

SIRIUS XM

RADIO INC.

1500 Eckington Place, N.E.
Washington, D.C. 20002
Tel: 202-380-4000
Fax: 202-380-4500
www.sirius.com www.xmradio.com

June 23, 2010

Via IBFS

Ms. Marlene H. Dortch, Secretary
Federal Communications Commission
445 12th Street, S.W.
Washington, D.C. 20554

**Re: Sirius XM Radio Inc.
Request for 180-Day Special Temporary Authority
For Two Low Power Repeaters in Baltimore, Maryland**

Dear Ms. Dortch:

Pursuant to Section 25.120(b)(2) of the Commission's rules, 47 C.F.R. § 25.120(b)(2), Sirius XM Radio Inc. ("Sirius XM"), a satellite radio licensee in the Satellite Digital Audio Radio Service ("SDARS"), hereby requests 180-Day Special Temporary Authority ("STA") for two low power terrestrial repeaters, each with an Effective Isotropically Radiated Power ("EIRP") of up to 2000 watts, in Baltimore, Maryland. Specifically, this application seeks authority to operate one low power repeater in the former XM Radio Inc. ("XM") frequency band (2332.5-2345 MHz) and one low power repeater in the former Sirius Satellite Radio Inc. ("Sirius") frequency band (2320-2332.5 MHz). Sirius XM requires STA so that it can promptly return these repeaters to operation and minimize the disruption of service to the public.¹

¹ On June 21, 2010, Sirius XM filed a request to operate these two repeaters under 60-Day Special Temporary Authority pursuant to Section 25.120(b)(3) of the Commission's rules. *See* FCC File No. SAT-STA-20100621-00140. That request remains pending. The Commission recently adopted formal rules for satellite radio terrestrial repeaters. *See* Amendment of Part 27 of the Commission's Rules to Govern the Operation of Wireless Communications Services in the 2.3 GHz Band; Establishment of Rules and Policies for the Digital Audio Radio Satellite Service in the 2310-2360 MHz Frequency Band, *Report and Order and Second Report and Order*, FCC 10-82 (released May 20, 2010) (the "*May 20 Order*"). The *May 20 Order* authorizes the International Bureau "to continue to grant STAs for new or modified repeaters ... [until] any permanent authorization to operate SDARS repeaters becomes effective." *Id.* at Para. 264.

The Commission has recognized that SDARS operators require terrestrial repeaters to provide high-quality service nationwide.² Consistent with this policy, in September 2001, the Bureau granted STAs to Sirius XM to operate a nationwide network of terrestrial repeaters.³ In the years since, the Bureau has granted Sirius XM additional STAs to operate terrestrial repeaters, pending issuance of final rules governing the deployment and use of repeaters.⁴

Public Interest Considerations. Sirius XM recently discontinued operations on these co-located Baltimore, Maryland repeaters upon discovering minor discrepancies between the authorized site parameters and the specifications of the repeaters as constructed. This STA corrects those parameters and will reauthorize the two sites to allow the prompt resumption of service in the Baltimore area. Without these repeaters, Sirius XM cannot provide the signal quality that its subscribers have come to expect.

² See *May 20 Order*. See also, *Establishment of Rules and Policies for the Digital Audio Radio Satellite Service in the 2310-2360 MHz Frequency Band, Report and Order*, 12 FCC Rcd 5754, 5770 ¶ 37 (1997).

³ See *Sirius Satellite Radio, Inc., Application for Special Temporary Authority to Operate Satellite Digital Audio Radio Service Complimentary Terrestrial Repeaters, Order and Authorization*, 16 FCC Rcd. 16773 ¶ 18 (2001) (“*Sirius STA Order*”). *XM Radio, Inc., Application for Special Temporary Authority to Operate Satellite Digital Audio Radio Service Complimentary Terrestrial Repeaters, Order and Authorization*, 16 FCC Rcd. 16781 ¶ 18 (2001) (“*XM STA Order*”).

⁴ See, e.g., *Sirius Satellite Radio Inc.; Request to Modify Special Temporary Authority to Operate Additional Satellite Digital Audio Radio Service Terrestrial Repeaters, Order and Authorization*, 19 FCC Rcd. 18140 (2004) (granting Sirius an STA in File No. SAT-STA-20031106-00370, effective Sept. 15, 2004. Since that time, the Commission has extended the STA several times, pending the issuance of final rules governing the use of satellite DARS terrestrial repeaters. In September 2004, the Commission granted Sirius a new STA to operate for 180 days or until the Commission issues final rules governing the use of satellite DARS terrestrial repeaters. See *Sirius Satellite Radio Inc. Request to Modify Special Temporary Authority to Operate Satellite DARS Terrestrial Repeaters, Order and Authorization*, 19 FCC Rcd 18149 (2004) (“*2004 STA Grant Order*”). Sirius timely filed an application for renewal of this STA on March 1, 2005. See File No. SAT-STA-20050301-00053. To date, the Commission has not acted on this application. See also, *XM Radio, Inc.; Request for Special Temporary Authority to Operate Additional Satellite Digital Audio Radio Service Terrestrial Repeaters, Order and Authorization*, 19 FCC Rcd. 18140 (2004) (granting XM an STA in File No. SAT-STA-20031112-00371, effective Sept. 15, 2004); *Public Notice*, 2002 FCC Lexis 5670 (rel. Oct. 30, 2002) (granting XM an STA in File No. SAT-STA-20020815-00153, effective Sept. 30, 2002); *Public Notice*, 2003 FCC Lexis 4803 (rel. Aug. 29, 2002) (granting XM an STA in File No. SAT-STA-20030409-00076, effective June 26, 2003). XM has filed applications to renew its STAs, and those renewal applications remain pending.

Technical Information for the New Low Power Repeaters. The following technical information pertaining to the repeaters is provided in Exhibit A: (1) antenna type; (2) antenna orientation; (3) average EIRP; (4) height above ground level (“AGL”); and (5) antenna downtilt.⁵ Exhibits B and C consist respectively, of Google™ satellite images and topographic maps showing the location of the proposed facilities. The specification sheets for the antennas to be used by the repeaters are attached as Exhibit D.

Interference Considerations. As proposed in this STA, these repeaters will operate at an average EIRP of less than 2000 watts. Because Sirius XM has exclusive use of its licensed band, it is highly unlikely that these low power repeaters will create interference to other licensees.⁶ To the extent Sirius XM’s original 2001 STAs require it to coordinate with affected Wireless Communications Services (“WCS”) licensees prior to operating any repeater, Sirius XM is sending a copy of this STA application to Horizon Wi-Com LLC in satisfaction of this coordination requirement.⁷ Moreover, as the Bureau acknowledged in granting Sirius XM’s original repeater STA requests, the WCS licensees have confirmed that operating terrestrial repeaters at an EIRP of 2 kW or less is not an interference concern.⁸ However, if prohibited interference does occur, Sirius XM will cease

⁵ For purposes of Sirius XM’s repeater STA applications, “antenna downtilt” refers to an antenna’s mechanical downtilt, without reference to any electrical downtilt built into the antenna.

⁶ In the *May 20 Order*, the Commission determined “that SDARS terrestrial repeaters can operate at an average EIRP of 12 kw with maximum PAPR of 13 dB without causing harmful interference to WCS base station receivers.” *May 20 Order* at Para. 243.

⁷ Despite the Bureau’s statement in the *XM STA Order* (at ¶ 14) and *Sirius STA Order* (at ¶ 14) that it expects “WCS licensees to provide a schedule or as much advance notice as possible of when their stations are to be placed in operation,” Sirius XM has not received information directly from any WCS licensee regarding plans for WCS deployment in these markets. However, Sirius XM’s own review of Commission files shows that Horizon has certified that it operates a WCS station serving the Washington, DC metro area, Call Sign KNLB315. It is not clear from the certification whether the base station is receiving transmissions from CPE or is engaged in transmit-only operations. If only the latter, potential interference to the base station is not an issue. In any event, Sirius XM has conducted an interference analysis and determined that its proposed repeaters will not create any interference concern for Horizon’s operating WCS site beyond any concerns that may exist from Sirius XM’s existing repeaters in the vicinity, none of which have been the subject of any interference complaints from WCS licensees or users.

⁸ *XM STA Order* ¶ 12 (“The comments from WCS licensees express concern about blanketing interference from DARS repeaters that operate with an Equivalent Isotropically Radiated Power (EIRP) above 2 kW.”). Moreover, in March 2007, the WCS Coalition said that it will defer from objecting to STA requests that propose operations of no more than 2,000 watts EIRP, even if they do not specify peak or average EIRP, provided that grant of the STA (i) is conditioned on operation on a non-interference basis; and (ii) is subject to the condition that the issue of peak versus average EIRP will be addressed in the pending DARS rulemaking (IB Docket No.

operation of the repeaters until such interference can be eliminated.⁹

Ownership and Control of Repeaters. Sirius XM will own the repeaters and it will be responsible for the repeaters' installation and operation.

Certifications. Sirius XM certifies that it will operate the repeaters subject to the conditions and certifications set forth in the *Sirius STA Order* and *XM STA Order* granting Sirius XM's September 2001 requests for STAs to operate terrestrial repeaters. Specifically, Sirius XM certifies the following:

- (1) Sirius XM will operate these repeaters at its own risk, and such operation shall not prejudice the outcome of the final rules adopted by the Commission in GEN Docket 95-91;
- (2) Sirius XM will operate these facilities on a non-interference basis with respect to all permanently authorized radiocommunication facilities;
- (3) The facilities will be restricted to the simultaneous retransmission of the complete programming, and only that programming, transmitted by the satellite directly to SDARS receivers;
- (4) Where applicable, coordination of the facilities will be completed with all affected Administrations prior to operation, in accordance with all applicable international agreements including those with Canada and Mexico;
- (5) The facilities will comply with Part 17 of the Commission's rules – Construction, Marking, and Lighting of Antenna Structures;
- (6) The facilities will comply with Part 1 of the Commission's rules, Subpart I - Procedures Implementing the National Environmental Policy Act of 1969, including the guidelines for human exposure to radio frequency electromagnetic fields as defined in Sections 1.1307(b) and 1.1310 of the Commission's rules;
- (7) The out-of-band emissions of the facility will be limited to 75+10log (EIRP) dB less than the transmitter EIRP;

95-91). *See* Letter from Paul J. Sinderbrand, Counsel to the WCS Coalition, to Ms. Helen Domenici, FCC, File No. SAT-STA-20061207-00145 (March 19, 2007). XM agrees to these conditions. . In the *May 20 Order*, the Commission concluded "that SDARS terrestrial repeaters can operate at an average EIRP of 12 kw with maximum PAPR of 13 dB without causing harmful interference to WCS base station receivers." *Id.* at Para. 243.

⁹ These repeaters' design includes several automated shutdown mechanisms that are triggered in the event of equipment major malfunctions. The transmit chain also includes a transmit output coupler which feeds a self-monitoring system detecting any transmission anomalies. Any such anomalies are automatically reported back to Sirius XM's National Repeater Control Center (202-380-4725), which is available on a continuous basis to receive any reports of any suspected interference and take immediate corrective action.

- (8) Sirius XM will operate these repeaters according to the technical parameters provided in this application;
- (9) Sirius XM will maintain full ownership and operational control of these repeaters; and
- (10) Sirius XM will immediately shut down these repeaters upon a complaint of interference, upon direction from the Commission, or upon finding that a facility has not been properly installed.

Granting this request will not alter Sirius XM's obligation to protect authorized radio-communications facilities from interference, nor will it prejudice the outcome of the Commission's ongoing rulemaking pertaining to the deployment and operation of terrestrial repeaters.

Sirius XM hereby certifies that no party to this application is subject to a denial of Federal benefits pursuant to Section 5301 of the Anti-Drug Abuse Act of 1988, 21 U.S.C. § 853(a).

Sirius XM is submitting payment to the Federal Communications Commission in the amount of Two Thousand Eight Hundred Sixty Dollars (\$2860.00) -- the filing fee applicable to requests for STAs for non-geostationary ("NGSO") satellites.¹⁰

Please direct any questions regarding this matter to the undersigned.

Very truly yours,

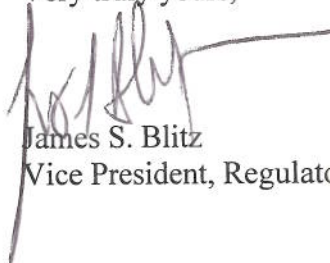

James S. Blitz
Vice President, Regulatory Counsel

cc: Stephen Duall, FCC International Bureau
Jay Whaley, FCC International Bureau
Sankar Persaud, FCC International Bureau

¹⁰ See International and Satellite Services Fee Filing Guide (February 2009).

Exhibit A

Technical Parameters for Repeaters

CITY	ANTENNA NUMBER	SITE LATITUDE (N)	SITE LONGITUDE (W)	ANTENNA TYPE	ANTENNA ORIENTATION (AZIMUTH)	ANTENNA HEIGHT (FT.AGL)	ANTENNA DOWNTILT (DEGREES)	TOTAL AVERAGE EIRP (W)
Baltimore, MD	WDC401B	39 -17 -14	76-36-52	TA2350-DAB- T2	0	537	0	2000
Baltimore, MD	Sirius 03-11 Sector 1	39 -17 -14	76-36-52	EMS FR90-17-00NVL	45	525	0	2000
Baltimore, MD	Sirius 03-11 Sector 2	39 -17 -14	76-36-52	EMS FR90-17-00NVL	315	525	0	2000

Exhibit B

Google™ Satellite Image of Repeater Location

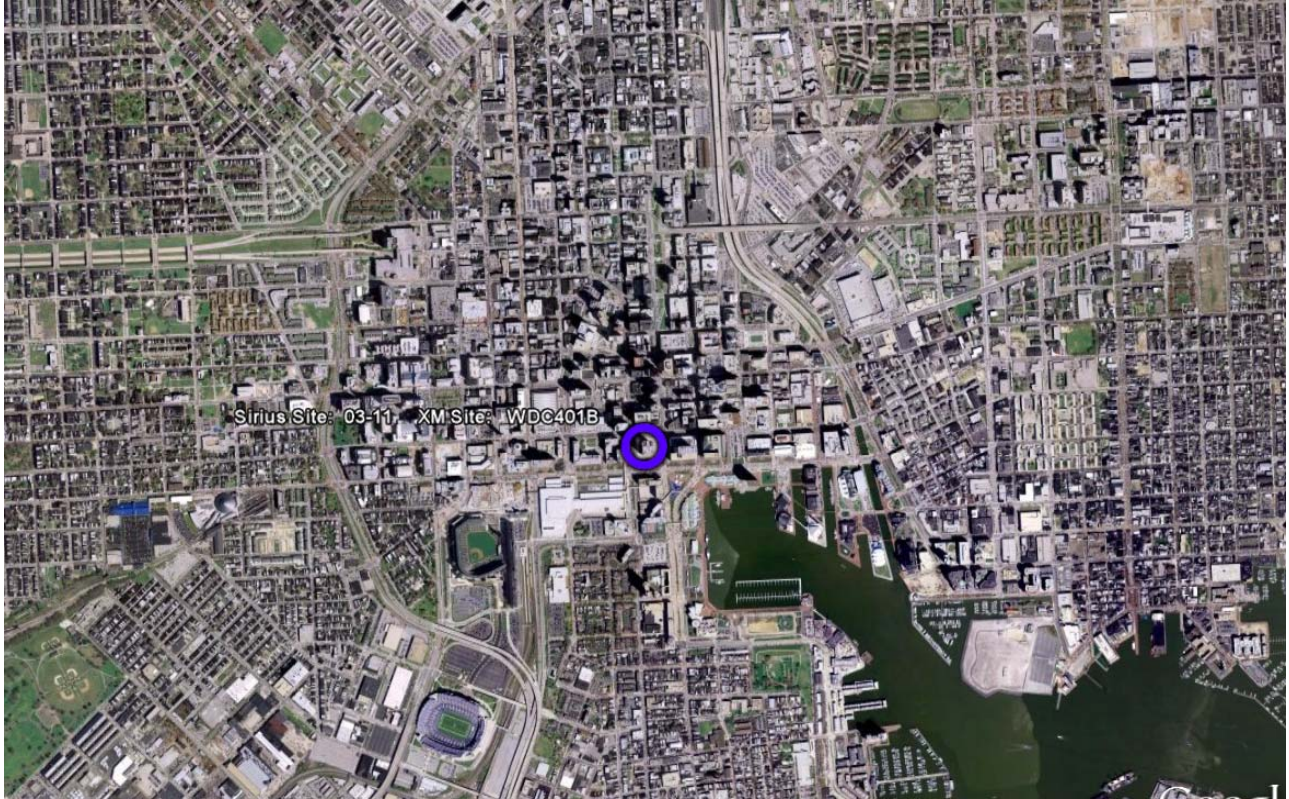

Exhibit C

Topographic Map of Repeater Location

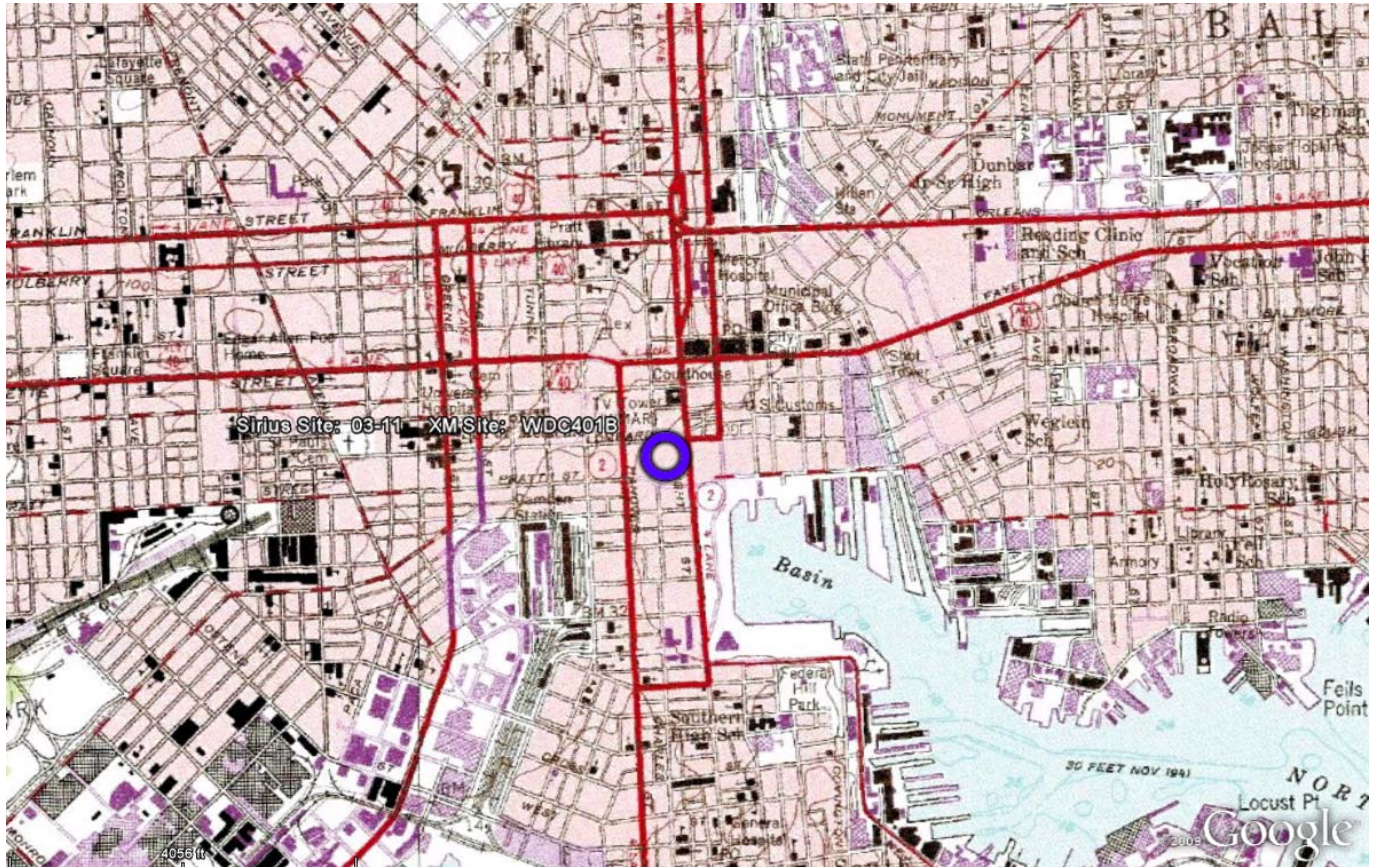

Exhibit D

Antenna Specification Sheet for Repeaters



TA-2350-DAB

Medium Power Omnidirectional

2330-2345 MHz

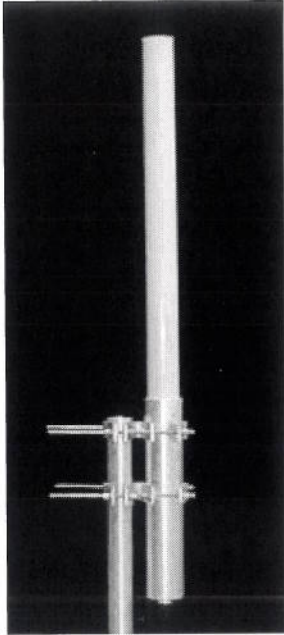

The TA-2350-DAB is a medium power vertically polarized omnidirectional antenna specifically designed for Digital Audio Broadcast transmission. The antenna consists of a phased corporately fed broadband dipole array which is configured to provide electrical beam downtilt and null fill. The antenna elements are at DC ground to aid in lightning protection.

Electrical Specifications

Frequency Range: 2330-2345 MHz
Gain: 10 dBi
VSWR: 1.4:1 max.
Polarization: Vertical
Power Rating: 200 W avg., 800 W peak
H-Plane Beamwidth: 360 degrees
E-Plane Beamwidth: 8 degrees
Electrical_Downtilt: 2, 4, 6 degrees
Cross Pol. Discrimination: 20 dB min.
Null Fill: -20 dB (1st Null)
Impedance: 50 ohms nominal
Termination: 7/16 DIN female

Typical mid band values. (For details , contact factory)

Mechanical Specifications

Length: 70 in. (1778 mm)
Diameter: 2.25 in. (57 mm)
Weight (Incl. Clamps): 15 lb. (6.8 kg)
Rated Wind Velocity: 125 mph (200 km/h)
Hor. Thrust at rated wind: 31 lb. (14 kg)
Mounting Pipe: 1.75 - 4.0 in. (44.5 - 102 mm)

Materials

Radiating Elements: Nickel plated copper array
Radome: Gray UV stabilized fiberglass
Clamps: HDG steel

E-Plane

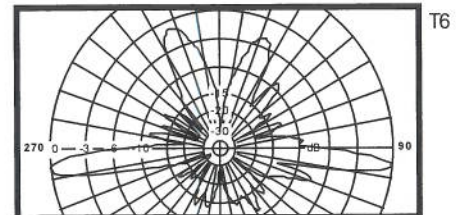
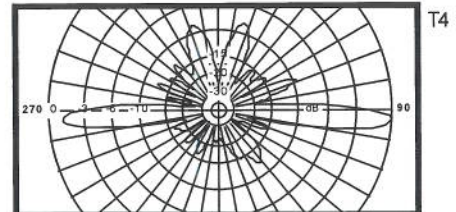
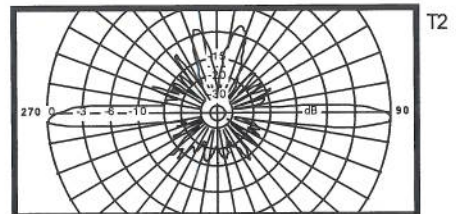

OTHER PRODUCTS



FR90-17-XXXVL

DualPol[®] Polarization

2305 MHz - 2360 MHz

OptiFill™
Suppressor™

Electrical Specifications

Azimuth Beamwidth (-3 dB)	90° ± 5°
Elevation Beamwidth (-3 dB)	5.6°
Elevation Sidelobes (Upper)	> 20 dB
Gain	16.6 dBi (14.5 dBd)
Polarization	Slant, ±45°
Front-to-Back Ratio	> 25 dB (> 30 dB Typ.)
Electrical Downtilt Options	0°
VSWR	1.33:1 Max (1.22:1 Typ)
Connectors	2; 7-16 DIN (female), or Type N
Power Handling	250 Watts CW
Passive Intermodulation	< -147 dBc [2 x 20 W (+ 43 dBm)]
Lightning Protection	Chassis Ground

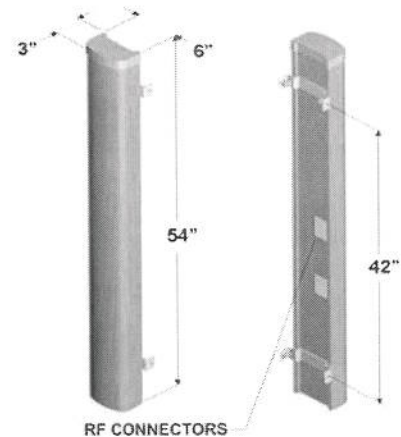

Mechanical Specifications

Dimensions (L x W x D)	54 in x 6 in x 3 in (137.2 cm x 15.2 cm x 7.6 cm)
Rated Wind Velocity	150 mph (241 km/hr)
Equivalent Flat Plate Area	2.3 ft ² (.21 m ²)
Front Wind Load @ 100 mph (161 kph)	66 lbs (294 N)
Side Wind Load @ 100 mph (161 kph)	33 lbs (147 N)
Weight (Without Mounting Options)	13 lbs (6.0 kg)

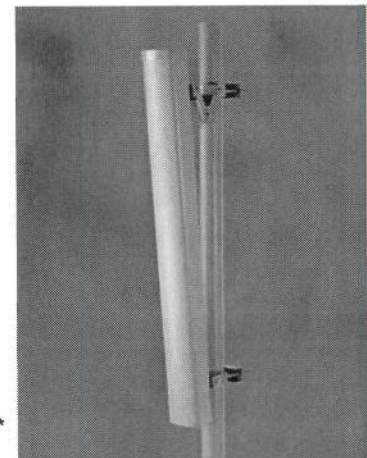

Mounting Options

MTG-P00-10, MTG-S02-10, MTG-DXX-20*, MTG-CXX-10*, MTG-C02-10, MTG-TXX-10*

*Note: *Model number shown represents a series of products. See Mounting Options section for specific model number.*

Patterns

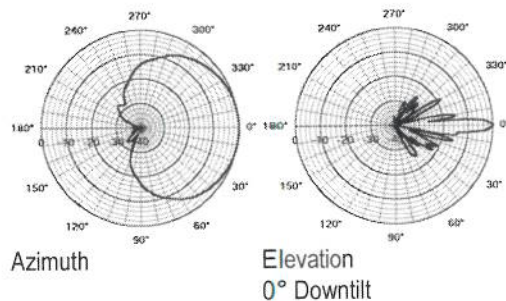

Azimuth

Elevation
0° Downtilt

EMS' antennas are protected by one or more of the following U.S. patents: 5,844,529; 6,067,053; 6,462,710; 6,392,600; 6,069,590; 5,966,102; 5,757,246. EMS' antenna designs may also be covered by pending U.S. patent applications and by pending & awarded international patents.

Revised 09/03/04