

Approved by OMB
3060-0678

Date & Time Filed: Jun 1 2005 3:00:59:926PM
File Number: SAT-STA-20050601-00113
Callsign:

FEDERAL COMMUNICATIONS COMMISSION
APPLICATION FOR SPACE STATION SPECIAL TEMPORARY AUTHORITY
FOR OFFICIAL USE ONLY

APPLICANT INFORMATION

Enter a description of this application to identify it on the main menu:
STA for Additional In-Store Boosters

1. Applicant	
Name:	XM Radio Inc.
DBA Name:	
Street:	1500 Eckington Place, NE
City:	Washington
Country:	USA
Attention:	Bill Bailey
Phone Number:	202-380-4000
Fax Number:	202-380-4500
E-Mail:	bill.bailey@xmradio.com
State:	DC
Zipcode:	20002

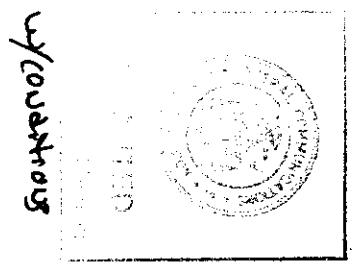

File # SAT-STA-20050601-00113
Call Sign _____ Grant Date 1/18/07
(or other identifier)
Term Dates
from 1/18/07 To: + 180 days
Approved: [Signature]
Policy Branch Chief

Application of XM Radio Inc. for Special Temporary Authority
IBFS File No. SAT-STA-20050601-00113

Special temporary authority (STA) IS GRANTED to XM Radio Inc. (XM Radio) for a period of 180 days to operate, in conjunction with Sirius Satellite Radio Inc. (Sirius),¹ up to an additional² 5,000 in-store terrestrial repeaters with an Effective Isotropically Radiated Power (EIRP) of 0.0001 watts at retail outlets within the United States with the technical parameters specified in its application, subject to the following conditions:

1. Sirius and XM Radio shall operate the in-store terrestrial repeaters at their own risk and such operation shall not prejudice the outcome of the final rules adopted by the Commission in IB Docket 95-91;
2. Sirius and XM Radio shall operate the in-store terrestrial repeaters on a non-interference basis with respect to all permanently authorized radiocommunication facilities;
3. The in-store terrestrial repeaters are restricted to the simultaneous retransmission of the complete programming, and only that programming, transmitted by the satellite directly to SDARS receivers;
4. Where applicable, coordination of the in-store terrestrial repeaters shall be completed with all affected Administrations prior to operation, in accordance with all applicable international agreements including those with Canada and Mexico;
5. The in-store terrestrial repeaters shall comply with Part 17 of the Commission's rules - Construction, Marking, and Lighting of Antenna Structures;
6. The in-store terrestrial repeaters shall comply with Part 1 of the Commission's rules, Subpart I - Procedures Implementing the National Environmental Policy Act of 1969, including the guidelines for human exposure to radio frequency electromagnetic fields as defined in Sections 1.1307(b) and 1.1310 of the Commission's rules;
7. The out-of-band emissions of the in-store terrestrial repeaters shall be limited to $75 + \log(\text{EIRP})$ dB less than the transmitter EIRP;
8. Sirius and XM Radio shall operate the in-store terrestrial repeaters according to the technical parameters provided in their applications for special temporary authority to operate such in-store terrestrial repeaters;

¹ Sirius has been separately granted special temporary authority to operate these repeaters in conjunction with XM Radio. See IBFS File No. SAT-STA-20050601-00114 (granted via grant stamp on January 18, 2007).

² XM Radio and Sirius were previously granted special temporary authority to operate up to an aggregate of 5,000 in-store terrestrial repeaters with an EIRP of 0.0001 watts at retail outlets within the United States. See IBFS File Nos. SAT-STA-20030411-00075/-00076 (granted via grant stamp on June 26, 2003). The authority granted herein is in addition to the authority granted previously, and does not negate, replace, or extend earlier authority to operate in-store terrestrial repeaters.

Application of XM Radio Inc. for Special Temporary Authority
IBFS File No. SAT-STA-20050601-00113

9. The total aggregate number of in-store terrestrial repeaters between Sirius and XM Radio operating pursuant to this grant of STA shall not exceed 5,000;
10. Sirius and XM Radio shall have joint ownership of each of the in-store terrestrial repeaters;
11. Sirius and XM Radio shall have joint operational control of each of the in-store terrestrial repeaters;
12. The in-store terrestrial repeaters shall be professionally installed pursuant to written instructions provided by Sirius and XM Radio and shall be labeled with contact telephone numbers for Sirius and XM Radio to be called in the event that an in-store terrestrial repeater causes interference;
13. Sirius and/or XM Radio shall immediately shut down any, or all, in-store terrestrial repeaters upon a complaint of interference, upon direction from the Commission, or upon finding that an in-store terrestrial repeater has not been properly installed;
14. Sirius and XM Radio shall have joint and several liability for any harmful interference caused by an in-store terrestrial repeater, and shall have joint and several liability for any forfeiture or other penalty imposed by the Commission as a result of any harmful interference.
15. XM Radio is granted 30 days from the date of the release of this authorization to decline the authorization as conditioned. Failure to respond within that period will constitute formal acceptance of the authorization as conditioned.
16. This action is issued pursuant to Section 0.261 of the Commission's rules on delegated authority, 47 C.F.R. § 0.261, and is effective immediately. Petitions for reconsideration under Section 1.106 or applications for review under Section 1.115 of the Commission's rules, 47 C.F.R. §§ 1.106, 1.115, may be filed within 30 days of the date of the public notice indicating that this action was taken.

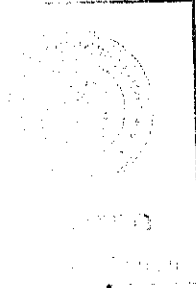
	File # <u>SAT-STA-20050601-00113</u>
	Call Sign _____ Grant Date <u>1/18/07</u> (or other identifier)
	Term Dates From <u>1/18/07</u> To: <u>+ 180 days</u>
	Approved: <u>[Signature]</u> Policy Branch Chief

with conditions

2. Contact	
Name: Bruce D. Jacobs	Phone Number: 202-663-8077
Company: Pillsbury Winthrop Shaw Pittman LLP	Fax Number: 202-663-8007
Street: 2300 N Street, NW	E-Mail: bruce.jacobs@pillsburylaw.com
City: Washington	State: DC
Country: USA	Zipcode: 20037 -1128
Attention:	Relationship: Legal Counsel
(If your application is related to an application filed with the Commission, enter the file number below.)	
3. Reference File Number	
4a. Is a fee submitted with this application?	
<input checked="" type="radio"/> If Yes, complete and attach FCC Form 159. If No, indicate reason for fee exemption (see 47 C.F.R. Section 1.1114).	
<input type="radio"/> Governmental Entity <input type="radio"/> Noncommercial educational licensee	
<input type="radio"/> Other(please explain):	
4b. Fee Classification CRY – Space Station (Geostationary)	
5. Type Request	
<input type="radio"/> Change Station Location	<input type="radio"/> Extend Expiration Date
	<input checked="" type="radio"/> Other
6. Temporary Orbit Location	7. Requested Extended Expiration Date

8. Description (If the complete description does not appear in this box, please go to the end of the form to view it in its entirety.)

XM requests Special Temporary Authority (STA) to operate up to 5,000 in-store signal boosters with an Effective Isotropically Radiated Power (EIRP) of 0.0001 watts in its licensed frequency band (2332.5-2345 MHz).

9. By checking Yes, the undersigned certifies that neither applicant nor any other party to the application is subject to a denial of Federal benefits that includes FCC benefits pursuant to Section 5301 of the Anti-Drug Act of 1988, 21 U.S.C. Section 862, because of a conviction for possession or distribution of a controlled substance. See 47 CFR 1.2002(b) for the meaning of "party to the application" for these purposes. Yes No

10. Name of Person Signing
William Bailey

11. Title of Person Signing
Senior Vice President

12. Please supply any need attachments.

Attachment 1: Letter Request

Attachment 2:

Attachment 3:

WILLFUL FALSE STATEMENTS MADE ON THIS FORM ARE PUNISHABLE BY FINE AND / OR IMPRISONMENT
(U.S. Code, Title 18, Section 1001), AND/OR REVOCATION OF ANY STATION AUTHORIZATION
(U.S. Code, Title 47, Section 312(a)(1)), AND/OR FORFEITURE (U.S. Code, Title 47, Section 503).

FCC NOTICE REQUIRED BY THE PAPERWORK REDUCTION ACT

The public reporting for this collection of information is estimated to average 2 hours per response, including the time for reviewing instructions, searching existing data sources, gathering and maintaining the required data, and completing and reviewing the collection of information. If you have any comments on this burden estimate, or how we can improve the collection and reduce the burden it causes you, please write to the Federal Communications Commission, AMD-PERM, Paperwork Reduction Project (3060-0678), Washington, DC 20554. We will also accept your comments regarding the Paperwork Reduction Act aspects of this collection via the Internet if you send them to jboley@fcc.gov. **PLEASE DO NOT SEND COMPLETED FORMS TO THIS ADDRESS.**

Remember – You are not required to respond to a collection of information sponsored by the Federal government, and the government may not conduct or sponsor this collection, unless it displays a currently valid OMB control number or if we fail to provide you with this notice. This collection has been assigned an OMB control number of 3060-0678.

THE FOREGOING NOTICE IS REQUIRED BY THE PAPERWORK REDUCTION ACT OF 1995, PUBLIC LAW 104-13, OCTOBER 1, 1995, 44 U.S.C. SECTION 3507.



June 1, 2005

VIA ELECTRONIC FILING

Ms. Marlene H. Dortch, Secretary
Federal Communications Commission
445 12th Street, S.W.
Washington, D.C. 20554

**Re: XM Radio Inc.
Request for Special Temporary Authority to Operate In-Store Signal
Boosters in the Satellite Digital Audio Radio Service**

Dear Ms. Dortch:

XM Radio Inc. ("XM"), pursuant to 47 C.F.R. § 25.120,¹ hereby requests Special Temporary Authority ("STA") to operate up to 5,000 in-store signal boosters with an Effective Isotropically Radiated Power ("EIRP") of 0.0001 watts in its licensed frequency band (2332.5-2345 MHz) at retail outlets. This STA is requested for a period of 180 days or until the date on which permanent rules become effective for the operation of Satellite Digital Audio Radio Service ("SDARS") terrestrial repeaters, whichever occurs first.

The Commission already has granted XM STA to operate up to 5,000 in-store signal boosters with an EIRP of 0.0001 watts in its licensed frequency band. By this application, XM seeks STA to operate an additional 5,000 in-store signal boosters. The additional boosters requested herein will include both the type previously approved by the Commission² as well as a new type which, like the previously authorized boosters, will amplify the satellite and terrestrial signals of both XM and Sirius Satellite Radio Inc. ("Sirius") within retail outlets.³ The additional boosters will enable XM (and Sirius) to meet the increased demand for deployment of boosters in additional retail outlets. Further, many of the new boosters will employ improved technology that permits

¹ XM has filed this STA request FCC Form 312 electronically via the International Bureau's Filing System. FCC Form 159 and the accompanying \$735.00 filing fee are being submitted by mail under separate cover.

² See *XM Radio Inc. Request for Special Temporary Authority to Operate In-Store Signal Boosters in the Satellite Digital Audio Radio Service*, File No. SAT-STA-20030409-00076 (grant stamp with conditions issued June 26, 2003).

³ XM notes that Sirius is filing concurrently an application for an STA to operate these signal boosters in its licensed frequency band, 2320-2332.5 MHz.

Ms. Marlene H. Dortch
June 1, 2005
Page 2

operation using one, rather than two, receive antennas. Accordingly, grant of the requested STA will serve the public interest.

Technical Information. The additional boosters requested herein will include both the type previously approved by the Commission as well as a new type. With respect to the new type, these boosters, like the previously approved in-store signal boosters, which are essentially S-band radio frequency amplifiers, will transmit inside of retail stores. However, these new in-store signal boosters will require only one receive antenna, whereas the current boosters employ two receive antennas, as shown in the figure below:

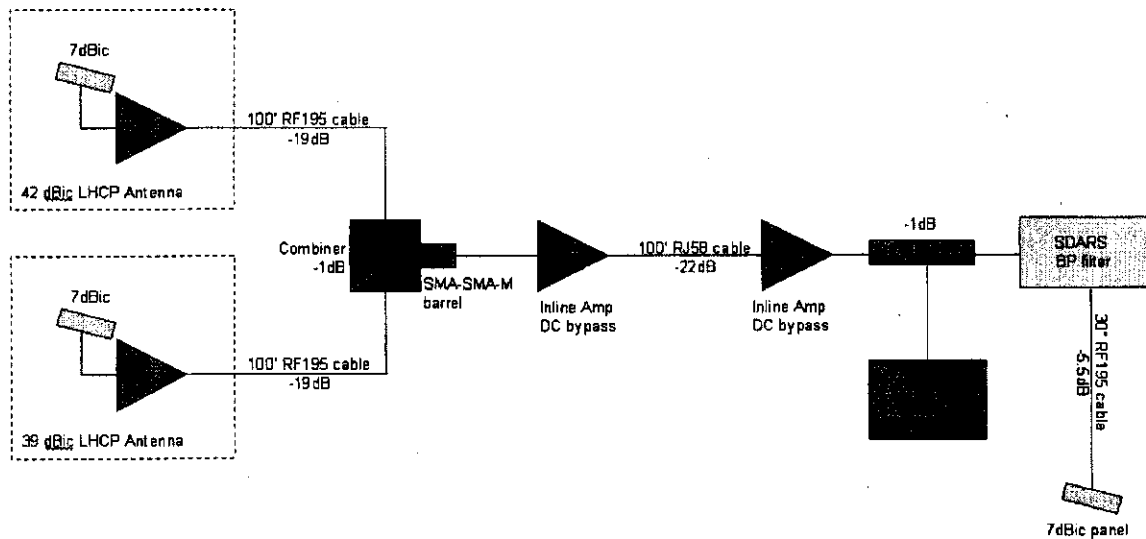

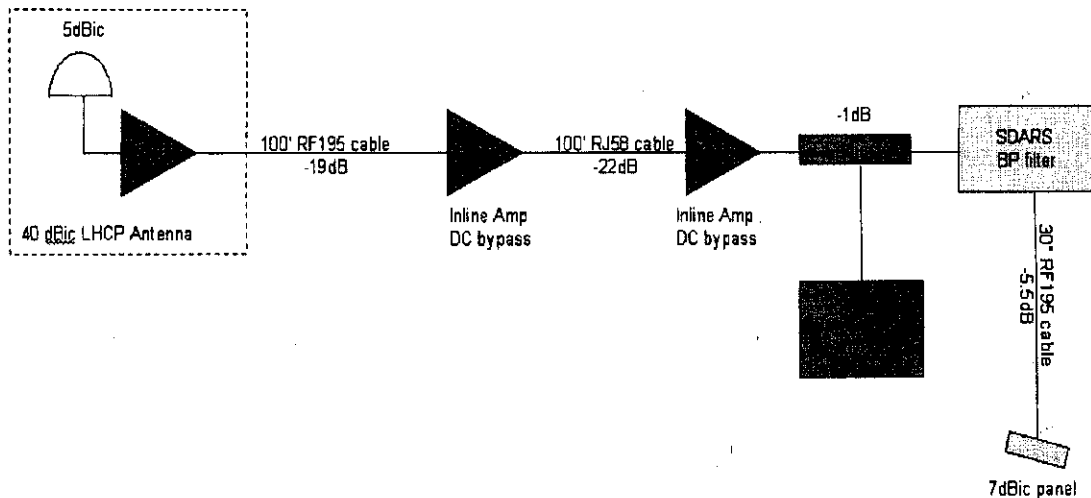

In all other respects, the technical parameters for these new in-store signal boosters will be identical to the current boosters.

As detailed in Exhibit A, an illustrative Installation Manual, a single in-store receive antenna will be used to amplify SDARS satellite signals and, in some cases, terrestrial rebroadcast signals. The signals are received by this antenna located on the roof or mounted on the outside walls of the stores and are fed via coaxial cable to an inline amplifier and subsequently to the in-store antenna for amplification. Retail stores will receive an Installation Manual along with the in-store signal boosters and will be required to install the boosters pursuant to the manual.

In Exhibit B, XM provides a list of technical parameters for the in-store signal boosters it seeks to operate pursuant to this STA. These technical parameters are the same for both the previously approved and new boosters. XM has included the following information: (1) antenna type; (2) antenna beamwidth; (3) total EIRP; and (4) approximate maximum height Above Ground Level (AGL). Consistent with its prior application, however, XM has not included geographic coordinates for each of these in-store signal boosters.⁴

⁴ XM notes that the manufacturers of these boosters may change, but the specifications will remain the same.

The location of each in-store signal booster does not constitute part of the "full particulars of the proposed operation" which must be submitted with an application for STA.⁵ Because the in-store signal boosters will operate at such a low EIRP that they will not cause blanketing interference to any Wireless Communications Service ("WCS") receivers, even ones operated very close to the signal boosters, there is no need to identify the location of the boosters in this application. Furthermore, it would be impractical for XM to list the retail outlets nationwide at which it plans to deploy these in-store signal boosters or to modify this STA every time XM were to operate an in-store signal booster at a new retail establishment. To the extent that the Commission determines that location information is required, XM respectfully requests that the Commission waive this requirement.⁶

Interference Considerations. The in-store signal boosters will not cause harmful interference to other radio services. Because XM has exclusive use of its licensed frequency band,⁷ there is no potential for in-band interference. Moreover, these additional in-store signal boosters, like the current boosters, will not cause adjacent band interference to WCS licensees in the 2305-2320 MHz and 2345-2360 MHz bands.

As set forth in Exhibit C, assuming the worst case scenario for interference to WCS operations (*i.e.*, WCS equipment operating on a frequency adjacent to the upper edge of XM's licensed frequency band and operating within 5.3 feet of the signal booster), WCS licensees will have a margin of 19 dB, which is sufficient for any digital fixed wireless or mobile use. Moreover, where WCS equipment operates outside of the store where the booster is located, the margin will increase by another 9 dB as a result of wall or ceiling attenuation, providing additional protection to any possible outdoor WCS receivers. And, as required by the Installation Manual, both the SDARS roof or wall-mounted receive antenna and the signal booster antenna will be installed with sufficient isolation to avoid reflection.

Ownership and Control of In-Store Signal Boosters. XM and Sirius will jointly own each in-store signal booster. Pursuant to contractual arrangements, each licensee will retain full operational control of these boosters to the extent the booster operates in its licensed frequency band. XM and Sirius also will retain the right to shut down any in-store signal booster upon a complaint of interference, upon direction of the Commission, or upon finding that an in-store signal booster has not been installed in accordance with the Installation Manual.

⁵ 47 C.F.R. § 25.120(a).

⁶ 47 C.F.R. § 1.3.

⁷ 47 C.F.R. § 25.202(a)(6) (stating the 2320-2345 MHz band is allocated exclusively for SDARS).

Ms. Marlene H. Dortch
June 1, 2005
Page 5

Public Interest Considerations. Prompt grant of this STA will promote the continued success of satellite radio and thereby serve the public interest. The demand for SDARS radios by the public has continued to increase over time. Accordingly, Circuit City, Best Buy, and other stores that sell and promote SDARS radios to the public have requested that XM and Sirius make in-store signal boosters available to additional locations so that they can promote the service to consumers in additional markets. Without in-store signal boosters, these retail outlets cannot effectively market SDARS service to consumers, and cannot easily test SDARS receivers installed in consumers' vehicles.

As XM has noted in prior applications, in-store signal boosters enable XM to provide a clear signal for reception by SDARS receivers located within retail outlets. Based on consumer reactions, retail outlets have expressed a need for this type of in-store reception capability in order to demonstrate the mobility of SDARS. Moreover, eliminating the need for a hard wire connection enables satellite radios to be displayed in any area of a store, including high traffic areas. Finally, in those retail outlets offering automobile installation, store employees installing SDARS receivers in vehicles will be able to verify that the SDARS receiver is working properly while the vehicle is located in the store's installation bay. This will result in time-saving efficiencies for installers and ensure that vehicles are returned to consumers with properly functioning SDARS radios.

In addition, many of these in-store signal boosters feature better antenna technology. As noted above, certain of the in-store signal boosters will employ one receive antenna rather than the two antennas required by the current boosters. The new design also is more convenient to install and, therefore, is easier for retail outlets to use. Accordingly, grant of the requested STA will enable XM to deploy advanced technology, which will support the continued growth and development of SDARS service.

Certifications. XM certifies that its operation of the in-store signal boosters will comply with the "Micro-Repeater STA Conditions" that the Commission imposed on XM in granting the original STA to operate 5,000 in-store signal boosters.⁸ A copy of the "Micro Repeater STA Conditions" is provided at Exhibit D.

⁸ See *XM Radio Inc. Request for Special Temporary Authority to Operate In-Store Signal Boosters in the Satellite Digital Audio Radio Service*, File No. SAT-STA-20030409-00076 (grant stamp with conditions issued June 26, 2003).

Please direct any questions regarding this matter to the undersigned.

Very truly yours,

A handwritten signature in black ink, appearing to read "William Bailey". The signature is written in a cursive style with a large, stylized initial "W" and a prominent flourish at the end.

William Bailey
Senior Vice President, Regulatory
and Government Affairs

cc: Stephen Duall

EXHIBIT A

Illustrative Installation Manual

Interoperable SDARS Wireless Repeater System Retail & Commercial Installation Instructions for XMSSR923WR

WARNING
INSTALLATION OF ANTENNA NEAR POWER LINES IS DANGEROUS.
FOR YOUR SAFETY, FOLLOW THE INSTALLATION INSTRUCTIONS.

Check for all parts listed before beginning assembly.
Note any shortages - Call Antenna Specialists (ph. 440-349-8400).

Parts List:

Item	Description	Figure
A	Pole Assembly	1
B	Antenna on Bracket	2-3
C	Two U-bolts	4
D	Kit Bag with tar tape & tie wraps	5
E	100 ft RF-195 Cable (QTY. 2)	6
F	100 ft RG-58 Cable	6
G	41 dB Amp w/DC By-Pass	8
H	DC Injector	9
I	Combiner with male/male adapter	7
J	39 dB Amp w/DC Bypass	8
K	45 ft Cable	6
L	Passive Interior Antenna on small bracket	12

Parts needed: (not supplied)

1. (6) 5/16 x 3" lag screws to mount pole to building
2. (6) 5/16" washers for the lag screws
3. Additional cable straps. (Various lengths for attaching the cable)
4. Mounting hardware to ground the 41 dB amp

Tools needed: (not supplied)

1. Compass - Highly recommended
2. 1/2" Wrench
3. Electric Drill
4. Bubble Level

NOTES:

- ASSEMBLY PROCEDURE MUST BE FOLLOWED, STEP BY STEP IN ORDER.
- LENGTHENING OR SHORTENING OF CABLES MAY DEGRADE SIGNAL PERFORMANCE.



31225 Bainbridge Road • Cleveland, Ohio 44139-2281
Phone 440-349-8400 • FAX 440-349-8407 www.antenna.com

Step 1.

Wall or roof mounting (roof mounting configuration shown in FIG. 1). Adjust the Pole Assembly so that the pole is in a vertical position at the top. Tighten bolts once vertical position has been achieved. Check with a level.

NOTE: Remember when doing any installation, keep the mast plumb.

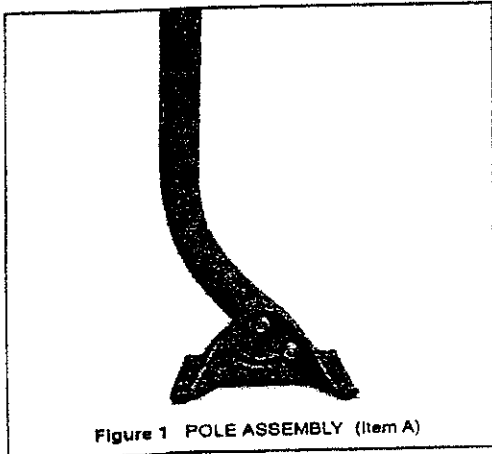

Figure 1 POLE ASSEMBLY (Item A)

NOTE: Ground the Pole Assembly to building following the National Electrical Code (NEC). Check local codes and ordinances. Professional Installation is highly recommended.

Step 2.

Position the antenna bracket assembly (Item B) on top of the vertical pole assembly (Item A) so that the center section of the bracket is horizontal, as shown. Feed the pole through hole in the bracket to assist in keeping it level (check using a level). Do not feed the pole through the bracket more than 1/8" (Bracket assembly is preformed for proper antenna elevations. **DO NOT ADJUST BRACKET POSITION**). Using a compass, align antenna assembly such that the XM Antenna faces South and the Sirius Antenna faces North, use arrows on bracket to assist in pointing North.

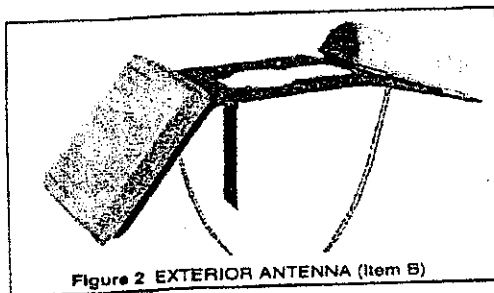

Figure 2 EXTERIOR ANTENNA (Item B)

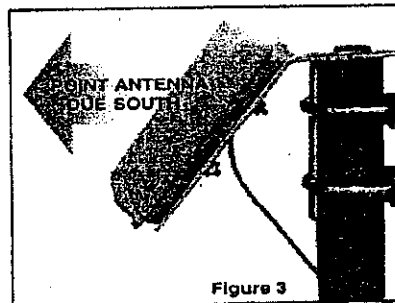

Figure 3

Fasten the antenna bracket to the pole assembly, using the U-bolts (Item C). Make certain the U-bolts are tightened securely to prevent rotation of bracket. Recommended torque on bolts is 10 to 15 in-lbs. Use one tie wrap to strap the antenna cable to the pole.

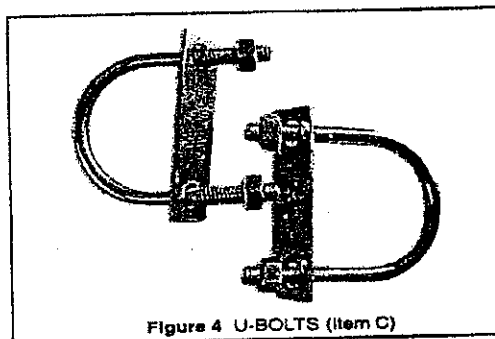

Figure 4 U-BOLTS (Item C)

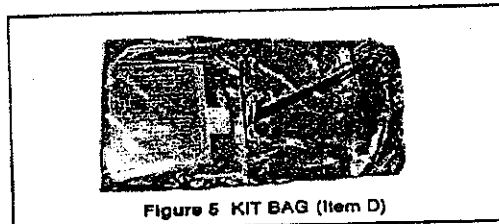

Figure 5 KIT BAG (Item D)

Step 3.

Attach one end of each 100' RF-195 cable (Item E) to each antenna cable. (verify that both are 100' RF-195 type cable by reviewing the label on each RF-195 type cable) Hand-tighten connectors until fully seated.

Remove the Vapor Wrap (tar) tape from the kit bag and remove from plastic covering. Remove the release liner from both sides. Wrap the black tape around the connectors until both sets of connectors are fully enclosed and are completely weather-sealed. Attach the cable along the pole assembly with remaining tie wraps.

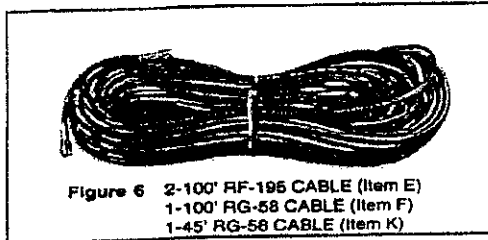

Figure 6 2-100' RF-195 CABLE (Item E)
1-100' RG-58 CABLE (Item F)
1-45' RG-58 CABLE (Item K)

Step 4.

Begin feeding both 100' cables (Item E) into the building or enclosure. Route cable toward the location of where the passive antenna will be located. Secure cables along the wall or beams, being careful not to puncture, pinch or smash the cable. NOTE: Avoid sharp bends or kinks in cable. Straighten all kinks if they occur during installation.

Step 5.

Connect both 100' RF-195 cables to the two (2) small cables of the combiner (item I).

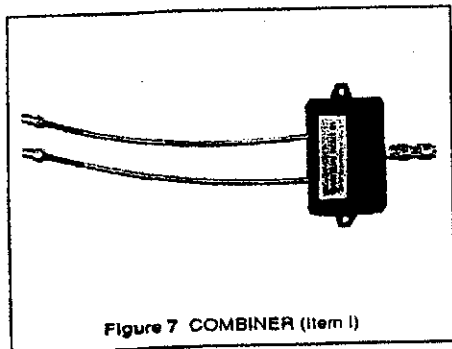

Figure 7 COMBINER (Item I)

Step 6.

If the small male to male adapter is not attached to the single female connector coming out of the combiner, reattach it. Review the orientation of the 41 dB Amp w/ DC By-Pass, (Item G). Attach Amplifier by mating the connector end labeled "in from antenna" to the male/male adapter of the combiner.

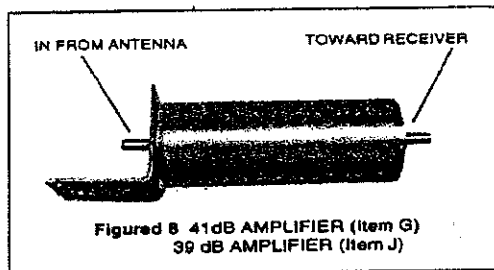

Figure 8 41dB AMPLIFIER (Item G)
39 dB AMPLIFIER (Item J)

Step 7.

Using the bracket located on the Amp, attach Amp to the building ground. Use the NEC as a reference. Support and mount the Amp to a wall, pole or beam so that the weight of the Amp is not straining on the cable.

Step 8.

Attach one end of the 100' RG-58 cable (Item F) to the other end of the Amp (Item G), the non-antenna end. Feed cable toward the passive antenna location. Bundle any extra cable (Do not cut). Secure cables along the wall or beams, being careful not to puncture, pinch or smash the cable, avoiding sharp bends or kinks during installation.

Step 9.

Attach the other end of the 100' RG-58 cable to the "in from antenna" side of the 39 dB in-line amplifier with DC bypass (item J).

Step 10.

Caution: Do not plug in the AC adapter of Item H before all connections are made. Equipment damage may occur. Attach the other end of the 39 dB in-line amplifier to the male connector of the DC-injector (item H) (the connector on the same side of the DC power pack).

Attach the 45' cable (item K) to the female SMA of the DC-Injector.

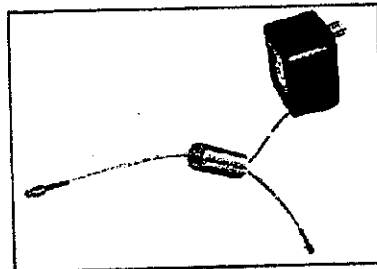

Figure 9 DC INJECTOR (Item H)

Step 11.

Select a suitable mounting location for the Passive Antenna (item L). This antenna provides a 70 degree horizontal by 60 degree verticle coverage pattern and should be located within 150 ft. but not closer than 20 ft. of the receivers to be covered. The table shown provides sample coverage dimensions based on the distance from the receivers. The antenna should be elevated so as to provided an unobstructed view of the receiver area(s) to be covered.

Step 12.

Attach the other connector of the 45' cable into the passive antenna (item L).

Step 13.

Verify all connections have been made before plugging in the AC adapter (Item H) into a standard 110 VAC wall receptacle.

Plug AC adapter of Item H into a standard 110 VAC wall receptacle.

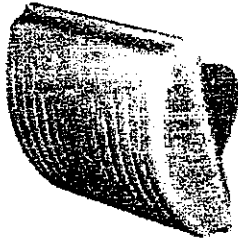
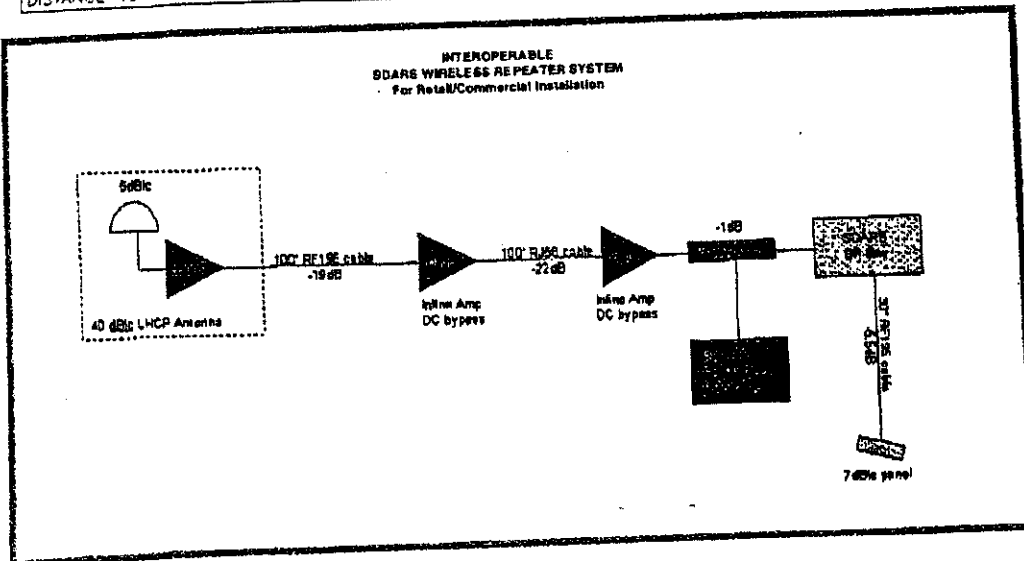

Figure 12 INTERIOR PASSIVE ANTENNA (item L) TO BE MOUNTED HIGH, TILT ANTENNA DOWNWARD INTO COVERED AREA 30-40 DEGREES.

150	210	173
80	112	92
40	56	46
20 MINIMUM	28	23
DISTANCE TO RECEIVERS (FEET)	HORIZONTAL COVERAGE (FEET)	VERTICAL COVERAGE (FEET)



**Interoperable SDARS Wireless Repeater System
Operation and System Test Instructions
for XMSSR923WR**

General

The XMSSR923WR is a Wireless Satellite Radio Repeater system designed to provide signal to XM and Sirius Satellite Radio receivers in the display areas in the retail environment. This system provides signal for both satellite radio service provider receivers and supports multiple receivers in the covered area.

System Description

The XMSSR923WR system consists of two receive antennas, an antenna combiner, two line amplifiers, a DC Injector, a transmit antenna and 4 cable assemblies to interconnect the components. The following section briefly describes each component of the system:

1. Receive Antennas

The Sirius and XM receive antennas are supplied with a mounting bracket and J-Pipe. Both antennas are LHCP, 7 dB gain, patch antennas with built in low noise amplifiers. The XM antenna LNA has a gain of 32 dB and the Sirius antenna LNA gain is 35 dB. The antennas are provided already connected in the correct locations of the mounting bracket so as to provide the proper elevation for each antenna (XM at 45 degrees and Sirius at 15 degrees from horizontal). For optimal system performance, these antennas must be fastened to the supplied J-Pipe and oriented with the Sirius antenna pointing toward the North. The antennas are connected to a combiner via two low loss RF195 type cables and the DC power for the internal amplifiers is supplied via the same cable.

2. Antenna Combiner

The antenna combiner combines the two receive antennas through the two antenna cables from two female SMA connectors at the combiner input to a single female SMA output connector at the combiner output. The combiner feeds DC to both antennas and delivers the combined signal to one of the two system line amplifiers.

3. Line Amplifier

Two line amplifiers are used in the XMSSR923WR (one with 41 dB and one with 39 dB of gain). The line amplifiers provide sufficient gain to offset the cable attenuation and to increase the signal level for retransmission inside a building. The line amplifiers amplify the RF signal from the combiner while providing a DC Bypass to deliver DC operating voltage to the rest of the system.

4. DC Injector

The DC Injector is a bias Tee with a built in AC adapter. The AC adapter portion supplies the system with the required DC voltage (7.5 VDC at 1000 mA.) and the Bias Tee portion injects the DC voltage into the system coax to bias the active components while isolating the RF signal from the AC adapter. The DC injector only supplies DC from one side (the side where the AC adapter cable exits) the other port blocks DC while RF signals pass through the device with only about 1 dB of attenuation.

5. Transmit Antenna

The transmit antenna used in the XMSSR923WR system is a passive version of the same LHCP, 7 dB Gain antenna design used in the receive antennas described above. This directional antenna provides a 70 degree by 60 degree signal beam that may be pointed toward the display area where the receivers are located. This antenna radiates the Satellite Radio signals to allow the radios in the covered display area to function properly.

System operation

The XMSSR923WR system is designed to receive Satellite Radio signals from the SDARS satellites via two, external, roof or wall mounted antennas, route the signals into the building via coaxial cables, amplify the signals to overcome cable attenuation and retransmit the signals to provide coverage to a portion of a building. The repeater is designed to have sufficient system gain to provide adequate signal inside retail establishments.

The system has no operator controls and is not adjustable by the end user. Proper system operation is controlled through the orientation and location of the receive and transmit antennas. See the Installation Instructions for additional information. Once the system is installed and the AC adapter is connected to the 120 volt supply, the system may be tested by connecting automotive antennas to an XM and a Sirius receiver in the covered display area, powering up the receivers and listening to the stereos. Additional coverage information may be obtained by installing a Delphi Sky Fi receiver in a battery operated Boom Box and analyzing the signal information using the "Antenna Aiming" feature of the radio. This feature provides Satellite and Terrestrial signal indications for XM signals.

EXHIBIT B

Attached is the following information for each of the in-store signal boosters XM seeks to operate pursuant to this STA.

- (1) antenna type;
- (2) antenna beamwidth;
- (3) total EIRP; and
- (4) approximate height Above Ground Level (AGL)

City	Antenna Type	Antenna Beamwidth	EIRP Total in Watts	Height AGL
Various	Antenna Specialists XMSSR923WR	75 degrees	0.0001	< 50 feet

The transmitted carriers have a center frequency and frequency stability identical to the received SDARS satellite or terrestrial carriers. Frequency accuracy is controlled by the satellite or terrestrial repeater and not by the booster.

EXHIBIT C

Calculation of Free-Space Loss

$$\begin{aligned}\alpha(\text{in dB}) &= 36.6 + 20 \log (f) + 20 \log (d) \\ f &= \text{transmission frequency in MHz} \\ d &= \text{separation distance in miles}\end{aligned}$$

Assuming the *worst case* frequency (*i.e.*, 2320 MHz) and 0.001 miles (*i.e.*, 5.3 feet) separation:

$$\begin{aligned}\alpha(\text{in dB}) &= 36.6 + 20 \log (2320) + 20 \log (0.001) \\ &= 36.6 + 67.3 - 60.0 \\ &= 43.9 \text{ dB}\end{aligned}$$

Calculation of Signal Power Received (P_R) By WCS Receiver Assuming It Has Omni-Directional (0 dBi) Antenna

$$P_R(\text{in dBW}) = \text{EIRP}_{MP} - \alpha$$

EIRP_{MP} is the output of the booster at beampeak (*i.e.*, 0.0001 watts or -40 dBW) (antenna beamwidth at 3 dB pattern points is 75°).

$$\begin{aligned}P_R(\text{in dBW}) &= -40 \text{ dBW} - 43.9 \text{ dB} \\ &= -83.9 \text{ dBW}\end{aligned}$$

Calculation of Margin at WCS Receiver (Assuming A Well-Designed Unit Operates Unimpaired With OOB Interference Of -65 dBW)

$$\begin{aligned}\text{Margin} &= -65 \text{ dBW} - (-83.9 \text{ dBW}) \\ &= 18.9 \text{ dB}\end{aligned}$$

Notes:

- (1) The calculation is done on a line-of-sight (*i.e.*, 5.3 feet) co-polarized basis.
- (2) The booster is for indoor operation and no wall/ceiling attenuation, which would normally exist, has been added to the margin. Where WCS equipment operates outside of the store where the booster is located, the margin will increase by another 9 dB as a result of wall or ceiling attenuation, providing additional protection to any possible outdoor WCS receivers.
- (3) Near field effects should be negligible. Locations at other than beampeak receive even lower P_R levels.

EXHIBIT D

“Micro-Repeater STA Conditions”

Micro-Repeater STA Conditions

1. Sirius and XM Radio shall operate the in-store signal boosters at their own risk and such operation shall not prejudice the outcome of the final rules adopted by the Commission in GEN Docket 95-91;
2. Sirius and XM Radio shall operate the in-store signal boosters on a non-interference basis with respect to all permanently authorized radiocommunication facilities;
3. The in-store signal boosters are restricted to the simultaneous retransmission of the complete programming, and only that programming, transmitted by the satellite directly to SDARS receivers;
4. Where applicable, coordination of the in-store signal boosters shall be completed with all affected Administrations prior to operation, in accordance with all applicable international agreements including those with Canada and Mexico;
5. The in-store signal boosters shall comply with Part 17 of the Commission's rules - Construction, Marking, and Lighting of Antenna Structures;
6. The in-store signal boosters shall comply with Part 1 of the Commission's rules, Subpart I - Procedures Implementing the National Environmental Policy Act of 1969, including the guidelines for human exposure to radio frequency electromagnetic fields as defined in Sections 1.1307(b) and 1.1310 of the Commission's rules;
7. The out-of-band emissions of the in-store signal boosters shall be limited to $75 + \log(\text{EIRP})$ dB less than the transmitter EIRP;
8. Sirius and XM Radio shall operate the in-store signal boosters according to the technical parameters provided in their applications for special temporary authority to operate such in-store signal boosters;
9. The total aggregate number of in-store signal boosters between Sirius and XM Radio shall not exceed 5,000;
10. Sirius and XM Radio shall have joint ownership of each of the in-store signal boosters;
11. Sirius and XM Radio shall have joint operational control of each of the in-store signal boosters;
12. The in-store repeaters shall be professionally installed pursuant to written instructions provided by Sirius and XM Radio and shall be labeled with contact telephone numbers for Sirius and XM Radio to be called in the event that a booster causes interference;
13. Sirius and/or XM Radio shall immediately shut down any, or all, in-store signal boosters upon a complaint of interference, upon direction from the Commission, or upon finding that an in-store signal booster has not been properly installed;

Micro-Repeater STA Conditions

14. Sirius and XM Radio shall have joint and several liability for any harmful interference caused by an in-store signal booster, and shall have joint and several liability for any forfeiture or other penalty imposed by the Commission as a result of any harmful interference.