

November 3, 2014

TEL +1 202 730 1300
FAX +1 202 730 1301
HWGLAW.COM

ATTORNEYS AT LAW

BY ELECTRONIC FILING

Marlene H. Dortch, Secretary
Federal Communications Commission
445 Twelfth Street, S.W.
Washington, DC 20554

Re: *Submission of Measured Transmitting Antenna Off-Axis Gain Information for
Call Sign S2711*

Dear Ms. Dortch:

Pursuant to Section 25.264 of the Commission's rules and the *17/24 GHz BSS Second R&O*,¹ DIRECTV Enterprises, LLC ("DIRECTV") hereby requests that its authorization for DIRECTV RB-1, a geostationary satellite in the 17/24 GHz Broadcasting Satellite Service ("BSS") authorized to operate at the nominal 99° W.L. orbital location,² be modified to reflect the submission of the measured transmitting antenna off-axis gain information and associated power flux-density ("PFD") calculations attached hereto. These materials were previously submitted to the Commission, but DIRECTV is re-filing this submission in the form of a modification application at the request of the International Bureau staff.

In addition, DIRECTV requests that the station keeping tolerance for this space station be reduced from $\pm 0.05^\circ$ to $\pm 0.025^\circ$, as we requested in the original application. Please direct any questions you may have to me.

Respectfully submitted,

/s/

William M. Wiltshire
Counsel for DIRECTV Enterprises, LLC

Attachment

¹ *Establishment of Policies and Service Rules for the Broadcasting-Satellite Service at the 17.3-17.7 GHz Frequency Band and at the 17.7-17.8 GHz Frequency Band Internationally, and at the 24.75-25.25 GHz Frequency Band for Fixed Satellite Services Providing Feeder Links to the Broadcasting-Satellite Service and for the Satellite Services Operating Bi-directionally in the 17.3-17.8 GHz Frequency Band*, 26 FCC Rcd. 8927 (2011) ("*17/24 GHz BSS Second R&O*").

² *See Stamp Grant*, IBFS File Nos. SAT-LOA-20060908-00099, SAT-AMD-20080114-00013, SAT-AMD-20080321-00076 (granted July 28, 2009).



April 5, 2013

BY ELECTRONIC FILING

Marlene H. Dortch
Secretary
Federal Communications Commission
445 Twelfth Street, S.W.
Washington, DC 20554

Re: *Submission of Measured Transmitting Antenna Off-Axis Gain Information for
Call Sign S2711*

Dear Ms. Dortch:

Pursuant to Section 25.264 of the Commission's rules and the *17/24 GHz BSS Second R&O*,¹ DIRECTV Enterprises, LLC ("DIRECTV") hereby submits the measured transmitting antenna off-axis gain information and associated power flux-density ("PFD") calculations for DIRECTV RB-1, a geostationary satellite in the 17/24 GHz Broadcasting Satellite Service ("BSS") authorized to operate at the nominal 99° W.L. orbital location.²

As required under Section 25.264(a), DIRECTV previously submitted the predicted transmitting antenna off-axis gain information for DIRECTV-RB1.³ Section 25.264(c) provides that, no later than nine months prior to launch, each 17/24 GHz BSS space station licensee must submit measured transmitting antenna off-axis gain information over the same angular ranges, measurement frequencies, and polarizations described in Section 25.264(a). Those requirements are as follows:

¹ *Establishment of Policies and Service Rules for the Broadcasting-Satellite Service at the 17.3-17.7 GHz Frequency Band and at the 17.7-17.8 GHz Frequency Band Internationally, and at the 24.75-25.25 GHz Frequency Band for Fixed Satellite Services Providing Feeder Links to the Broadcasting-Satellite Service and for the Satellite Services Operating Bi-directionally in the 17.3-17.8 GHz Frequency Band*, 26 FCC Rcd. 8927 (2011) ("*17/24 GHz BSS Second R&O*").

² *See Stamp Grant*, IBFS File Nos. SAT-LOA-20060908-00099, SAT-AMD-20080114-00013, SAT-AMD-20080321-00076 (granted July 28, 2009).

³ *See Stamp Grant*, IBFS File No. SAT-MOD-20111128-00230 (granted May 24, 2012).

Marlene H. Dortch

April 5, 2013

Page 2 of 6

- (1) in the X-Z plane, *i.e.*, the plane of the geostationary orbit, over a range of ± 30 degrees from the positive and negative X axes in increments of 5 degrees or less;
- (2) in planes rotated from the X-Z plane about the Z axis, over a range of ± 60 degrees relative to the equatorial plane, in increments of 10 degrees or less;
- (3) in both polarizations;
- (4) at a minimum of three measurement frequencies determined with respect to the entire portion of the 17.3-17.8 GHz frequency band over which the space station is designed to transmit: 5 MHz above the lower edge of the band; at the band center frequency; and 5 MHz below the upper edge of the band; and
- (5) over a greater angular measurement range, if necessary, to account for any planned spacecraft orientation bias or change in operating orientation relative to the reference coordinate system. The applicant must also explain its reasons for doing so.

This information is to be measured under conditions as close to flight configuration as possible, though the Commission has specifically recognized that this exercise may be conducted with “the use of simulated spacecraft components.”⁴

In the attached Technical Appendix, DIRECTV submits such measured data for DIRECTV RB-1.⁵ This data was obtained by the satellite manufacturer, Space Systems/Loral (“SS/L”), on a Compact Antenna Test Range (“CATR”) using the actual transmit antenna for the DIRECTV RB-1 satellite. That antenna has not yet been integrated with the spacecraft. Thus, for purposes of these measurements, the antenna was combined with simulated spacecraft components to represent those elements of the actual spacecraft structure that could potentially play a role in influencing the far off-axis gain performance. The entire test configuration was surrounded (to the extent feasible) with material designed to absorb radio frequency energy. Slides 2 and 3 in the attached data set provide a schematic and photo of the set-up, respectively.

When considering this data, it is important to recognize that the signal levels of interest are exceedingly low. In addition, there were practical limitations to the measurement resolution obtainable in the CATR due primarily to multipath signal effects. Indeed, as a result of these limitations, the measurement resolution in the test range was reduced to signal

⁴ See 47 C.F.R. § 25.264(a); *17/24 GHz BSS Second R&O*, ¶ 50.

⁵ Since DIRECTV does not plan any orientation bias or change in operating orientation relative to the reference coordinate system for this spacecraft, it has provided data only over the range called for in the rule. See 47 C.F.R. § 25.264(a)(5).

Marlene H. Dortch
April 5, 2013
Page 3 of 6

levels that were commensurate with the signal that SS/L was attempting to measure. As such, the measured data represents a worst case set of results, with the very real expectation that the actual far off-axis levels were lower than the measured results would otherwise indicate.

In addition, Section 25.264(d) provides that, no later than nine months prior to launch, a 17/24 GHz BSS licensee must provide PFD calculations based upon the measured transmitting antenna off-axis gain information. As demonstrated in Table 1 below, based on the measured data the satellite will not exceed the $-117 \text{ dBW/m}^2/100 \text{ kHz}$ PFD coordination trigger with respect to any DBS satellite located more than 0.12° away. Again, it is likely that the actual far off-axis performance is better than shown in the measured data, and so this separation truly represents a worst case. Nevertheless, since DIRECTV RB-1 is licensed to operate at $99.235^\circ \text{ W.L.}$ and the nearest prior-filed or subsequently-filed U.S. DBS space station is DIRECTV 8, located at $100.85^\circ \text{ W.L.}$ (*i.e.*, over 1.5° away, net of station keeping allowances), the spacecraft will not trigger the PFD threshold at any relevant location.

Max EIRP from Sched S (dBW/36 MHz)	58
Peak TX Antenna gain from Sched S (dBi)	36.9
Max power into antenna (dBW/36 MHz)	21.1
Max power density into antenna (dBW/100 kHz)	-4.5
Max off-axis measured antenna gain (dBi)	-2.8
Max off-axis EIRP density (dBW/100 kHz)	-7.3
Coordination trigger value (dBW/m ² /100 kHz)	-117
Req'd spreading loss to meet coord trigger (dB-m ²)	109.7
Req'd distance to achieve spreading loss (km)	86.5
Geocentric orbital separation equal to 86.5 km (deg)	0.12

Table 1. Orbital Separation Required to Meet Coordination Trigger

Although these measurements have been made with respect to three frequencies covering the entire portion of the 17/24 GHz BSS band over which the space station is designed to transmit, they were not made at precisely the frequencies indicated in the rule. In addition, due to mechanical/physical limitations of the test fixture, measurements could only be made over a range of ± 50 degrees relative to the equatorial plane in planes rotated from the X-Z plane about the Z axis. Accordingly, in an abundance of caution, DIRECTV has included below a request for a waiver to the extent necessary.

Marlene H. Dortch
April 5, 2013
Page 4 of 6

WAIVER REQUEST

Section 25.264(a)(4), as incorporated by Section 25.264(c), specifies that transmitting off-axis gain measurements should be made at frequencies 5 MHz above the lower edge of the band, at the band center frequency, and 5 MHz below the upper edge of the band over which the space station is designed to transmit. The measurements made for DIRECTV by its satellite manufacturer used transponder center frequencies for the lowest and highest frequency transponders on DIRECTV RB-1 (*i.e.*, transponders 1/2 and 17/18, respectively) for determining the lowest and highest frequencies of interest for these measurements. The frequency of the central transponders on DIRECTV RB-1 (*i.e.*, transponders 9/10) was used as the “band center” frequency. The actual frequencies used for these measurements were: 17326 MHz, 17486 MHz and 17646 MHz.

It is worth noting that the highest transmit EIRP density will not occur at frequencies 5 MHz above and below band edges, but rather will occur at the transponder center frequencies, due to the edge effect imposed by the filtering of the input and output multiplexers on the satellite. To estimate the far off-axis EIRP density at frequencies that are 5 MHz above and below the band edge frequencies would require reducing the power density into the transmit antenna to account for these edge effects. The antenna gain is relatively flat at frequencies just above and below the band of interest, due to the broadband nature of the antenna design. As such, by selecting the center frequency of the highest and lowest transponders, the measurements were more representative of the worst case system performance.

Section 25.264(a)(2), as incorporated by Section 25.264(c), also specifies that measurements be made “in planes rotated from the X-Z plane about the Z axis, over a range of ± 60 degrees relative to the equatorial plane, in increments of 10 degrees or less.” Due to mechanical/physical limitations of the test fixture, measurements could only be made over a range of ± 50 degrees relative to the equatorial plane in planes rotated from the X-Z plane about the Z axis.

To the extent necessary, DIRECTV hereby requests a waiver of Section 25.264(a)(4) of the Commission’s rules. Granting the requested waiver would be consistent with Commission policy.

The Commission may waive a rule for good cause shown. Waiver is appropriate if special circumstances warrant a deviation from the general rule and such deviation would better serve the public interest than would strict adherence to the general rule. Generally, the Commission may grant a waiver of its rules in a particular case if the relief requested would not undermine the

Marlene H. Dortch
April 5, 2013
Page 5 of 6

policy objective of the rule in question and would otherwise serve the public interest.⁶

The criteria justifying a waiver are clearly present in this case.

First, the Commission decided to require data at several frequencies across the transmit frequency band because “antenna off-axis gain is a frequency dependent parameter,” making it necessary to measure at the high, middle, and low frequencies of the band “[i]n order to adequately characterize the off-axis gain performance of the 17 GHz transmitting antennas.”⁷ The measurements submitted by DIRECTV accomplish this same objective, as they are made at the center frequencies of the lowest, center, and highest transponders of the DIRECTV RB-1 satellite. Moreover, as discussed above, measurements using these frequencies are more representative of the worst case system performance than would be those using the frequencies specified in the rule.

Second, the measurements were made over the greatest angular extent physically possible with the test fixture using the actual transmit antenna integrated with simulated spacecraft components. These measurements cover the large majority of the angular range specified in the Commission’s rules. While there was some variation in the absolute level of off-axis gain across the 0° to 50° angular range that was measured, all measured levels of off-axis gain were very low, and there is every reason to expect that if measurements were possible for the last 10° angular step, the results of those measurements would be very similar to the results for the range of 0 to 50°.

Accordingly, grant of the requested waiver would not undermine the policy objective of the rule in either case, and would serve the public interest by enabling DIRECTV to proceed with construction without the considerable expense and program delay that would be associated with devising a new measurement setup capable of taking measurements at a greater angular range and repeating the measurements at slightly different high and low frequencies.⁸

For the foregoing reasons, DIRECTV requests that it be granted a waiver of Section 25.264(a) and (c) of the Commission’s rules to the extent necessary.

* * *

⁶ *PanAmSat Licensee Corp.*, 17 FCC Rcd. 10483, ¶ 22 (Int’l Bur. 2002) (footnotes omitted).

⁷ *17/24 GHz BSS Second R&O*, ¶ 28.

⁸ The Commission granted a similar waiver request in connection with the frequencies used for the predicted off-axis antenna gain contours submitted by DIRECTV for this spacecraft. *See Stamp Grant*, IBFS File No. SAT-MOD-20111128-00230 (granted May 24, 2012).

WILTSHIRE & GRANNIS LLP

Marlene H. Dortch
April 5, 2013
Page 6 of 6

Should you have any questions about this submission, please do not hesitate to contact me.

Respectfully submitted,

/s/

William M. Wiltshire
Counsel for DIRECTV

Attachment

ENGINEERING CERTIFICATION

The undersigned hereby certifies to the Federal Communications Commission as follows:

- (i) I am the technically qualified person responsible for the engineering information contained in the foregoing submission,
- (ii) I am familiar with Part 25 of the Commission's Rules, and
- (iii) I have either prepared or reviewed the engineering information contained in the foregoing submission, and it is complete and accurate to the best of my knowledge and belief.

Signed:

/s/

Jack Wengryniuk

April 5, 2013

Date

TECHNICAL ATTACHMENT

DTV-14 - SE Antenna CATR R-Band Broadside Verification CATR Measured Data – Test Report

3/21/2013

Brandon George

Daniel Navarrete

This document may contain data and/or information proprietary (competition sensitive) to Space Systems/Loral (SS/L).
"Information included herein is controlled under the International Traffic in Arms Regulations ("ITAR") by the U.S. Department of State. Export or transfer of this information to a Foreign Person or foreign entity requires an export license issued by the U.S. State Department or an ITAR exemption prior to the export or transfer."

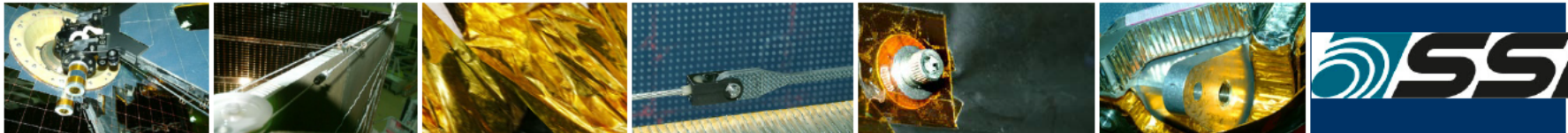

Test Setup Concept

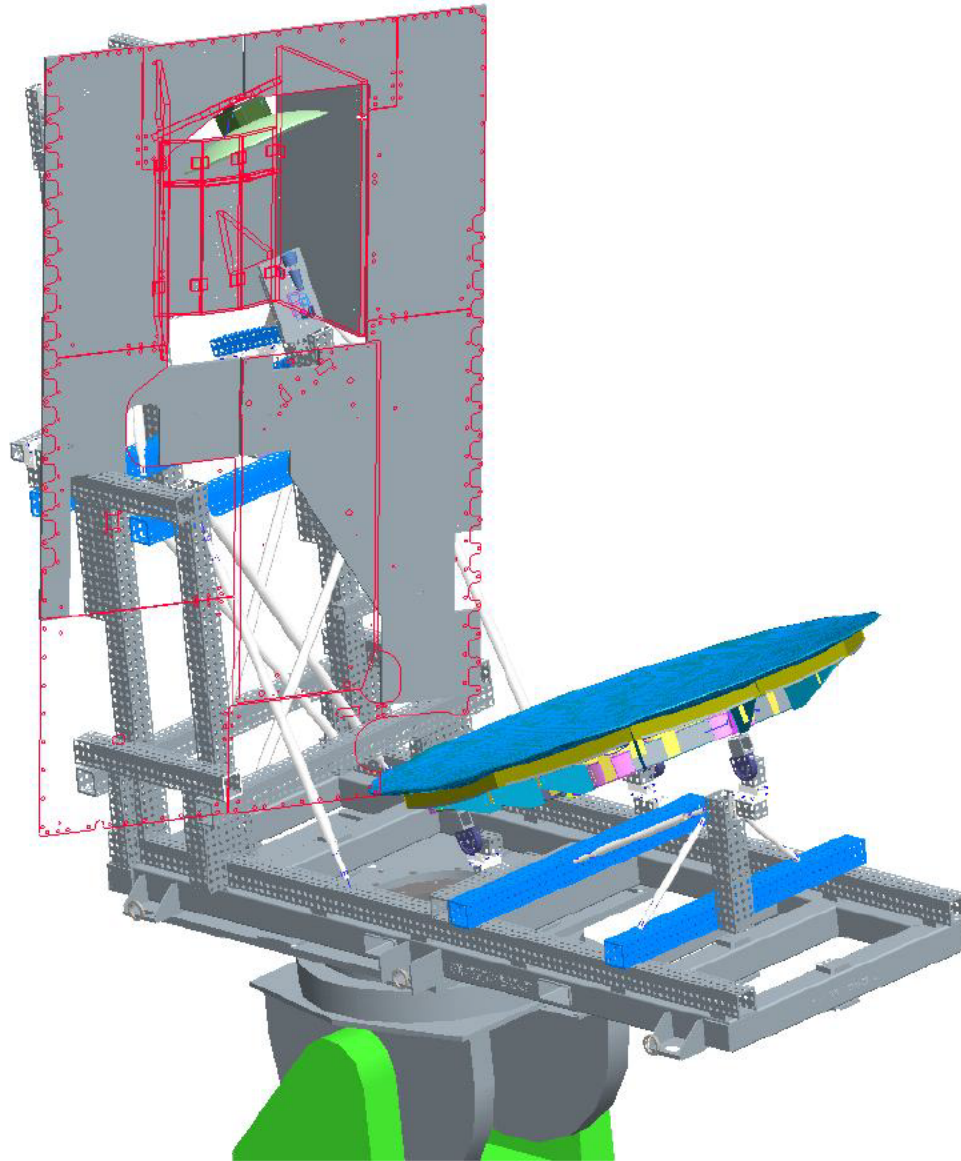

Test Setup Photo

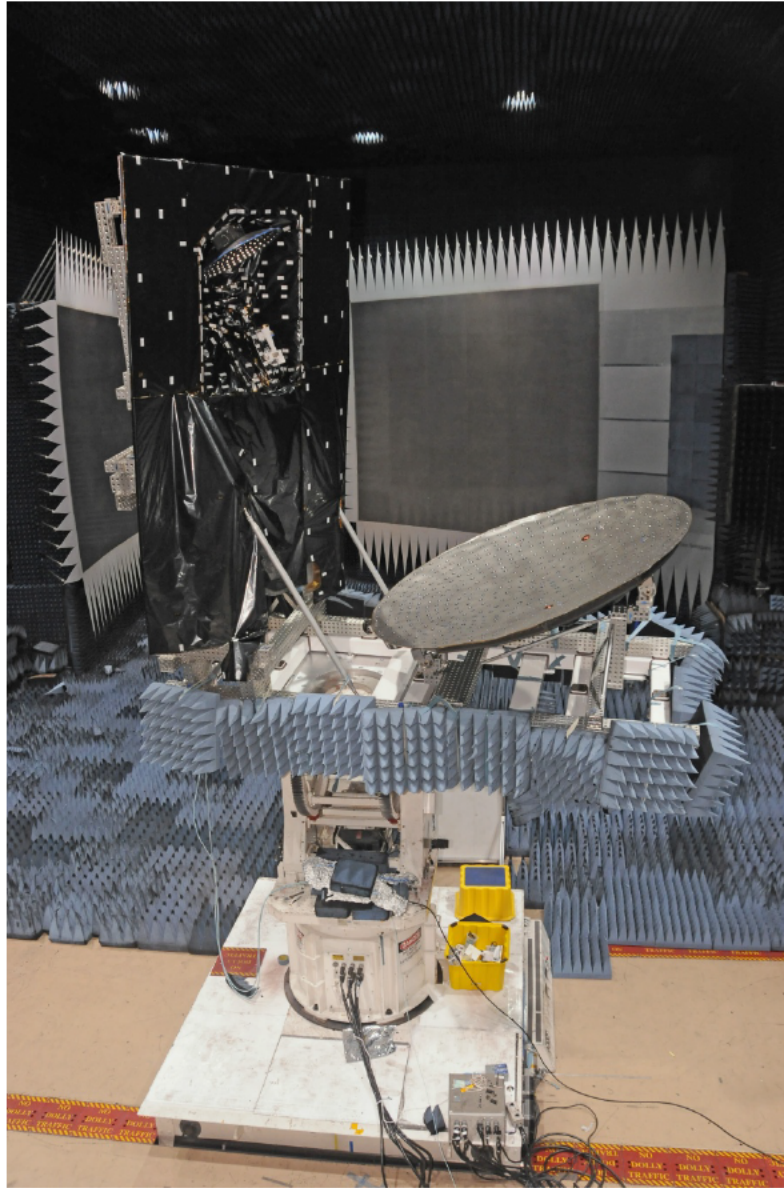

Test Summary

- ◆ DTV-14 SE Antenna CATR R-Band Broadside Verification Measurement took place in SSL's B18 CATR Facility from 2/23/2013 – 3/4/2013
- ◆ Theodolites and a precision laser tracking system were used to verify precise alignment.
- ◆ Far-Field Rasterscans were recorded with a dual-port CP probe
 - ◆ Probe Ku-8: 17.3 – 17.8 GHz
- ◆ CATR Model 2097/MI3000 System measured the Far-Field. All test frequencies (amplitude & phase) were recorded in each scan.

CATR Measured Channel Test Frequencies

➤ Test Frequencies highlighted

Channel	Polarization	Center Frequency (MHz)
Lower Edge	LHCP	17308
Lower Edge	RHCP	17308
1	RHCP	17326
2	LHCP	17326
3	RHCP	17366
4	LHCP	17366
5	RHCP	17406
6	LHCP	17406
7	RHCP	17446
8	LHCP	17446
9	RHCP	17486
10	LHCP	17486
11	RHCP	17526
12	LHCP	17526
13	RHCP	17566
14	LHCP	17566
15	RHCP	17606
16	LHCP	17606
17	RHCP	17646
18	LHCP	17646
Higher Edge	RHCP	17664
Higher Edge	LHCP	17664

RDBS Max Broadside Requirement

- ◆ **Requirements of 47 C.F.R. § 25.264: Angular Ranges for Antenna Off-Axis Gain Data**
 - Transmitting antenna off-axis gain measurements made over a range of $\pm 30^\circ$ from the X axis in the X-Z plane (in 5° intervals), and over a range of $\pm 60^\circ$ in planes rotated about the Z axis (in 10° intervals).
 - Off-axis antenna gain measurements be made at a minimum of three frequencies (5 MHz above the lower edge of the band; at the band center frequency; and 5 MHz below the upper edge of the band) in both polarizations.
 - To the extent practical, measurements should be made under conditions as close to flight configuration as possible. This could be done with the antenna mounted on the spacecraft or may include the use of simulated spacecraft components.

Measurement Process

◆ Measurement Process

- Established Gain Reference via Standard Gain Horn Measurement.
- Obtained scan data for the antenna patterns at channels 1, 2, 9,10, 17 and 18.
- Evaluated antenna patterns with +X & -X axis as the radiation directions, NOT the usual Z-axis.
- Repeated Gain Reference via Standard Gain Horn Measurement and verified Gain.

Measurement Result

◆ Result

- The measured pattern levels were at or below the CATR Facility Multipath Interference levels. Multipath interference is present in the measured data (inherent to this type of low signal level measurement in a CATR facility).
- The measured patterns showed levels commensurate to the antenna pattern predictions in the +X direction and as expected in the -X direction, when CATR Multipath contribution to the measurement is considered.
- Plots shown in the following section

DTV 14: CATR Measured Transmitting Antenna Off-Axis Gain Run 1 (+X & -X Broadside Pattern Cuts)

ATD#2987

Luke Snow

4/4/13

This document may contain data and/or information proprietary (competition sensitive) to Space Systems/Loral (SS/L).
"Information included herein is controlled under the International Traffic in Arms Regulations ("ITAR") by the U.S. Department of State. Export or transfer of this information to a Foreign Person or foreign entity requires an export license issued by the U.S. State Department or an ITAR exemption prior to the export or transfer."

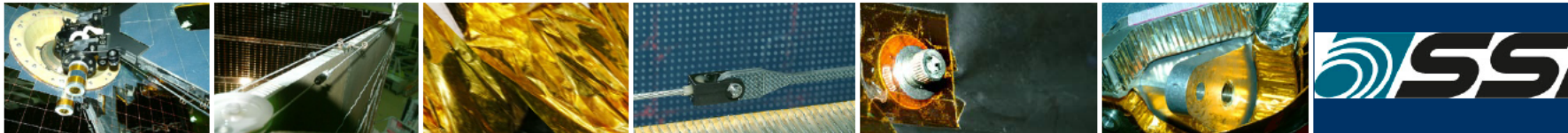

Overview

- Provide measured (run 1) transmitting antenna off-axis gain for 3 frequencies.
 - (1) In the X–Z plane, i.e., the plane of the geostationary orbit, over a range of ± 30 degrees from the positive and negative X axes in increments of 5 degrees, in both polarizations.
 - (2) In planes rotated from the X–Z plane about the Z axis, over a range of ± 50 degrees relative to the equatorial plane, in increments of 10 degrees, in both polarizations.
 - (3) For 3 frequencies: the lower edge of the band, the band center frequency, and the upper edge of the band. (Use the DTV14 frequencies measured in CATR.)

Frequency: 17.326 GHz

XZ-Plane, Yaw = 0 deg +x direction, Freq: 17326 MHz RHCP

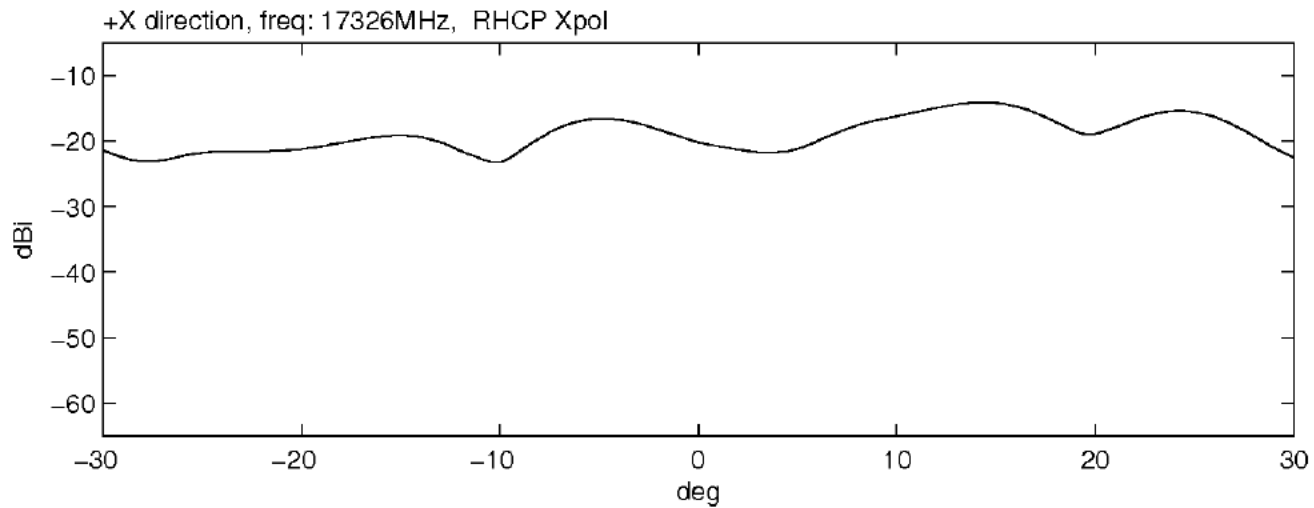
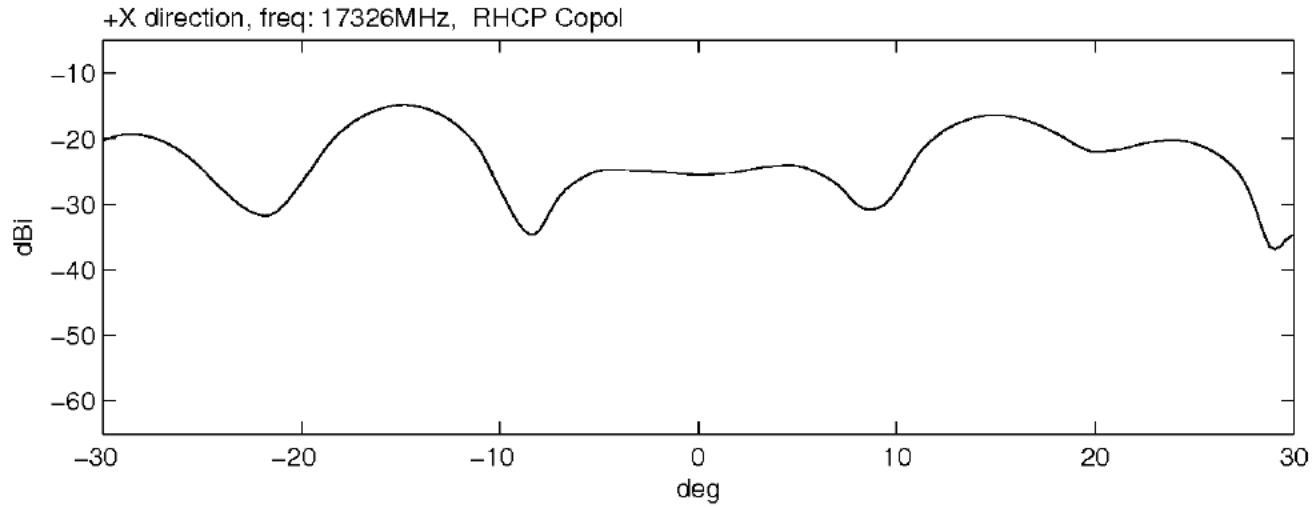

XZ-Plane, Yaw = 0 deg +x direction, Freq: 17326 MHz LHCP

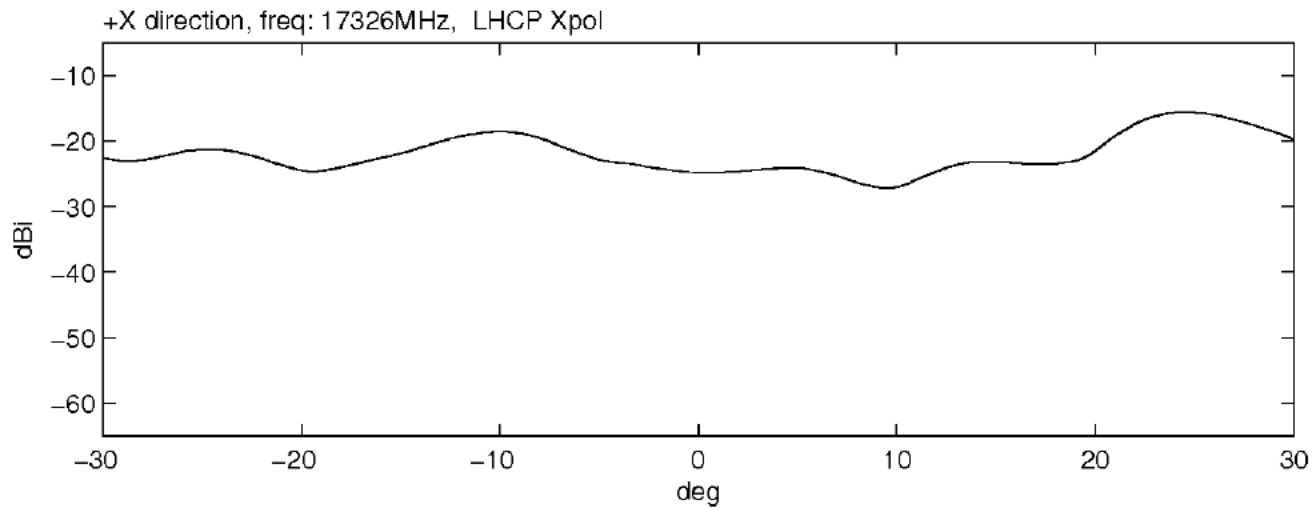
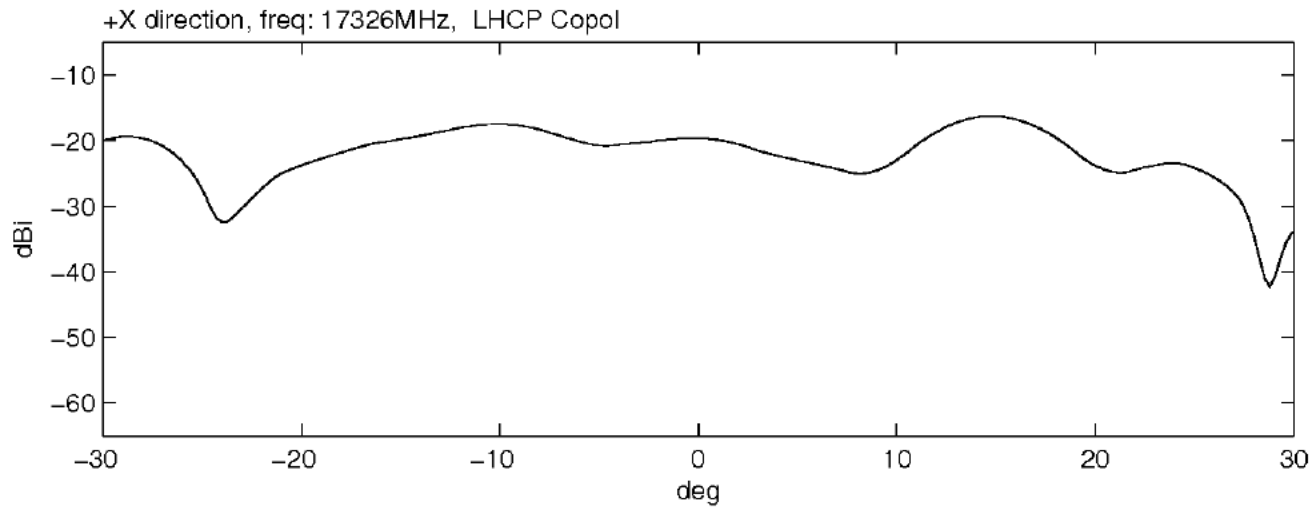

XZ-Plane, Yaw = 0 deg -x direction, Freq: 17326 MHz RHCP

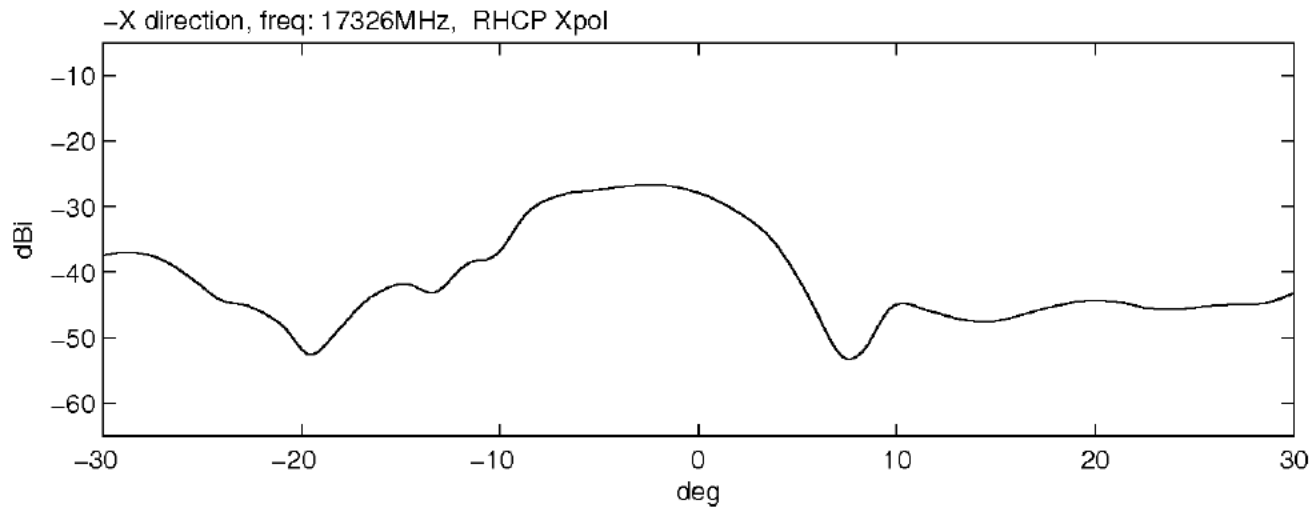
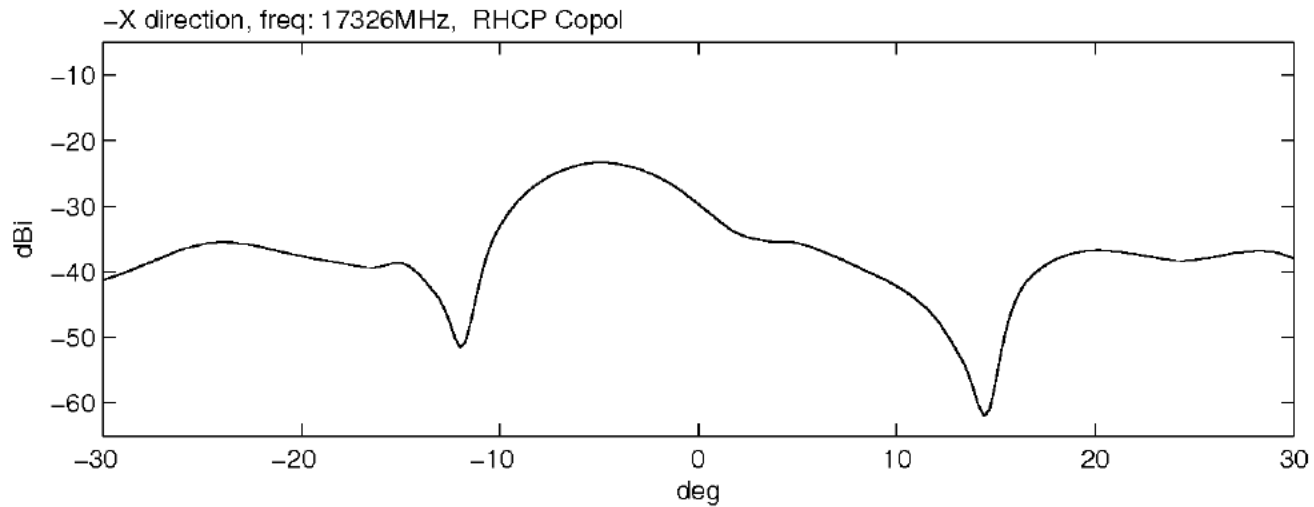

XZ-Plane, Yaw = 0 deg -x direction, Freq: 17326 MHz LHCP

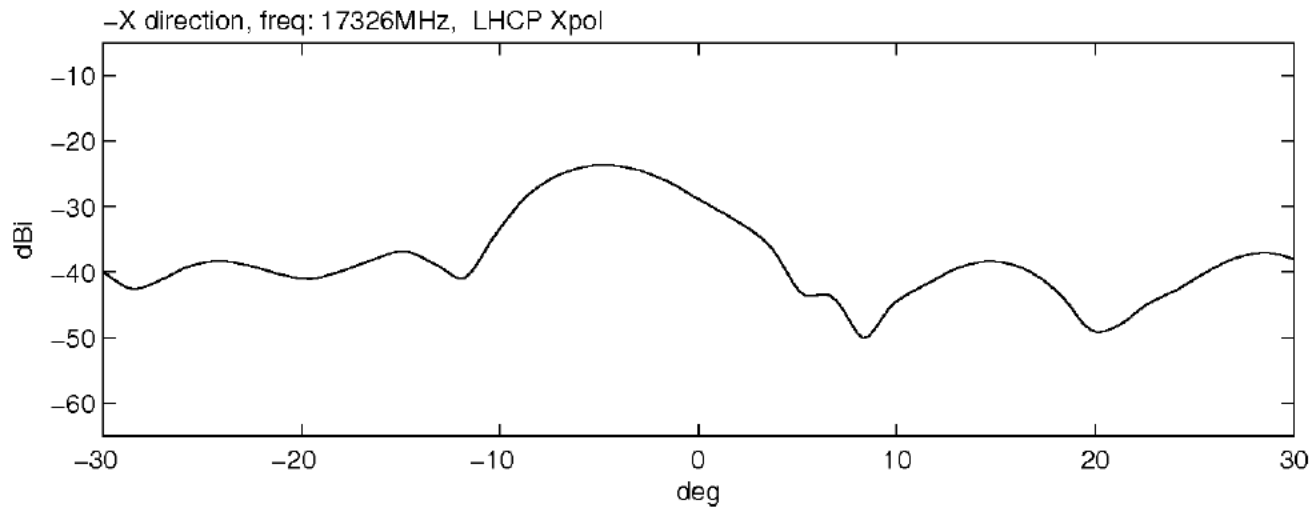
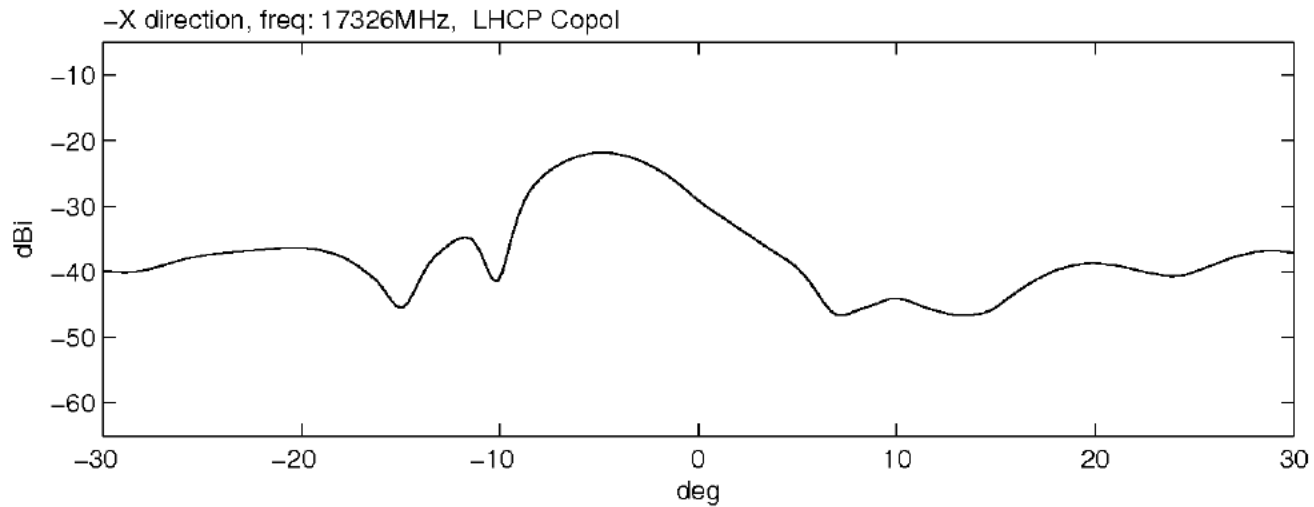

XZ-Plane, Yaw = 10 deg +x direction, Freq: 17326 MHz RHCP

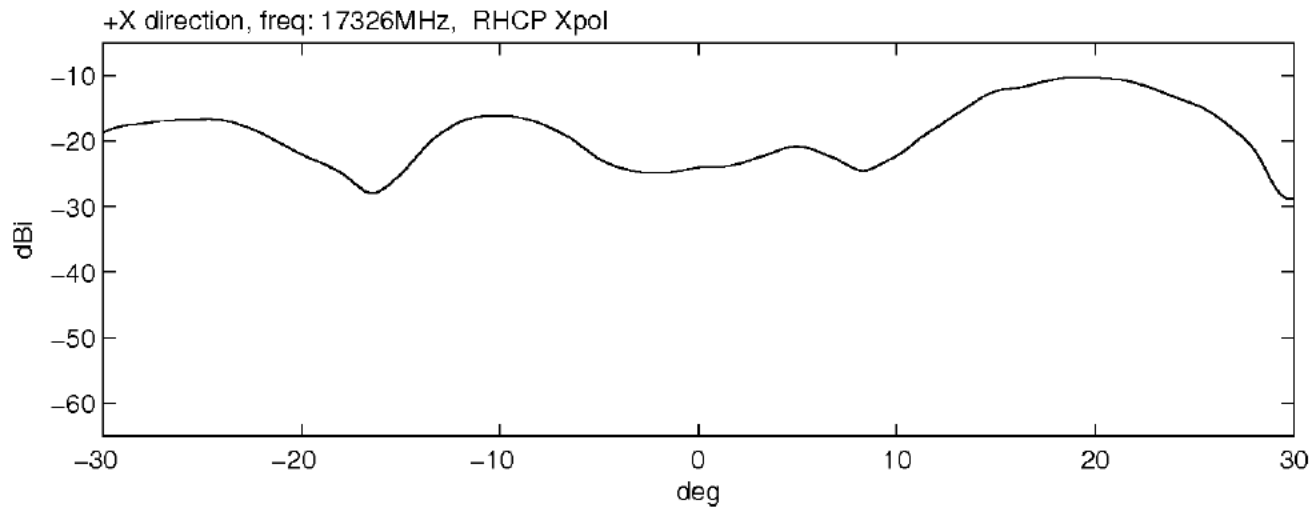
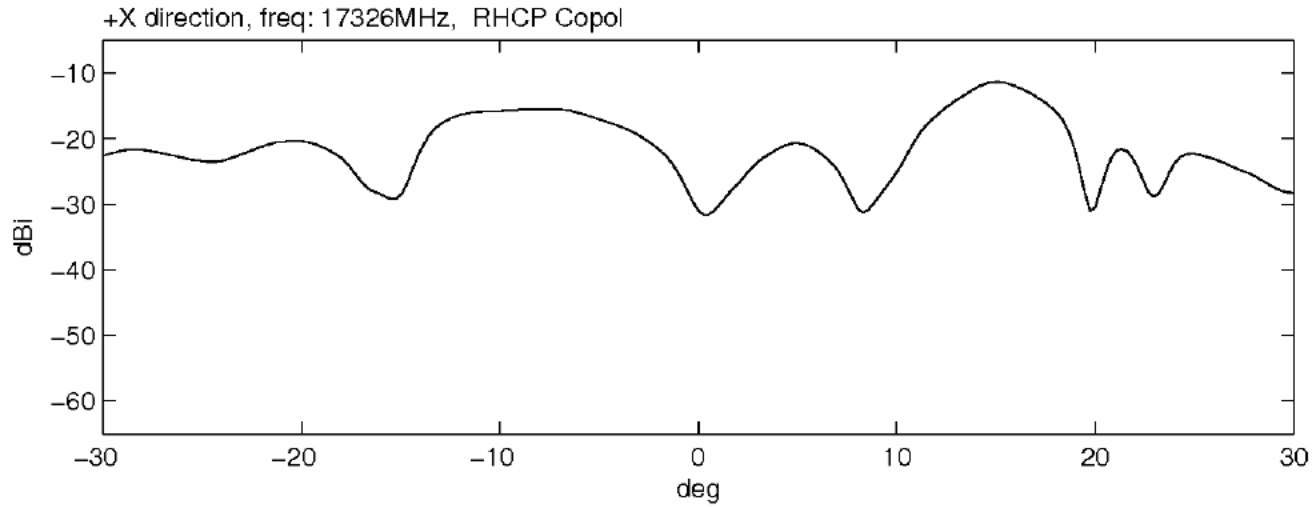

XZ-Plane, Yaw = 10 deg +x direction, Freq: 17326 MHz LHCP

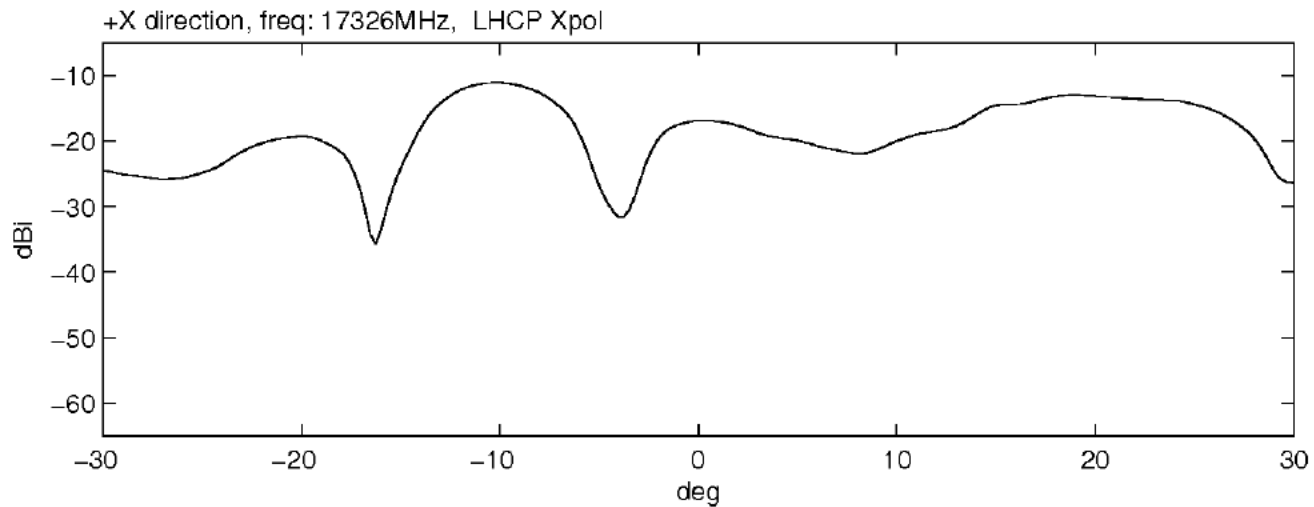
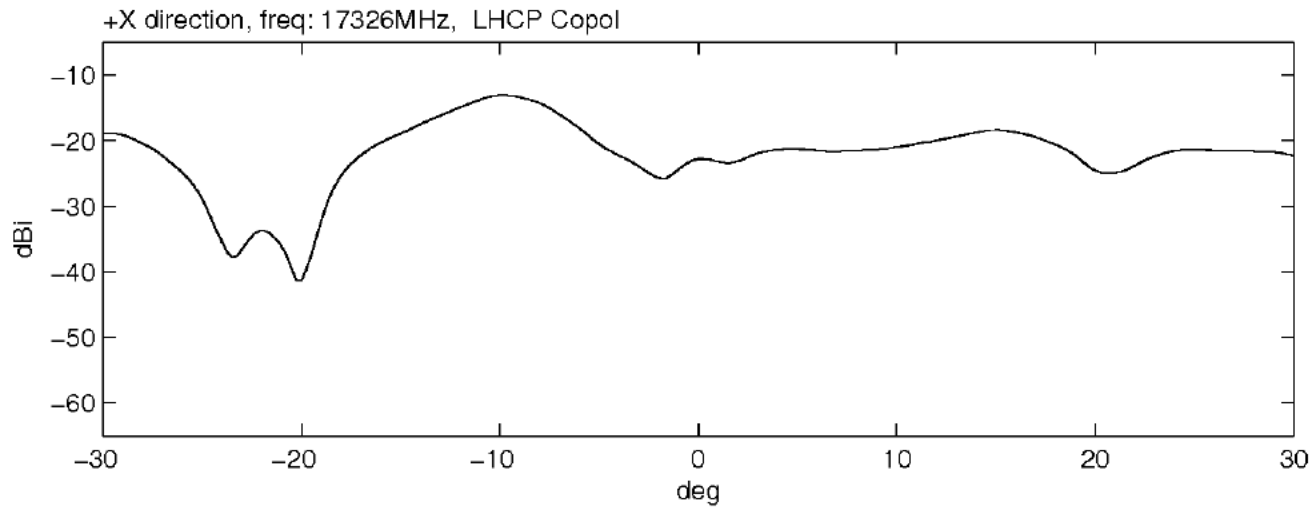

XZ-Plane, Yaw = 10 deg -x direction, Freq: 17326 MHz RHCP

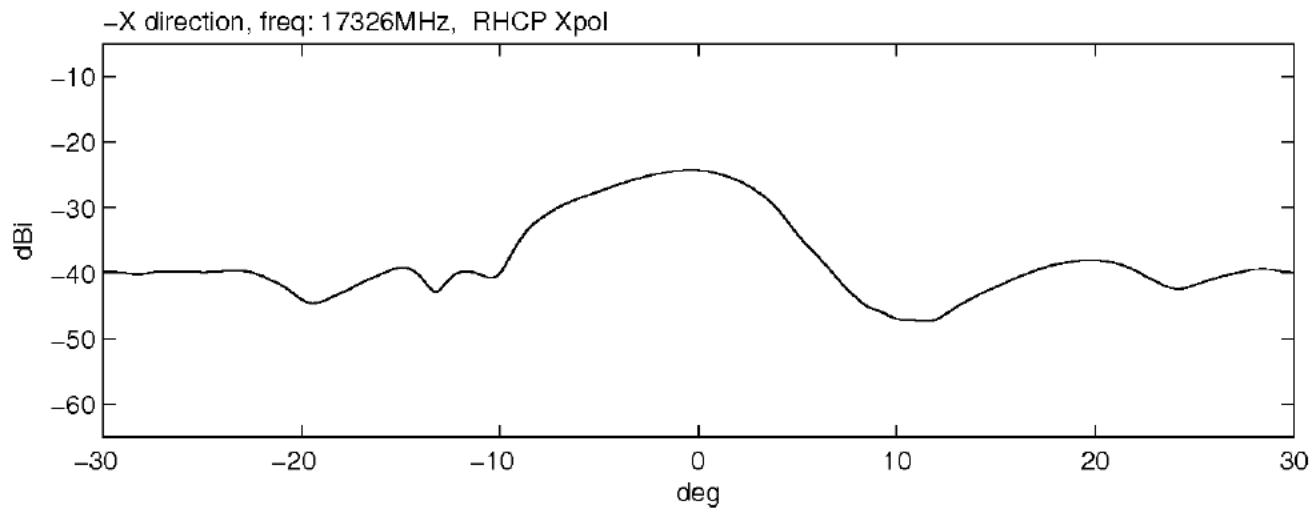
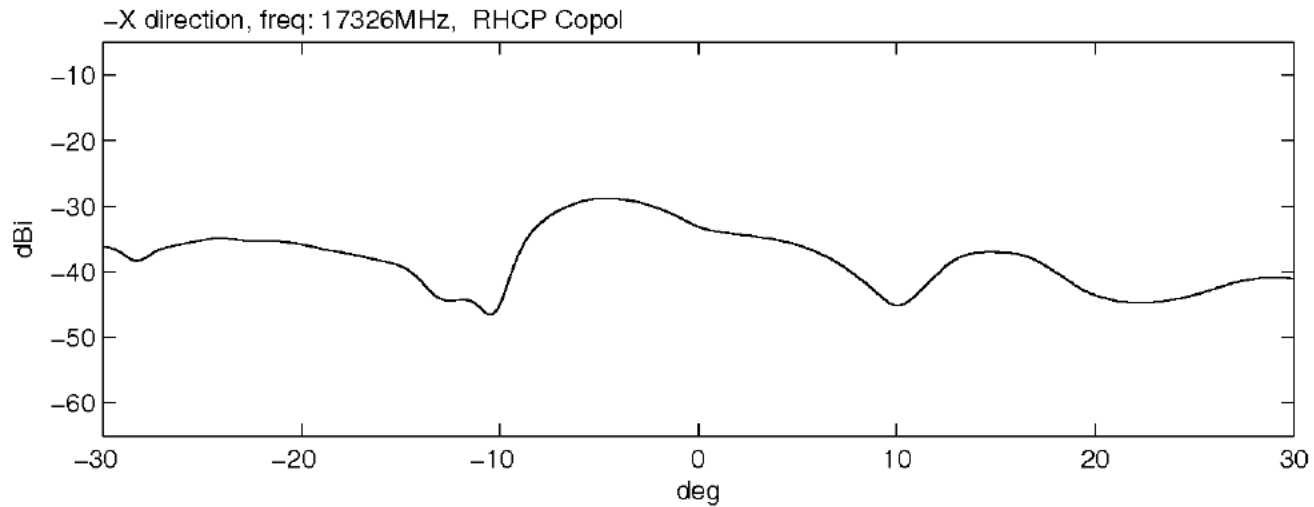

XZ-Plane, Yaw = 10 deg -x direction, Freq: 17326 MHz LHCP

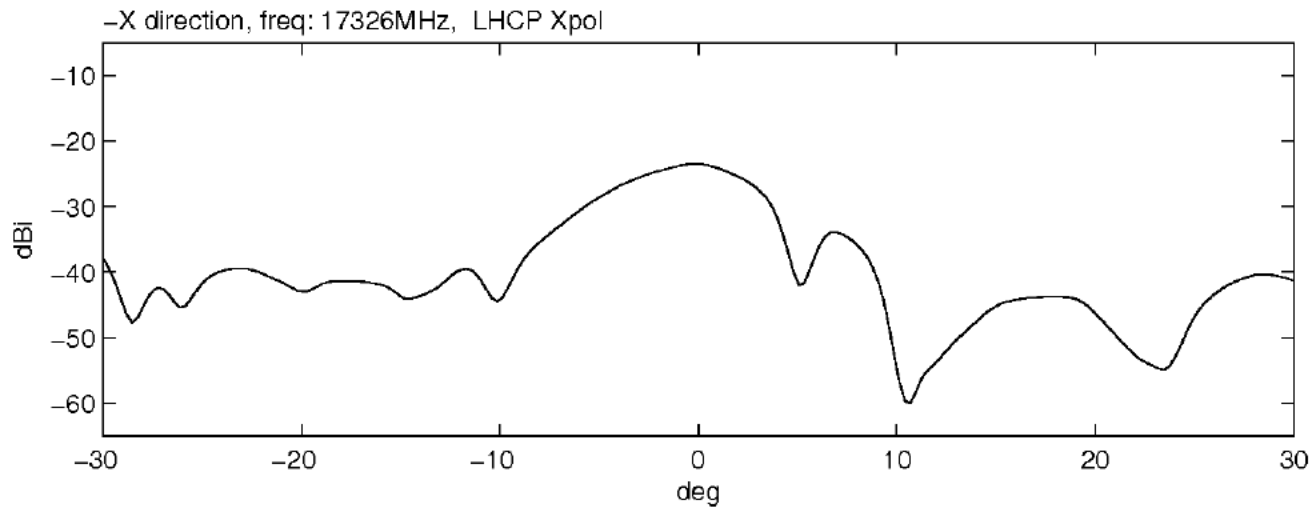
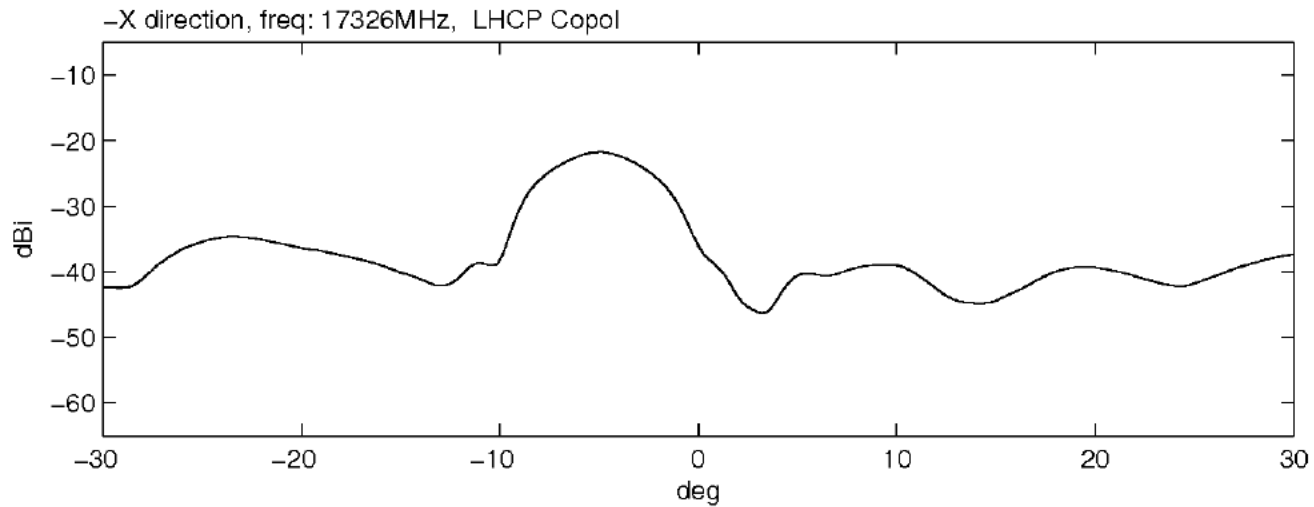

XZ-Plane, Yaw = 20 deg +x direction, Freq: 17326 MHz RHCP

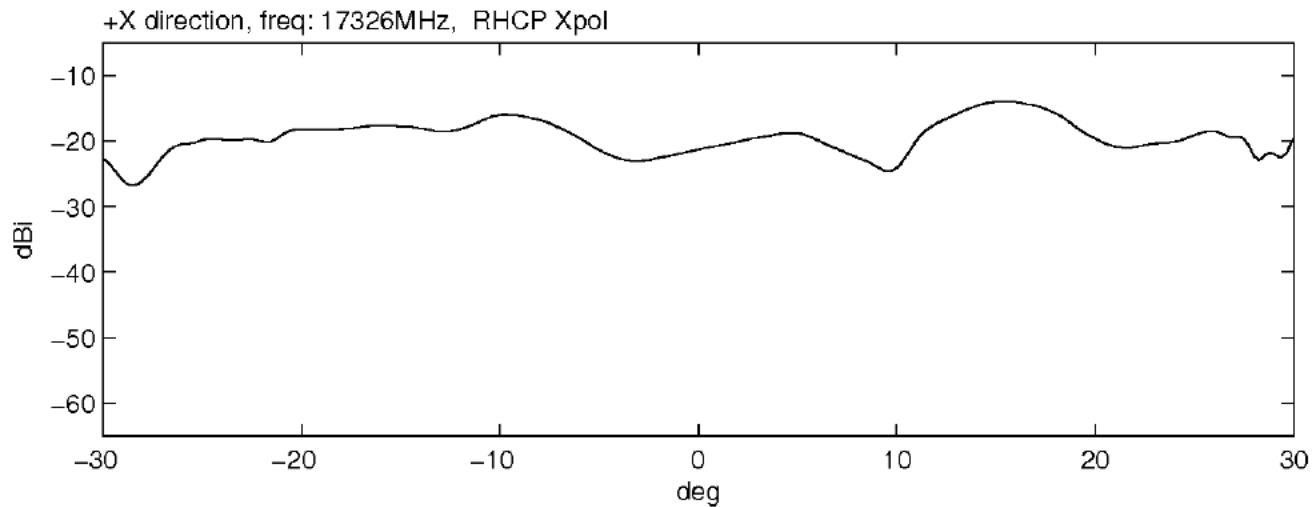
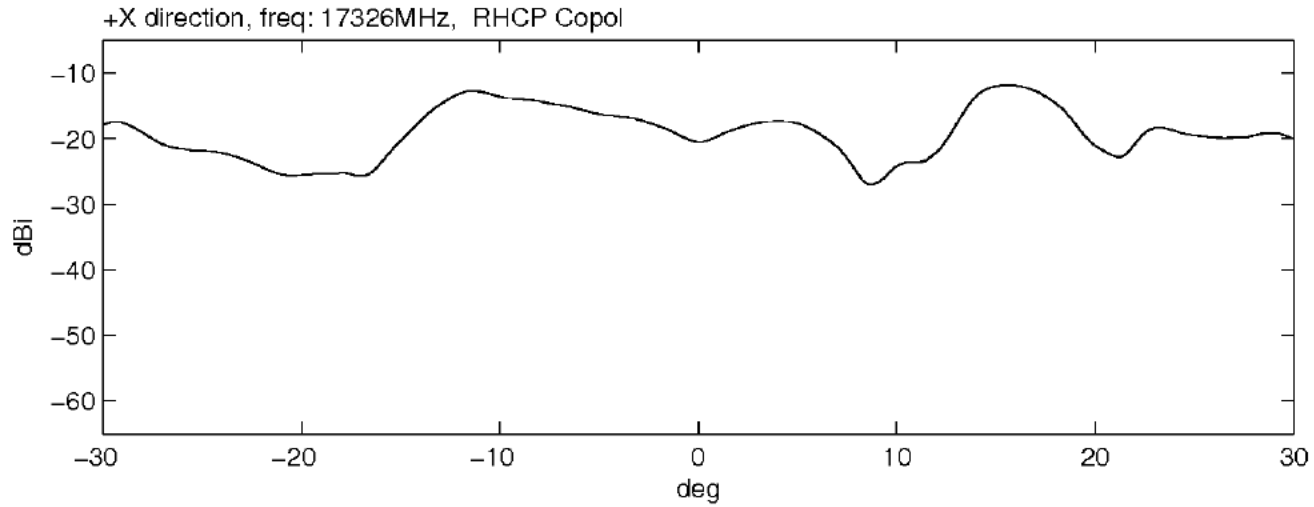

XZ-Plane, Yaw = 20 deg +x direction, Freq: 17326 MHz LHCP

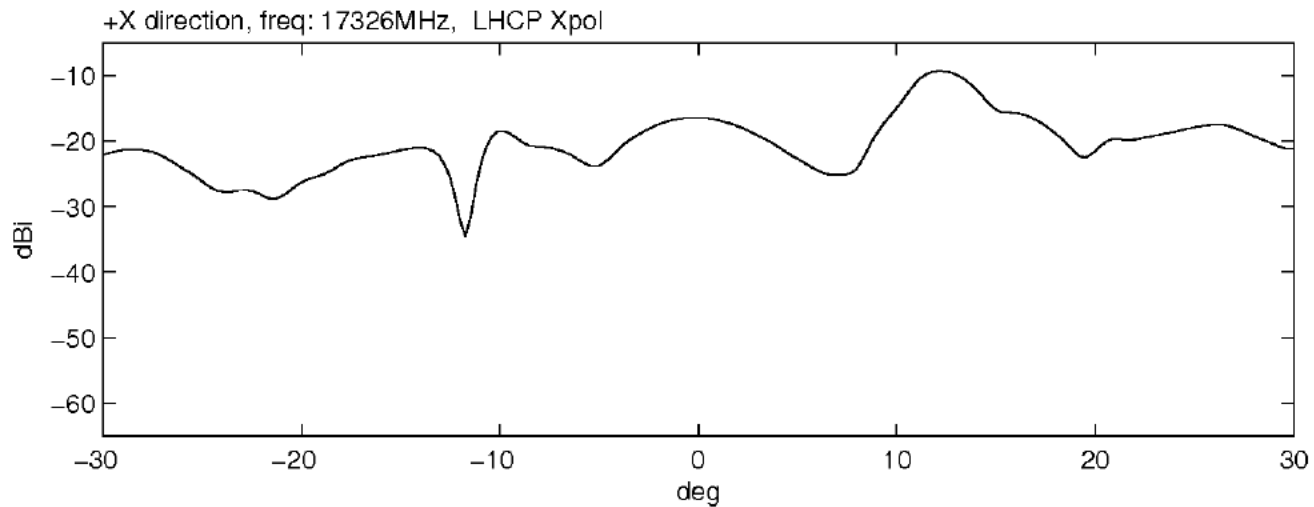
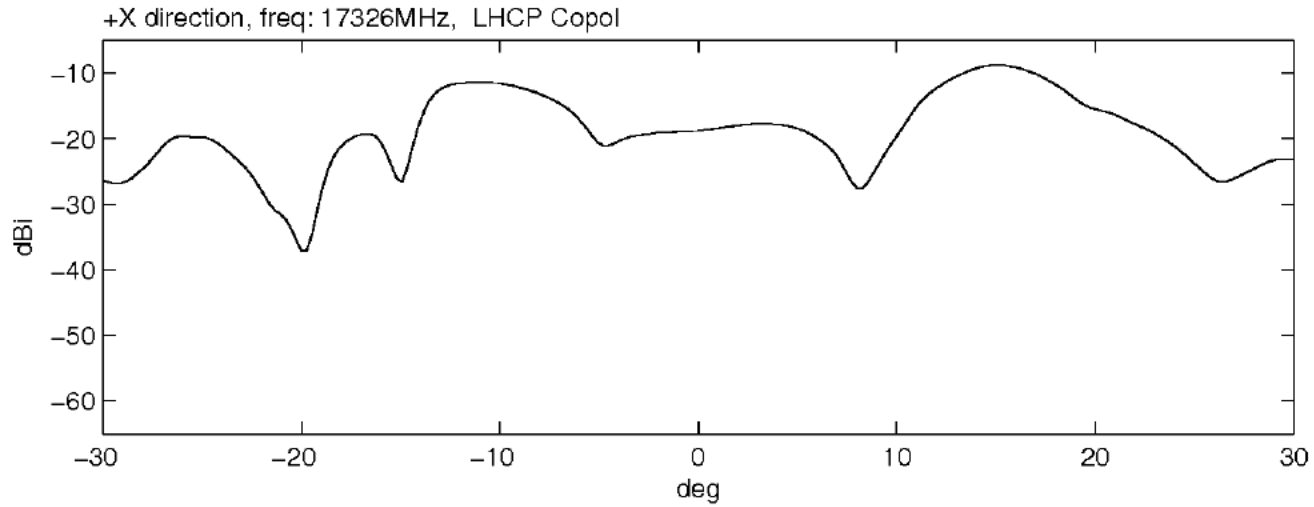

XZ-Plane, Yaw = 20 deg -x direction, Freq: 17326 MHz RHCP

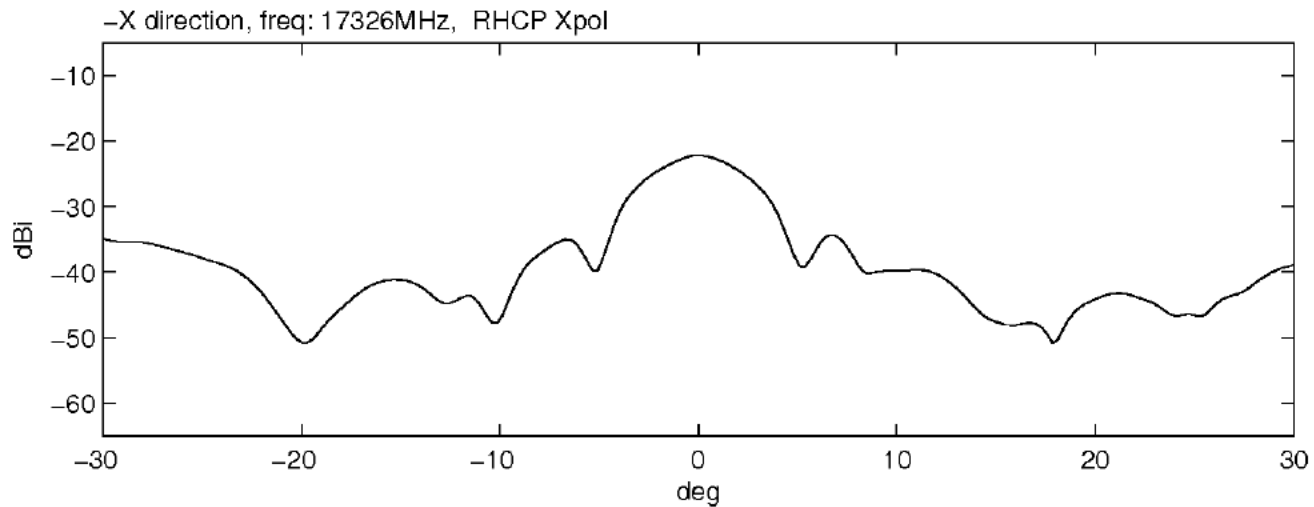
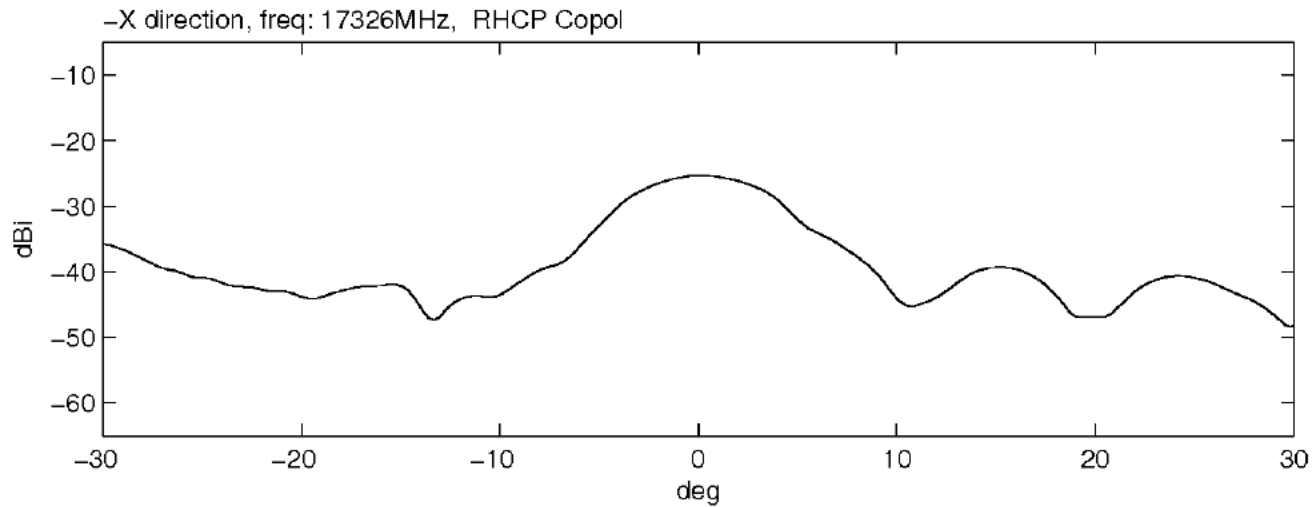

XZ-Plane, Yaw = 20 deg -x direction, Freq: 17326 MHz LHCP

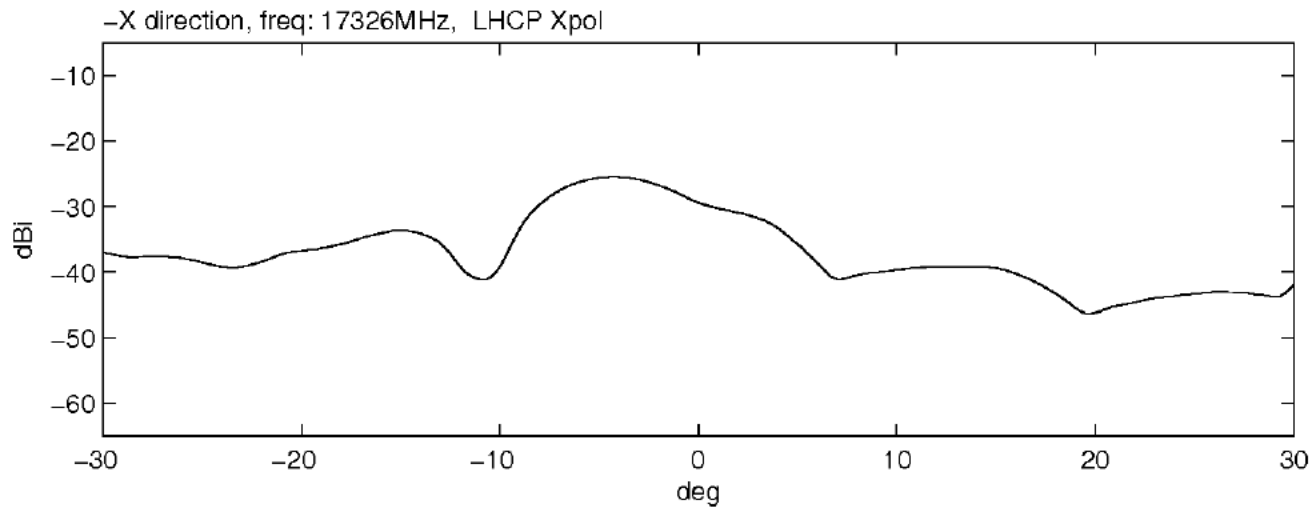
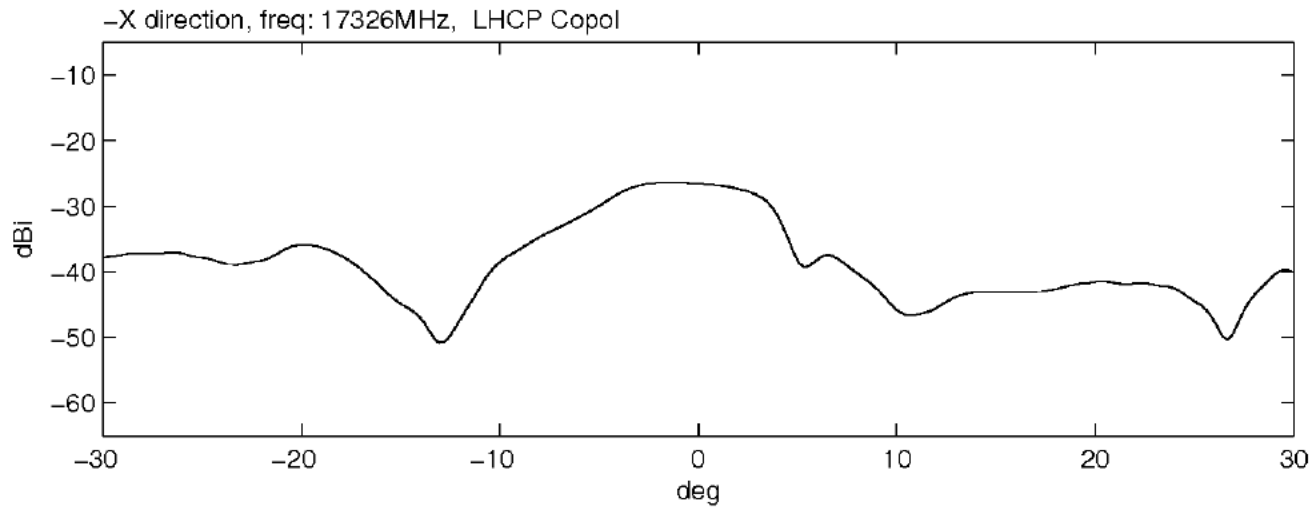

XZ-Plane, Yaw = 30 deg +x direction, Freq: 17326 MHz RHCP

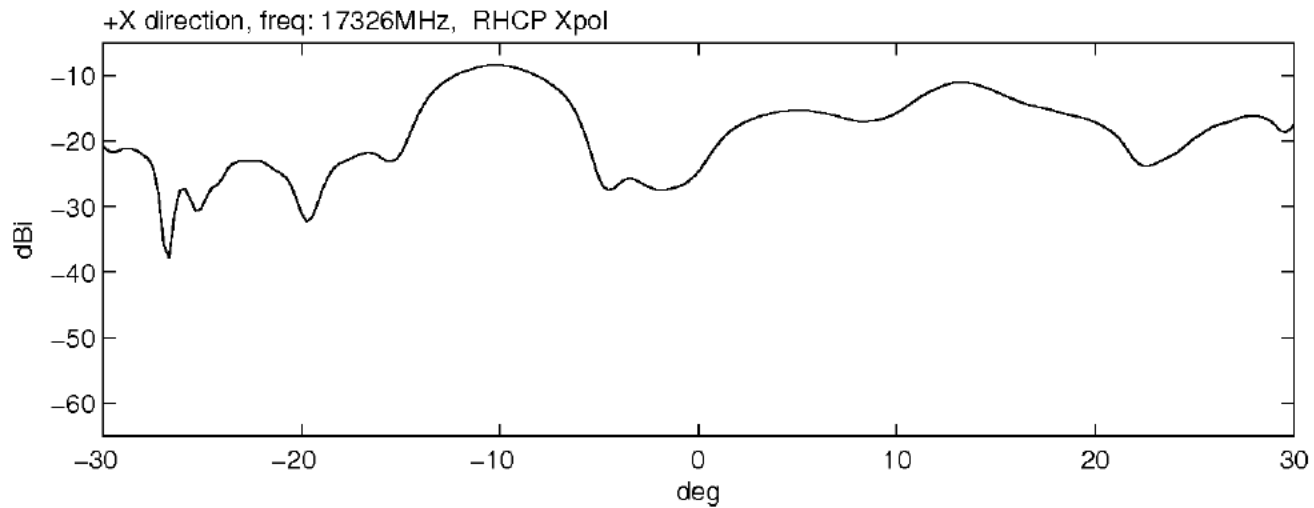
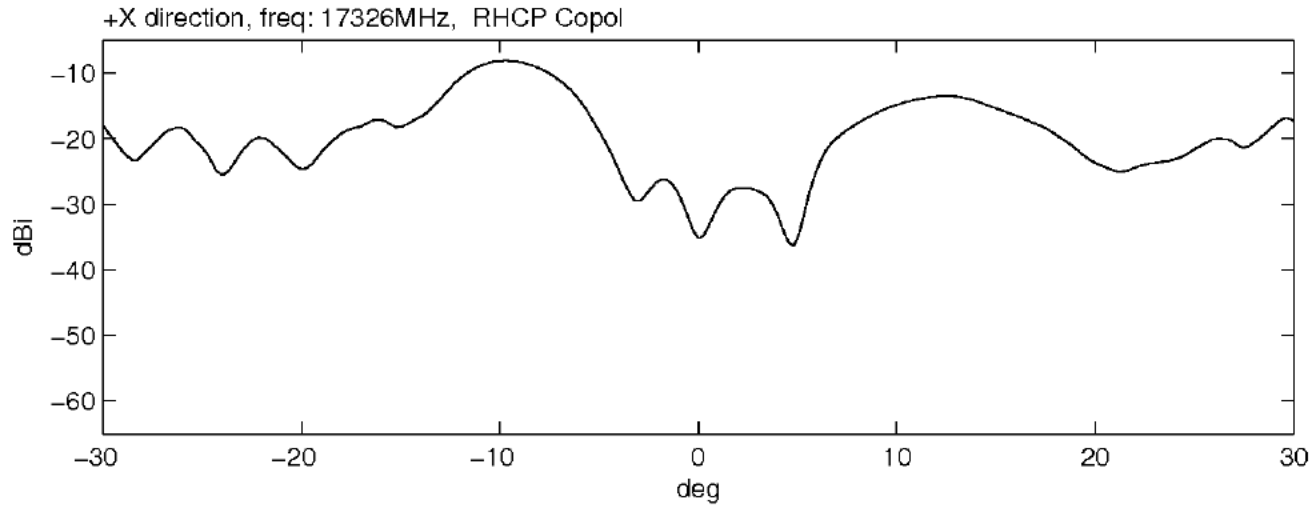

XZ-Plane, Yaw = 30 deg +x direction, Freq: 17326 MHz LHCP

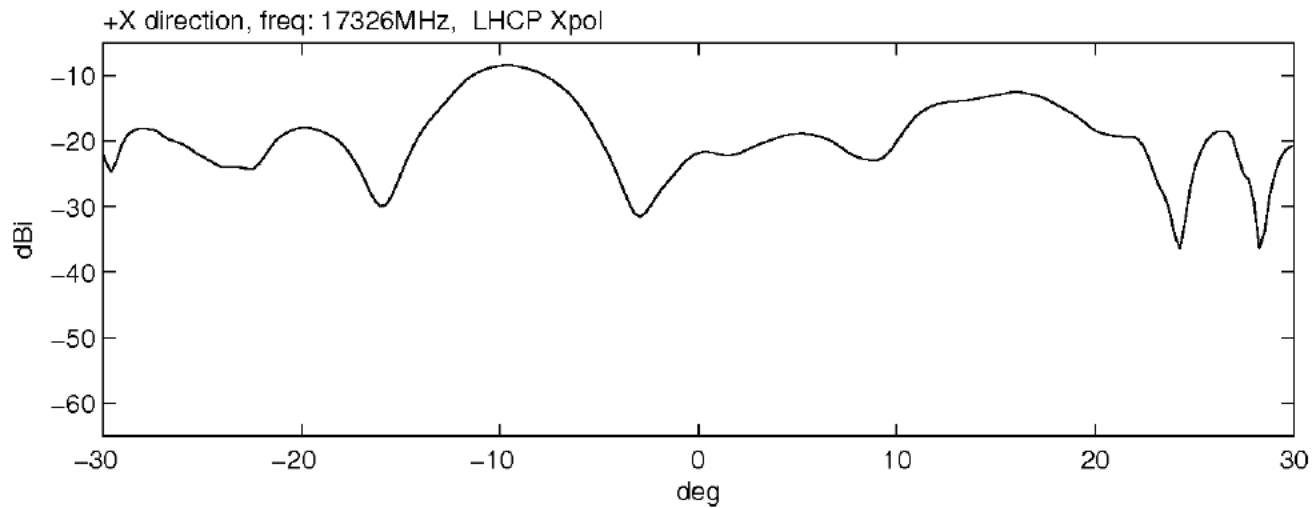
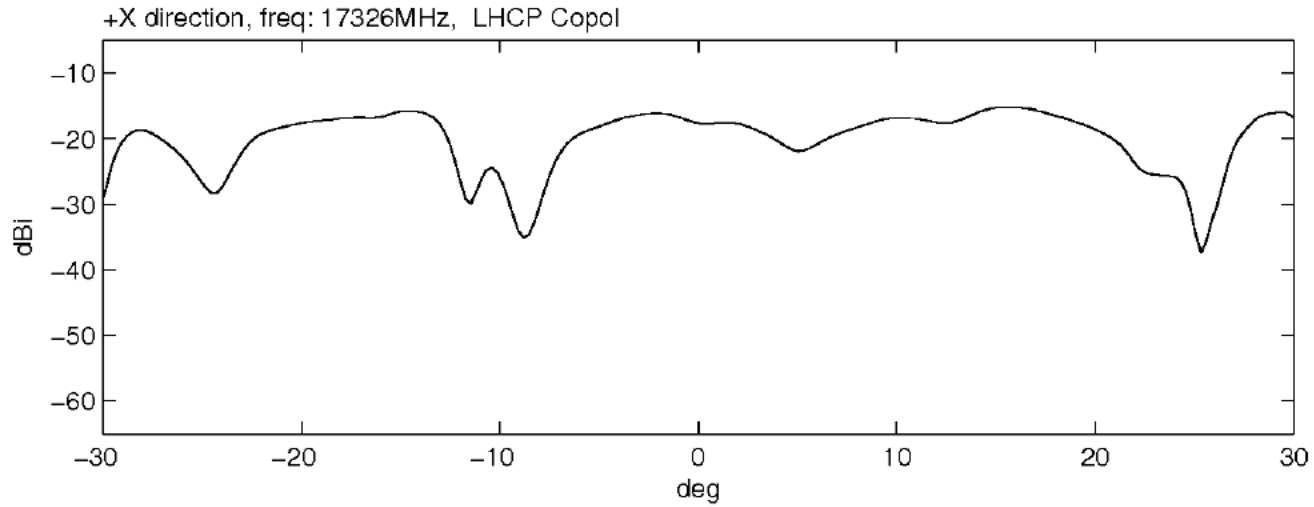

XZ-Plane, Yaw = 30 deg -x direction, Freq: 17326 MHz RHCP

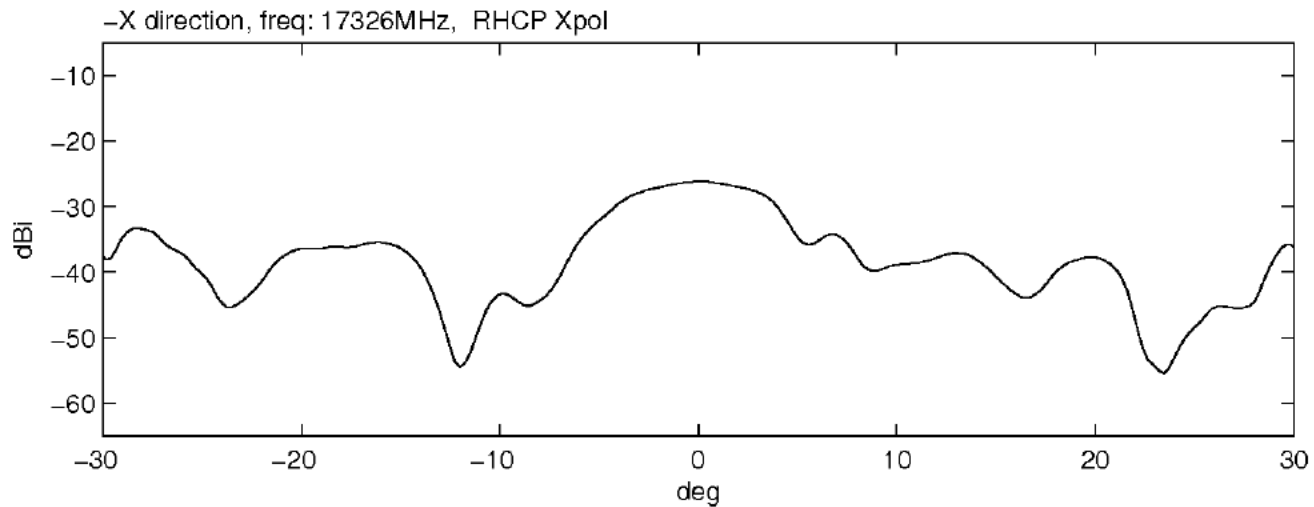
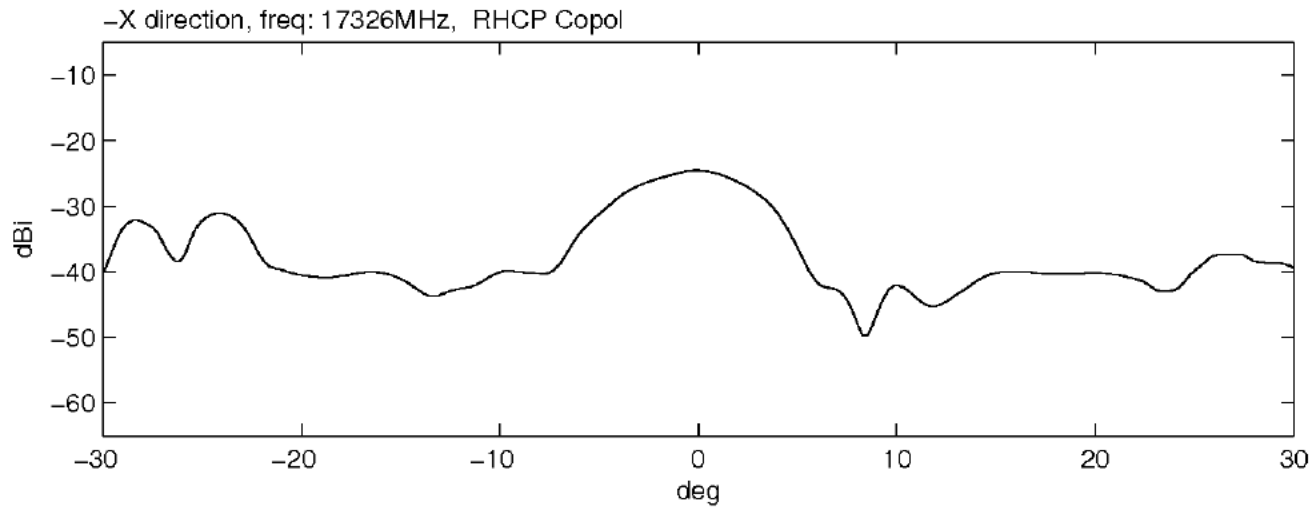

XZ-Plane, Yaw = 30 deg -x direction, Freq: 17326 MHz LHCP

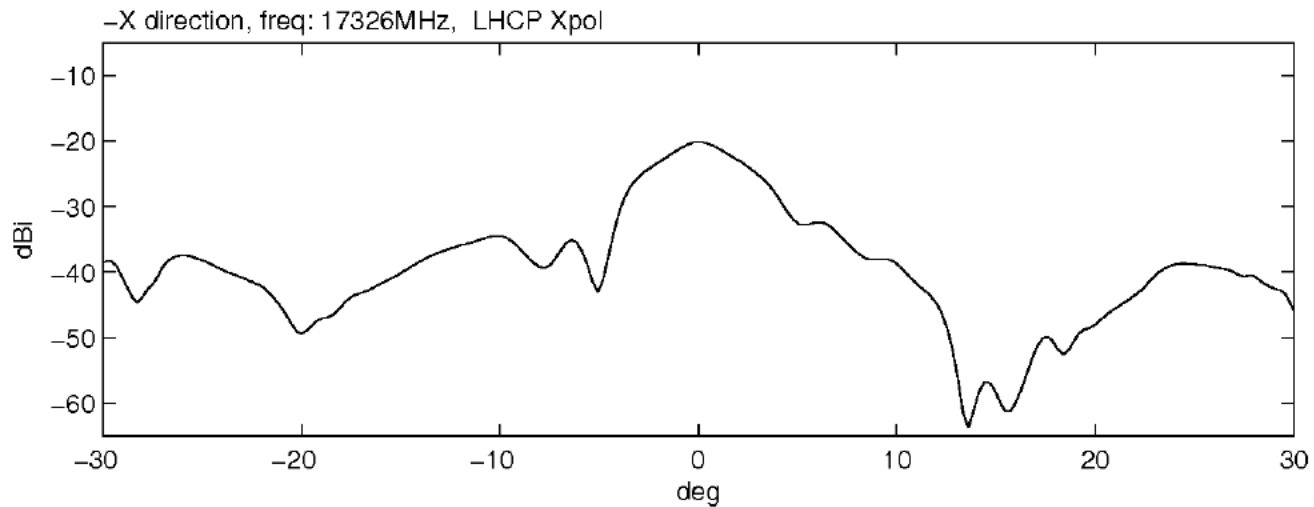
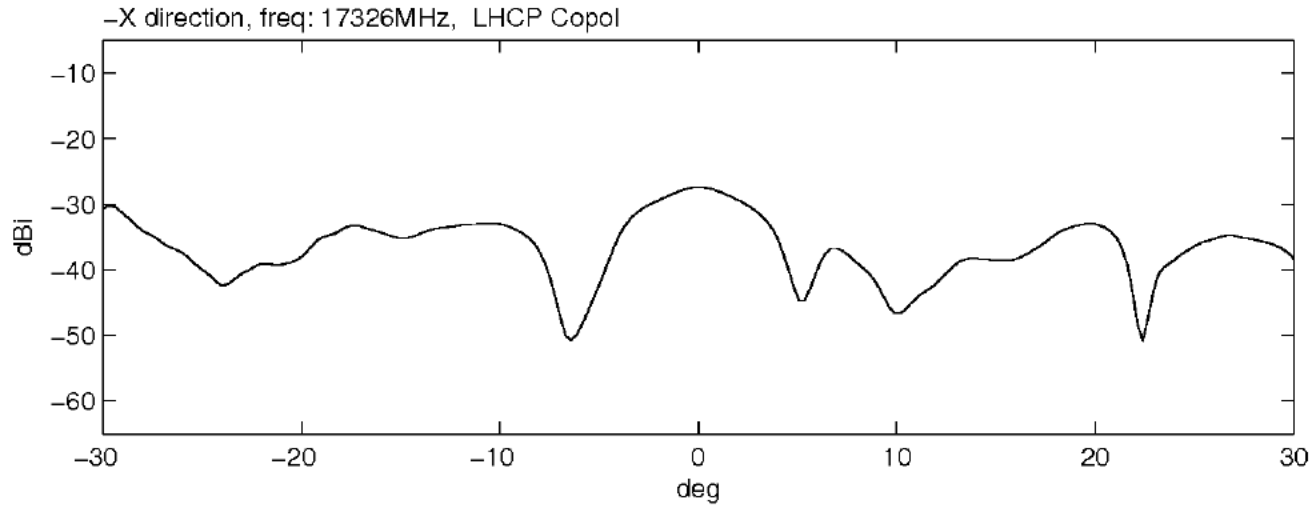

XZ-Plane, Yaw = 40 deg +x direction, Freq: 17326 MHz RHCP

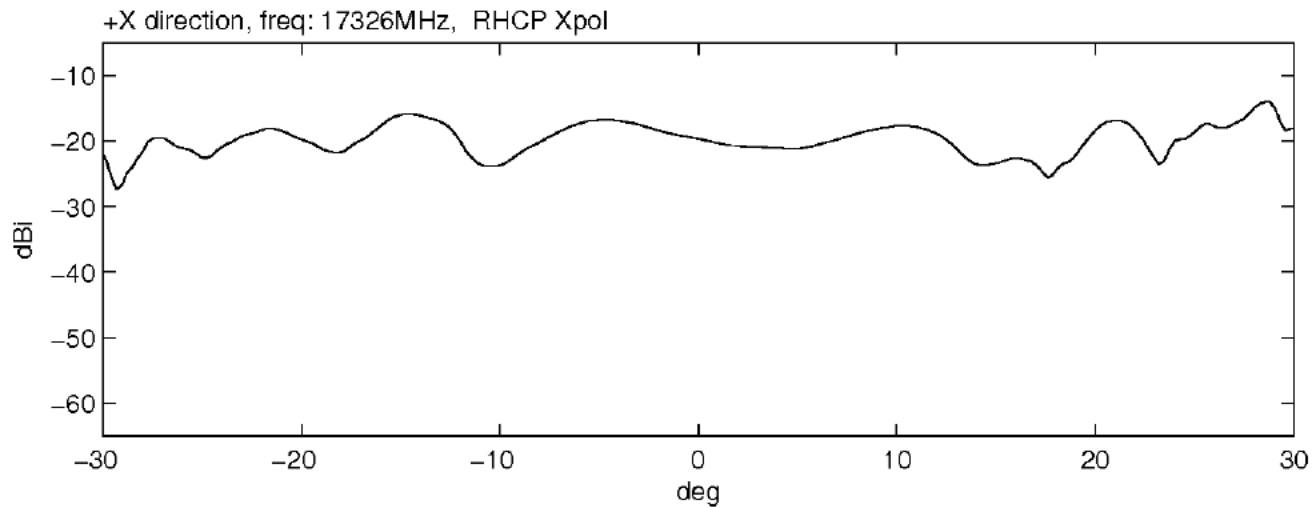
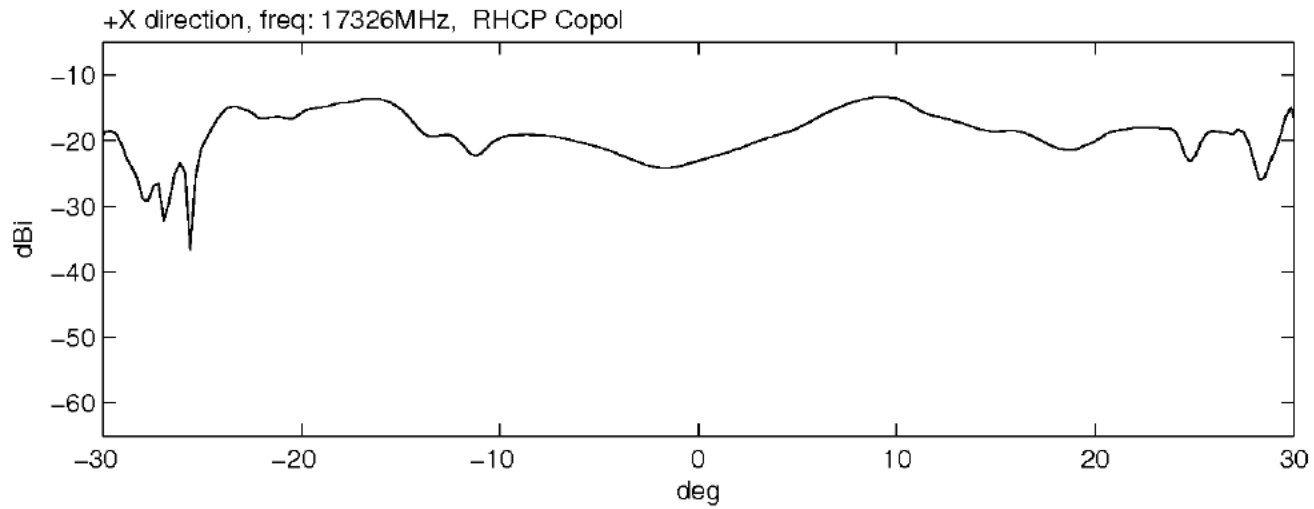

XZ-Plane, Yaw = 40 deg +x direction, Freq: 17326 MHz LHCP

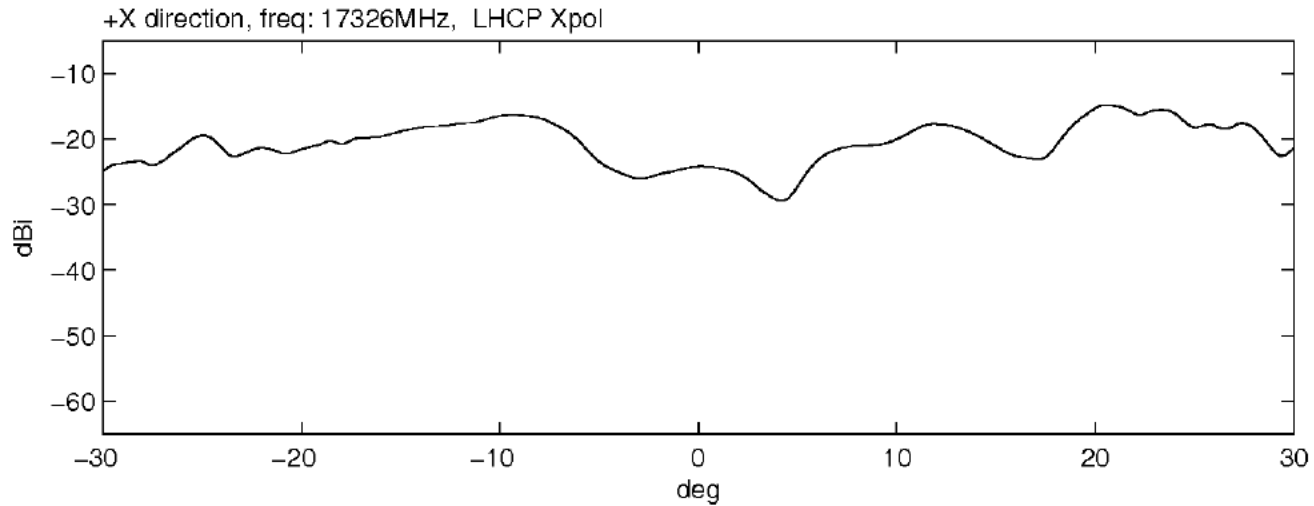
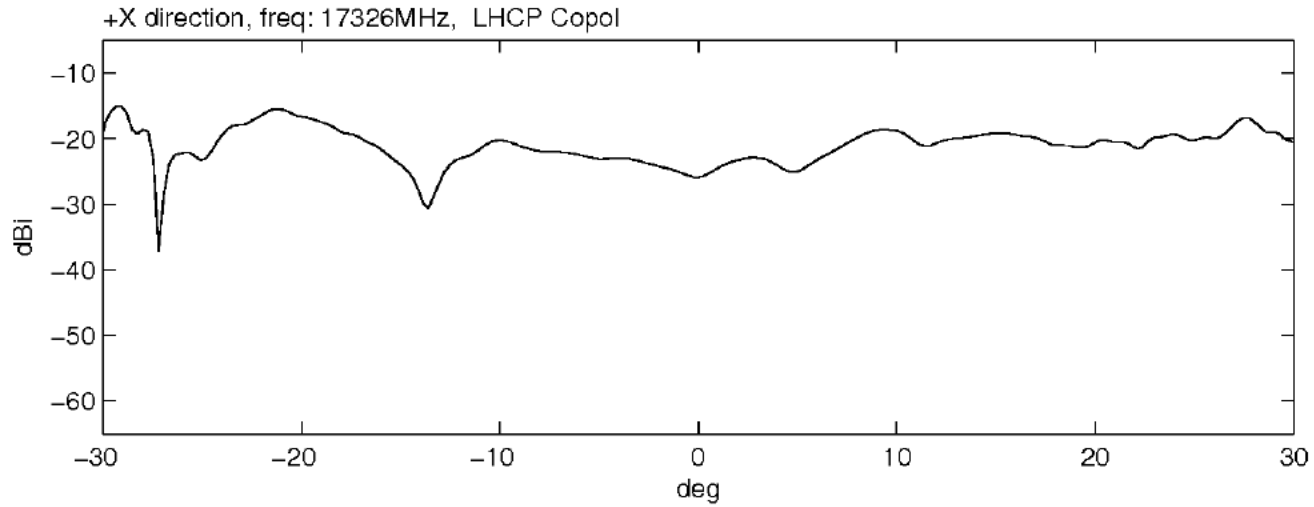

XZ-Plane, Yaw = 40 deg -x direction, Freq: 17326 MHz RHCP

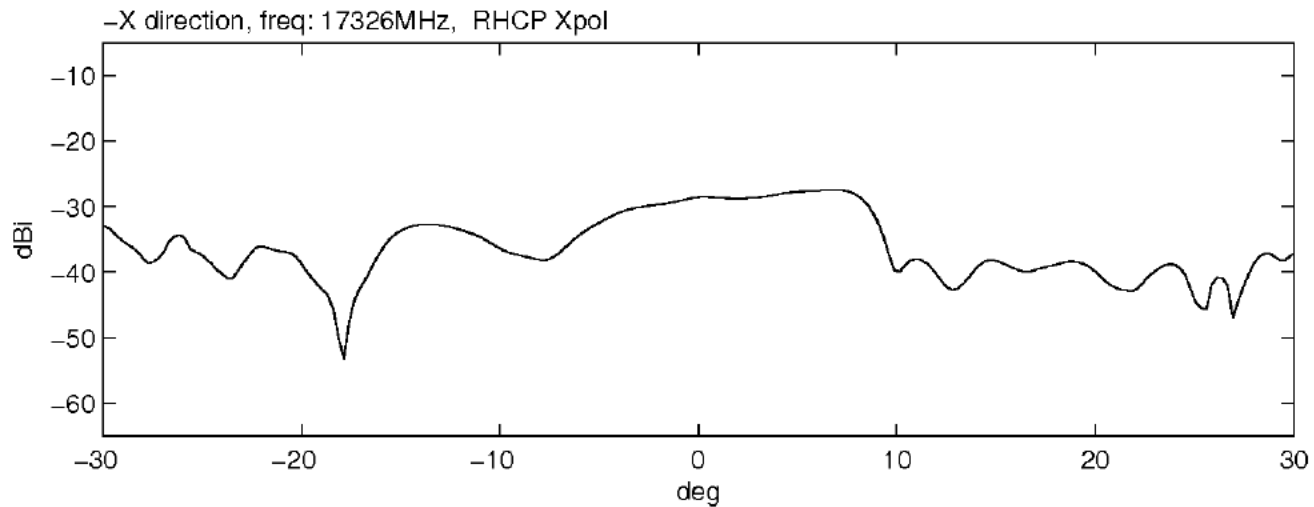
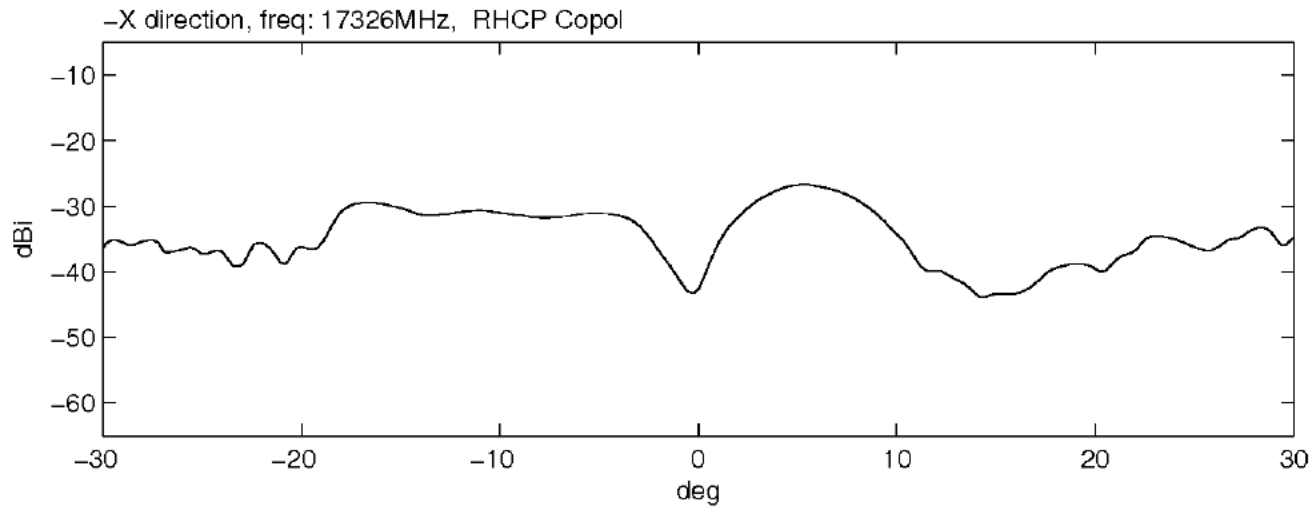

XZ-Plane, Yaw = 40 deg -x direction, Freq: 17326 MHz LHCP

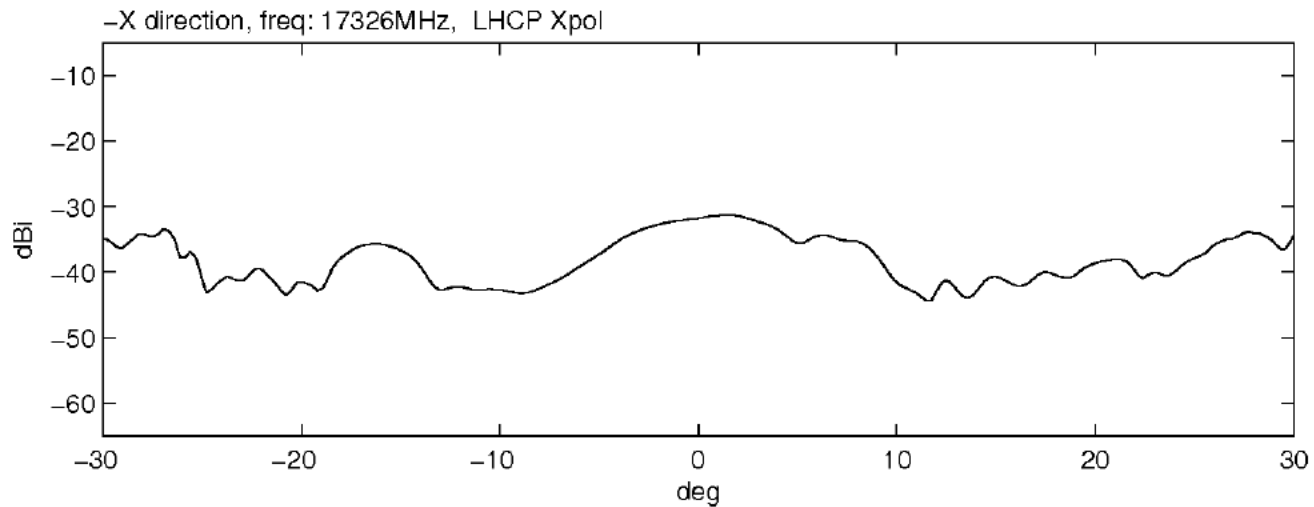
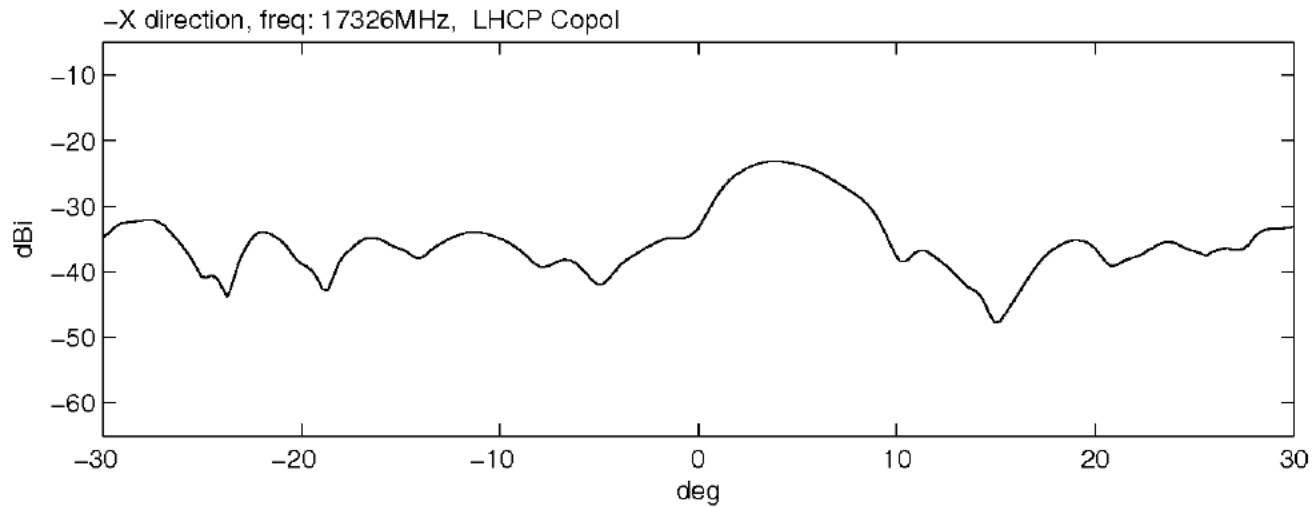

XZ-Plane, Yaw = 50 deg +x direction, Freq: 17326 MHz RHCP

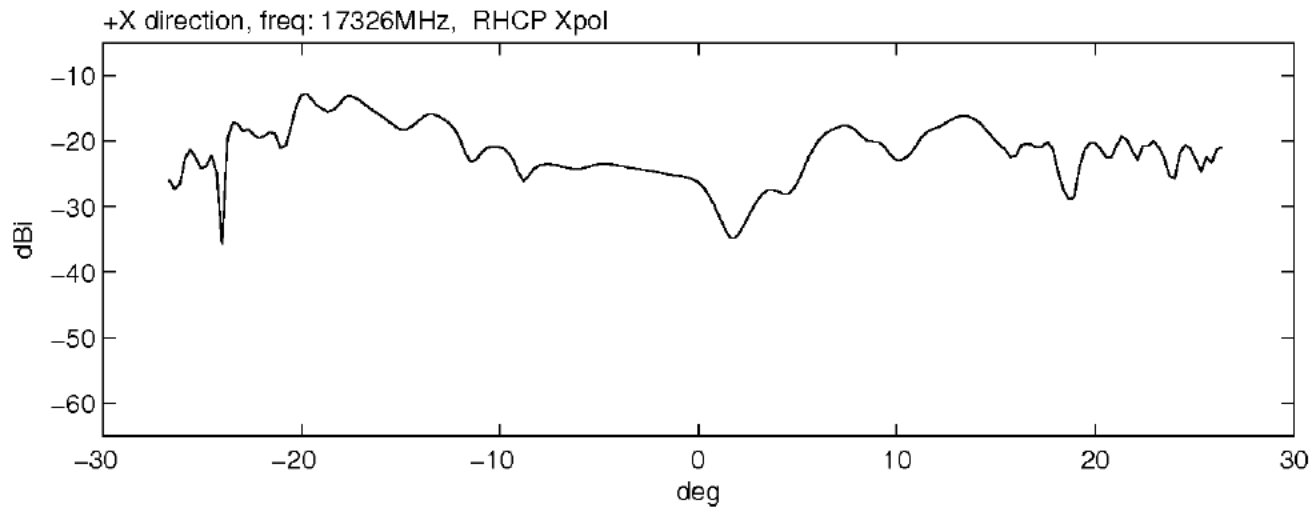
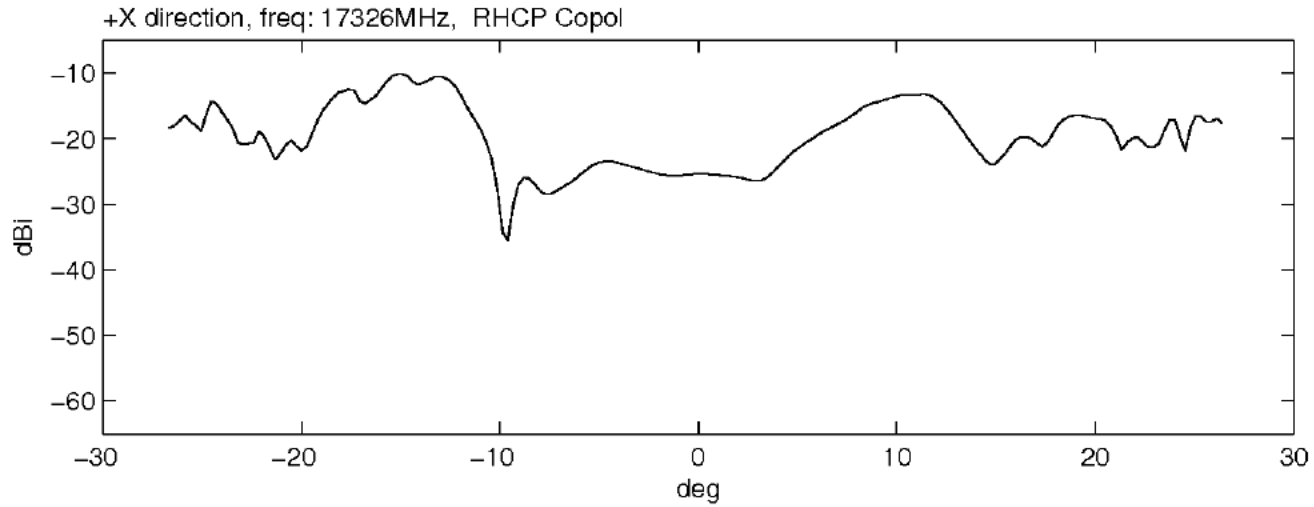

XZ-Plane, Yaw = 50 deg +x direction, Freq: 17326 MHz LHCP

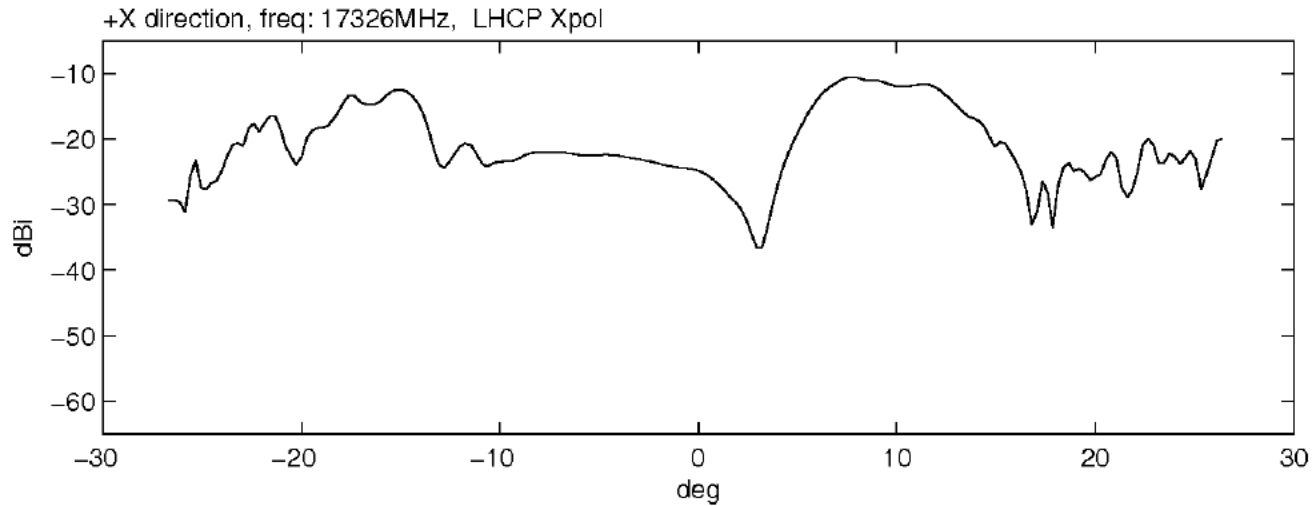
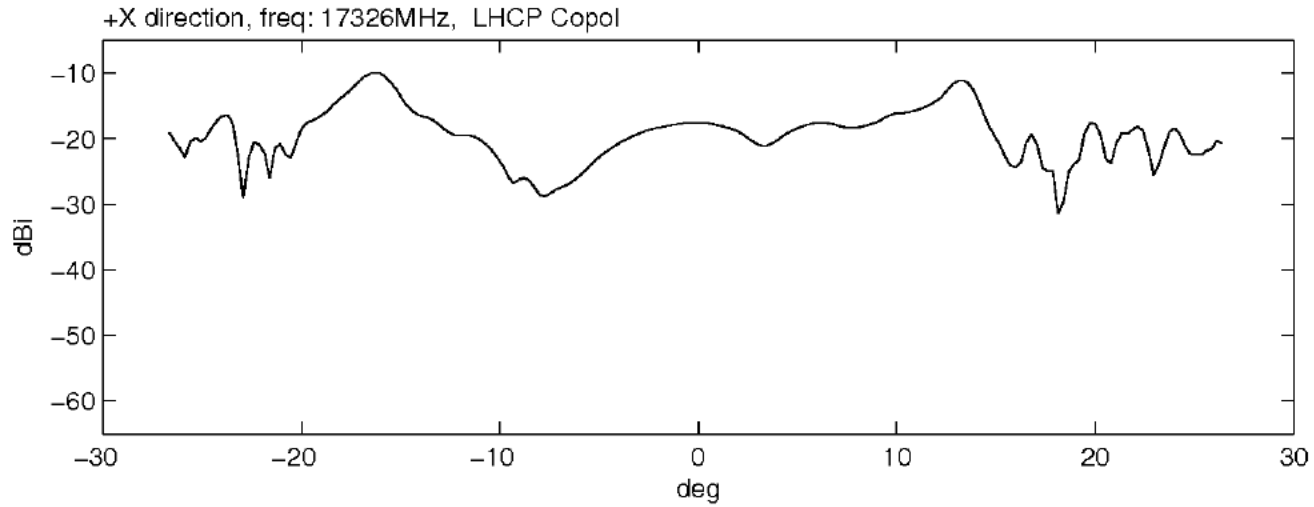

XZ-Plane, Yaw = 50 deg -x direction, Freq: 17326 MHz RHCP

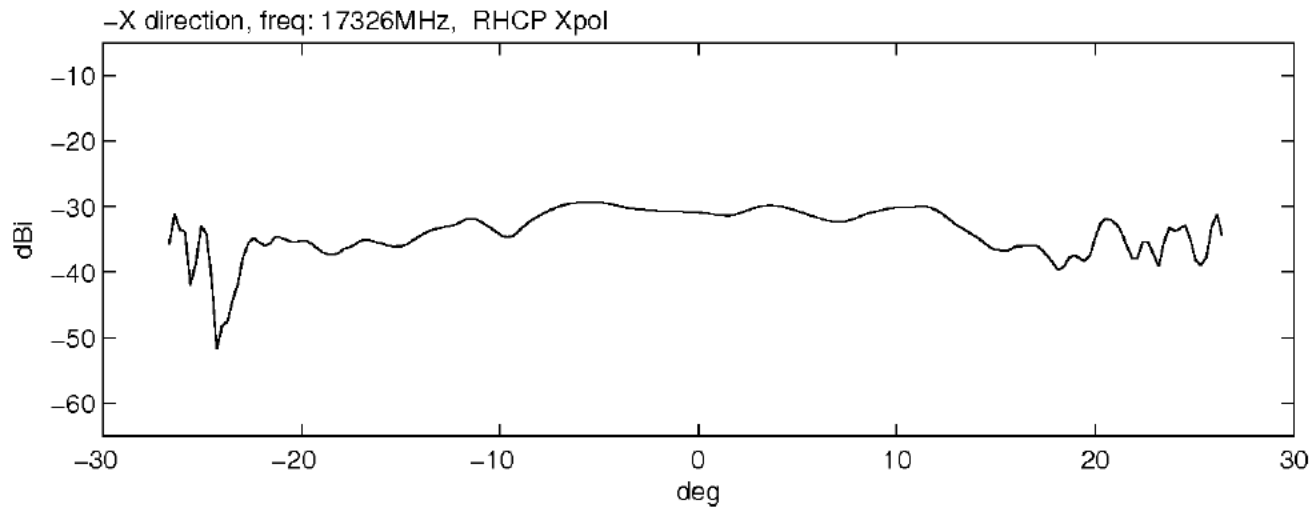
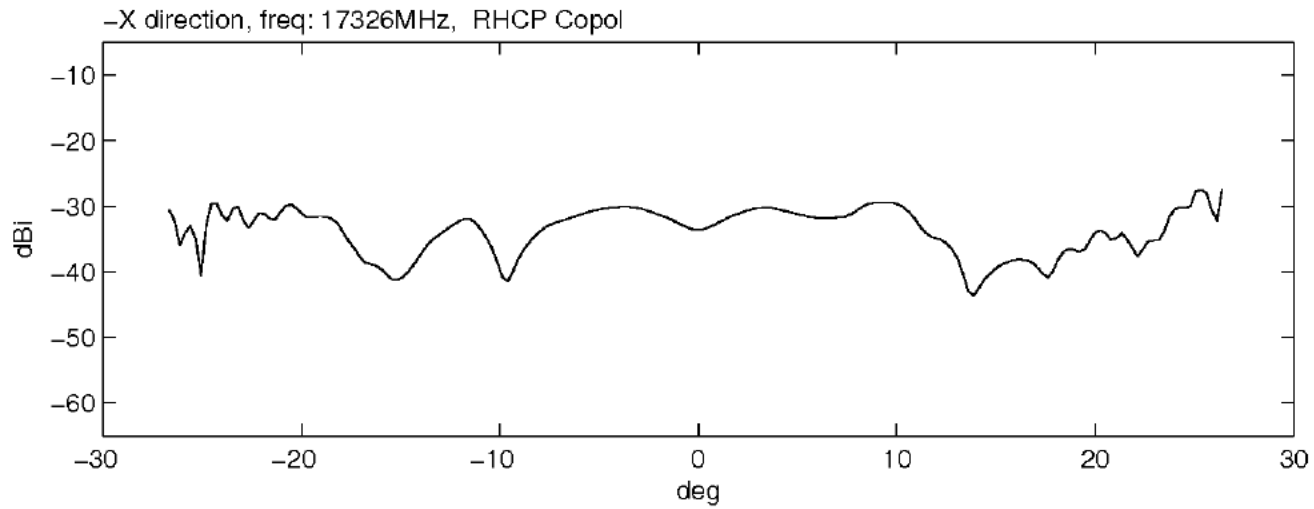

XZ-Plane, Yaw = 50 deg -x direction, Freq: 17326 MHz LHCP

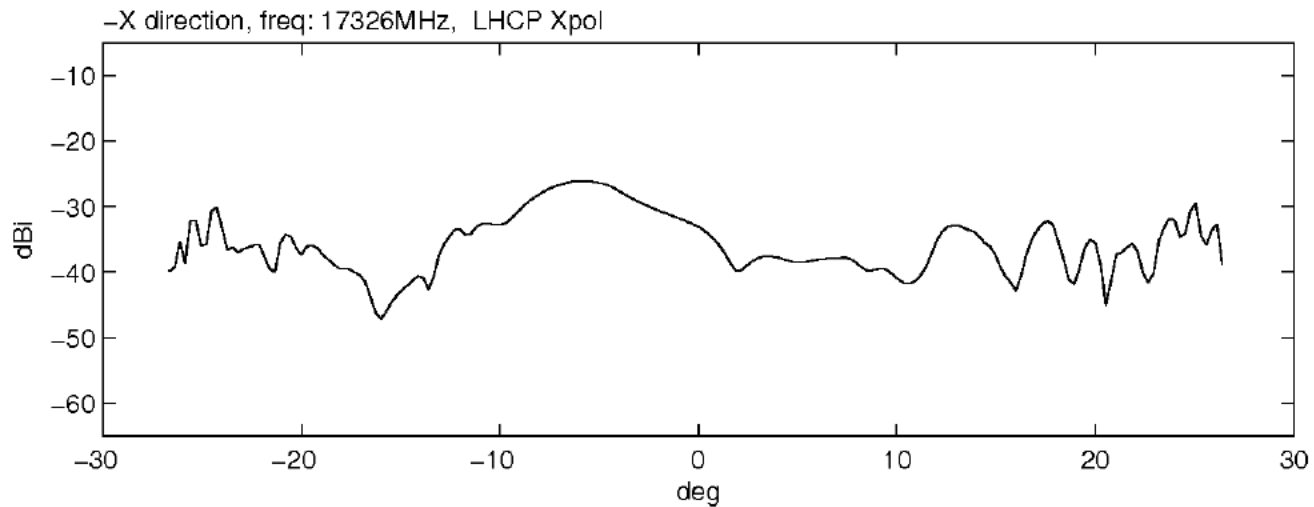
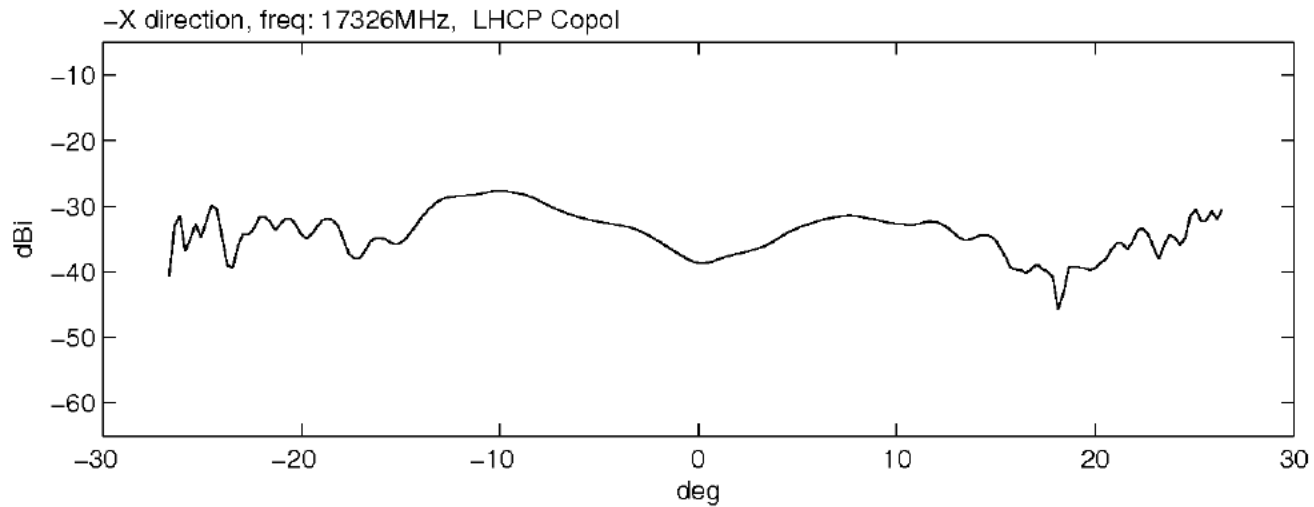

XZ-Plane, Yaw = -10 deg +x direction, Freq: 17326 MHz RHCP

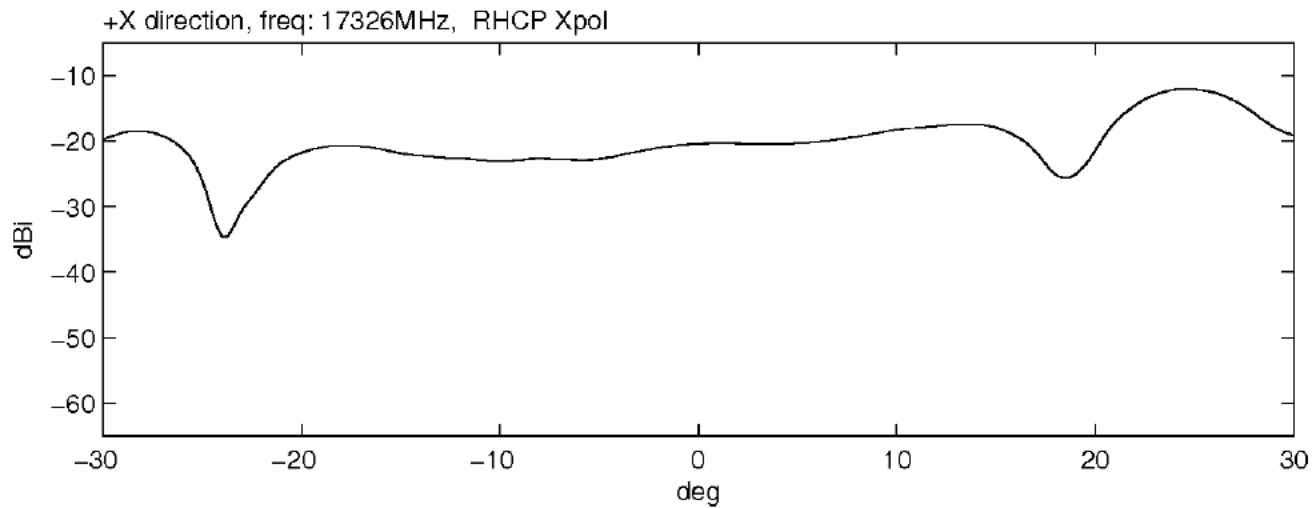
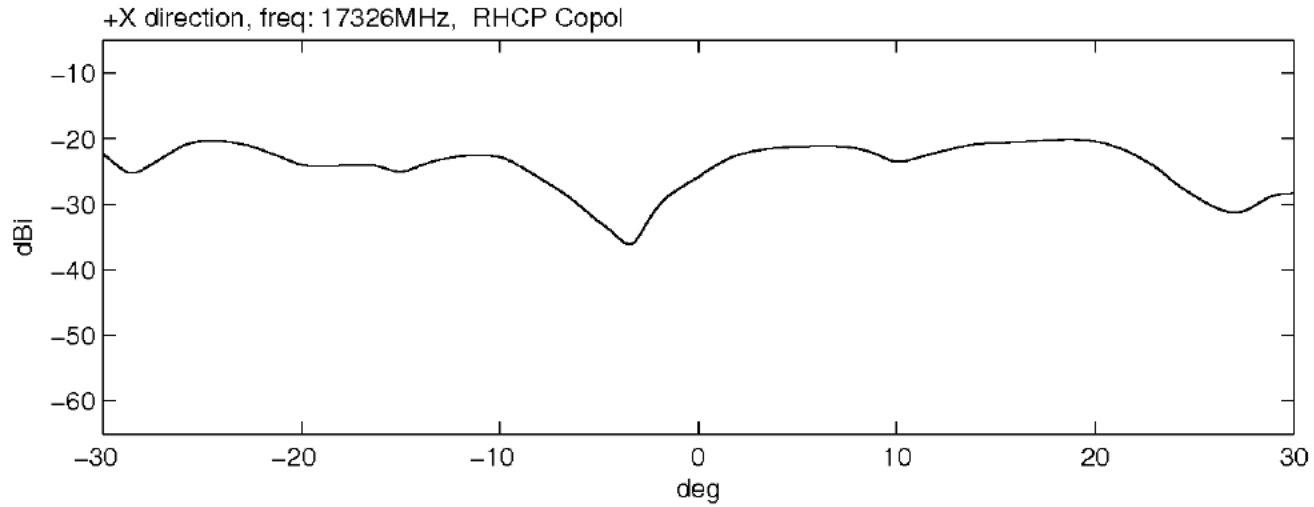

XZ-Plane, Yaw = -10 deg +x direction, Freq: 17326 MHz LHCP

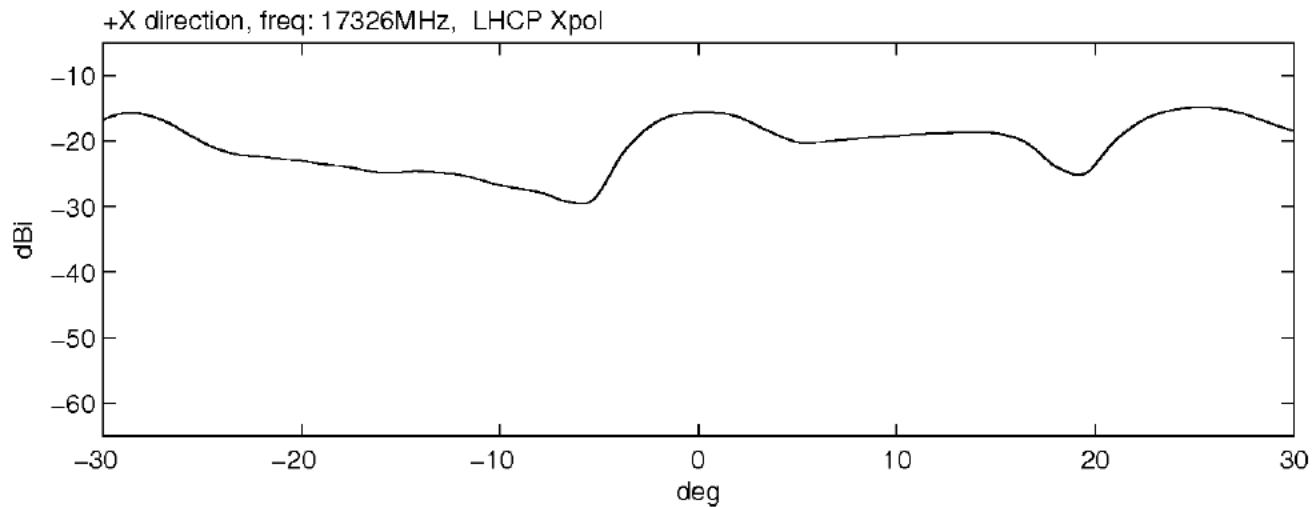
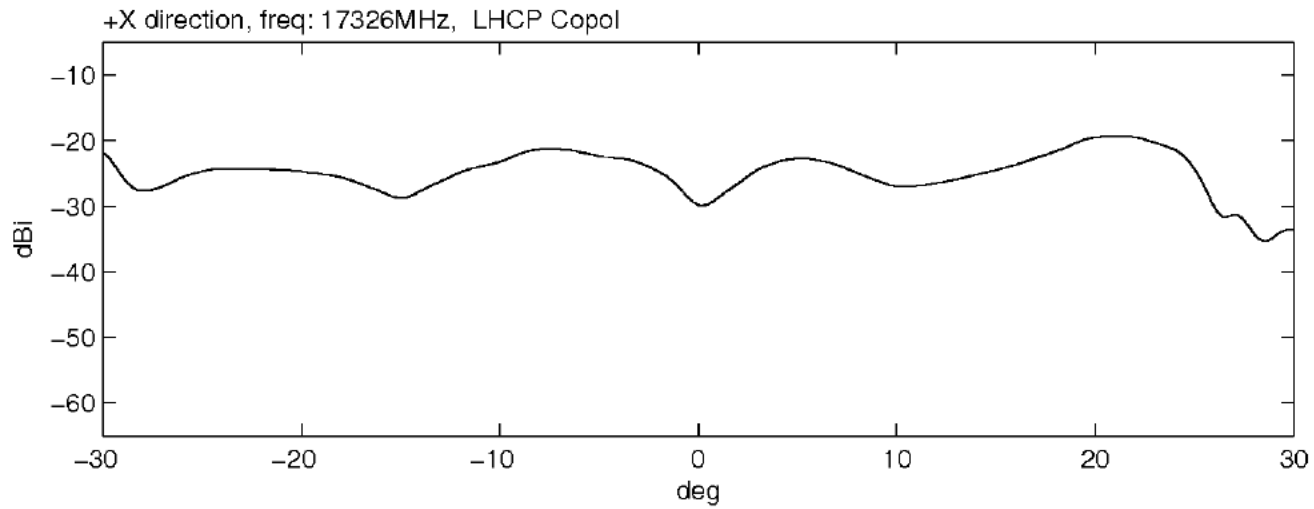

XZ-Plane, Yaw = -10 deg -x direction, Freq: 17326 MHz RHCP

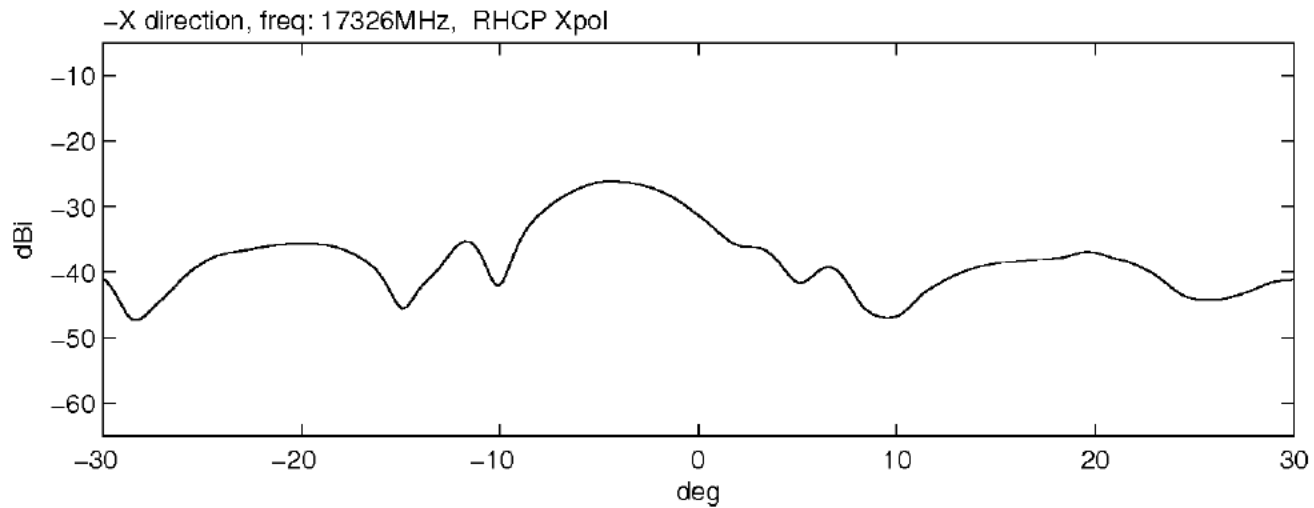
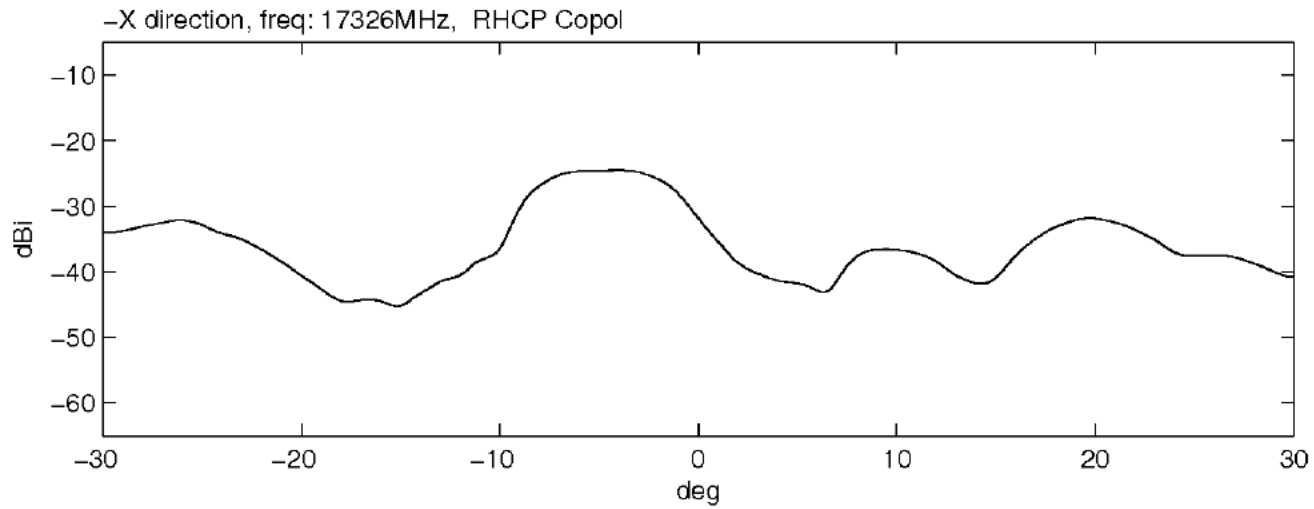

XZ-Plane, Yaw = -10 deg -x direction, Freq: 17326 MHz LHCP

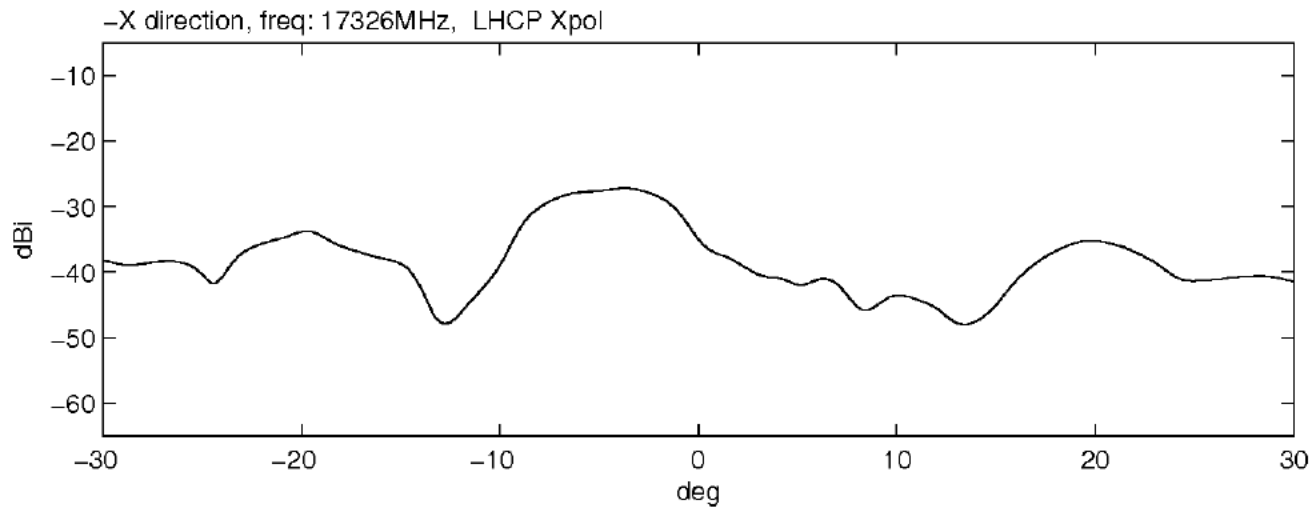
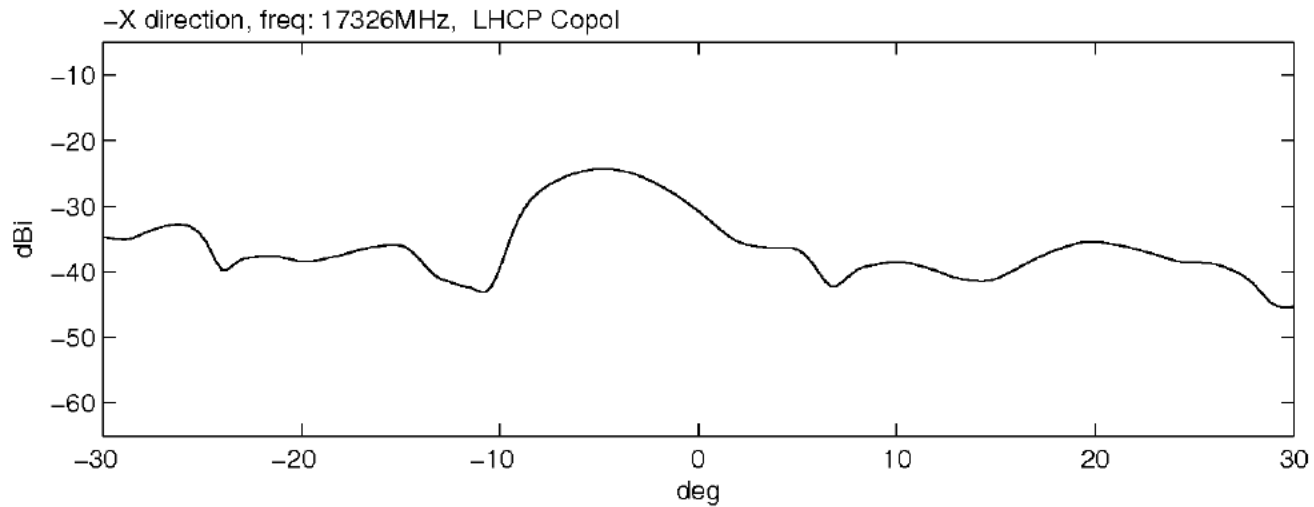

XZ-Plane, Yaw = -20 deg +x direction, Freq: 17326 MHz RHCP

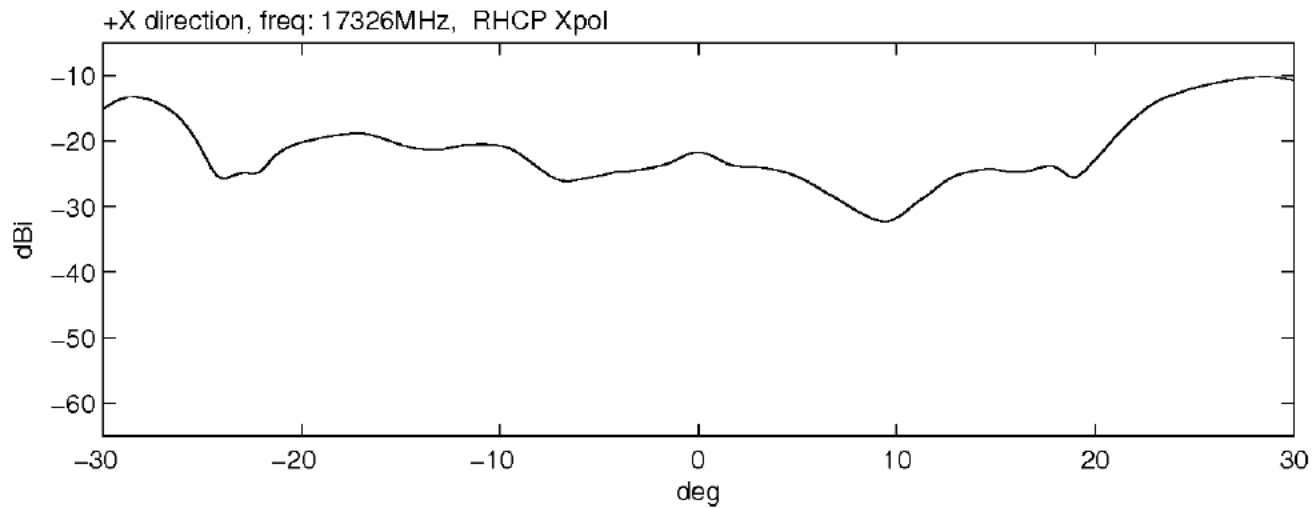
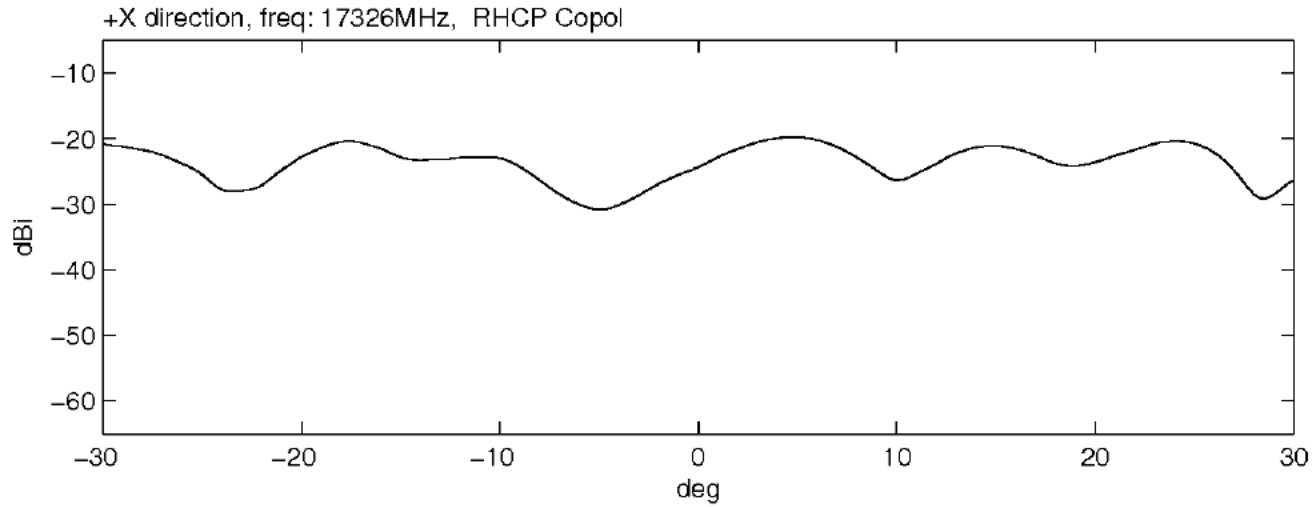

XZ-Plane, Yaw = -20 deg +x direction, Freq: 17326 MHz LHCP

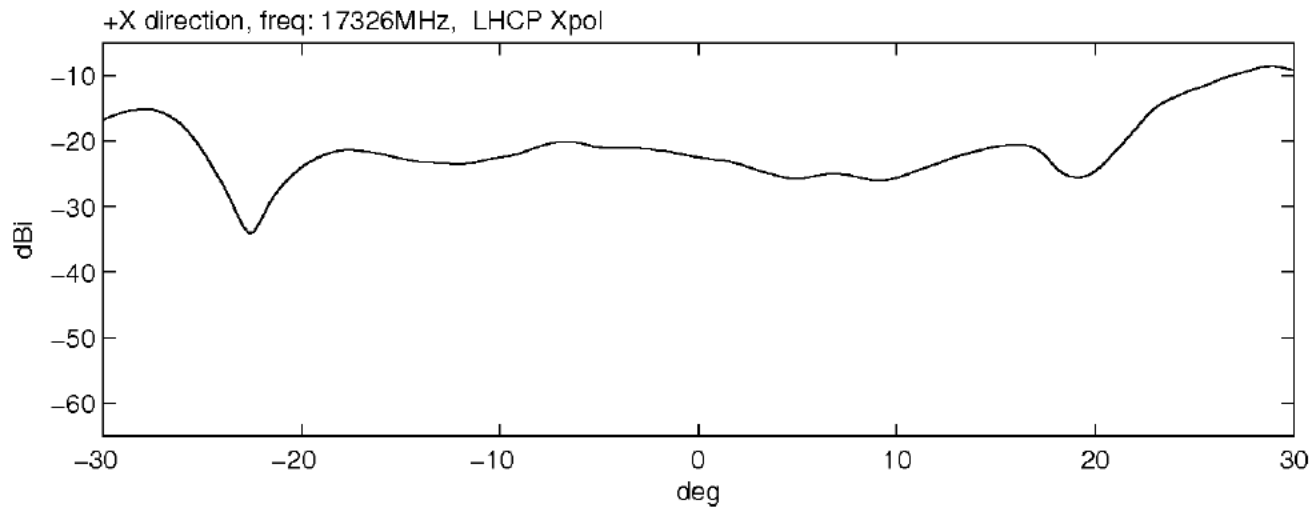
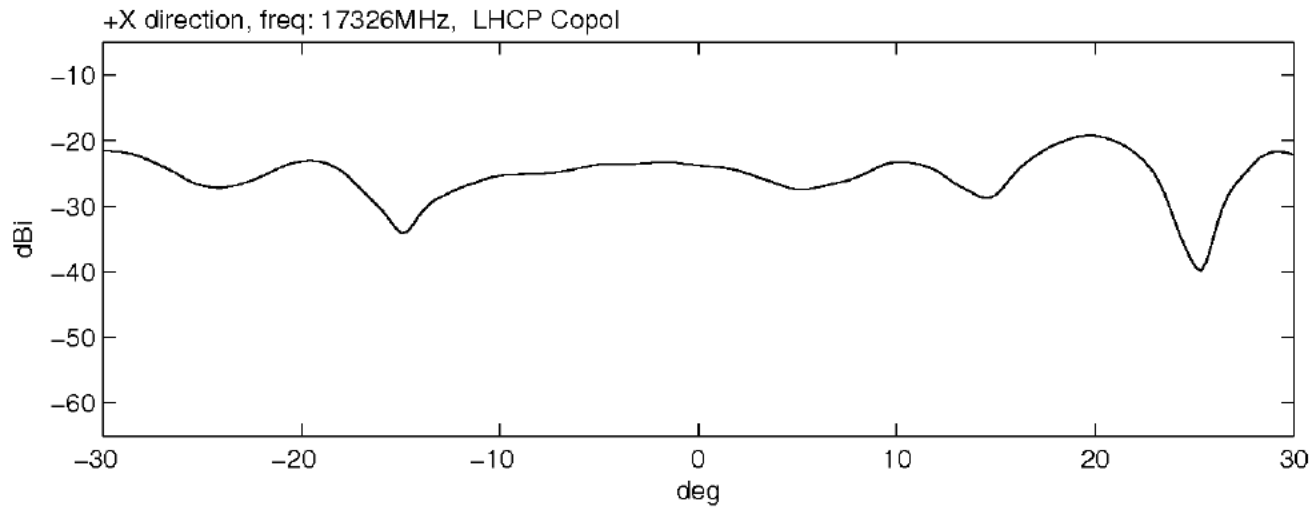

XZ-Plane, Yaw = -20 deg -x direction, Freq: 17326 MHz RHCP

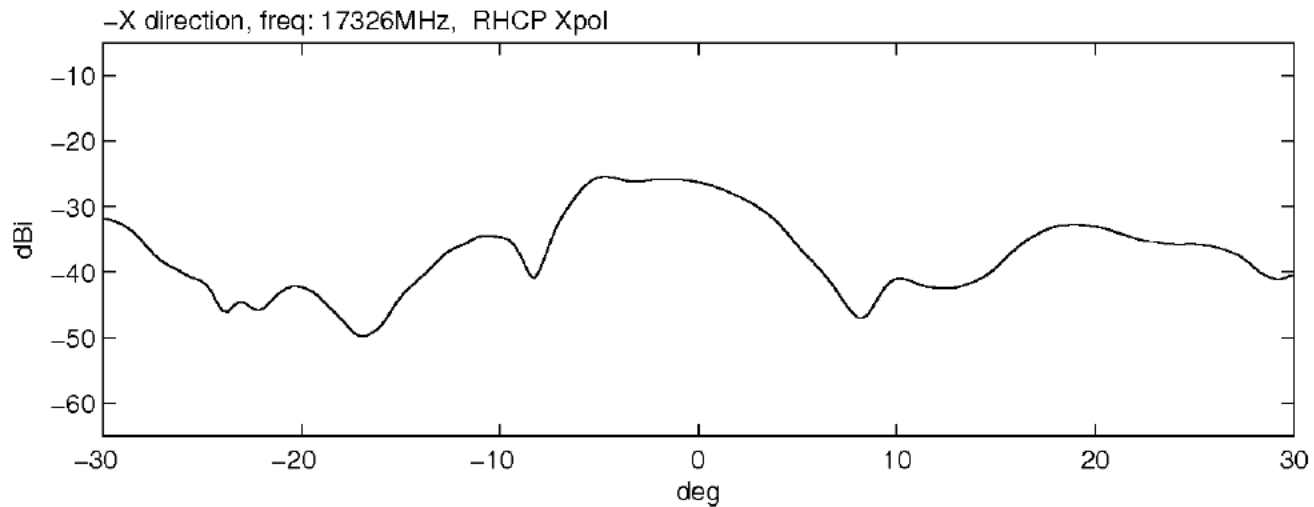
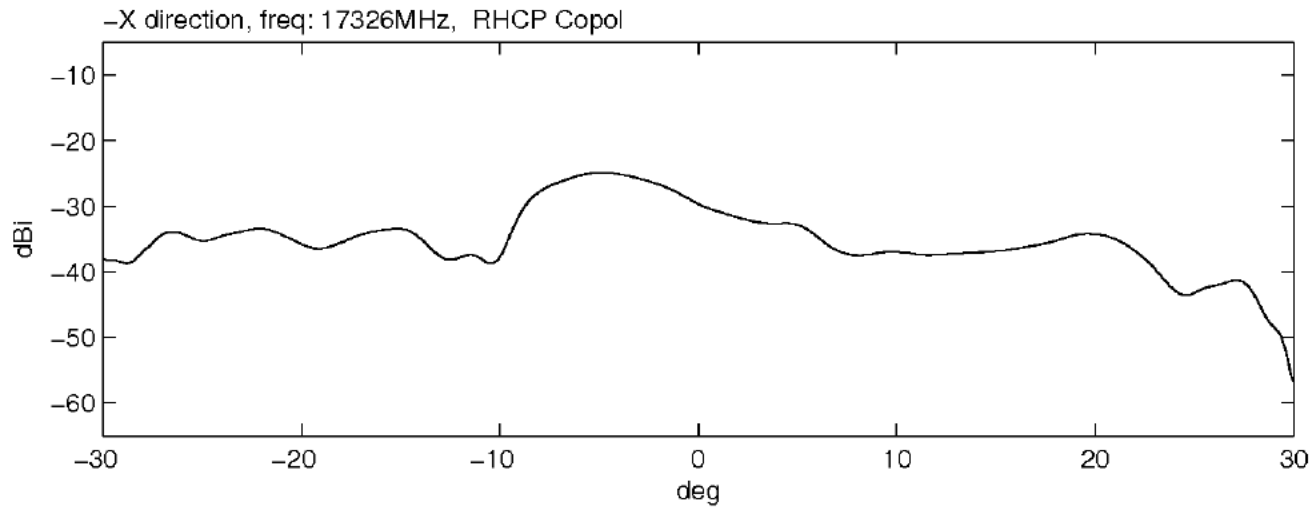

XZ-Plane, Yaw = -20 deg -x direction, Freq: 17326 MHz LHCP

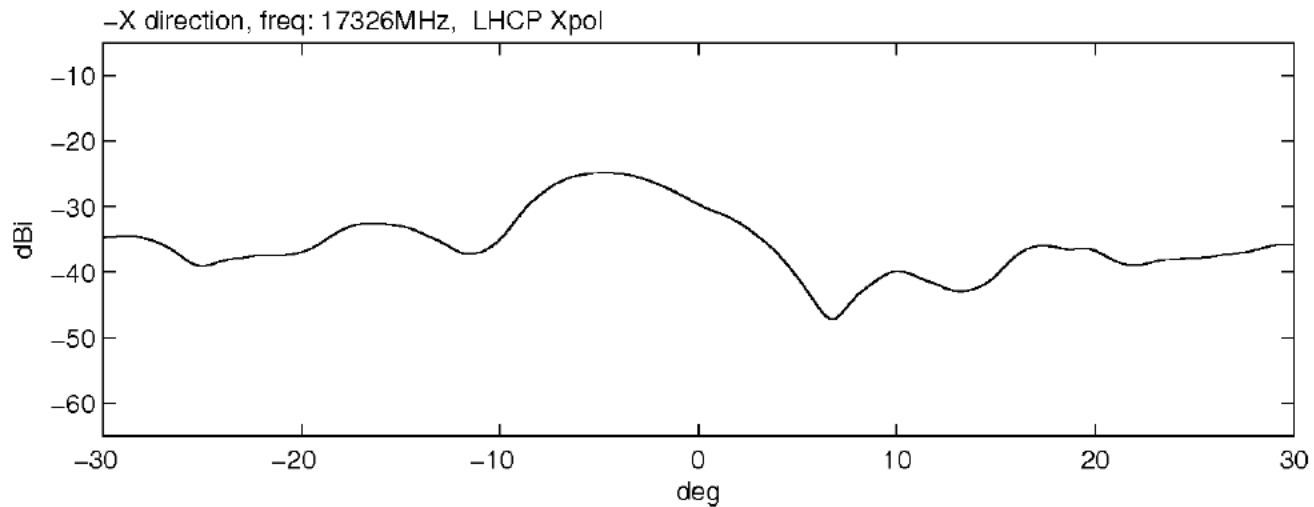
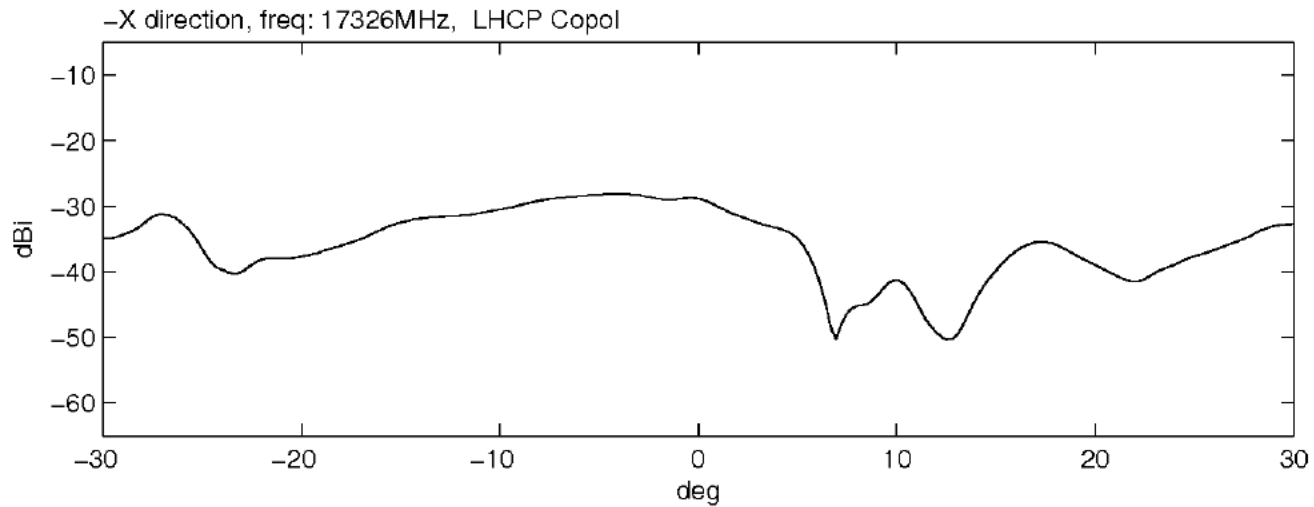

XZ-Plane, Yaw = -30 deg +x direction, Freq: 17326 MHz RHCP

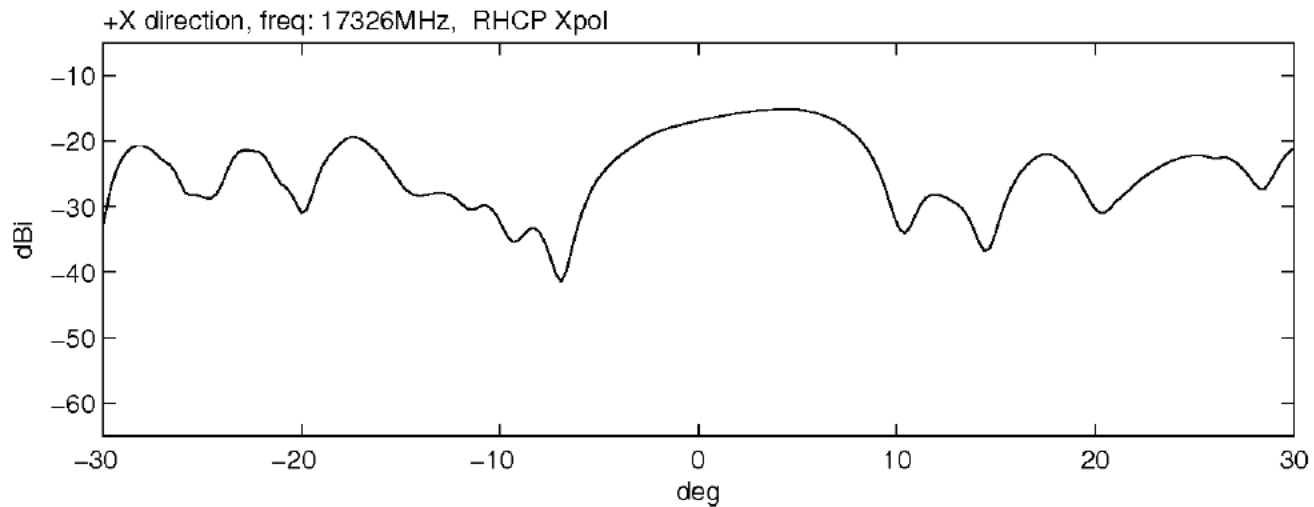
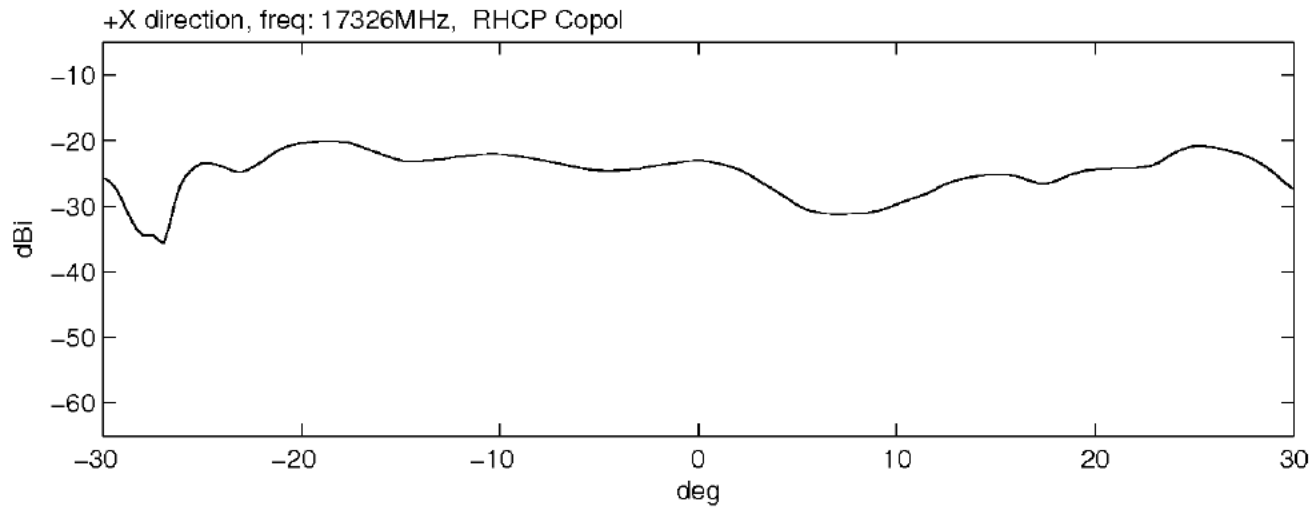

XZ-Plane, Yaw = -30 deg +x direction, Freq: 17326 MHz LHCP

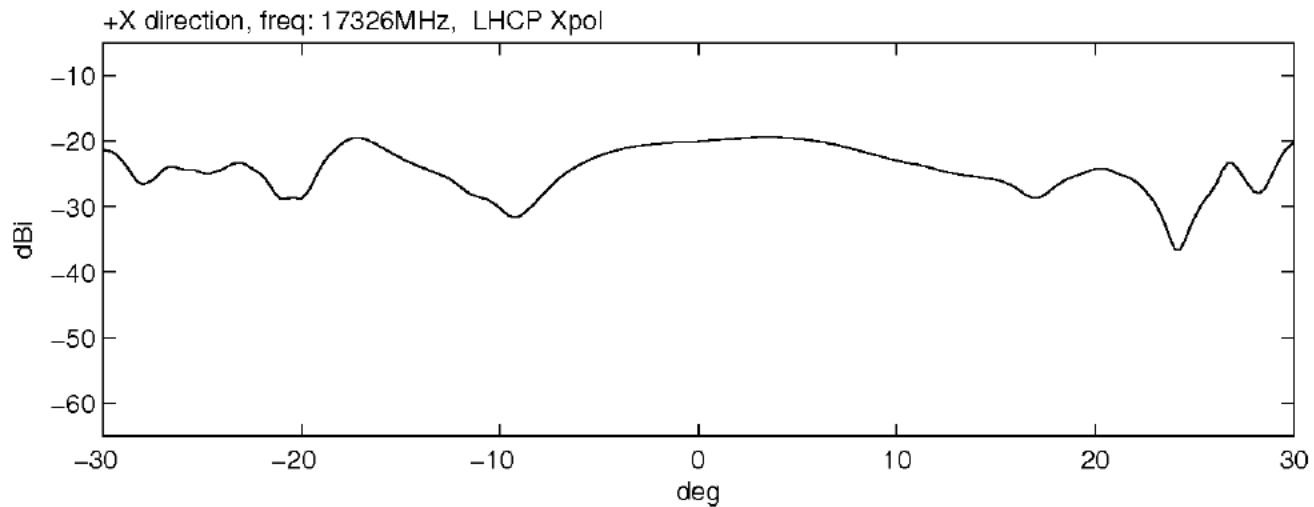
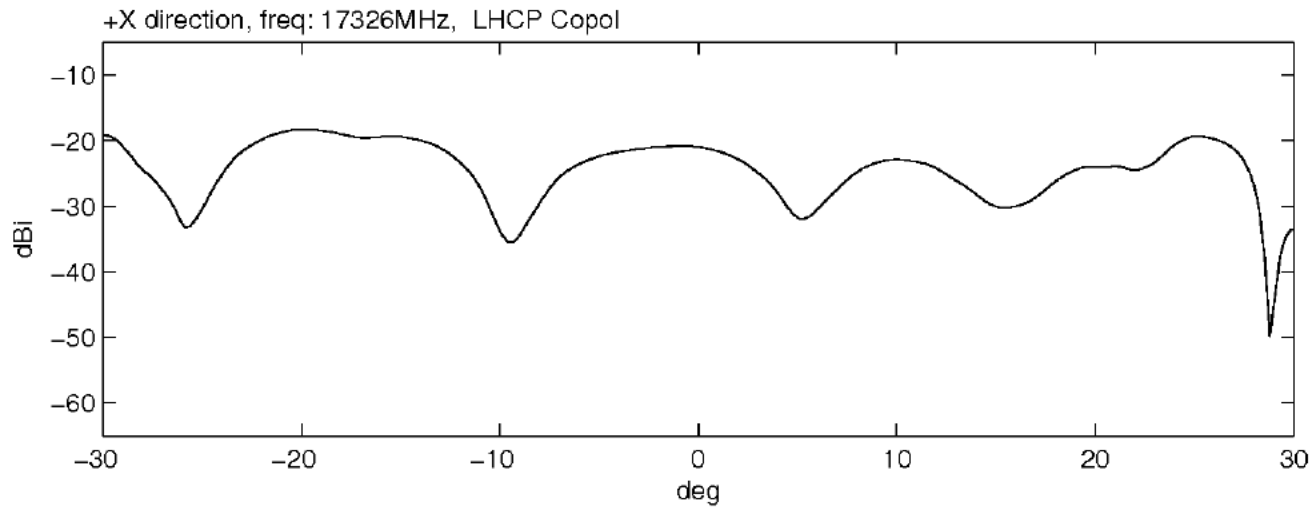

XZ-Plane, Yaw = -30 deg -x direction, Freq: 17326 MHz RHCP

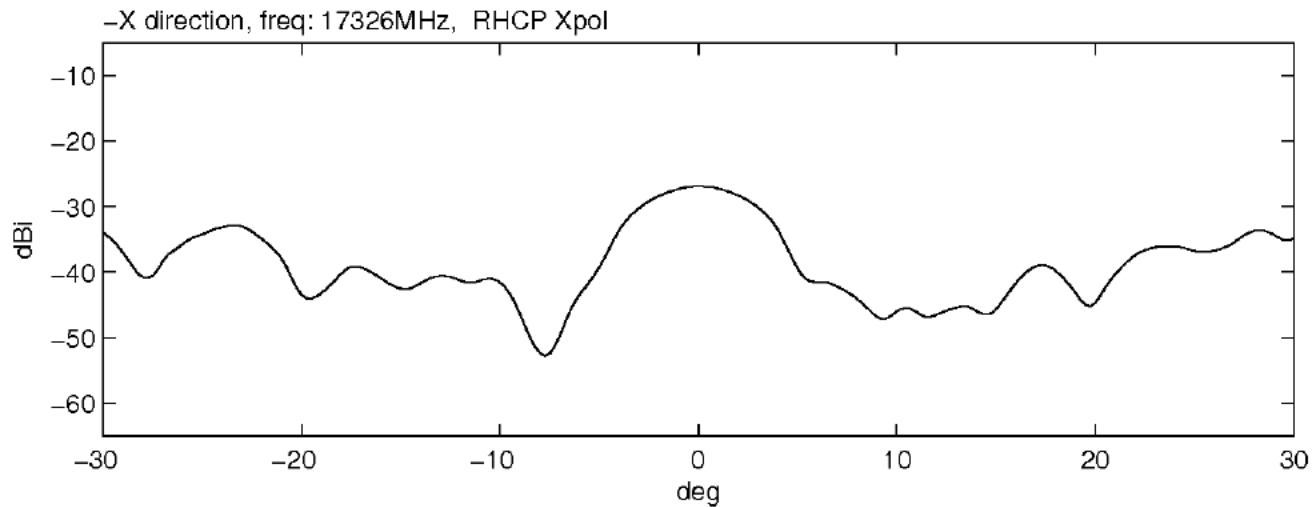
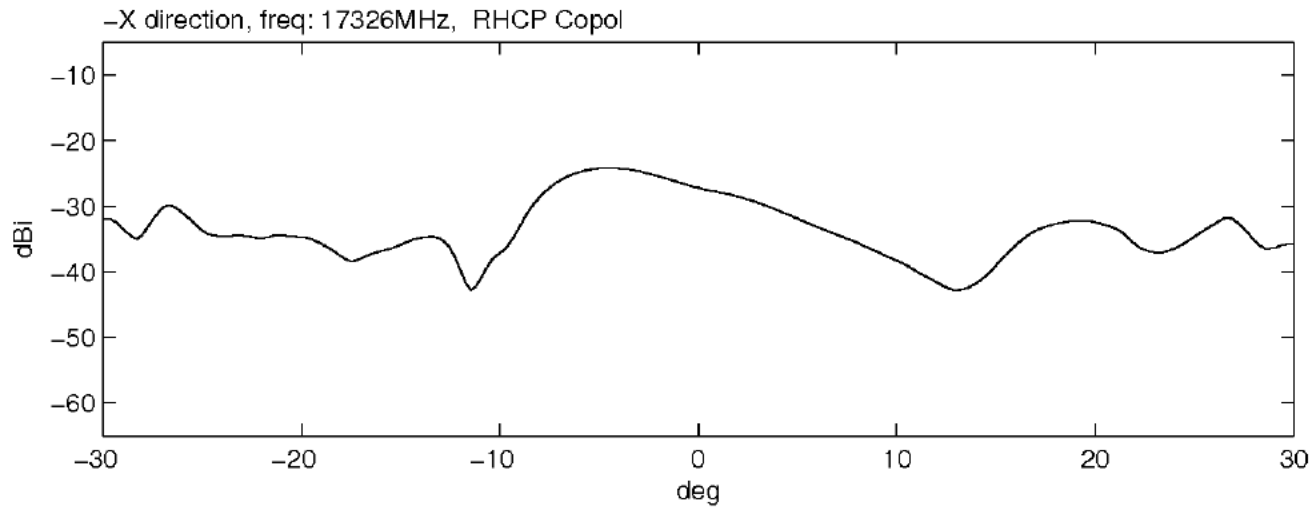

XZ-Plane, Yaw = -30 deg -x direction, Freq: 17326 MHz LHCP

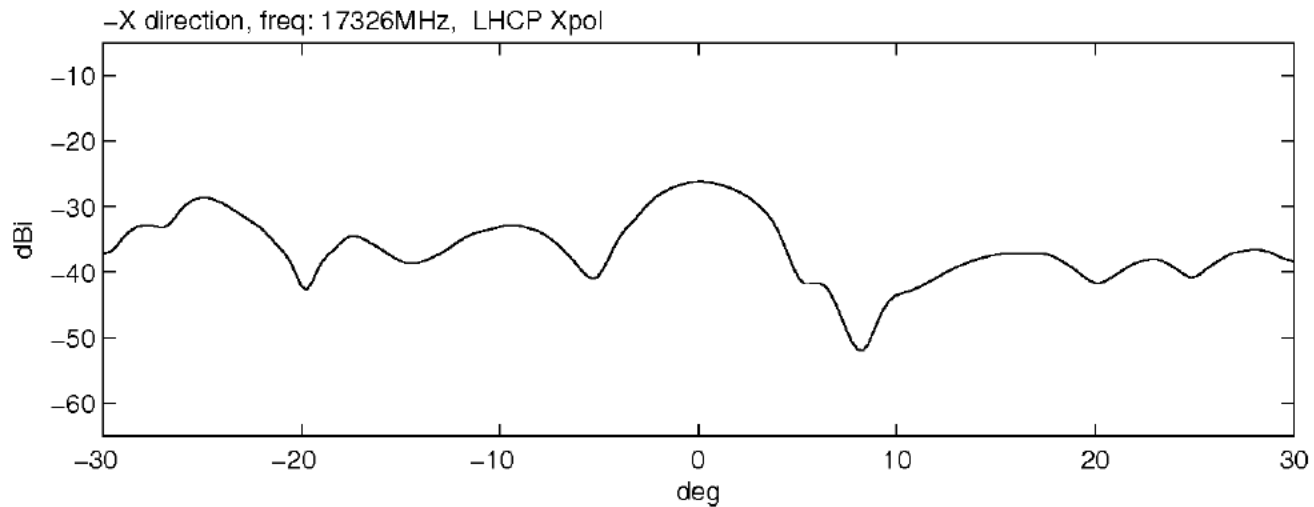
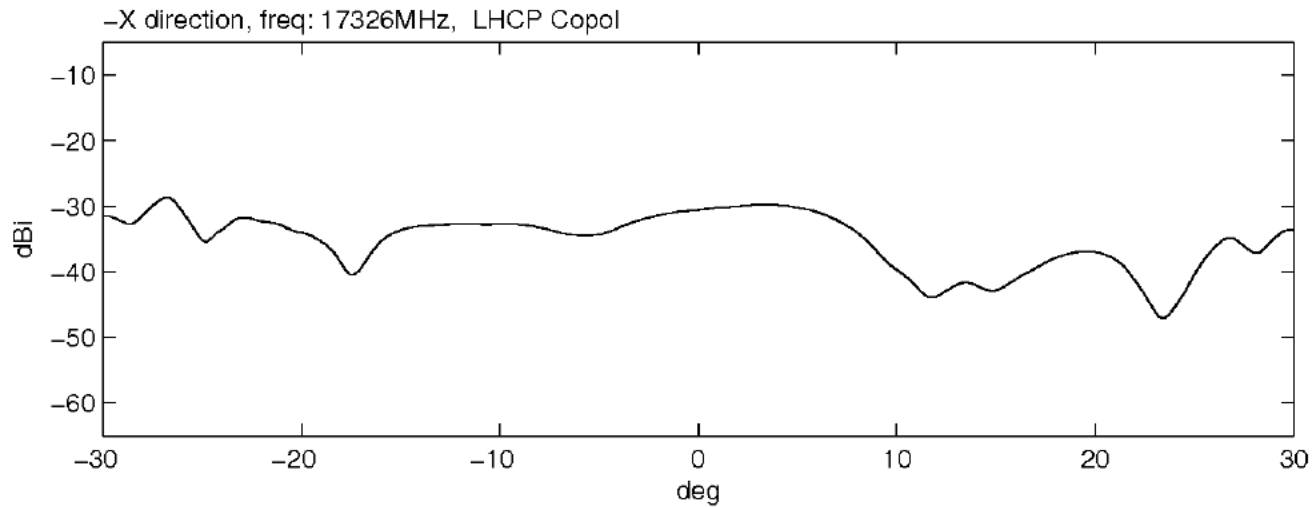

XZ-Plane, Yaw = -40 deg +x direction, Freq: 17326 MHz RHCP

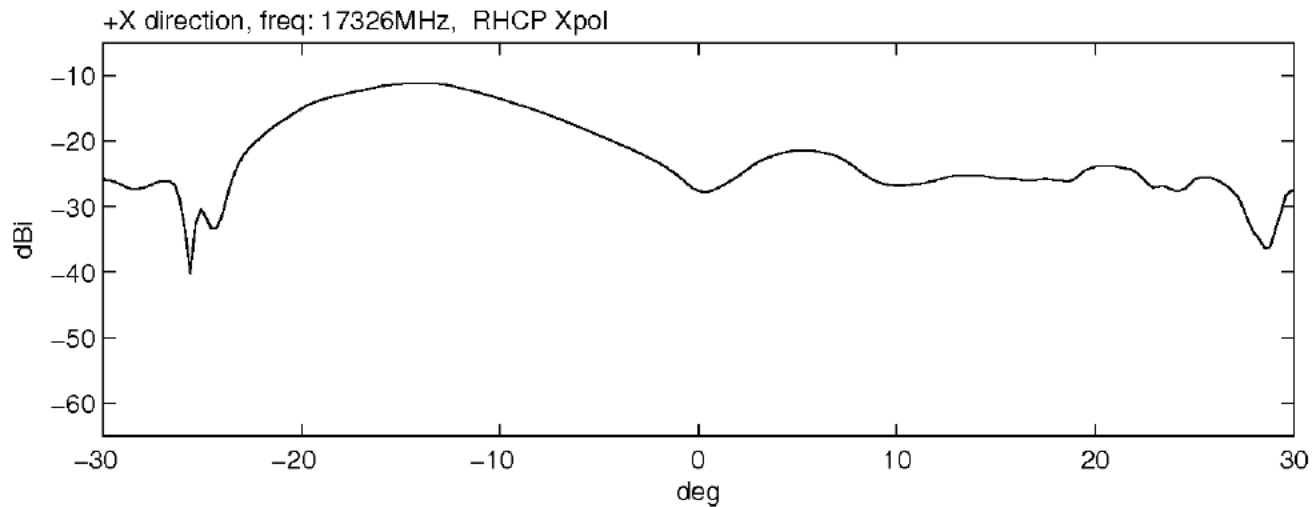
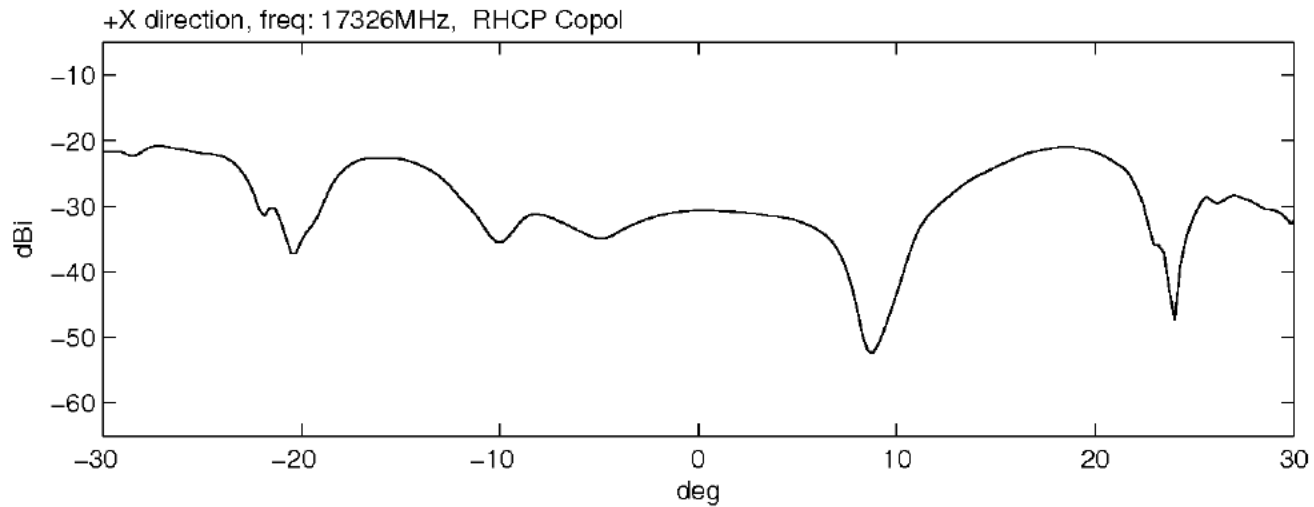

XZ-Plane, Yaw = -40 deg +x direction, Freq: 17326 MHz LHCP

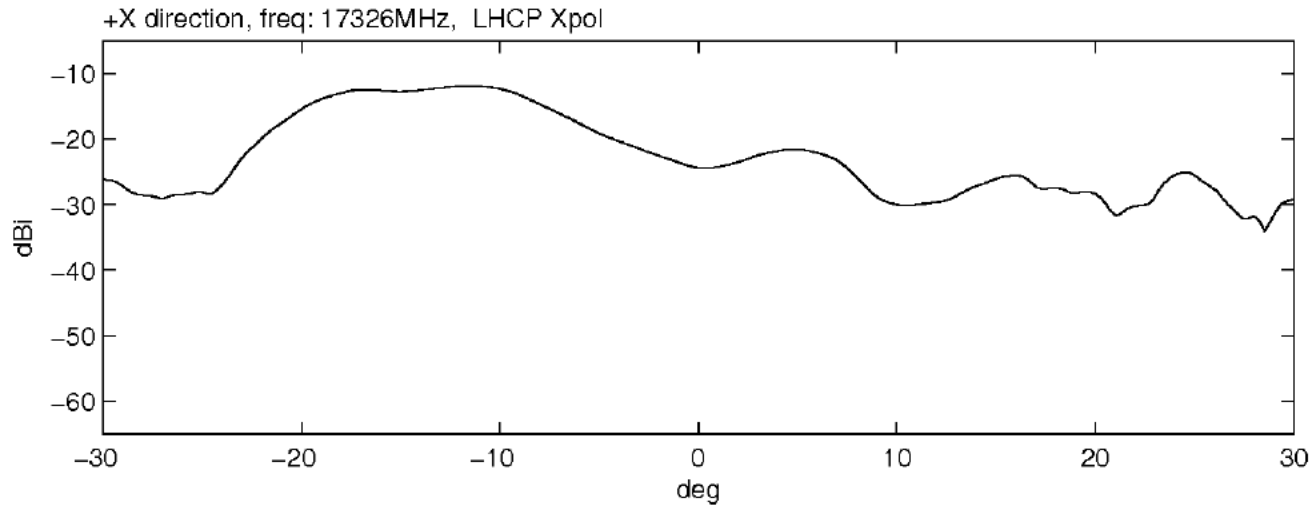
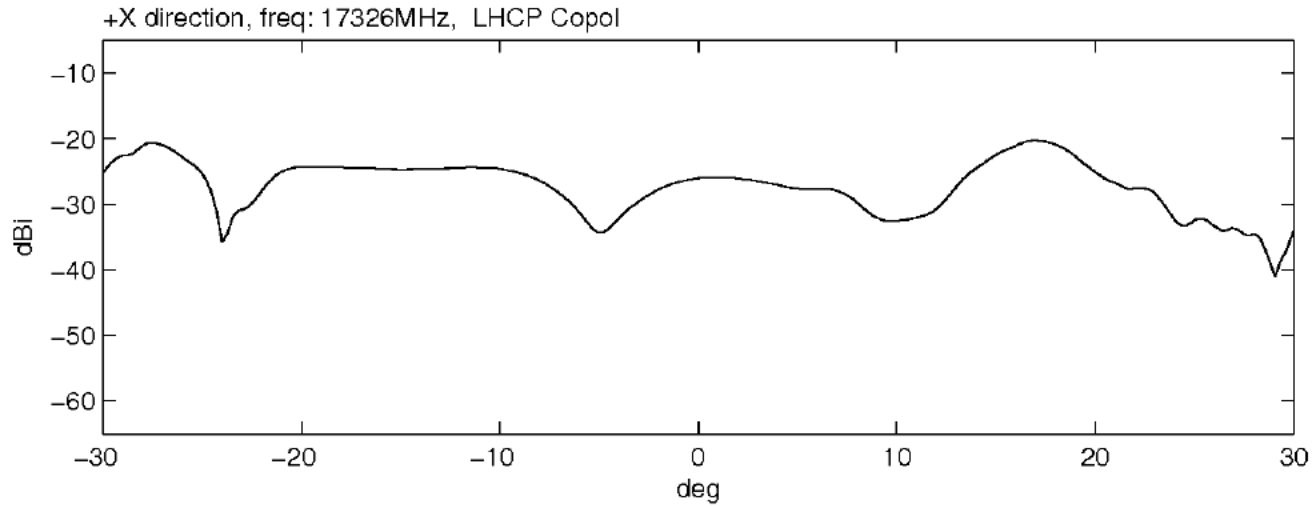

XZ-Plane, Yaw = -40 deg -x direction, Freq: 17326 MHz RHCP

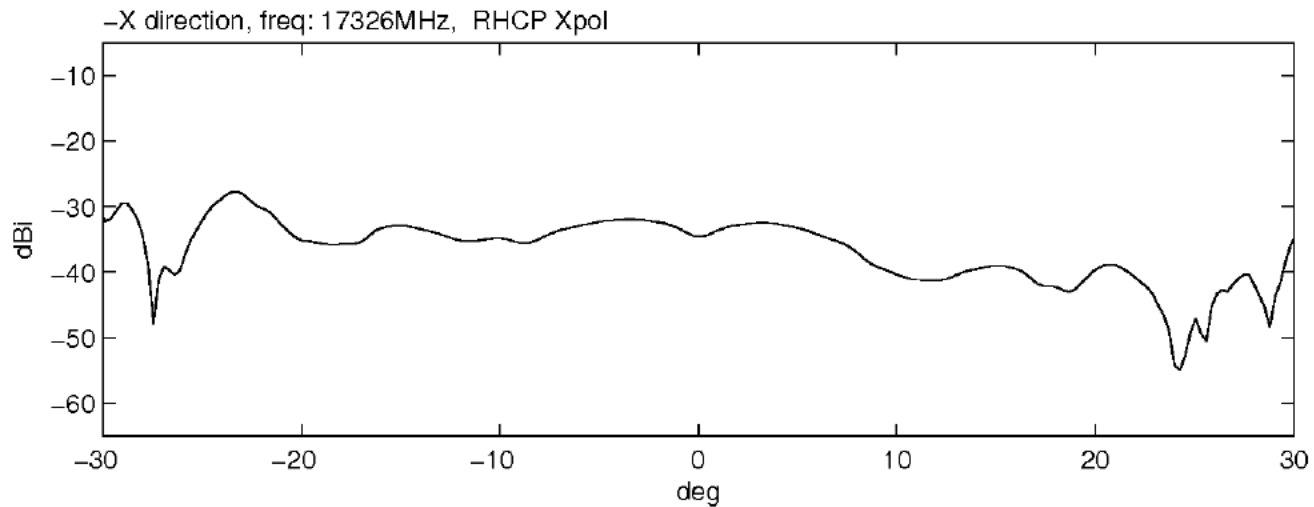
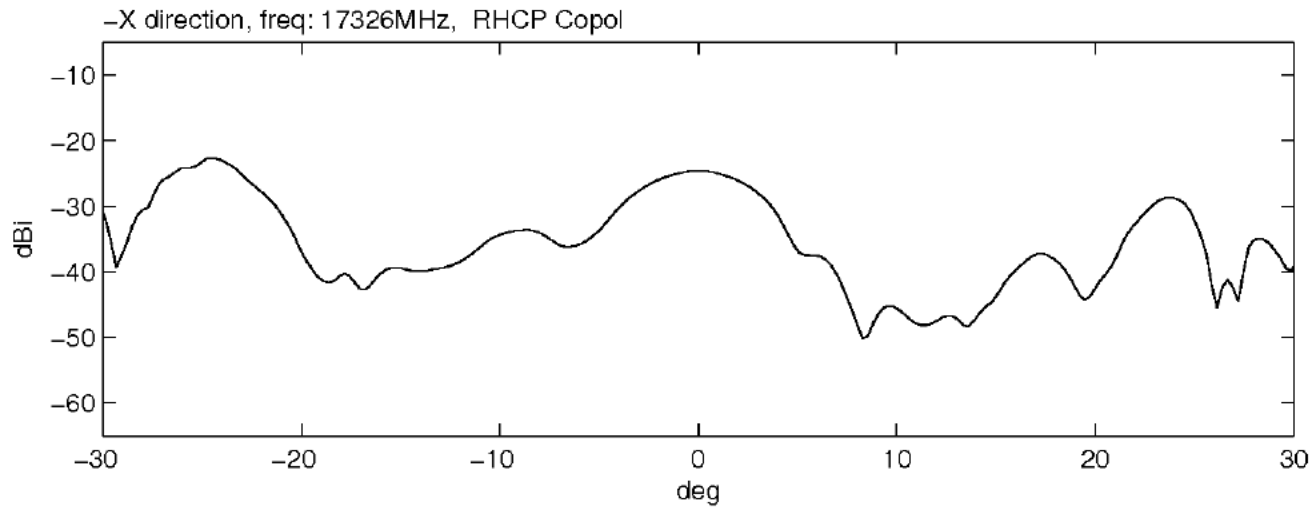

XZ-Plane, Yaw = -40 deg -x direction, Freq: 17326 MHz LHCP

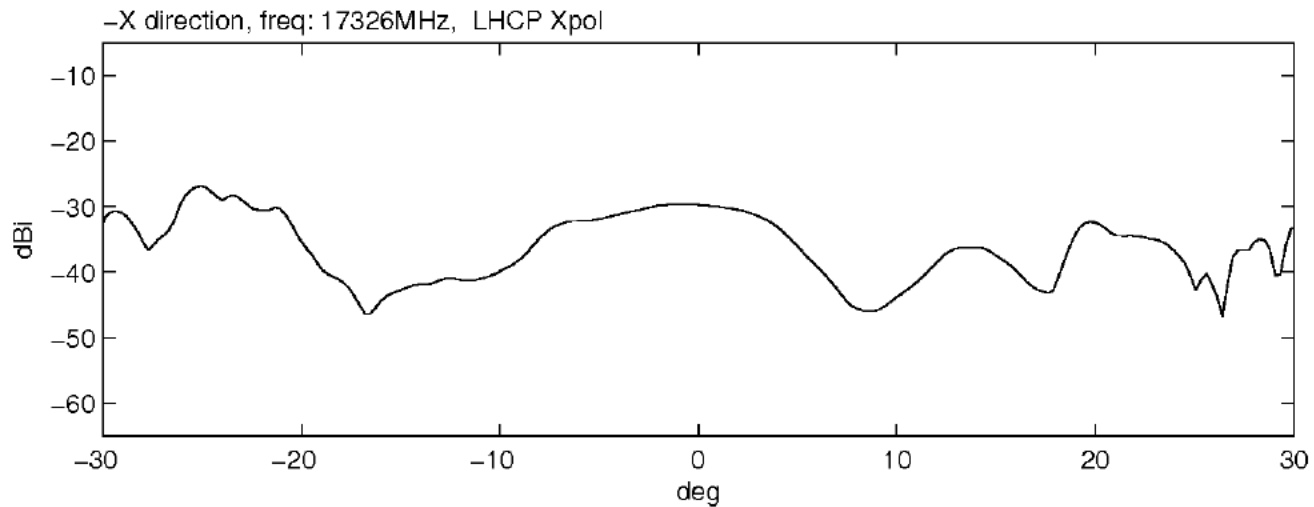
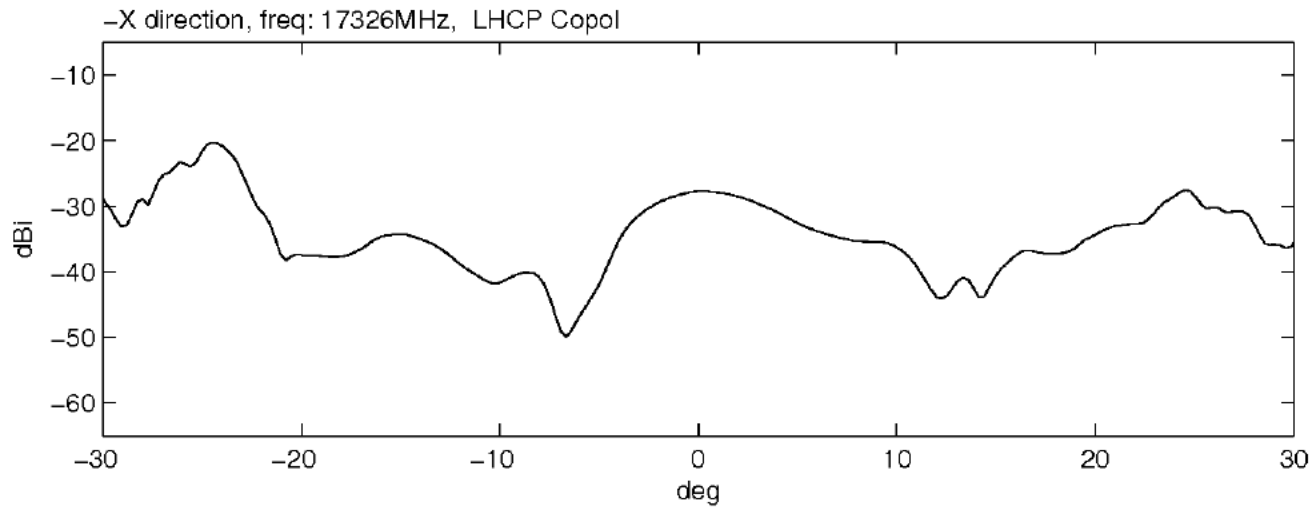

XZ-Plane, Yaw = -50 deg +x direction, Freq: 17326 MHz RHCP

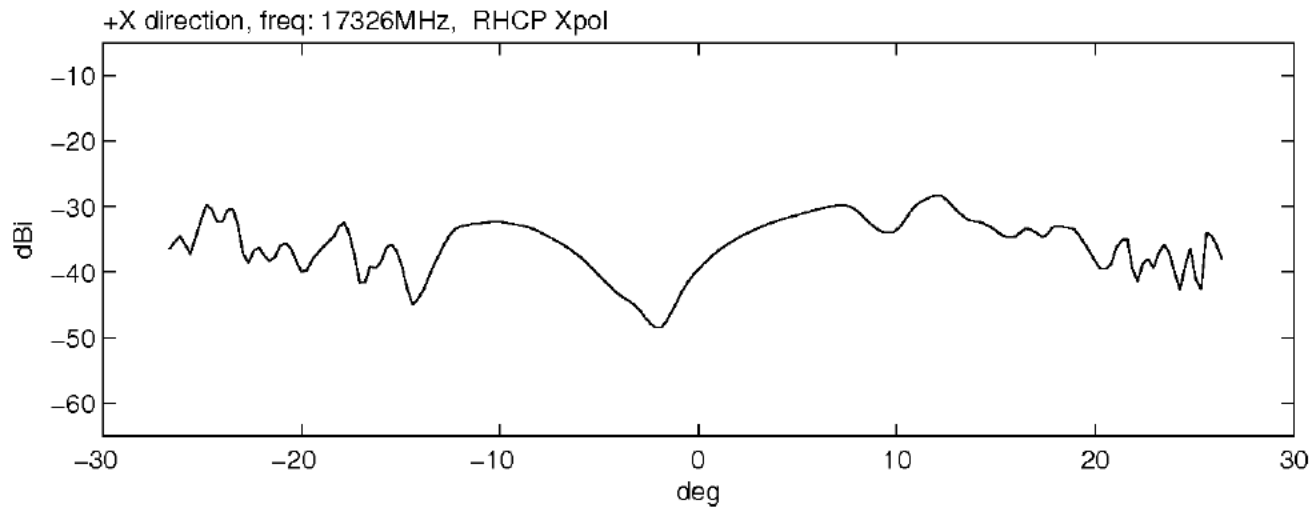
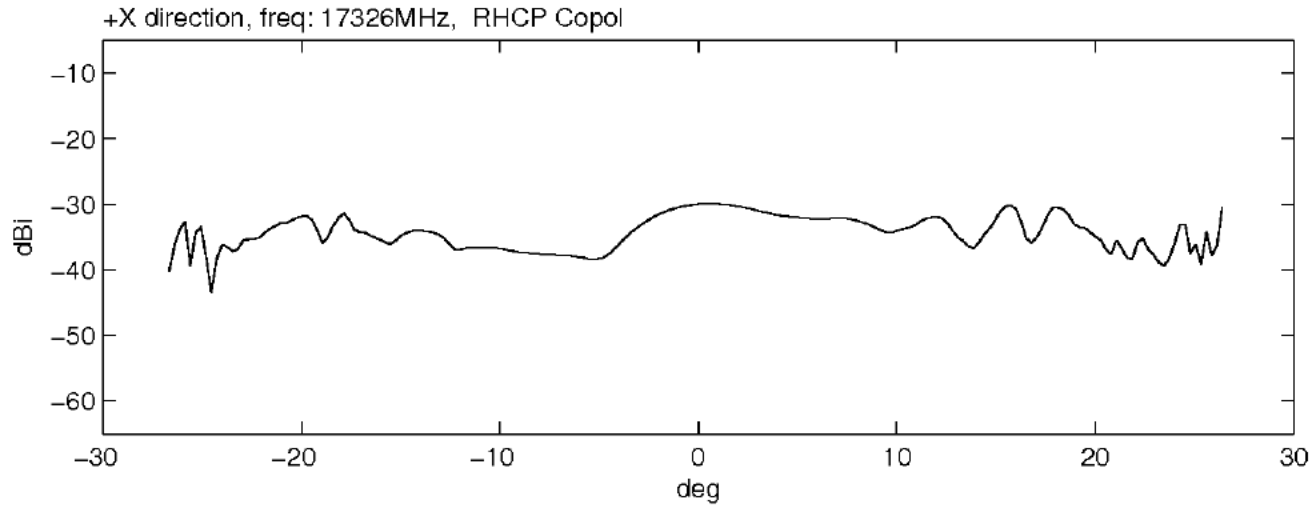

XZ-Plane, Yaw = -50 deg +x direction, Freq: 17326 MHz LHCP

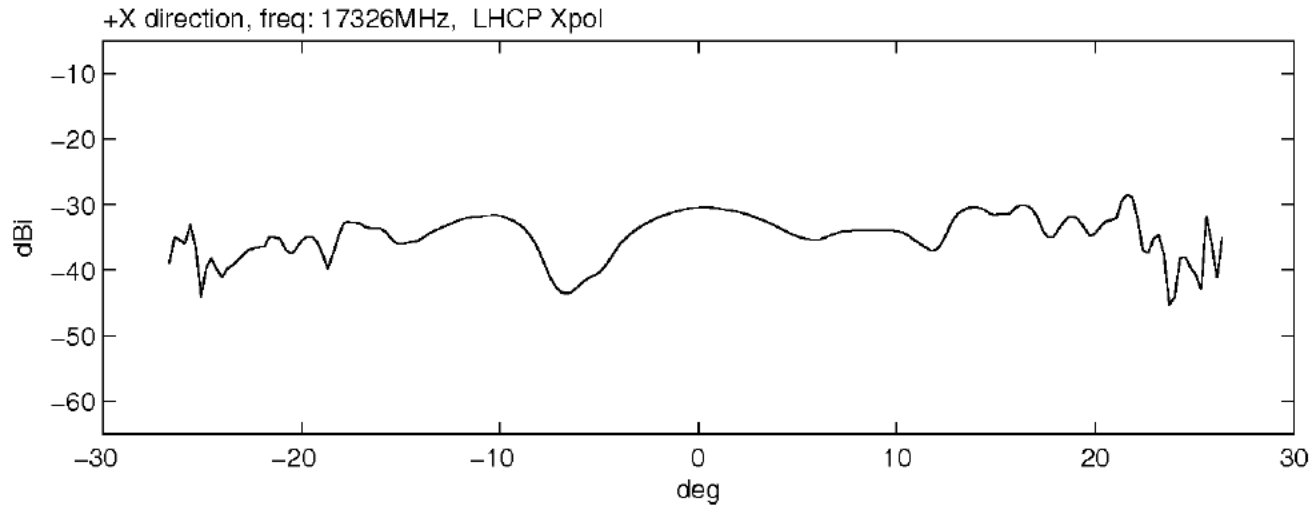
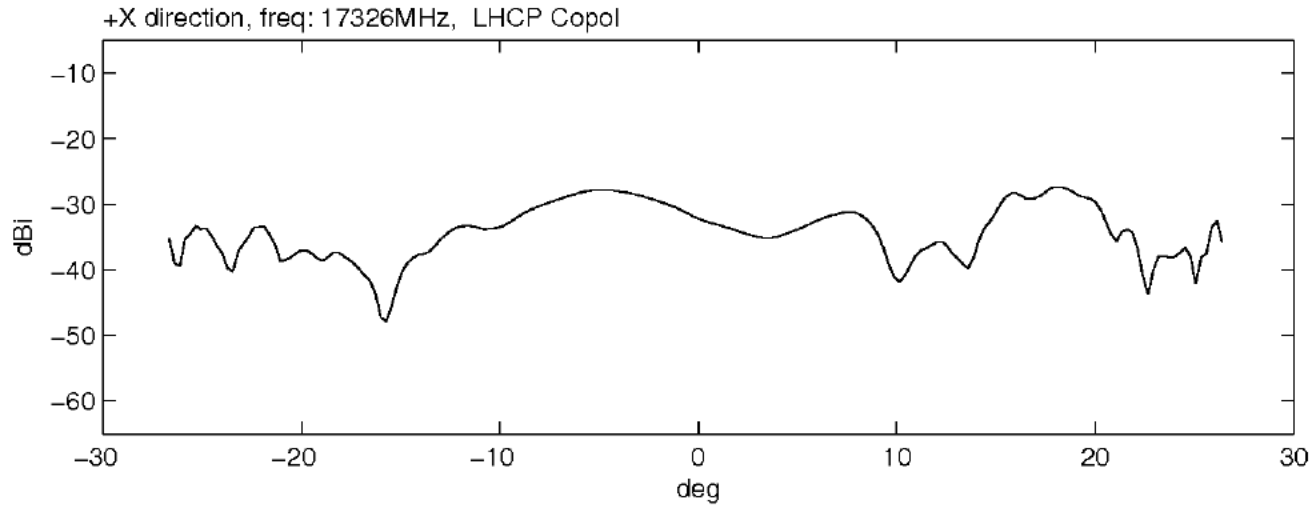

XZ-Plane, Yaw = -50 deg -x direction, Freq: 17326 MHz RHCP

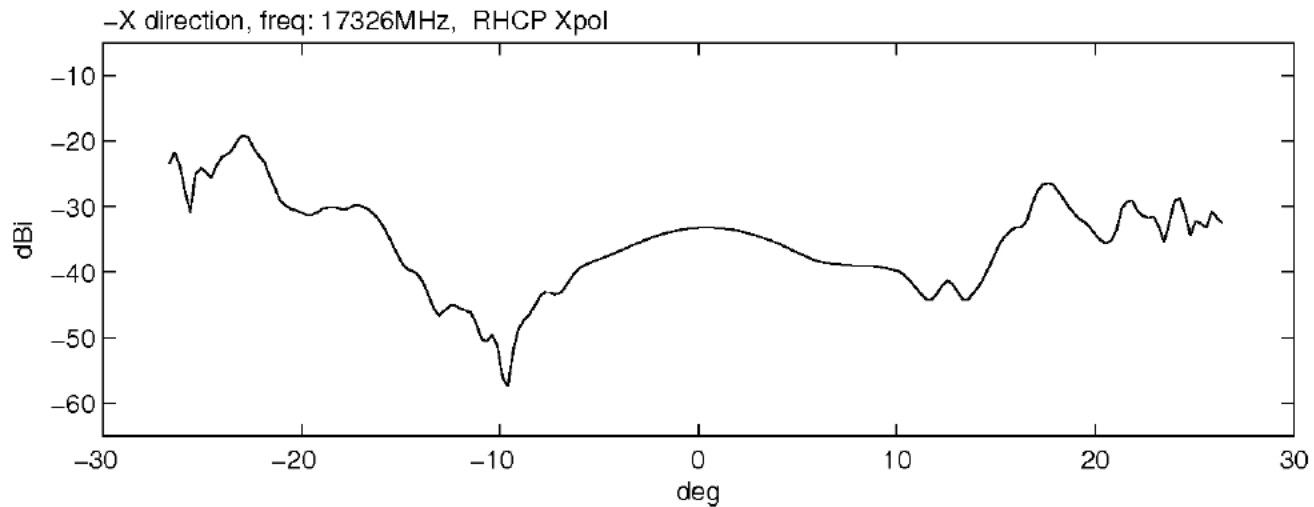
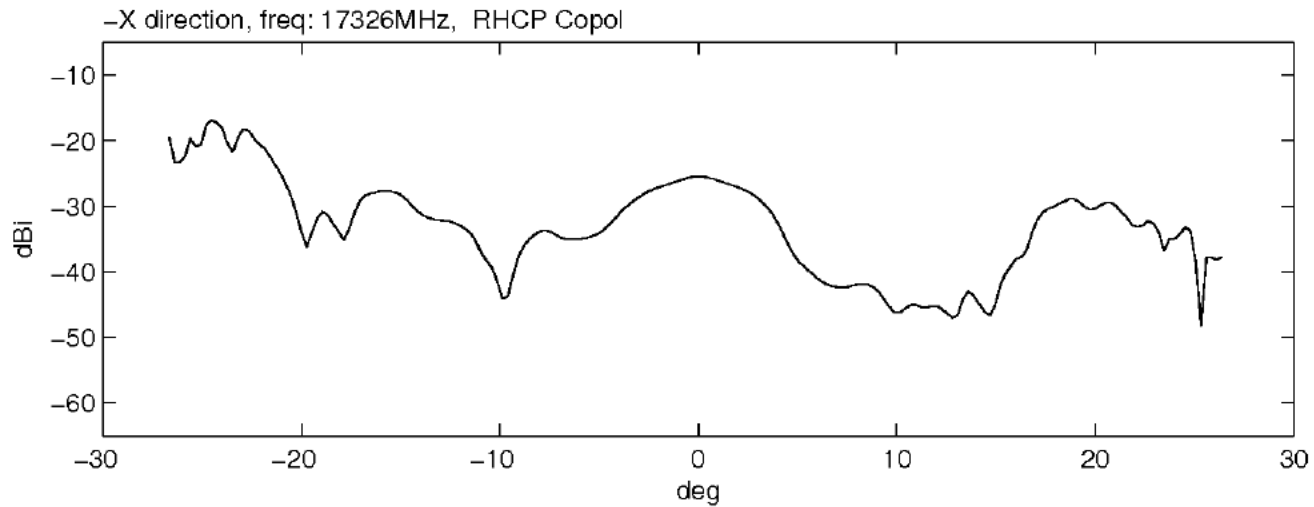

XZ-Plane, Yaw = -50 deg -x direction, Freq: 17326 MHz LHCP

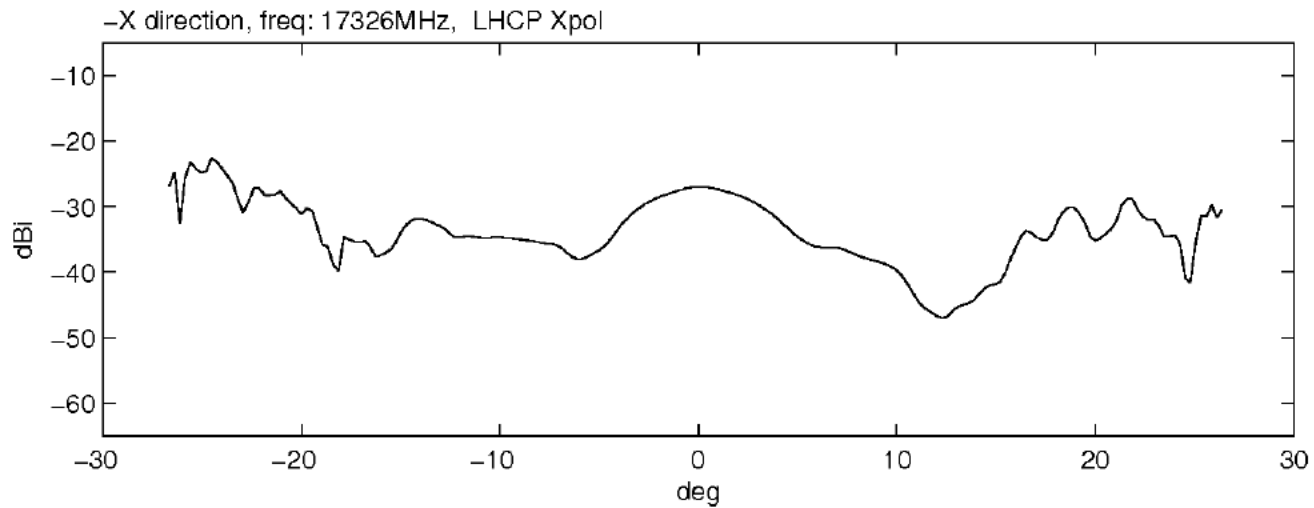
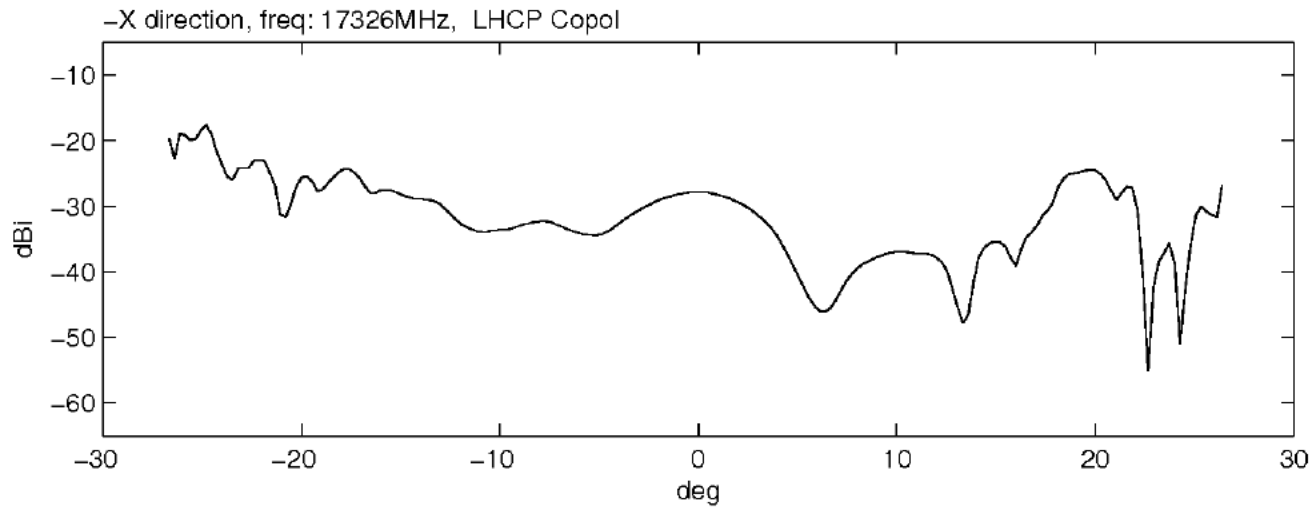

Frequency: 17.486 GHz

XZ-Plane, Yaw = 0 deg +x direction, Freq: 17486 MHz RHCP

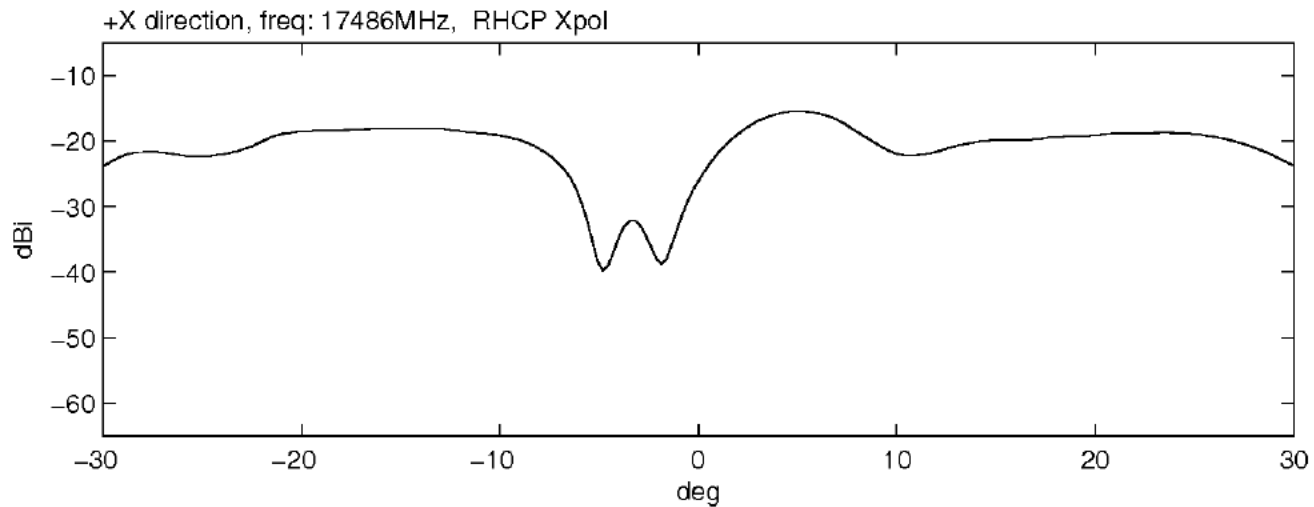
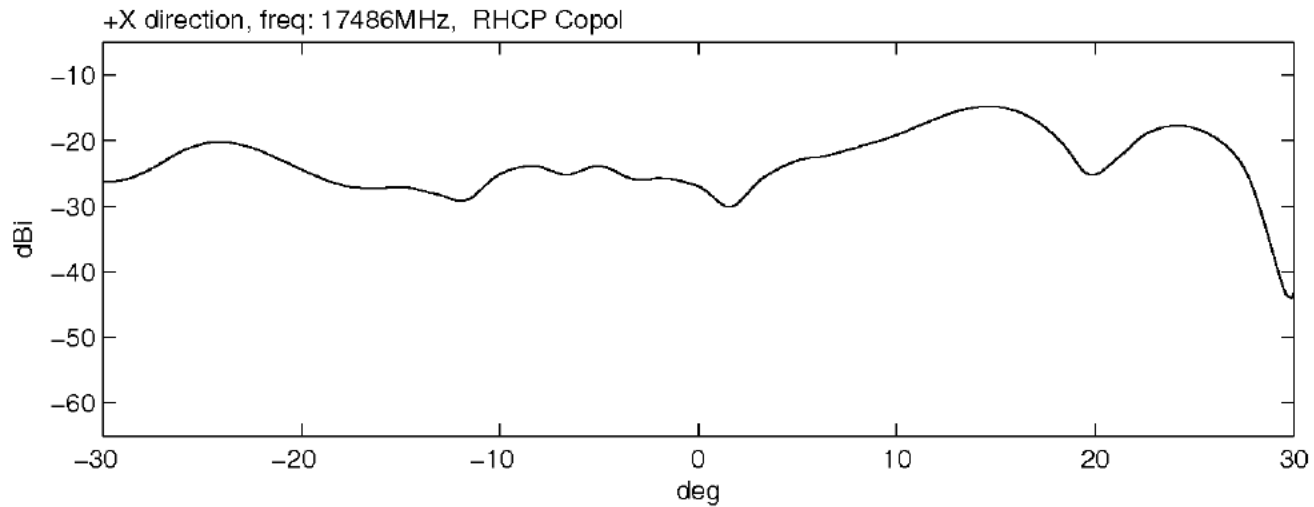

XZ-Plane, Yaw = 0 deg +x direction, Freq: 17486 MHz LHCP

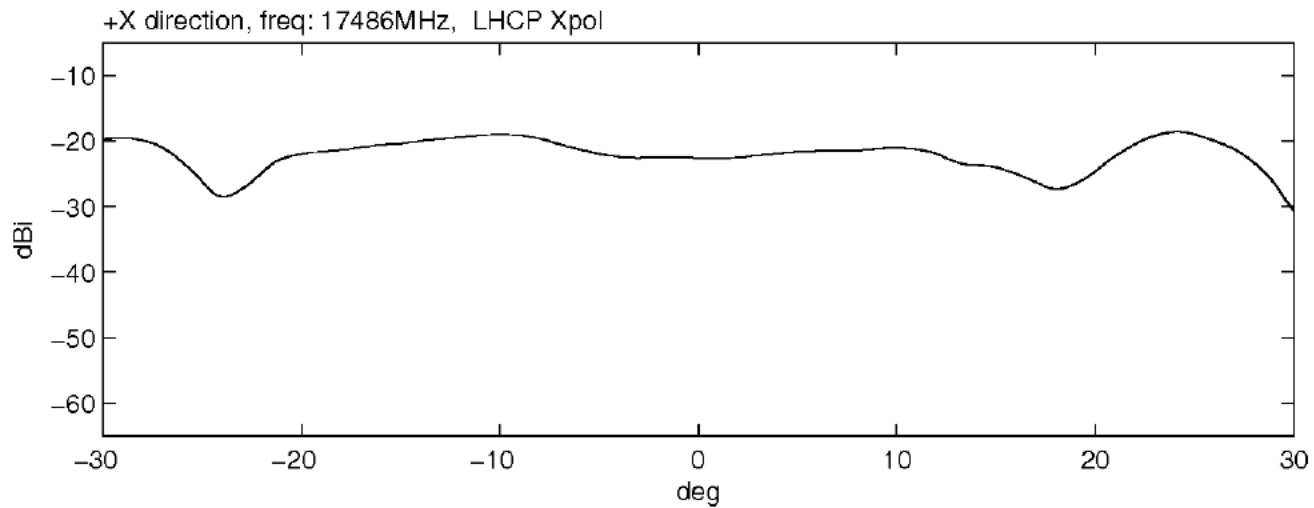
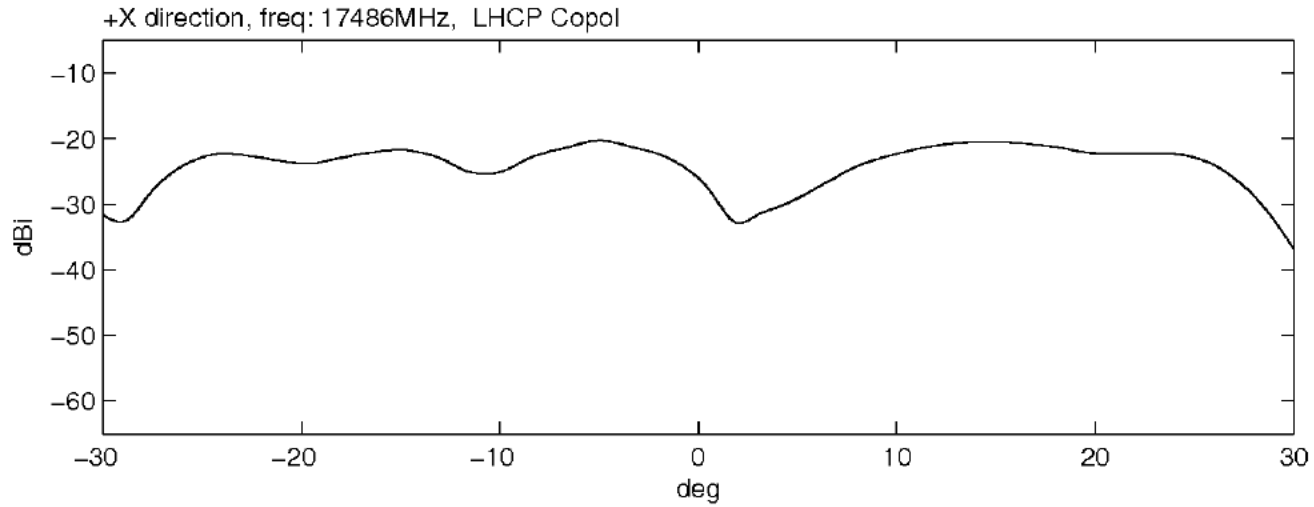

XZ-Plane, Yaw = 0 deg -x direction, Freq: 17486 MHz RHCP

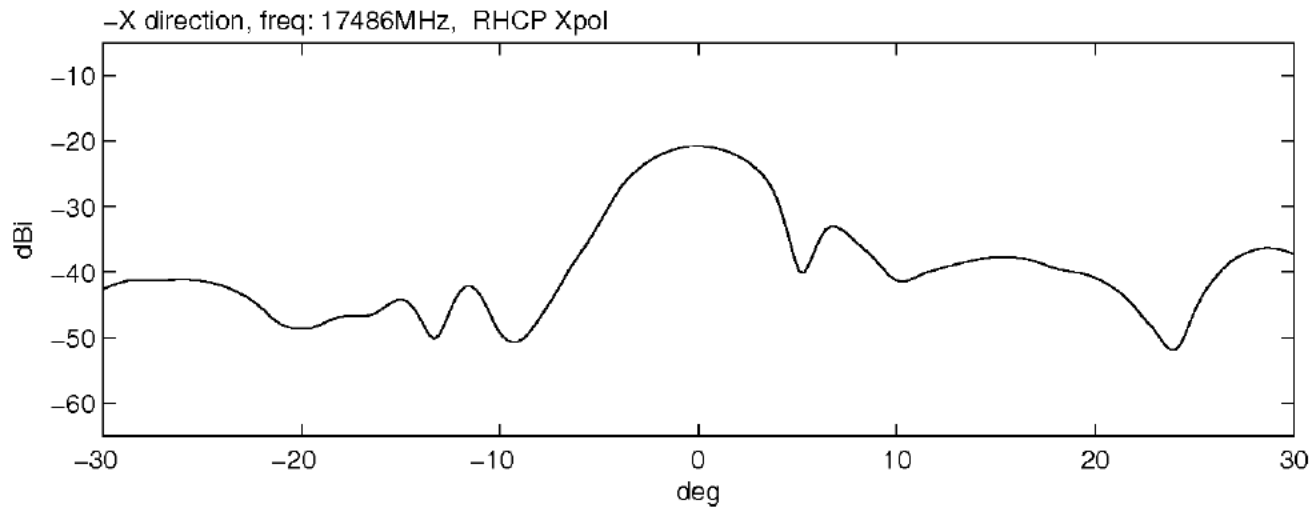
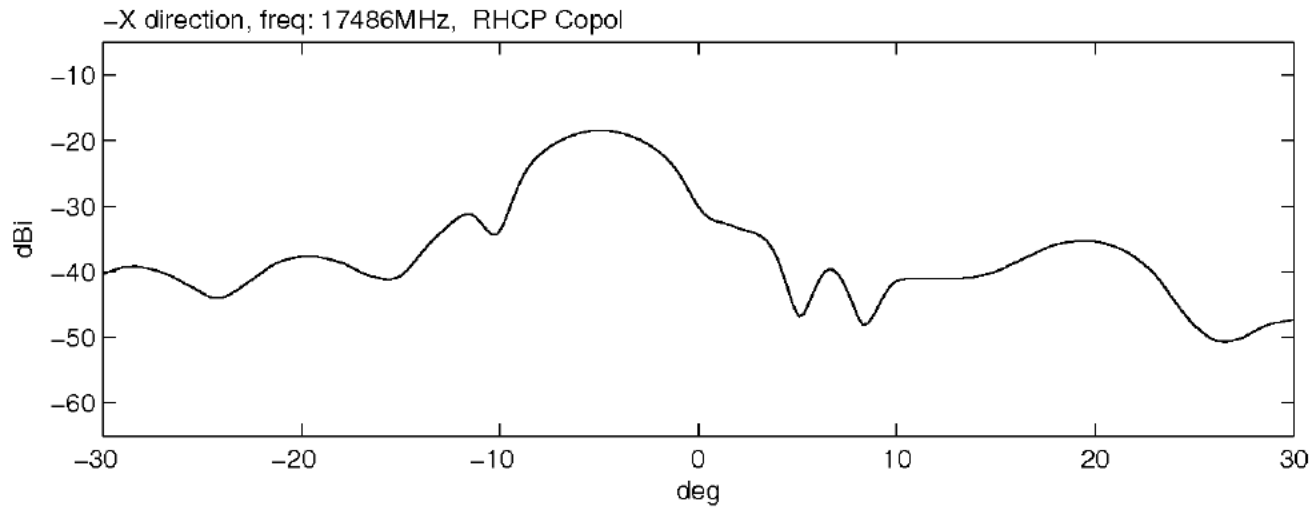

XZ-Plane, Yaw = 0 deg -x direction, Freq: 17486 MHz LHCP

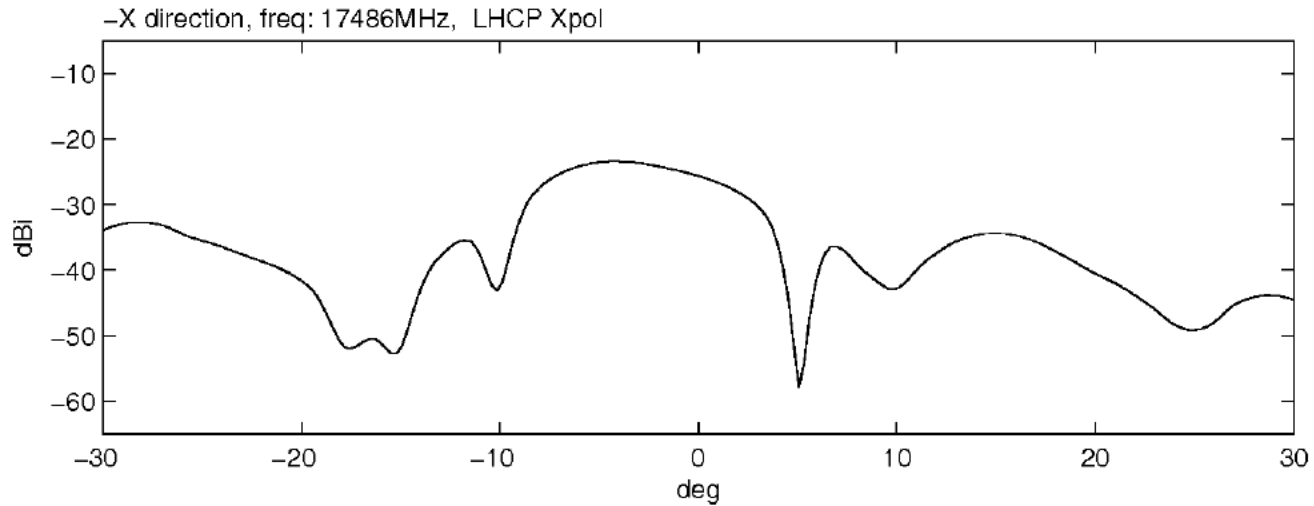
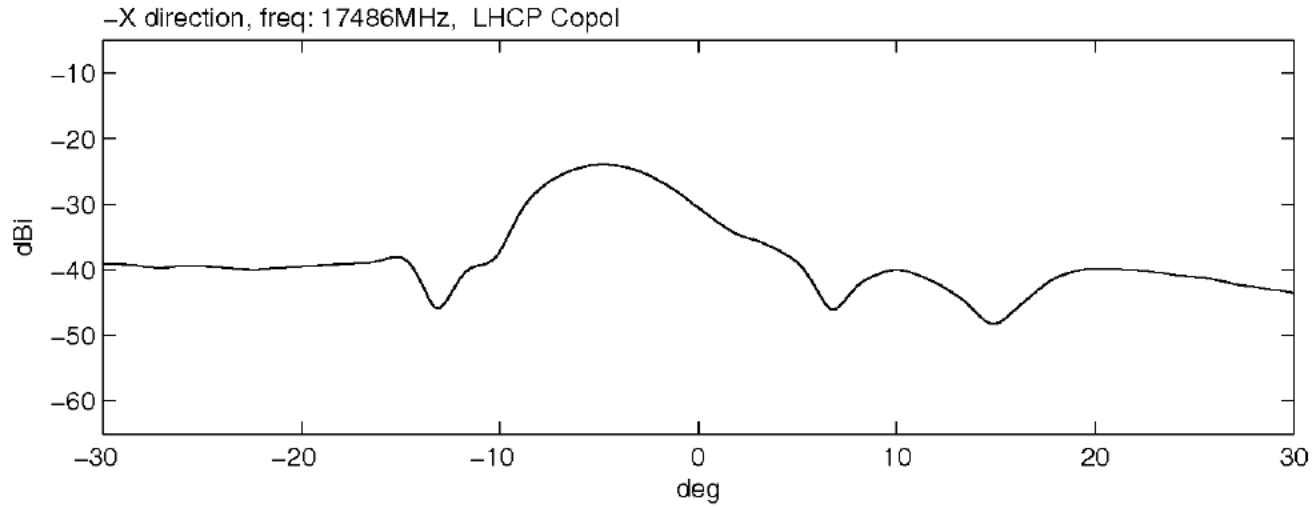

XZ-Plane, Yaw = 10 deg +x direction, Freq: 17486 MHz RHCP

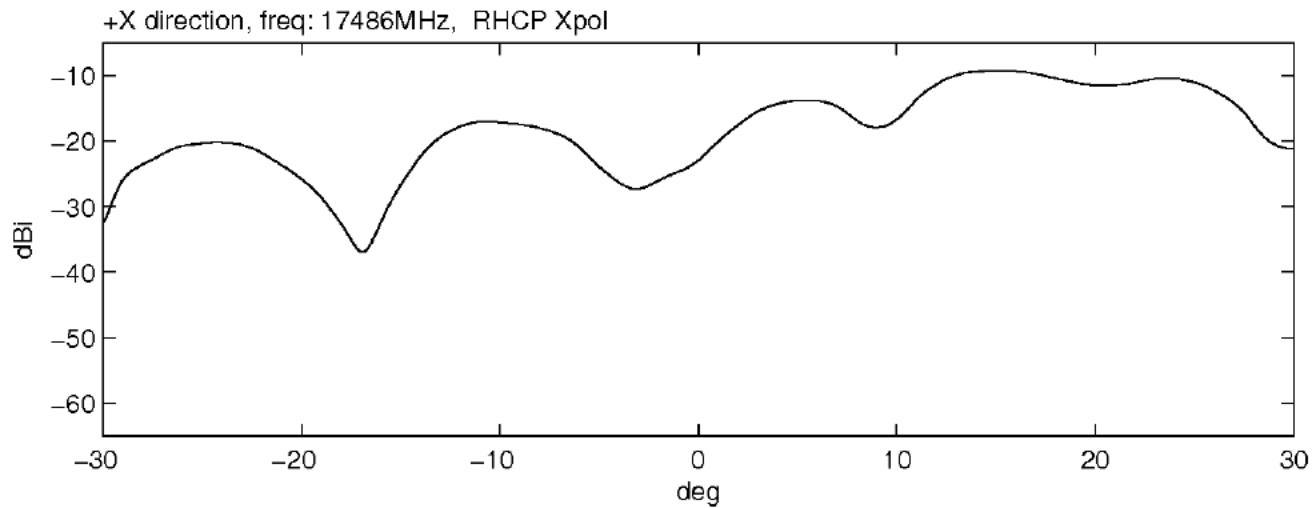
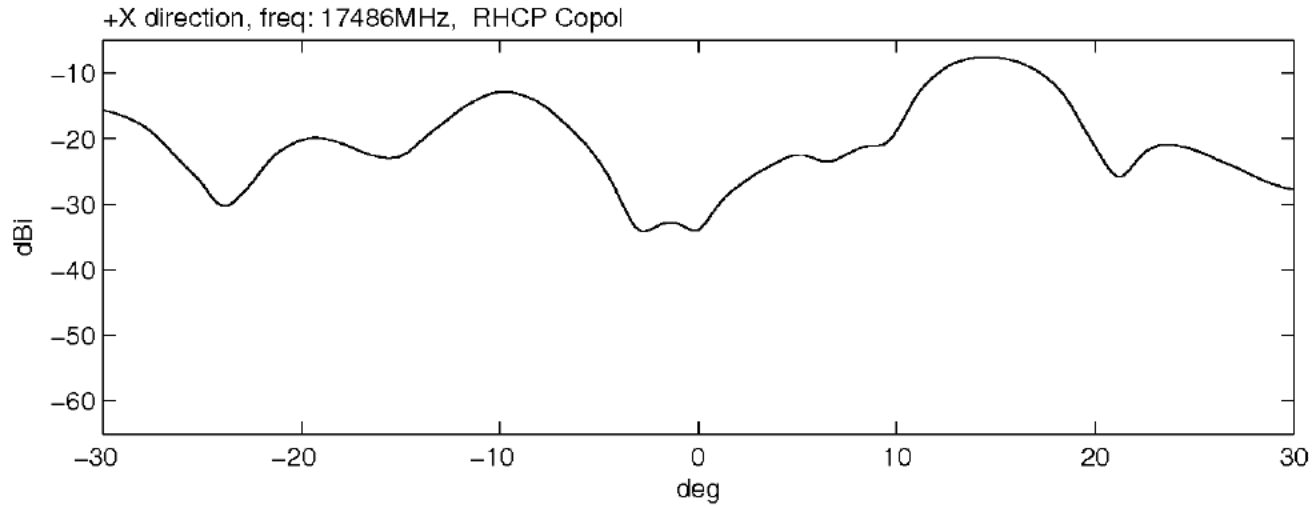

XZ-Plane, Yaw = 10 deg +x direction, Freq: 17486 MHz LHCP

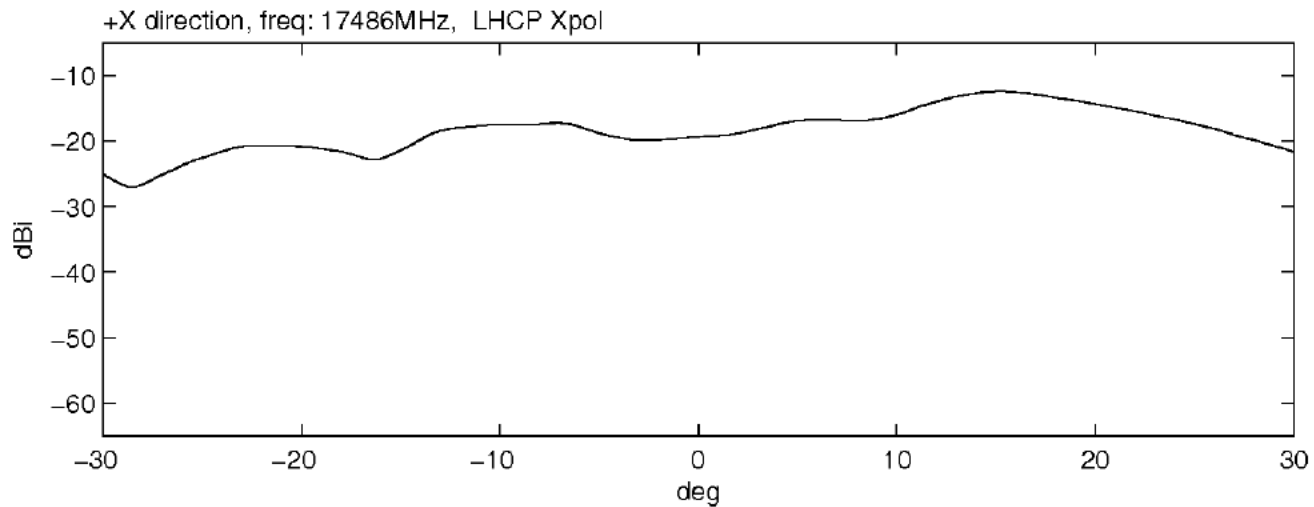
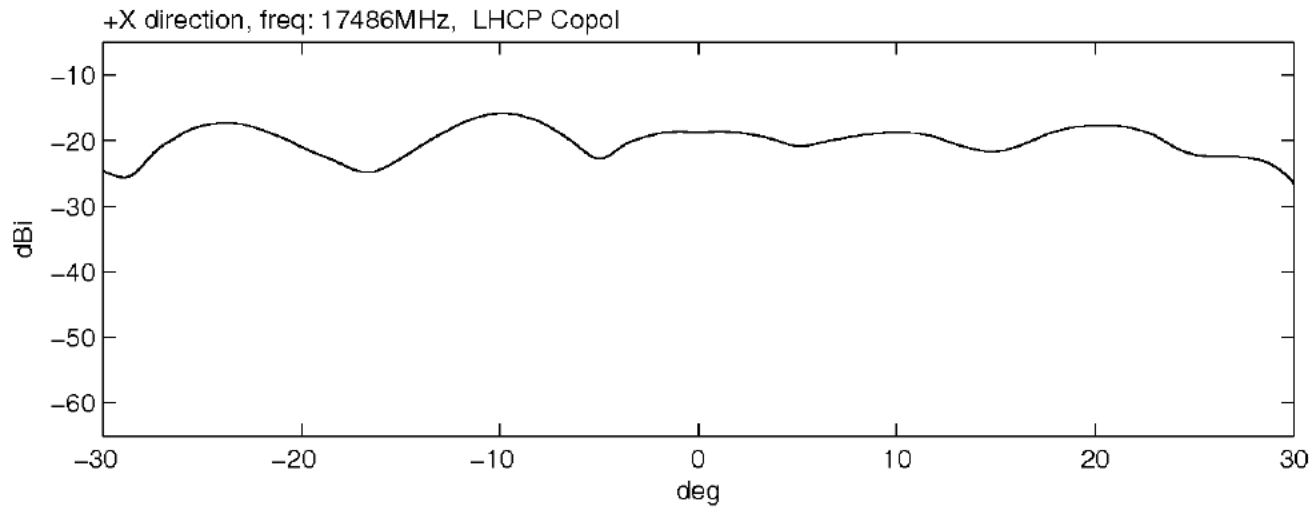

XZ-Plane, Yaw = 10 deg -x direction, Freq: 17486 MHz RHCP

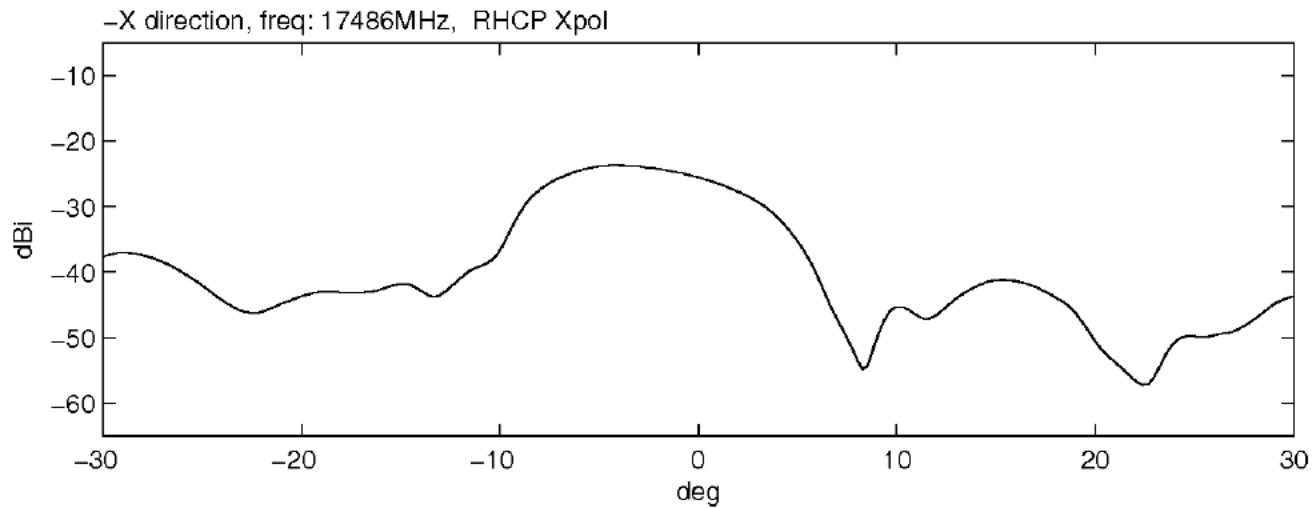
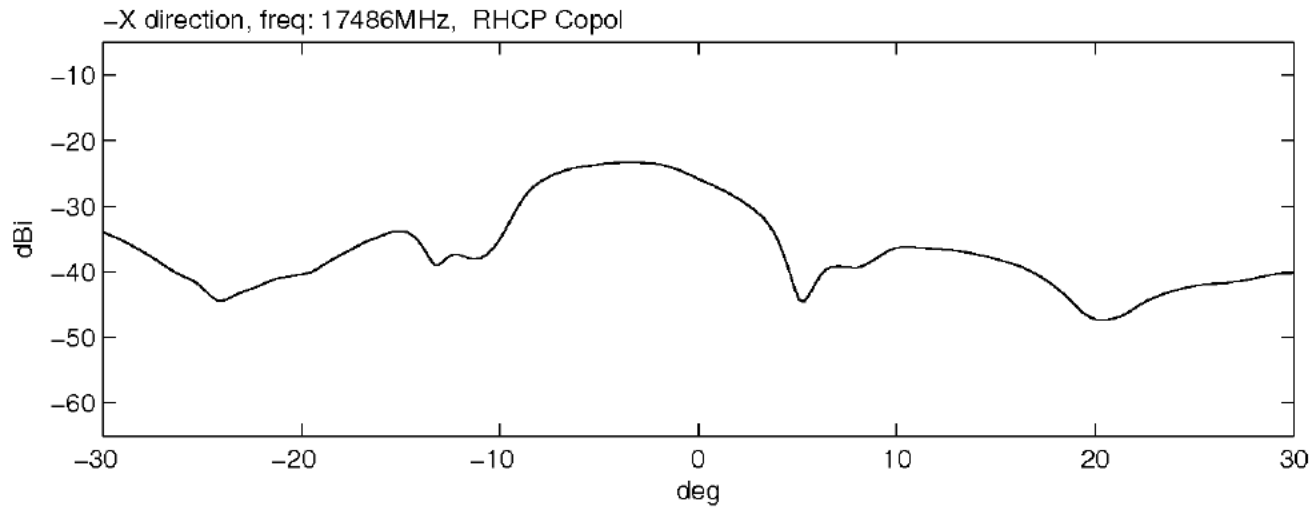

XZ-Plane, Yaw = 10 deg -x direction, Freq: 17486 MHz LHCP

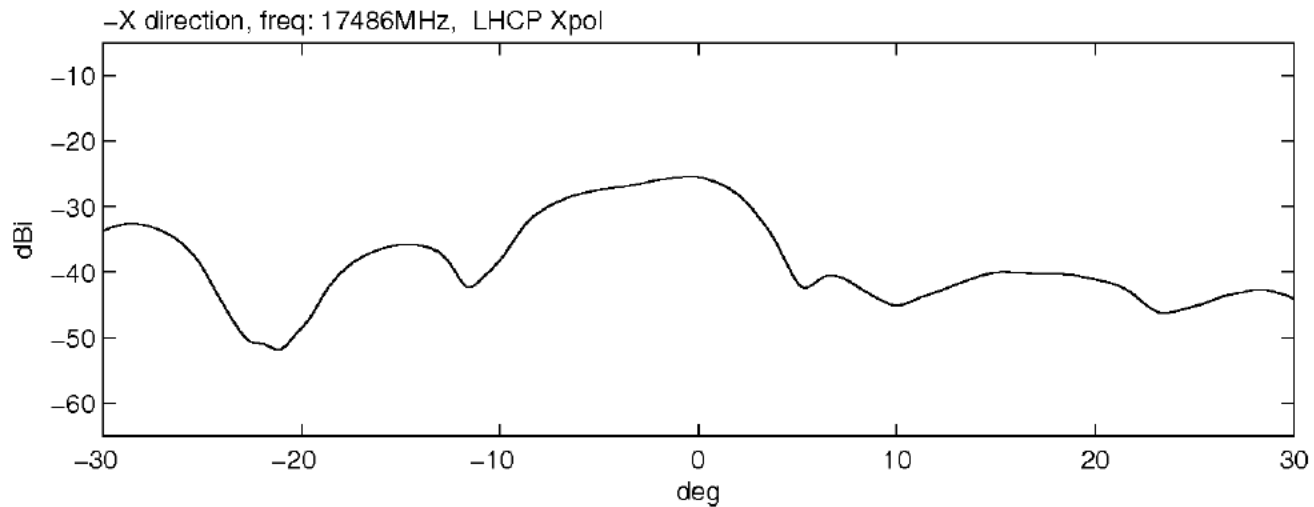
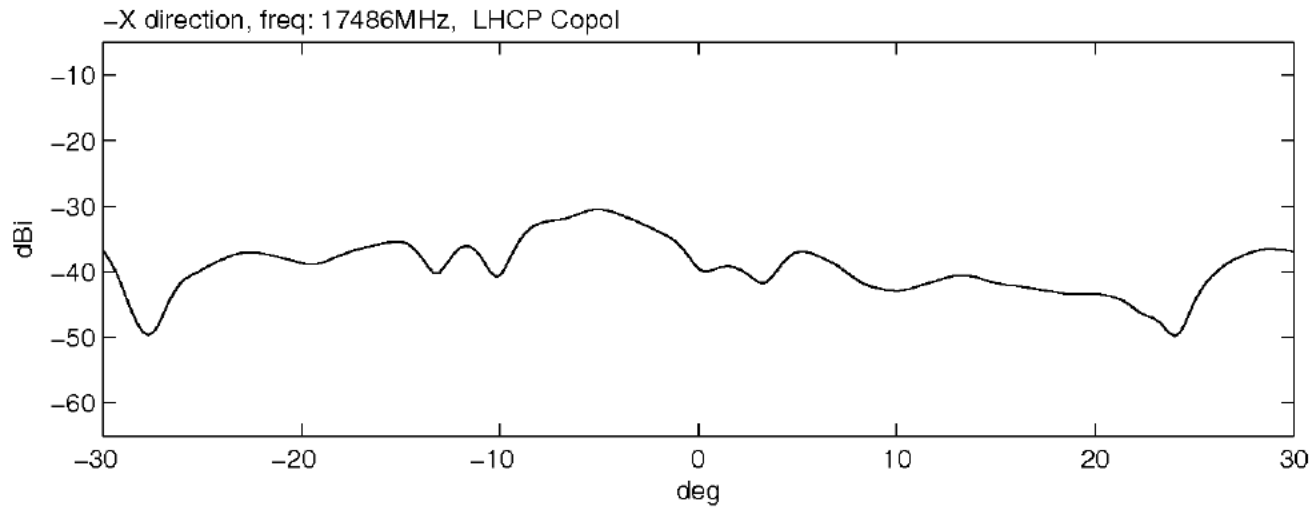

XZ-Plane, Yaw = 20 deg +x direction, Freq: 17486 MHz RHCP

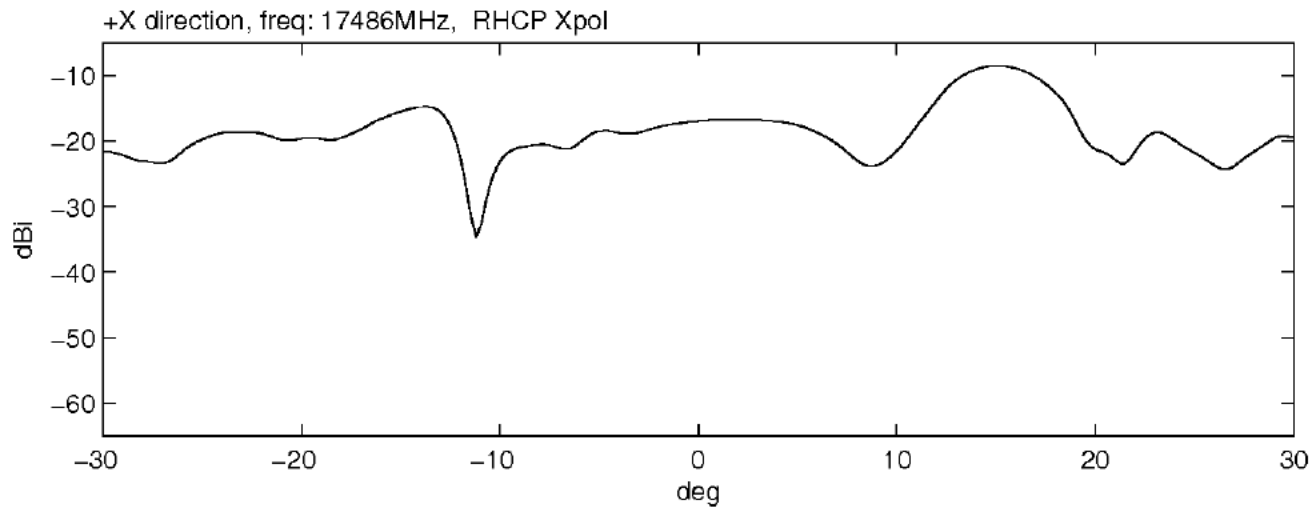
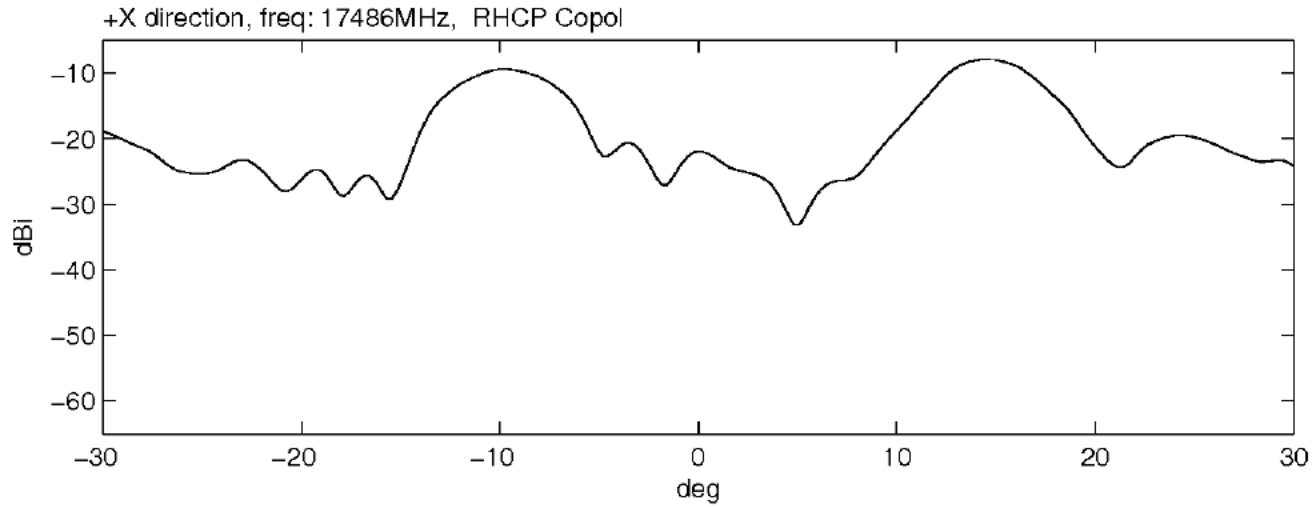

XZ-Plane, Yaw = 20 deg +x direction, Freq: 17486 MHz LHCP

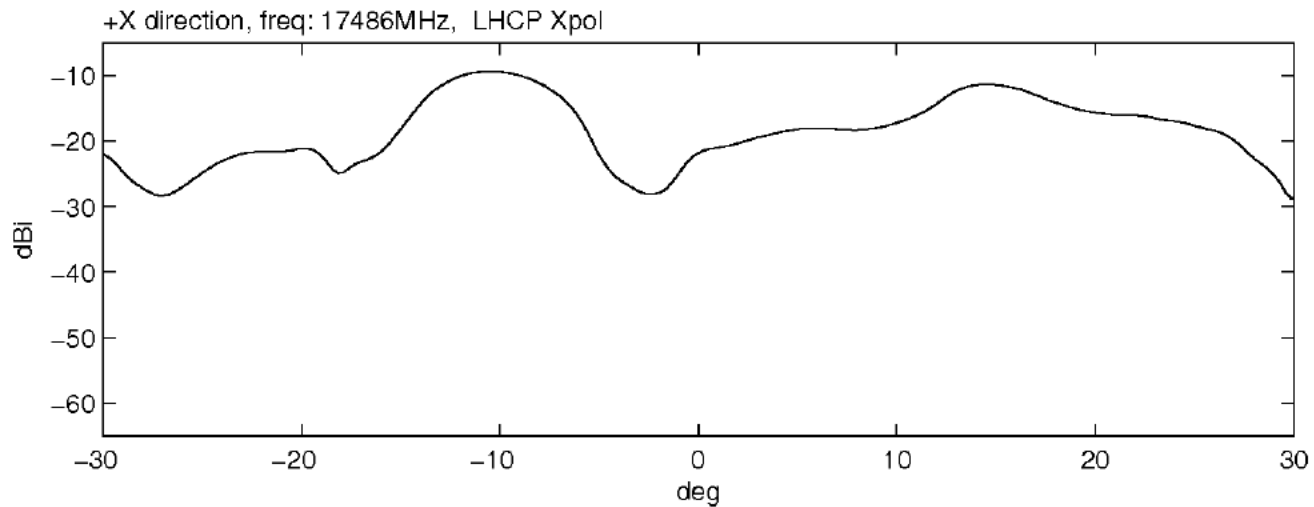
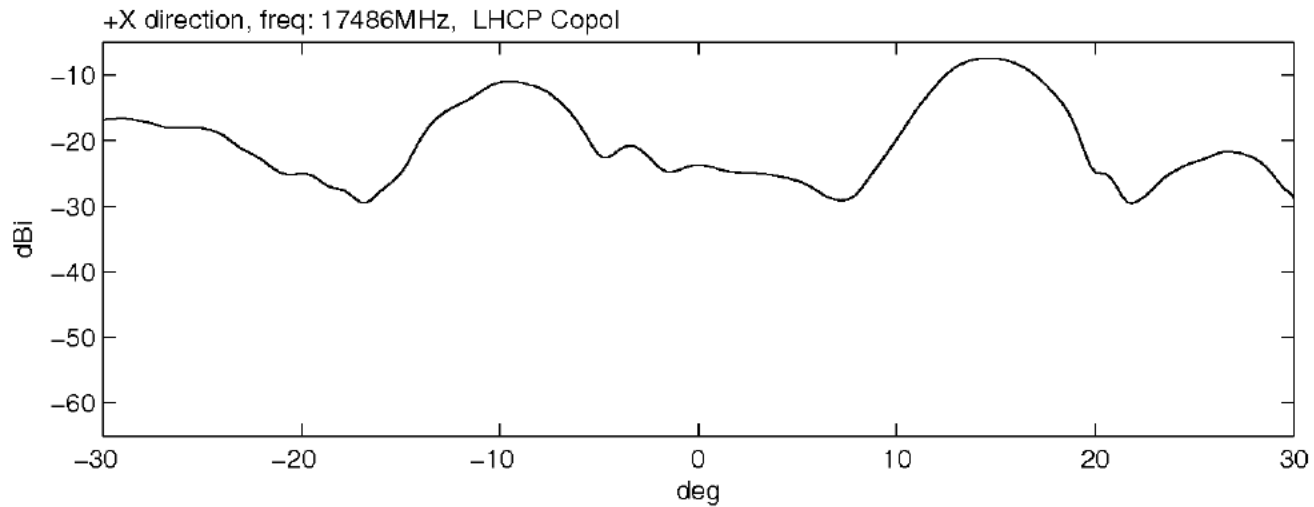

XZ-Plane, Yaw = 20 deg -x direction, Freq: 17486 MHz RHCP

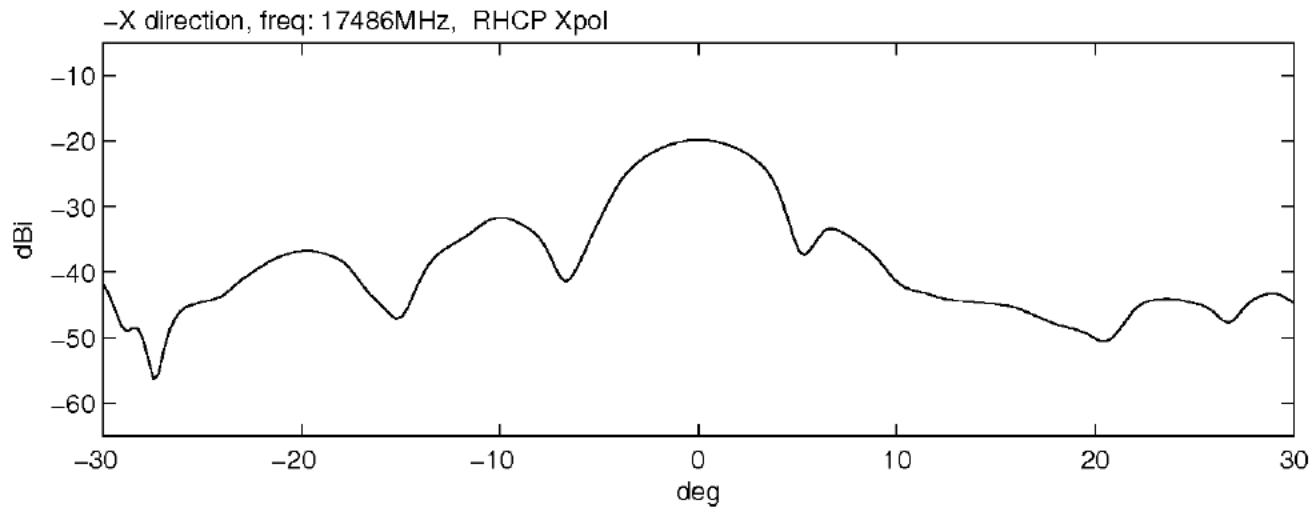
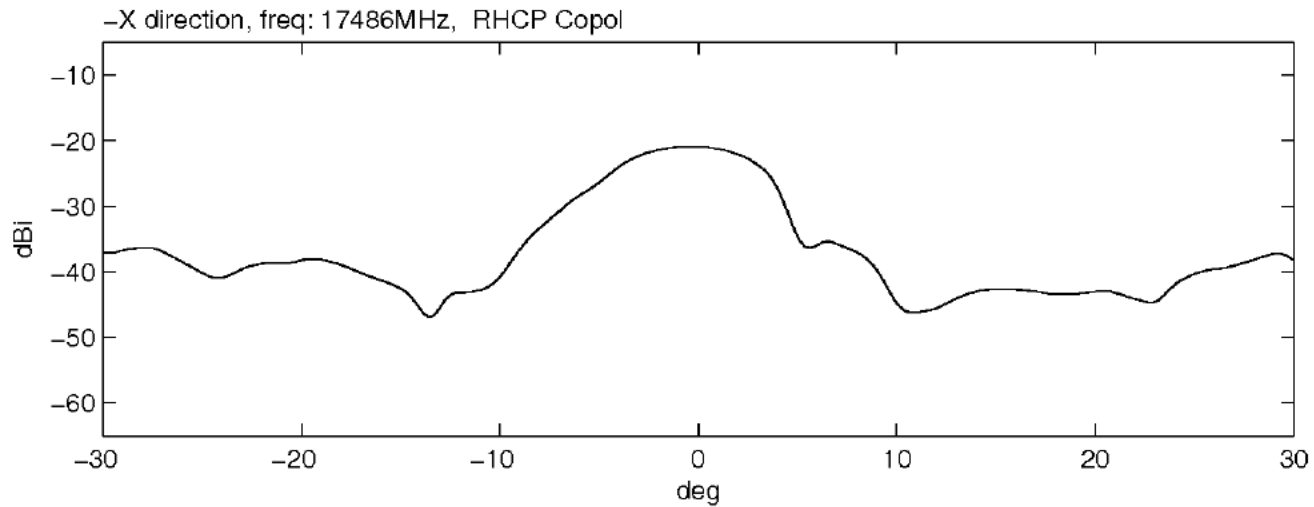

XZ-Plane, Yaw = 20 deg -x direction, Freq: 17486 MHz LHCP

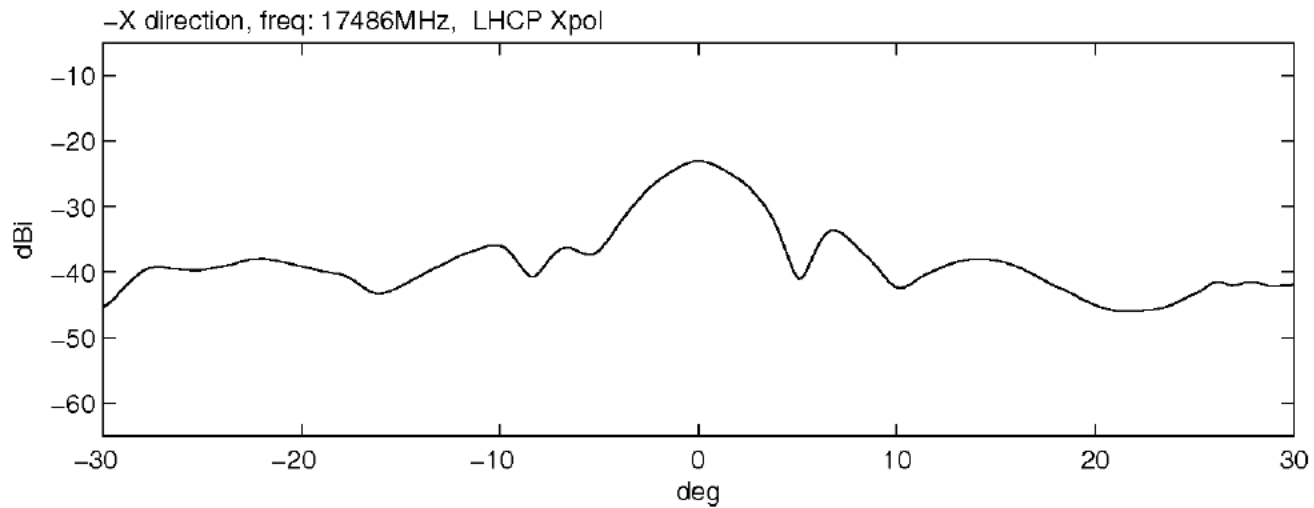
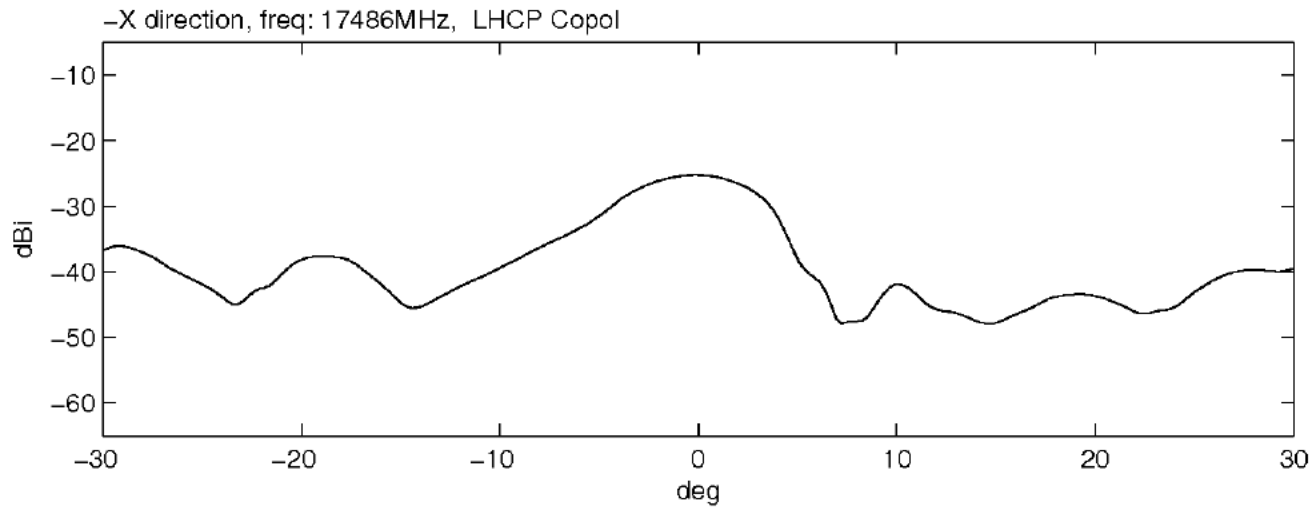

XZ-Plane, Yaw = 30 deg +x direction, Freq: 17486 MHz RHCP

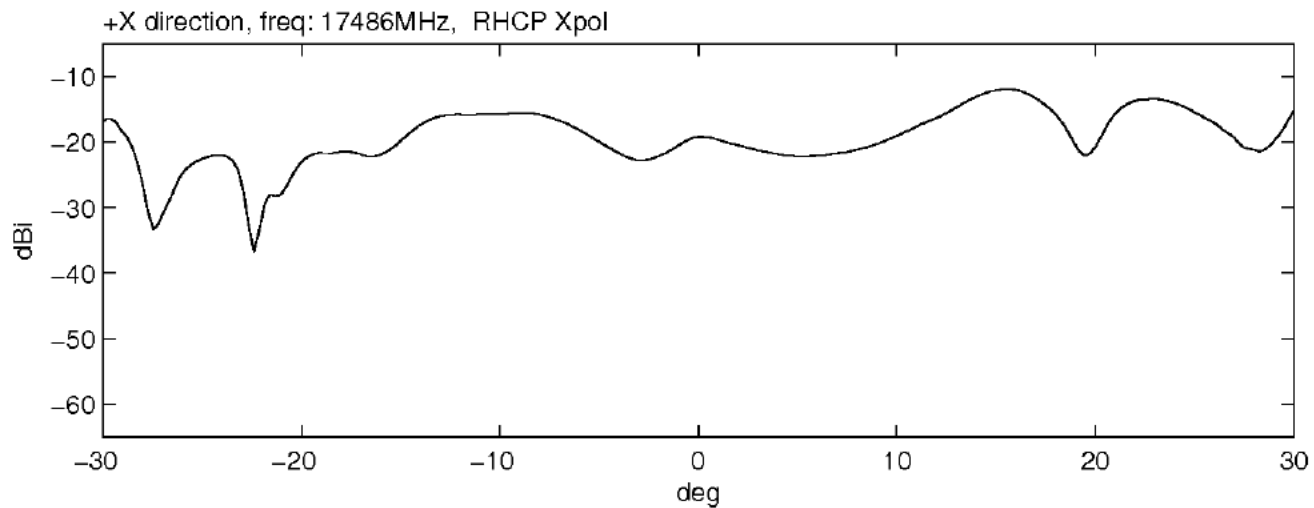
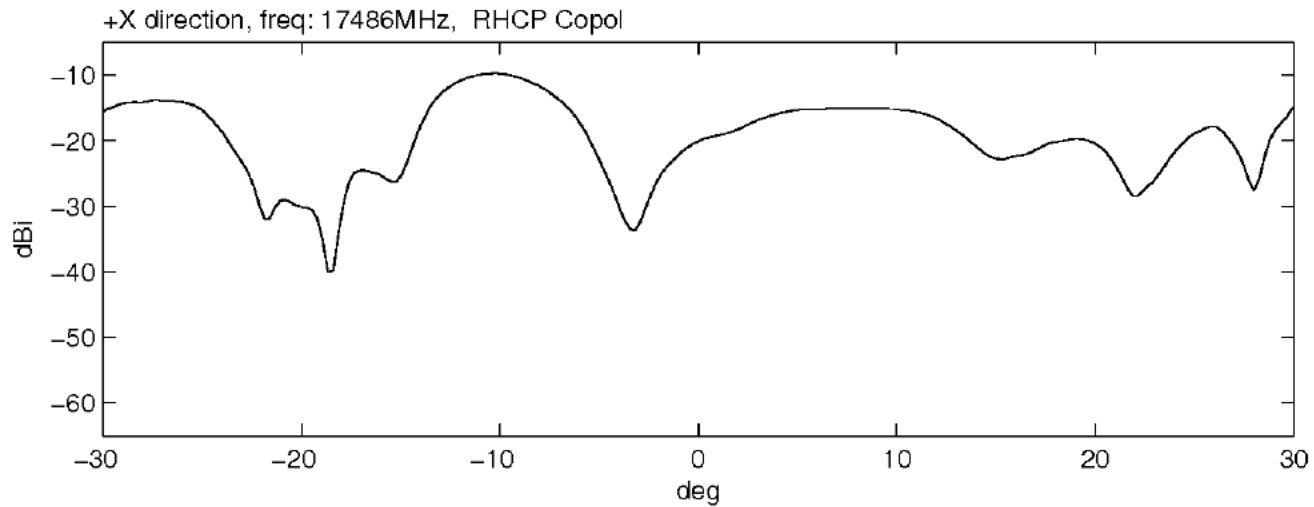

XZ-Plane, Yaw = 30 deg +x direction, Freq: 17486 MHz LHCP

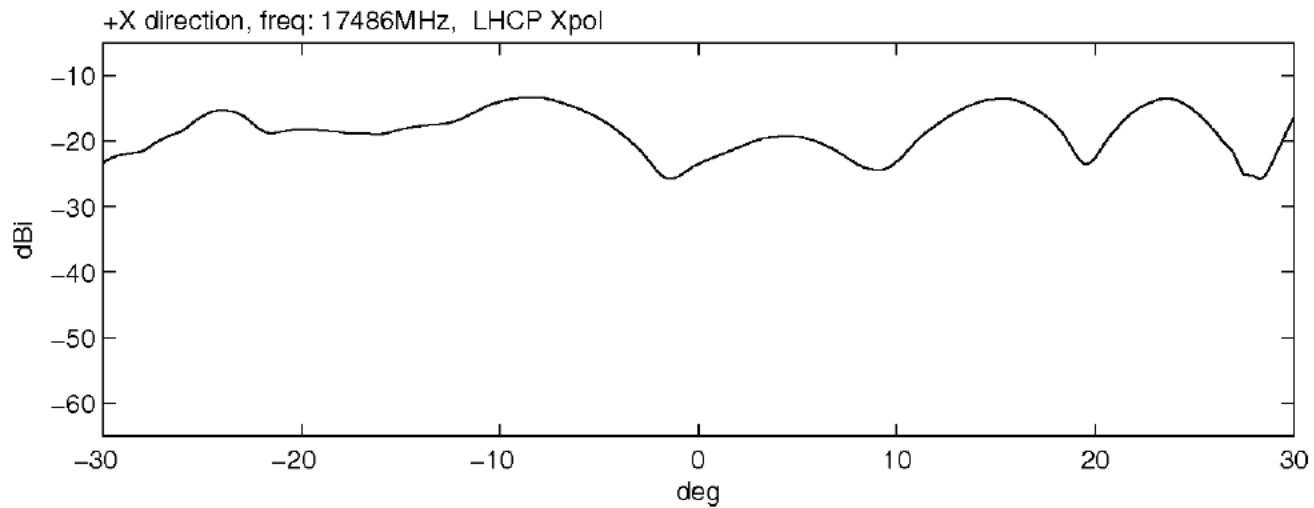
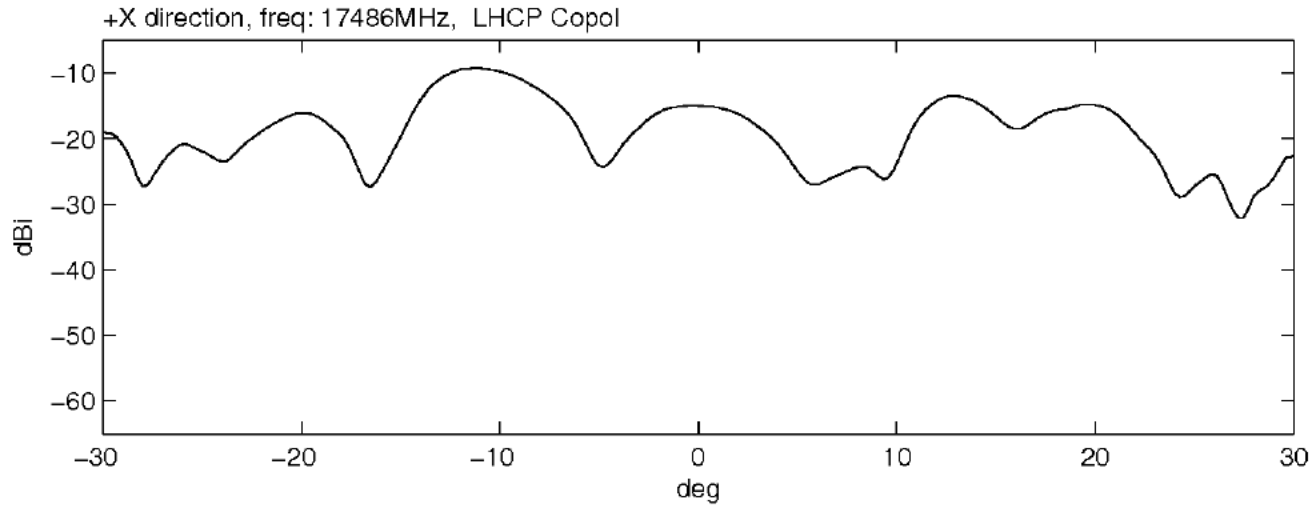

XZ-Plane, Yaw = 30 deg -x direction, Freq: 17486 MHz RHCP

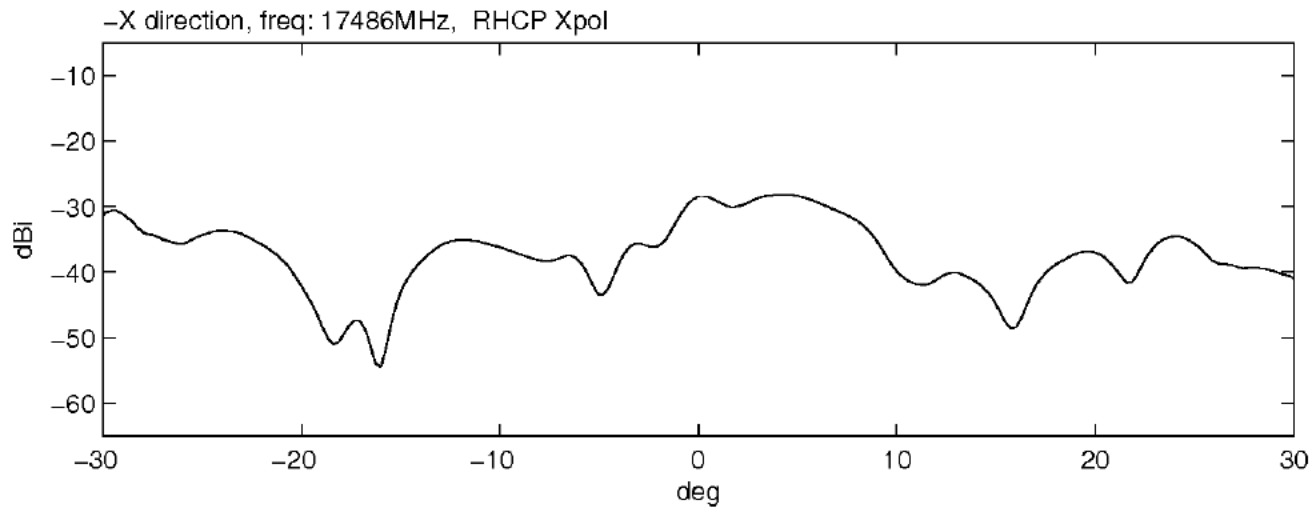
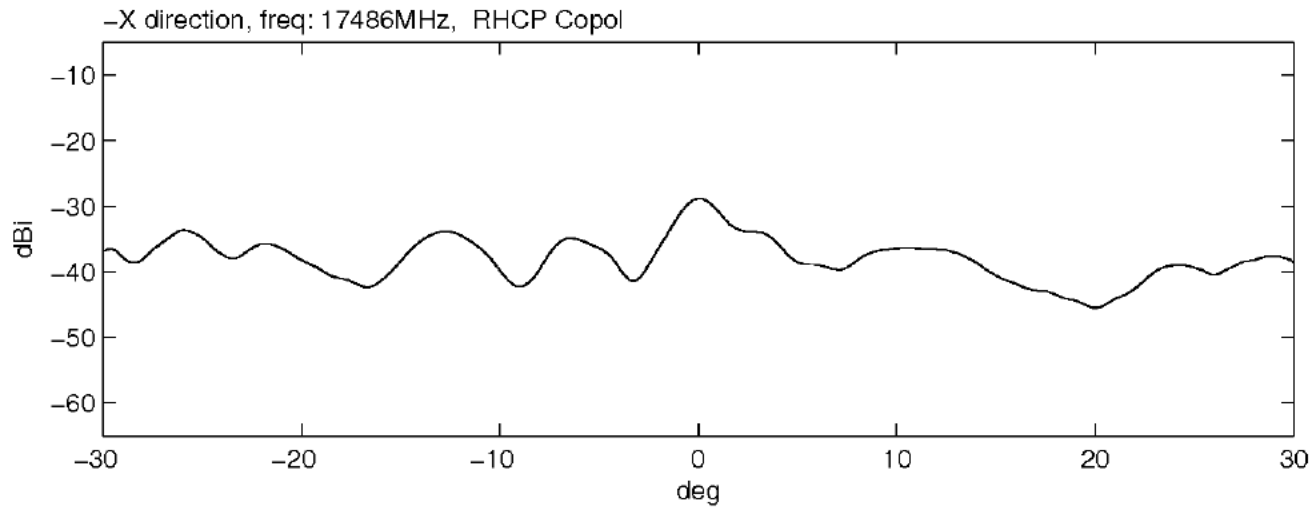

XZ-Plane, Yaw = 30 deg -x direction, Freq: 17486 MHz LHCP

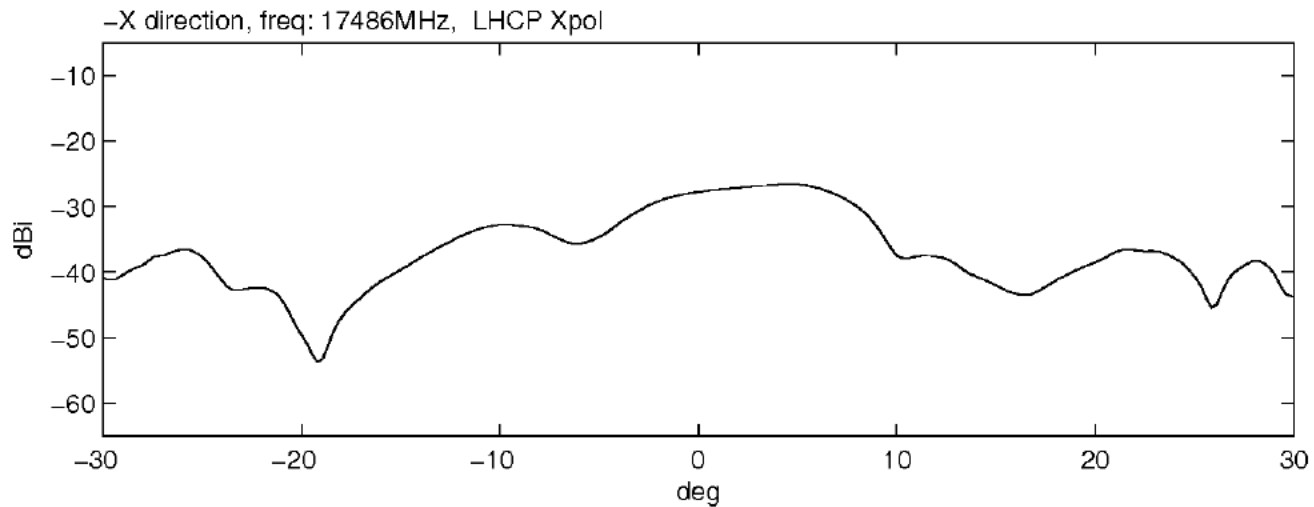
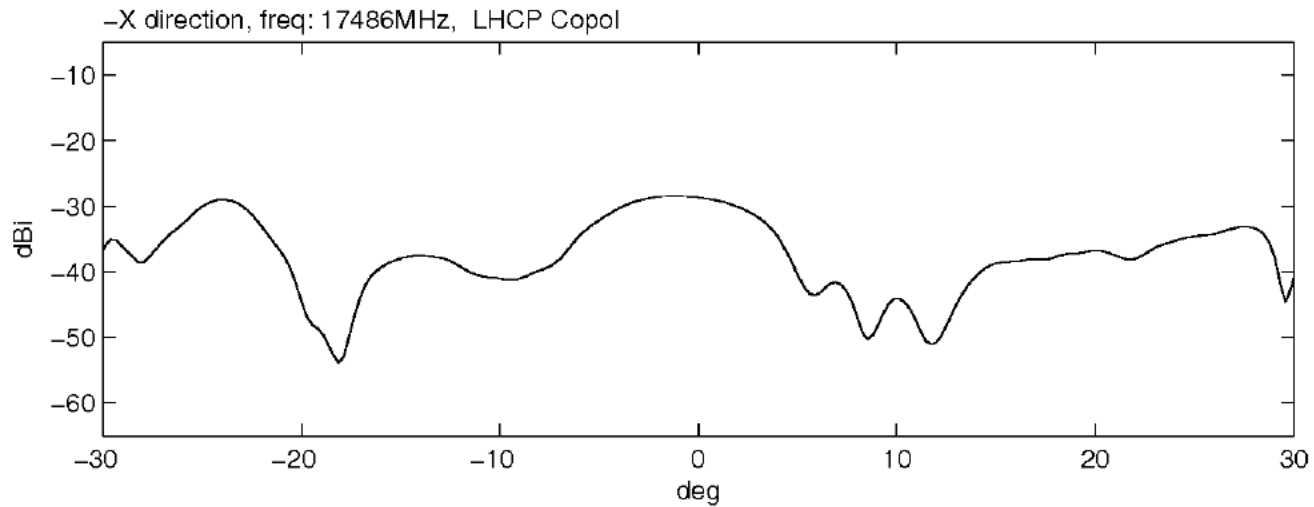

XZ-Plane, Yaw = 40 deg +x direction, Freq: 17486 MHz RHCP

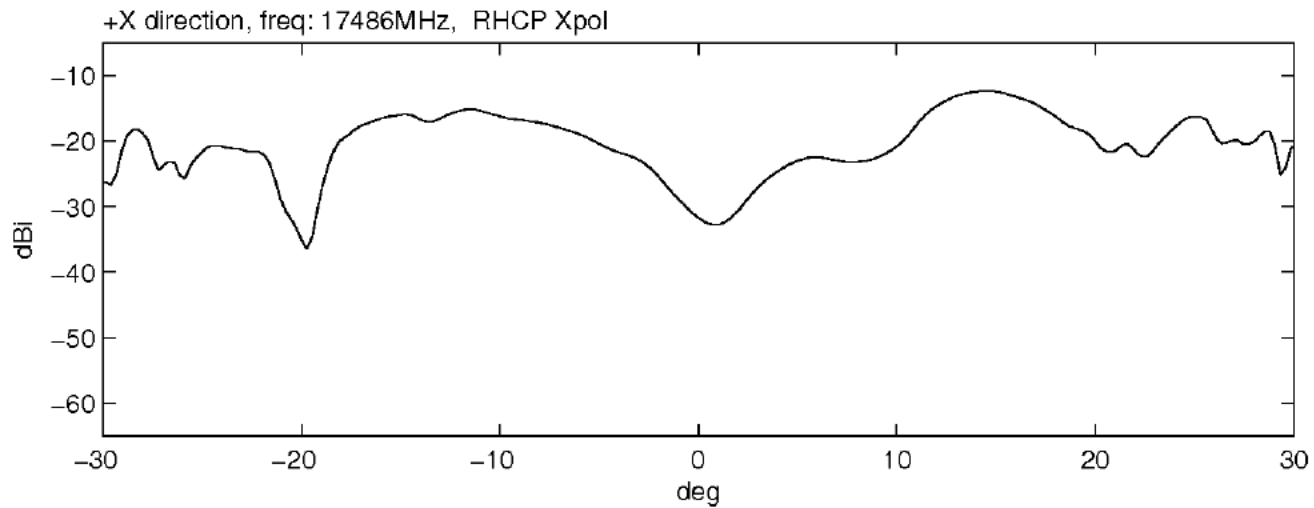
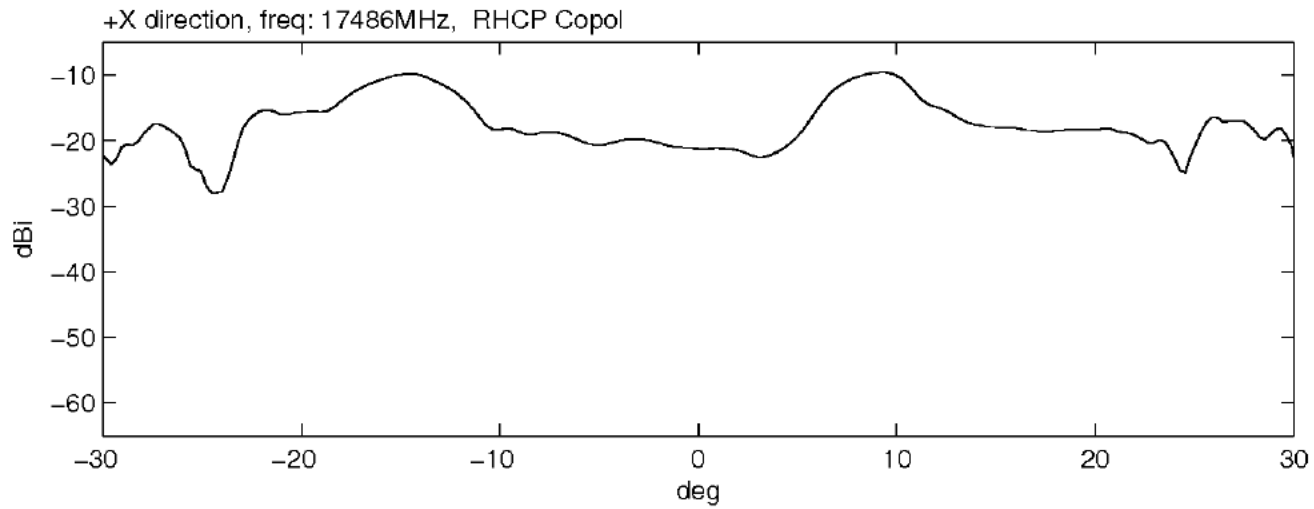

XZ-Plane, Yaw = 40 deg +x direction, Freq: 17486 MHz LHCP

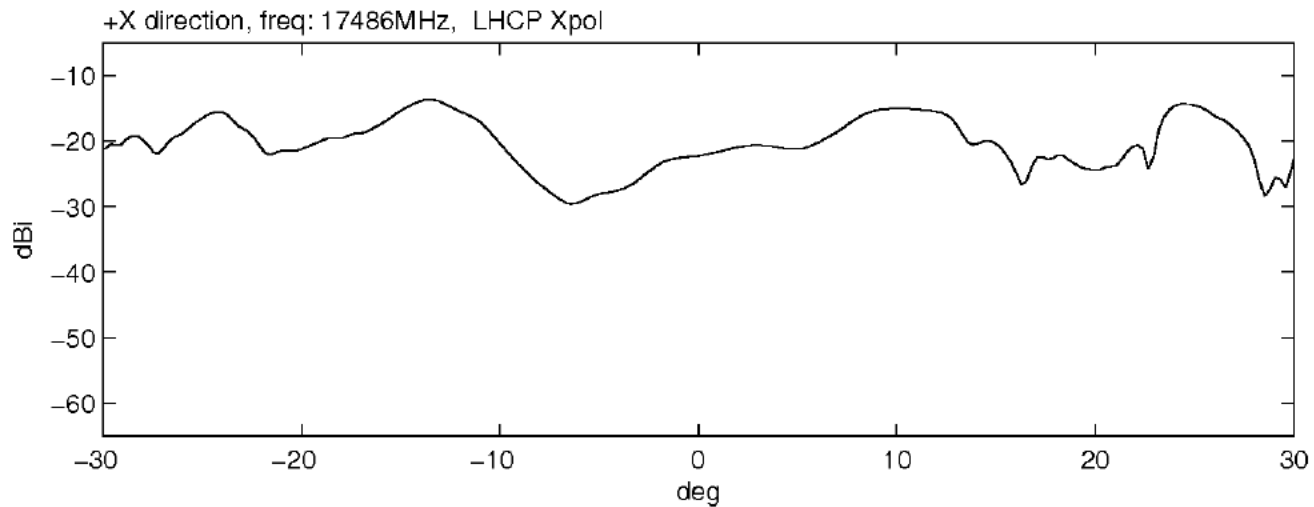
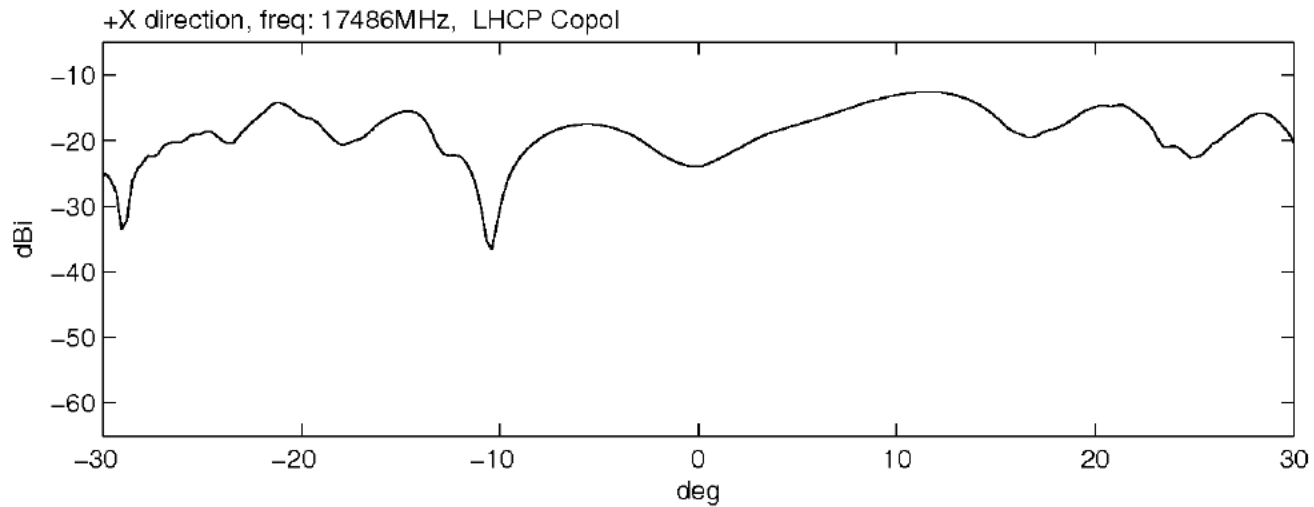

XZ-Plane, Yaw = 40 deg -x direction, Freq: 17486 MHz RHCP

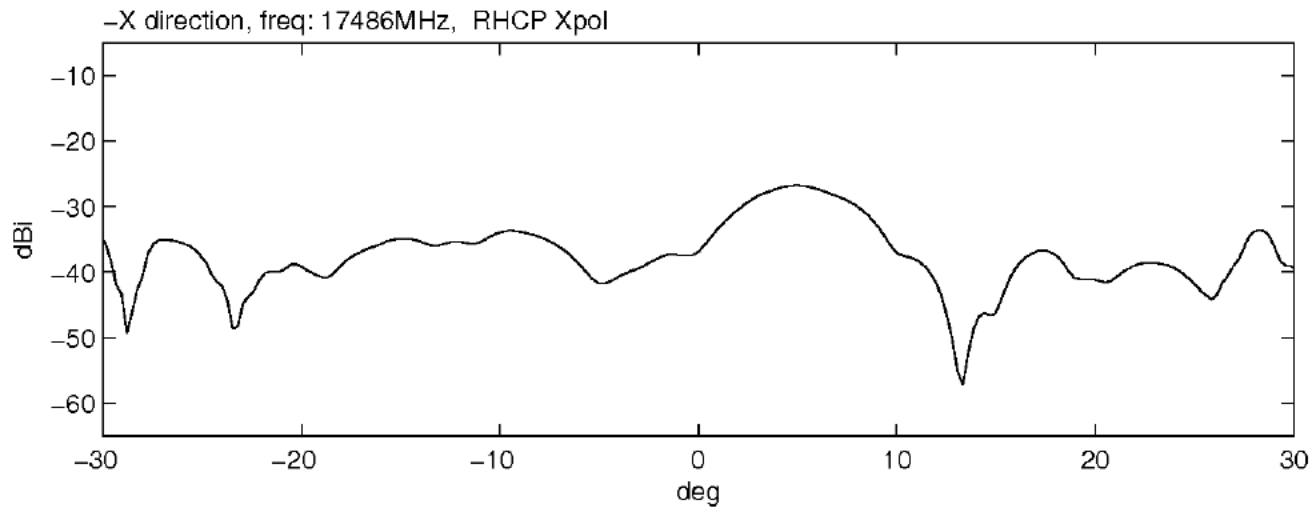
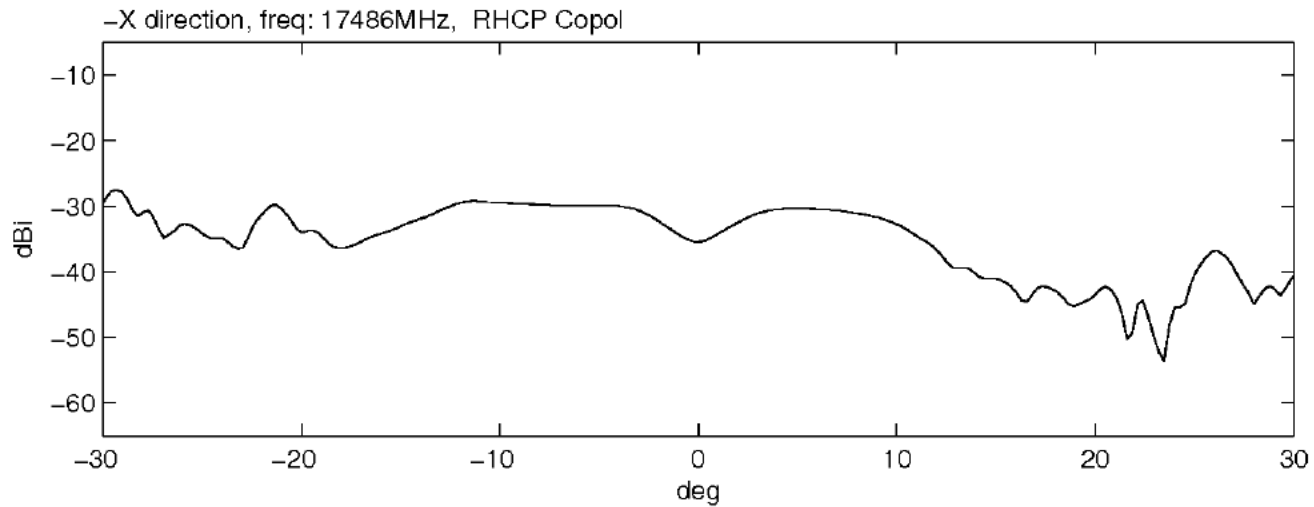

XZ-Plane, Yaw = 40 deg -x direction, Freq: 17486 MHz LHCP

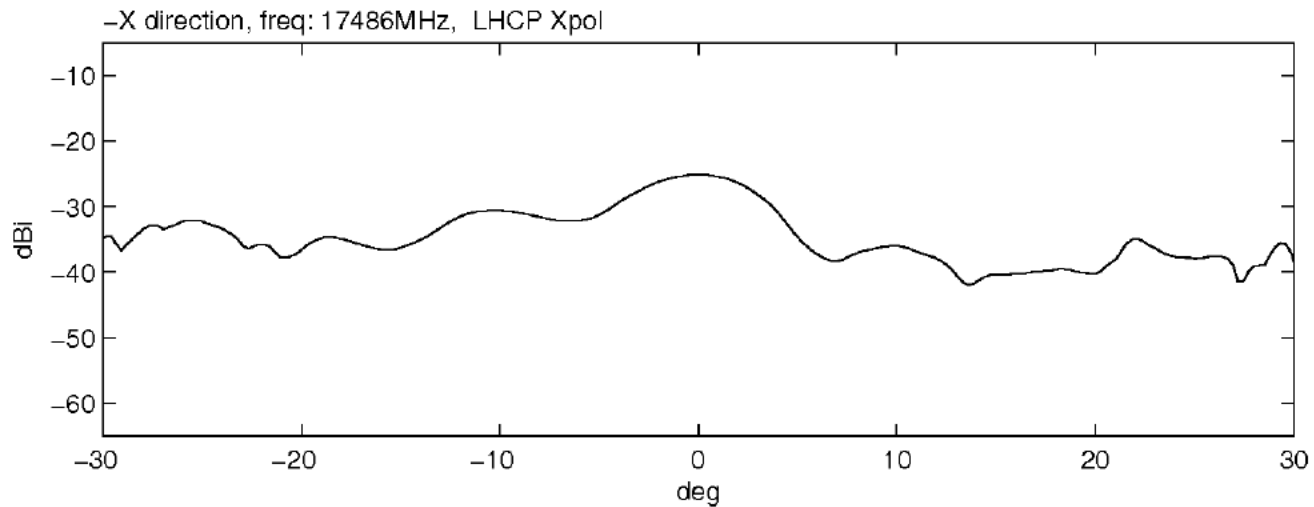
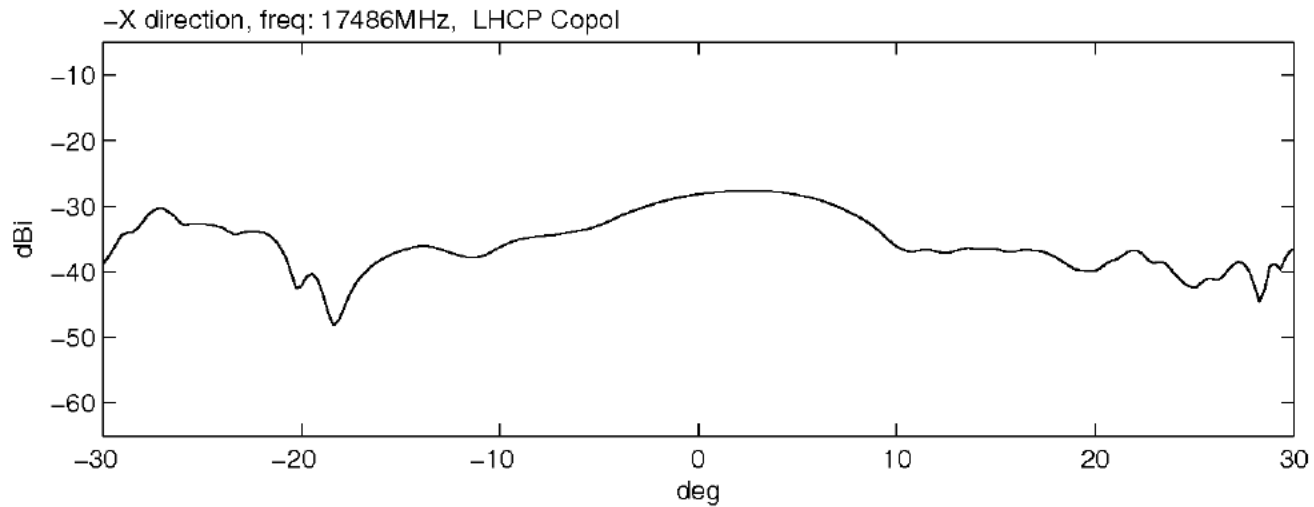

XZ-Plane, Yaw = 50 deg +x direction, Freq: 17486 MHz RHCP

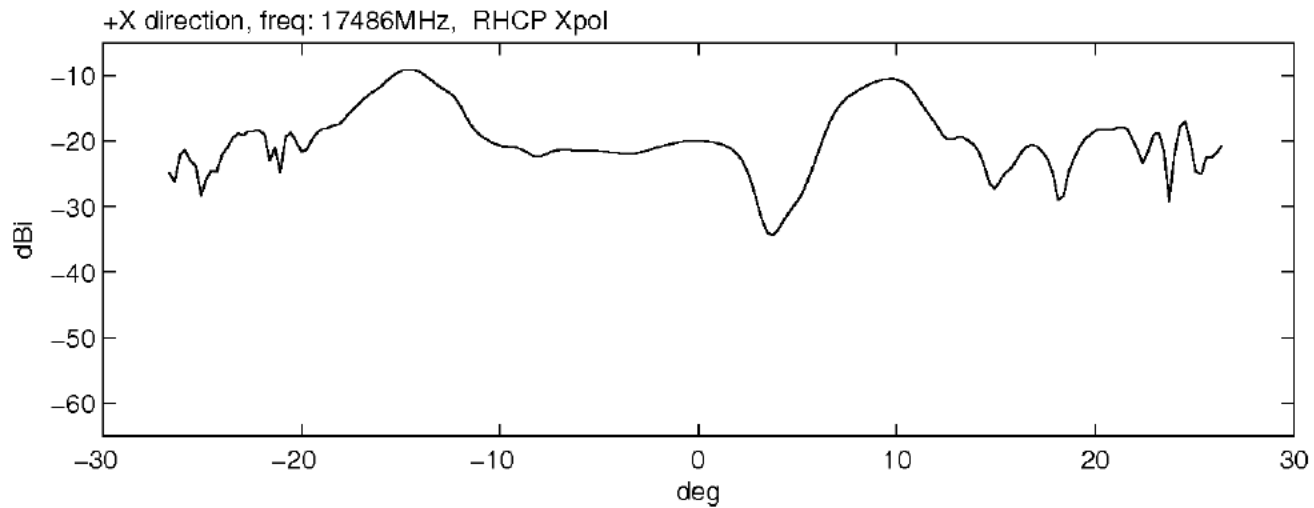
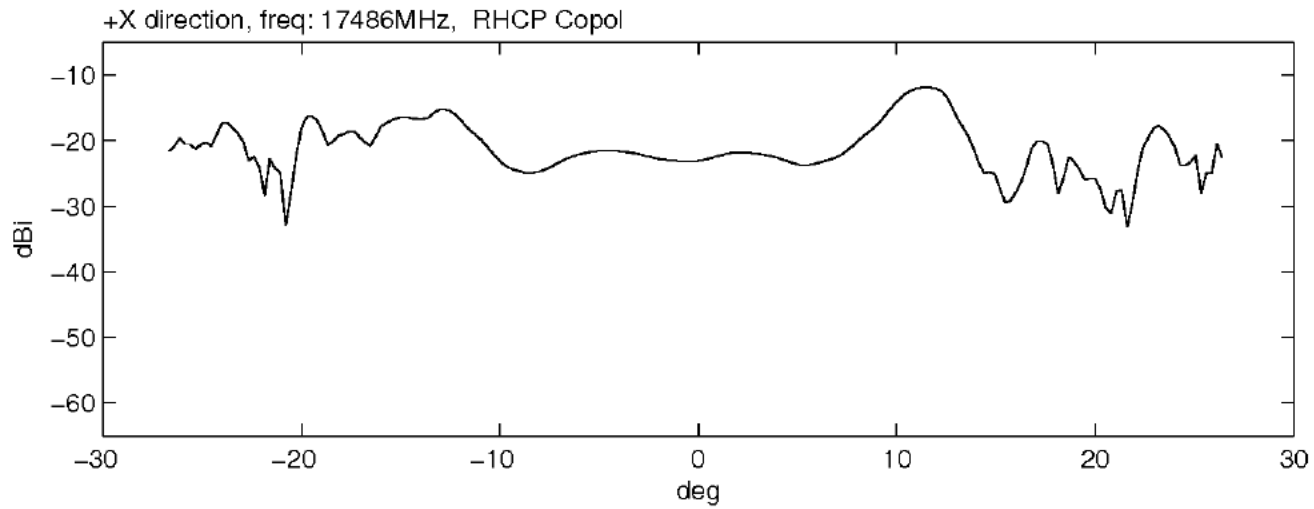

XZ-Plane, Yaw = 50 deg +x direction, Freq: 17486 MHz LHCP

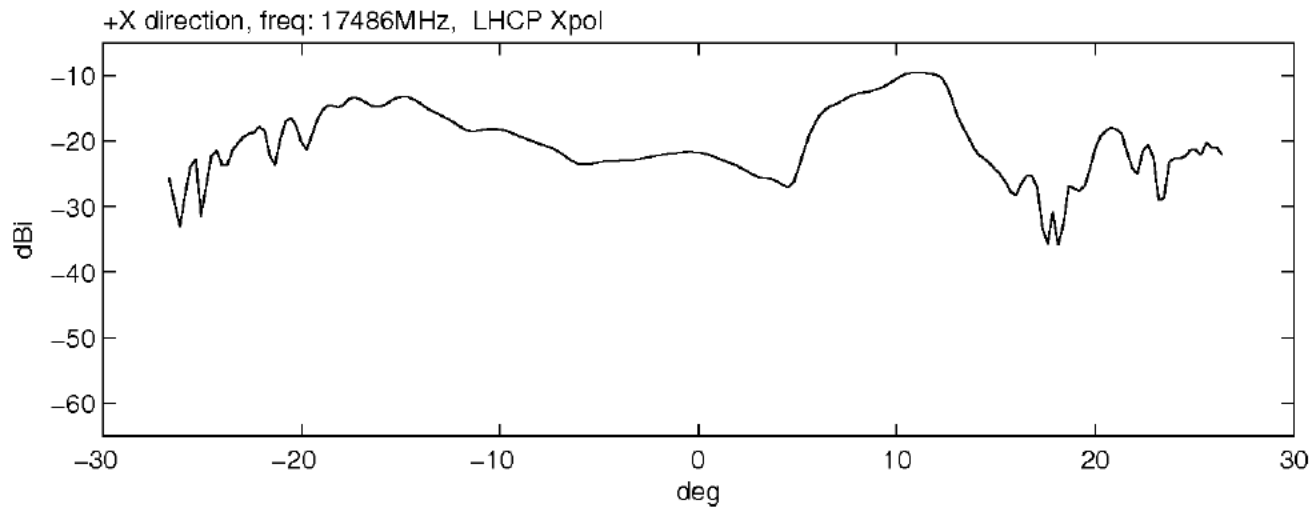
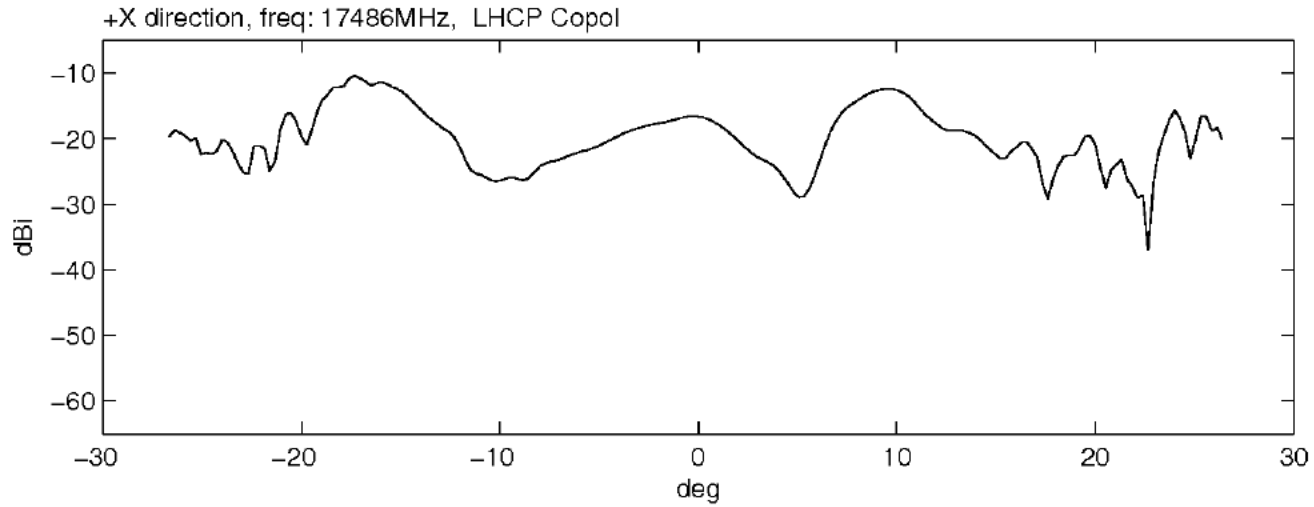

XZ-Plane, Yaw = 50 deg -x direction, Freq: 17486 MHz RHCP

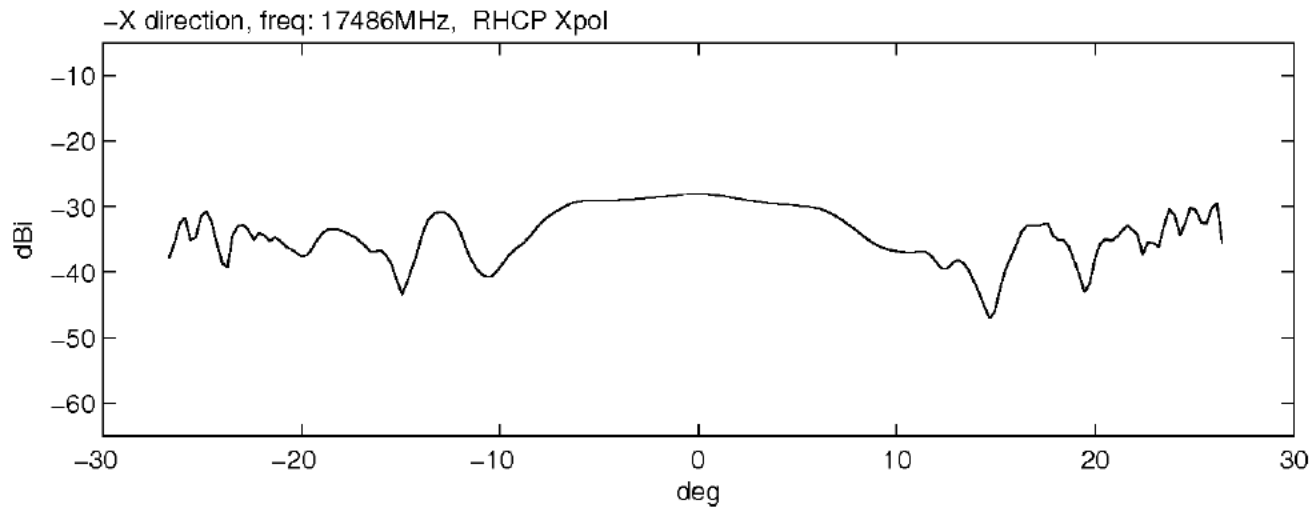
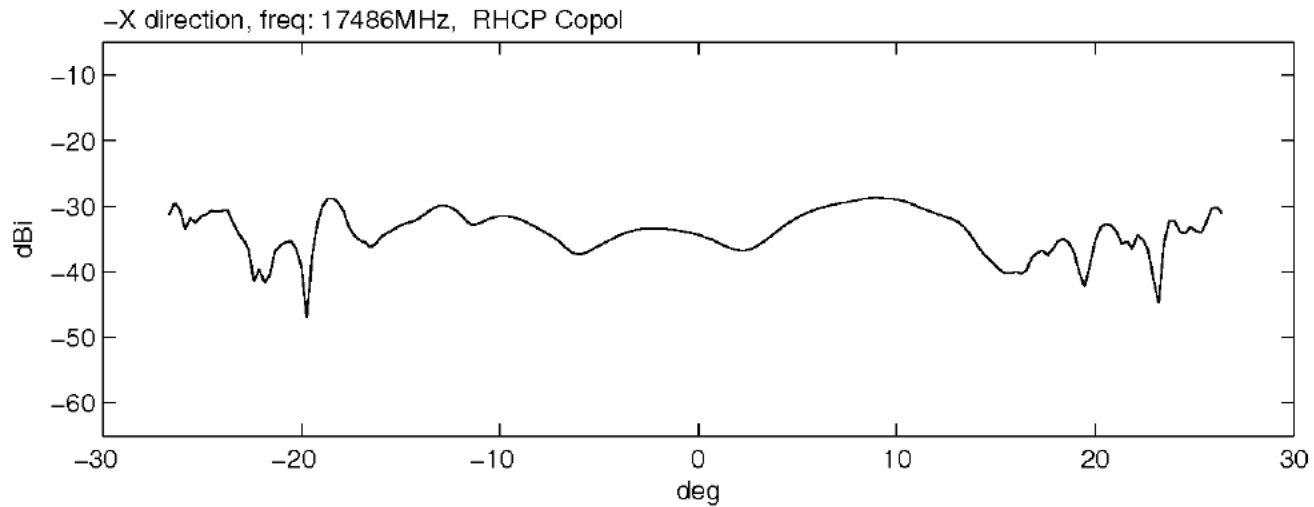

XZ-Plane, Yaw = 50 deg -x direction, Freq: 17486 MHz LHCP

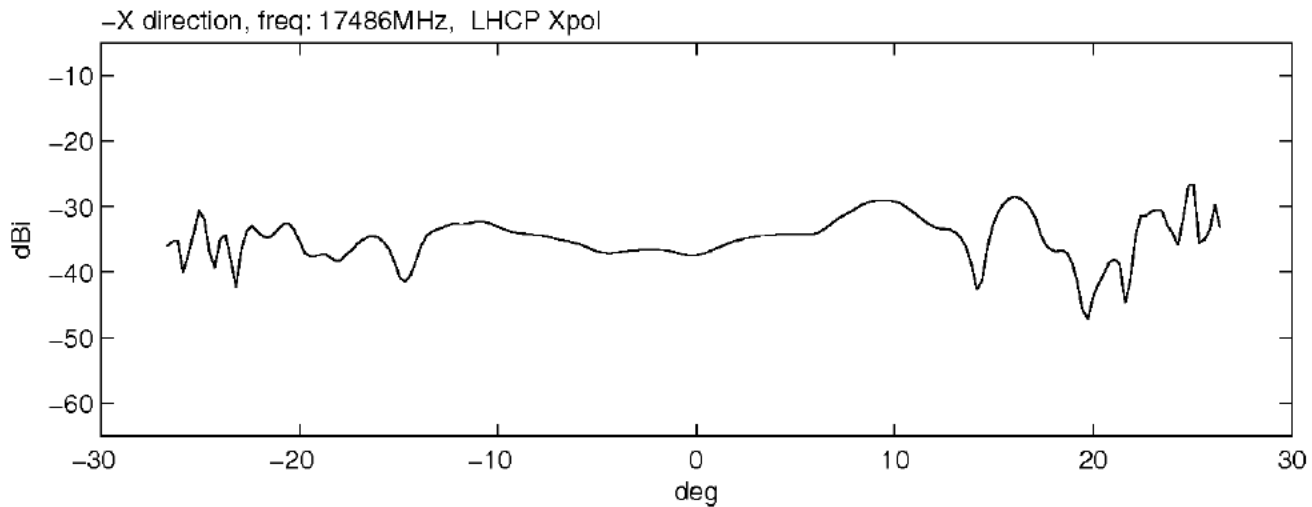
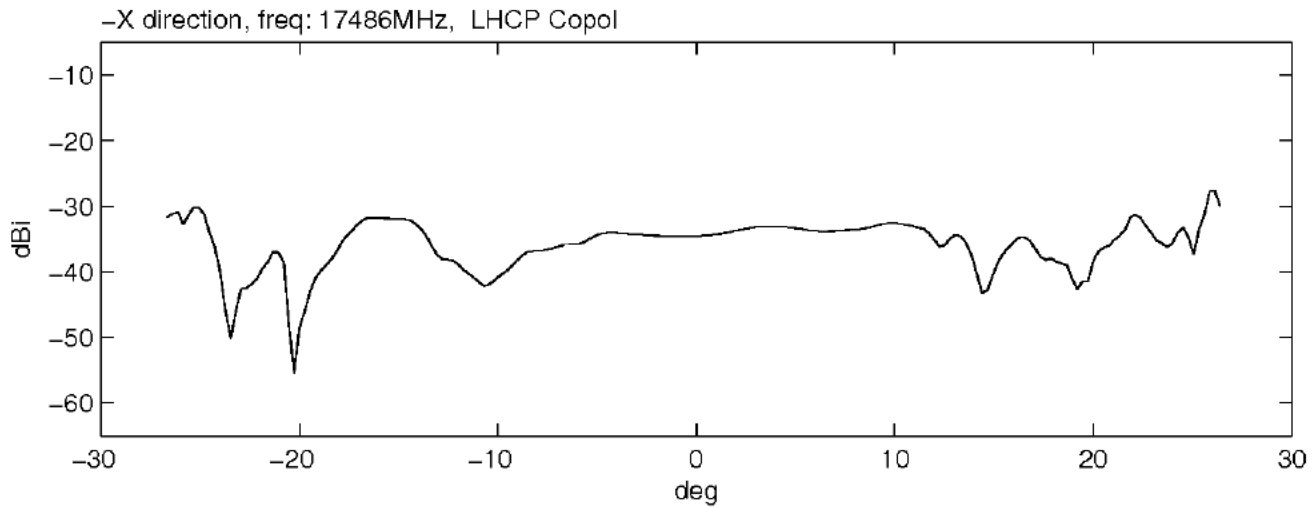

XZ-Plane, Yaw = -10 deg +x direction, Freq: 17486 MHz RHCP

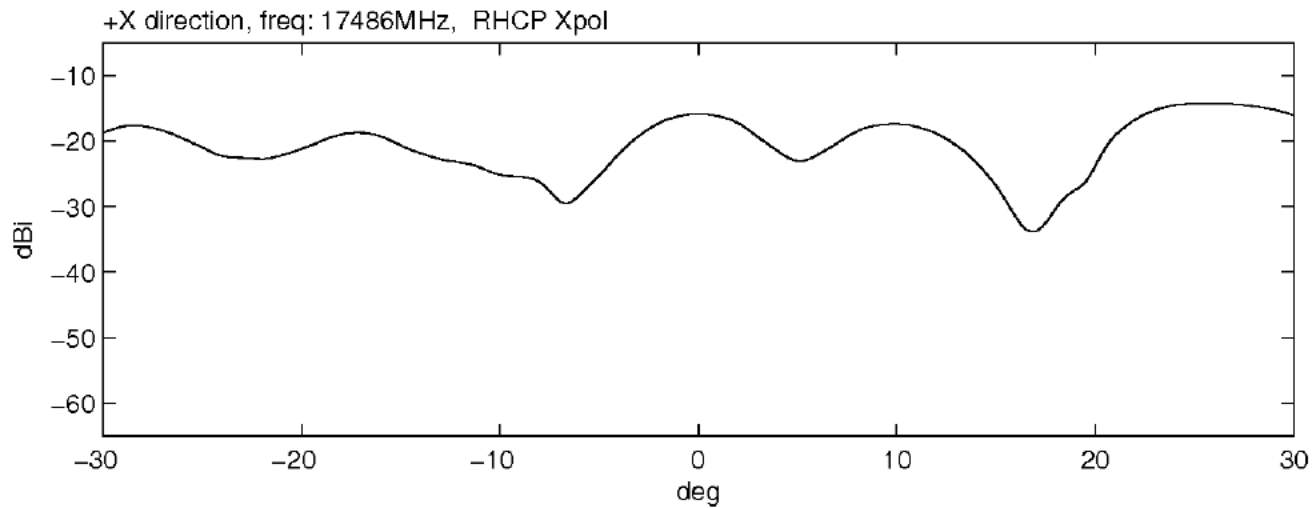
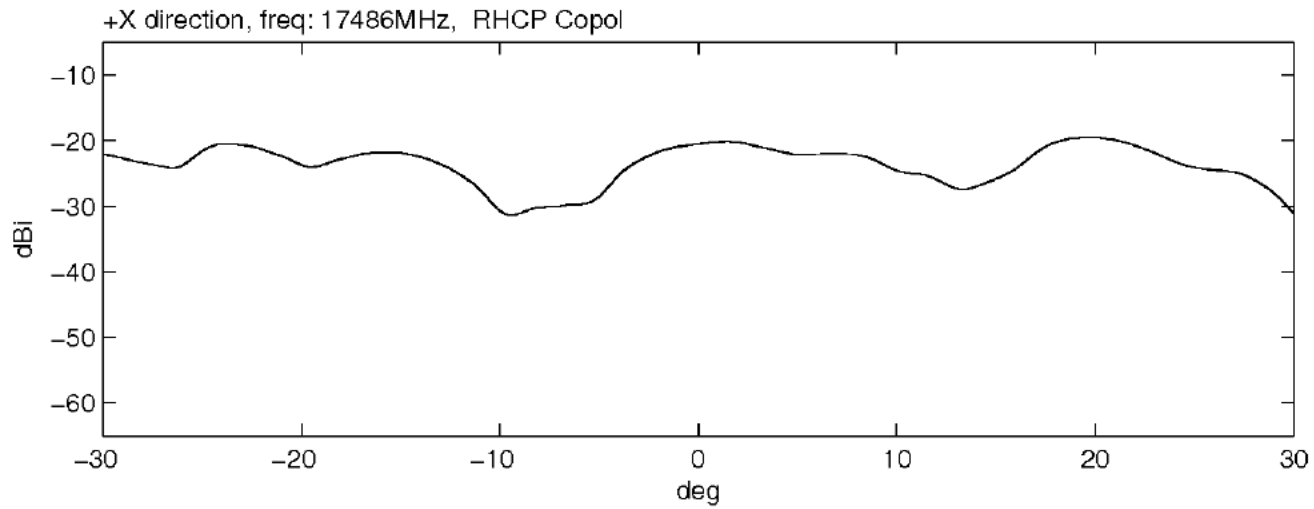

XZ-Plane, Yaw = -10 deg +x direction, Freq: 17486 MHz LHCP

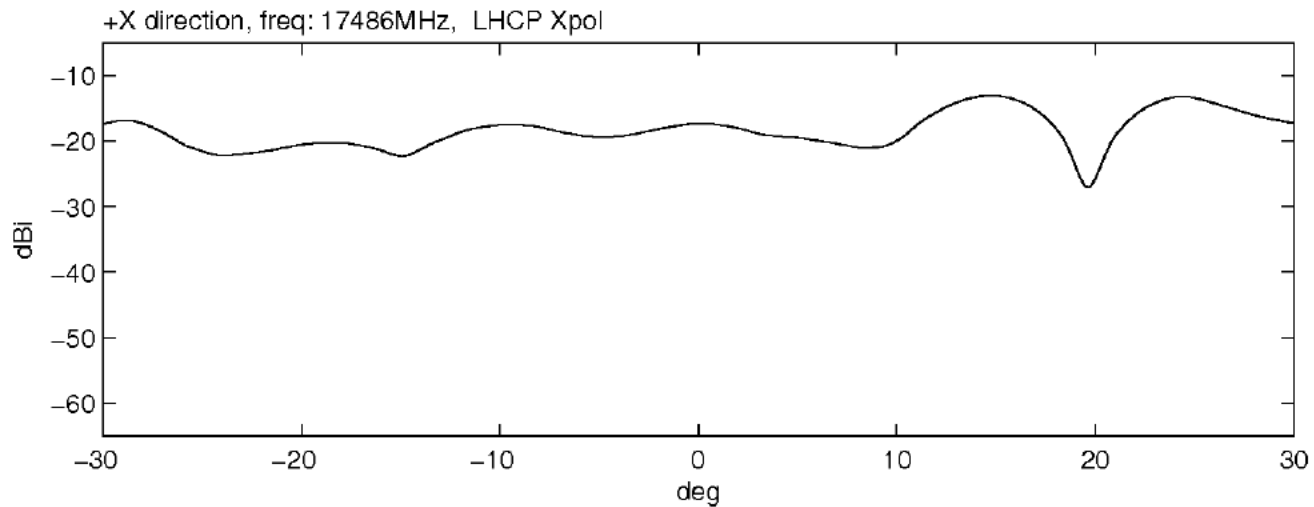
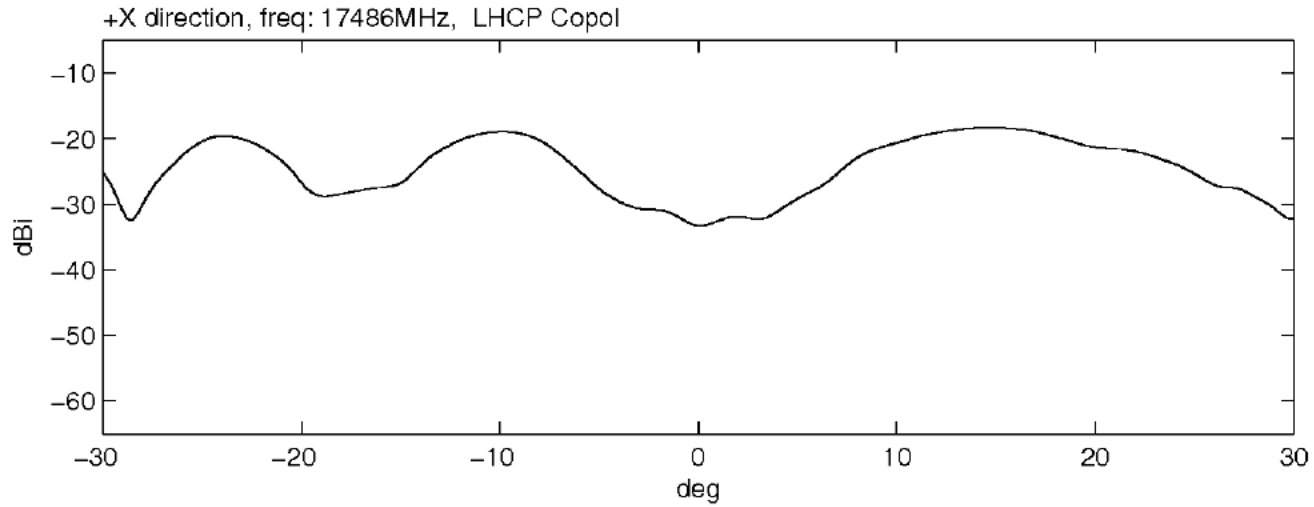

XZ-Plane, Yaw = -10 deg -x direction, Freq: 17486 MHz RHCP

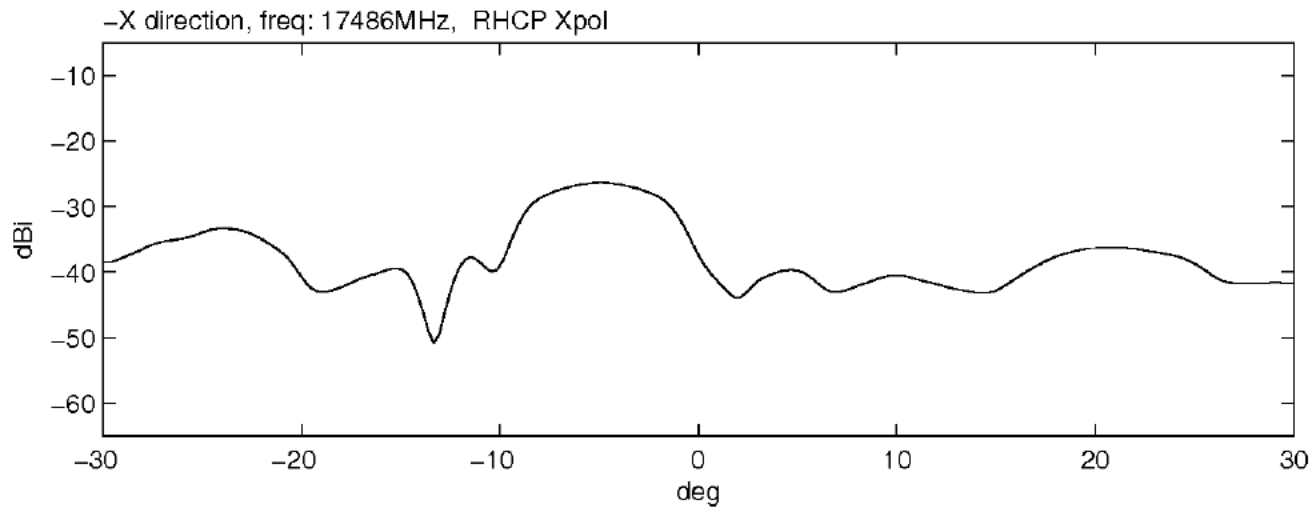
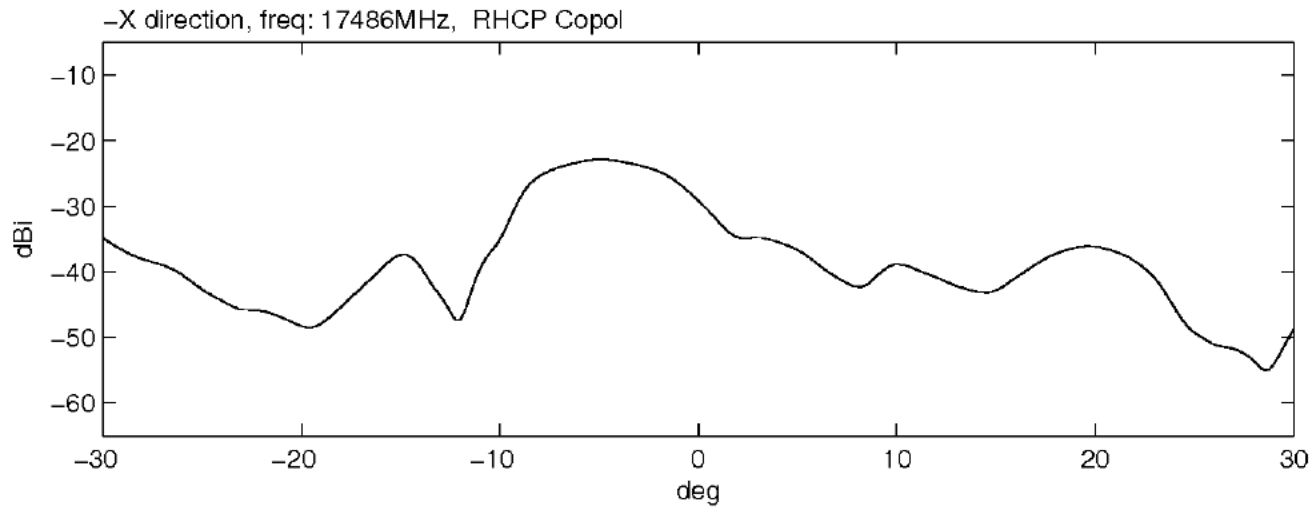

XZ-Plane, Yaw = -10 deg -x direction, Freq: 17486 MHz LHCP

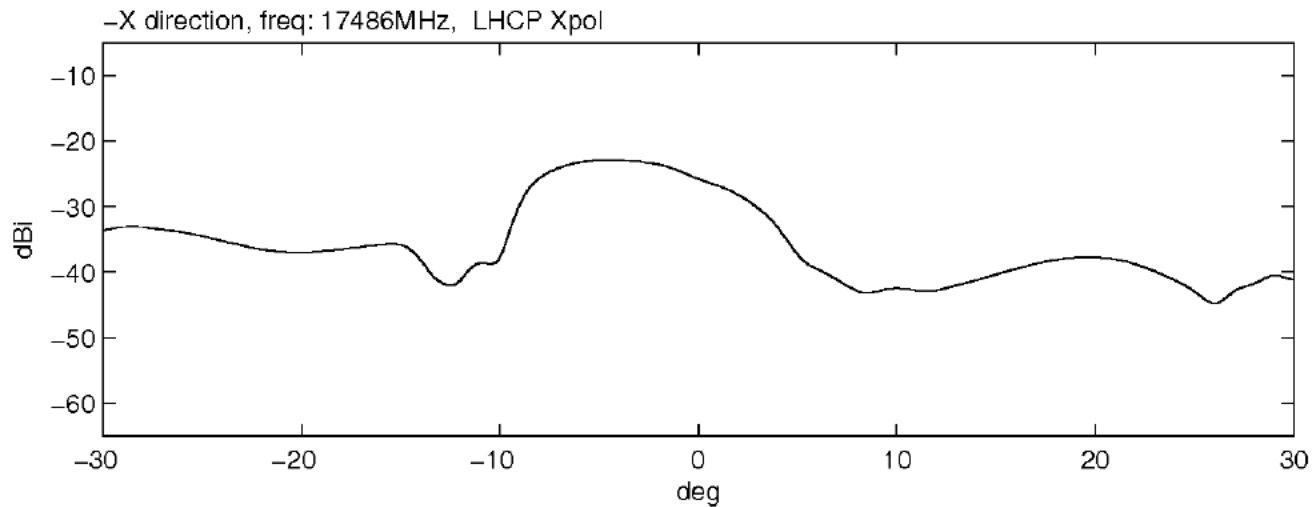
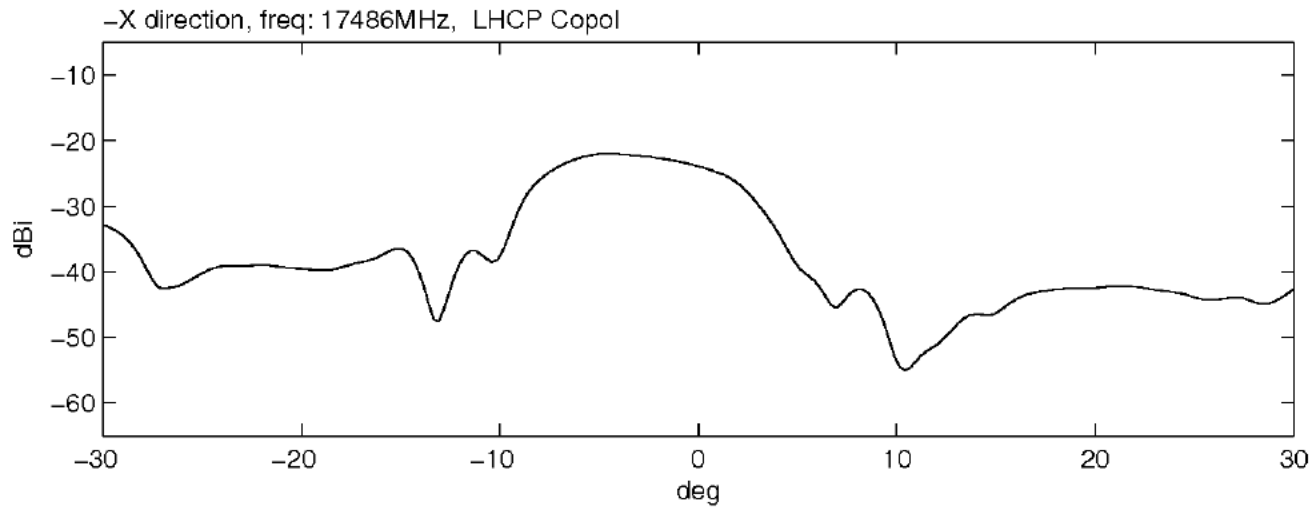

XZ-Plane, Yaw = -20 deg +x direction, Freq: 17486 MHz RHCP

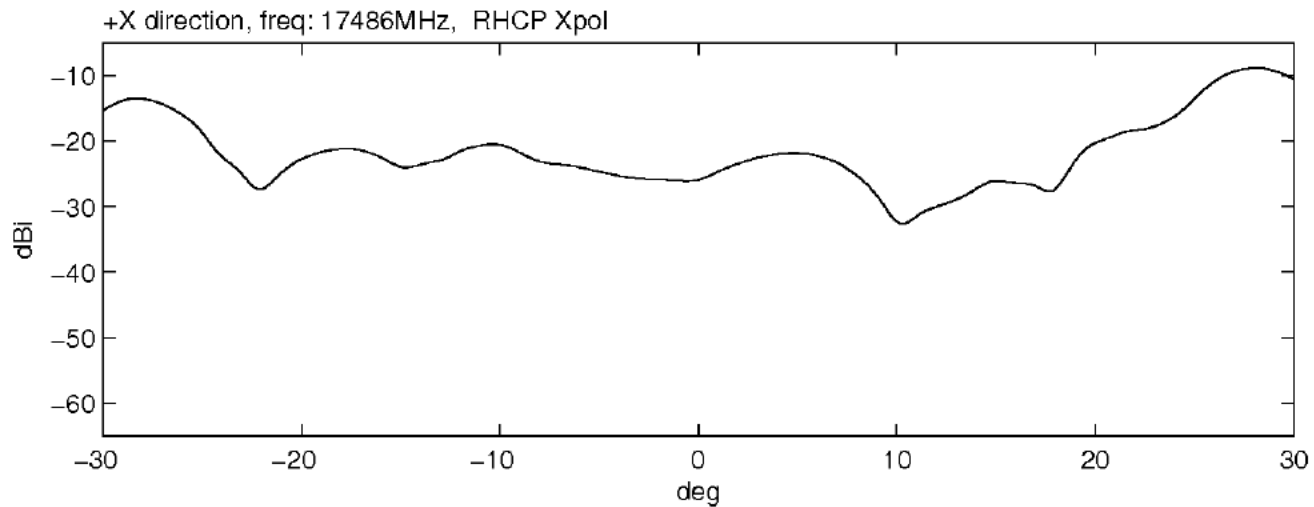
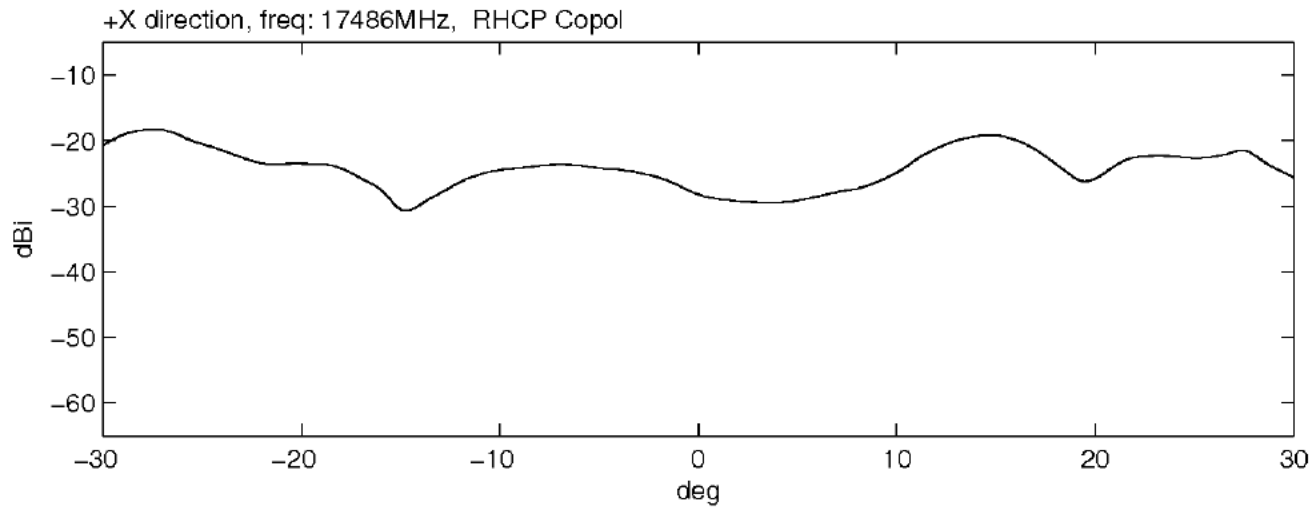

XZ-Plane, Yaw = -20 deg +x direction, Freq: 17486 MHz LHCP

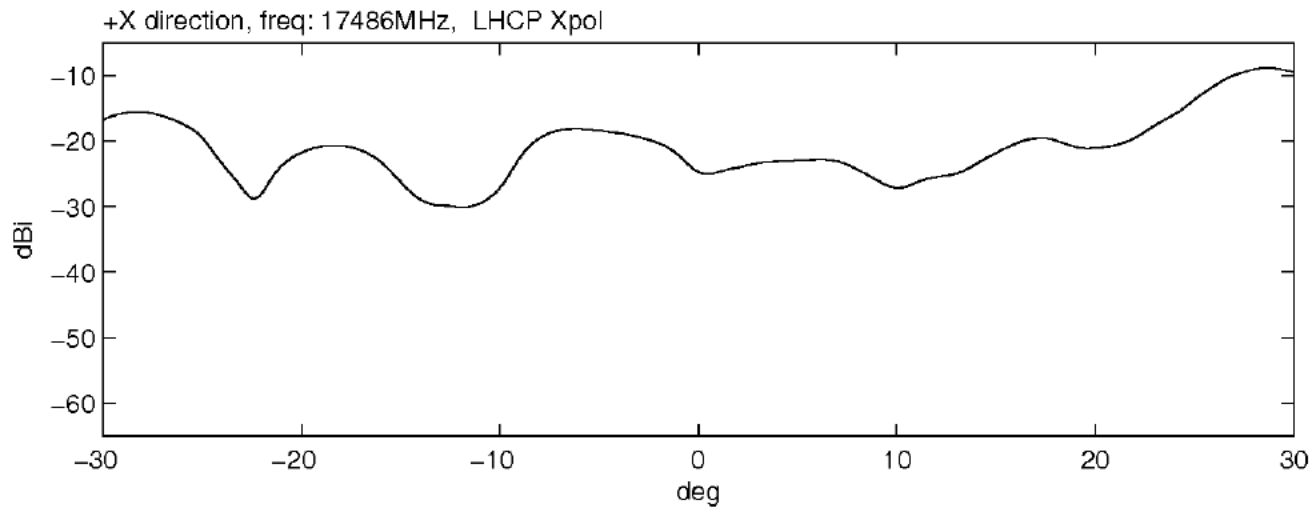
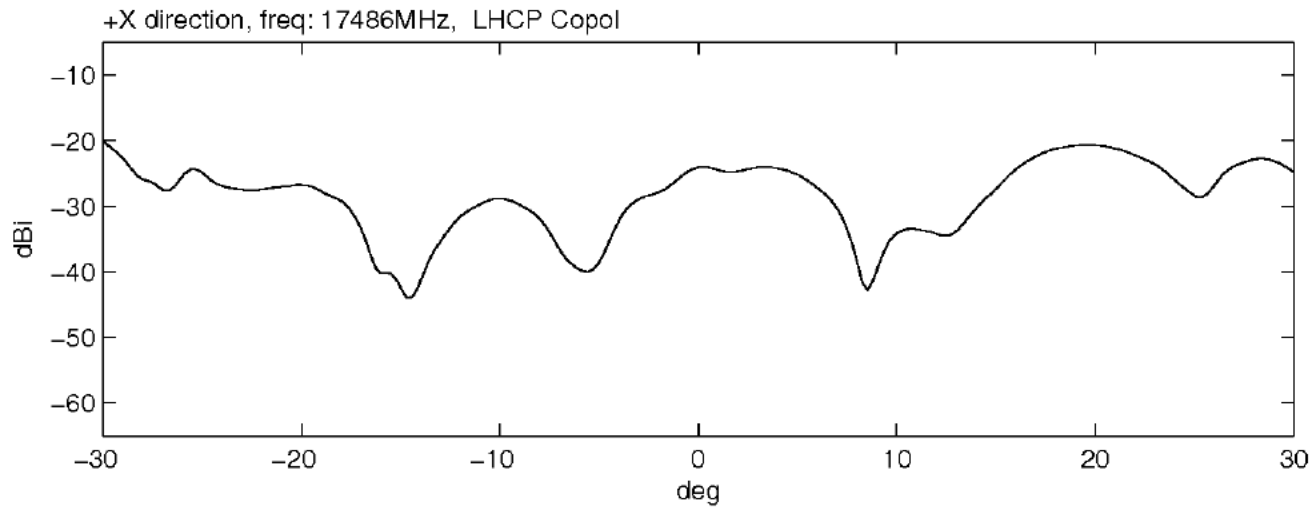

XZ-Plane, Yaw = -20 deg -x direction, Freq: 17486 MHz RHCP

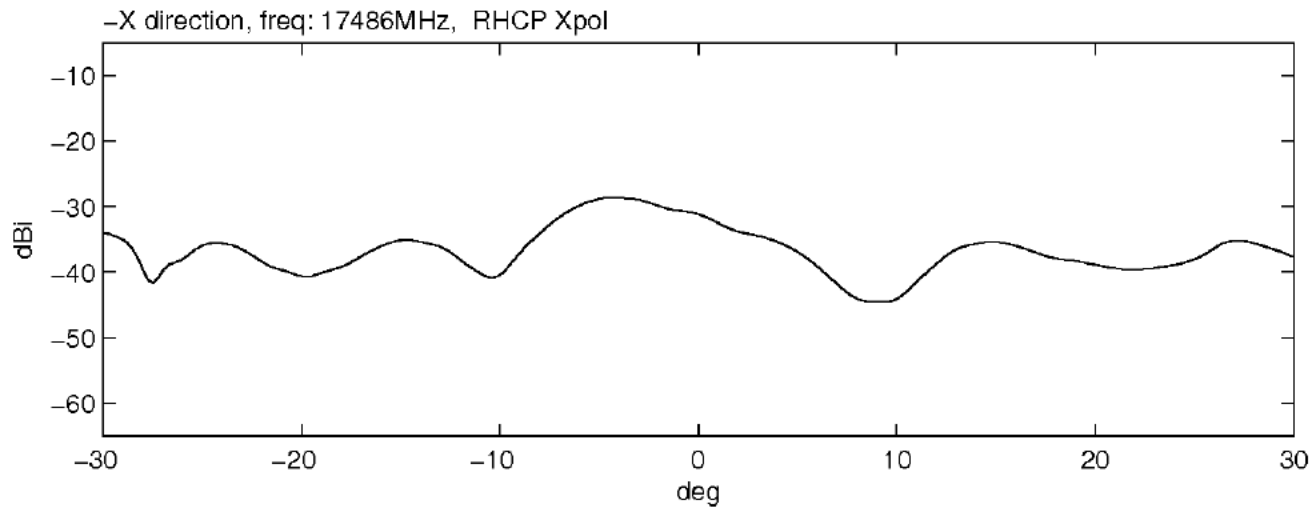
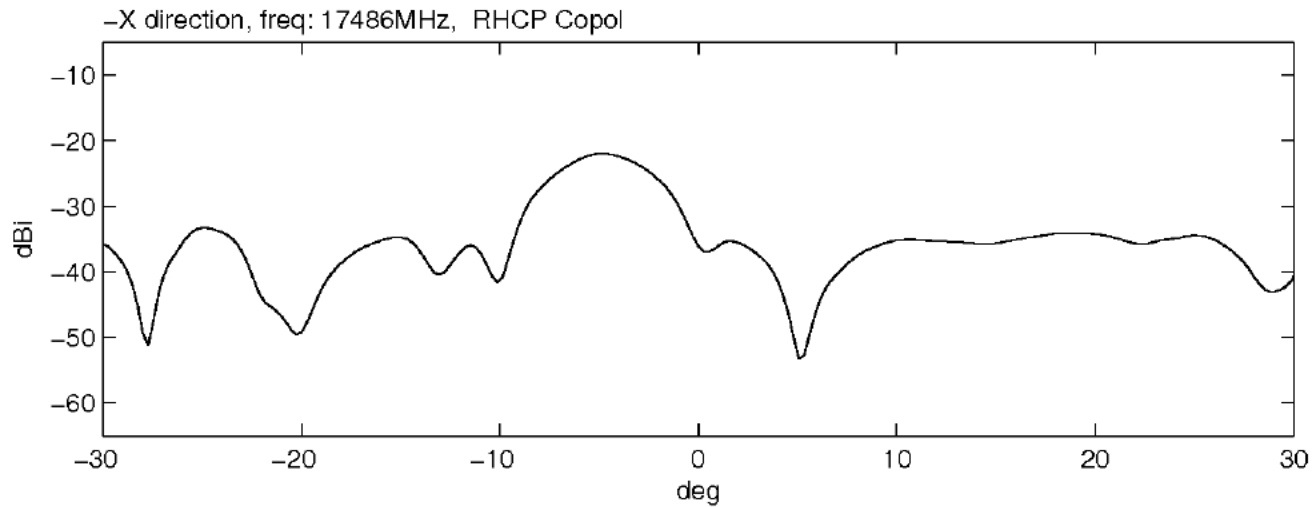

XZ-Plane, Yaw = -20 deg -x direction, Freq: 17486 MHz LHCP

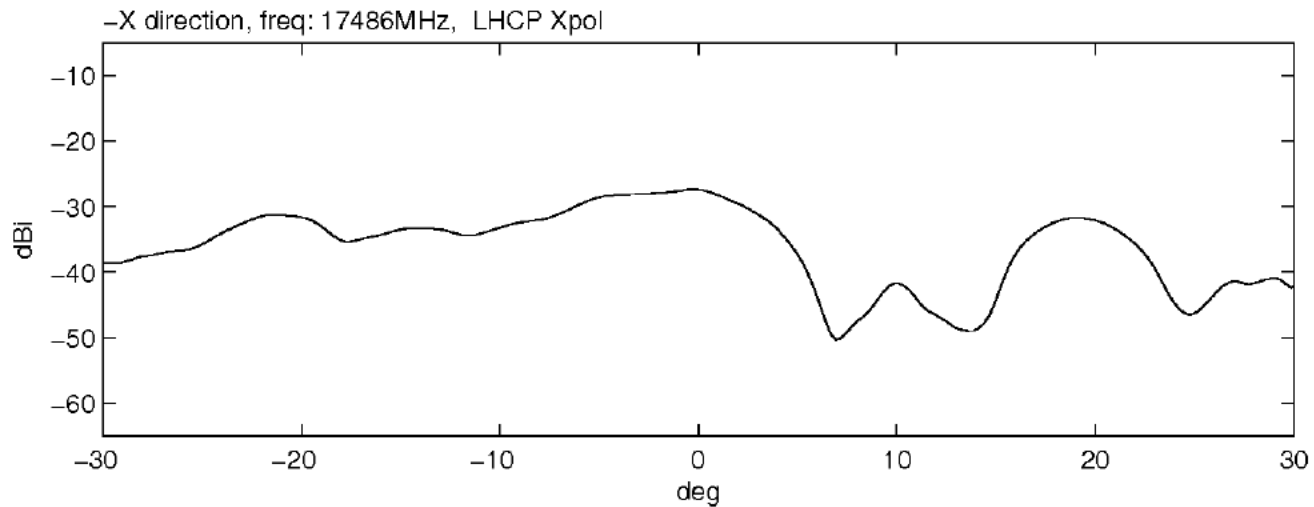
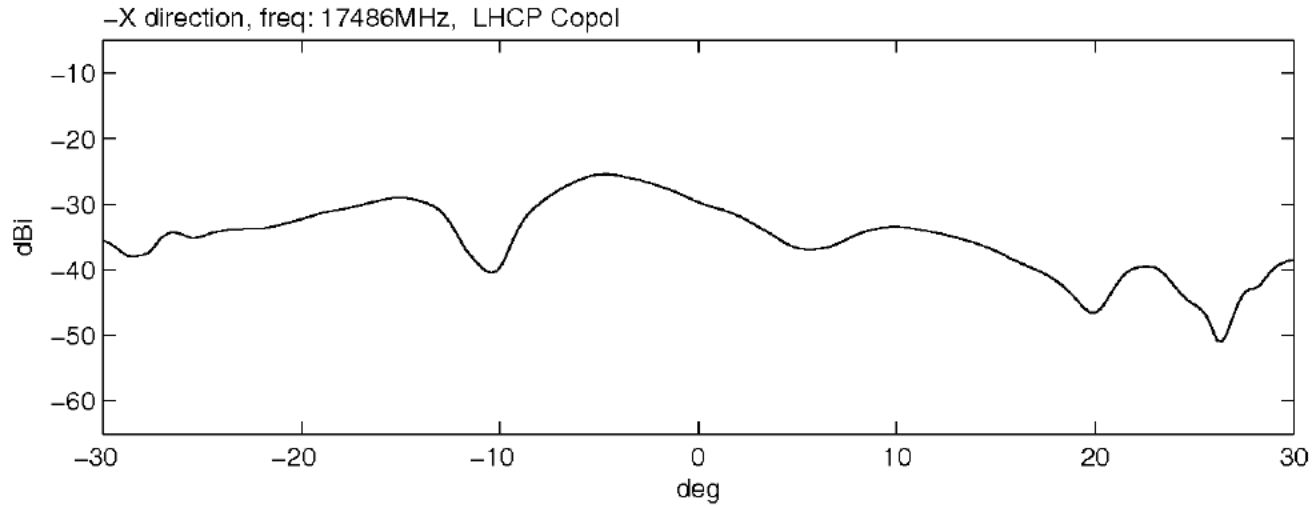

XZ-Plane, Yaw = -30 deg +x direction, Freq: 17486 MHz RHCP

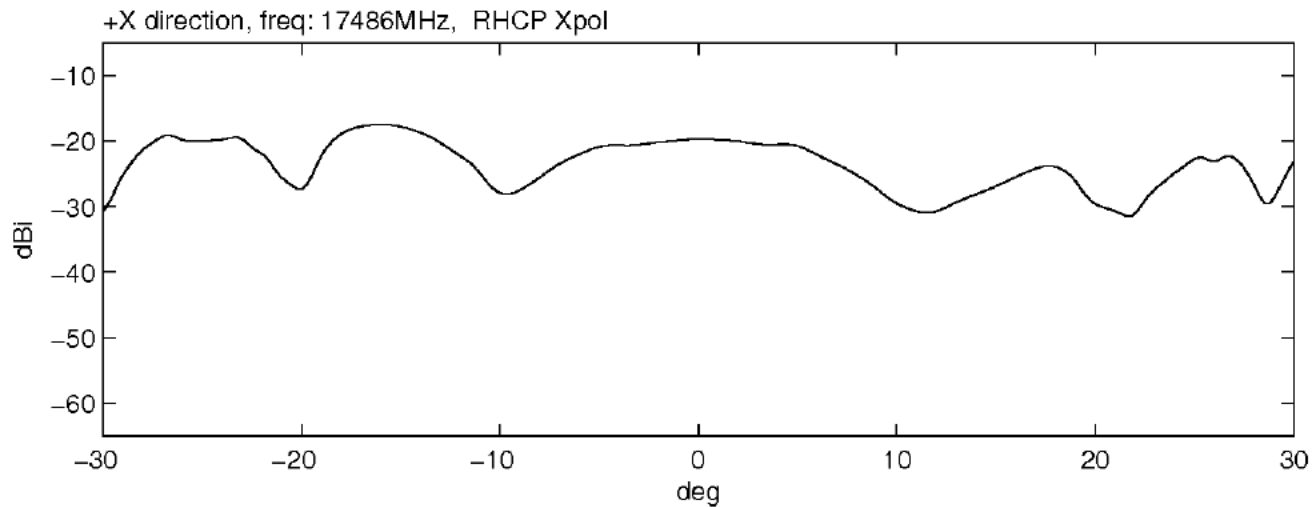
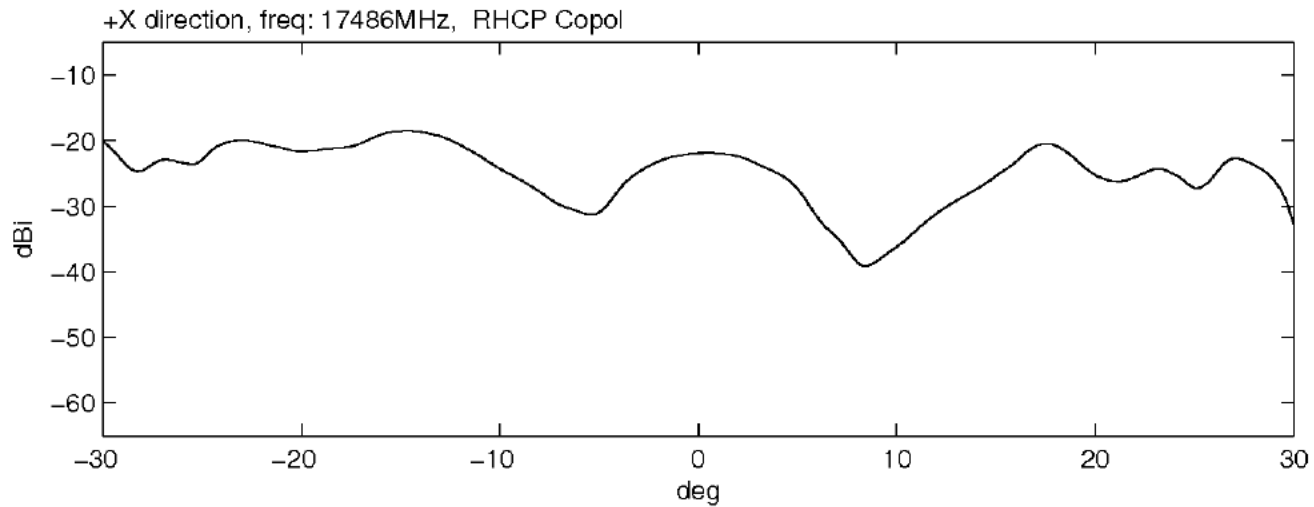

XZ-Plane, Yaw = -30 deg +x direction, Freq: 17486 MHz LHCP

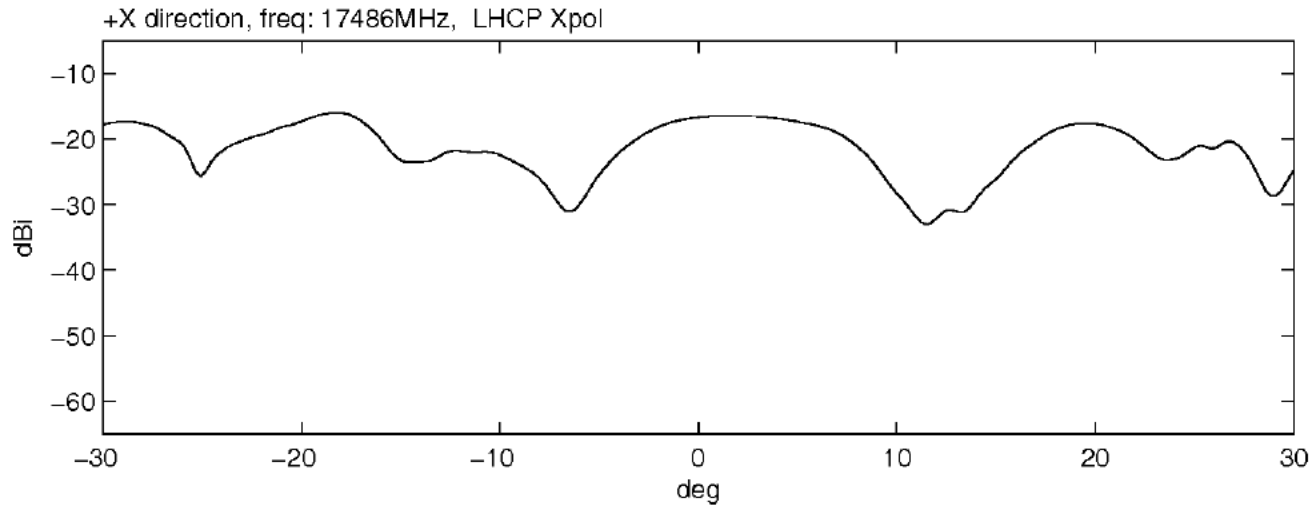
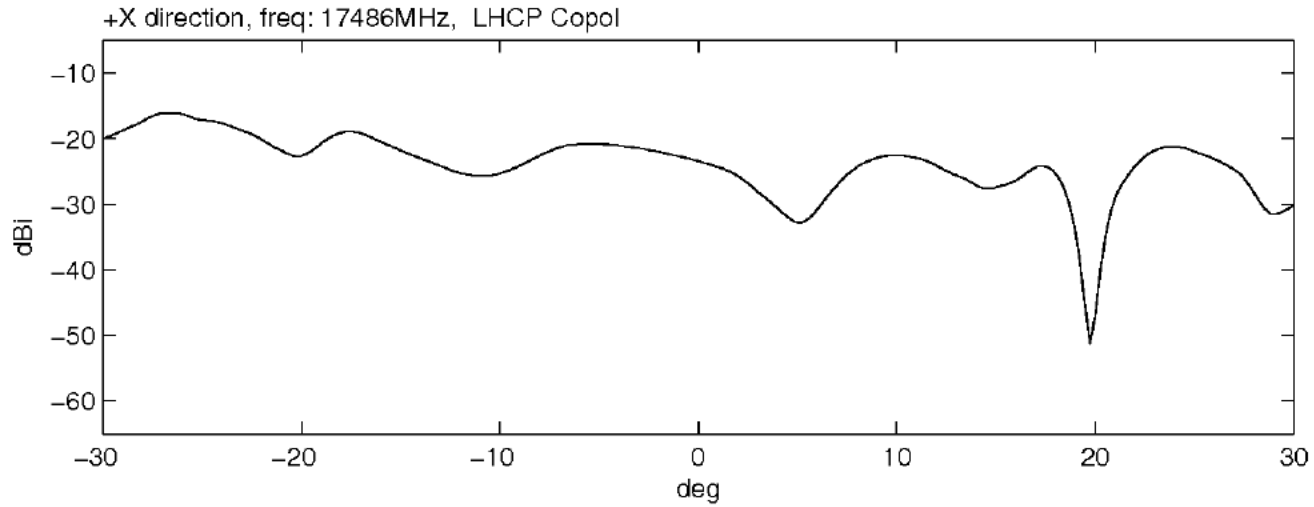

XZ-Plane, Yaw = -30 deg -x direction, Freq: 17486 MHz RHCP

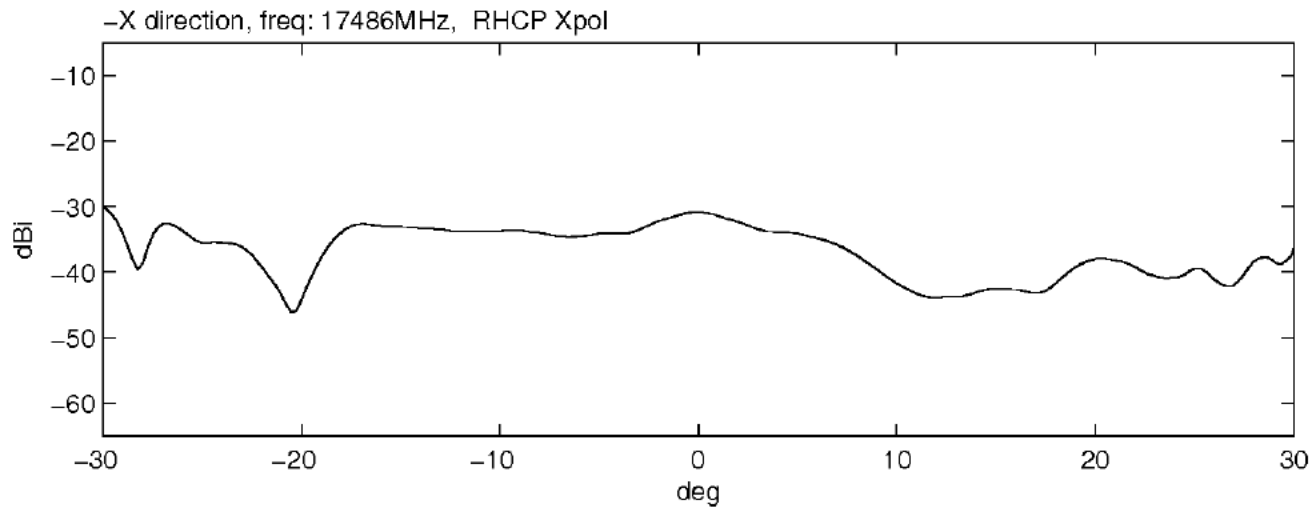
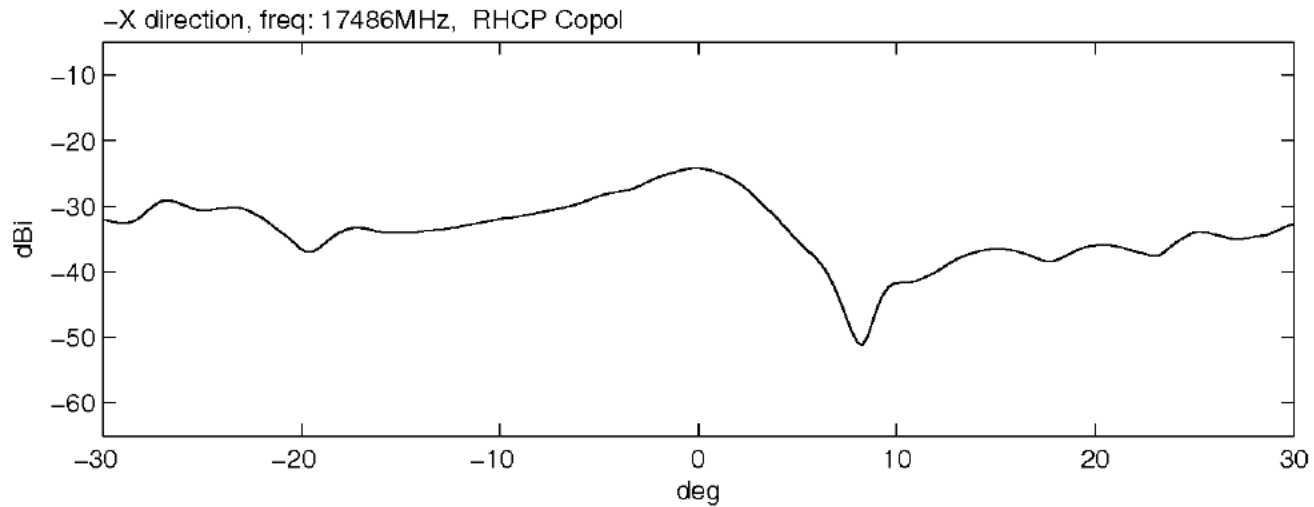

XZ-Plane, Yaw = -30 deg -x direction, Freq: 17486 MHz LHCP

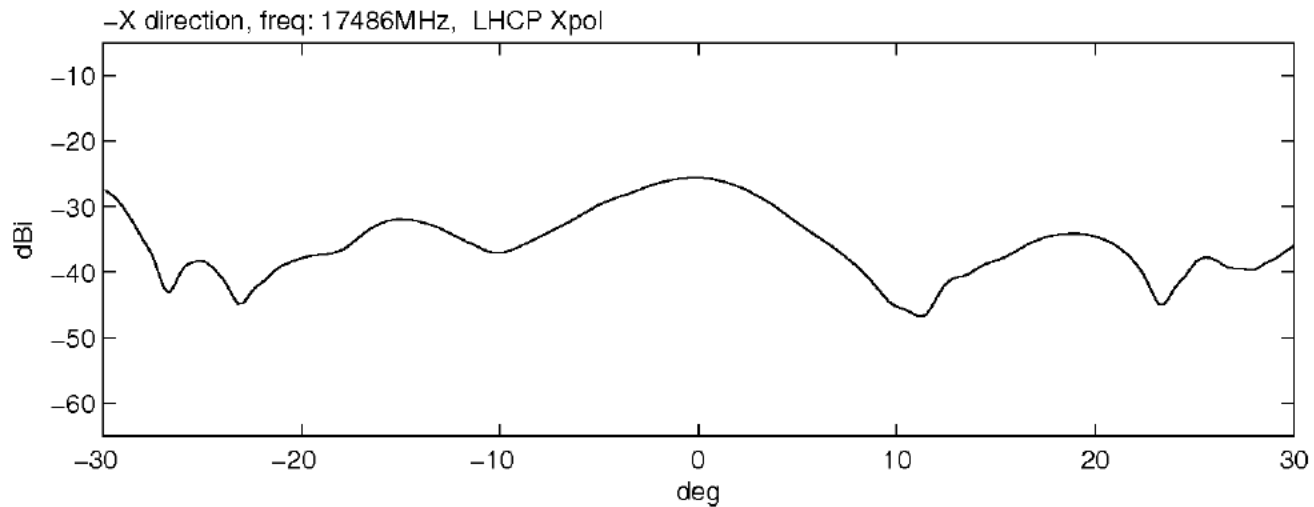
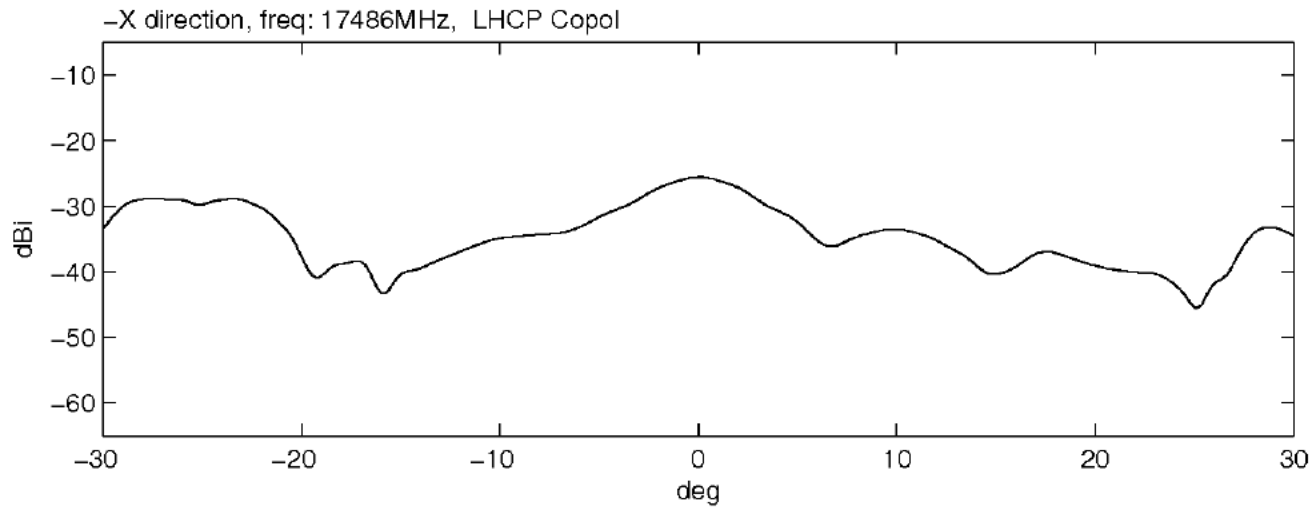

XZ-Plane, Yaw = -40 deg +x direction, Freq: 17486 MHz RHCP

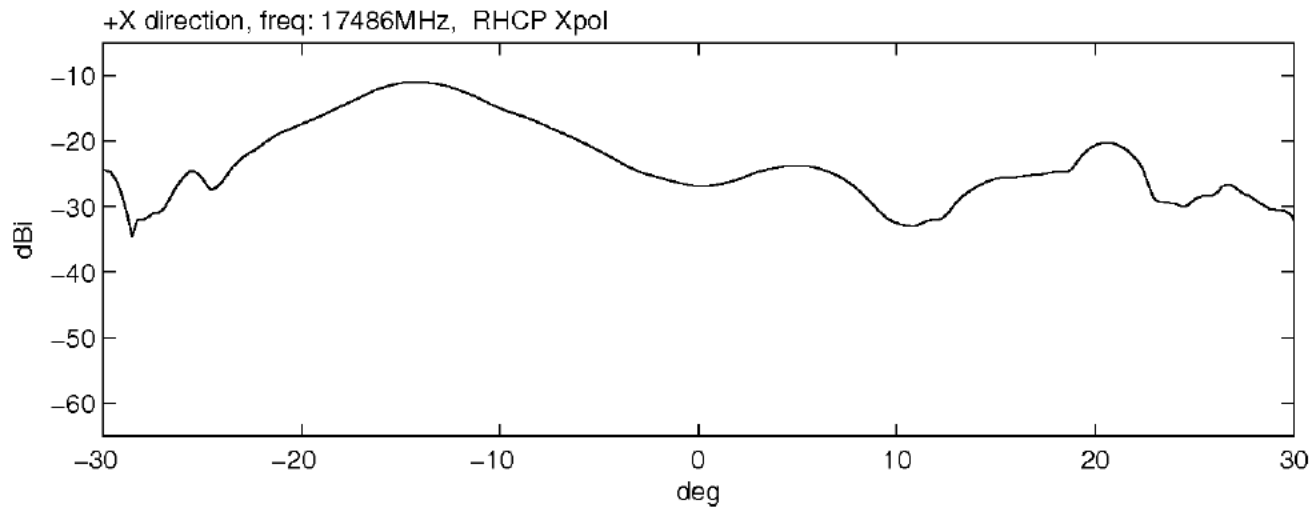
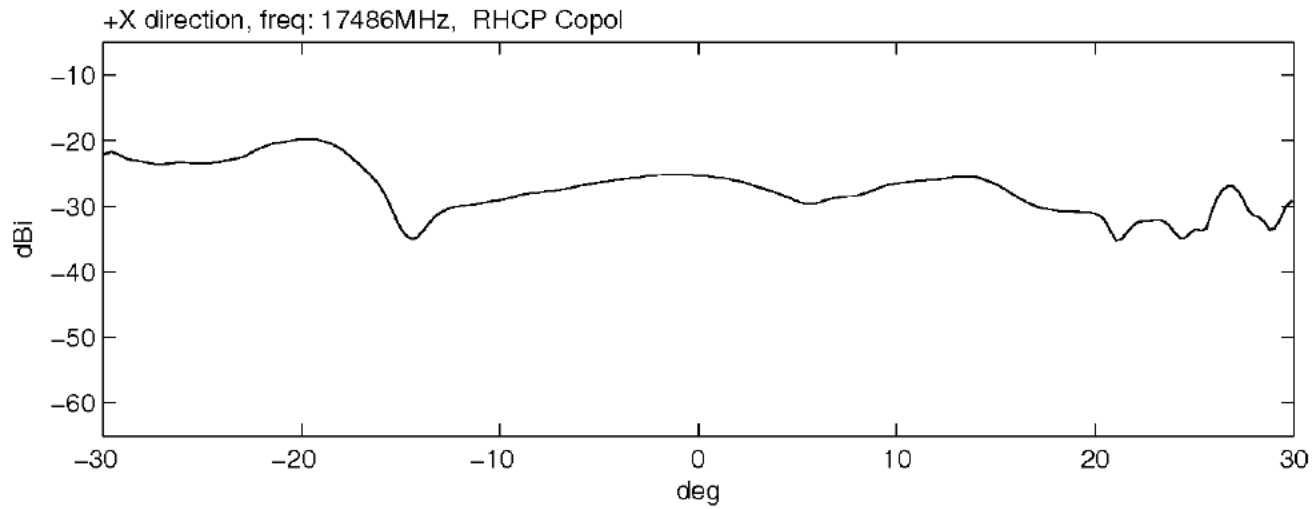

XZ-Plane, Yaw = -40 deg +x direction, Freq: 17486 MHz LHCP

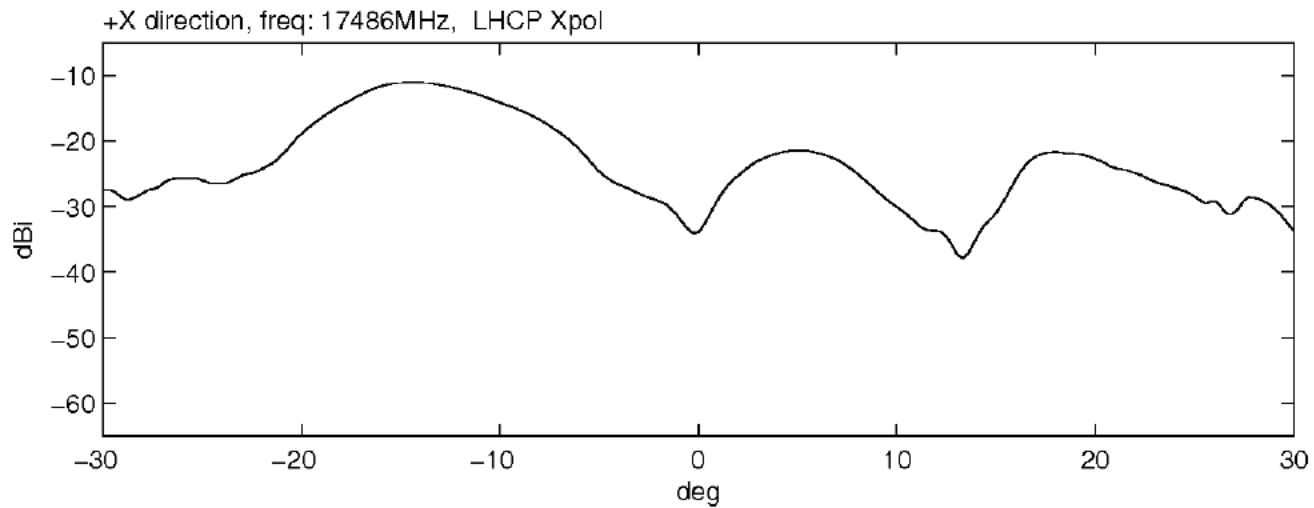
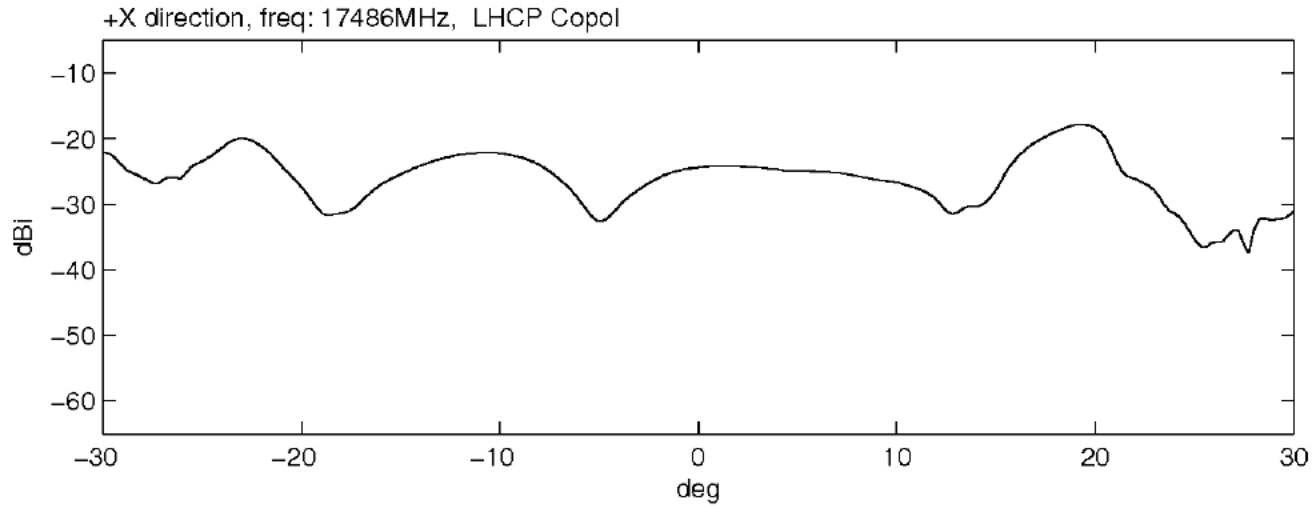

XZ-Plane, Yaw = -40 deg -x direction, Freq: 17486 MHz RHCP

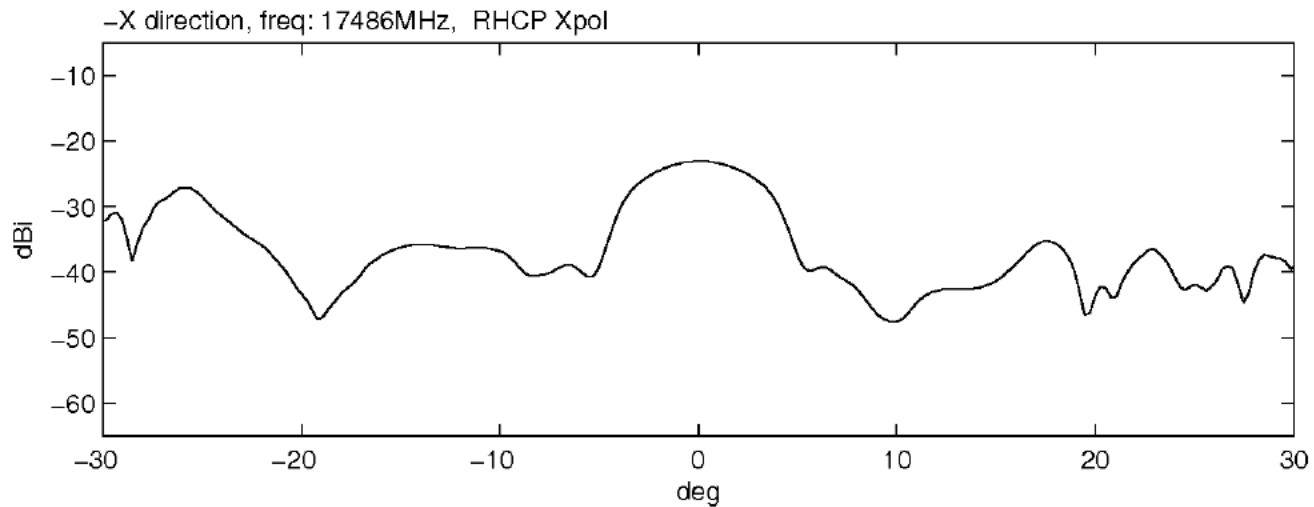
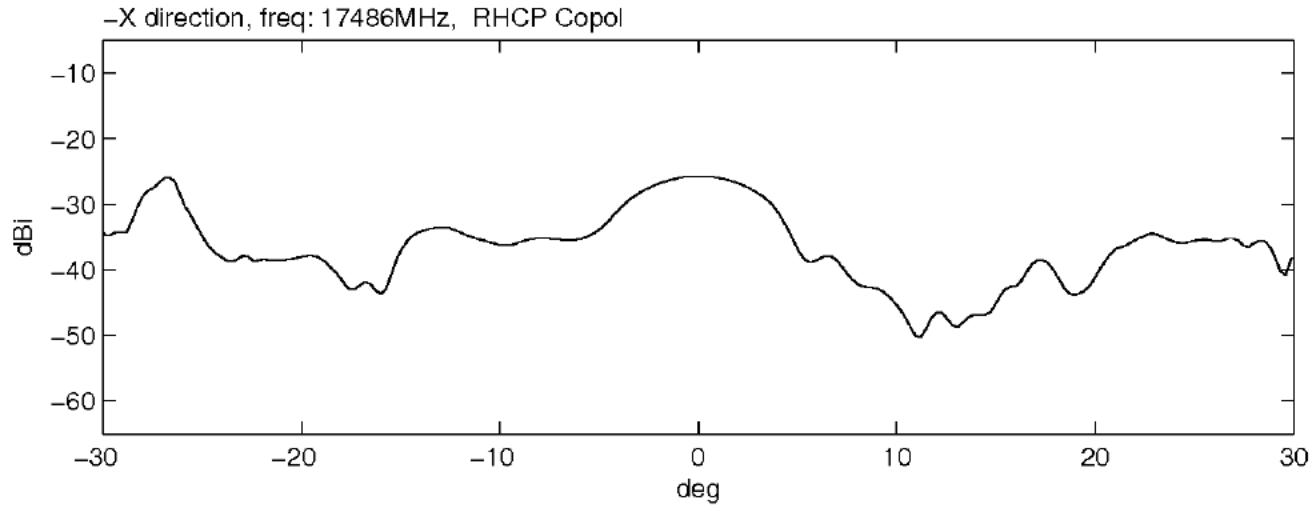

XZ-Plane, Yaw = -40 deg -x direction, Freq: 17486 MHz LHCP

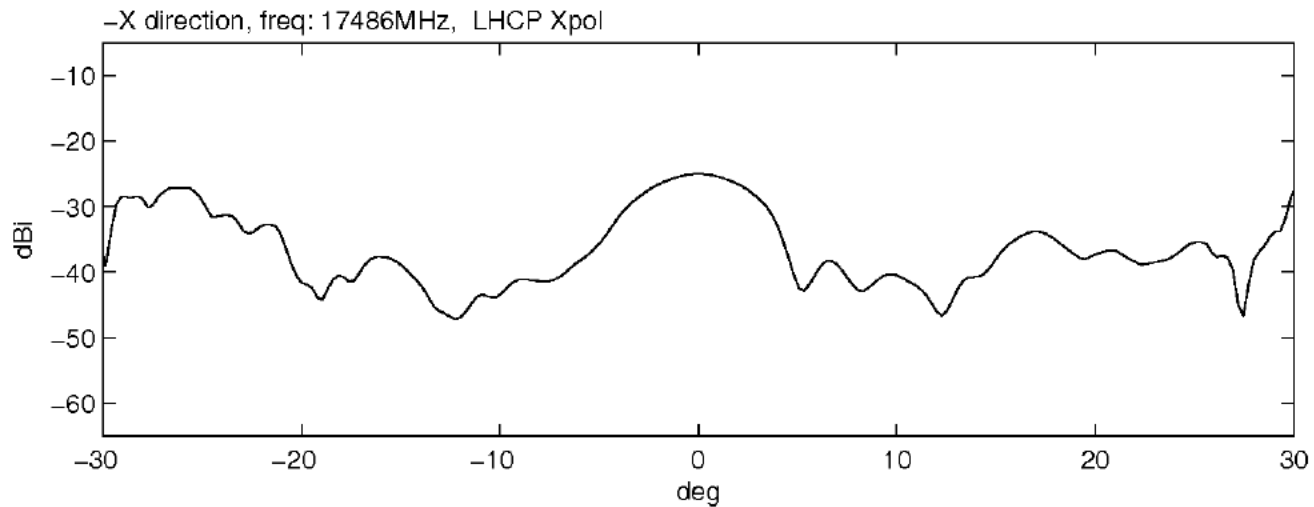
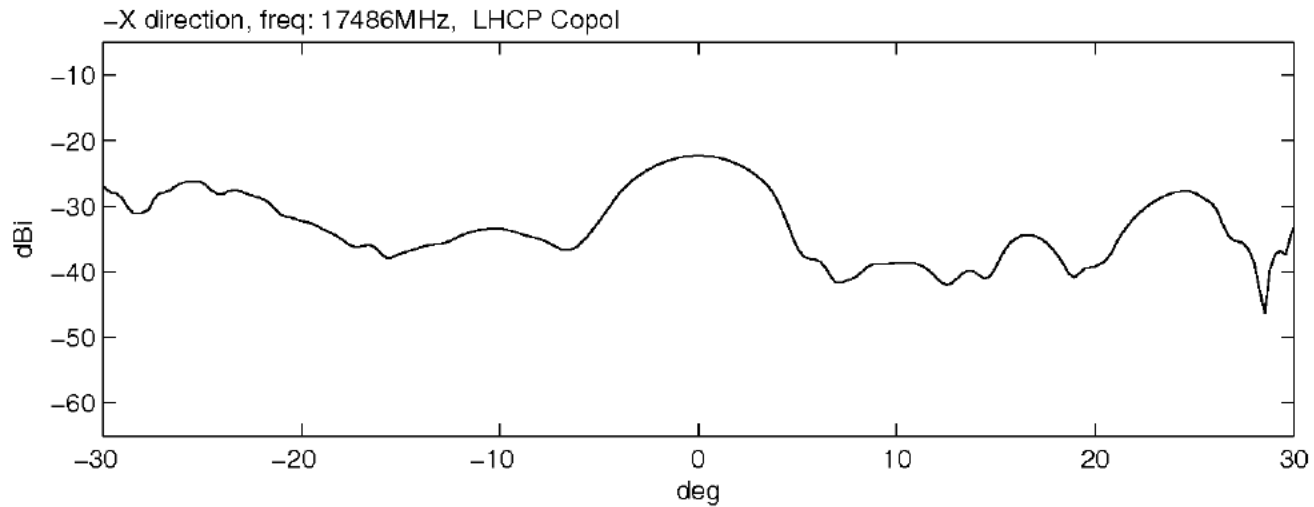

XZ-Plane, Yaw = -50 deg +x direction, Freq: 17486 MHz RHCP

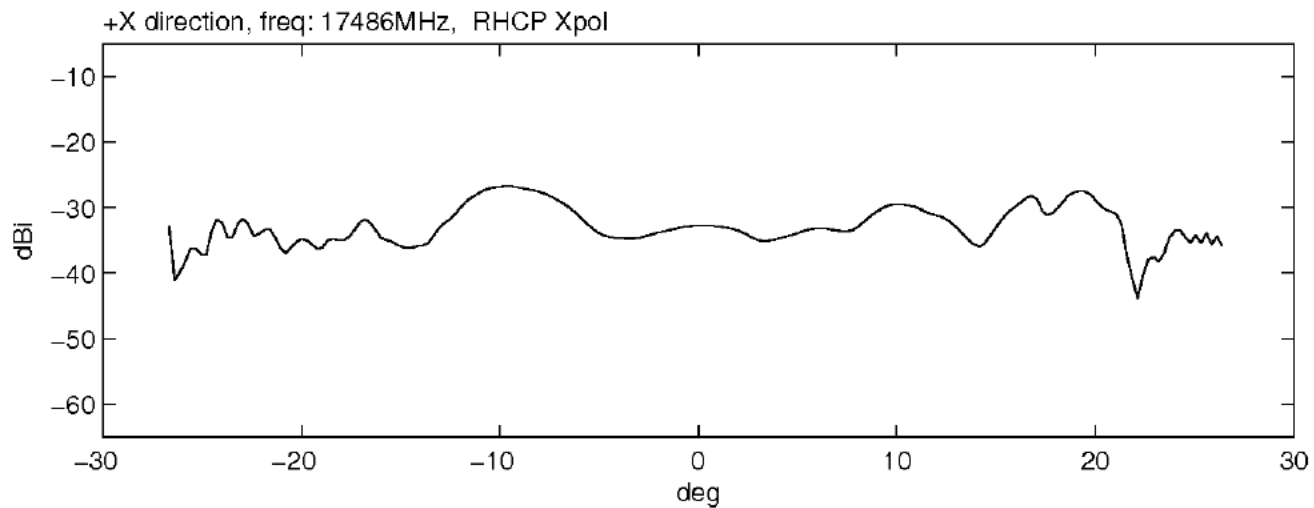
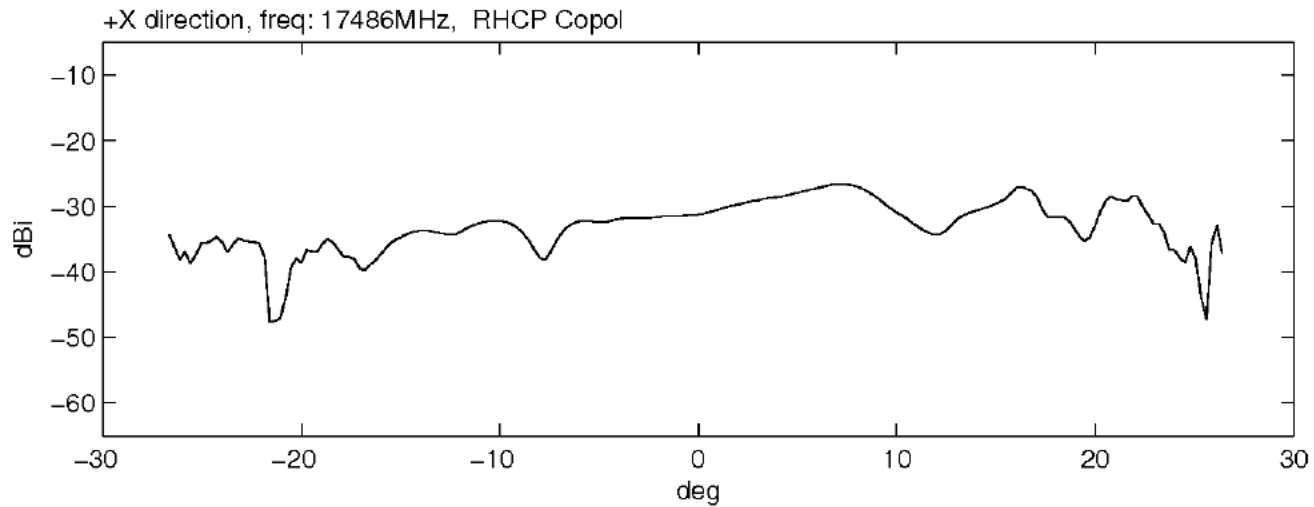

XZ-Plane, Yaw = -50 deg +x direction, Freq: 17486 MHz LHCP

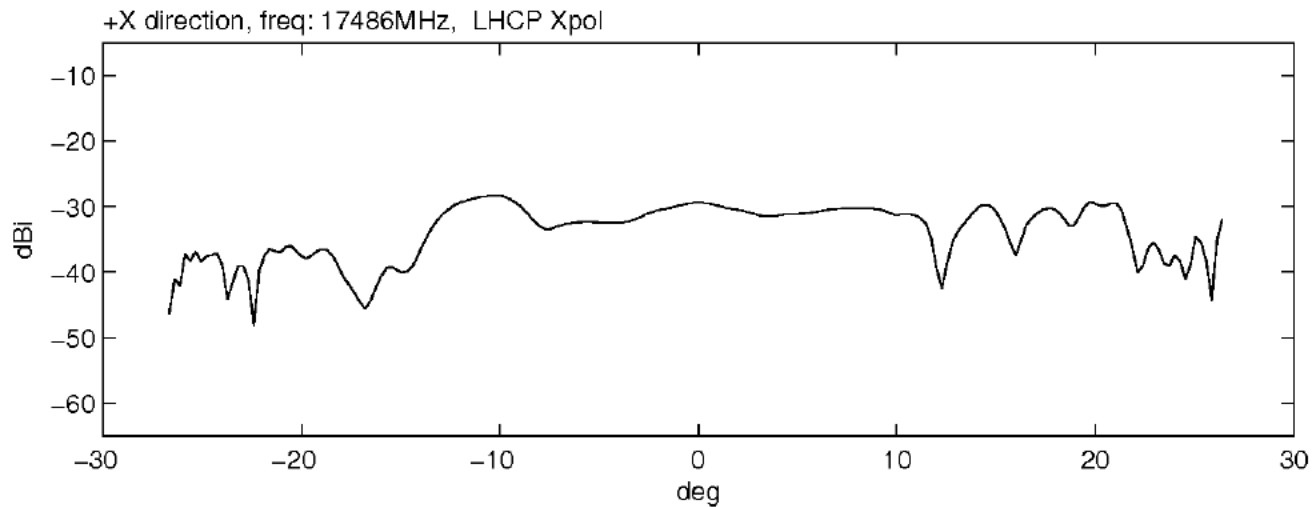
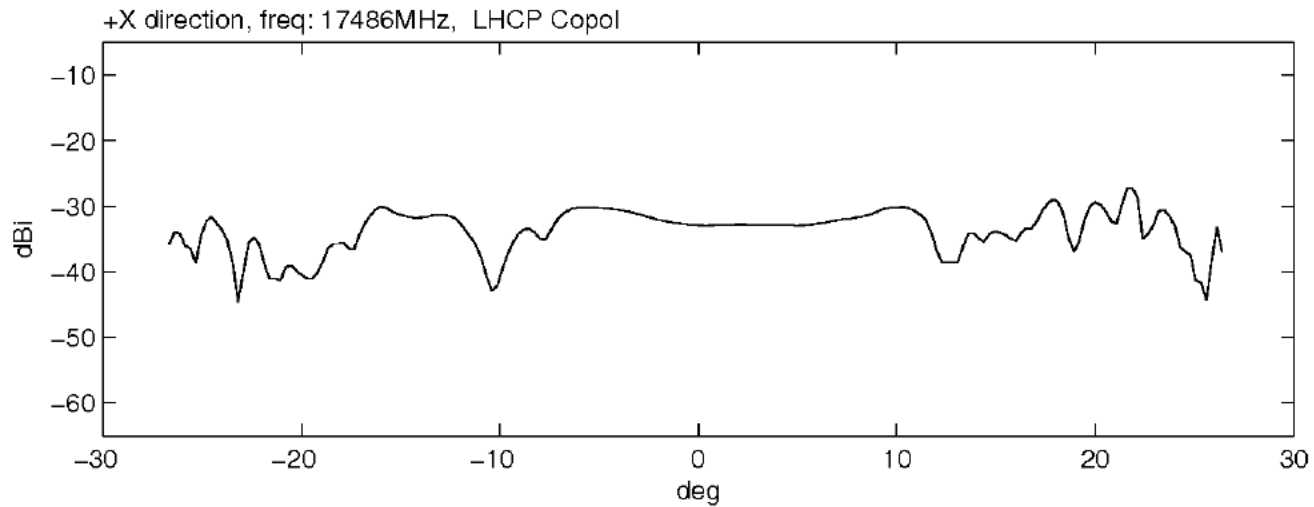

XZ-Plane, Yaw = -50 deg -x direction, Freq: 17486 MHz RHCP

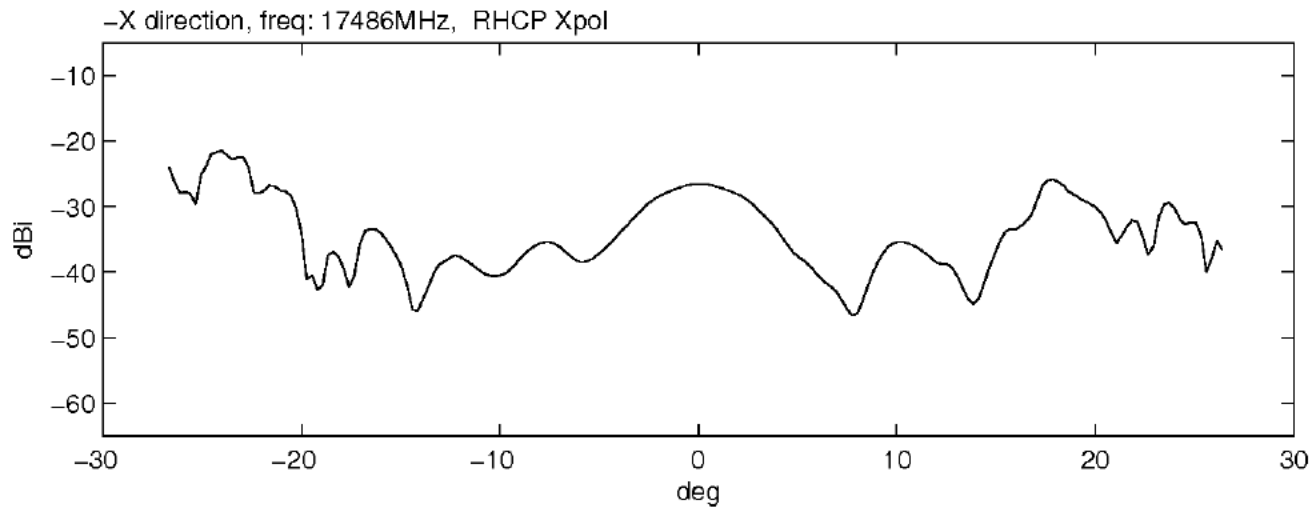
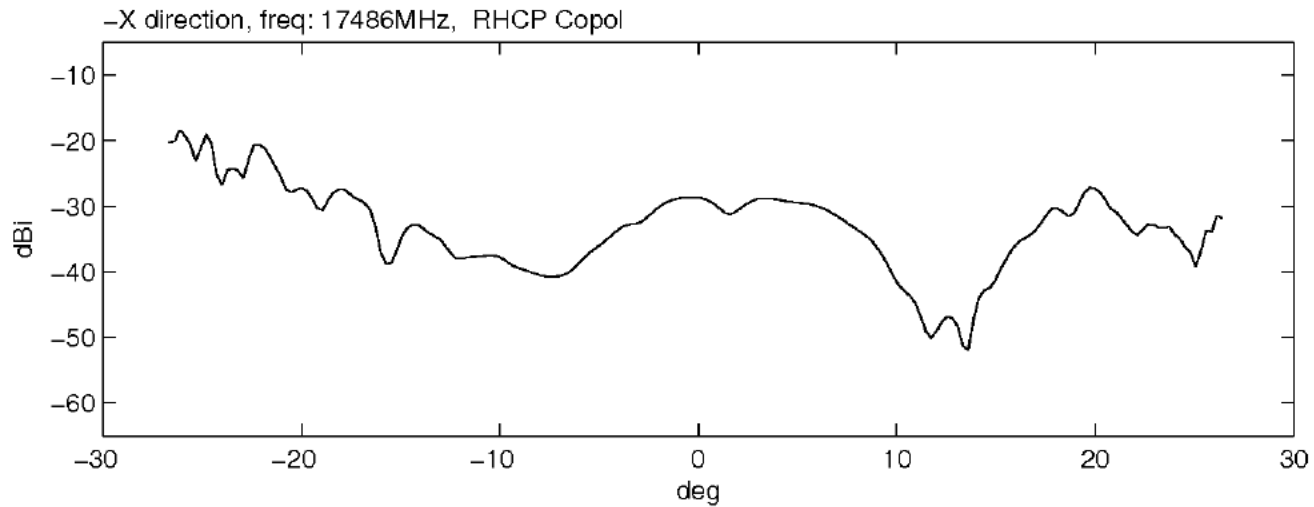

XZ-Plane, Yaw = -50 deg -x direction, Freq: 17486 MHz LHCP

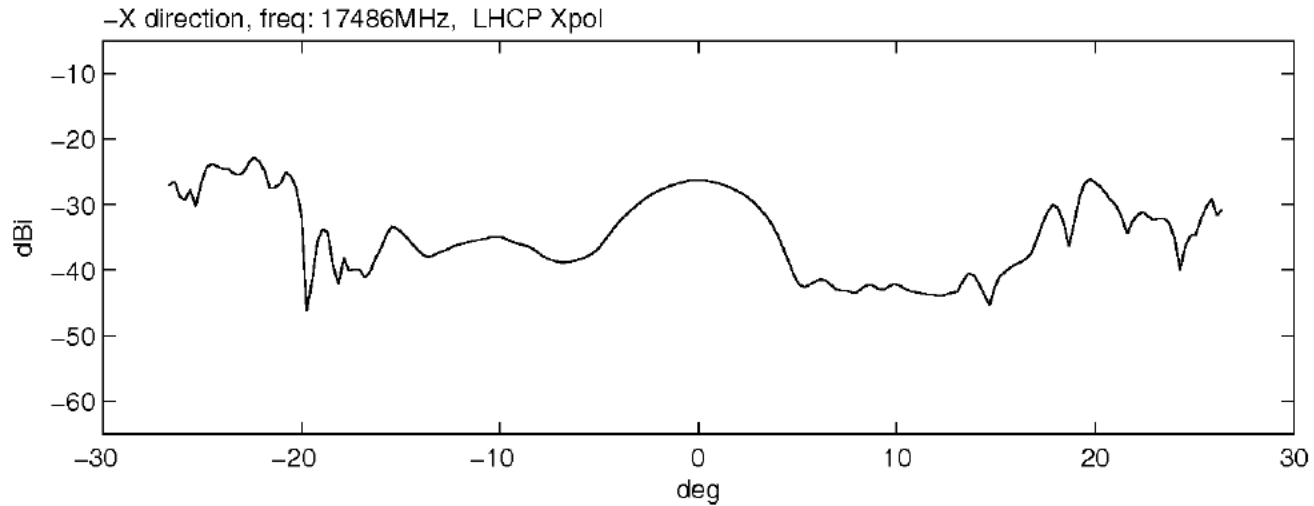
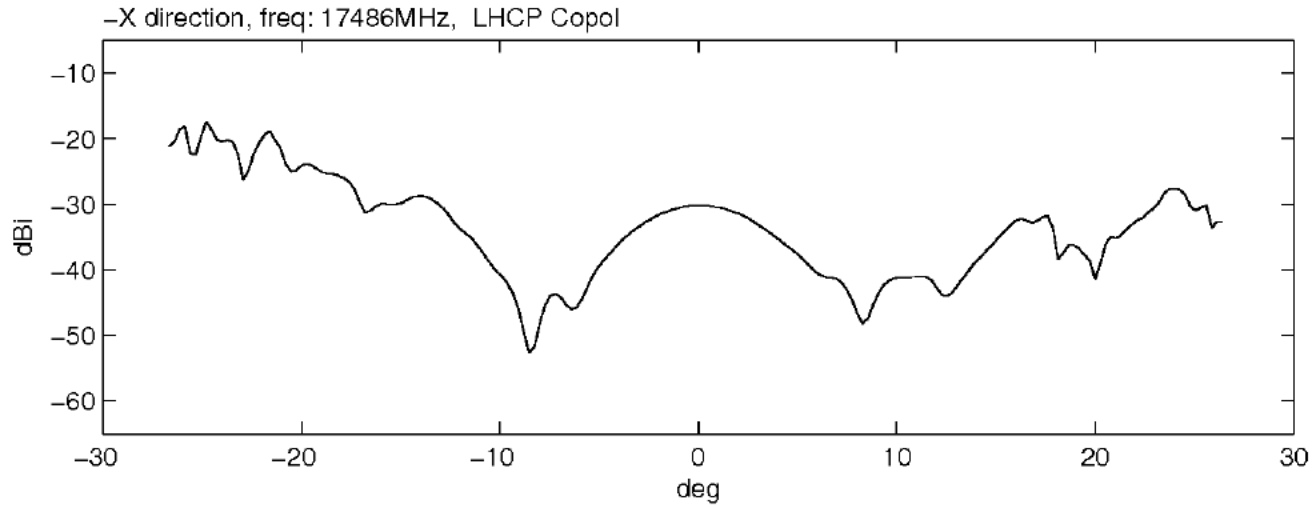

Frequency: 17.646 GHz

XZ-Plane, Yaw = 0 deg +x direction, Freq: 17646 MHz RHCP

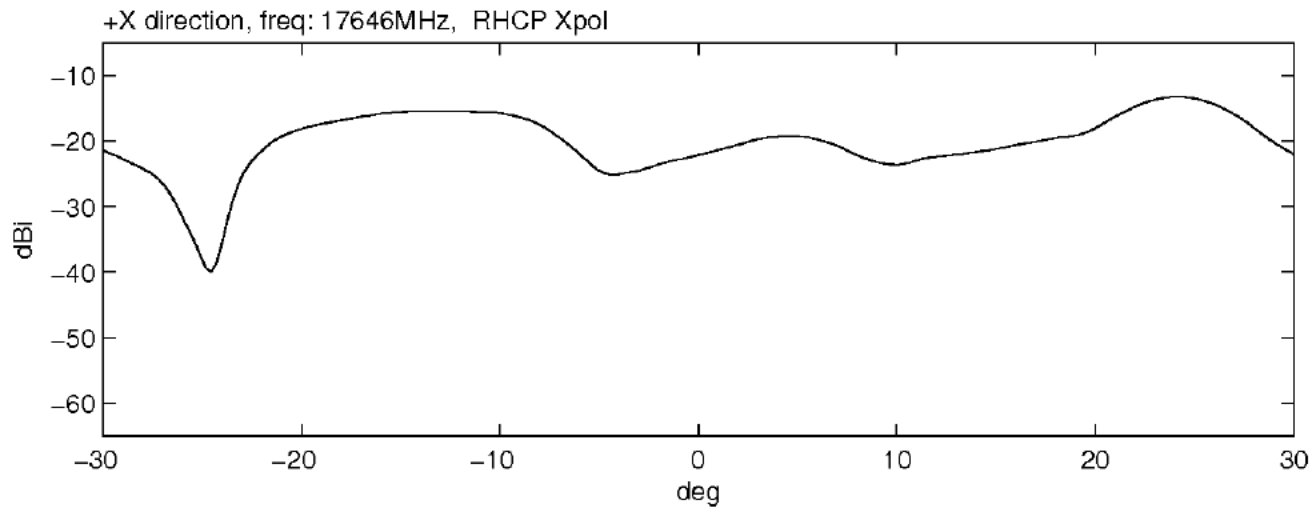
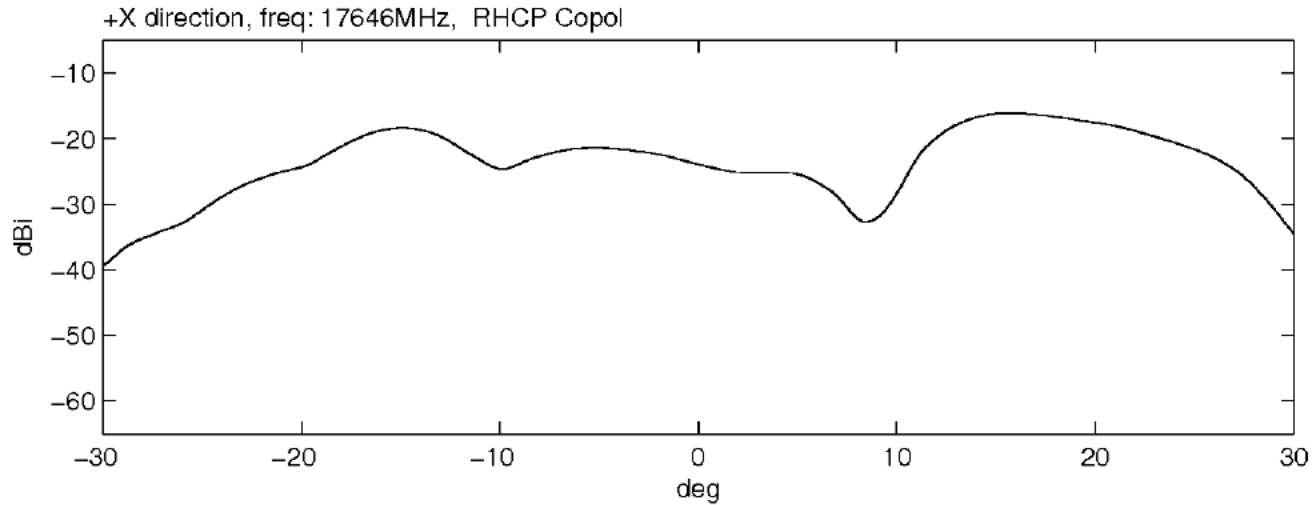

XZ-Plane, Yaw = 0 deg +x direction, Freq: 17646 MHz LHCP

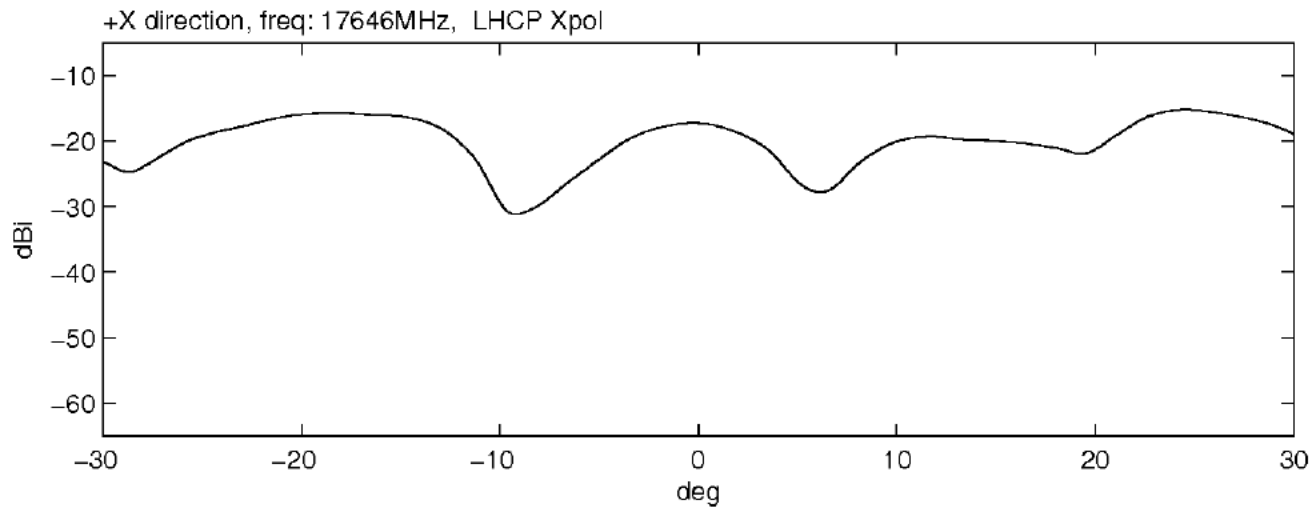
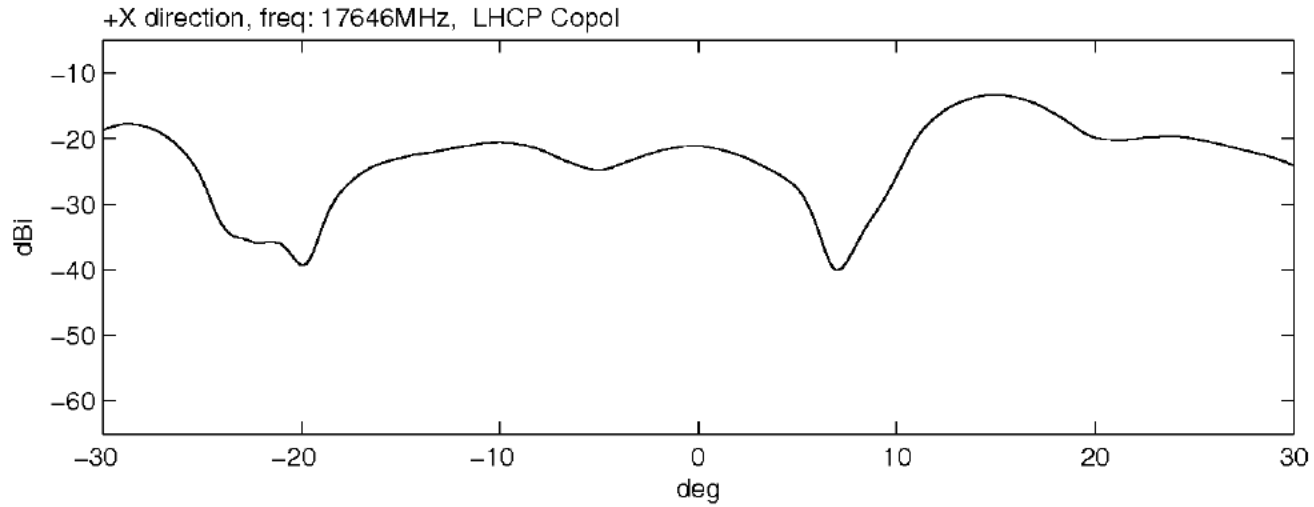

XZ-Plane, Yaw = 0 deg -x direction, Freq: 17646 MHz RHCP

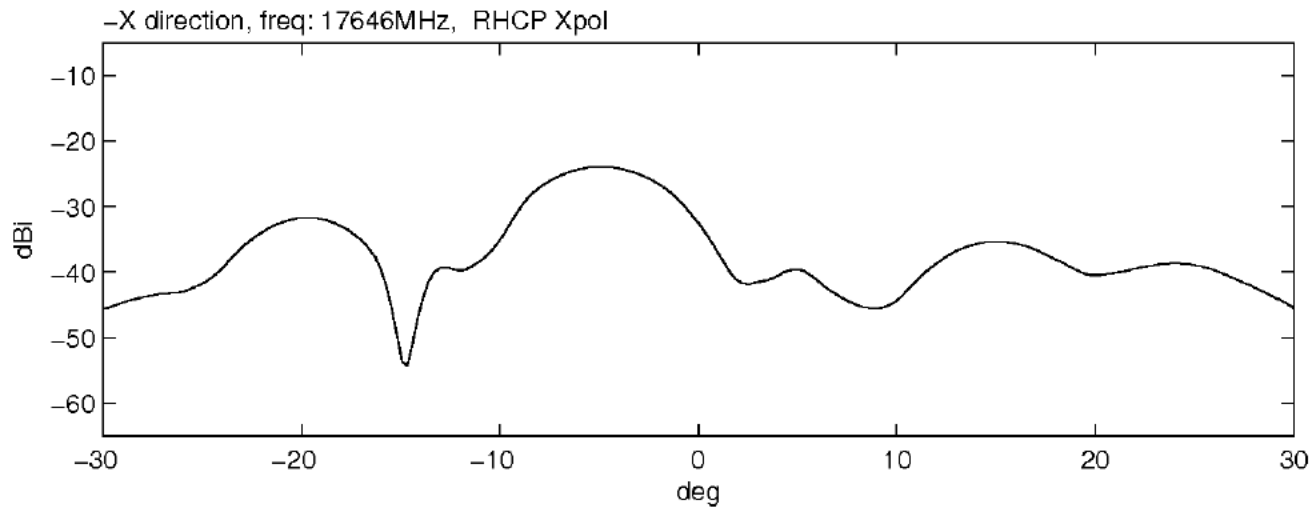
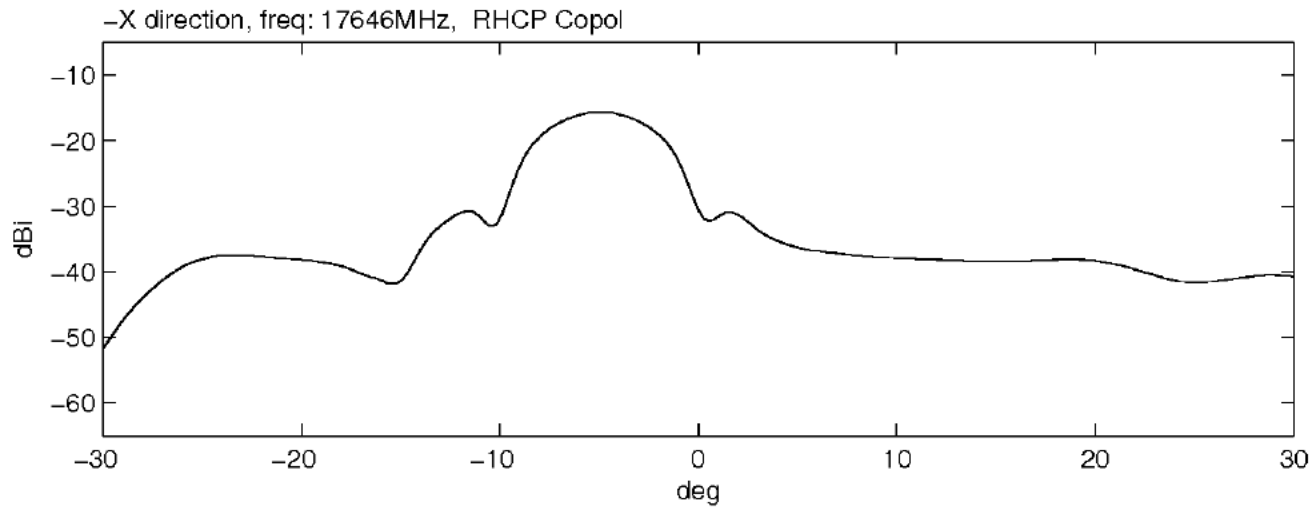

XZ-Plane, Yaw = 0 deg -x direction, Freq: 17646 MHz LHCP

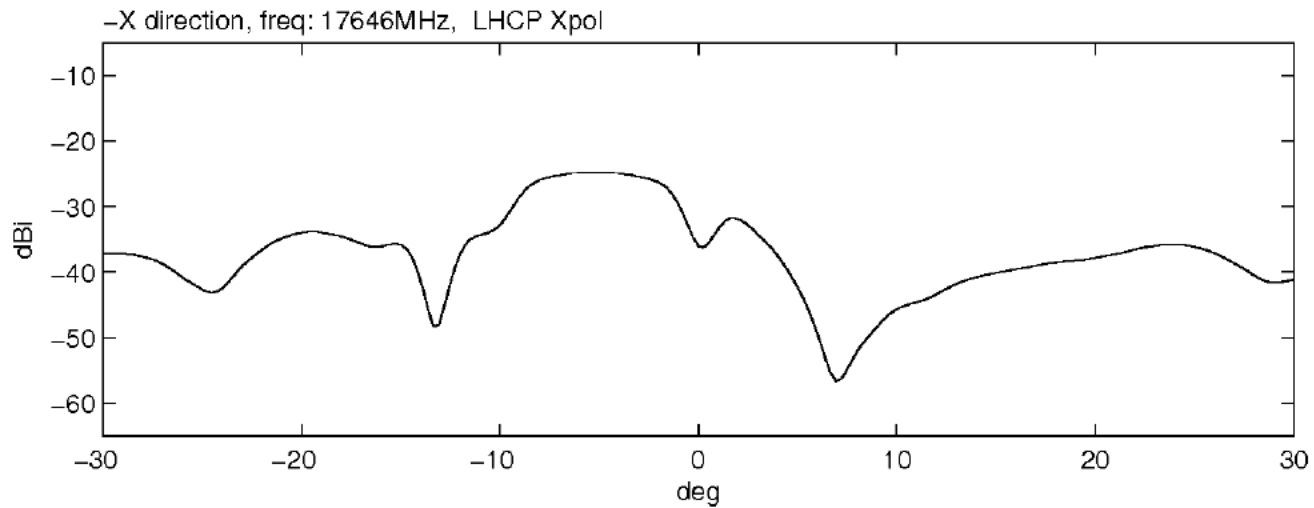
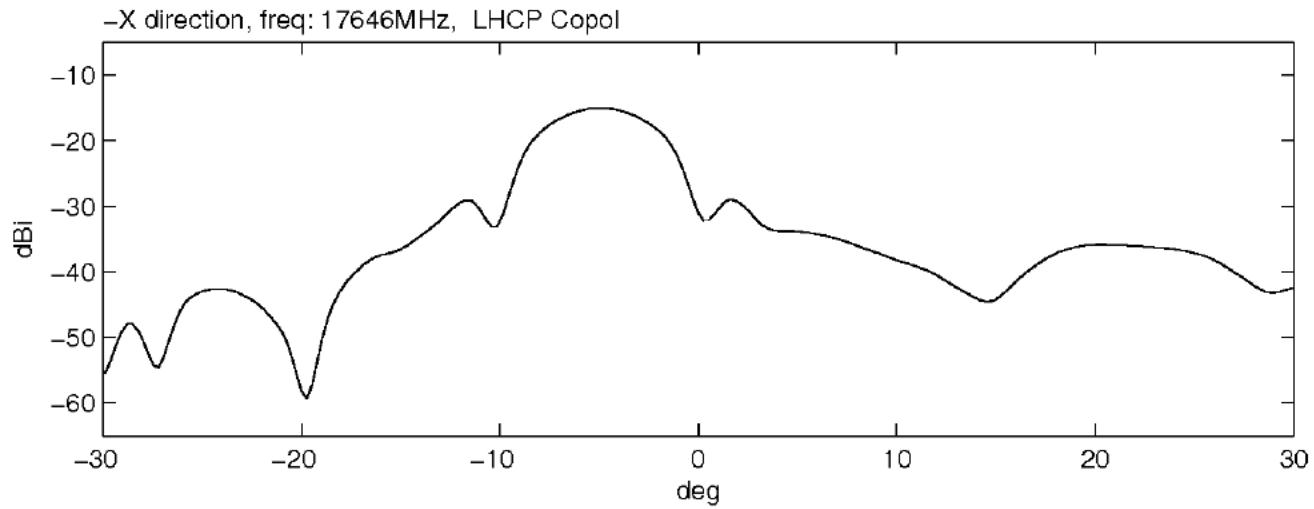

XZ-Plane, Yaw = 10 deg +x direction, Freq: 17646 MHz RHCP

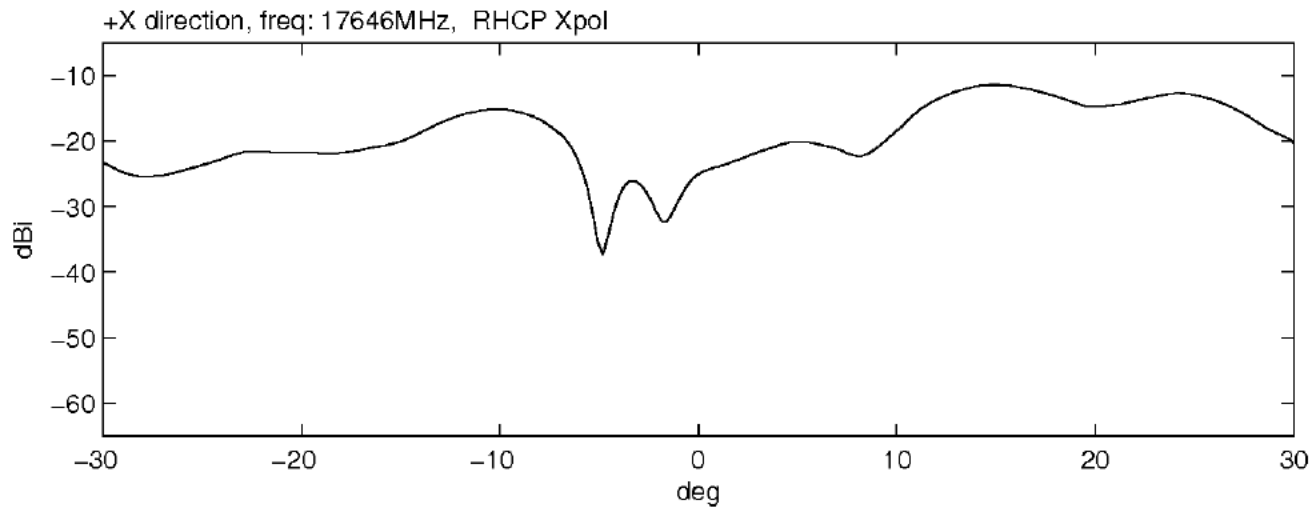
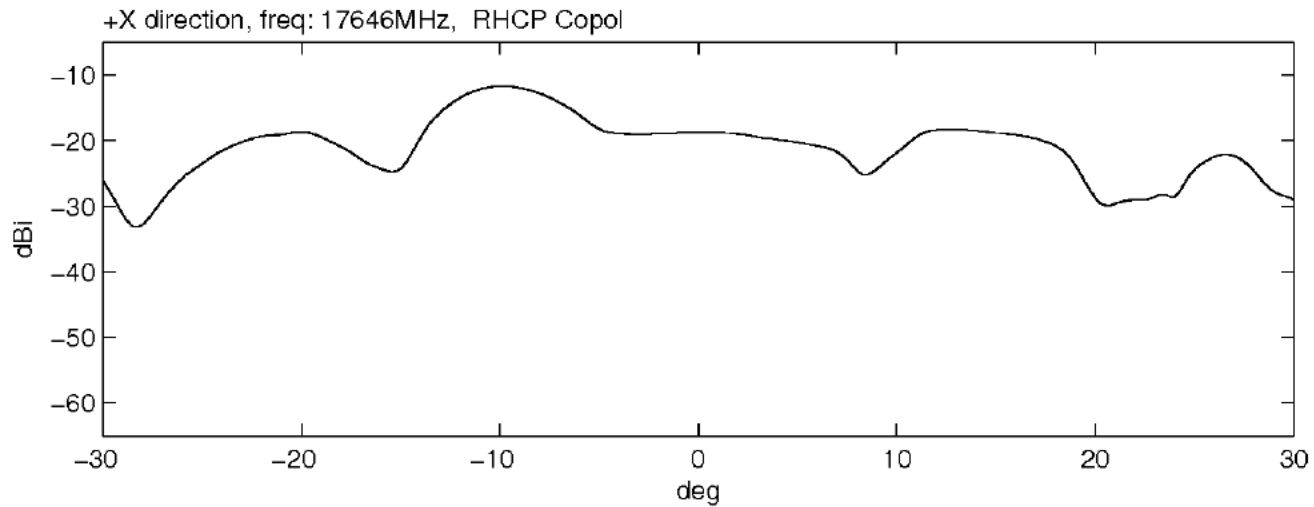

XZ-Plane, Yaw = 10 deg +x direction, Freq: 17646 MHz LHCP

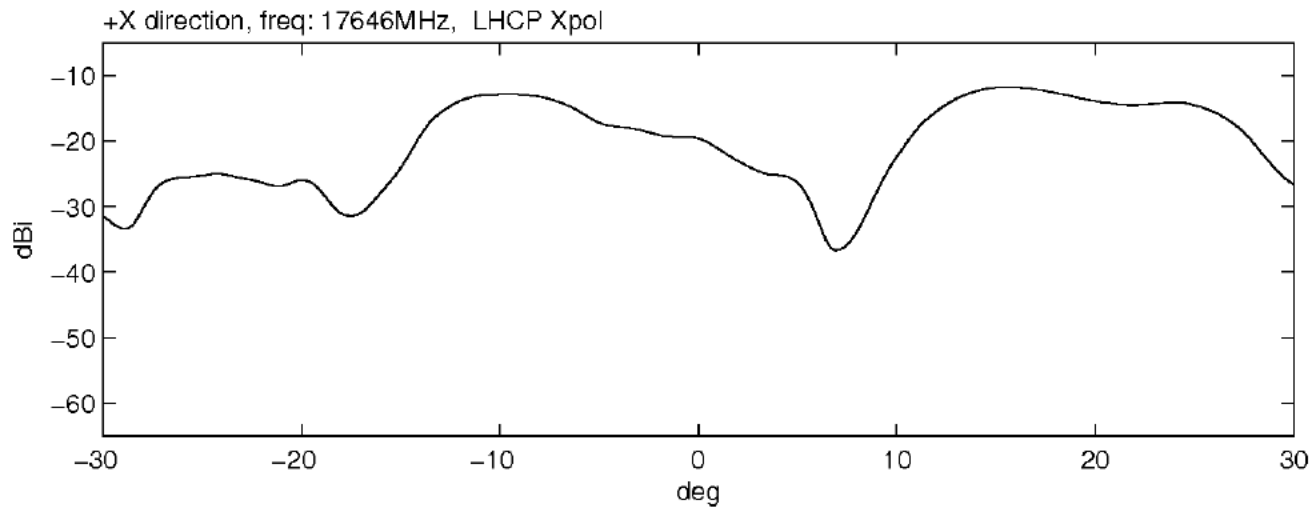
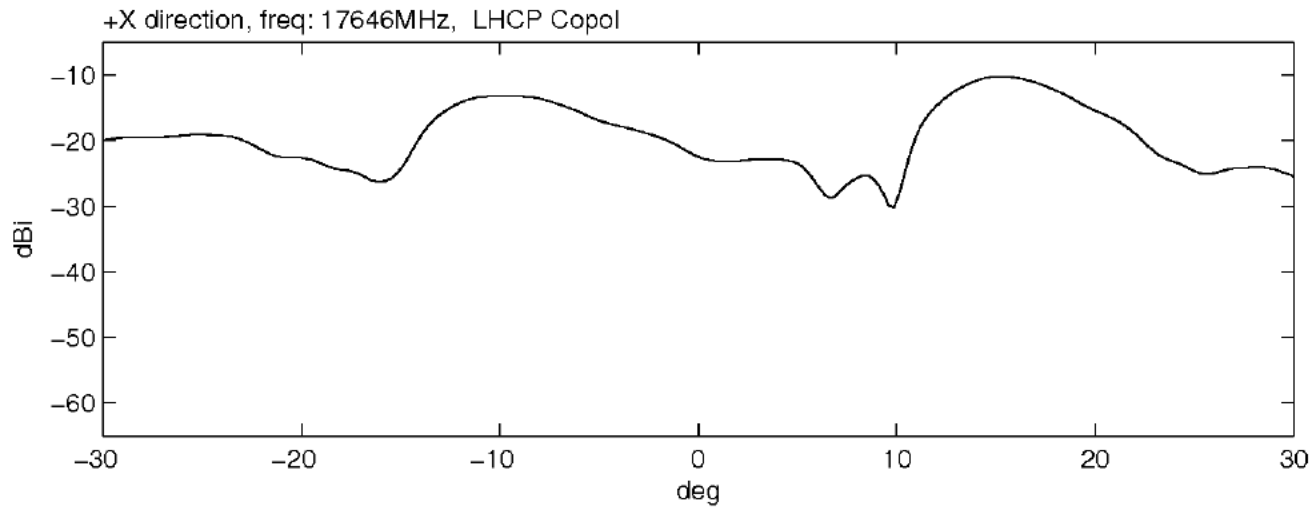

XZ-Plane, Yaw = 10 deg -x direction, Freq: 17646 MHz RHCP

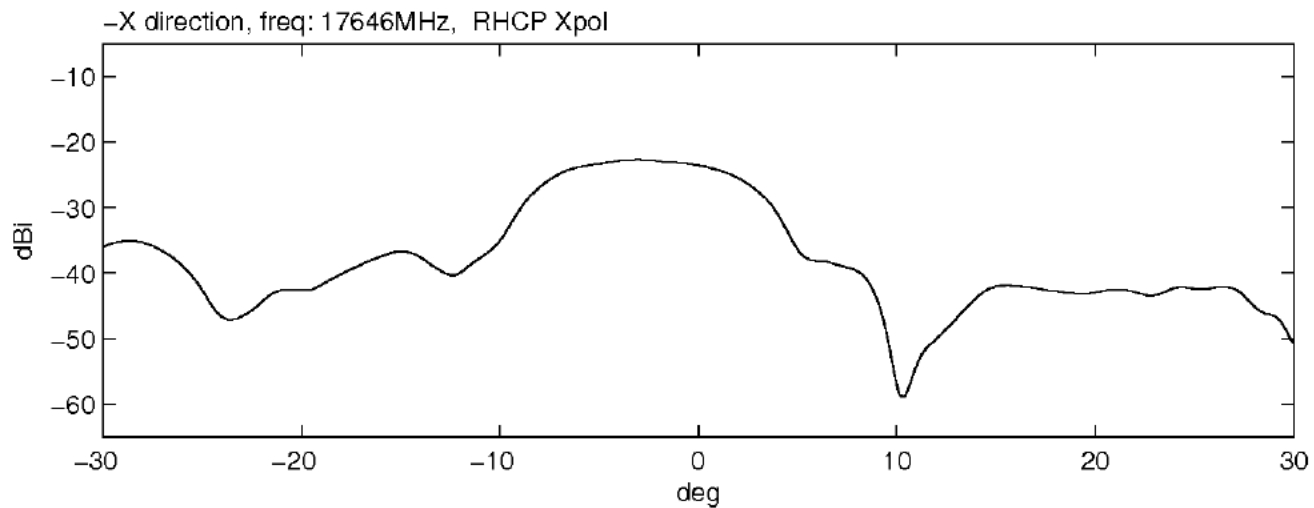
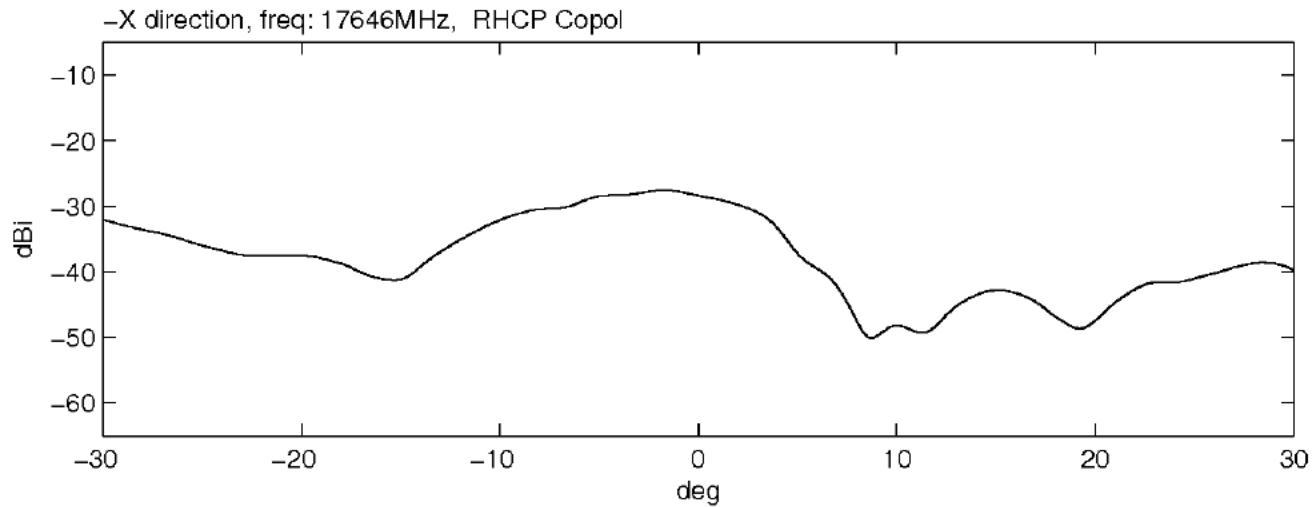

XZ-Plane, Yaw = 10 deg -x direction, Freq: 17646 MHz LHCP

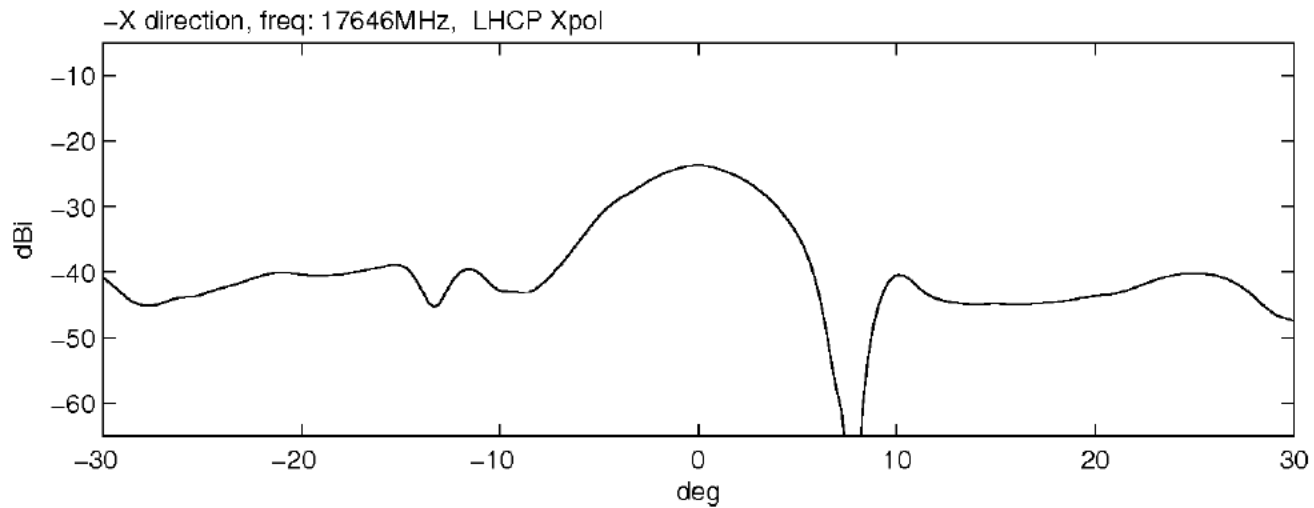
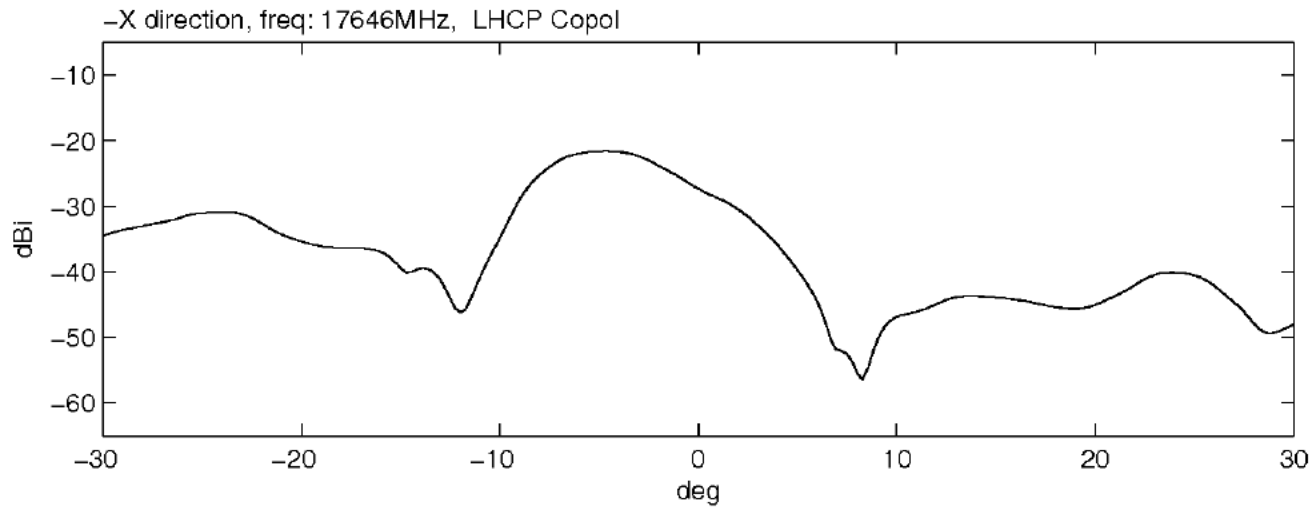

XZ-Plane, Yaw = 20 deg +x direction, Freq: 17646 MHz RHCP

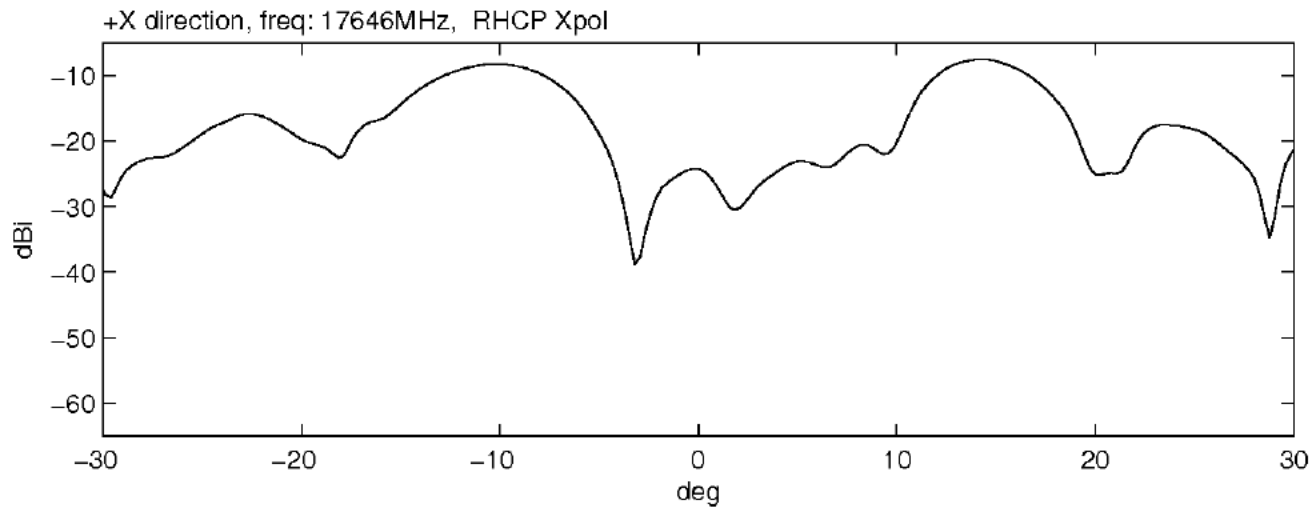
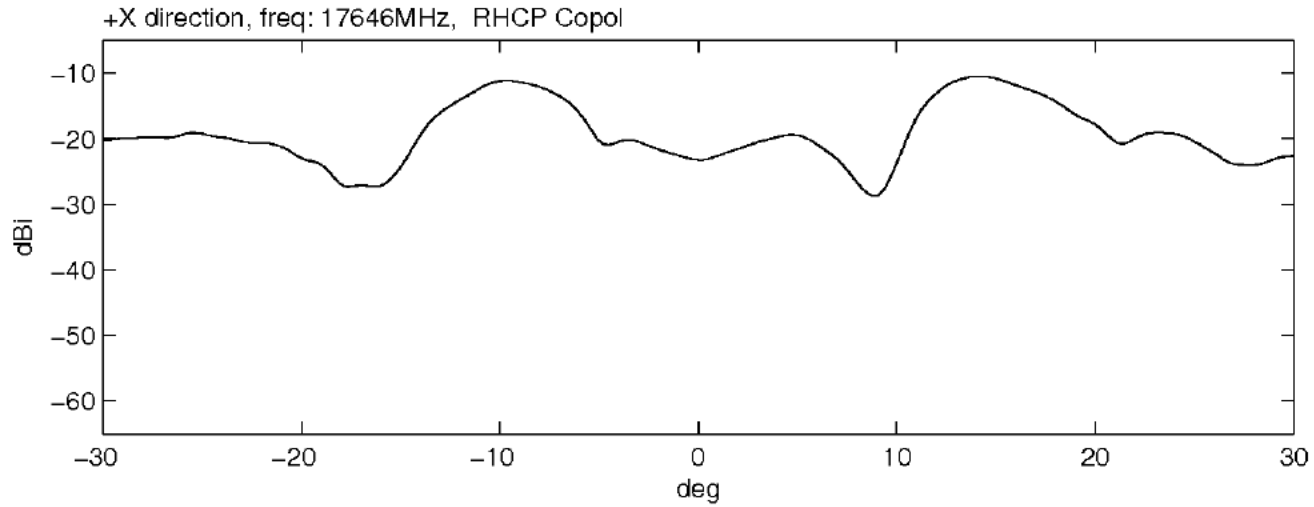

XZ-Plane, Yaw = 20 deg +x direction, Freq: 17646 MHz LHCP

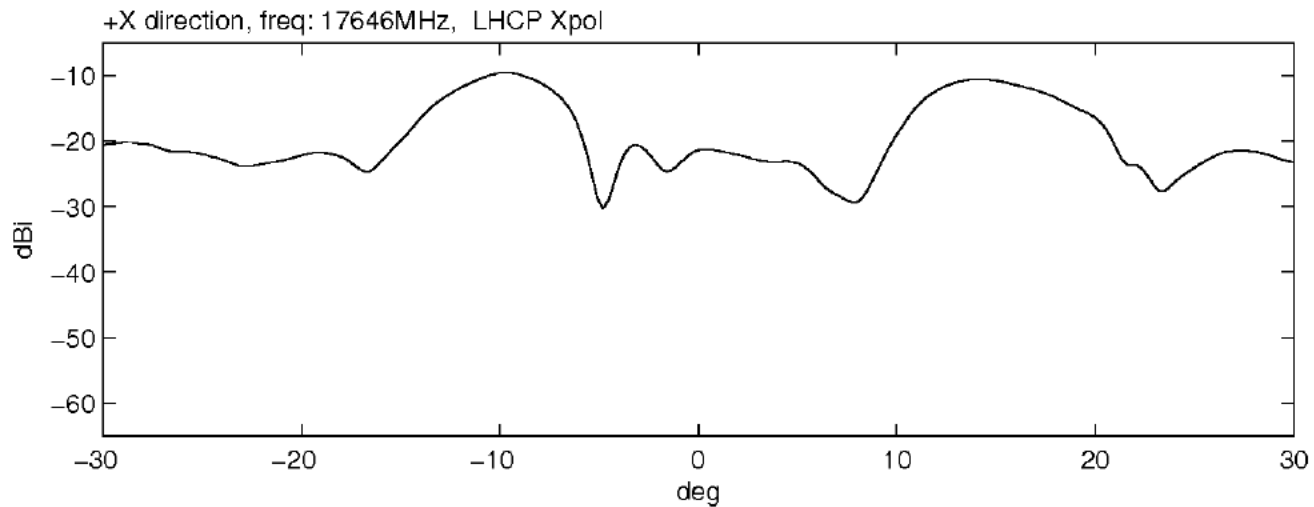
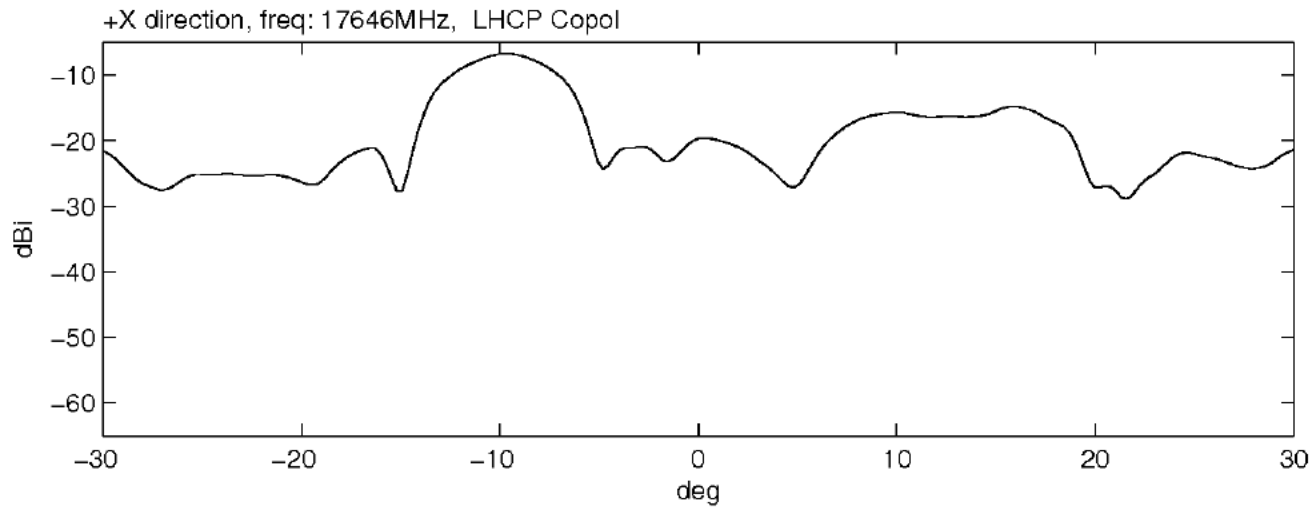

XZ-Plane, Yaw = 20 deg -x direction, Freq: 17646 MHz RHCP

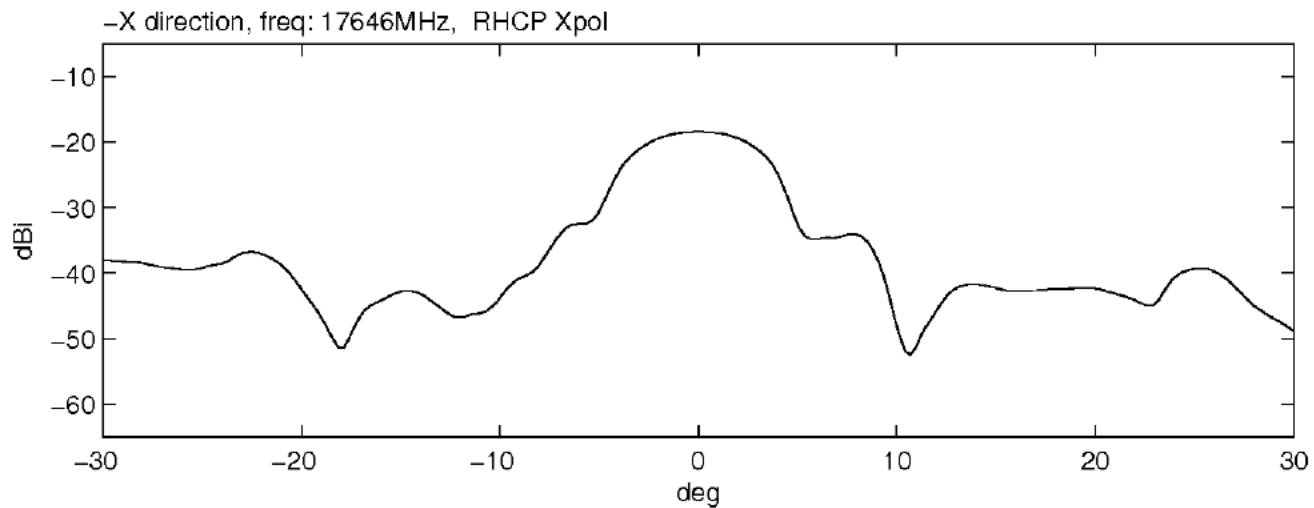
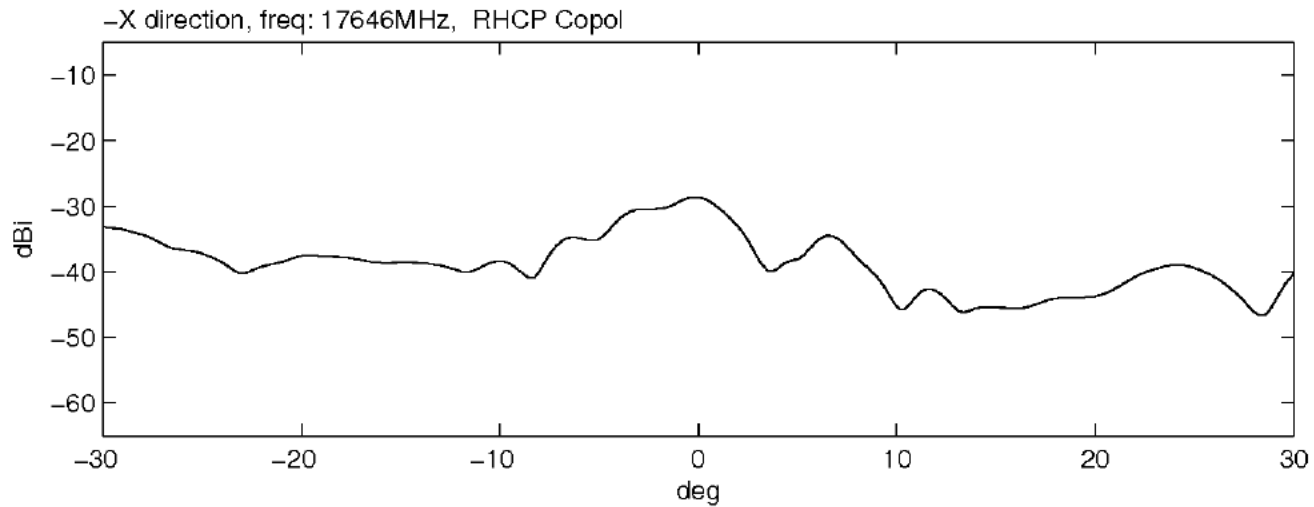

XZ-Plane, Yaw = 20 deg -x direction, Freq: 17646 MHz LHCP

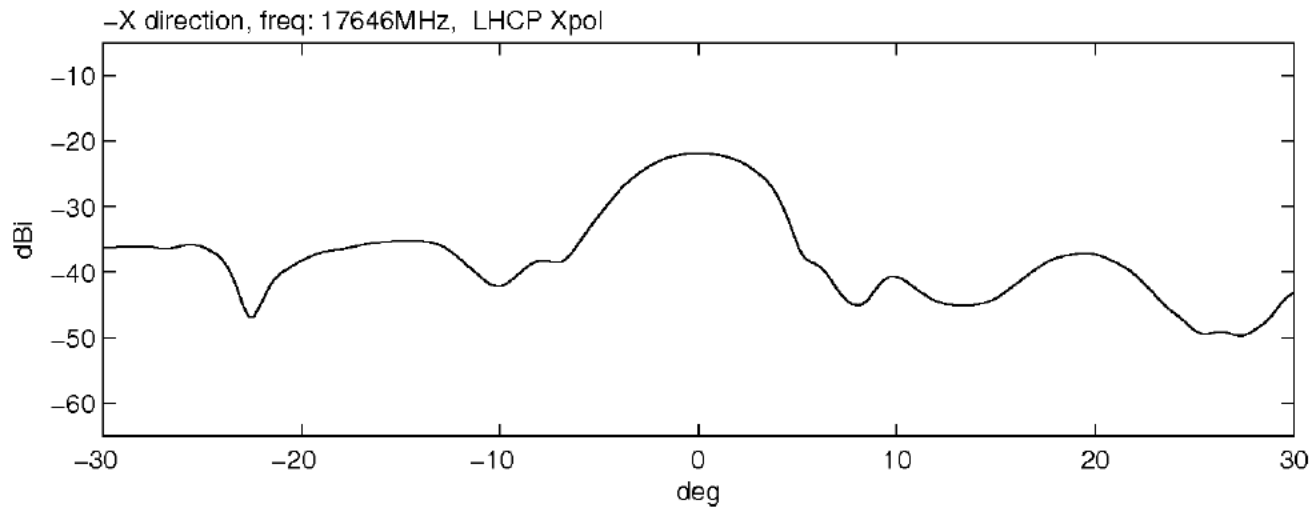
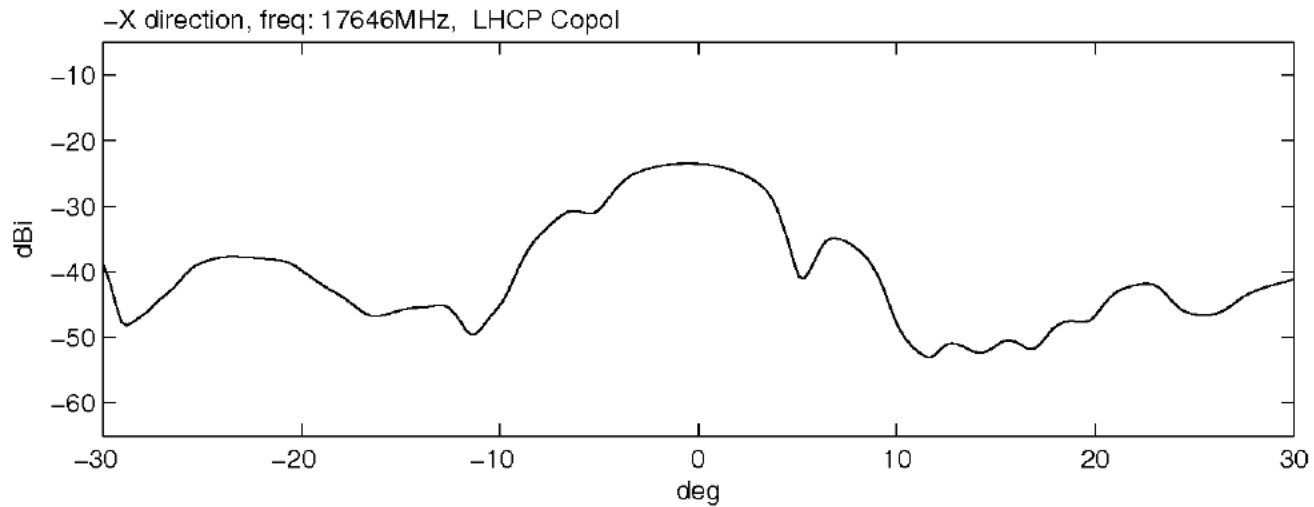

XZ-Plane, Yaw = 30 deg +x direction, Freq: 17646 MHz RHCP

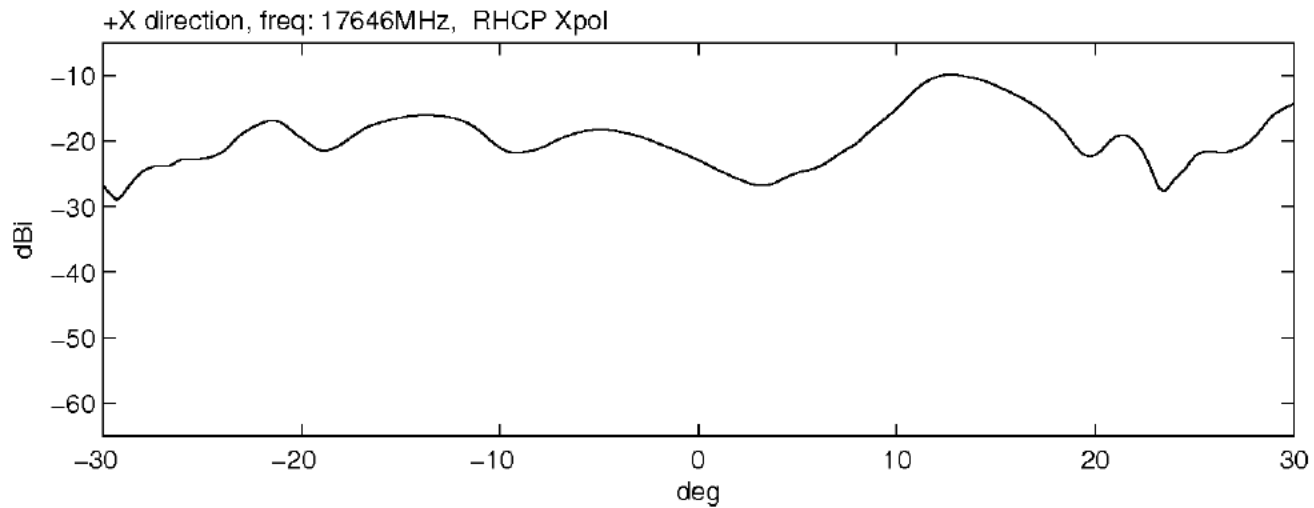
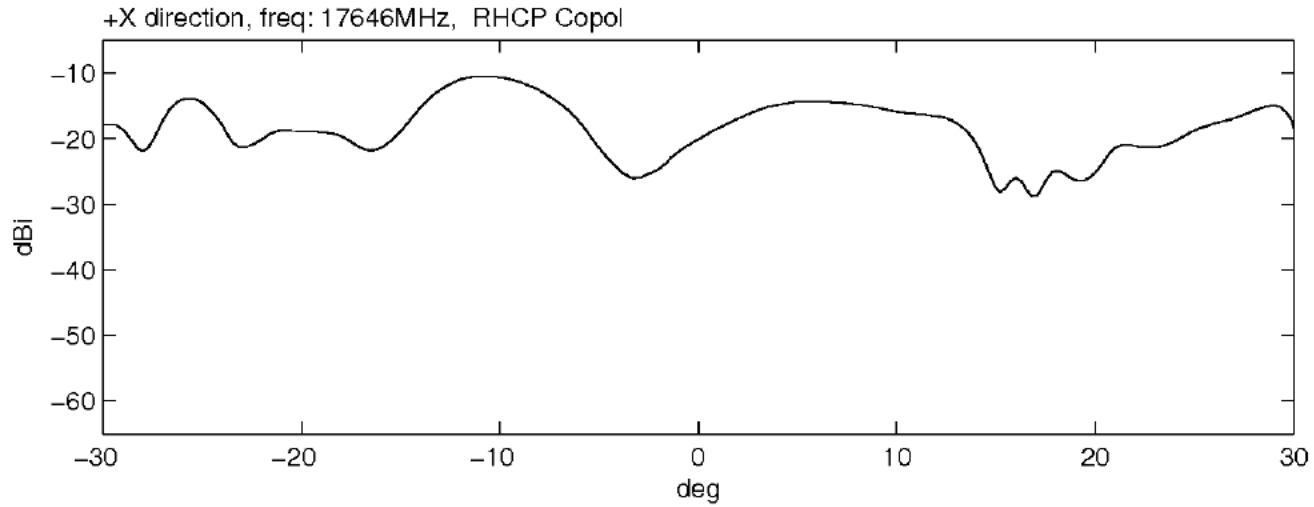

XZ-Plane, Yaw = 30 deg +x direction, Freq: 17646 MHz LHCP

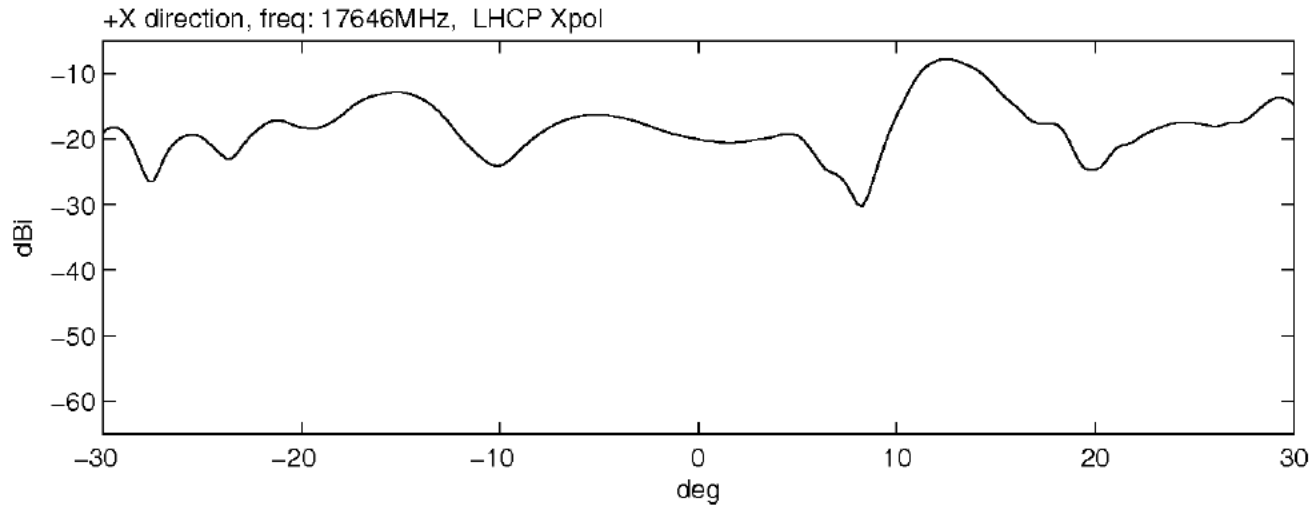
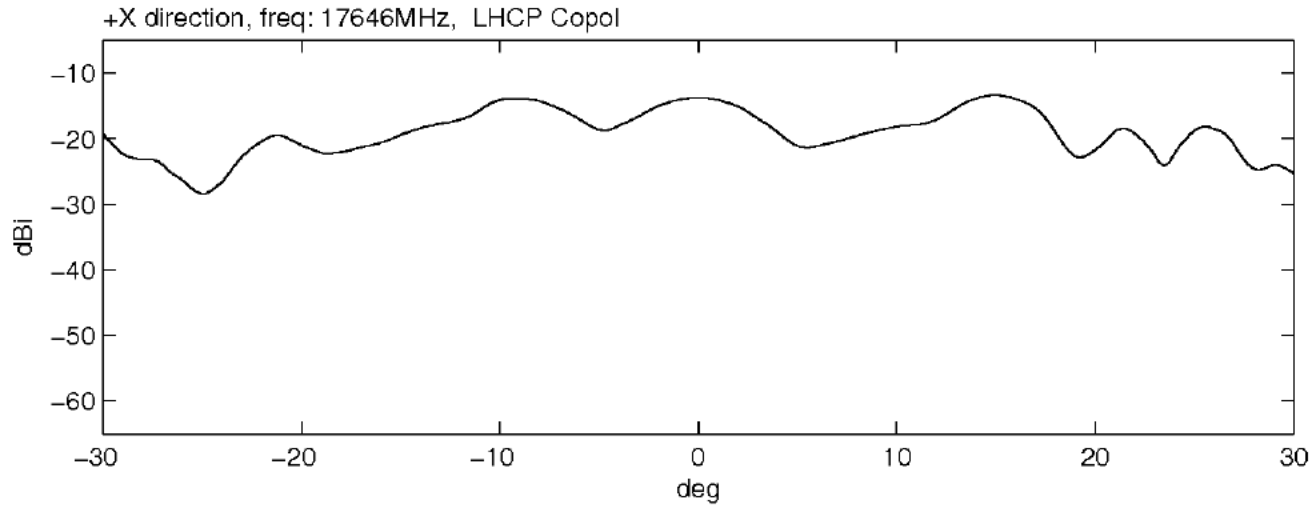

XZ-Plane, Yaw = 30 deg -x direction, Freq: 17646 MHz RHCP

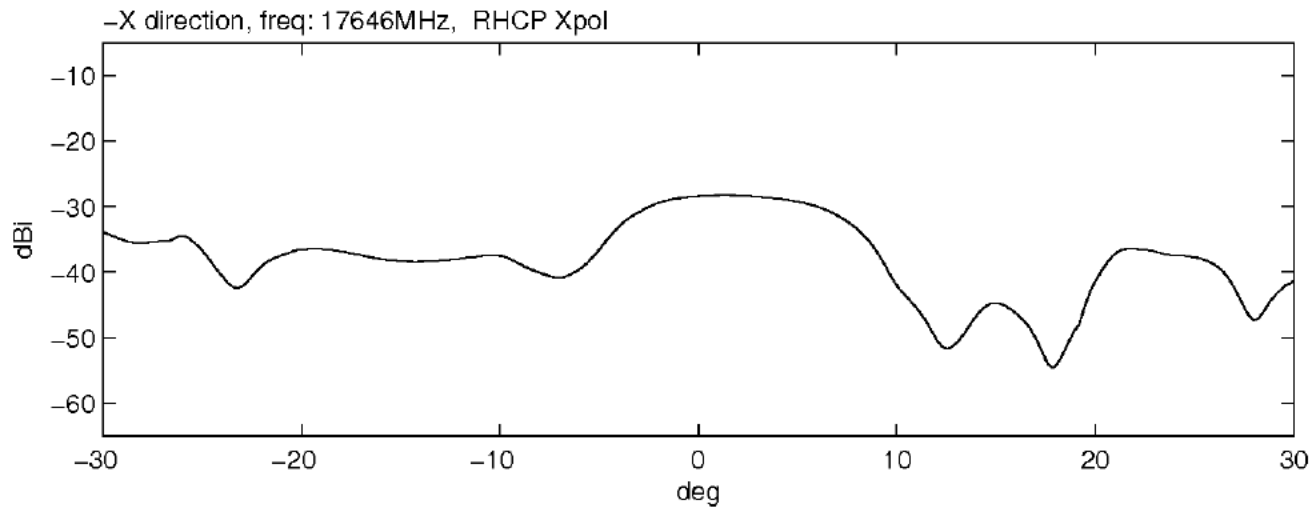
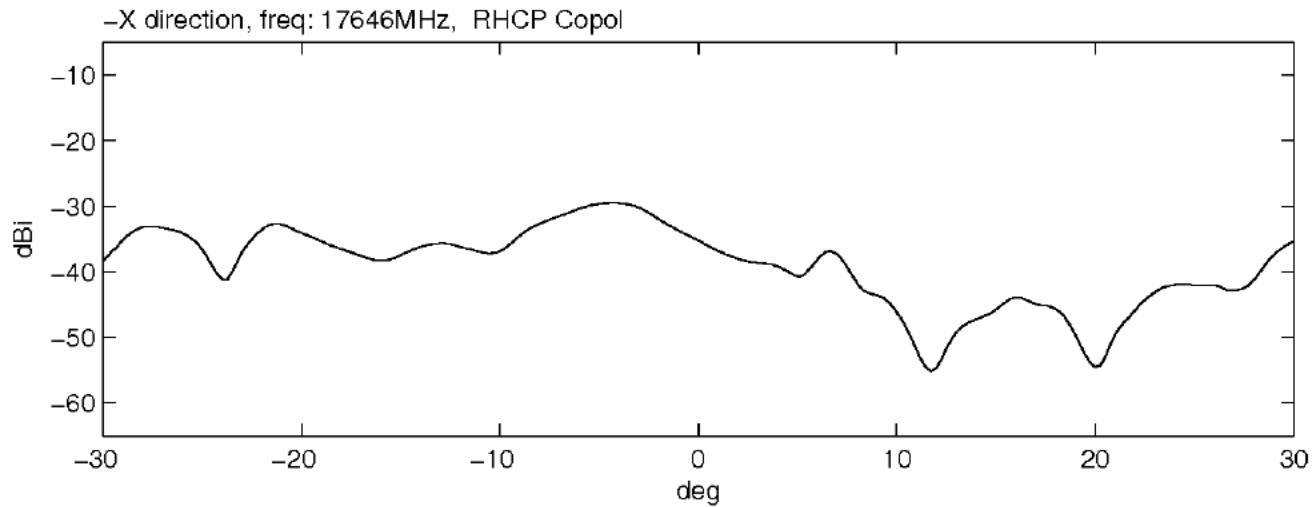

XZ-Plane, Yaw = 30 deg -x direction, Freq: 17646 MHz LHCP

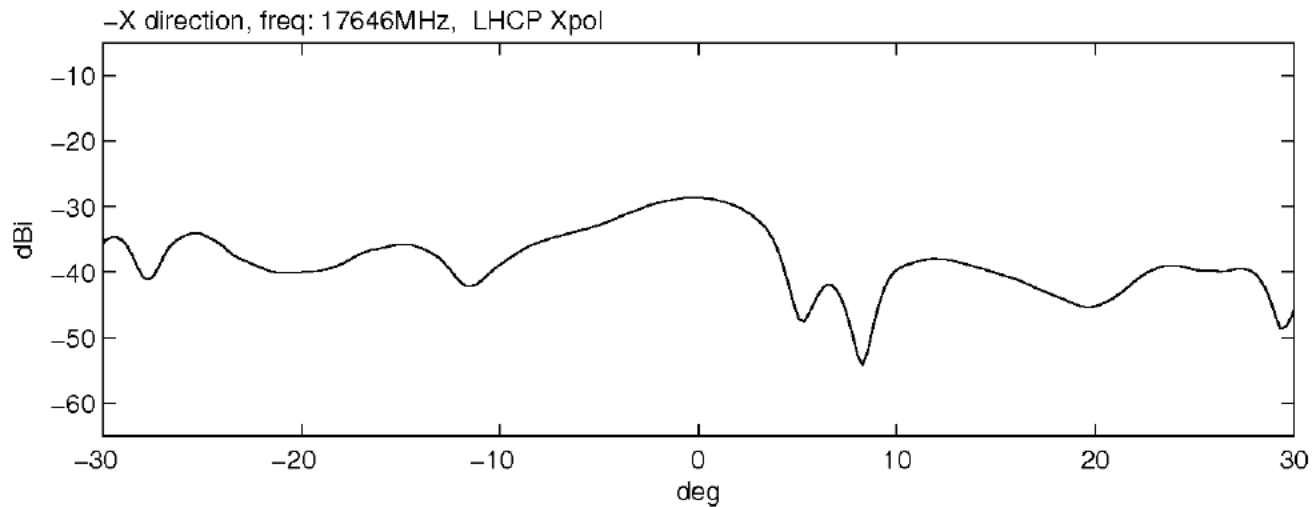
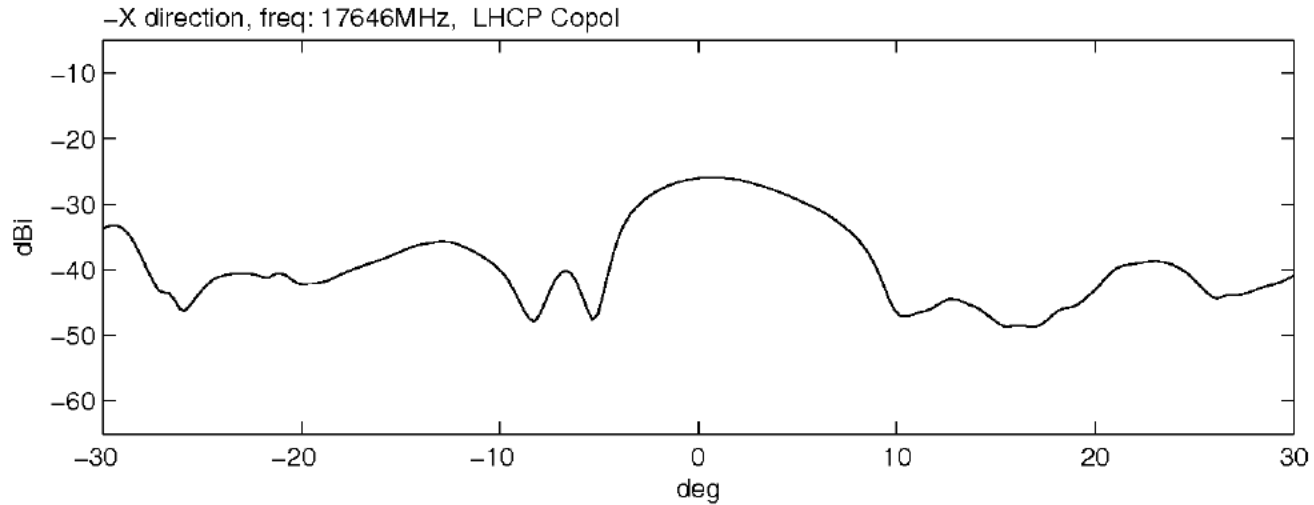

XZ-Plane, Yaw = 40 deg +x direction, Freq: 17646 MHz RHCP

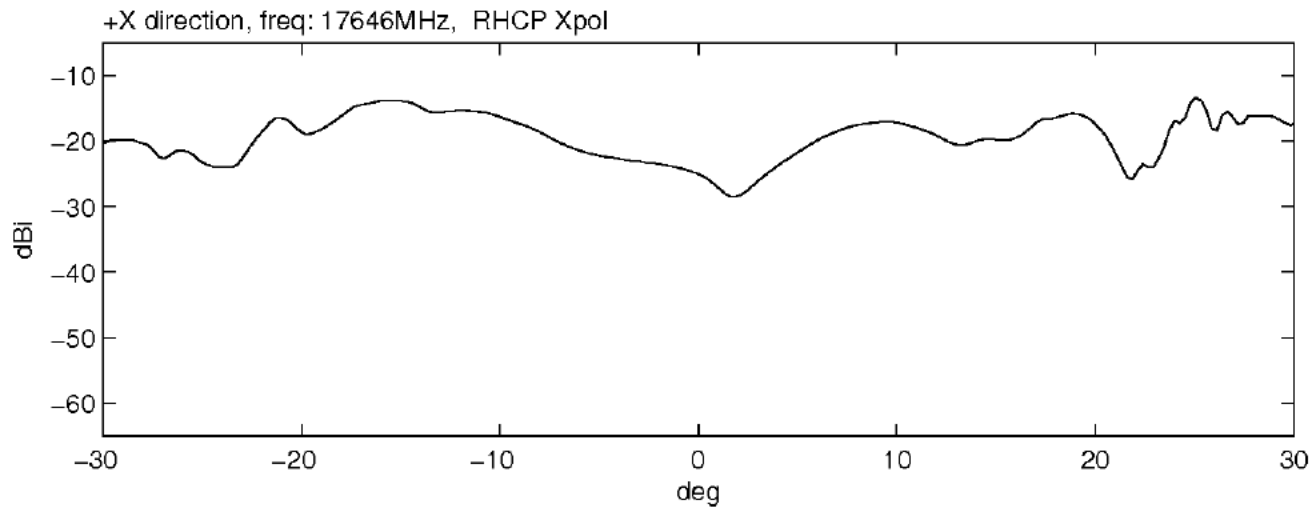
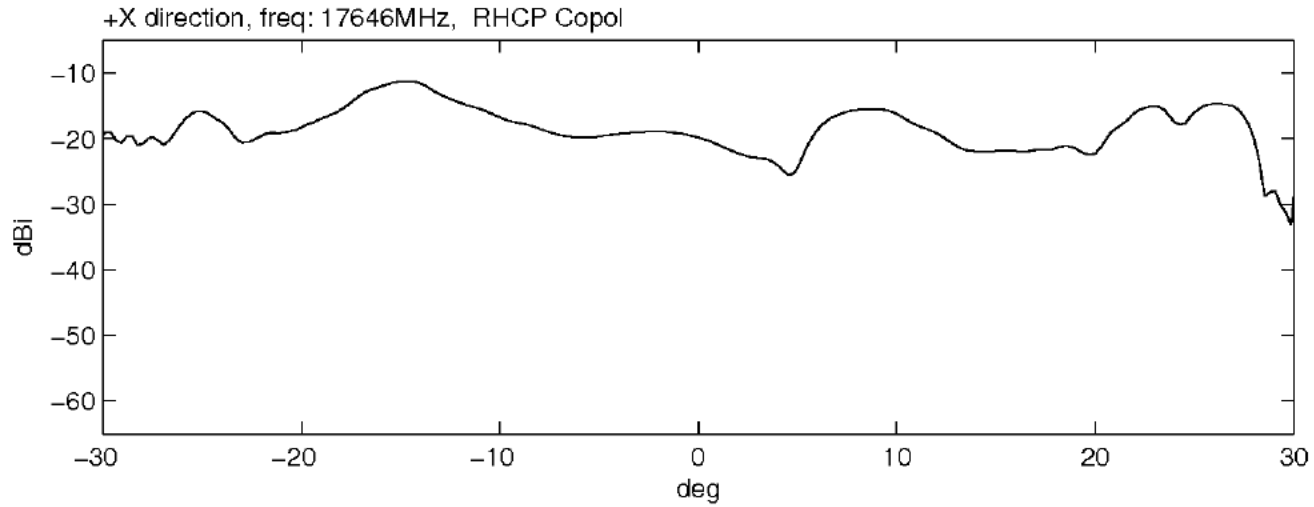

XZ-Plane, Yaw = 40 deg +x direction, Freq: 17646 MHz LHCP

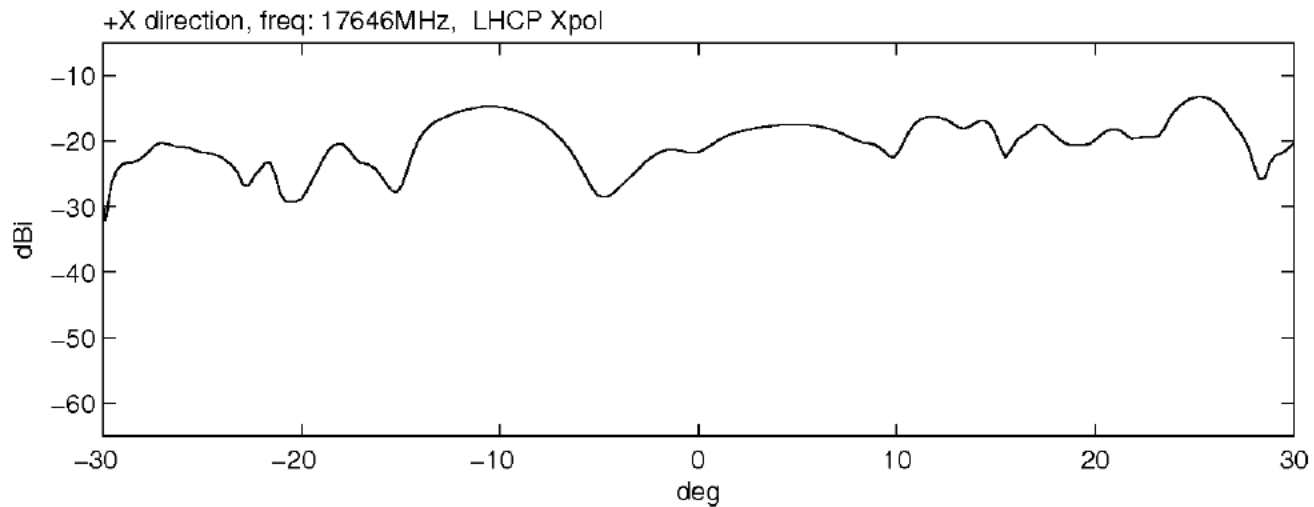
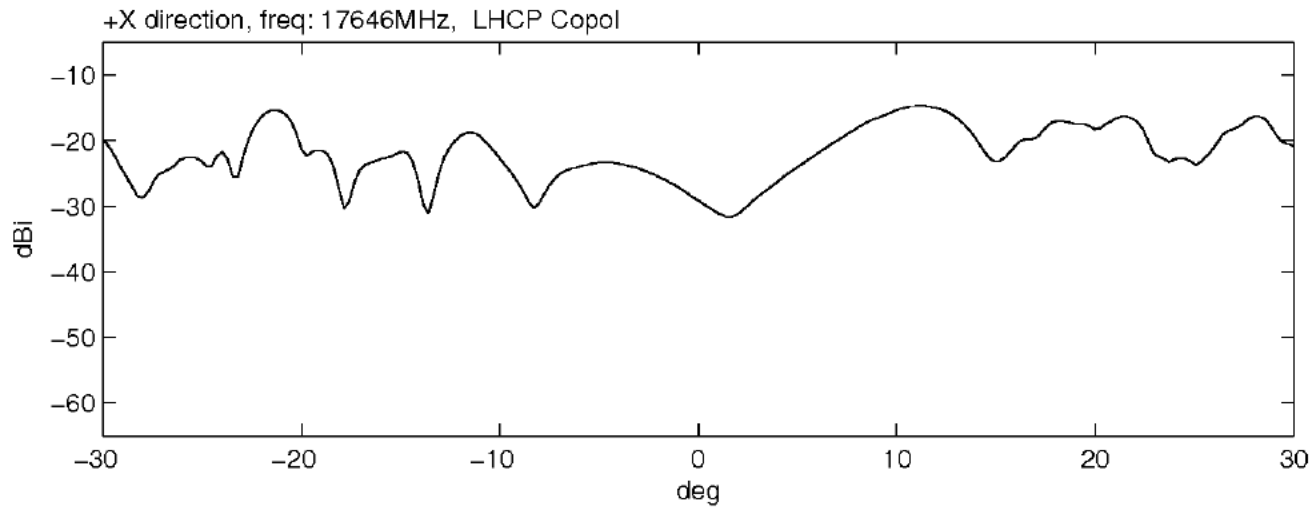

XZ-Plane, Yaw = 40 deg -x direction, Freq: 17646 MHz RHCP

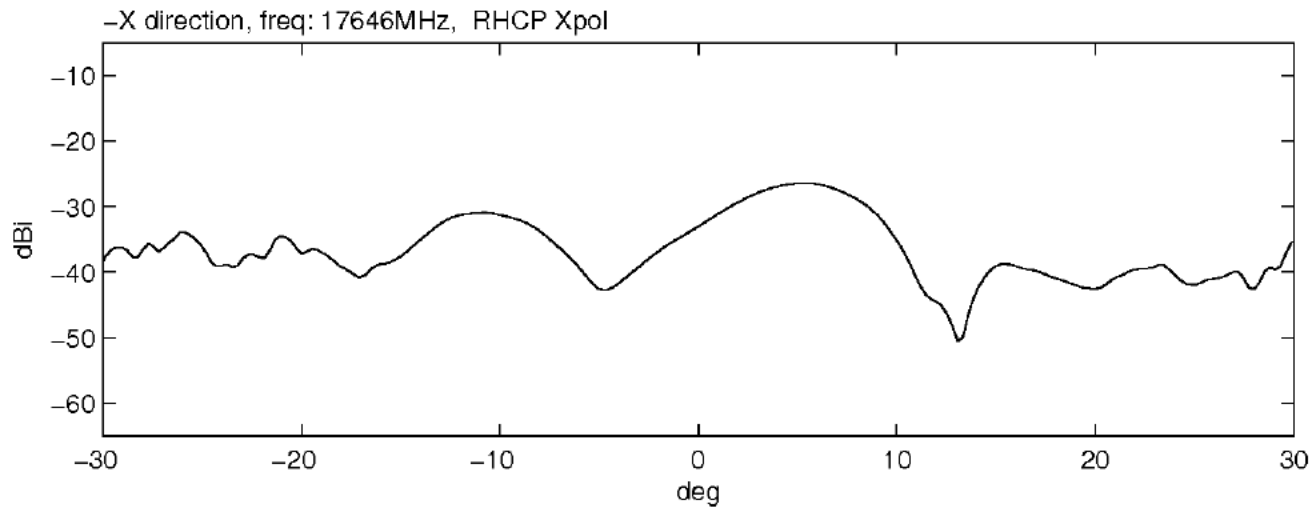
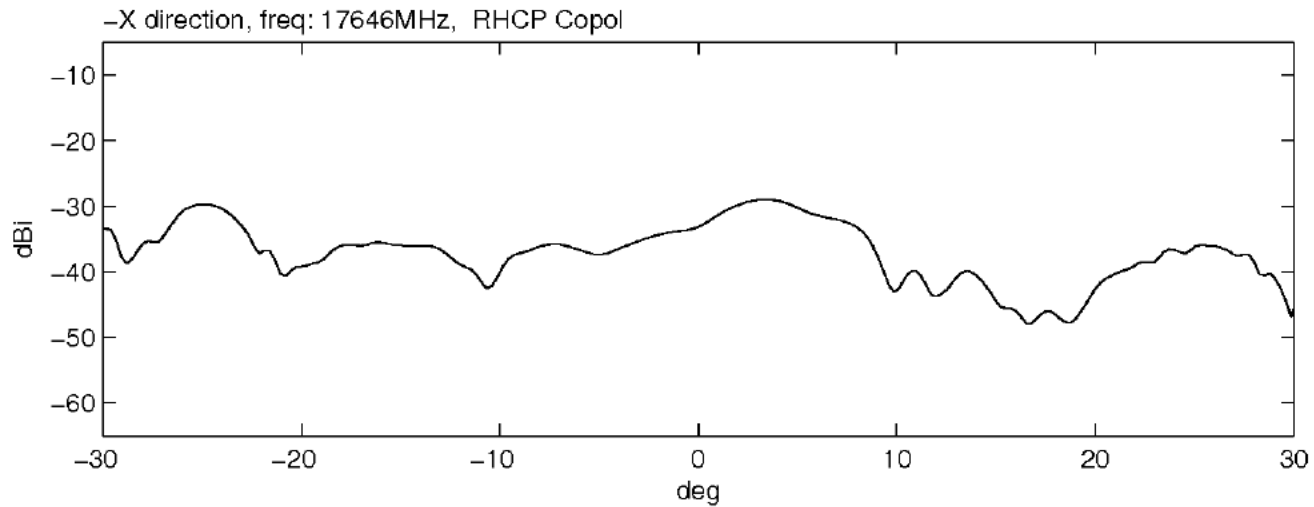

XZ-Plane, Yaw = 40 deg -x direction, Freq: 17646 MHz LHCP

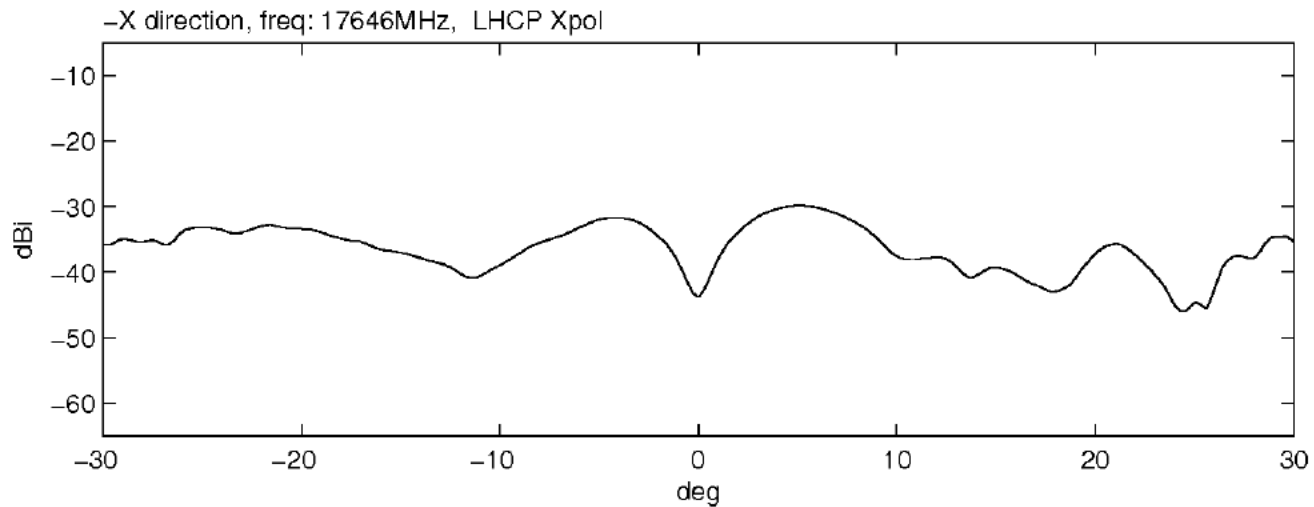
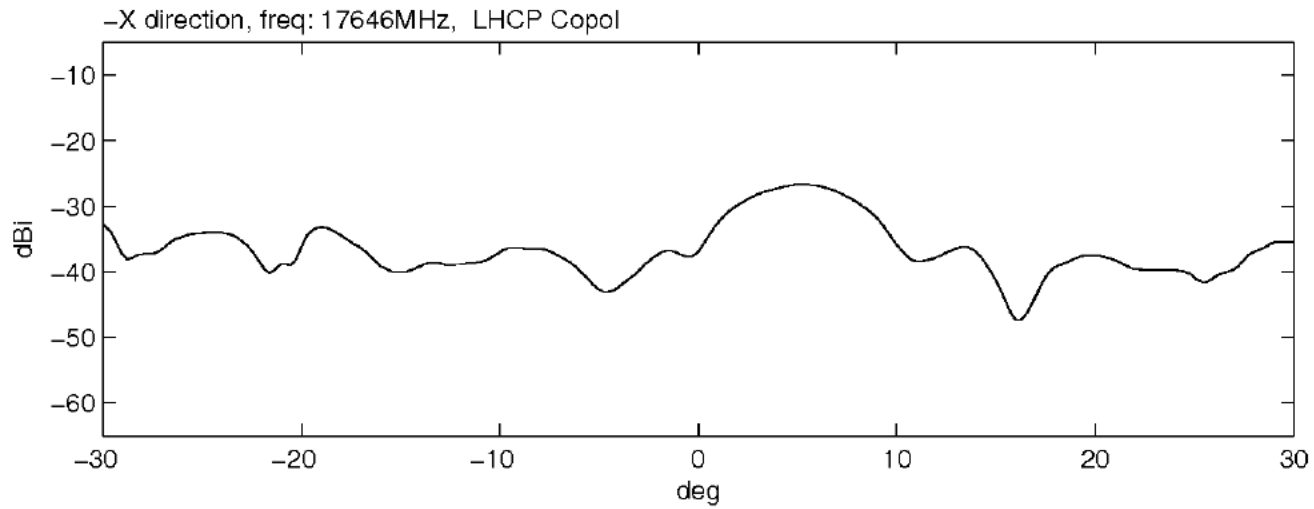

XZ-Plane, Yaw = 50 deg +x direction, Freq: 17646 MHz RHCP

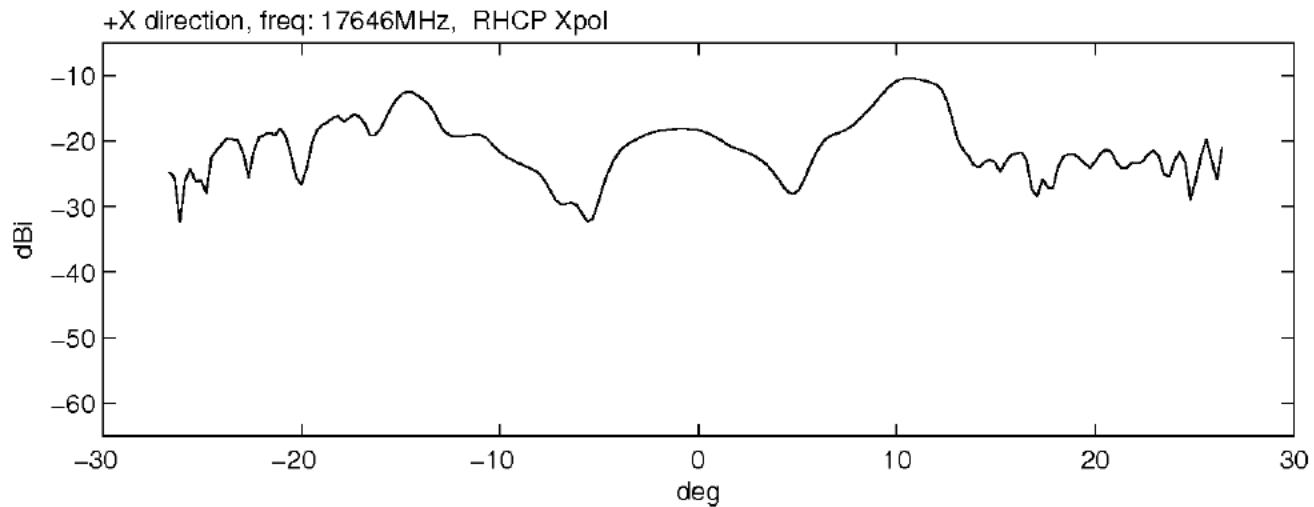
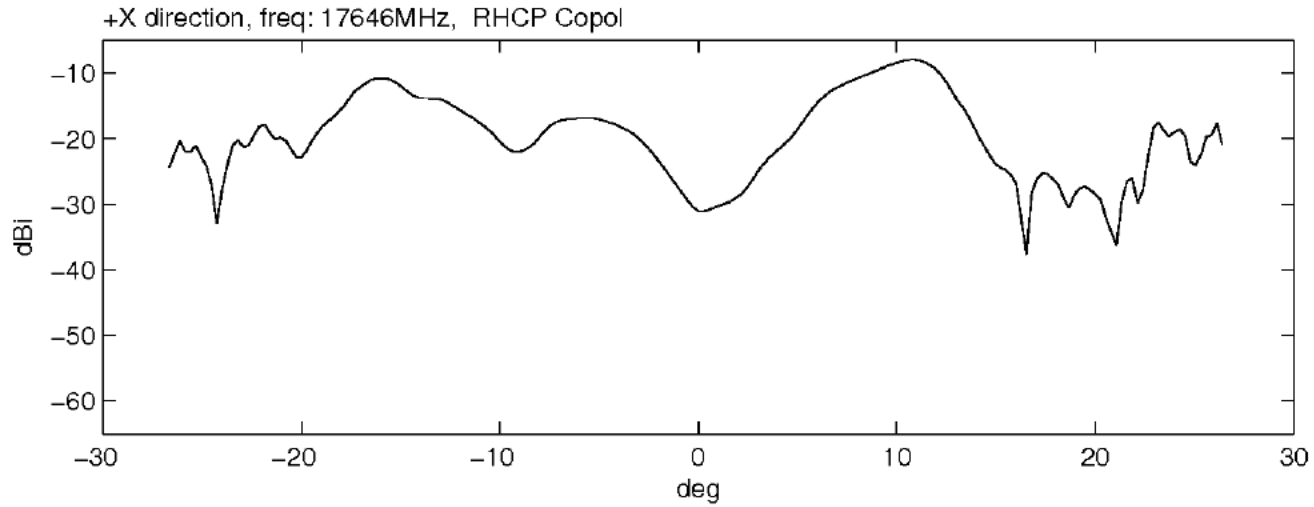

XZ-Plane, Yaw = 50 deg +x direction, Freq: 17646 MHz LHCP

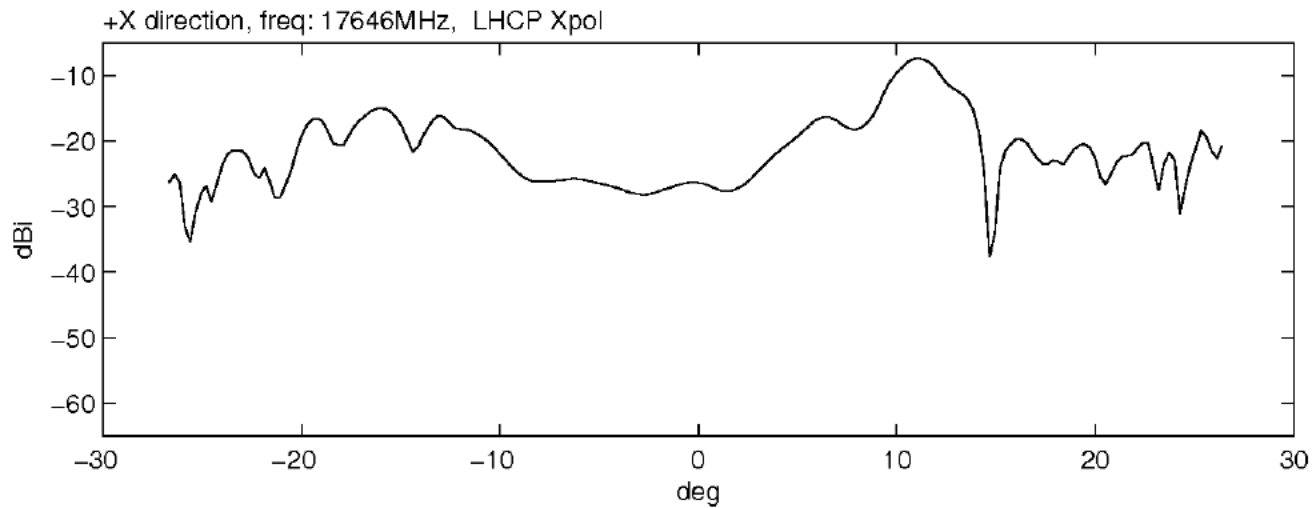
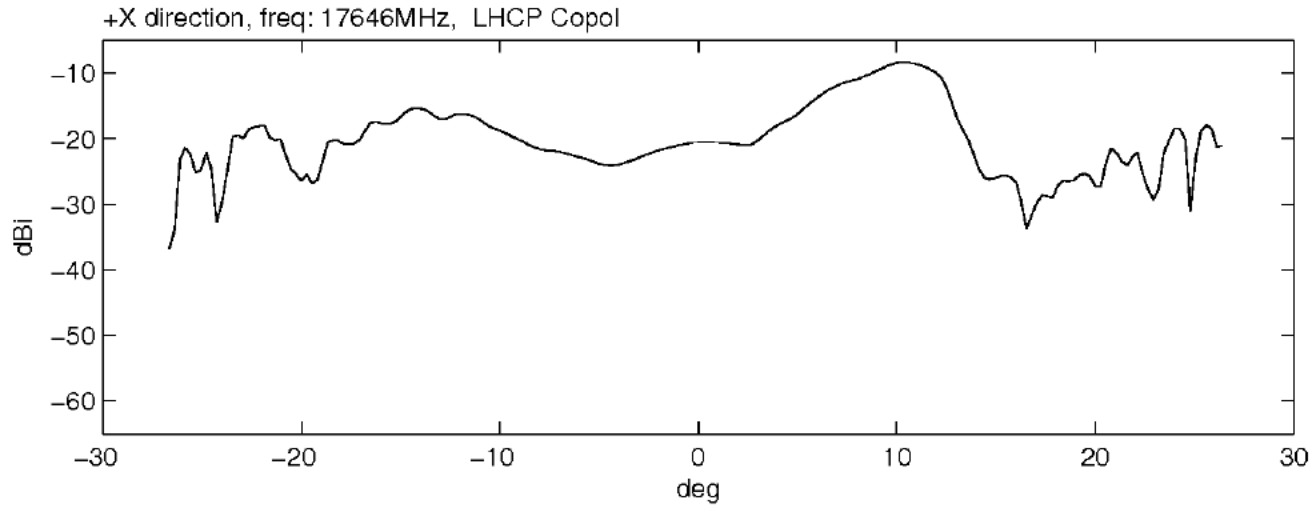

XZ-Plane, Yaw = 50 deg -x direction, Freq: 17646 MHz RHCP

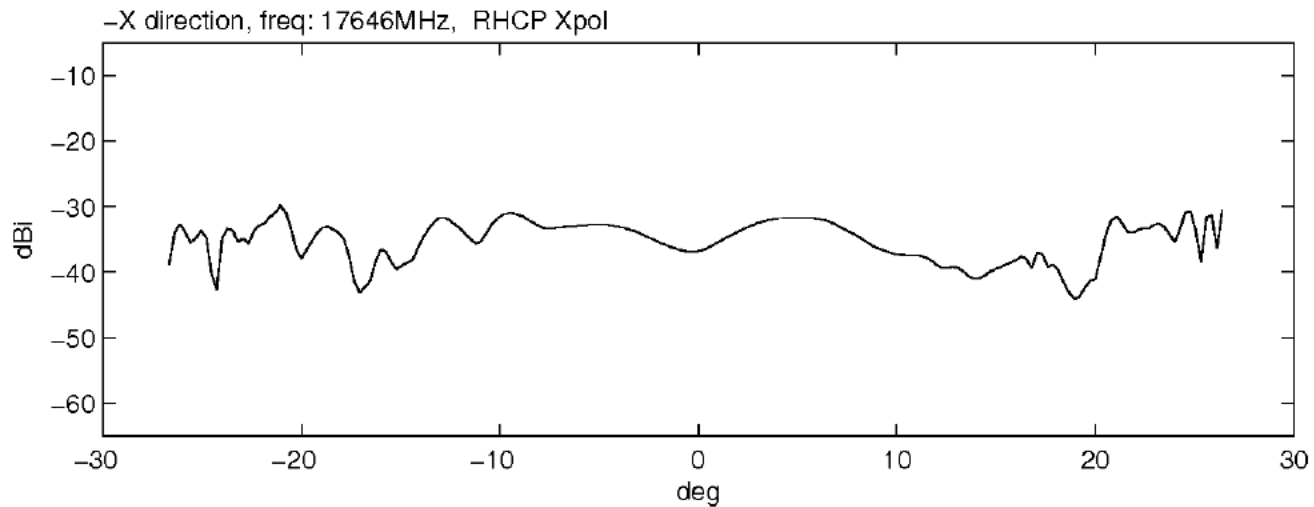
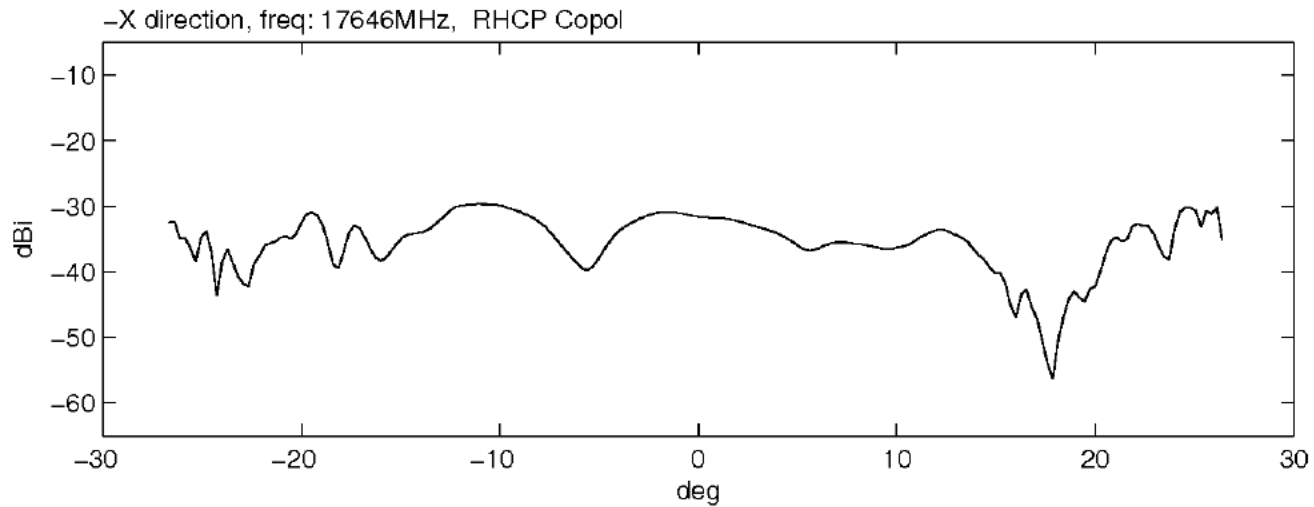

XZ-Plane, Yaw = 50 deg -x direction, Freq: 17646 MHz LHCP

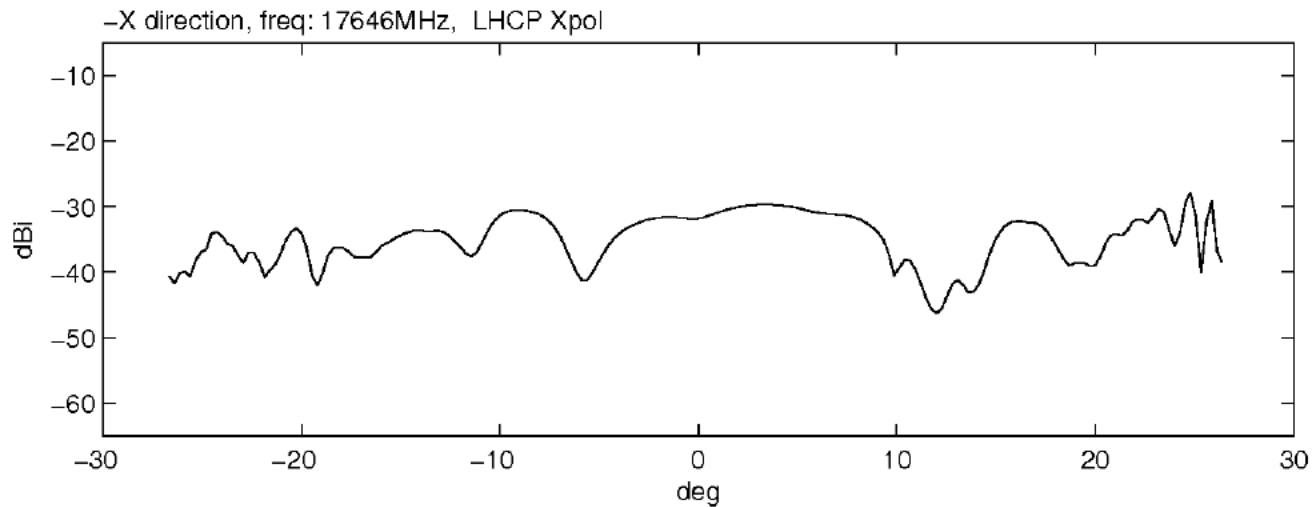
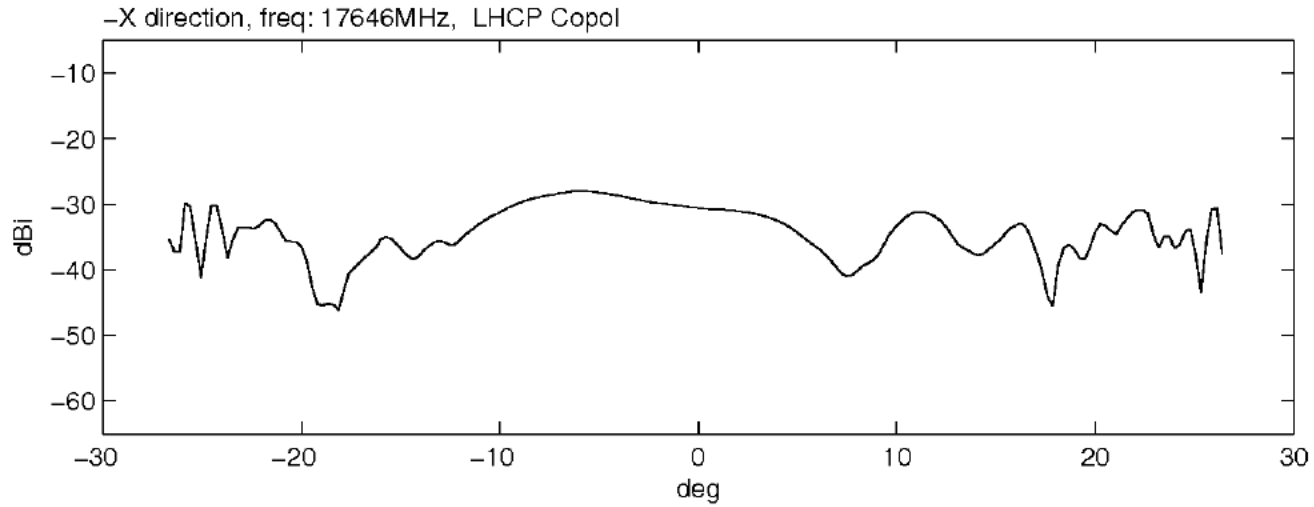

XZ-Plane, Yaw = -10 deg +x direction, Freq: 17646 MHz RHCP

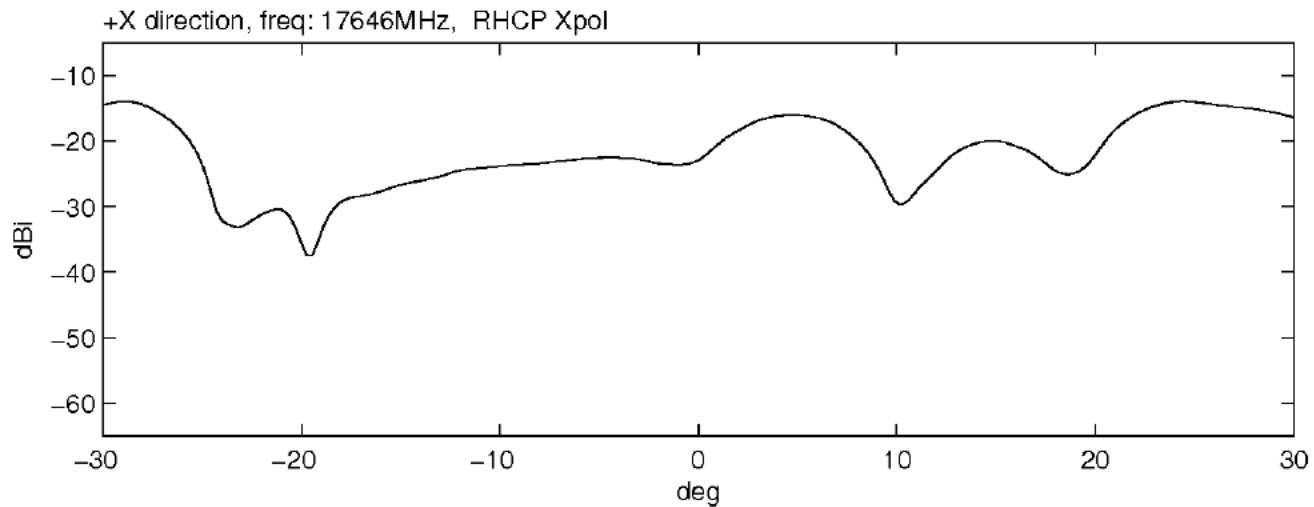
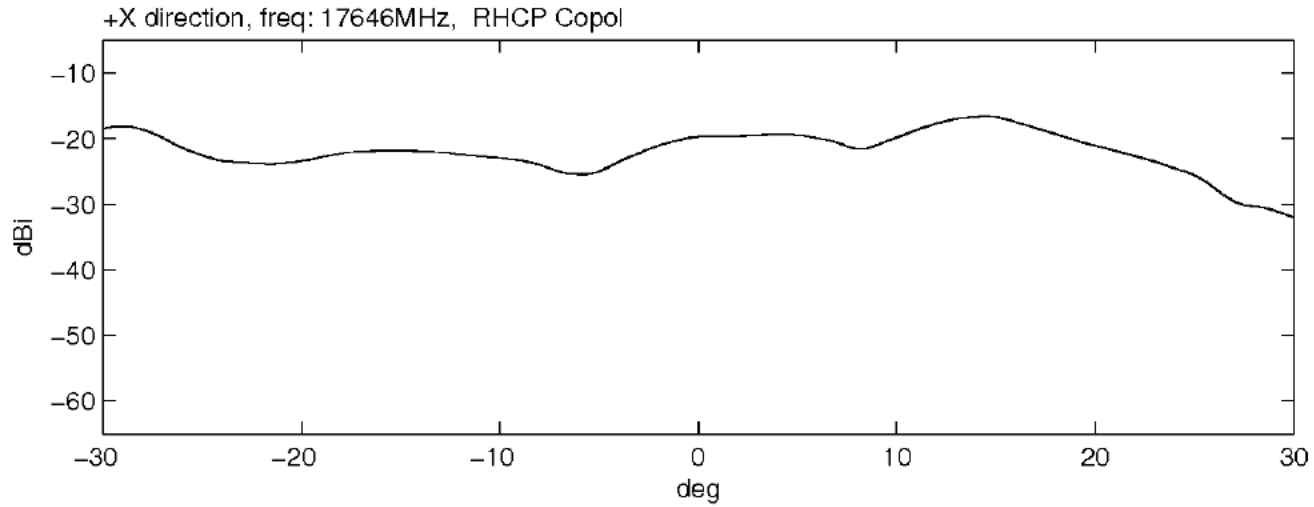

XZ-Plane, Yaw = -10 deg +x direction, Freq: 17646 MHz LHCP

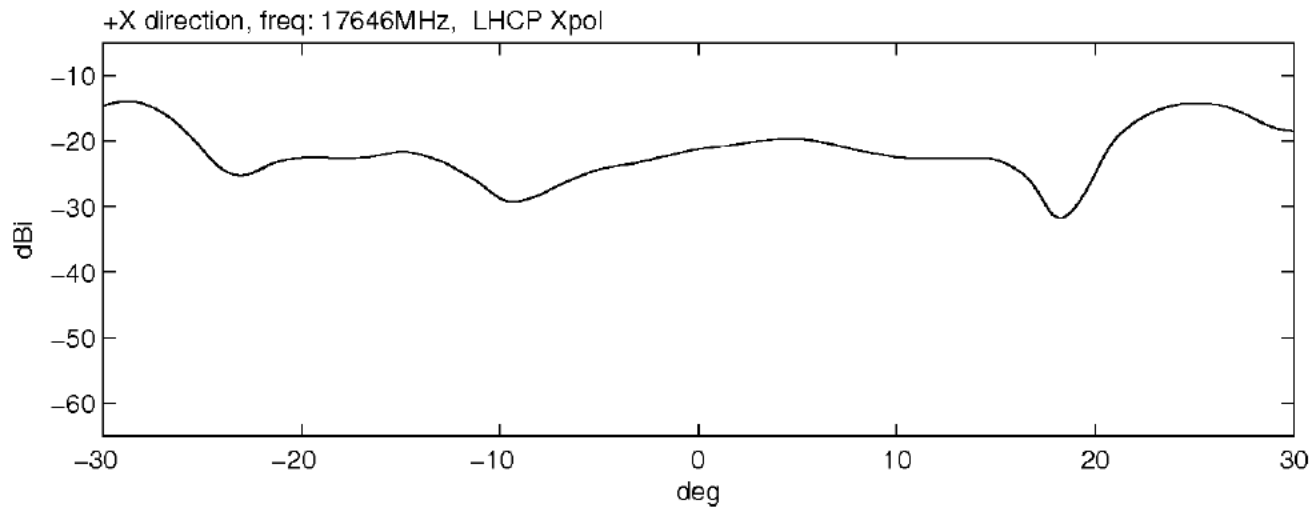
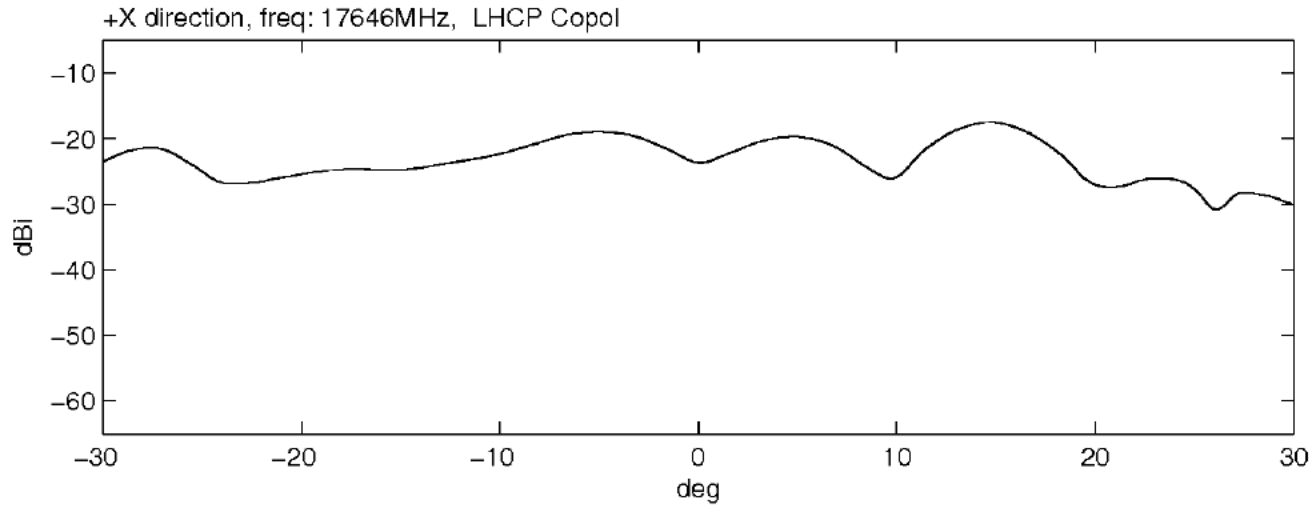

XZ-Plane, Yaw = -10 deg -x direction, Freq: 17646 MHz RHCP

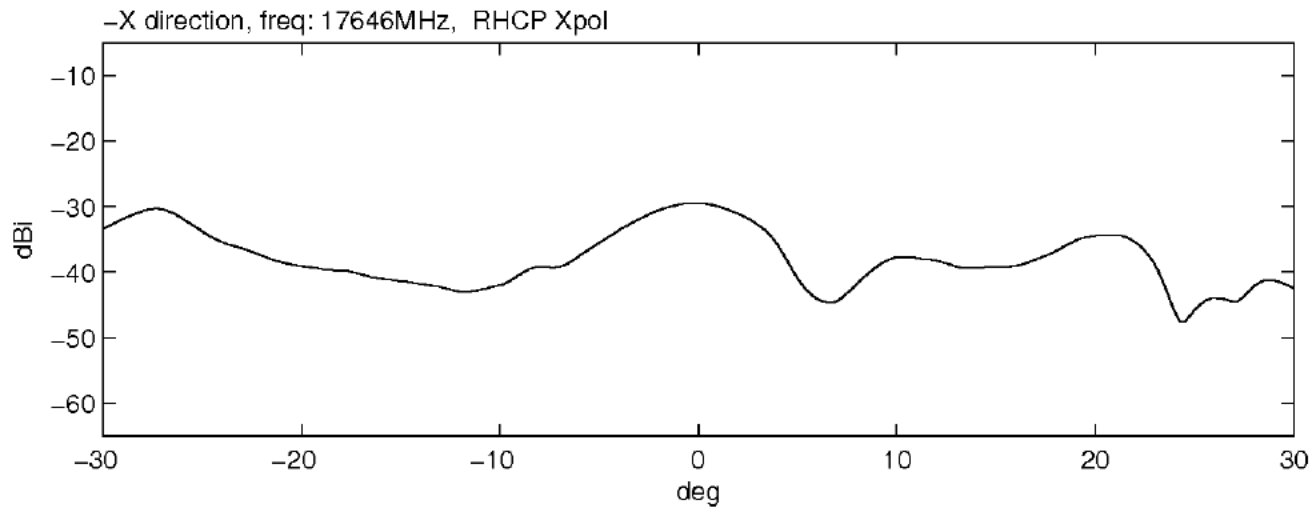
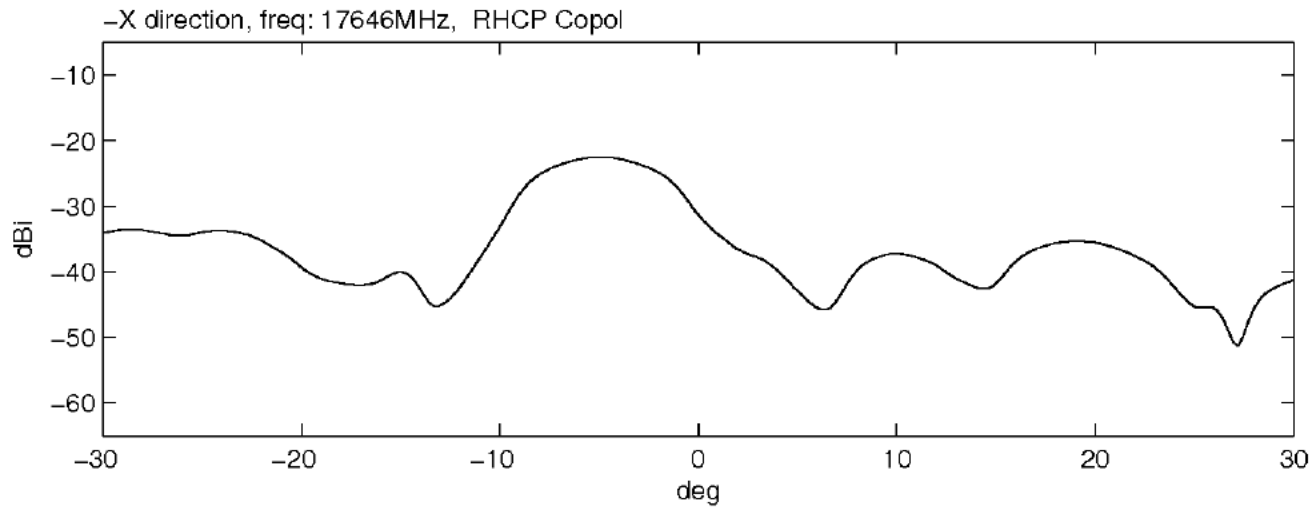

XZ-Plane, Yaw = -10 deg -x direction, Freq: 17646 MHz LHCP

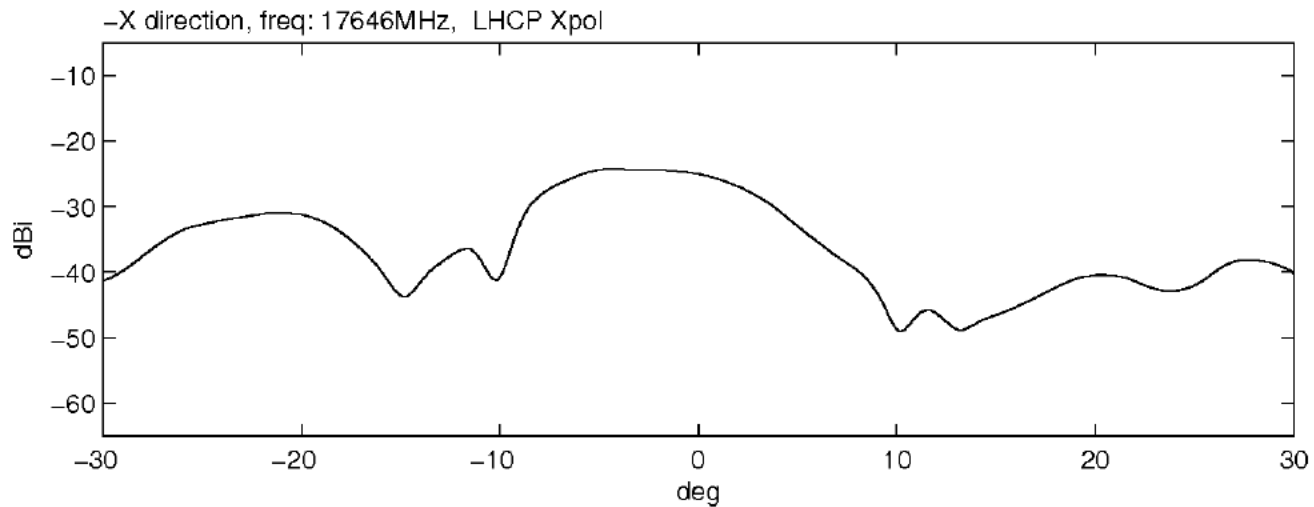
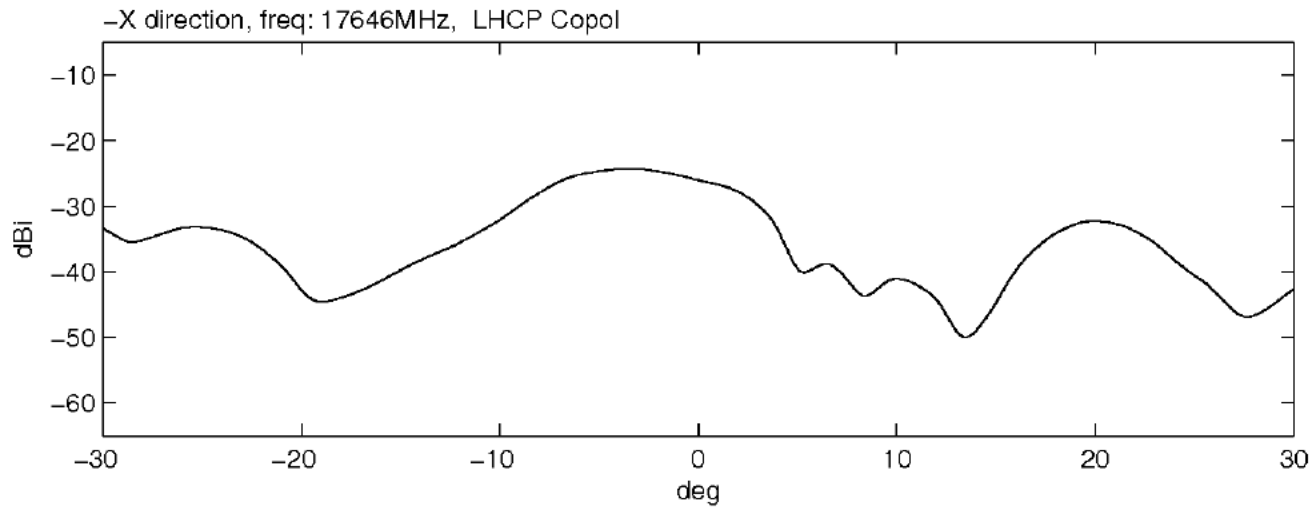

XZ-Plane, Yaw = -20 deg +x direction, Freq: 17646 MHz RHCP

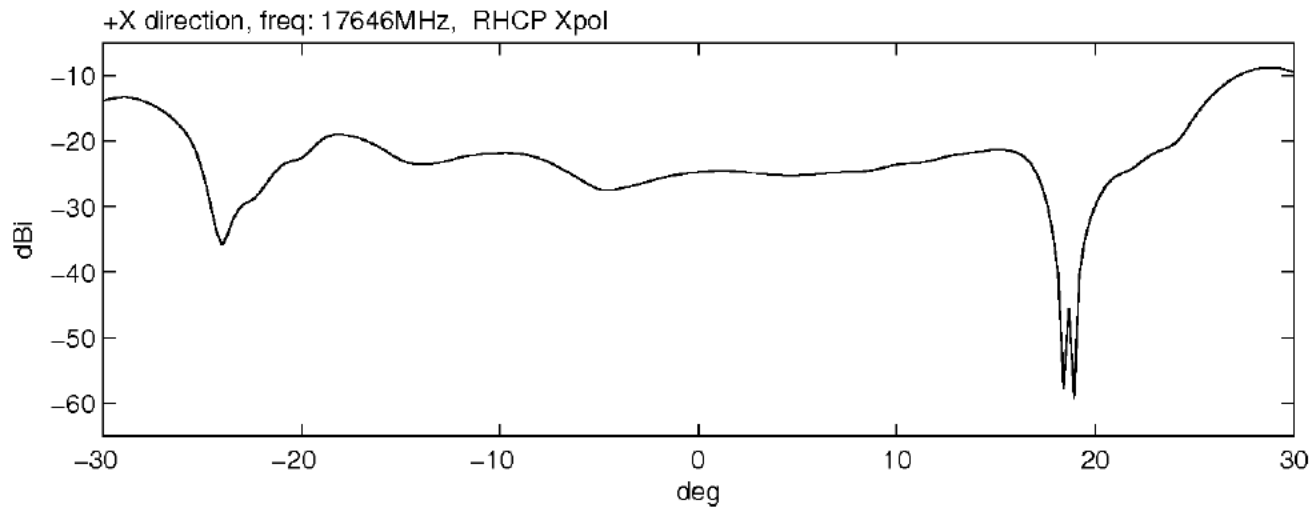
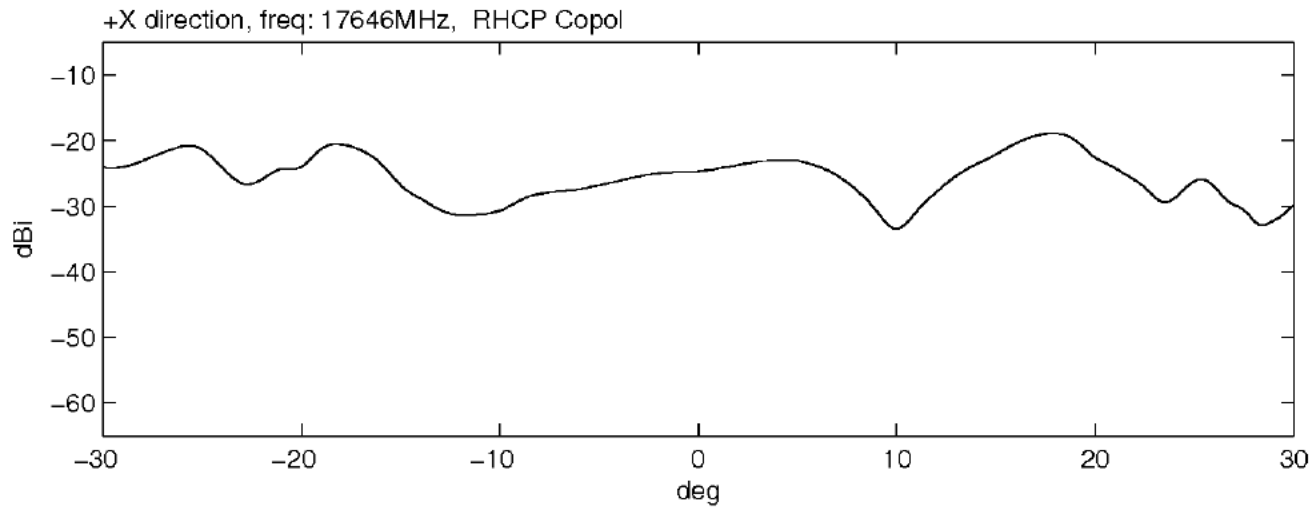

XZ-Plane, Yaw = -20 deg +x direction, Freq: 17646 MHz LHCP

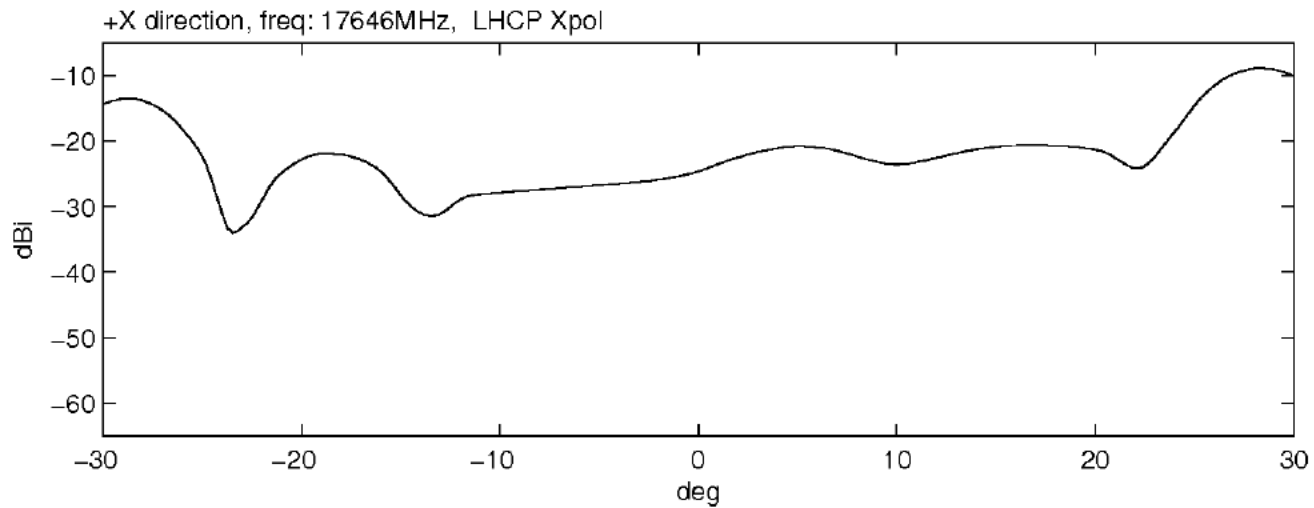
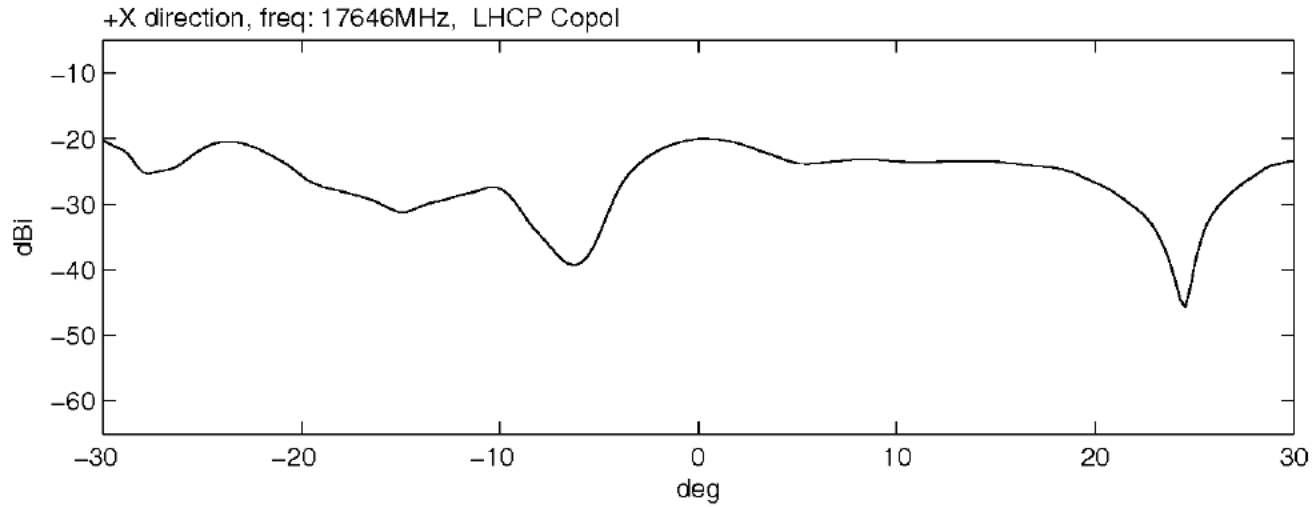

XZ-Plane, Yaw = -20 deg -x direction, Freq: 17646 MHz RHCP

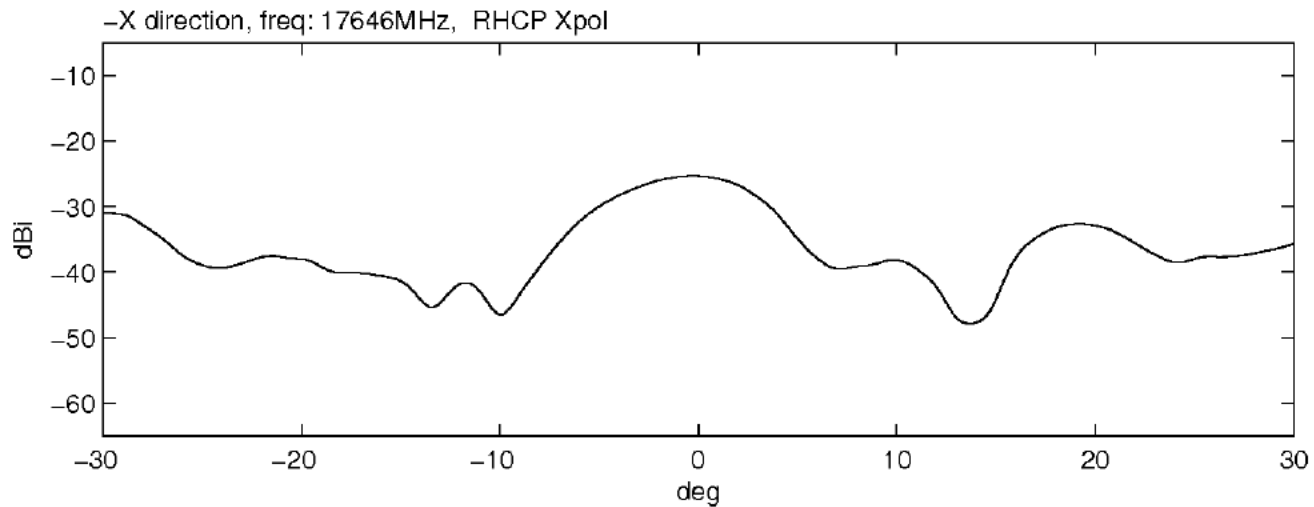
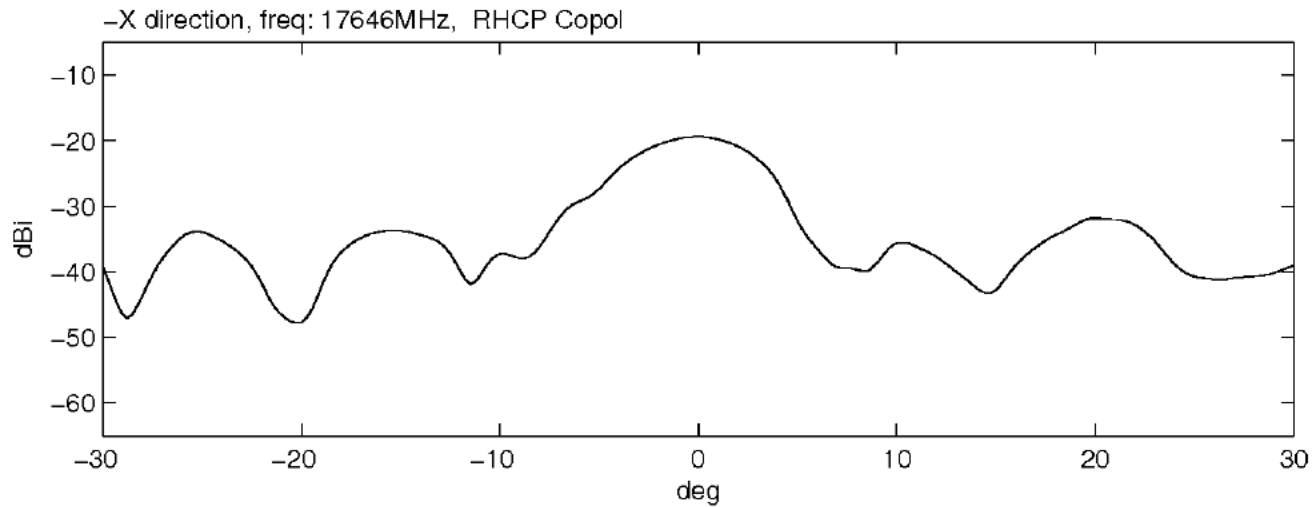

XZ-Plane, Yaw = -20 deg -x direction, Freq: 17646 MHz LHCP

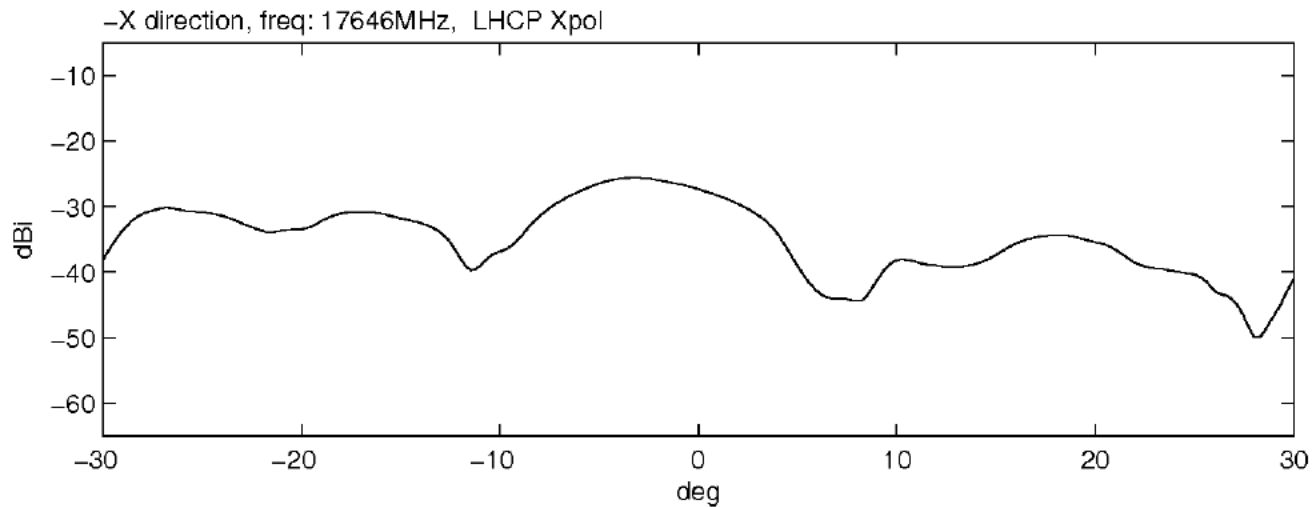
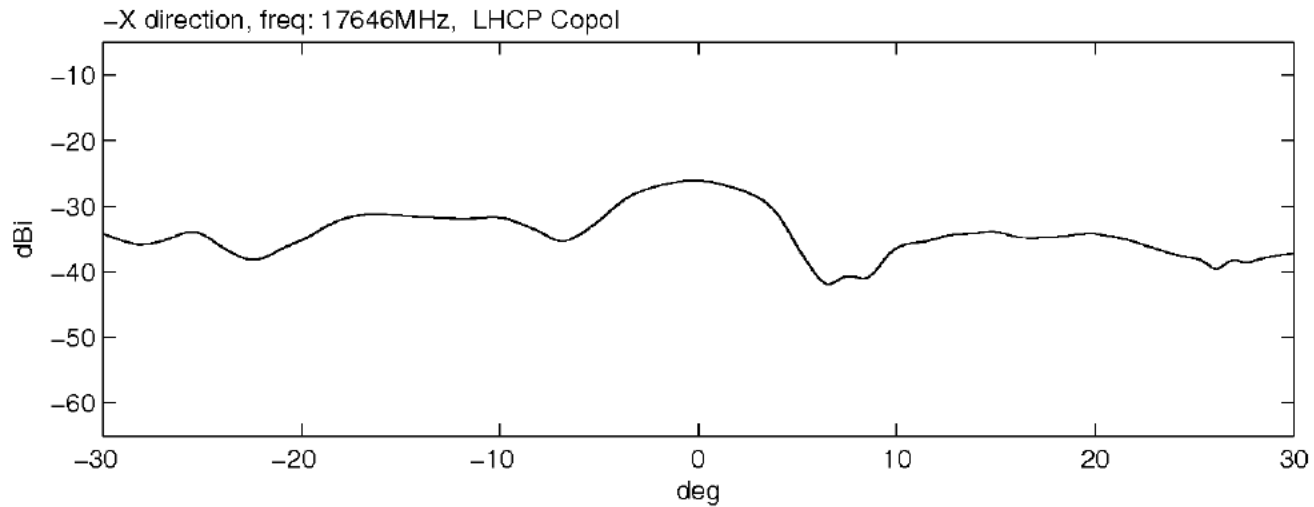

XZ-Plane, Yaw = -30 deg +x direction, Freq: 17646 MHz RHCP

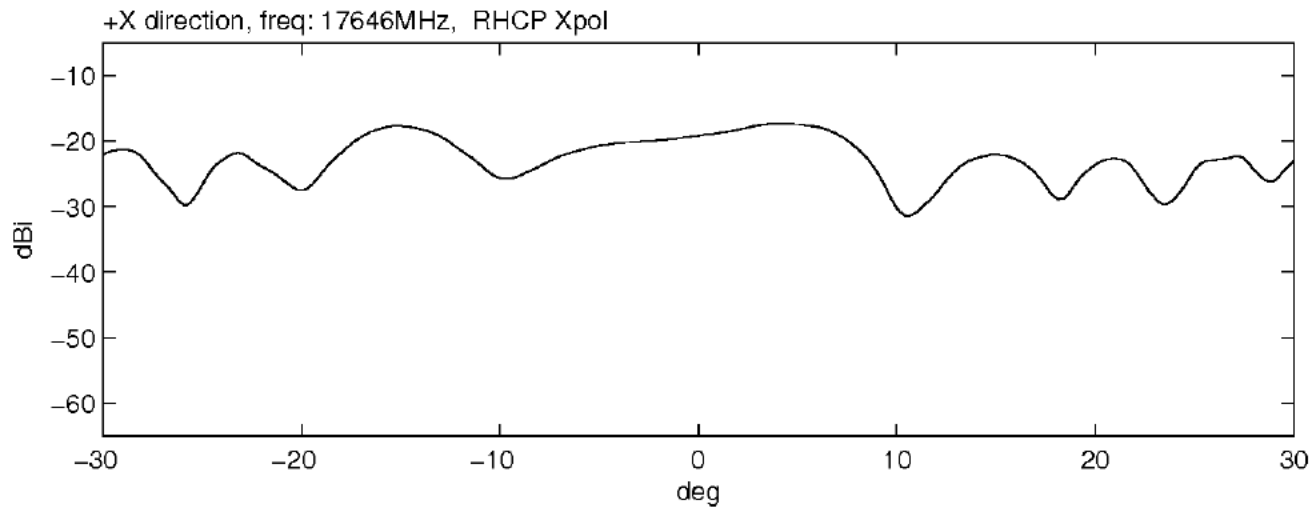
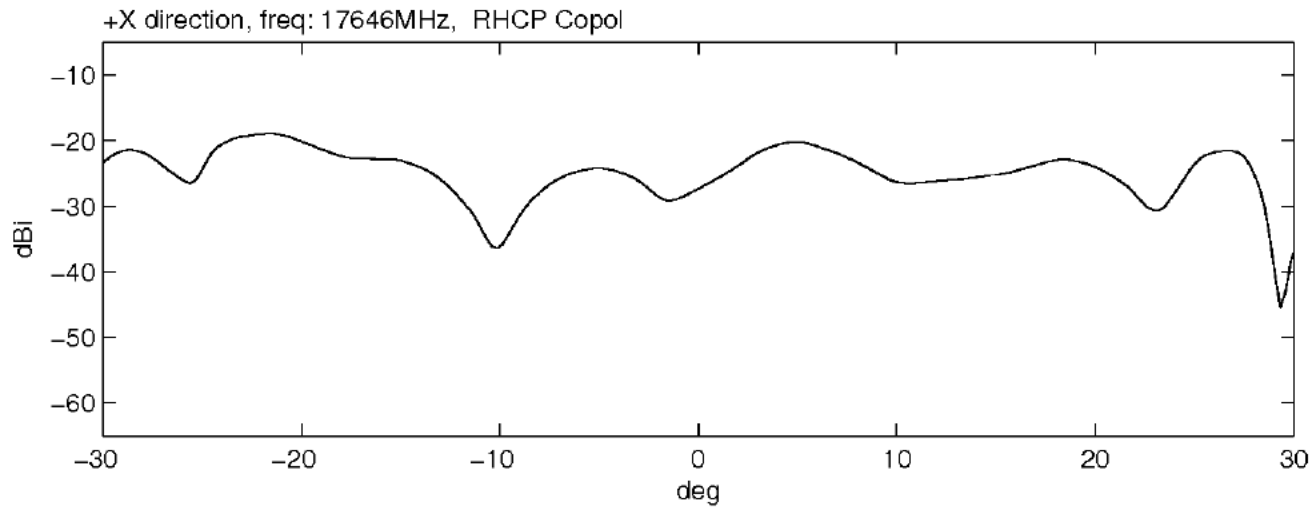

XZ-Plane, Yaw = -30 deg +x direction, Freq: 17646 MHz LHCP

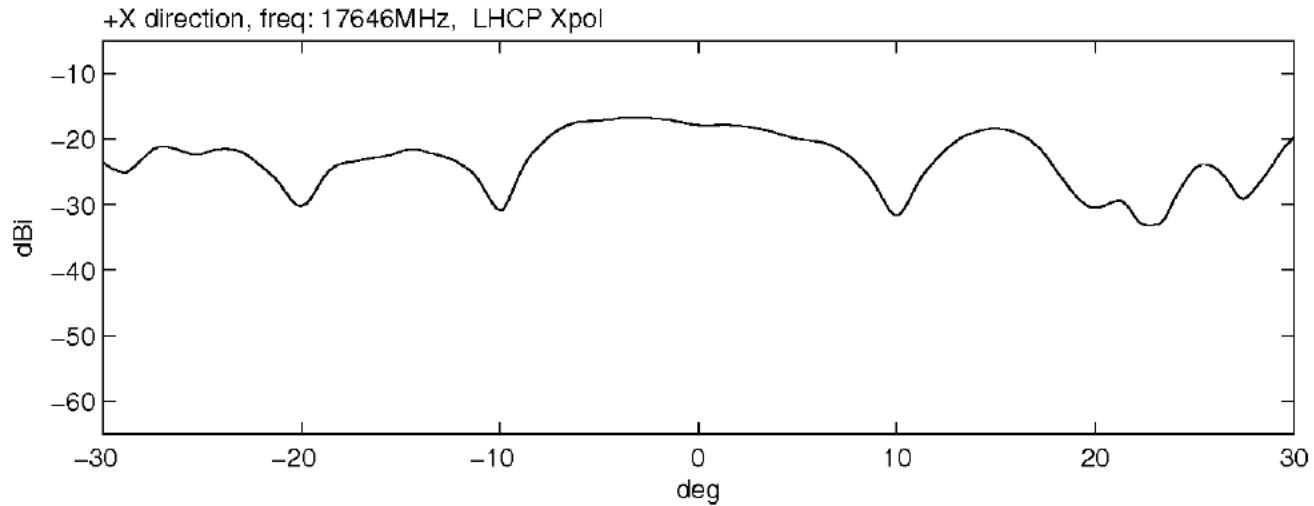
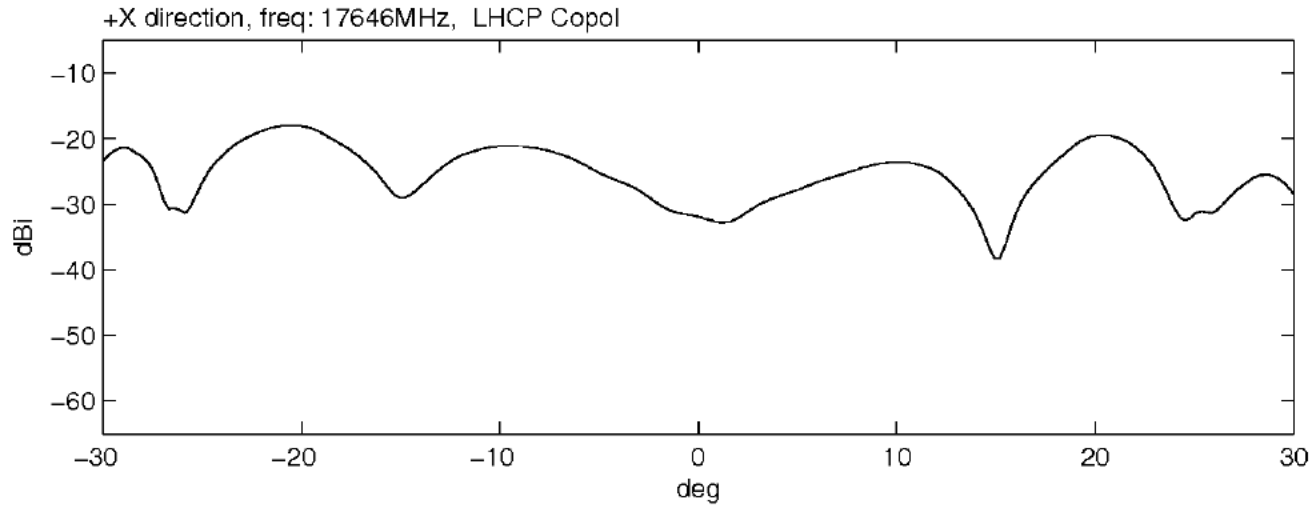

XZ-Plane, Yaw = -30 deg -x direction, Freq: 17646 MHz RHCP

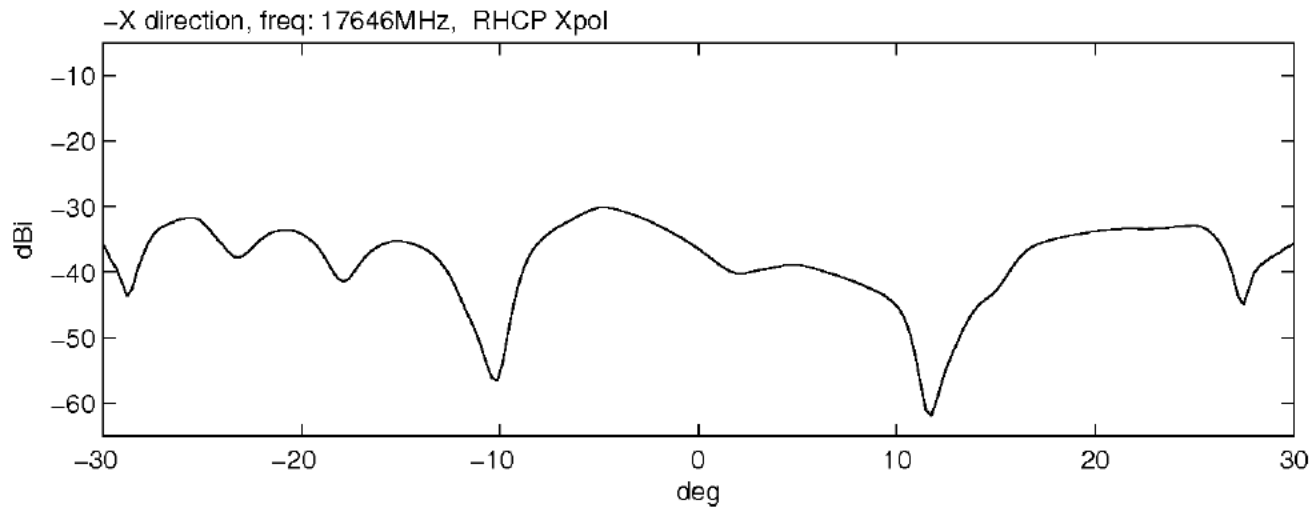
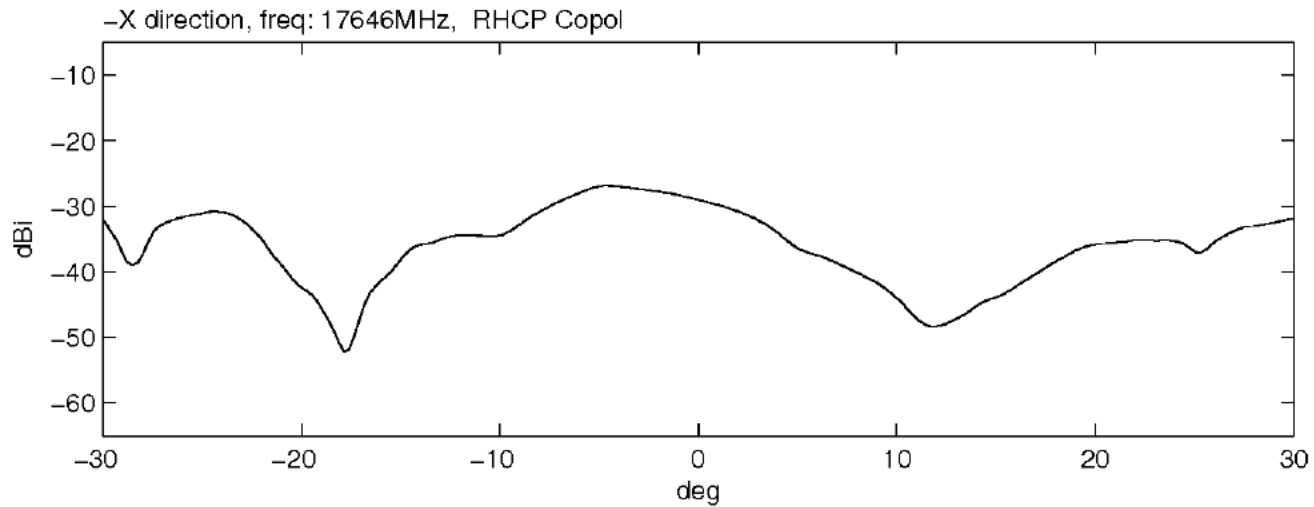

XZ-Plane, Yaw = -30 deg -x direction, Freq: 17646 MHz LHCP

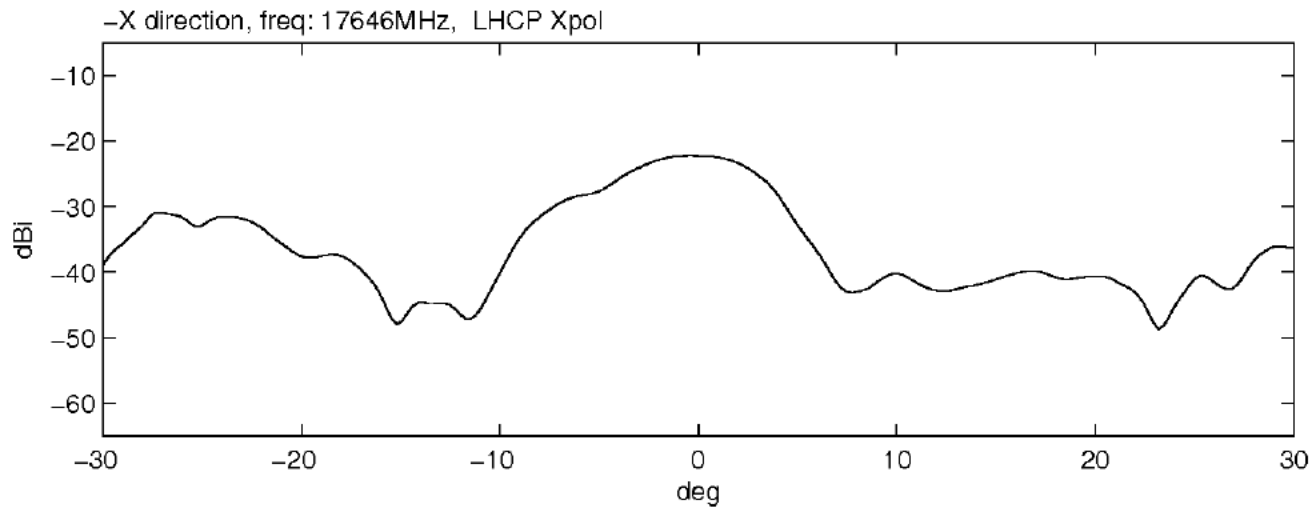
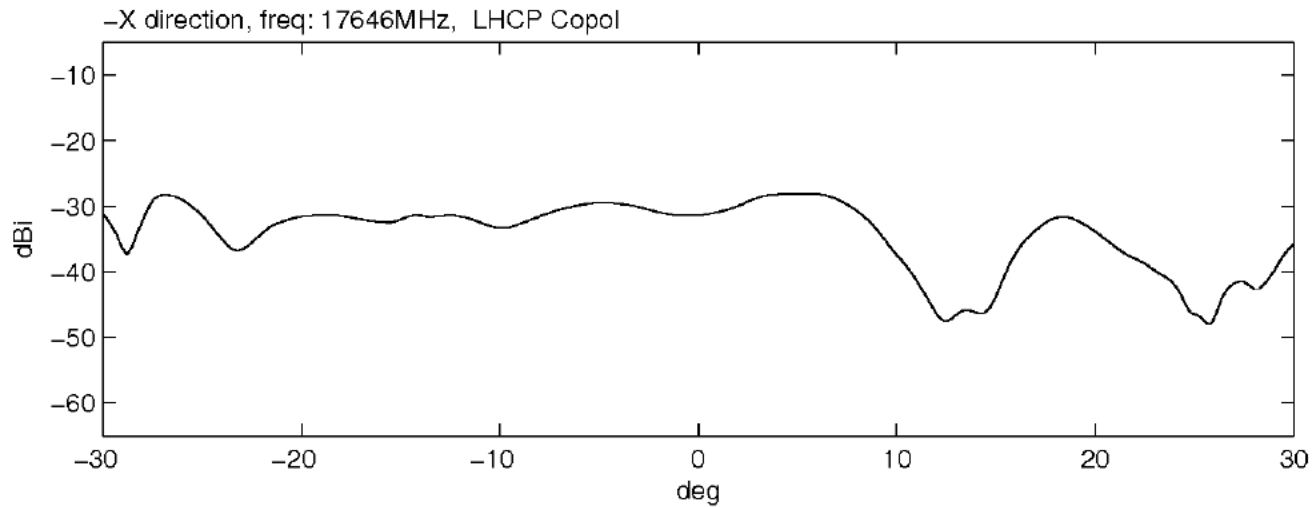

XZ-Plane, Yaw = -40 deg +x direction, Freq: 17646 MHz RHCP

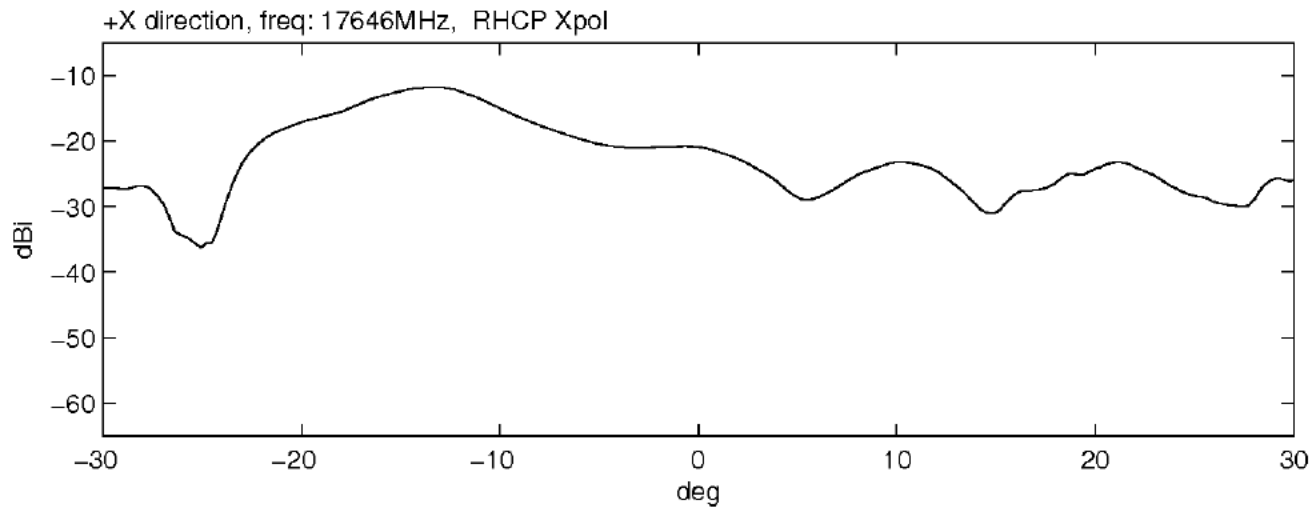
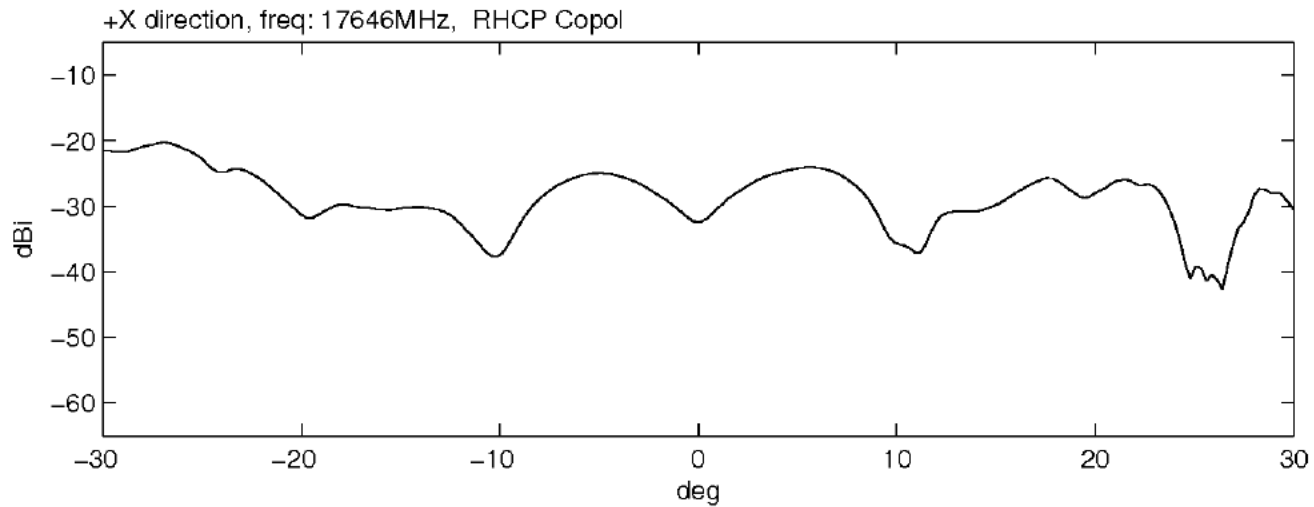

XZ-Plane, Yaw = -40 deg +x direction, Freq: 17646 MHz LHCP

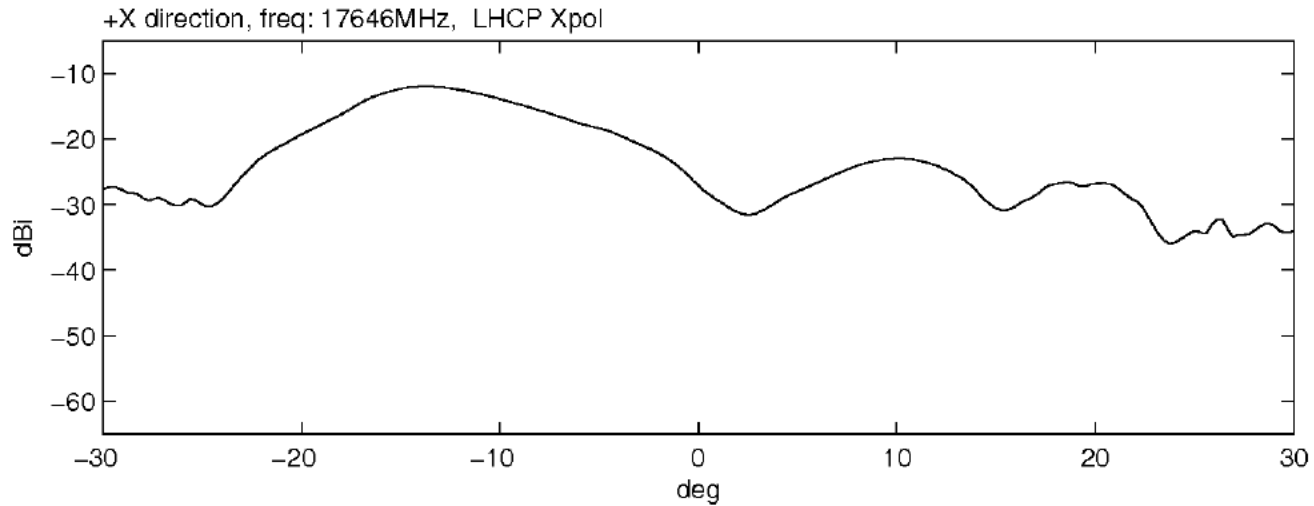
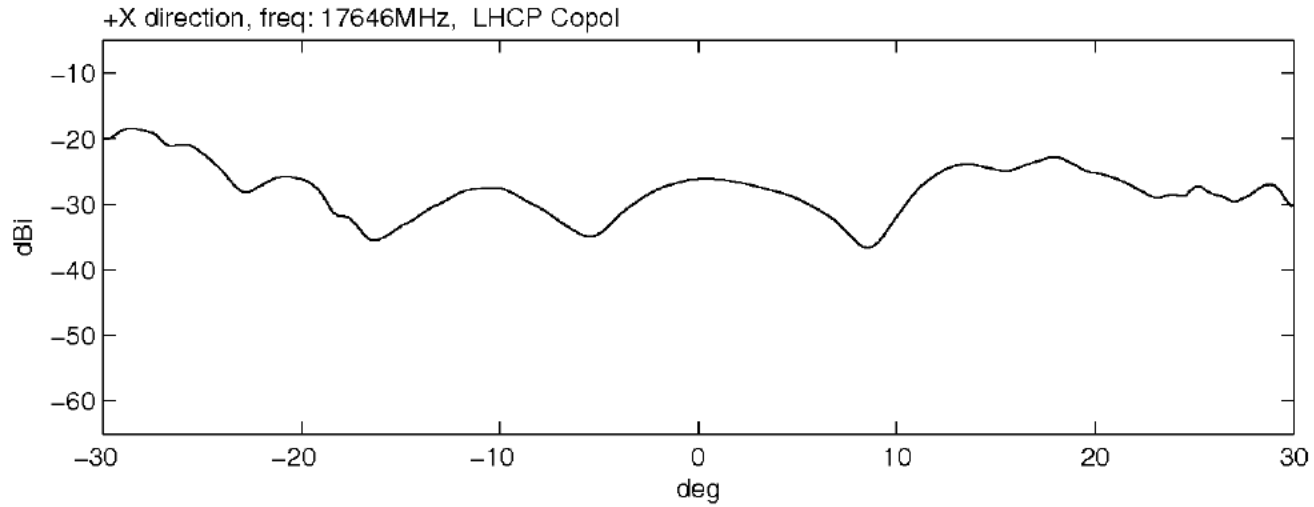

XZ-Plane, Yaw = -40 deg -x direction, Freq: 17646 MHz RHCP

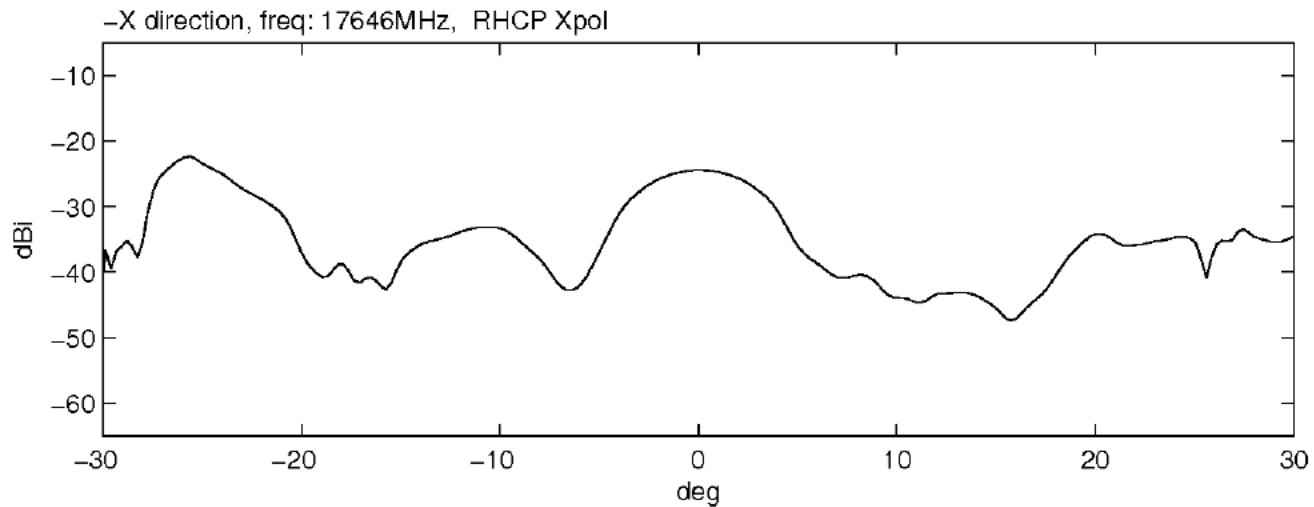
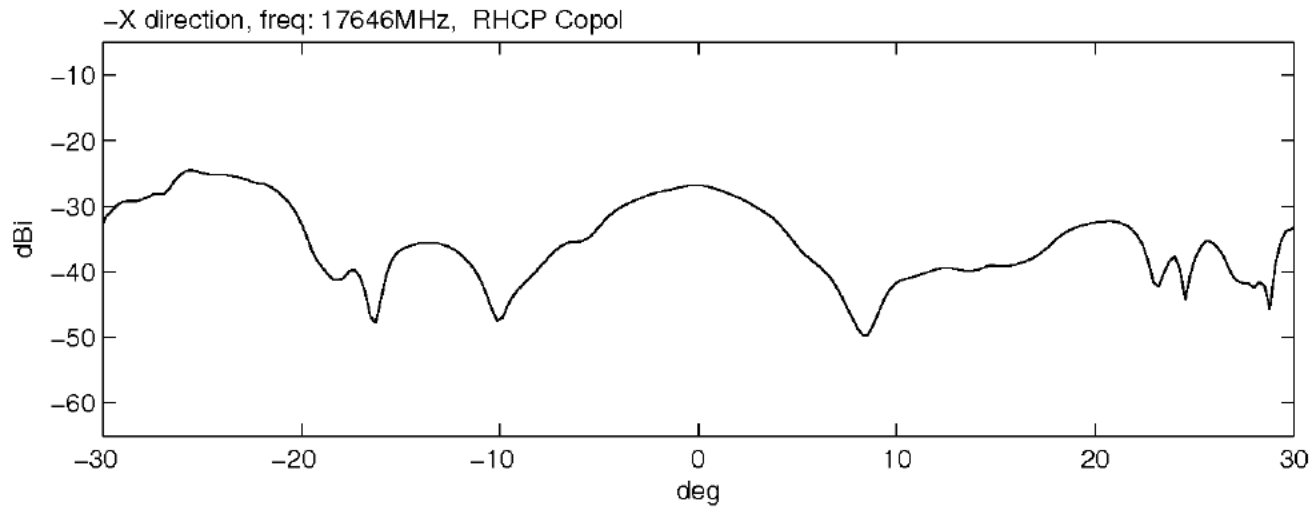

XZ-Plane, Yaw = -40 deg -x direction, Freq: 17646 MHz LHCP

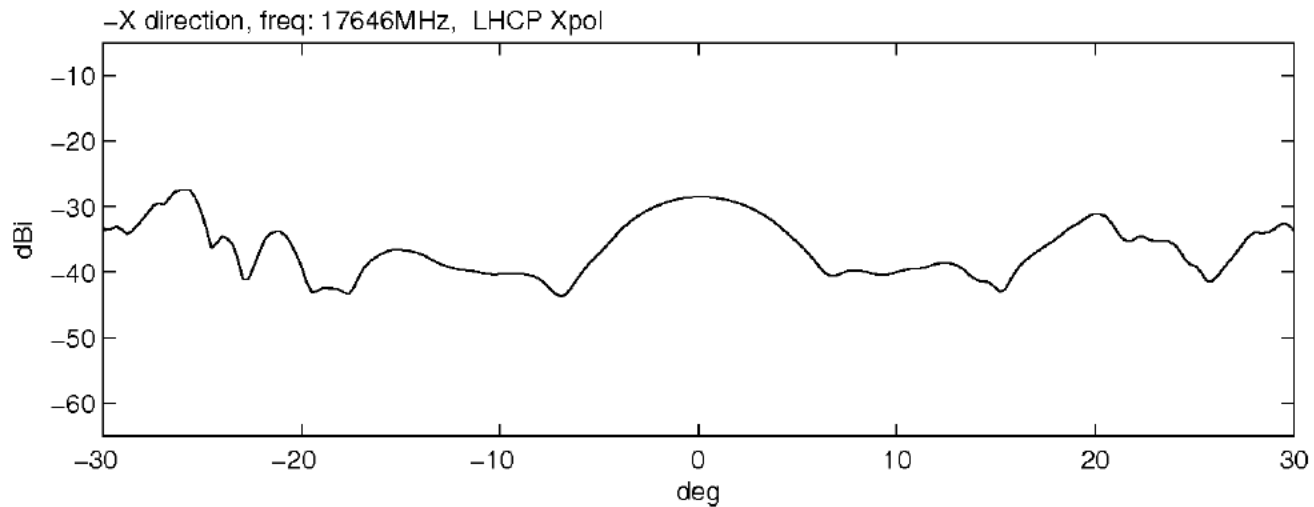
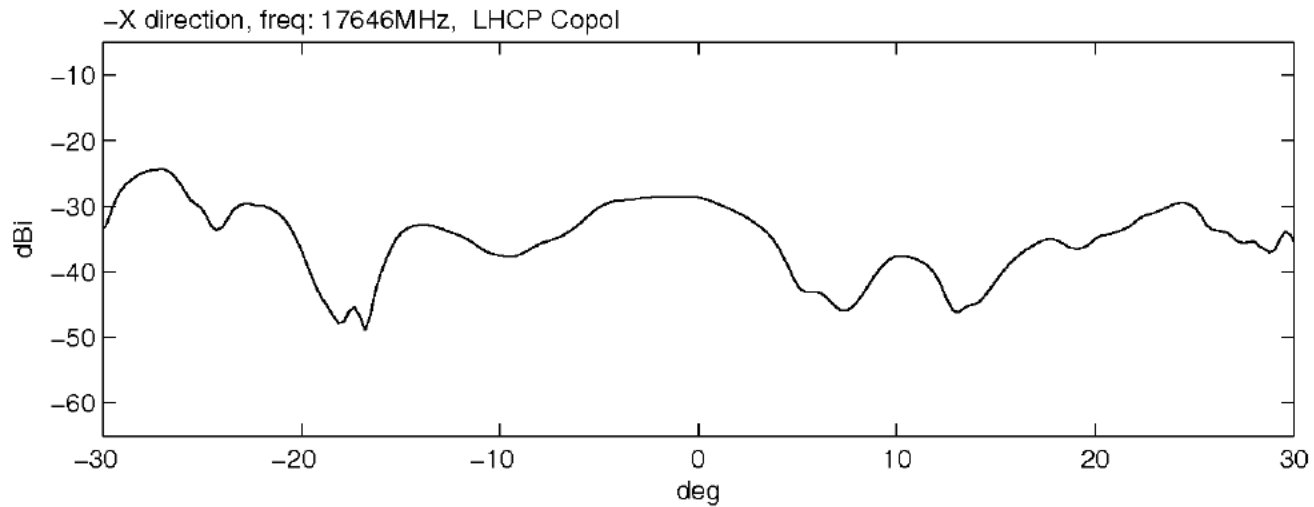

XZ-Plane, Yaw = -50 deg +x direction, Freq: 17646 MHz RHCP

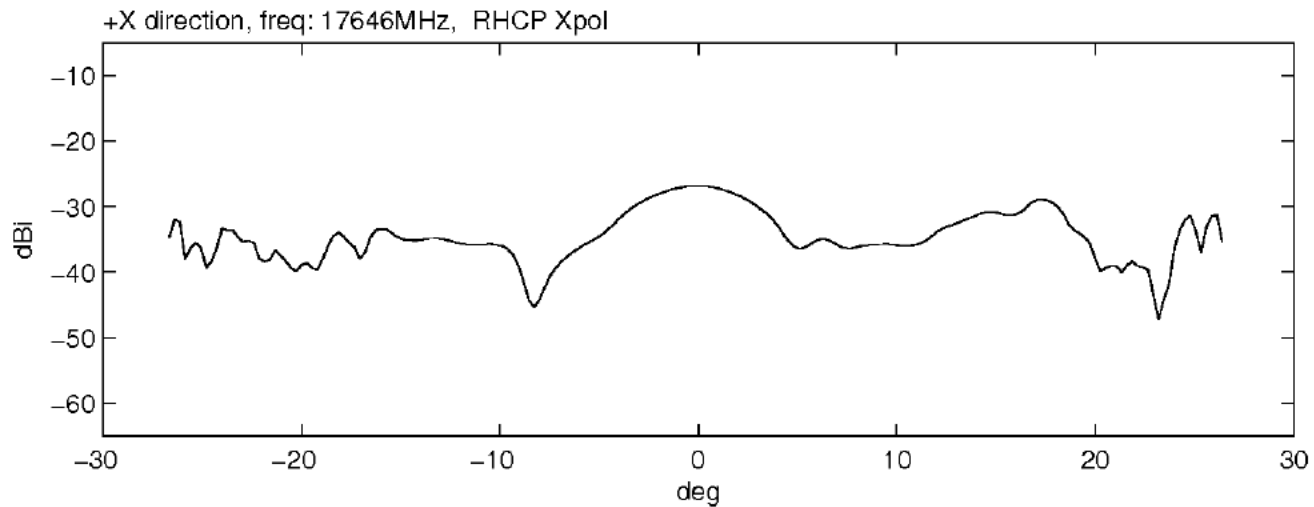
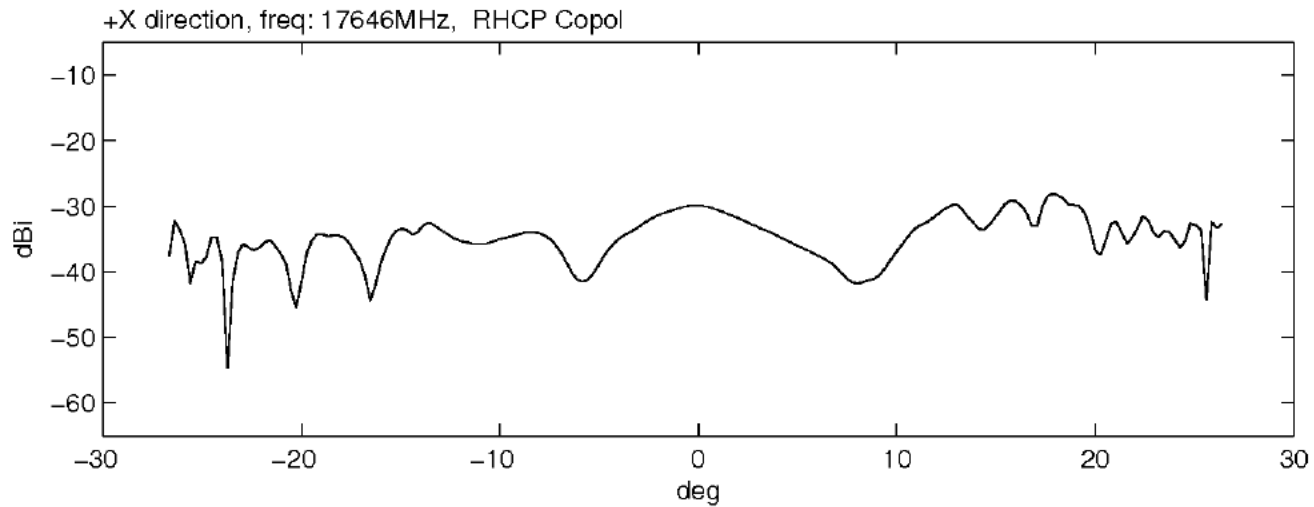

XZ-Plane, Yaw = -50 deg +x direction, Freq: 17646 MHz LHCP

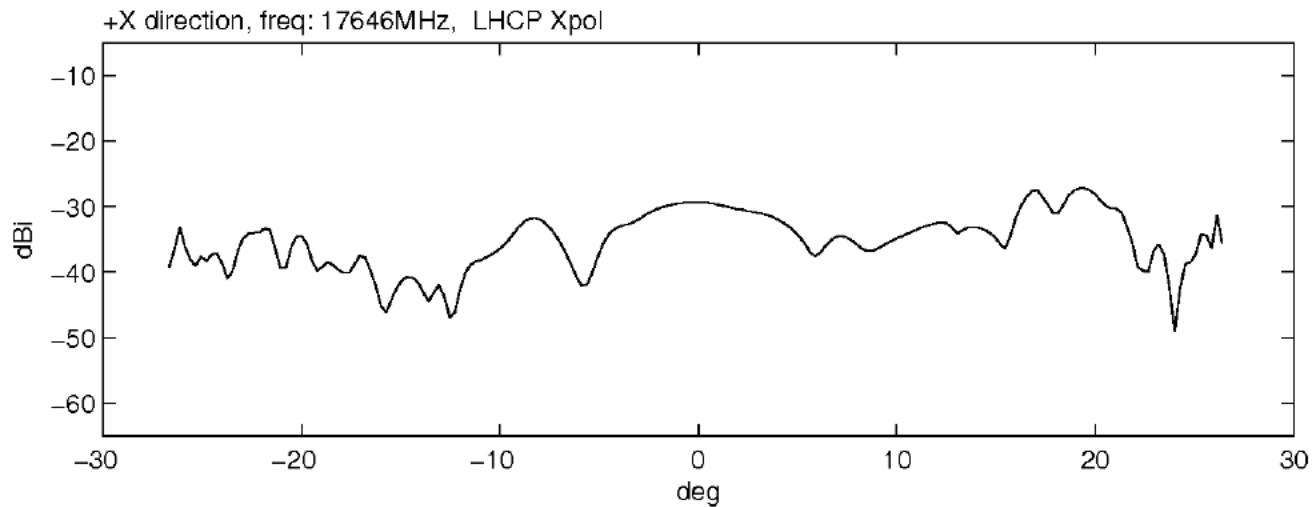
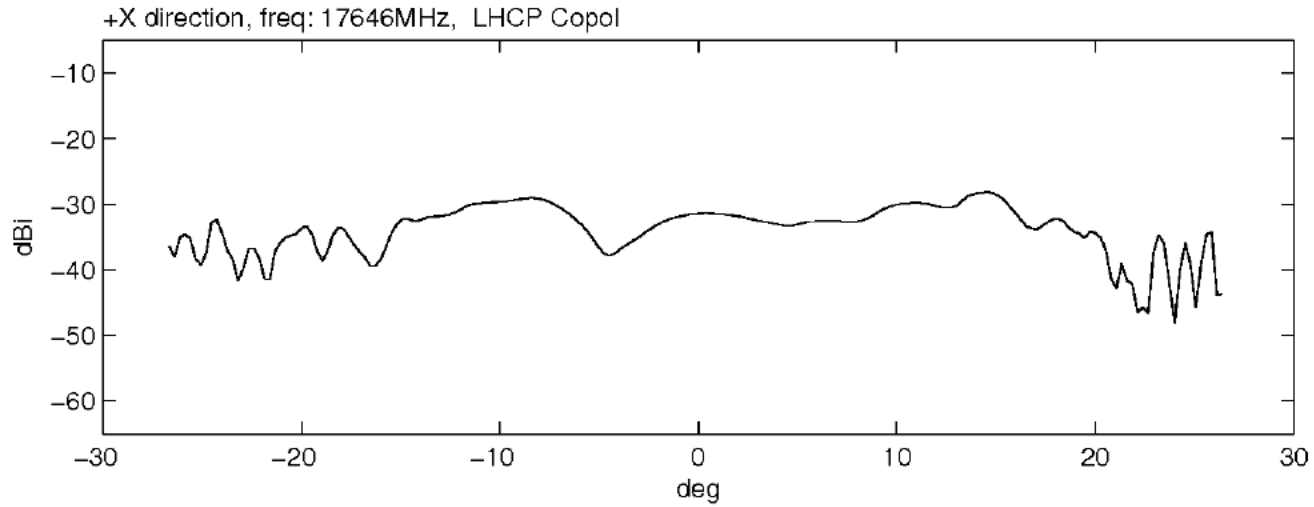

XZ-Plane, Yaw = -50 deg -x direction, Freq: 17646 MHz RHCP

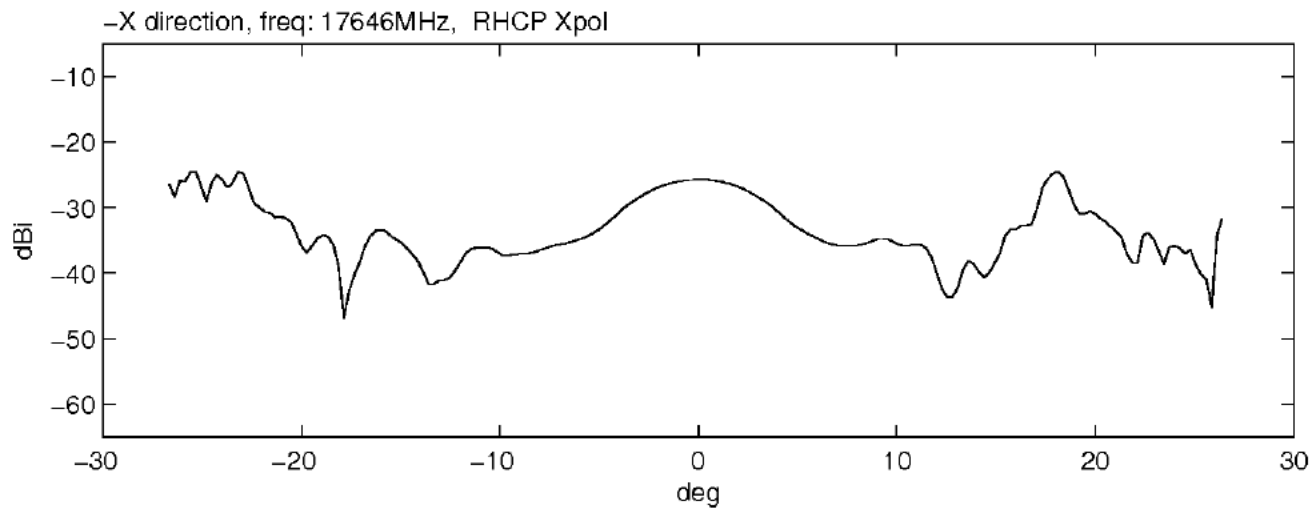
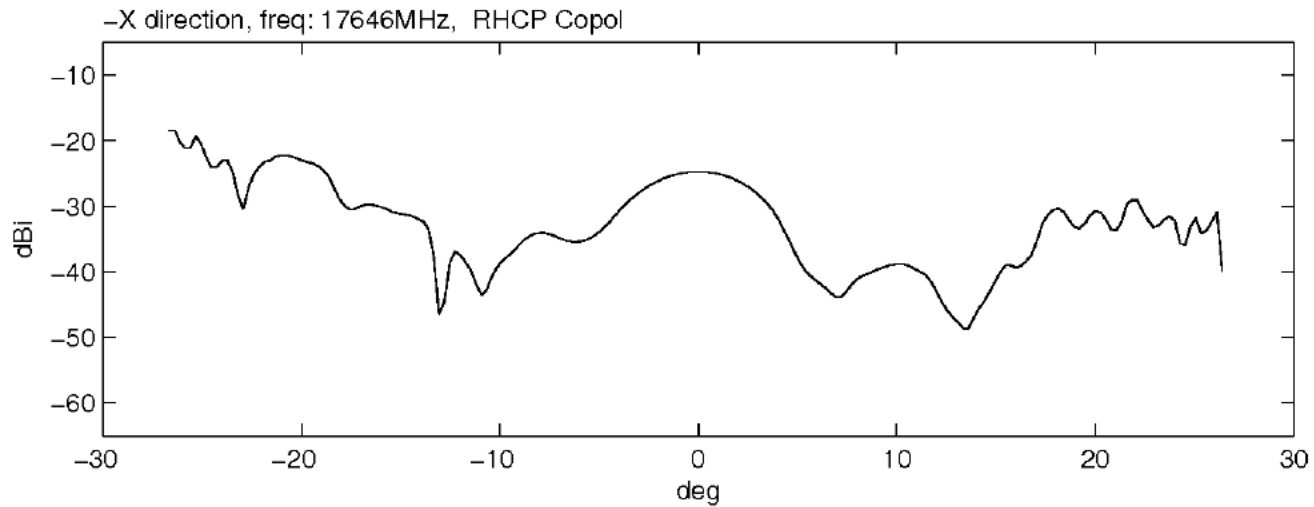

XZ-Plane, Yaw = -50 deg -x direction, Freq: 17646 MHz LHCP

