

BEFORE THE
Federal Communications Commission
WASHINGTON, D.C. 20554

In re the Application of)
)
Northrop Grumman Space & Mission) File No. SAT-LOA-19970904-00082
Systems Corporation)
)
For Authority to Operate a Geostationary)
Satellite in the Fixed-Satellite Service)

AMENDMENT

Northrop Grumman Space & Mission Systems Corporation, by counsel and through its Northrop Grumman Space Technology sector (“NGST”), hereby amends, pursuant to Section 25.116 of the Commission’s Rules (47 C.F.R. § 25.116) and the January 29, 2004 Public Notice affording the V-band applicants until March 15, 2004 to amend their applications,¹ its above-captioned application for authority to launch and operate a geostationary-orbit (“GSO”) satellite at the 15° E.L. orbital location as part of its proposed Ka-band/V-band hybrid fixed-satellite service (“FSS”) network,² provisionally called the Global EHF Satellite Network (“GESN”). In this Amendment, which is one of five associated amendments that NGST is filing with regard to its GESN system on this date, NGST clarifies the spectrum requirements for the system by amending its V-band frequency plan to conform to the Commission’s recently adopted allocation plan and provides additional or revised technical information concerning the system. NGST also updates certain corporate information to reflect recent minor changes in the officers and directors, and in the stock ownership of its parent company.

¹ See Public Notice, Report No. SPB-199, *International Bureau Invites Applicants to Amend Pending V-band Applications* (released January 29, 2004).

² As used herein, “Ka-band” refers to the FSS Earth-to-space band at 27.5-30 GHz (including the primary non-GSO segment at 28.6-29.1 GHz) and the FSS space-to-Earth band at 17.7-20.2 GHz (including the primary non-GSO band at 18.8-19.3 GHz). “V-band” refers to the FSS Earth-to-space band at 47.2-50.2 GHz and the FSS space-to-Earth band at 37.5-42 GHz.

This Amendment to the V-band GSO spacecraft that NGST seeks to operate at the 15° E.L. orbital location is associated with – indeed, it is interconnected with – four additional amendments that NGST is filing on this date with respect to the non-GSO component of GESN and GSO satellites at three other orbital locations. As reflected collectively in NGST’s five concurrently-filed Amendments, the GESN system will now have a total of seven spacecraft (down from 19 as originally filed). Three satellites will operate in HEO orbits, and four satellites will operate in geostationary orbits at 119° W.L., 89° W.L., 15° E.L., and 116.5° E.L.³

Unlike the other GSO satellites in the GESN network, the 15° E.L. spacecraft is intended to operate using only the 2 x 3000 MHz of V-band spectrum requested in the original GESN application (it will not operate at Ka-band).⁴ Table 1 below shows the overall orbital and frequency configuration of GESN, as proposed through today’s interdependent and comprehensive series of amendments. Information specific to the spacecraft authorization requested in this Amendment is shaded and outlined within bold borders. A detailed description of the overall technical and design concept for GESN is presented in the Technical Appendix to this Amendment, and at pages 2-4 of the contemporaneously-filed amendment pertaining to the non-GSO component of GESN.

³ Three of these four GSO slots (the exception being 89° W.L.) were the slots licensed to NGST’s Ka-band GSO component in August 2001. *See TRW Inc.*, 16 FCC Rcd 14407 (Int’l. Bur. 2001). At the time, had the V-band component of GESN been under processing, NGST would have amended its V-band GSO applications to move to the new locations (all three of which had parallel ITU filings in process for both Ka-band and V-band to accommodate GESN). The fourth slot licensed to NGST in *TRW Inc.* – the 79° W.L. orbital location – was licensed at Ka-band to another U.S. operator in January 2004, leading NGST to select 89° W.L. as an alternative, which it will pursue even though the 79° W.L. slot has now been relinquished. Thus, NGST is resurrecting, to the extent it is now able, its hybrid Ka-band/V-band GSO proposal, as that proposal effectively stood as of August 2001.

⁴ Of the four GESN GSO V-band applications being amended, only the amendment to the 15° E.L. satellite is a true conforming amendment and nothing more. The other three satellites, including the spacecraft at issue in this Amendment, are undergoing changes in proposed orbital locations and the addition of frequency bands. The GESN GSO satellites at 119° W.L. and 116.5° E.L. will operate in the 3000 MHz (Earth-to-space) and 4500 MHz (space-to-Earth) of FSS spectrum at V-band and in the 2 x 1000 MHz of GSO primary spectrum at Ka-band. Without regard to whether the changes in location for the 119° W.L. and 116.5° E.L. could arguably be considered as eligible for a waiver of Section 25.116, NGST accepts that changes of the type proposed for the three GSO satellites other than the 15° E.L. satellite are typically considered “major amendments” under the relevant provision of Section 25.116 of the Commission’s Rules, 47 C.F.R. § 25.116.

Table 1: GESN Orbital and Frequency Configuration

<u>GESN ORBITAL AND FREQUENCY PLAN</u>		<u>UPLINK</u>	<u>DOWNLINK</u>
<u>Non-GSO Component</u>	3 HEO Satellites	<ul style="list-style-type: none"> • 28.6-29.1 GHz (Primary) • 29.5-30 GHz (Secondary/Non-Unacceptable Interference Basis) • 47.2-50.2 GHz (Gateway and user, per new FCC Rule) 	<ul style="list-style-type: none"> • 18.8-19.3 GHz (Primary) • 19.7-20.2 GHz (Secondary/Non-Unacceptable Interference Basis) • 37.5-42 GHz (3000 MHz, flexibly assigned to accommodate future GSO/non-GSO sharing rules, and operating as non-GSOs; gateway and user, per new FCC Rule)
	4 Geosynchronous Circular-Orbit Satellites at 119°W, 89°W, 15°E, and 116.5°E	<ul style="list-style-type: none"> • 28.6-29.1 GHz (Secondary, and used to resolve MX situations during non-GSO in-line events) • 47.2-50.2 GHz (Gateway and user, per new FCC Rule) 	<ul style="list-style-type: none"> • 18.8-19.3 GHz (Secondary, and used to resolve MX situations during non-GSO in-line events) • 37.5-42 GHz (3000 MHz, flexibly assigned to accommodate future GSO/non-GSO sharing rules, and operating as non-GSOs; gateway and user, per new FCC Rule)
<u>GSO Component</u>	GSO 1: 119° W	<ul style="list-style-type: none"> • 28.35-28.6 GHz (Primary) • 29.25-30 GHz (Primary) • 47.2-50.2 GHz (Gateway and user, per new FCC Rule) 	<ul style="list-style-type: none"> • 18.3-18.8 GHz (Primary) • 19.7-20.2 GHz (Primary) • 37.5-42 GHz (Gateway and user, per new FCC Rule)
	GSO 2: 89° W	<ul style="list-style-type: none"> • 28.35-28.6 GHz (Primary) • 29.25-29.5 GHz (Primary) • 47.2-50.2 GHz (Gateway and user, per new FCC Rule) 	<ul style="list-style-type: none"> • 18.3-18.8 GHz (Primary) • 37.5-42 GHz (Gateway and user, per new FCC rule)
	GSO 3: 15° E	<ul style="list-style-type: none"> • 47.2-50.2 GHz (Gateway and user, per new FCC Rule) 	<ul style="list-style-type: none"> • 37.5-42 GHz (3000 MHz, flexibly assigned to accommodate future GSO/non-GSO sharing rules, and operating as a GSO; gateway and user, per new FCC Rule)
	GSO 4: 116.5° E	<ul style="list-style-type: none"> • 28.35-28.6 GHz (Primary) • 29.25-30 GHz (Primary) • 47.2-50.2 GHz (Gateway and user, per new FCC Rule) 	<ul style="list-style-type: none"> • 18.3-18.8 GHz (Primary) • 19.7-20.2 GHz (Primary) • 37.5-42 GHz (Gateway and User, per new FCC Rule)

Rather than make line-by-line changes to the material included in the existing application, NGST provides below a brief summary of the differences between the authority it now seeks and the requests it set out in the original application (as amended in December 1997). NGST also provides a Technical Appendix that includes a complete description of the V-band (40/50 GHz) payload for the GESN GSO spacecraft at 15° E.L.

1. Overview of the Amendment.

a. Background – Original Applications

In September 1997, in response to a Commission cut-off notice, NGST filed an application for authority to establish a global V-band FSS system.⁵ NGST proposed that GESN utilize fifteen (15) non-GSO satellites in medium Earth orbit (“MEO”) operating in concert, via optical inter-satellite links, with four (4) GSO satellites strategically placed around the globe. It was NGST’s objective, from the outset, to have fully interconnected and interdependent GSO and non-GSO satellites operating in concert within GESN. For both the GSO and non-GSO components of GESN, NGST sought to employ three gigahertz of V-band spectrum in each direction – initially proposed to be the then-internationally-allocated FSS bands at 47.2-50.2 GHz (Earth-to-space) and 37.5-40.5 GHz (space-to-Earth).⁶ Services NGST proposed to provide via GESN include two-way point-to-point wideband data transport services, multimedia services, and private network services. GESN was to support a full range of data service rates, from T1

⁵ See Application of TRW Inc., File No. SAT-LOA-19970904-00080 (filed Sept. 4, 1997) (“NGST Application” or “NGST V-Band Application”). At that time, NGST was part of TRW Inc. (“TRW”) and TRW was the applicant. TRW merged with Northrop Grumman Corporation in December 2002. In the course of the merger proceedings, the Commission established NGST’s basic qualifications to be a Commission satellite licensee. *Application of TRW Inc., Transferor and Northrop Grumman Corporation, Transferee*, 17 FCC Rcd 24625 (Sat. Div. 2002).

⁶ NGST also proposed to use two megahertz of spectrum in each direction in the extended C-band, 3650-3700 MHz (downlink) and 6425-6525 MHz (uplink), for transfer orbit and on-orbit emergency telemetry and command links. For on-orbit operations, the TT&C subsystem would use two megahertz of spectrum at around 40 GHz for telemetry links and two megahertz of spectrum around 50 GHz for its command links. NGST also proposed to locate GESN’s beacon links in three megahertz each of 40 GHz and 50 GHz FSS spectrum.

(1.5 Mbps) to OC-30 (1.552 Gbps), and was to have a total system capacity in excess of 1300 Gbps – the equivalent of more than 850,000 T1 circuits.

In December 1997, NGST amended its application by adding Ka-band capacity to each of the GESN system satellites – GSO and non-GSO. In other words, the fully integrated and interdependent GSO/non-GSO V-band system was expanded to be a fully-integrated and interdependent GSO/non-GSO V-band and Ka-band system. With respect to GSO spacecraft operations, NGST requested authority to provide service in 1000 megahertz of spectrum in both the Earth-to-space (uplink) and space-to-Earth (downlink) directions in the 28.6-29.1 GHz and 29.5-30.0 GHz uplink bands, as well as 1000 megahertz from within the band 17.7-20.2 GHz (excluding the 19.3-19.7 GHz portion of the band).⁷

With NGST's agreement, the Commission eventually treated the Ka-band portions of the GESN GSO satellites as separate and independent applications, and in August 2001, granted NGST licenses for four Ka-band GSO satellites – three of which specified locations different from the locations proposed in the December 1997 Amendment. For a variety of business reasons, including the fact that there was no immediate prospect of restoring the Ka-band and V-band components of the unified GESN system to a common implementation track, NGST surrendered its Ka-band GSO license to the Commission in March 2003.⁸

⁷ In the same amendment, NGST sought authority to operate GSO uplinks in the 29.25-29.5 GHz band, and to use Ka-band spectrum for on-orbit TT&C and beacon links. *See* Amendment, File No. SAT-AMD-19971222-00219 (filed Dec. 22, 1997) (“December 1997 Amendment” or “NGST Ka-band Amendment”). Specifically, NGST sought to use two megahertz of spectrum centered on 29.997 GHz for command links, and its telemetry links would use two megahertz of spectrum centered on 20.197 GHz. NGST Dec. 1997 Amendment at 7. GESN's Ka-band beacon links would use 3 MHz of Ka-band spectrum in each direction).

⁸ *See* Letter dated March 5, 2003, from Counsel to NGST to Secretary, FCC (File No. SAT-AMD-19971222-00229) (“March 2003 Letter”).

b. Description of Amended Application

Since submission of the original filings comprising NGST's Ka-/V-band GSO proposal in the middle part of the last decade of the last century, there have been significant changes in the Commission's spectrum allocation scheme for these bands, in NGST's thinking concerning the optimal means of implementing its hybrid GSO FSS service, and in the state of the satellite technological art. Because the final international and domestic spectrum allocation issues have been resolved with respect to V-band FSS in the past six months, the Commission is now in a position to process this long-pending aspect of the overall GESN application.⁹ The Commission's January 29, 2004 Public Notice affording the remaining V-band applicants until March 15, 2004 to amend their applications to conform to the final allocation rules¹⁰ presents a concurrent opportunity for NGST to revise its system proposal and to realign the non-GSO and GSO elements.

i. Frequency Bands

NGST is altering its original V-band proposal to specify operation at 47.2-50.2 GHz (Earth-to-space) and 3000 MHz within the band 37.5-42.0 GHz (space-to Earth). This is a conforming amendment that brings NGST's spectrum requests into alignment with the soft-segmentation of V-band spectrum for terrestrial and FSS use that the Commission adopted in the *V-Band Second Report and Order*.

⁹ In December 2003, the Commission adopted rules to implement allocation and power limitation actions that were taken at a series of three International Telecommunication Union ("ITU") World Radiocommunication Conferences, culminating with the 2003 conference. *See Allocation and Designation of Spectrum for Fixed-Satellite Services in the 37.5-38.5 GHz, 40.5-41.5 GHz and 48.2-50.2 GHz Frequency Bands; Allocation of Spectrum to Upgrade Fixed and Mobile Allocations in the 40.5-42.5 GHz Frequency Band; Allocation of Spectrum in the 46.9-47.0 GHz Frequency Band for Wireless Services; and Allocation of Spectrum in the 37.0-38.0 and 40.0-40.5 GHz Band for Government Spectrums, Second Report and Order*, IB Docket No. 97-95, FCC 03-296 (released Dec. 5, 2003) ("*V-Band Second Report and Order*").

¹⁰ *See* Public Notice, Report No. SPB-199, *International Bureau Invites Applicants to Amend Pending V-band Applications* (released January 29, 2004).

In this Amendment (and in its concurrently-filed non-GSO and GSO counterparts), NGST is requesting Commission authority to have the GSO and non-GSO components of GESN (as well as the Ka-band and V-band components at other orbital locations and for the non-GSO component) considered and processed as a unified system filing. This was the original concept behind GESN, and NGST's failure to remain fully faithful to its concept contributed to its 2003 decision to return the Ka-band GSO licenses it had received in 2001 – a decision that it specifically emphasized was being taken without prejudice to reapplying in the manner it is doing today.¹¹

ii. Service Objectives

Not surprisingly, given the passage of time since its original proposal was filed, NGST has somewhat revised its service objectives for GESN. NGST envisions that the V-band frequencies would be used primarily for feeder links/Hubs and trunked relay applications. NGST also believes that the combined HEO/GSO GESN system can be used as a big-pipe relay system to provide bandwidth for communications services to and from the moon. For a very high percentage of the time, one of the four GSO satellites and two of the HEO satellites have line-of-sight visibility to the moon, enabling a permanent direct connection.

iii. Performance Objectives

The GESN system will provide good link availability for most locations around the world. The link availability will depend on the user types. GESN users operating in the V-band frequencies on the GSO satellite located at 15 E.L. will use two common types of user terminals: 1.5 m and 2.7 m diameter terminals. Users operating with 1.5 m earth terminal antennas could achieve up to 18 dB of rain fade margin. In order to achieve higher link availability, and to meet the system capacity objectives, adjustable coding, modulation and data

¹¹ See March 2003 Letter, at 2.

rates will be utilized. In general, the users will reduce their transmit data rates, use heavy coding and/or operate with lower order modulation during the rain fade conditions. The links will operate at 2E-10 BER or lower.

2. Complete Technical Description

Full technical characteristics of the proposed system, as amended, are contained in the attached Technical Appendix. Pursuant to new Commission requirements, NGST provides material in the form of FCC Form 312, Schedule S. NGST also provides, with some slight redundancy, technical material in the conventional narrative format.¹² Collectively, this material replaces the corresponding sections and appendices of the original application and Attachment 1 to the December 1997 amendment with respect to the GSO spacecraft covered by this amendment. At the very least, NGST's technical submissions should be found sufficient to satisfy the obligation to propose a substantially complete technical approach for GESN.¹³

3. Implementation Schedule

The proposed construction milestones contained in the original GESN Application are not consistent with the Commission's more recently adopted standard milestone schedules for satellite systems. Accordingly, NGST takes this opportunity to delete the benchmarks from Section 7 of its application, and states that it will instead abide by the milestone schedule established by Commission rule that will be made part of its authorization

¹² NGST is taking this approach because it experienced some difficulties in completing the new, pre-official electronic version of FCC Form 312, Schedule S that the Commission first made available for public use on February 27, 2004. Despite repeated technical consultations with the Staff, some of the data entries NGST wished to make on Schedule S could not be accomplished successfully. All of the information requested on the form is provided as a back-up in the narrative text of the Technical Appendix and its attachments. At this earliest of stages in the transition to Schedule S, NGST requests that the Commission rely upon both documents, as appropriate, in assessing NGST's technical proposal.

¹³ NGST specifically notes that its compliance with the requirement of Sections 25.114(d)(7) and 25.140(b)(2) (47 C.F.R. §§ 25.114(d)(7) and 25.140(b)(2)) to provide interference analyses to demonstrate compatibility of GESN GSO satellites with satellites two degrees removed is achieved for its Ka-band capable satellites by virtue of its demonstration of compliance with the specifically applicable off-axis EIRP and pfd limitations. There are no satellites to be considered at this point in V-band, so that this requirement is inapplicable to the 15° E.L. spacecraft.

when granted. *See* 47 C.F.R. § 25.164(a). *See also* Technical Appendix at Attachment A (FCC Form 312, Schedule S). To the extent that the spacecraft described herein will also be part of the GESN non-GSO constellation, and thus would be subject to some differing milestones under Section 24.164(b) of the Commission's Rules, 47 C.F.R. § 25.164(b), NGST proposes that the earlier of the dually-applicable milestones apply.¹⁴

4. Public Interest Considerations

As noted in Section 2 of the original GESN application filed in September 1997, the explosion in demand for capacity for high-speed transmission for video, fax, data and Internet use has posed increasing challenges for terrestrial networks. GESN's innovative non-GSO/GSO network architecture will allow low-cost broadband services to be provided in a variety of areas within the United States and throughout the world without the costly capital investment that would be required to construct or upgrade terrestrial networks. The design concepts incorporated into GESN will significantly increase the capacity, flexibility, and availability of communications worldwide.

For rural areas of the U.S., and in developing countries, GESN will provide thin-route capacity that dynamically matches local needs, providing the same level of service that urban users expect. GESN will extend broadband data and video services to areas that are viewed as technically or economically impractical (or even impossible) to serve by any other means. The low cost first- and last-mile nature of the GESN system will help address national and international goals of providing connectivity to rural areas for telemedicine, education, and economic development.

¹⁴ Specifically, even though it is also part of the non-GSO constellation, this GSO satellite would have to be brought into use by 60 months after licensing, as per Section 25.164(a), rather than at the 72 month mark permitted in Section 25.164(b).

GESN combines advanced technology with a design that minimizes cost. With wide bandwidths on relatively few satellites, GESN efficiently uses spectrum and orbital resources to deliver global connectivity. The technological advantages incorporated into the GESN system will provide other substantial public benefits as well. For example, much of the advanced processing technology employed by NGST in this system will find its way into next generation spacecraft operating in other commercial frequency bands, providing the basis for new products and services that more efficiently reuse that spectrum. Building on NGST's strong military technology heritage, the GESN system will also be a major source of new EHF technology for other commercial space and terrestrial wireless applications. In turn, the cost advantages gained by widespread commercial use of EHF satellite terminals will help to increase availability and reduce the cost of such services to government users.

As noted above, among other benefits, GESN can provide a wideband pipeline for communications between the Earth and the moon. As the U.S. Government looks toward the possibility of establishing an extended manned presence on the moon,¹⁵ the availability of such two-way communications capability could provide a critical contribution to this endeavor.

GESN will also make significant contributions to the nation's economy. Aside from the economic benefits of the new services and applications that it will support, the development of the GESN system itself will employ highly skilled workers at NGST's facilities in the U.S. Other elements of the system hardware, software and user terminals will be developed and manufactured by U.S. and international subcontractors.

¹⁵ See Mike Allen & Eric Pianin, "Bush Outlines Space Agenda: President Calls for Moon Trip By 2020," *Washington Post*, at A1, January 15, 2004.

5. Requested Waivers of Commission Rules

As new spectrum allocations have been adopted for the V-band satellite service, and service rules are expected to be adopted as well, many of the waivers sought in Section 6 of the original GESN application have been or may be mooted by the time the application is granted. To the extent any waivers of the Commission's allocation or processing rules remain necessary, however, NGST's requests for waiver contained in its original application remain in effect.

At the same time, new Section 25.156(d)(3) of the Commission's rules raises a different issue, which may necessitate a modest waiver of the processing approach established under that rule with respect to the other GSO applications in the GESN system. This rule specifies that applications for "systems employing two or more service bands will be treated like separate applications for each service band" (47 C.F.R. § 25.156(d)(3)), permitting the application to be granted in parts by the Commission on separate processing tracks. This could pose a special problem for NGST in that, as noted above, its Ka-band and V-band proposals are mutually interdependent – and indeed, have become more interrelated as the system design has evolved.

Accordingly, to the extent necessary, NGST requests that the Commission waive Section 25.156(d)(3) of its rules in order to allow both the Ka-band and V-band portions of its 119° W.L., 89° W.L. and 116.5° E.L. GSO satellite proposal to be considered and acted upon contemporaneously.¹⁶ Further, NGST requests that the Commission consider both the GSO and the non-GSO components of the amended GESN proposal as integrally related, and act upon all of today's Amendments contemporaneously. The system concept is fundamentally dependent on

¹⁶ In this same regard, NGST specifically emphasizes that the four GSO satellites are an integral sub-package of the GESN system, and that staggered action on these applications would be inconsistent with NGST's vision and approach for a unified GESN system.

use of the two bands and the package of orbital architectures together, and NGST would not be able to proceed with construction of one element without assurance that the other parts of the network will also be authorized. This treatment appears consistent with the approach the Commission has stated it would follow in connection with hybrid satellite proposals, acting simultaneously on the requests for each band.¹⁷

Finally, NGST requests a waiver of Section 25.202(g) of the Commission's Rules to permit it to place its transfer-orbit and emergency-mode on-orbit TT&C links in 4/6 GHz ("C-band") FSS frequencies, rather than at the band edge in the V-band uplink and downlink frequencies. As noted above, NGST only requests 2 MHz of spectrum in the extended C-band for transfer orbits and on-orbit emergency modes.¹⁸ NGST submits that good cause exists for the grant of this waiver, and that such grant will not undermine the purpose of the rule.

The required link availability for the TT&C links is ~99.99% or higher. In order to achieve 99.99% link availability, the required fade margin in the C-band for low elevation angles and high rain-rate regions is ~10 dB. Typical C-band TT&C earth stations are in a range of from 12m to 20m in diameter. If either HEO or GSO satellites use V-band for transfer orbit and on-orbit emergency TT&C modes, the V-band TT&C earth terminals would have to be in a range of from 40m to 60m in diameter in order to achieve the same link availability as systems using C-band for TT&C. It is almost impossible to use this type of antenna sizes with the narrow beamwidths that are required for transfer orbits and on-orbit emergency modes.

The limited waiver requested by NGST is also appropriate because the required fade margin in the 4/6 GHz band is significantly lower than the required fade margin in the 40-50 GHz frequency range. The operations using 2 MHz of extended C-band spectrum for transfer

¹⁷ See *Space Station Licensing Reform Order*, 18 FCC Rcd 10760, 10817 (¶ 147)(2003).

¹⁸ On-orbit TT&C for NGST's 15° E.L. satellite will be conducted in Ka-band, within the service-link frequency assignments for GESN that will be included on the spacecraft.

orbits and on-orbit emergency modes will be extremely limited in duration (relative to the overall design life of the spacecraft), and they will be fully coordinated with other C-band users in the case of transfer-orbit operations (and coordinated to the greatest extent practicable in the case of on-orbit recovery operations). Routine on-orbit TT&C operations, which will occur in the Ka-band as per Section 25.202(g), will be restored as quickly as possible.

NGST notes that its on-orbit TT&C operations for the GSO satellite at 15°E.L. will be performed in the Ka-band frequencies used by the non-GSO component of GESN (i.e., at around 18.8 GHz and 29.1 GHz). As the two sets of bands are included on the same physical spacecraft, NGST does not understand a waiver to be required. If NGST's understanding in this regard is not correct, however, it requests a waiver of Section 25.202(g) to the extent necessary to enable it to have on-orbit TT&C functions for the hybrid 15°E.L. GSO and geosynchronous non-GSO spacecraft performed at the edges of the spacecraft's above-mentioned non-GSO FSS service link bands. In support, NGST points out that the efficiencies of including only one set of TT&C links in the service bands to be included on a hybrid, multi-band satellite are self-evident, and reflect only part of the efficiencies and economies of scale that hybrid payloads permit. Good cause exists for the grant of this request.¹⁹

6. Basic Qualifications – Updated Officers, Directors and Stockholders

Included as Exhibit H to this Amendment is updated information concerning the stockholders, officers and directors of Northrop Grumman Corporation.

7. Orbital Debris Mitigation

In November 2003, NGST filed an orbital debris mitigation plan with the Commission, pursuant to Section 25.145(c)(3) of the Commission's Rules, with respect to its Ka-

¹⁹ NGST reminds the Commission that it has requested common and simultaneous consideration of its other Ka-band and V-band "applications," in order to be assured of the opportunity to see its omnibus vision for the unified GESN system through to implementation. Only by rule are NGST's Ka-band and V-band proposals, and for that matter NGST's GSO and non-GSO proposals, "separate applications."

band non-GSO component.²⁰ With the modification of the orbital parameters of the non-GSO component of GESN that is being proposed today in via amendment of NGST's non-GSO application, it is necessary to make adjustments to its orbital debris mitigation plan. A revised Exhibit G is included with this Amendment. The revised orbital debris mitigation plan includes NGST's plan for both the HEO and the GSO satellites that will together comprise GESN.

8. ITU Filings and Cost Recovery

Shortly after NGST filed its initial V-band Application, and then again shortly after it filed its Ka-band Amendment, the Commission forwarded new advance publication materials for the GSO and non-GSO components of GESN to the ITU pursuant to the relevant provisions in Article 9 of the ITU Radio Regulations. At the time of the V-band ITU filings in November 1997, filers had as long as nine years (or until November 2006) to bring their published frequency assignments into use.

Clearly, NGST, even if it were to be fully licensed for GESN (pursuant to the Amendments filed today) in the next few months, and putting aside for the moment other relevant considerations, NGST would not be able to bring the proposed GSO frequency assignments into use prior to the expiration of the deadlines associated with the initial ITU filings for GESN. As a result, NGST is in the process of preparing the information necessary to allow U.S. Government Advance Publication and Coordination of the frequency assignments it proposes for the GSO and the non-GSO components of GESN in today's Amendments. As these filings are to be made with the ITU in an electronic format that is not conducive to inclusion with the instant Amendment filings, NGST will be providing these materials to the Commission's International Bureau shortly, under separate cover, for forwarding to the ITU.

²⁰ See Amendment of NGST, File No. SAT-AMD-20031104-00324 (filed Nov. 4, 2003), at Exhibit G.

NGST is aware that the ITU Council, in Decision 482 (Modified), has implemented a program of cost recovery for satellite network filings. As a result of this program, Commission applicants for satellite facilities are responsible for the payment of all cost-recovery charges that are associated with ITU advance publication or coordination filings, as appropriate, that the United States makes on behalf of their proposed systems and networks. NGST confirms that it is aware of the ITU cost recovery obligations that will be associated with its forthcoming ITU filings for the GESN system. NGST hereby accepts its obligations under Decision 482 (Modified) and acknowledges its responsibility to pay any ITU cost recovery invoices for filings associated with this Amendment. Invoices received from the ITU for cost recovery associated with NGST's forthcoming filings should be forwarded, upon receipt from the Commission, to the contact person listed in the FCC Form 312 Application included with this Amendment.

9. Request for "Permit-But-Disclose" Treatment Under *Ex Parte* Rules

For administrative convenience, NGST also requests that the Commission exercise its authority pursuant to Section 1.1200(a) of its Rules (47 C.F.R. § 1.1200(a) (2003)) to make this application subject to "permit-but-disclose" *ex parte* treatment under Section 1.1206 of the rules. 47 C.F.R. § 1.1206 (2003). Such treatment will bring the status of this application into alignment with the Ka-band non-GSO portion of the GESN network, which the Commission has previously designated for treatment under the "permit-but-disclose" provisions. *See* Public Notice, Report No. SAT-00012, at 11 (released March 16, 1999).

CONCLUSION

For the reasons set forth in the GESN application, as now amended, NGST is fully qualified in all respects to launch and operate the Ka-band/V-band GSO satellite network for which authority is requested. NGST has further shown that its proposed system will materially advance the public and national interests. NGST therefore requests that the Commission grant this application, so that the public interest benefits that its system promises may begin to be realized.

Respectfully submitted,

NORTHROP GRUMMAN SPACE & MISSION
SYSTEMS CORPORATION

By: Stephen D. Baruch
Norman P. Leventhal
Stephen D. Baruch
David S. Keir

Leventhal Senter & Lerman PLLC
2000 K Street, N.W.
Suite 600
Washington, D.C. 20006
(202) 429-8970

March 11, 2004

Its Attorneys

TECHNICAL APPENDIX

TECHNICAL CHARACTERISTICS OF THE
GLOBAL EHF SATELLITE NETWORK

The following information replaces, in its entirety, the technical information in Northrop Grumman Space Technology's (NGST) September 1997 Application for the Global EHF Satellite Network (GESN), as amended in December 1997. This Technical Appendix, including the information presented in the FCC Form 312, Schedule S (see Attachment A to this Technical Appendix), applies to the geostationary satellite-orbit (GSO) component of NGST's hybrid Ka-band and V-band GESN proposal. NGST is today making four separate amendments to its GSO component – one each for the four GSO satellites originally proposed for the 113W, 83W, 15E, and 112E orbital locations. In addition, and again by concurrent filing, NGST is amending its pending application for the non-geostationary satellite orbit (non-GSO) spacecraft that comprise the interdependent non-GSO component of GESN.

1. General Description of Overall System Facilities, Operations and Services
(Section 25.114(d)(1))

The Global EHF Satellite Network (GESN) will use a constellation of seven spacecraft to provide a broad range of wideband telecommunications services, including two-way, wide-band data transport, multimedia services and private network services. The data rates are in a range from 75 Mbps to 750 Mbps for the downlink (space-to Earth) direction and 0.5 Mbps to 700 Mbps for the uplink (Earth-to-space) direction. The actual data rate will depend on the desired link availability, earth terminal antenna size, type of service, etc. A summary of the system features is included in Attachment E to this Technical Appendix.

The GESN system earth terminal users will be able to communicate with any of the GESN satellites in view, whether GSO or non-GSO. The GESN user terminals will be equipped with tracking antennas so that they can maintain continuous transmission with the satellites in view – a feature that is particularly useful for the three non-GSO satellites that will operate in highly-elliptical orbits (HEO). User earth terminal antenna sizes will range from 0.7 m to 2.7 m in diameter, depending on the applications and the desired link availability.

The GESN system will use fixed-satellite service (FSS) spectrum in both the Ka-band and V-band frequency ranges for its communications links. In the Ka-band, between the non-GSO and the GSO satellites, the bands 18.3-19.3 GHz, 19.7-20.2 GHz, 28.35-29.1 GHz and 29.5-30 GHz will be utilized (although not all bands will be used on all satellites, see Amendment at Table 1). In the V-band, the GESN satellites use the bands 37.5-42 GHz and 47.2-50.2 GHz for the downlink and the uplink, respectively (although, again, not all of the band 37.5-42 GHz will be used on all satellites, see Amendment at Table 1). All satellites in the system will use both left-hand circular polarization (LHCP) and right-hand circular polarization (RHCP).

Each GESN satellite will use two megahertz of spectrum in each direction of the extended C-band frequencies, 3650-3700 MHz for downlink and 6425-6525 MHz for uplink, for transfer orbit and on-orbit emergency telemetry and command (TT&C) operations. For regular on-orbit operations, the GESN satellites' TT&C subsystem will use two megahertz of spectrum in each the 19 and 29 GHz bands for telemetry and for telecommands.

The GESN HEO satellites will, as NGST proposed for its non-GSO satellites in the December 1997 Amendment, operate in the 19.7-20.2 GHz and 29.5-30 GHz on a secondary, non-unacceptable interference basis. The ability of the HEO satellites to operate on such a basis is confirmed by the fact that the satellites meet the equivalent power flux-density (epfd) limits established in Article 22 of the International Telecommunication Union (ITU) Radio Regulations for the protection of GSO FSS satellite networks from unacceptable interference caused by non-GSO FSS systems (see Attachment D for a detailed showing of compliance with the epfd limits). The geosynchronous, circular-orbit satellites in the GESN non-GSO component will not operate in the 19.7-20.2 GHz and 29.5-30 GHz bands. All GESN satellites, non-GSO and GSO, meet the applicable power flux-density (pfd) limits in Section 25.208 of the Commission's Rules.

In the Ka-band, the GESN system plans to use small earth terminal antennas, in a range of from 0.7 m to 1.2 m in diameter. In the V-band, larger earth terminal antennas, in a range of from 1.5-2.7 m in diameter, will be used.

The inclination angle and perigee altitude of the GESN's HEO satellites are 63.4 deg and 1111 km, respectively, which corresponds to a 12-hour orbit period. The apogee altitude of the HEO satellites is 39,352 km. The HEO satellites are distributed over three orbit planes, one satellite per plane. The minimum operational elevation angles for the HEO satellites at Ka-band and V-band are 10 degrees and 15 degrees, respectively. The coverage of the HEO satellites is shown in Figure 1.

Four GSO satellites will be located at 119°W, 89°W, 15°E and 116.5°E. These satellites will also host the payloads of the four non-GSO satellites that comprise the GESN geosynchronous circular-orbit plane of satellites. The coverage of these four satellites is shown in Figure 2. The coverage of the entire GESN constellation, including 3 HEO satellites and the 4 GSO/geosynchronous satellites, is shown in Figure 3. In the calculation, the minimum operational elevation angle (10 degrees) was used. Figure 3 confirms that the GESN system will be capable of serving all populated areas of the world.

Each GESN satellite will have 60 (30 Ka + 30 V-band) active receive beams and 48 (24 Ka + 24 V-band) active transmit beams. Each beam will be able to operate on RHCP and/or LHCP. Each transmit and receive beam will be able to be assigned to any point in the satellite field of view. Each non-GSO satellite has an Earth coverage antenna beam for order wire. The purpose of the order wire is to support the communications between the ground terminals and the GESN satellites or/and GESN Network Control Center.

In addition, each GESN satellite will be equipped with three laser heads. These three laser heads will allow the GESN satellites to communicate via optical cross-links with each other and other satellite networks or space vehicles.

The capacity of each GESN satellite is ~24 Gbps. The overall system capacity of GESN is ~165 Gbps.

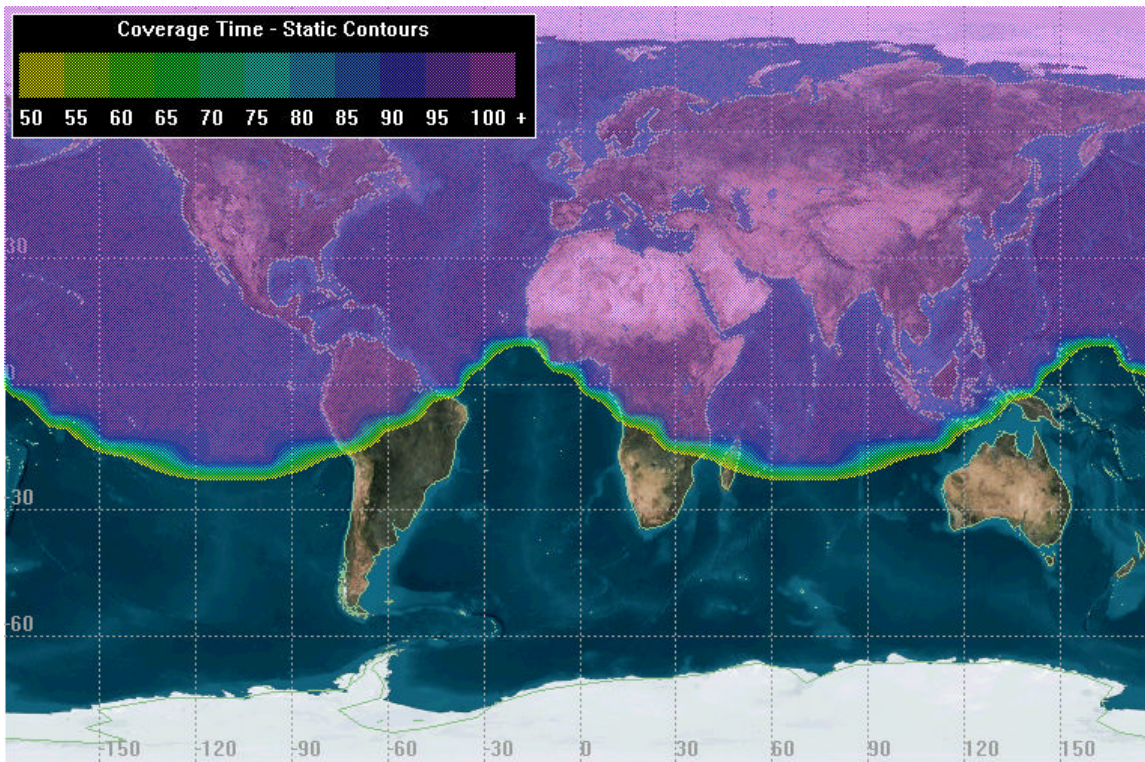

Figure 1: Coverage of Three HEO Satellites (Minimum Elevation Angle = 10 degrees)

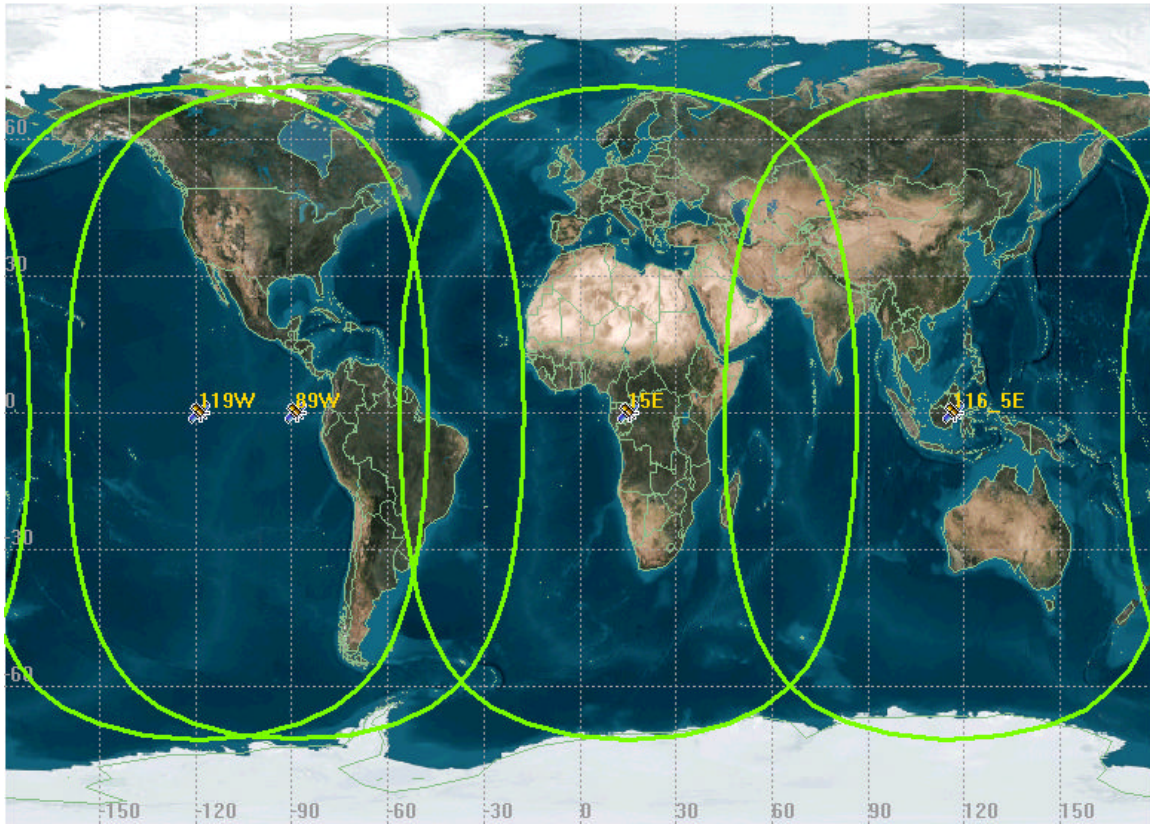

Figure 2: Coverage of Four GSO Satellites (Minimum Elevation Angle = 10 deg.)

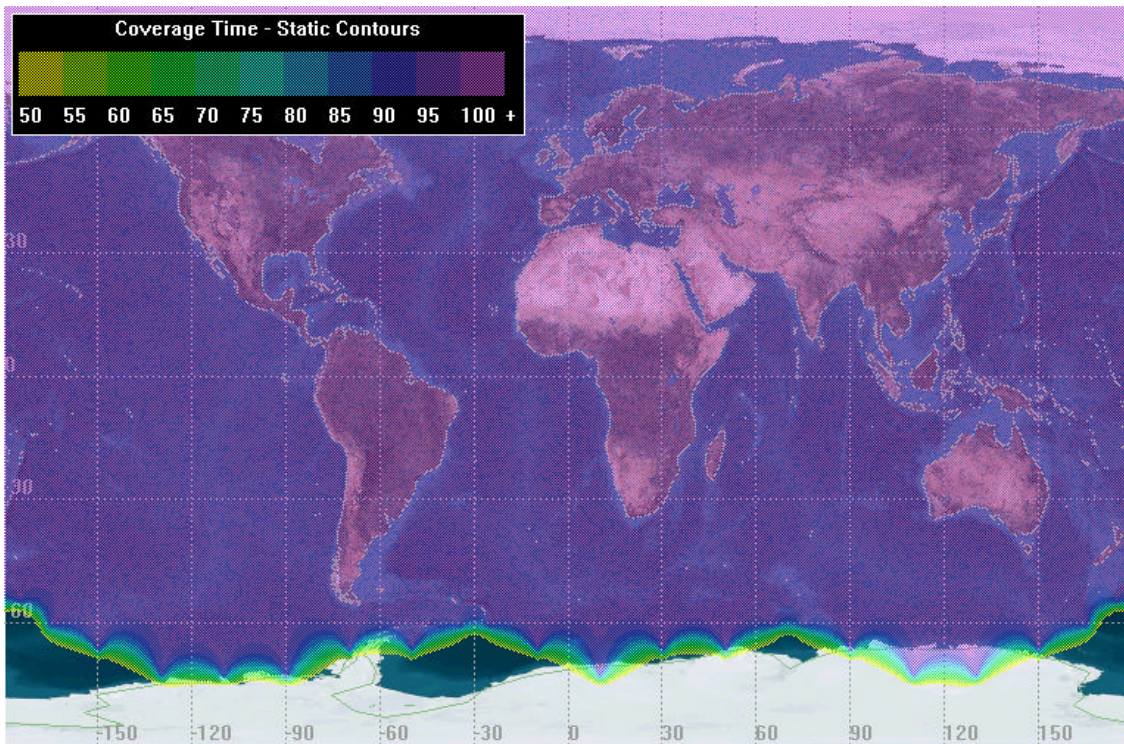

Figure 3: Coverage of GESN Constellation (7 Satellites)

2. Radio Frequency and Polarization Plan, Center Frequency and Polarization of transponders, emission designators and allocated bandwidth of emission, transmit power, EIRP (Section 25.114(c)(4))

- **GESN Frequency Plan (Non-GSO Component): (Section 25.114(c)(4)(i))**

- **HEO Non-GSO Satellites:** Each satellite will utilize 1000 MHz of Ka-band spectrum and 3000 MHz of V-band spectrum in each direction, as shown in Figure 4A. In the uplink direction, the Ka-band spectrum will be divided into eight 125 MHz channels and the V-band spectrum will be divided into seven channels: two 300 MHz channels, one 400 MHz channel, and four 500 MHz channels. In the downlink direction, there will be four Ka-band 250 MHz channels and nine V-band 500 MHz channels (of which only six will be utilized). Each beam would be able to operate on LHCP and/or RHCP, depending on the traffic demand and sharing conditions.

Note: In the 37.5-42 GHz band, each GESN non-GSO satellite only uses 3000 MHz of the 4500 MHz of downlink spectrum (i.e., six of the nine available channels). The actual configuration used is dependent on the outcome of future GSO/non-GSO sharing deliberations. NGST has requested a flexible authorization that will enable it to adjust without further application proceedings to the results of future proceedings.

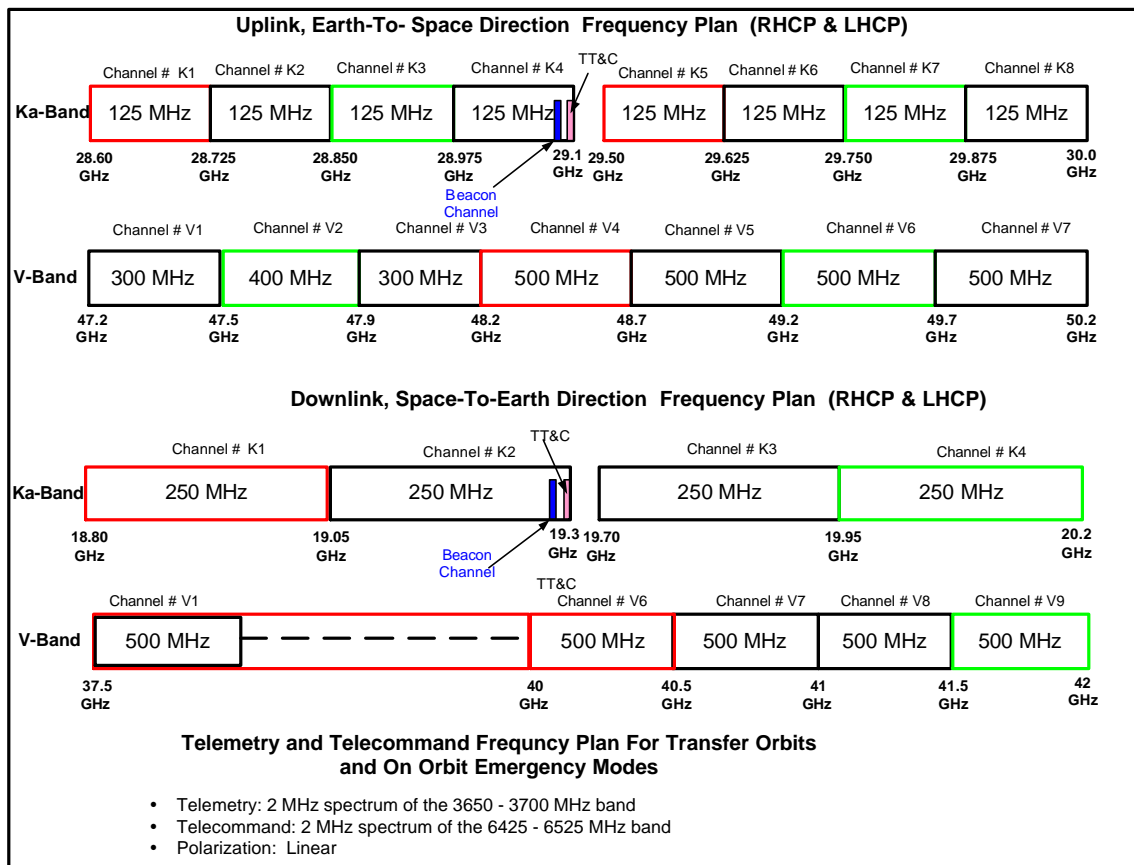

Figure 4A: Non-GSO Satellite (HEO) – Frequency and Polarization Plan

- **Geosynchronous Circular-Orbit Non-GSO Satellites:** Each satellite will utilize 500 MHz of Ka-band spectrum and 3000 MHz of V-band spectrum in each direction, as shown in Figure 4B. In the uplink direction, the Ka-band spectrum will be divided into four 125 MHz channels and the V-band spectrum will be divided into seven channels: two 300 MHz channels, one 400 MHz channel, and four 500 MHz channels. In the downlink direction, there will be two Ka-band 250 MHz channels and nine V-band 500 MHz channels (of which only six will be utilized). Each beam would be able to operate on LHCP and/or RHCP, depending on the traffic demand and sharing conditions.

Note: In the 37.5-42 GHz band, each GESN non-GSO satellite only uses 3000 MHz of the 4500 MHz of downlink spectrum (i.e., six of the nine available channels). The actual configuration used is dependent on the outcome of future GSO/non-GSO sharing deliberations. NGST has requested a flexible authorization that will enable it to adjust without further application proceedings to the results of future proceedings.

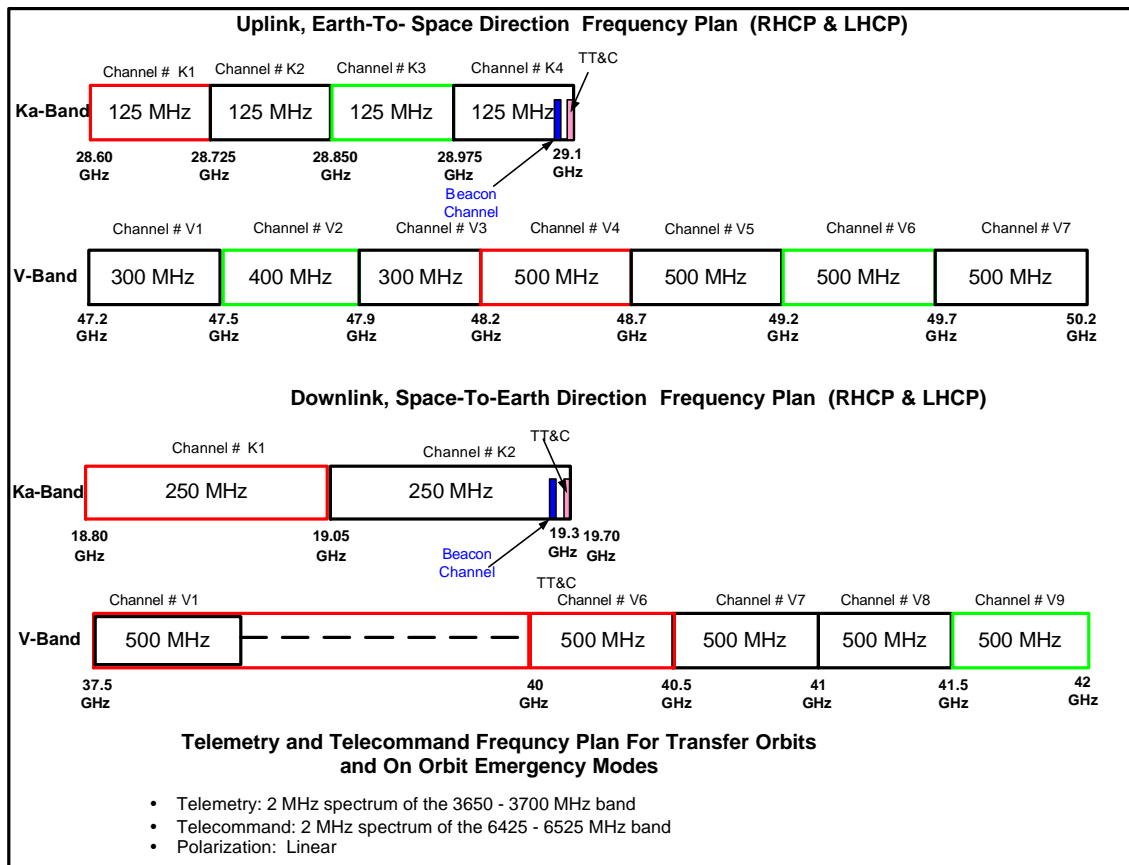

Figure 4B: Non-GSO Satellite (Geosynchronous Circular-Orbit) – Frequency and Polarization Plan

- **GESN Frequency Plan (GSO Component): (Section 25.114(c)(4)(i))**

- **GSO satellites at 119°W and 116.5°E:** The GESN GSO satellites at 119°W and 116.5°E will utilize 2 x 1000 MHz of GSO FSS primary spectrum in the Ka-band, and the full 3000 MHz of V-band uplink and 4500 MHz of V-band downlink FSS spectrum as shown in Figure 5A. In the uplink direction, the 1000 MHz of Ka-band spectrum is divided into eight 125 MHz channels and the V-band spectrum is divided into seven channels: two 300 MHz channels, one 400 MHz channel, and four 500 MHz channels. In the downlink direction, there will be four Ka-band 250 MHz channels and nine V-band 500 MHz channels. Each beam would be able to operate on LHCP and/or RHCP, depending on the traffic demand and sharing conditions.

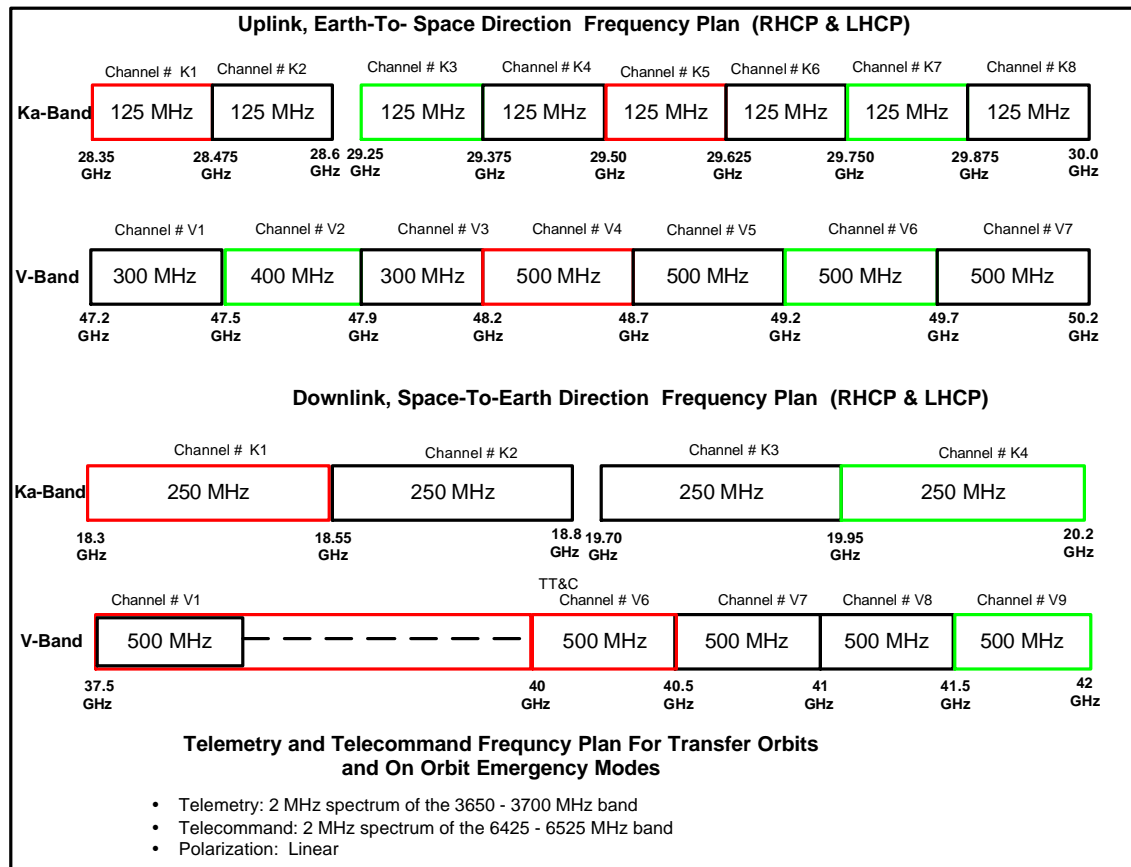

Figure 5A: GSO Satellites at 119°W and 116.5°E – Frequency and Polarization Plan

- **GSO satellite at 89°W:** The GESN GSO satellite at 89°W will utilize 2 x 500 MHz of GSO FSS primary spectrum in the Ka-band, and the full 3000 MHz of V-band uplink and 4500 MHz of V-band downlink FSS spectrum as shown in Figure 5B. In the uplink direction, the 500 MHz of Ka-band spectrum is divided into four 125 MHz channels and the V-band spectrum is divided into seven channels: two 300 MHz channels, one 400 MHz channel, and four 500 MHz channels. In the downlink direction, there will be two Ka-band 250 MHz channels and nine V-band 500 MHz channels. Each beam would be able to operate on LHCP and/or RHCP, depending on the traffic demand and sharing conditions.

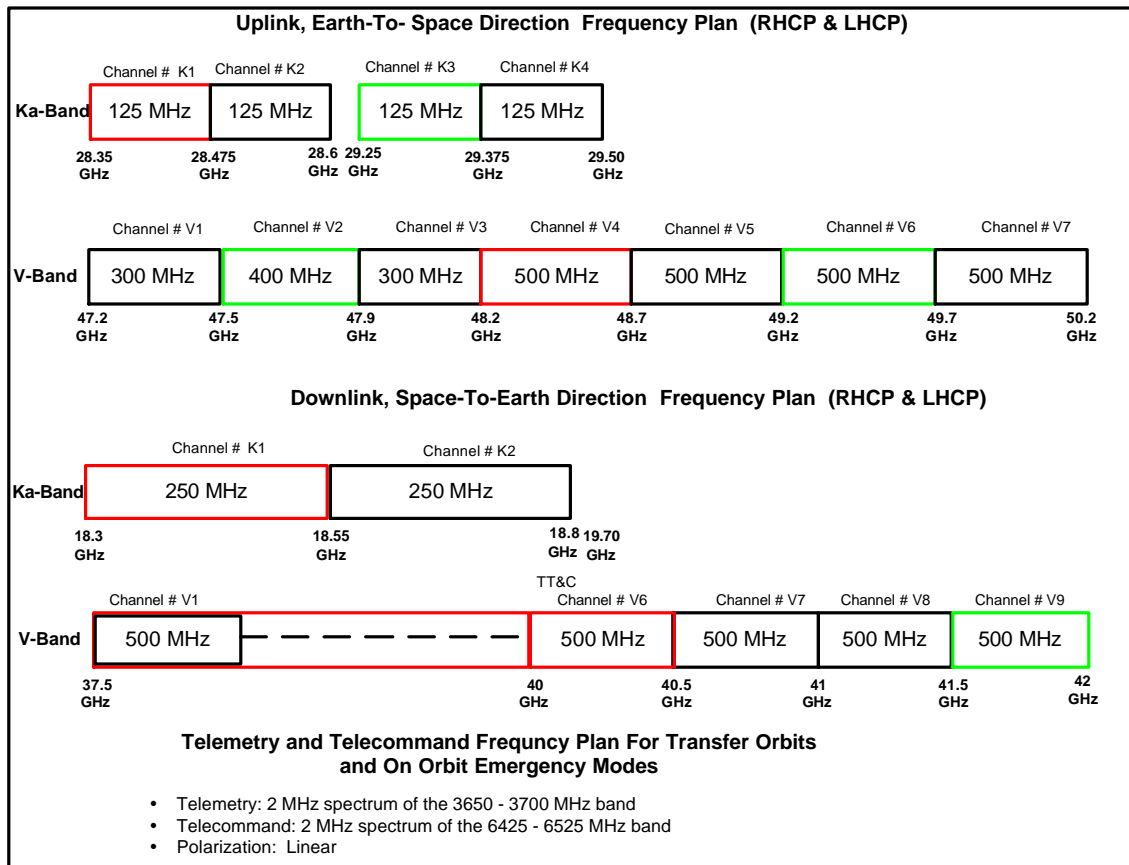

Figure 5B: GSO Satellite Located at 89°W – Frequency and Polarization Plan

- **GSO satellite at 15°E:** The GESN GSO satellite at 15°E will utilize the full 3000 MHz of V-band uplink and 3000 MHz of V-band downlink FSS spectrum as shown in Figure 5C. In the uplink direction, the spectrum is divided into seven channels: two 300 MHz channels, one 400 MHz channel, and four 500 MHz channels. In the downlink direction, six V-band 500 MHz channels will be utilized. Each beam would be able to operate on LHCP and/or RHCP, depending on the traffic demand and sharing conditions.

Note: In the 37.5-42 GHz band, the GESN satellite at 15°E only uses 3000 MHz of the 4500 MHz of downlink spectrum (i.e., six of the nine available channels). The actual configuration used is dependent on the outcome of future GSO/non-GSO sharing deliberations. The downlink frequency plan shown in Figure 5C is one possible configuration, and is dependent on the outcome of future GSO/non-GSO sharing deliberations. NGST has requested a flexible authorization that will enable it to adjust without further application proceedings to the results of future proceedings.

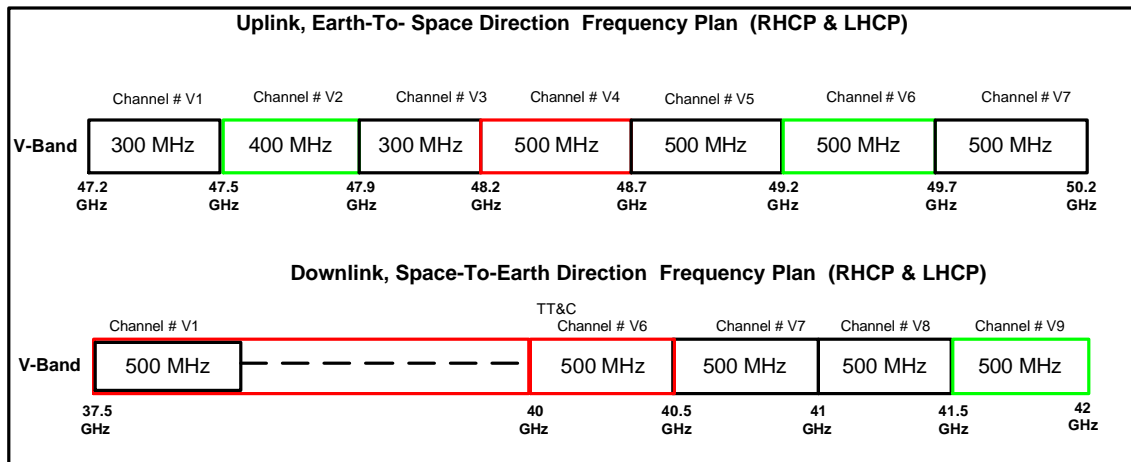

Figure 5C: GSO Satellite Located at 15°E – Frequency and Polarization Plan

- **Center frequencies and polarizations:** The center frequencies and polarizations for the Non-GSO (HEO and Geosynchronous-Circular) and GSO satellites are summarized in Tables 1A, 1B, and 2, respectively.

Table 1A: Non-GSO Satellite (HEO) - Center Frequencies and Polarization

Parameters	Center Frequencies	Polarization
Uplink (Earth-to-Space Direction)		
Standard service links	28.6625 GHz, 28.7875 GHz, 28.9125 GHz, 29.0375 GHz, 29.5625 GHz, 29.6875 GHz, 29.8125 GHz, 29.9375 GHz, 47.35 GHz, 47.7 GHz, 48.05GHz, 48.45 GHz, 48.95 GHz, 49.45 GHz, 49.95 GHz	RHCP & LHCP
Beacon	29.096 GHz	CP
TT&C (Telecommand)		
• Transfer orbits & on-orbit emergency modes	2 MHz spectrum of the 6425 – 6525 MHz band	Linear
• On-orbit operations	29.098 GHz	CP
Downlink (Space-to-Earth Direction)		
Standard service links	18.925 GHz, 19.175 GHz, 19.825 GHz, 20.075 GHz 37.75 GHz, 38.25 GHz, 38.75 GHz, 39.25 GHz, 39.75 GHz, 40.25 GHz, 40.75 GHz, 41.25 GHz, 41.75 GHz	RHCP & LHCP (In the 37.5-42 GHz band, only six 500 MHz channels will be used)
Beacon	19.296 GHz	CP
TT&C (Telecommand)		
• Transfer orbits & on-orbit emergency modes	2 MHz spectrum of the 3650-3700 MHz band	Linear
• On-orbit operations	19.298 GHz	CP

Table 1B: Non-GSO Satellite (Geosynchronous, Circular-Orbit) - Center Frequencies and Polarization

Parameters	Center Frequencies	Polarization
Uplink (Earth-to-Space Direction)		
Standard service links	28.6625 GHz, 28.7875 GHz, 28.9125 GHz, 29.0375 GHz, 47.35 GHz, 47.7 GHz, 48.05GHz, 48.45 GHz, 48.95 GHz, 49.45 GHz, 49.95 GHz	RHCP & LHCP
Beacon	29.096 GHz	CP
TT&C (Telecommand) <ul style="list-style-type: none"> • Transfer orbits & on-orbit emergency modes • On-orbit operations 	2 MHz spectrum of the 6425 – 6525 MHz band 29.098 GHz	Linear CP
Downlink (Space-to-Earth Direction)		
Standard service links	18.925 GHz, 19.175 GHz, 37.75 GHz, 38.25 GHz, 38.75 GHz, 39.25 GHz, 39.75 GHz, 40.25 GHz, 40.75 GHz, 41.25 GHz, 41.75 GHz	RHCP & LHCP (In the 37.5-42 GHz band, only six 500 MHz channels will be used)
Beacon	19.296 GHz	CP
TT&C (Telecommand) <ul style="list-style-type: none"> • Transfer orbits & on-orbit emergency modes • On-orbit operations 	2 MHz spectrum of the 3650-3700 MHz band 19.298 GHz	Linear CP

Table 2: GSO Satellite - Center Frequencies and Polarization

Parameters	Center Frequencies*	Polarization
Uplink (Earth-to-Space Direction)		
Standard service links	28.4125 GHz, 28.5375 GHz, 29.3125 GHz, 29.4375 GHz, 29.5625 GHz, 29.6875 GHz, 29.8125 GHz, 29.9375 GHz, 47.35 GHz, 47.7 GHz, 48.05GHz, 48.45 GHz, 48.95 GHz, 49.45 GHz, 49.95 GHz	RHCP & LHCP
TT&C (Telecommand) • Transfer orbits & on-orbit emergency modes • On-orbit operations	2 MHz spectrum of the 6425 – 6525 MHz band 28.354 GHz	Linear CP
Downlink (Space-to-Earth Direction)		
Standard service links	18.425 GHz, 18.675 GHz 19.825 GHz, 20.075 GHz 37.75 GHz, 38.25 GHz, 38.75 GHz, 39.25 GHz, 39.75 GHz, 40.25 GHz, 40.75 GHz, 41.25 GHz, 41.75 GHz	RHCP & LHCP
TT&C (Telecommand) • Transfer orbits & on-orbit emergency modes • On-orbit operations	2 MHz spectrum of the 3650-3700 MHz band 18.304 GHz	Linear CP

** The 15°E satellite will not include any GSO primary spectrum at Ka-band, and will include only six 500 MHz channels, on a flexible assignment basis, in the 37.5-42 GHz band. The 89°W satellite will not include any channels in the 29.5-30 GHz and 19.7-20.2 GHz bands. The 15°E satellite will share the on-orbit operations TT&C frequencies of the geosynchronous satellite in the non-GSO component of GESN (see Table 1B, above).*

- **Emission designators and allocated bandwidth of emission**

Emission designators and allocated bandwidth of emission are shown in Table 3:

Table 3: Emission Designators and Allocated Bandwidth of Emission

Parameters	Emission Designators	Allocated Bandwidth
Uplink (Earth-to-Space Direction)		
Standard service links		
• Ka-Band	7M0G7W, 3M5G7W, 700K0G7W	7 MHz, 3.5 MHz, 700 kHz
• V-band	491M8G7W, 175M6G7W, 87M8G7W, 35M1G7W	491.8 MHz, 175.6 MHz 87.8 MHz, 35.1 MHz
Beacon	10K7G7D	10.7 kHz
TT&C (Telecommand)		
• Transfer orbits & on-orbit emergency modes	4K0F9D, 1M0FXD	4 kHz, 1 MHz
• On-orbit operations	1M0G7D	1 MHz
Downlink (Space-to-Earth Direction)		
Standard service links		
• Ka-band	250M0G7W, 125M0G7W, 500M0G7W, 250M0G7W	250 MHz, 125 MHz 500 MHz, 250 MHz
• V-band	125M0G7W	125 MHz
Beacon	334K0G7D	334 kHz
TT&C (Telemetry)		
• Transfer orbits & on-orbit emergency modes	4K0F9D, 600KG7D	4 kHz, 600 kHz
• On-orbit operations	2M0G7D	2 MHz

- **Amplifier output power, EIRP and connectivity:** The satellite transmit EIRPs are shown in Table 4:

Table 4: Transmit Power and EIRP

Parameters	Tx power	Circuit loss	Antenna gain	EIRP (peak)
Standard service links				
• Ka-band	50 W	2 dB	48 dBi	63 dBWi
• V-band				
- 37.5-40 GHz	20 W	2 dB	53 dBi	64 dBWi
- 40 – 42 GHz	40 W	2 dB	53 dBi	67 dBWi
Beacon (Ka-band only)	50 W	2 dB	18.5 dBi	33.5 dBWi
TT&C				
• Transfer orbits or on-orbit emergency modes	2 W	3 dB	-3 dBi	-3 dBWi
• On-orbit operations	0.5 W	3 dB	48 dBi	42 dBWi

- **Satellite receive system noise temperature and G/T:** Table 5 summarizes the satellite receive G/T:

Table 5: Satellite G/T

Parameters	Receive Antenna peak gain	System noise temperature	G/T
Standard service links			
• Ka-band	46.5 dBi	504 k	19.5 dB/k
• V-band	54.4 dBi	520 k	27.2 dB/k
Beacon (Ka-band only)	18.5 dBi	504 k	-8.5 dB/k
TT&C			
• Transfer orbits or on-orbit emergency modes	-2 dBi	1154 k	- 32.6 dB/k
• On-orbit operations	46.5 dBi	504 k	19.5 dB/k

- **Maximum transmit power and e.i.r.p. density and pfd**

Table 6 summarizes the satellite transmit power density and downlink pfd.

Table 6: Maximum Transmit Power and e.i.r.p. Density and pfd on the Earth

Parameters	Max transmit power density (dBW/Hz)	Max e.i.r.p. density (dBW/Hz)	Max pfd (dB(W/m ² /MHz)) (Nadir)
Standard service links			
• Ka-band			
○ HEO satellite	- 69.0	-21.0	-116.1
○ GSO satellite	- 69.0	-21.0	-120.1
• V-band			
○ HEO satellite			
○ 37.5-40 GHz	- 76.0	- 23.0	-118.1
○ 40-42 GHz	- 66.9	- 13.9	-109.0
○ GSO satellite			
○ 37.5-40 GHz	-76	-23.0	-125
○ 40-42 GHz	-67.0	- 14.0	-116.0
Beacon (Ka-band only)			
• GSO satellite	-40.2	-21.7	- 123.8
• HEO satellite	-40.2	-21.7	- 116.9
TT&C (On-orbit operation)			
• GSO satellite	-69	-21.0	- 123.1
• HEO satellite	-69	-21.0	- 116.0

3. Orbital Locations for Satellites in Geostationary Orbit (Section 25.114(c)(5)(i))

- **Orbital location:** The GESN system includes four satellites in geostationary orbit. The desired orbital locations of these satellites are: 119°W, 89°W, 15° E, and 116.5° E. These locations were selected to optimize constellation coverage of the world's populated landmasses (in conjunction with the HEO satellites). These locations also are available (to the extent requested) in both Ka-band and V-band for assignment to a U.S. licensee – a prerequisite for NGST's proposed hybrid operation. Considering the foregoing, NGST has only limited flexibility to consider any alternative locations, and it would have to consider alternatives in the context of its coverage requirements for GESN.
- **Service areas:** These four satellites provide service to any user almost everywhere around the world as shown in Figure 2.
- **Longitude tolerance or east-west station-keeping capability:** 0.05 degrees
- **Inclination incursion or north-south station-keeping capability:** 0.05 degrees

4. Satellites in Non-Geostationary Orbits (Section 25.114(c)(6))

The orbital parameters of the GESN HEO satellites are shown in Table 7 below:

Table 7: Orbital parameters (3 HEO satellites)

Orbital Information For Non-geostationary Satellites								
Orbital Plane No.	No. of Satellites in Plane	Inclination Angle (degrees)	Orbital Period (Seconds)	Apogee (km)	Perigee (km)	Right Ascension of the Ascending Node (Deg.)	Argument of Perigee (Degrees)	Active Service Area Range (Degrees)
1	1	63.4	43064	39352	1111	0	270	360
2	1	63.4	43064	39352	1111	120	270	360
3	1	63.4	43064	39352	1111	240	270	360

Initial Satellite Phase Angle		
Orbital Plane No.	Satellite Number	Initial Phase Angle (Degrees)
1	1	0 (Mean Anomaly)
2	2	120 (Mean Anomaly)
3	3	240 (Mean Anomaly)

5. Description of Services to be Provided, Areas to be Served, Transmission Characteristics, Performance Objectives, Details of Link Noise Budget, Baseline Earth Station Parameters, Modulation Parameters, and Overall Link Performance Analysis (Section 25.114(d)(4))

- **Description of service:** The GESN system will provide service almost everywhere in the world as shown in Figure 3. Each satellite will be equipped with 48 active transmit (24 Ka-band and 24 V-band beams) and 60 active receive beams (30 Ka- band and 30 V-band beams), for standard communications, between the ground terminal users and satellites. Each non-GSO satellite also has a transmit and receive beacon beam for the order wire to allow the setup and tear down of the communication paths. All GESN satellites will be self-relay, and/or able to communicate with other satellite systems or space vehicles via their three laser heads.
- **Performance objectives:** The GESN system will provides good link availability for most locations around the world. The link availability will depend on the user types. There are four common types of user terminals: 0.7 m and 1.2 m diameter terminals for Ka-band, and 1.5 m and 2.7 m terminals for V-band. The users operating with 0.7m and 1.2 m earth terminal antennas can achieve up to 10 dB rain fade margin in the downlink and 12 dB fade margin in the uplink. In the V-band, the users operating with 1.5 m earth terminal antennas could achieve up to 18 dB rain fade margin. In order to achieve higher link availability, and

to meet the system capacity objectives, adjustable coding, modulation and data rate will be utilized. In general, the users will reduce their transmit data rates, use heavy coding and/or operate with lower order modulation during the rain fade conditions. The links operate at 2E-10 BER or lower.

- **Modulation Parameters:** 8PSK(8-Phase Shift Keying) and QPSK (Quadrature Phase-Shift Keying) will be used for communications links and order wire.
 - o Downlink:
 - o Modulation: 8PSK, QPSK
 - o Coding:
 - 8PSK: RS (236,212) and convolution code, $r = 5/6$ and $r = 2/3$
 - QPSK: RS (236, 212) and convolution code, $r = 3/4$ and $r = 1/2$
 - o Uplink
 - o Modulation: QPSK
 - o Coding:
 - Light code: RS (236,212)
 - Heavy code: RS (236,212) and Reed-Muller (8,4,4)
- **Link Budgets:** See Attachment B to this Technical Appendix
- **Typical baseline Earth Stations**

The earth terminal parameters are summarized in Table 8 below:

Table 8: Baseline Earth Terminal Parameters

Parameters	Ka-Band		V-Band	
	0.7 m	1.2 m	2.7 m (37.5-40 GHz)	1.5 m (40-42 GHz)
Max. transmit EIRP	47.4 dBWi	54.3 dBWi	75.9 dBWi	68.6 dBWi
Max transmit data rate	2.52 Mbps	10.1 Mbps	706 Mbps	252 Mbps
Receive G/T	16.0 dB/k	20.7 dB/k	33.5 dB/k	28.8 dB/k
Max receive data rate	224 Mbps	374 Mbps	748 Mbps	748 Mbps

6. Downlink power flux density (Section 25.114(d)(5))

The power flux density levels of the GESN HEO and GSO satellites shown in Figures 6 and 7 are below the limits in Sections 25.208(c), (d), (e), (p), (q), (r), (s), (t), and 25.138(a)(6).

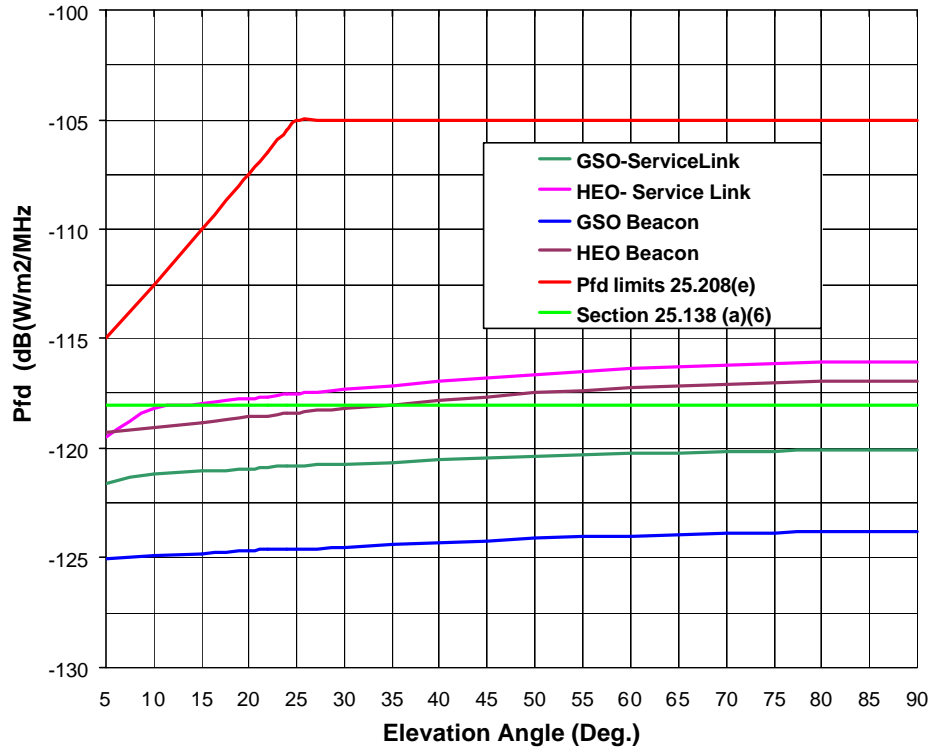

Figure 6: GESN Ka-Band Downlink Power Flux Density Levels

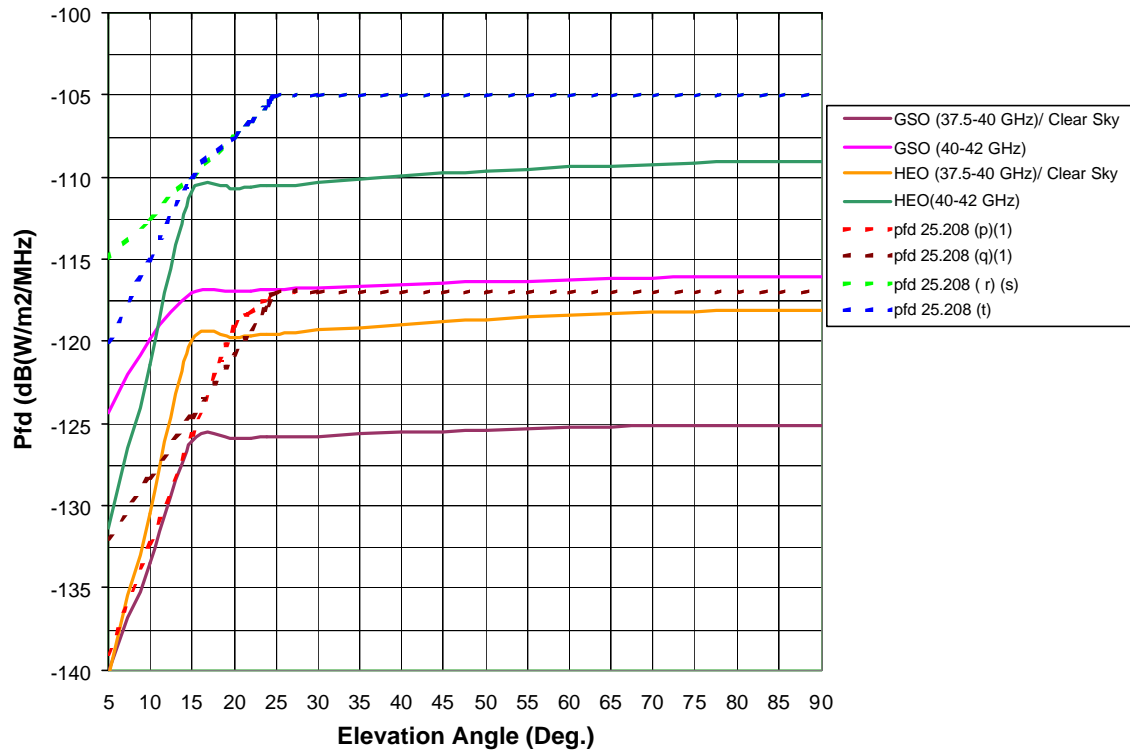

Figure 7: GESN V-Band Downlink Power Flux Density Levels

The maximum downlink power flux density level of the GSO satellites, located 119°W and 116.5°E operating in the 19.7-20.2 GHz band is $-120 \text{ dB(W/m}^2\text{/MHz)}$ as shown in Figure 6 (GSO service link), which complies with Section 25.138(a)(6). In addition, the power flux density level of satellites operating in the 18.6-18.8 GHz band is $-97 \text{ dB(W/m}^2\text{/200 MHz)}$, which meets the power flux density limits shown in Section 25.208(d).

Section 25.138(a): The off-axis EIRP spectral density levels of the GESN GSO satellites operating in the 28.35 –28.6 GHz and 29.25-30 GHz bands shown in Figure 8 are at least 6 dB lower than the values required in Section 25.138(a).

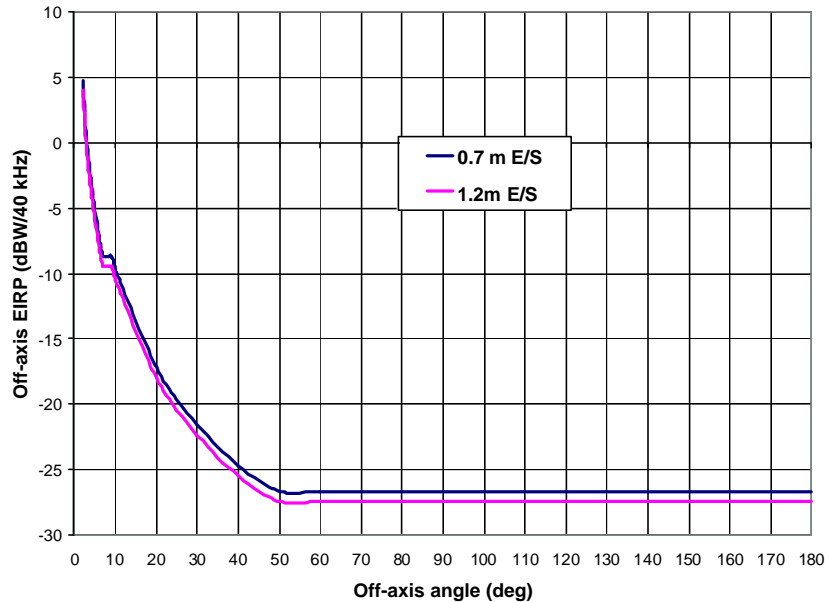

Figure 8: The off-axis EIRP Spectral Density Levels (Clear Sky Conditions)

Figures 6 and 8 also serve as satisfaction of NGST’s requirement to provide an interference analysis with respect to GSO satellite networks operating in the 18.3-18.8 GHz, 19.7-20.2 GHz, 28.35-28.6 GHz and 29.25-30 GHz (none exist at V-band), under Sections 25.114(d)(7) and 25.140(b)(2) of the Commission’s Rules.

Section 25.202(f): Emission Limitations

The out-of-band emissions will be at least attenuated with respect to the mean output power of transmitters as shown in Table 9:

Table 9: Emission Mask

Percentage of the authorized bandwidth	Attenuation of unwanted emissions with respect to the mean power of the transmitter, p (In any 4 kHz band
50 % to 100 %	25 dB
100% to 250%	35 dB
> 250%	43+10Log(p)

7. TT&C System Parameters (Section 25.114(c)(9))

Table 10 summarizes the TT&C subsystem:

Table 10: TT&C Subsystem Arrangements

Parameters	Transfer Orbits and On orbit Emergency Modes		On Orbit Operation	
	Uplink	Downlink	Uplink	Downlink
Frequency band • Bandwidth • Polarization	6425-6525 MHz • 2 MHz • Linear	3650-3700 MHz • 2 MHz • Linear	29.095-29.097 GHz * 28.353-28.255 GHz ** • 2 MHz • Circular (CP)	19.295-19.297 GHz * 18.303-18.305 GHz ** • 2 MHz • Circular (CP)
Emission designator • Bandwidth	4K0F9D, 1M0FXD • 4 kHz, 1 MHz	4K0F9D, 600K0G7D • 4 kHz, 600 kHz	1M0G7D • 1 MHz	2M0G7D • 2 MHz
Transmit EIRP • Tx power into ant. (W) • Tx antenna gain (dBi)	73.9 dBWi (E/S) • 63 W • 55.9 dBi	-3dBWi (Satellite) • 1 W • -3 dBi	76 dBWi (E/S) • 50.5 W • 59 dBi	42 dBWi (satellite) • 0.25W • 48 dBi
Receive G/T • System noise temp (k) • Rx antenna gain (dBi)	-33.6 dB/k (satellite) • 1154 k • -3 dBi	26 dB/k (E/S) • 311 k • 50.98 dBi	19.5 dB/k (satellite) • 504 k • 46.5 dBi	28.9 dB/k (E/S) • 448 k • 55.5 dBi
Modulation`	FM	BPSK	BPSK	BPSK
Notes: * These bands will be used for non-GSO satellites (including both HEO and geosynchronous) ** These bands will be used for GSO satellites located at 119°W, 89°W and 116.5°E				

8. Physical characteristics of the space station including weight and dimensions of spacecraft (Section 25. 114(c)(10))

The GESN payload consists of eight major elements: an V-band subsystem, a Ka-band subsystem, a digital processor, a crosslink subsystem, a payload computer, a beacon access control and timing subsystem, a telemetry, tracking and command (TT&C) subsystem and a timing and frequency generation subsystem as shown in Figure 9. The GESN satellite depicted in Figure 10 consists of a three-axis stabilized bus and a communication payload. Tables 11 and 12 summarize the GESN satellite characteristics:

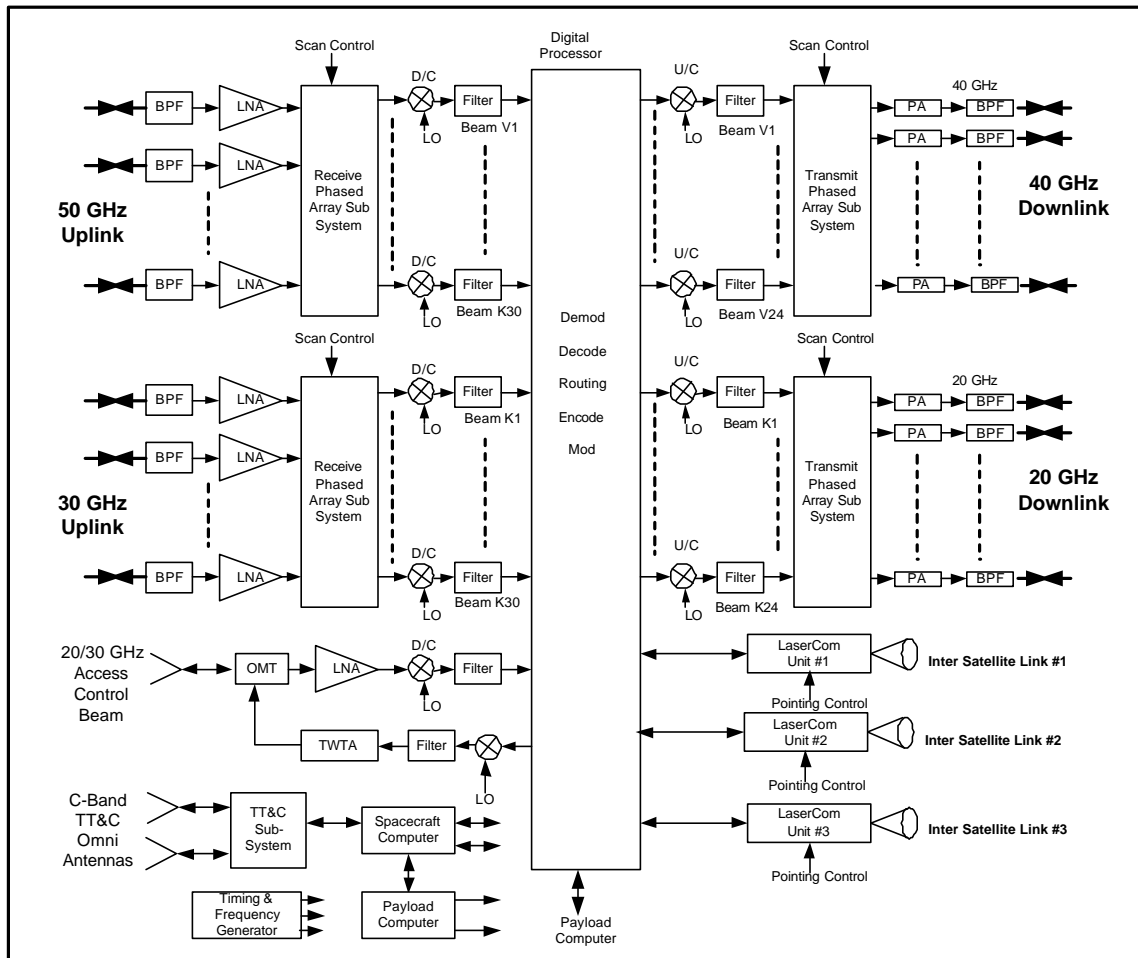

Figure 9: GESN Payload Conceptual Block Diagram

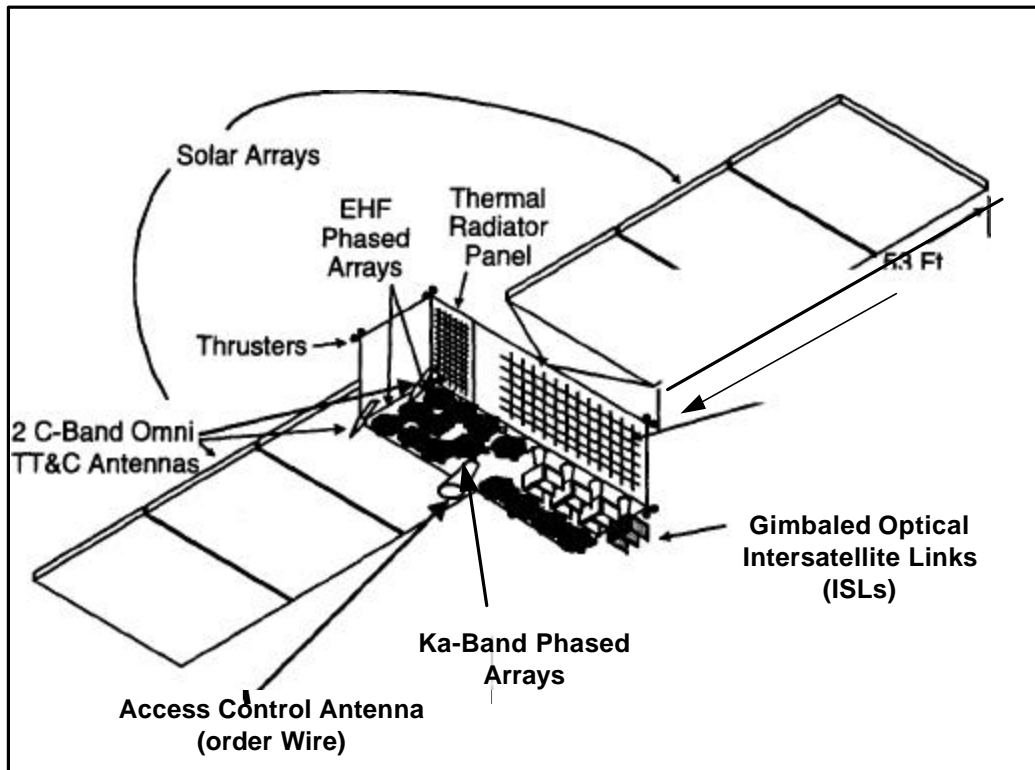

Figure 10: GESN Satellite Configuration

Table 11: GESN GSO Satellite Characteristics

Design life	15 years
Stabilization	3 Axis sensors with the use of reaction wheels and thrusters
DC Power	~ 10.7 kW
Eclipse capability	100%
Deployed length	Approximately 90 ft
Deployed height	Approximately 20 ft
TT &C sub system	2 C-band omni antennas
Number of beams - Ka-band - V-band - Inter-satellite links	24 transmit and 30 receive beams 24 transmit and 30 receive beams 3 laser heads
Number of command carriers	2
Number of telemetry carriers	2
Spectrum re-use	Uplink: ~4; Downlink: ~8
Inclination	0.05 degrees
East-West station-keeping	+/- 0.05 degrees
Antenna beam pointing tolerance	0.05 degrees
Total weight - Payload - Spacecraft - Propellant	5500 kg 1100 kg 1600kg 2800
Total power - Payload - Spacecraft	10.7 kW 8.6kW (including 3 laser heads) 2.1kW

Table 12: GESN HEO Satellite Characteristics

Design life	15 years
Stabilization	3 Axis sensors with the use of reaction wheels and thrusters
DC Power	~ 10.7 kW
Eclipse capability	100%
Deployed length	Approximately 90 ft
Deployed height	Approximately 20 ft
TT &C sub system	2 C-band omni antennas
Number of beams	
- Ka-band	24 transmit and 30 receive beams + 1 beacon beam
- V-band	24 transmit and 30 receive beams
- Inter satellite links	3 laser heads for inter satellite links
Number of command carriers	2
Number of telemetry carriers	2
Number of tracking beacon	1
Spectrum re-use	Uplink: ~4; Downlink: ~8
Orbital parameters	
- Number of satellites	3
- Number of planes	3
- Number of satellites per plane	1
- Inclination angle	63.4 degrees
- Perigee	1111 km
- Orbital period	~ 12 hours
Total weight	3154 kg
- Payload	906 kg
- Spacecraft	1602 kg
- Propellant	646 kg
Total power	10.7kW
- Payload	8.6 kW (including 3 laser heads)
- Spacecraft	2.1 kW

ATTACHMENT A

**FCC Form 312, Schedule S
(Filed Electronically)**

ATTACHMENT B

Link Budgets

The link budgets are presented here as examples.

The GESN GSO and HEO Ka-band link budgets are shown in Tables B1-B8.

The TT&C link budgets are shown in Tables B9 and B10.

Tables B11- B14 summarize the GESN V-band GSO and HEO link budgets.

Table B1: GSO- Ka-Band Uplink

Uplink Budgets- GSO				
Elevation angle (deg)	15.0			
Slant range (km)	40153.8			
Uplink	1.20 m E/S Antenna- User		0.70 m E/S Antenna- User	
	Clear sky	Rain	Clear sky	Rain
Frequency (GHz)	28.9	28.9	28.9	28.9
Earth station transmit EIRP (dBW)	54.3	54.3	47.4	47.4
* Antenna gain (dBi)	49.3	49.3	44.6	44.6
* Transmit power (W)	5.0	5.0	3.0	3.0
* Circuit loss (dB)	2.0	2.0	2.0	2.0
Information data rate (Mbps)	10.10	2.52	2.52	0.50
Code rate	0.9	0.4	0.4	0.4
Modulation	QPSK	QPSK	QPSK	QPSK
Required bandwidth (MHz)	7.0	3.5	3.5	0.7
Space loss (dB)	213.7	213.7	213.7	213.7
Atmospheric & Scintillation Losses (dB)	2.1	-	2.1	-
ITU Combined Loss (dB)		12.0		10.6
Link availability (%)	-	99.40	-	99.20
Aggregate pointing loss (dB)	0.61	0.61	0.61	0.61
Polarization loss/degradation (dB)	0.2	0.1	0.1	0.1
Total Channel losses (dB)	216.7	226.4	216.6	225.1
Satellite Receive G/T (dBi) @ EOC	16.5	16.5	16.5	16.5
* Satellite receive antenna gain (dBi)	46.5	46.5	46.5	46.5
* Receive system noise temp (k)	504.0	504.0	504.0	504.0
* EOC (dB)	3.0	3.0	3.0	3.0
Potential interference degradation (dB)	1.0	1.0	1.0	1.0
Received Eb/No (dB)	11.7	7.9	10.9	9.4
Required Eb/No (dB)	9.3	7.1	7.1	7.1
System margin (dB)	2.4	0.8	3.8	2.3

Table B2: GSO- Ka-band Downlink

Downlink Budgets- GSO				
Elevation angle (deg)	15.0			
Slant Range	40153.8			
Downlink	1.20 m E/S Antenna- User		0.70 m E/S Antenna- User	
	Clear sky	Rain	Clear sky	Rain
Frequency (GHz)	19.1	19.1	19.1	19.1
Satellite transmit EIRP (dBW)	63.0	63.0	63.0	63.0
* Antenna gain (dBi)	48.0	48.0	48.0	48.0
* EOC (dB)	3.0	3.0	3.0	3.0
* Transmit power (W)	50.0	50.0	50.0	50.0
* Circuit loss (dB)	2.0	2.0	2.0	2.0
Information data rate (Mbps)	374.0	112.0	224.0	74.0
Coding	0.75	0.67	0.67	0.45
Modulation	8PSK	QPSK	QPSK	QPSK
Required bandwidth (MHz)	250.0	125.0	250.0	125.0
Space loss (dB)	210.1	210.1	210.1	210.1
Atmospheric & Scintillation Losses (dB)	1.7	-	1.7	-
ITU Combined Loss (dB)		8.1		6.6
Link availability (%)	-	99.70	-	99.50
Aggregate pointing loss (dB)	0.68	0.68	0.69	0.69
Polarization loss/degradation (dB)	0.2	0.1	0.1	0.1
Total Channel losses (dB)	212.7	219.0	212.6	217.4
Earth terminal Receive G/T (dBi)	20.7	19.1	16.0	14.6
* Earth station receive antenna gain (dBi)	45.7	45.7	41.0	41.0
* Receive system noise temp (k)	315.9	454.0	316.1	436.7
Potential interference degradation (dB)	0.5	0.8	0.8	0.8
Received Eb/No (dB)	10.4	7.5	7.7	6.3
Required Eb/No (dB)	8.6	5.4	5.4	4.2
System margin (dB)	1.8	2.1	2.3	2.1

Table B3: GSO – Ka-Band Beacon Uplink

Beacon Uplink Budgets- GSO				
Uplink	1.20 m E/S Antenna- User		0.70 m E/S Antenna- User	
	Clear sky	Rain	Clear sky	Rain
Frequency (GHz)	28.9	28.9	28.9	28.9
Earth station transmit EIRP (dBW)	47.3	54.3	47.4	47.4
* Antenna gain (dBi)	49.3	49.3	44.6	44.6
* Transmit power (W)	1.0	5.0	3.0	3.0
* Circuit loss (dB)	2.0	2.0	2.0	2.0
Information data rate (Mbps)	0.005	0.005	0.005	0.005
Code rate	0.4	0.4	0.4	0.4
Modulation	QPSK	QPSK	QPSK	QPSK
Required bandwidth (MHz)	0.008	0.008	0.008	0.008
Space loss (dB)	213.7	213.7	213.7	213.7
Atmospheric & Scintillation Losses (dB)	2.1	-	2.1	-
ITU Combined Loss (dB)		12.9		8.0
Link availability (%)	-	99.50	-	98.50
Aggregate pointing loss (dB)	0.12	0.12	0.12	0.12
Polarization loss/degradation (dB)	0.1	0.1	0.1	0.1
Total Channel losses (dB)	216.0	226.7	216.0	221.8
Satellite Receive G/T (dBi)	-8.5	-8.5	-8.5	-8.5
* Satellite receive antenna gain (dBi)	18.5	18.5	18.5	18.5
* Receive system noise temp (k)	504.0	504.0	504.0	504.0
**System noise figure (dB)	2.4	2.4	2.4	2.4
* EOC (dB)	3.0	3.0	3.0	3.0
Potential interference degradation (dB)	1.0	1.0	1.0	1.0
Received Eb/No (dB)	10.6	6.9	10.6	4.9
Required Eb/No (dB)	4.2	4.2	4.2	4.2
System margin (dB)	6.4	2.7	6.4	0.7

Table B4: GSO Ka-band Beacon Downlink

Beacon Downlink Budgets- GSO				
Average elevation angle (deg)	15.0			
Downlink	1.20 m E/S Antenna- User		0.70 m E/S Antenna- User	
	Clear sky	Rain	Clear sky	Rain
Frequency (GHz)	19.296	19.296	19.296	19.296
Satellite transmit EIRP (dBW)	33.5	33.5	33.5	33.5
* Antenna gain (dBi)	18.5	18.5	18.5	18.5
* EOC (dB)	3.0	3.0	3.0	3.0
* Transmit power (W)	50.0	50.0	50.0	50.0
* Circuit loss (dB)	2.0	2.0	2.0	2.0
Information data rate (Mbps)	0.2	0.2	0.2	0.2
Modulation	QPSK	QPSK	QPSK	QPSK
Required bandwidth (MHz)	0.334	0.334	0.334	0.334
Space loss (dB)	210.2	210.2	210.2	210.2
Atmospheric & Scintillation Losses (dB)	1.8	-	1.8	-
ITU Combined Loss (dB)		8.4		5.3
Link availability (%)	-	99.70	-	99.00
Aggregate pointing loss (dB)	0.12	0.12	0.12	0.12
Polarization loss/degradation (dB)	0.1	0.1	0.1	0.1
Total Channel losses (dB)	212.3	218.7	212.3	215.6
Earth terminal Receive G/T (dBi)	20.8	19.2	16.1	14.9
* Earth station receive antenna gain (dBi)	45.8	45.8	41.1	41.1
* Receive system noise temp (k)	320.7	456.9	320.9	416.5
Potential interference degradation (dB)	0.8	0.8	0.8	0.8
Received Eb/No (dB)	13.8	5.9	9.1	4.7
Required Eb/No (dB)	4.2	4.2	4.2	4.2
System margin (dB)	9.6	1.7	4.9	0.5

Table B5: HEO Ka-Band Uplink

Uplink Budgets- HEO				
Satellite altitude (km)				
* Maximum operational altitude (km)	39500.0			
Average elevation angle (deg)	15.0			
Slant Range - Max (km)	43811.7			
Slant Range - Min (km)	18820.3			
Uplink	1.20 m E/S Antenna- User	0.70 m E/S Antenna- User		
	Clear sky	Rain	Clear sky	Rain
Frequency (GHz)	29.7	29.7	29.7	29.7
Earth station transmit EIRP (dBW)	54.6	54.6	47.7	47.7
* Antenna gain (dBi)	49.6	49.6	44.9	44.9
* Transmit power (W)	5.0	5.0	3.0	3.0
* Circuit loss (dB)	2.0	2.0	2.0	2.0
Information data rate (Mbps)	10.1	2.5	2.5	0.5
Code rate	0.9	0.4	0.4	0.4
Modulation	QPSK	QPSK	QPSK	QPSK
Required bandwidth (MHz)	7.0	3.5	3.5	0.7
Space loss - max altitude (dB)	214.7	214.7	214.7	214.7
Atmospheric & Scintillation Losses (dB)	2.1	-	2.1	-
ITU Combined Loss (dB)		10.5		10.1
Link availability (%)	-	99.10	-	99.00
Aggregate pointing loss (dB)	1.99	1.99	1.99	1.99
Polarization loss/degradation (dB)	0.2	0.1	0.1	0.1
Total Channel losses (dB)	219.0	227.4	218.9	226.9
Satellite Receive G/T (dBi)	19.4	19.5	19.5	19.5
* Satellite receive antenna gain (dBi)	46.5	46.5	46.5	46.5
* Receive system noise temp (k)	515.7	504.0	504.0	504.0
* EOC (dB)	3.0	3.0	3.0	3.0
Potential interference degradation (dB)	0.5	0.5	0.5	0.5
Received Eb/No (dB)	10.0	7.8	9.3	8.3
Required Eb/No (dB)	9.3	7.1	7.1	7.1
System margin (dB)	0.7	0.7	2.2	1.2

Table B6: HEO Ka-Band Downlink

Downlink Budgets- HEO				
Satellite altitude (km)				
Average elevation angle (deg)	15.0			
Slant Range - Max (km)	43811.7			
Slant Range - Min (km)	19862.5			
Downlink	1.20 m E/S Antenna- User		0.70 m E/S Antenna- User	
	Clear sky	Rain	Clear sky	Rain
Frequency (GHz)	19.9	19.9	19.9	19.9
Satellite transmit EIRP (dBW)	63.0	63.0	63.0	63.0
* Antenna gain (dBi)	48.0	48.0	48.0	48.0
* EOC (dB)	3.0	3.0	3.0	3.0
* Transmit power (W)	50.0	50.0	50.0	50.0
* Circuit loss (dB)	2.0	2.0	2.0	2.0
Information data rate (Mbps)	374.0	224.0	224.0	149.0
Code rate	0.75	0.67	0.67	0.45
Modulation	8PSK	QPSK	QPSK	QPSK
Required bandwidth (MHz)	250.0	250.0	250.0	250.0
Space loss - max altitude (dB)	211.3	211.3	211.3	211.3
Atmospheric & Scintillation Losses (dB)	2.2	-	2.2	-
ITU Combined Loss (dB)		7.6		5.0
Link availability (%)	-	99.50	-	98.50
Earth terminal pointing capability	10%	10%	10%	10%
Aggregate pointing loss (dB)	0.87	0.87	2.52	2.52
Polarization loss/degradation (dB)	0.2	0.1	0.1	0.1
Total Channel losses (dB)	214.5	219.8	216.1	218.9
Earth terminal Receive G/T (dBi)	20.9	19.6	16.2	15.3
* Earth station receive antenna gain (dBi)	46.1	46.1	41.4	41.4
* Receive system noise temp (k)	333.9	449.0	334.1	412.2
Potential interference degradation (dB)	0.5	0.5	0.5	0.5
Received Eb/No (dB)	11.0	6.7	7.0	5.3
Required Eb/No (dB)	8.6	5.4	5.4	4.2
System margin (dB)	2.4	1.3	1.6	1.1

Table B7: HEO Ka-band Beacon Uplink

Uplink Budgets- HEO				
Satellite altitude (km)				
Average elevation angle (deg)	15.0			
Slant Range - Max (km)	43811.7			
Slant Range - Min (km)	18820.3			
Uplink	1.20 m E/S Antenna- User		0.70 m E/S Antenna- User	
	Clear sky	Rain	Clear sky	Rain
Frequency (GHz)	29.7	29.7	29.7	29.7
Earth station transmit EIRP (dBW)	47.6	52.3	47.7	47.7
* Antenna gain (dBi)	49.6	49.6	44.9	44.9
* Transmit power (W)	1.0	3.0	3.0	3.0
* Circuit loss (dB)	2.0	2.0	2.0	2.0
Information data rate (Mbps)	0.005	0.005	0.005	0.005
Code rate	0.4	0.4	0.4	0.4
Modulation	QPSK	QPSK	QPSK	QPSK
Required bandwidth (MHz)	0.0080	0.0080	0.0080	0.0080
Space loss - max altitude (dB)	214.7	214.7	214.7	214.7
Atmospheric & Scintillation Losses (dB)	2.1	-	2.1	-
ITU Combined Loss (dB)		11.7		7.3
Link availability (%)	-	99.30	-	98.00
Aggregate pointing loss (dB)	0.12	0.12	0.12	0.12
Polarization loss/degradation (dB)	0.1	0.1	0.1	0.1
Total Channel losses (dB)	217.0	226.5	217.0	222.1
Satellite Receive G/T (dBi)	-8.6	-8.5	-8.5	-8.5
* Satellite receive antenna gain (dBi)	18.5	18.5	18.5	18.5
* Receive system noise temp (k)	515.7	504.0	504.0	504.0
* EOC (dB)	3.0	3.0	3.0	3.0
Potential interference degradation (dB)	0.5	0.5	0.5	0.5
Received Eb/No (dB)	10.2	5.6	10.4	5.4
Required Eb/No (dB)	4.2	4.2	4.2	4.2
System margin (dB)	6.0	1.4	6.2	1.2

Table B8: HEO Ka-Band Beacon Downlink

Downlink Budgets- HEO				
Satellite altitude (km)				
Average elevation angle (deg)	10.0			
Slant Range - Max (km)	44338.5			
Slant Range - Min (km)	20370.9			
Downlink	1.20 m E/S Antenna- User		0.70 m E/S Antenna- User	
	Clear sky	Rain	Clear sky	Rain
Frequency (GHz)	19.29	19.29	19.29	19.29
Satellite transmit EIRP (dBW)	33.4	33.4	33.4	33.4
* Antenna gain (dBi)	18.4	18.4	18.4	18.4
* EOC (dB)	3.0	3.0	3.0	3.0
* Transmit power (W)	50.0	50.0	50.0	50.0
* Circuit loss (dB)	2.0	2.0	2.0	2.0
Information data rate (Mbps)	0.2	0.2	0.2	0.2
Code rate	0.4	0.4	0.4	0.4
Modulation	QPSK	QPSK	QPSK	QPSK
Required bandwidth (MHz)	0.334	0.334	0.334	0.334
Space loss - max altitude (dB)	211.1	211.1	211.1	211.1
Atmospheric & Scintillation Losses (dB)	2.8	-	2.8	-
ITU Combined Loss (dB)		10.2		6.3
Link availability (%)	-	99.60	-	98.50
Earth terminal pointing capability	10%	10%	10%	10%
Aggregate pointing loss (dB)	0.12	0.12	0.12	0.12
Polarization loss/degradation (dB)	0.1	0.1	0.1	0.1
Total Channel losses (dB)	214.1	221.4	214.1	217.5
Earth terminal Receive G/T (dBi)	20.3	19.1	15.6	14.8
* Earth station receive antenna gain (dBi)	45.8	45.8	41.1	41.1
* Receive system noise temp (k)	355.0	470.1	355.2	433.3
Potential interference degradation (dB)	0.5	0.5	0.5	0.5
Received Eb/No (dB)	14.3	5.8	9.6	5.3
Required Eb/No (dB)	4.2	4.2	4.2	4.2
System margin (dB)	10.1	1.6	5.4	1.1

Table B9: GSO TT&C Link budgets

		TRANSFER ORBITS		ON ORBIT OPERATION	
		UPLINK	DOWNLINK	UPLINK	DOWNLINK
		(Command)	(Telemetry)	(Command)	(Telemetry)
Elevation Angle (Deg.) =	5				
Satellite Altitude (Km) =	35878				
Frequency (GHz)		6.475	3.675	29.098 or 28.354	19.298 or 18.304
Transmit RF power (W)		100.00	2.00	80.00	0.50
Circuit Loss (dB)		2.00	3.00	2.00	3.00
Transmit antenna gain (dBi)		55.90	-3.00	59.01	48.00
EIRP		73.90	-2.99	76.04	41.99
Path Loss (dB)		200.97	196.05	214.03	210.46
Pointing error (dB)		0.50	0.50	0.50	0.50
Atmospheric + Scintillation loss (dB)		2.10	1.60	8.62	7.50
Polarization loss (dB)		0.40	0.40	0.40	0.40
Total channel loss (dB)		203.98	198.56	223.54	218.86
Receive antenna gain (dBi)		-2.00	50.98	46.50	55.44
Receive power (dBW)		-132.07	-145.56	-101.00	-104.63
Receive system noise temperature (k)		864.51	225.70	213.96	225.70
Total system noise temperature (k)		1154.5	311.0	504.0	448.2
G/T		-32.62	26.06	19.48	28.93
C/No		65.90	58.11	100.57	97.46
Carrier modulation		FM	PHASE	Phase	PHASE
Data modulation		FSK	BPSK	BPSK	BPSK
Data rate (kbps)		4.00	4.00	500.00	1000.00
Received Eb/No		29.88	22.09	43.58	37.46
Required Eb/No, including implementation loss (dB)		18.00	15.00	18.00	15.00
System Margin , Clear sky (dB)		11.88	7.09	25.58	22.46
RAIN					
		(Command)	(Telemetry)	(Command)	(Telemetry)
Link availability (%)		99.98	99.98	99.40	99.40
ITU Combined Loss (dB)		8.69	4.10	28.55	24.50
System noise temp./ Rain (k)		-	391.93	-	494.75
Receives Eb/No, Rain (dB)		23.29	18.58	23.65	20.03
System Margin in rain (dB)		5.29	3.58	5.65	5.03
Earth Terminal Antenna Parameters					
		(Command)	(Telemetry)	(Command)	(Telemetry)
Wavelength (cm)		4.615	8.131	1.027	1.548
Antenna gain (dBi)		55.90	50.98	59.01	55.44
3 dB beamwidth (deg)		0.29	0.52	0.21	0.31
Antenna efficiency (%)		70%	70%	70%	70%
Antenna size		11.0	11.00	3.5	3.50

Table B10: HEO TT&C Linkbudgets

		TRANSFER ORBITS		ON ORBIT OPERATION	
		UPLINK	DOWNLINK	UPLINK	DOWNLINK
		(Command)	(Telemetry)	(Command)	(Telemetry)
Elevation Angle (Deg.) =	5				
Satellite Altitude (Km) =	39500				
Frequency (GHz)		6.475	3.675	29.098	19.298
Transmit RF power (W)		100.00	2.00	80.00	0.50
Circuit Loss (dB)		2.00	3.00	2.00	3.00
Transmit antenna gain (dBi)		55.90	-3.00	59.01	48.00
EIRP		73.90	-2.99	76.04	41.99
Path Loss (dB)		201.71	196.79	214.77	211.20
Pointing error (dB)		0.50	0.50	0.50	0.50
Atmospheric + Scintillation loss (dB)		2.10	1.60	8.62	7.50
Polarization loss (dB)		0.40	0.40	0.40	0.40
Total channel loss (dB)		204.72	199.29	224.28	219.60
Receive antenna gain (dBi)		-2.00	50.98	46.50	55.44
Receive power (dBW)		-132.81	-146.30	-101.74	-105.37
Receive system noise temperature (k)		864.51	225.70	213.96	225.70
Total system noise temperature (k)		1154.5	311.0	504.0	448.2
G/T		-32.62	26.06	19.48	28.93
C/No		65.16	57.37	99.83	96.72
Carrier modulation		FM	PHASE	Phase	PHASE
Data modulation		FSK	BPSK	BPSK	BPSK
Data rate (kbps)		4.00	4.00	500.00	1000.00
Received Eb/No		29.14	21.35	42.84	36.72
Required Eb/No, including implementation loss (dB)		18.00	15.00	18.00	15.00
System Margin , Clear sky (dB)		11.14	6.35	24.84	21.72
RAIN					
		(Command)	(Telemetry)	(Command)	(Telemetry)
Link availability (%)		99.98	99.98	99.40	99.40
ITU Combined Loss (dB)		8.69	4.10	28.55	24.50
System noise temp./ Rain (k)		-	391.93	-	494.75
Receives Eb/No, Rain (dB)		22.55	17.84	22.91	19.30
System Margin in rain (dB)		4.55	2.84	4.91	4.30
Earth Terminal Antenna Parameters					
		(Command)	(Telemetry)	(Command)	(Telemetry)
Wavelength (cm)		4.615	8.131	1.027	1.548
Antenna gain (dBi)		55.90	50.98	59.01	55.44
3 dB beamwidth (deg)		0.29	0.52	0.21	0.31
Antenna efficiency (%)		70%	70%	70%	70%
Antenna size		11.0	11.00	3.5	3.50

Table B11: GSO V-Band Downlink

Downlink Budgets- GEO			
Elevation angle (deg)	15.0		
Downlink	2.7 m E/S Antenna - Hub 37.5-40 GHz Band	1.50 m E/S Antenna- User 40 - 42 GHz Band	
		Clear sky	Rain
Frequency (GHz)	38.8	41.0	41.0
Satellite transmit EIRP (dBW)	64.0	67.0	67.0
* Antenna gain (dBi)	53.0	53.0	53.0
* EOC (dB)	3.0	3.0	3.0
* Transmit power (W)	20.0	40.0	40.0
* Circuit loss (dB)	2.0	2.0	2.0
Information data rate (Mbps)	748.0	748.0	74.0
Code Rate	0.749	0.749	0.449
Modulation	8PSK	8PSK	QPSK
Symbol rate (Msps)	333	333	83
Required bandwidth (MHz)	500.0	500.0	125.0
Space loss (dB)	216.3	216.8	216.8
Atmospheric & Scintillation Losses (dB)	2.5	2.9	-
ITU Combined Loss (dB)			16.3
Link availability (%)	-	-	99.00
Pointing loss (dB)	0.53	0.53	0.53
Aggregate pointing loss (dB)	0.55	0.55	0.55
Polarization loss/degradation (dB)	0.2	0.2	0.1
Total Channel losses (dB)	219.6	220.4	233.7
Earth terminal Receive G/T (dBi)	33.5	28.8	27.4
* Earth station receive antenna gain (dBi)	58.9	54.3	54.3
* Receive system noise temp (k)	346.6	358.2	489.5
Potential interference degradation (dB)	0.5	0.5	0.5
Received Eb/No (dB)	14.3	11.7	7.1
Required Eb/No (dB)	8.6	8.6	4.2
System margin (dB)	5.7	3.1	2.9

Table B12: GSO V-band Uplink

Uplink Budgets- GSO				
Elevation angle (deg)	15.0			
Uplink	2.70 m E/S Antenna- User		1.50 m E/S Antenna- User	
	Clear sky	Rain	Clear sky	Rain
Frequency (GHz)	48.7	48.7	48.7	48.7
Earth station transmit EIRP (dBW)	75.9	75.9	68.6	68.6
* Antenna gain (dBi)	60.9	60.9	55.8	55.8
* Transmit power (W)	50.0	50.0	30.0	30.0
* Circuit loss (dB)	2.0	2.0	2.0	2.0
Information data rate (Mbps)	706.0	63.0	252.0	25.0
Code rate	0.9	0.4	0.9	0.4
Modulation	QPSK	QPSK	QPSK	QPSK
Required bandwidth (MHz)	491.8	87.8	175.6	35.1
Space loss (dB)	218.3	218.3	218.3	218.3
Atmospheric & Scintillation Losses (dB)	5.6	-	5.6	-
ITU Combined Loss (dB)		19.2		17.0
Link availability (%)	-	98.50	-	98.00
Aggregate pointing loss (dB)	2.92	2.92	2.92	2.92
Polarization loss/degradation (dB)	0.2	0.1	0.2	0.1
Total Channel losses (dB)	227.0	240.5	227.1	238.4
Satellite Receive G/T (dBi)	27.2	27.2	27.2	27.2
* Satellite receive antenna gain (dBi)	54.4	54.4	54.4	54.4
* Receive system noise temp (k)	520.0	520.0	520.0	520.0
* EOC (dB)	3.0	3.0	3.0	3.0
Potential interference degradation (dB)	0.5	0.5	0.5	0.5
Received Eb/No (dB)	12.7	9.7	9.8	8.6
Required Eb/No (dB)	9.3	7.1	9.3	7.1
System margin (dB)	3.4	2.6	0.5	1.5

Table B13: HEO V-Band Downlink

Downlink Budgets- HEO			
Satellite altitude (km)			
Average elevation angle (deg)	15.0		
Slant Range - Max (km)	43811.7		
Slant Range - Min (km)	19862.5		
Downlink	2.7 m E/S Antenna - Hub 37.5-40 GHz Band	1.50 m E/S Antenna- User 40 - 42 GHz Band	
		Clear sky	Rain
Frequency (GHz)	38.8	41.0	41.0
Satellite transmit EIRP (dBW)	64.0	67.0	67.0
* Antenna gain (dBi)	53.0	53.0	53.0
* EOC (dB)	3.0	3.0	3.0
* Transmit power (W)	20.0	40.0	40.0
* Circuit loss (dB)	2.0	2.0	2.0
Information data rate (Mbps)	748.0	748.0	74.0
Code Rate	0.749	0.749	0.449
Modulation	8PSK	8PSK	QPSK
Symbol rate (Mpsps)	333	333	83
Required bandwidth (MHz)	500.0	500.0	125.0
Space loss - max altitude (dB)	217.0	217.5	217.5
Atmospheric & Scintillation Losses (dB)	2.5	2.9	-
ITU Combined Loss (dB)			13.5
Link availability (%)	-	-	98.50
Pointing loss (dB)	2.12	2.12	2.12
Aggregate pointing loss (dB)	2.12	2.12	2.12
Polarization loss/degradation (dB)	0.2	0.1	0.1
Total Channel losses (dB)	221.9	222.6	233.2
Earth terminal Receive G/T (dBi)	33.5	28.8	27.5
* Earth station receive antenna gain (dBi)	58.9	54.3	54.3
* Receive system noise temp (k)	346.6	358.2	483.8
**System noise figure (dB)	2.5	2.5	2.5
Potential interference degradation (dB)	0.5	0.5	0.5
Received Eb/No (dB)	12.0	9.5	7.7
Required Eb/No (dB)	8.6	5.4	4.2
System margin (dB)	3.4	4.1	3.5

Table B14: HEO V-Band Uplink

Uplink Budgets- HEO				
Satellite altitude (km)				
Average elevation angle (deg)	16.0			
Slant Range - Max (km)	43708.5			
Slant Range - Min (km)	18722.0			
Uplink	2.70 m E/S Antenna- User		1.50 m E/S Antenna- User	
	Clear sky	Rain	Clear sky	Rain
Frequency (GHz)	48.7	48.7	48.7	48.7
Earth station transmit EIRP (dBW)	75.9	75.9	68.6	68.6
* Antenna gain (dBi)	60.9	60.9	55.8	55.8
* Transmit power (W)	50.0	50.0	30.0	30.0
* Circuit loss (dB)	2.0	2.0	2.0	2.0
Information data rate (Mbps)	706.0	63.0	252.0	25.0
Code rate	0.9	0.4	0.9	0.4
Modulation	QPSK	QPSK	QPSK	QPSK
Required bandwidth (MHz)	491.8	87.8	175.6	35.1
Space loss - max altitude (dB)	219.0	219.0	219.0	219.0
Atmospheric & Scintillation Losses (dB)	5.2	-	5.3	-
ITU Combined Loss (dB)		18.3		13.5
Link availability (%)	-	98.50	-	97.00
Aggregate pointing loss (dB)	2.92	2.92	2.92	2.92
Polarization loss/degradation (dB)	0.2	0.1	0.2	0.1
Total Channel losses (dB)	227.4	240.3	227.4	235.6
Satellite Receive G/T (dBi)	27.2	27.2	27.2	27.2
* Satellite receive antenna gain (dBi)	54.4	54.4	54.4	54.4
* Receive system noise temp (k)	520.0	520.0	520.0	520.0
* EOC (dB)	3.0	3.0	3.0	3.0
Potential interference degradation (dB)	0.5	0.5	0.5	0.5
Received Eb/No (dB)	12.4	9.9	9.5	11.4
Required Eb/No (dB)	9.3	7.1	9.3	7.1
System margin (dB)	3.1	2.8	0.2	4.3

ATTACHMENT C

Satellite Transmit and Receive Antenna Contours

Figure C1: GSO Ka-band Transmit Antenna Contours (Copol & Xpol)

Figure C2: GSO Ka-band Receive Antenna Contours (Copol & Xpol)

Figure C3: GSO V-band Transmit Antenna Contours (CoPol & XPol)

Figure C4: GSO V-Band Receive Antenna Contours (CoPol & Xpol)

Figure C5: Transmit and Receive Ka-band Beacon Beam (from Satellite @ 119W) (CoPol & Xpol)

Figure C6: Transmit and Receive Ka-band Beacon Beam (from Satellite @ 89W) (CoPol & Xpol)

Figure C7: Transmit and Receive Ka-band Beacon Beam (from Satellite @ 15E) (CoPol & Xpol)

Figure C8: Transmit and Receive Ka-band Beacon Beam (from Satellite @ 116.5 E) (CoPol & Xpol)

Figure C9: HEO (@129.6W, 63.4 N & 39254 km) Ka-band Transmit Antenna Beam (CoPol & Xpol)

Figure C10: HEO (@129.6W, 63.4 N & 39254 km) Ka-band Receive Antenna Beam (CoPol & Xpol)

Figure C11: HEO (@129.6W, 63.4 N & 39254 km) V-band Receive Antenna Beam (CoPol & Xpol)

Figure C12: HEO (@129.6W, 63.4 N & 39254 km) V-band Receive Antenna Beam (CoPol & Xpol)

Figure C13: HEO (@129.6W, 63.4 N & 39254 km) Ka-band Transmit and Receive Beacon Beam (CoPol & Xpol)

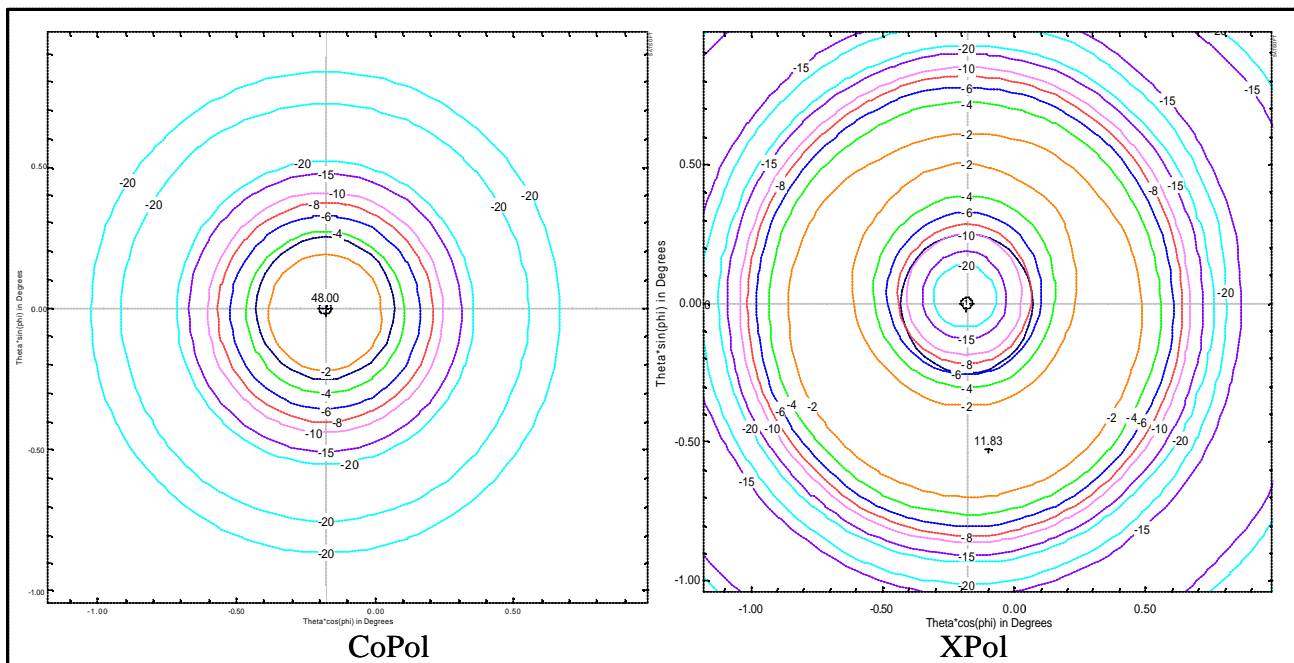

Figure C1: GSO Ka-band Transmit Antenna Contours (Copol & Xpol) (Contour levels: -2, -4, -6, -8, -10, -15, -20 dB)

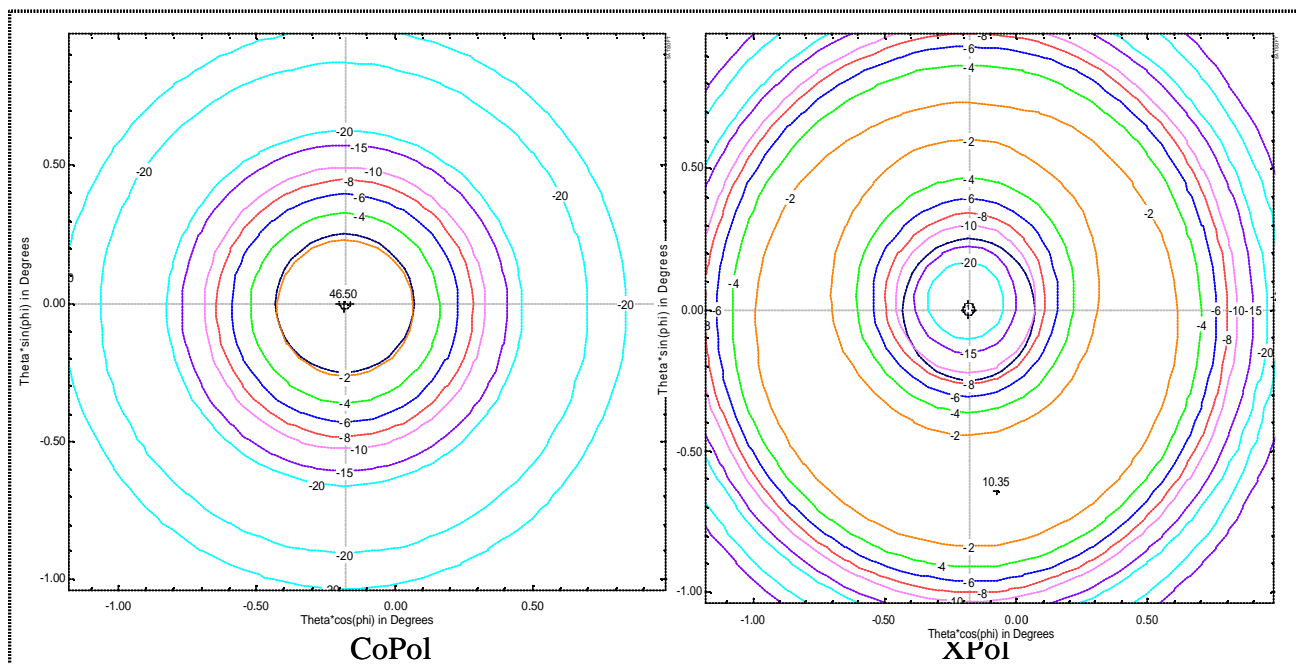

Figure C2: GSO Ka-band Receive Antenna Contours (Copol & Xpol) (Contour levels: -2, -4, -6, -8, -10, -15, -20 dB)

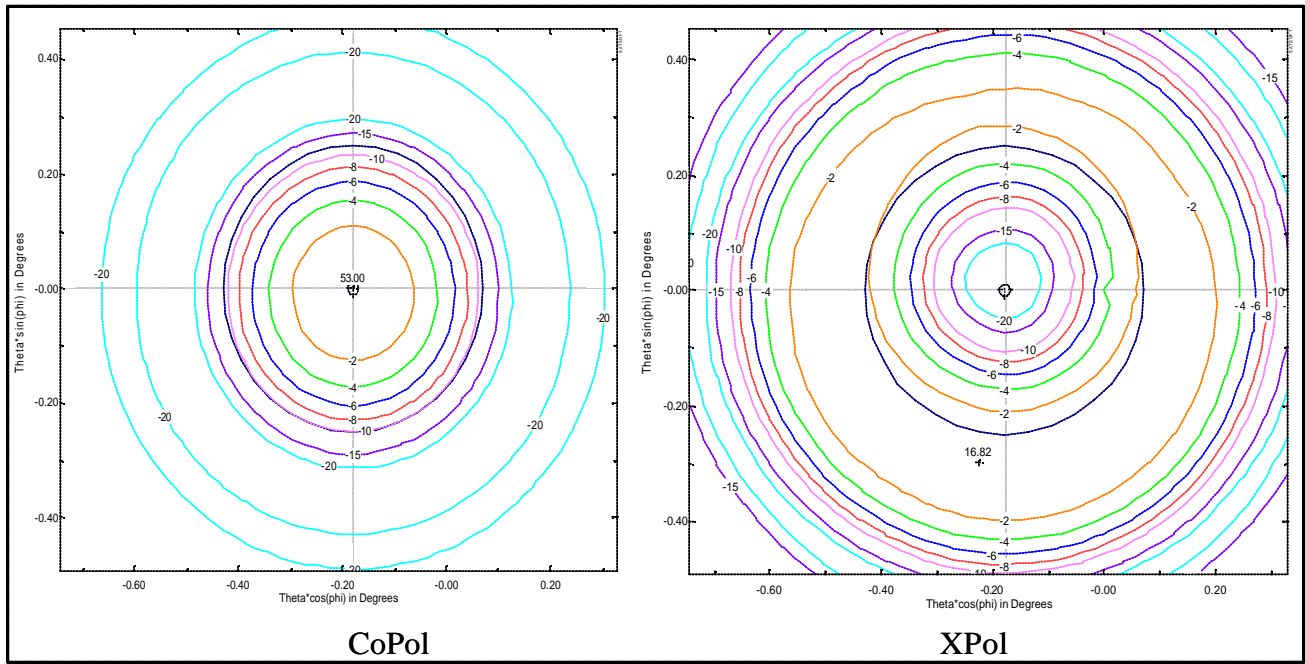

Figure C3: GSO V-band Transmit Antenna Contours (CoPol & XPol) (Contour levels: -2, -4, -6, -8, -10, -15, -20 dB)

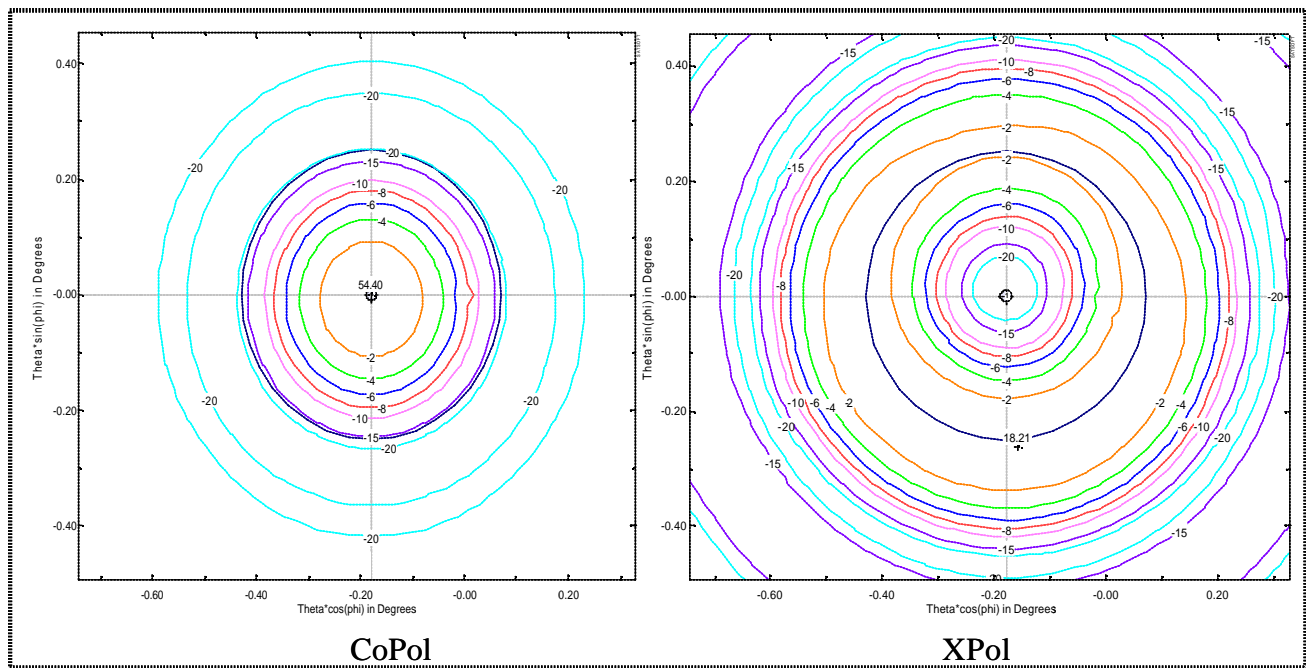

Figure C4: GSO V-band Receive Antenna Contours (CoPol & XPol) (Contour levels: -2, -4, -6, -8, -10, -15, -20 dB)

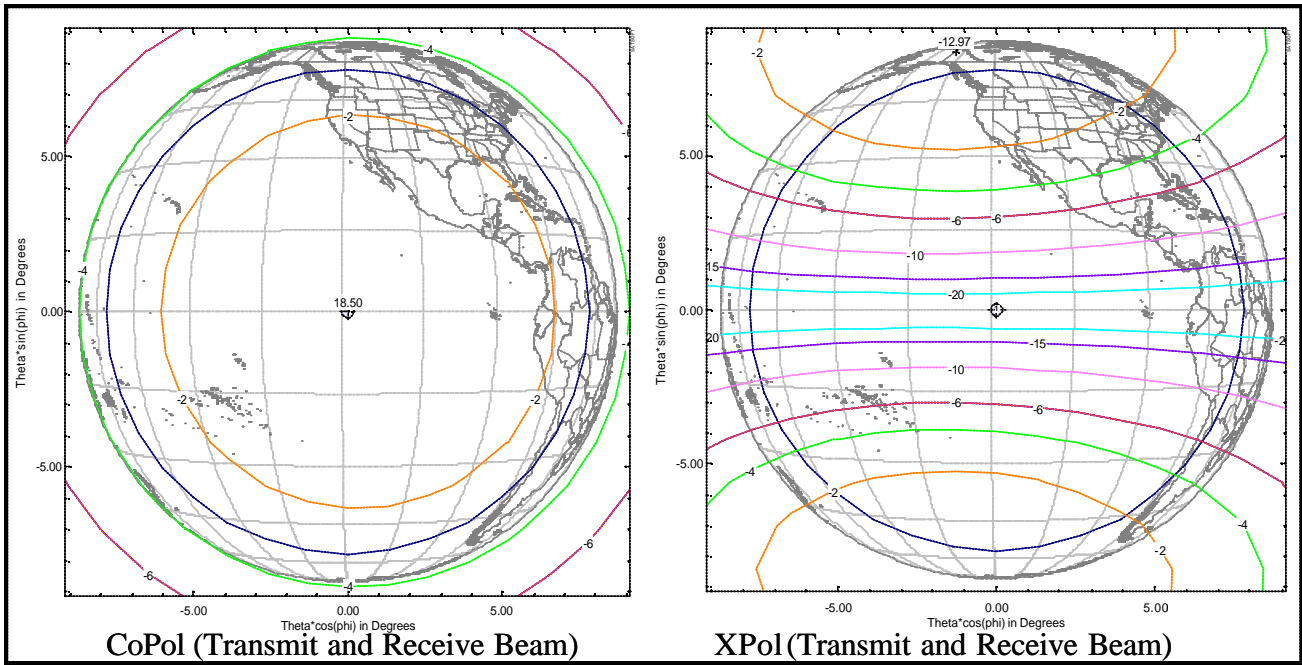

Figure C5: Transmit and Receive Ka-band Beacon Beam (from Satellite @ 119W) (CoPol & Xpol)

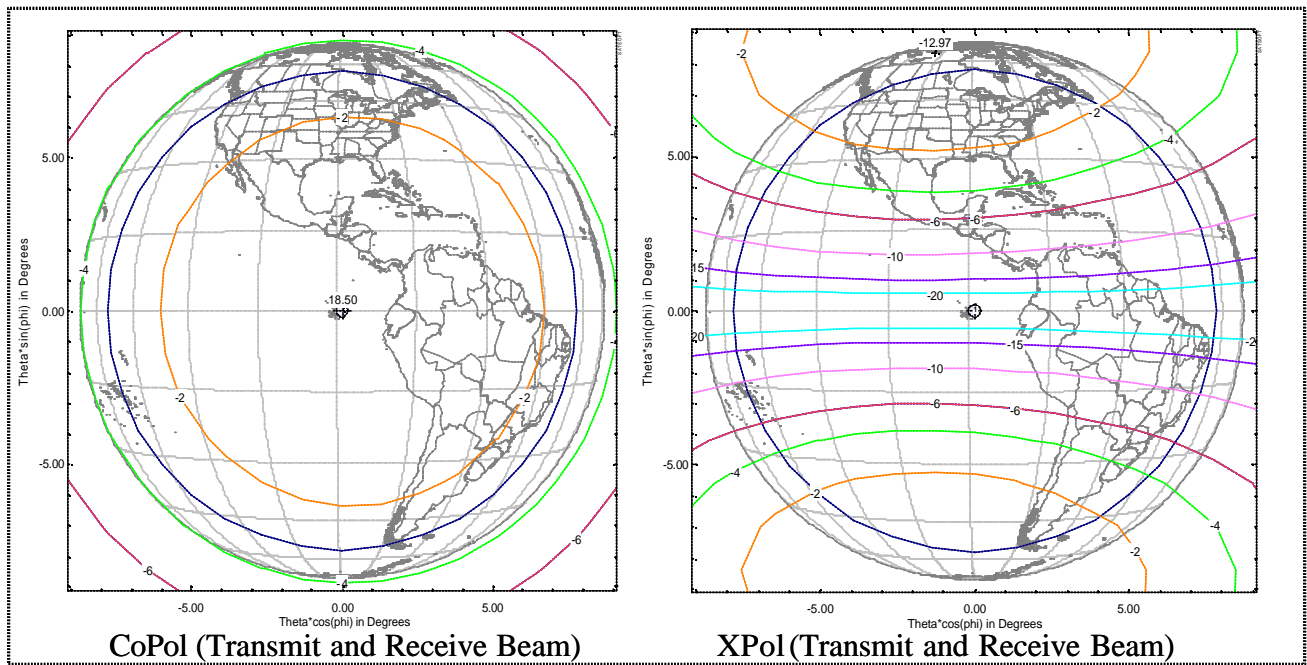

Figure C6: Transmit and Receive Ka-band Beacon Beam (from Satellite @ 89W) (CoPol & Xpol)

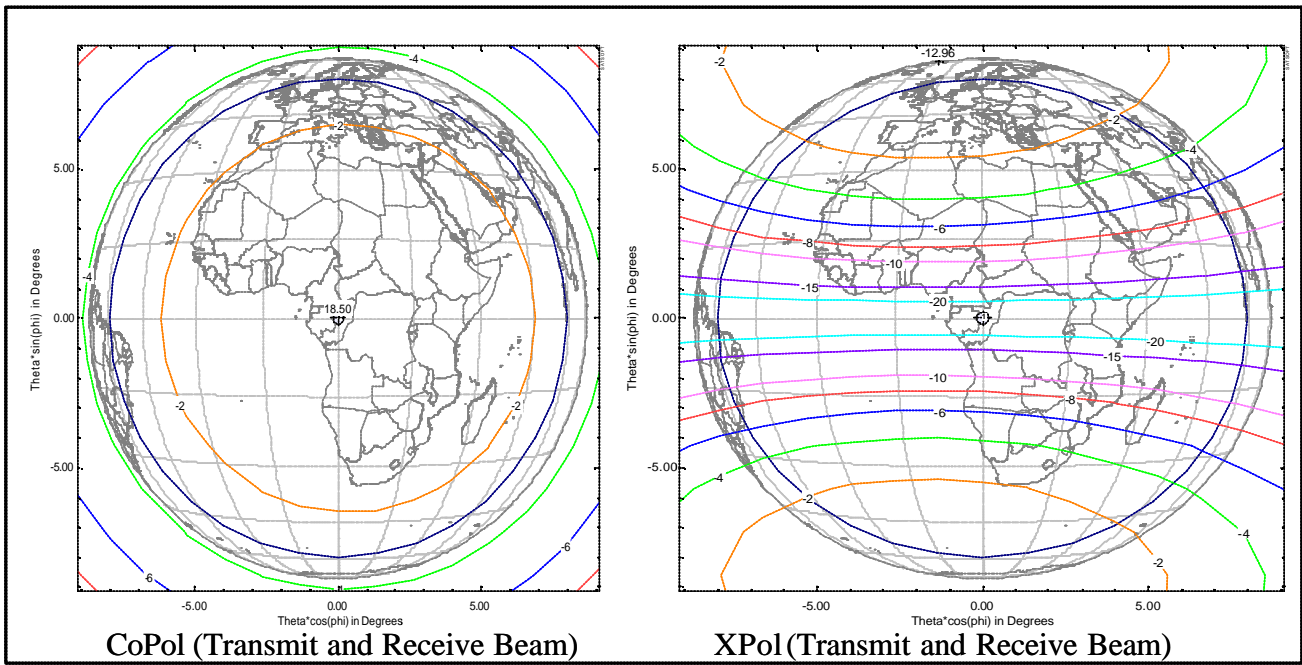

Figure C7: Transmit and Receive Ka-band Beacon Beam (from Satellite @ 15E) (CoPol & Xpol)

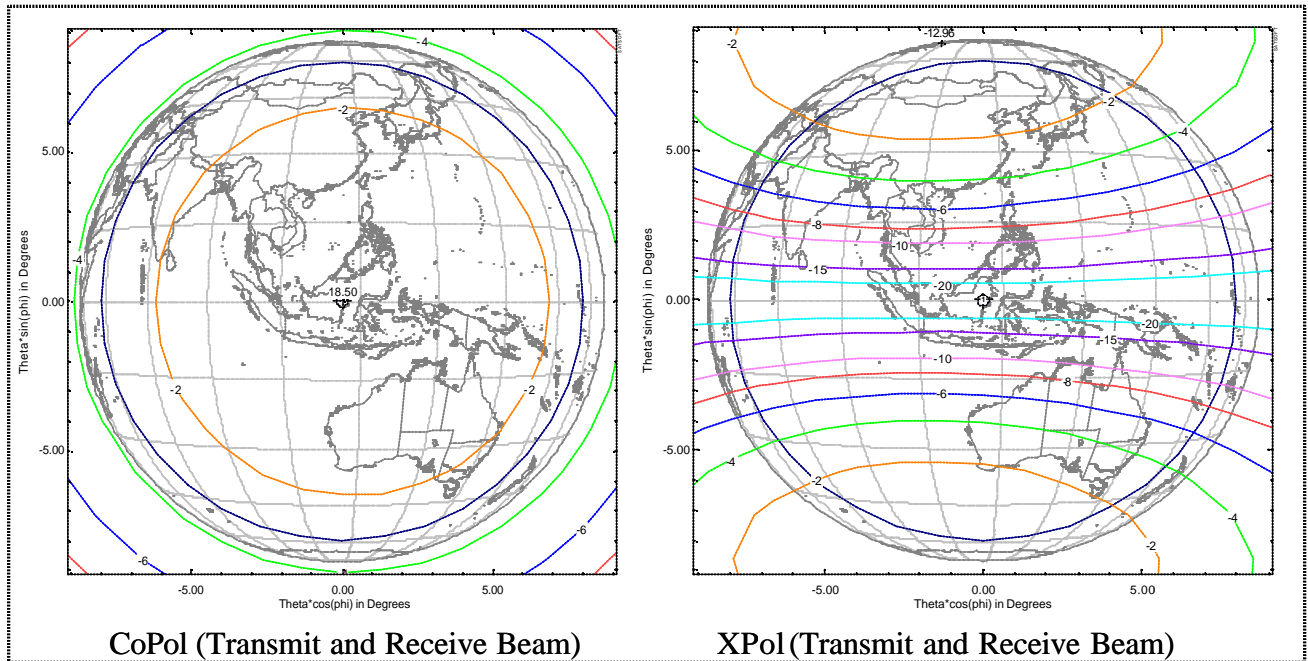

Figure C8: Transmit and Receive Ka-band Beacon Beam (from Satellite @ 116.5 E) (CoPol & Xpol)

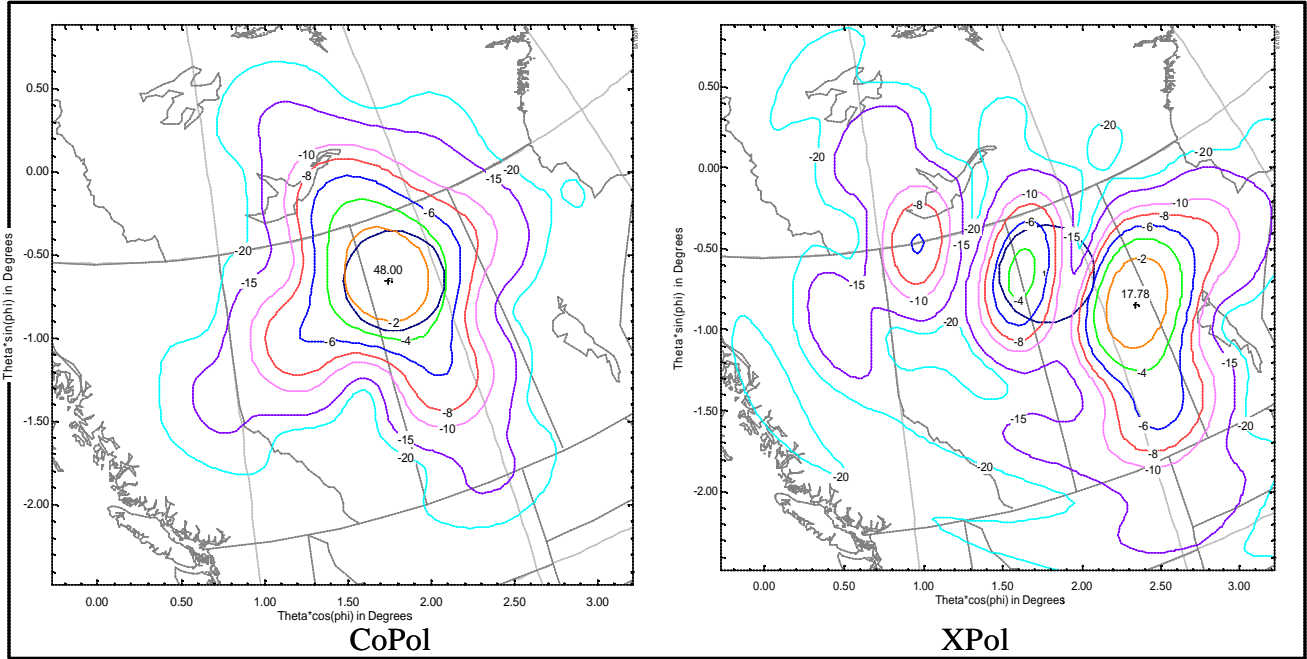

Figure C9: HEO (@129.6W, 63.4 N & 39254 km) Ka-band Transmit Antenna Beam (CoPol & Xpol) (Contour levels: -2, -4, -6, -8, -10, -15, -20 dB)

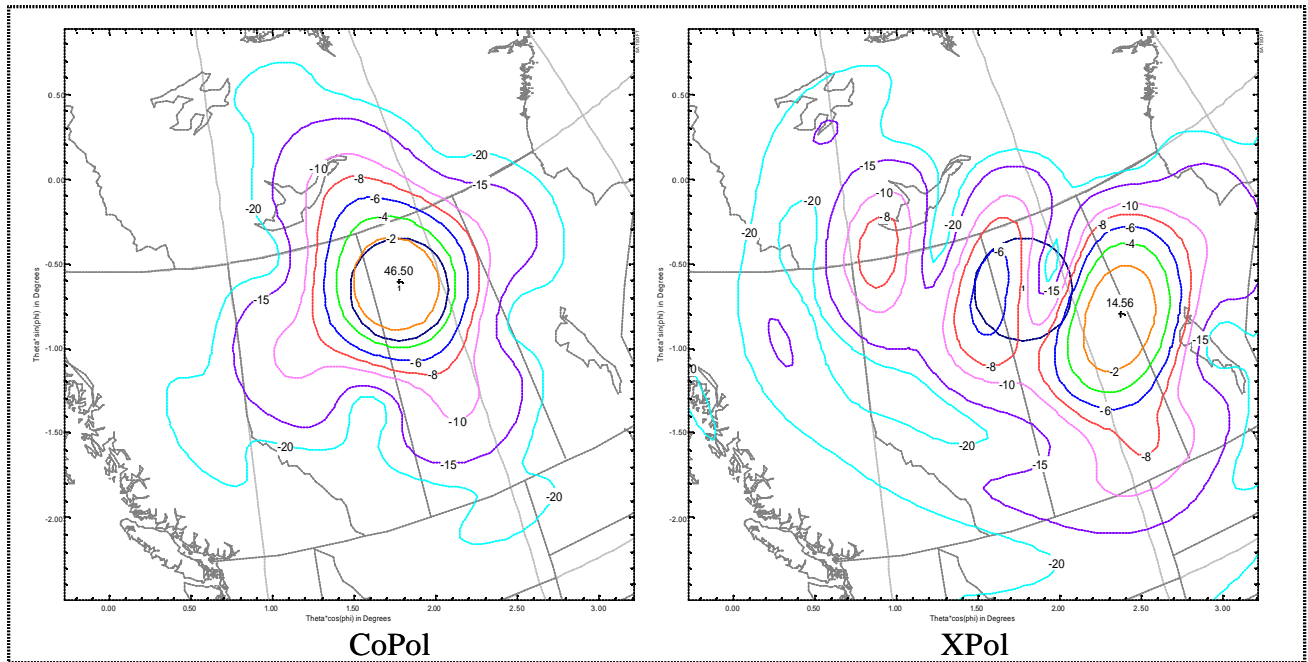

Figure C10: HEO (@129.6W, 63.4 N & 39254 km) Ka-band Receive Antenna Beam (CoPol & Xpol) (Contour levels: -2, -4, -6, -8, -10, -15, -20 dB)

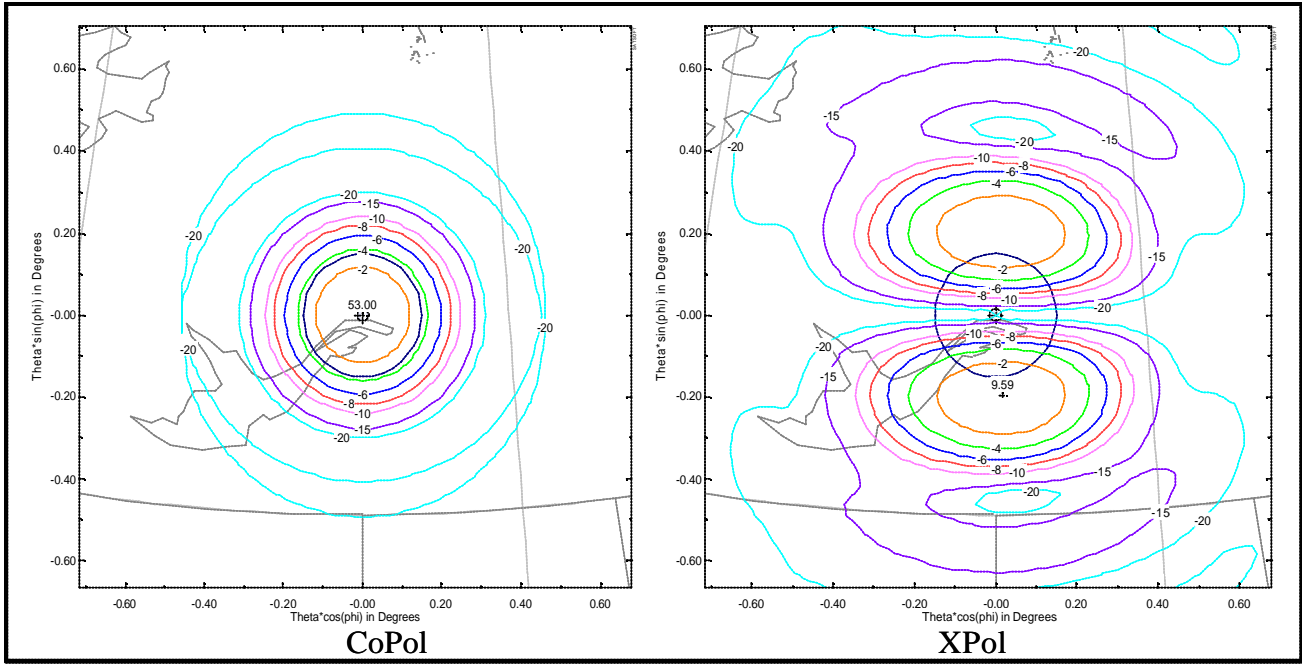

Figure C11: HEO (@129.6W, 63.4 N & 39254 km) V-band Receive Antenna Beam (CoPol & Xpol) (Contour levels: -2, -4, -6, -8, -10, -15, -20 dB)

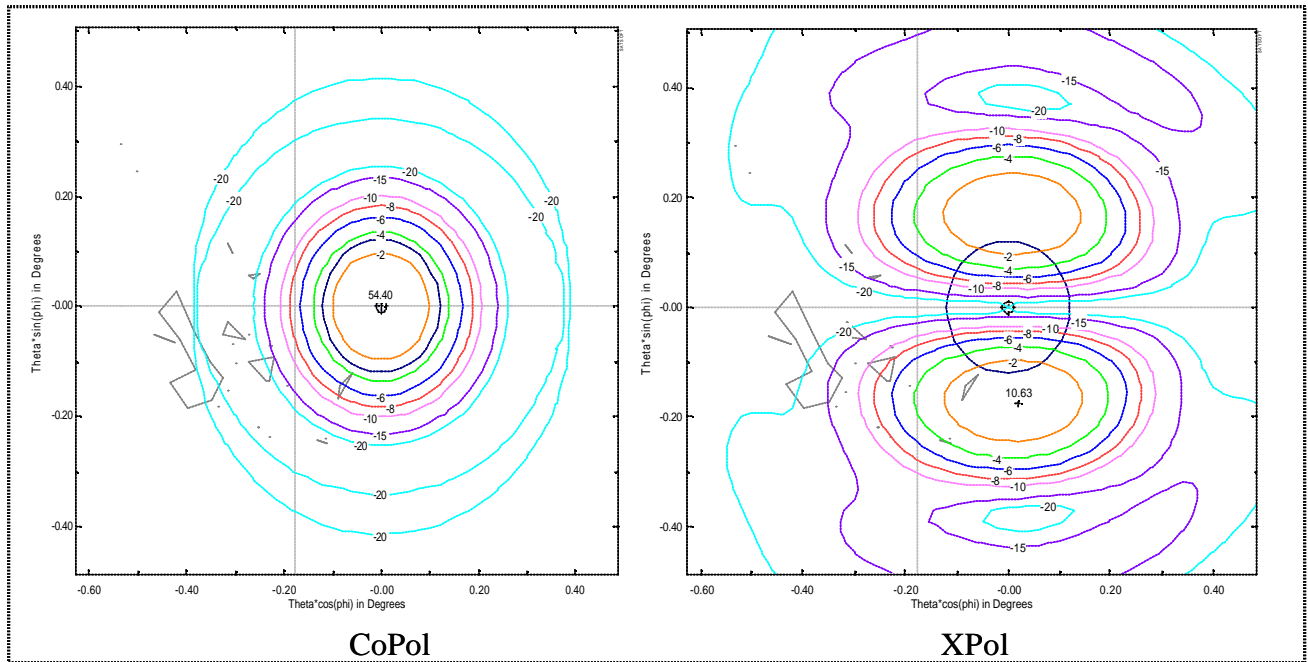

Figure C12: HEO (@129.6W, 63.4 N & 39254 km) V-band Receive Antenna Beam (CoPol & Xpol) (Contour levels: -2, -4, -6, -8, -10, -15, -20 dB)

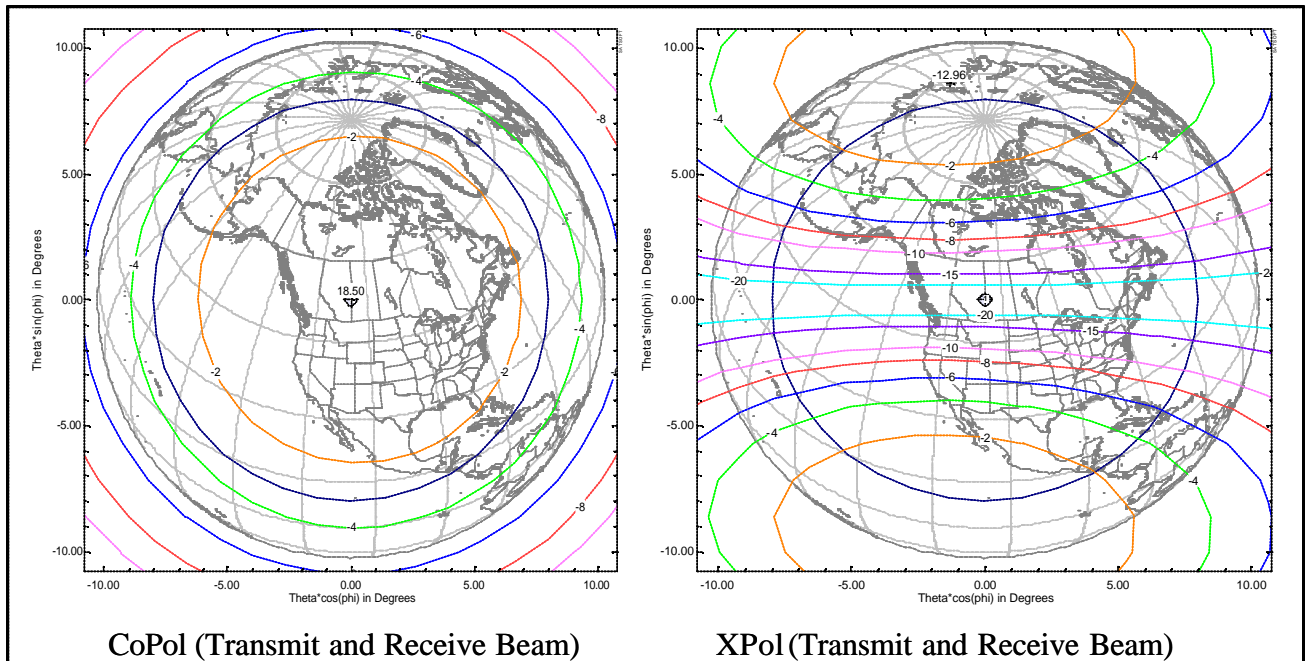

Figure C13: HEO (@129.6W, 63.4 N & 39254 km) Ka-band Transmit and Receive Beacon Beam (CoPol & Xpol)

ATTACHMENT D

GESN High Elliptical Orbit Satellite System In The 19.7-20.2 GHz and 29.5-30 GHz Bands Meets Both Downlink and Uplink epfd Limits In Table 22.

1 Introduction

This attachment presents simulation results related to both the uplink and downlink epfd levels of the GESN HEO satellites operating the 29.5-30 GHz and 19.7-20.2 GHz bands. The computer simulation was developed in accordance with the specification stipulated in a Rec. ITU-R S.1503.

2 System technical characteristics

- **GESN HEO Parameters:** The orbital characteristics of GESN HEO satellite system are given in Table C1. Tables 2 and 3 summarize the satellite and the Earth station transmit parameters, respectively.

TABLE 1

GESN HEO orbital parameters

Number of satellites	3
Number of orbital planes	3
Number of satellite per plane	1
Type of orbit	HEO (Highly-Elliptical Orbits) (Molniya type constellation)
Inclination angle	63.4 degrees
Period of orbit	43064 sec.
Apogee	39352 km
Perigee	1111 km
Minimum operational elevation angle	10 degrees
Minimum operational altitude	16000 km
Right Ascension of Ascending Node	0, 120, 240 degrees
Initial phase Angle (Mean Anomaly)	0, 120, 240 degrees

TABLE 2

Satellite and Earth Station Transmit Parameters

Parameters	Satellite Transmit Parameters	Earth Station Transmit Parameters
Frequency	19.7-20.2 GHz	29.5-30 GHz
Transmit power into the antenna	15 dBW	5 dBW (1.2 m); -2 dBW (0.7 m)
Antenna peak gain	48 dBi	49.6 dBi (1.2 m); 44.9 dBi (0.7m)
Antenna radiation patterns	Rec. ITU-R S.672-4	Rec. ITU-R S.1428-1
Transmit bandwidth	250 MHz	3.5 MHz (1.2 m); 0.7 m (0.7 m)

- **GSO Parameters:** The earth terminal 70 cm, 90 cm, 2.5 m and 5 m antennas are assumed to meet Rec. ITU-R S. 1428

3 Simulation results

In the simulation, the parameters were used:

GSO satellite location: 100⁰ West longitude

- GSO Earth station location: 100⁰ West longitude and 40⁰ North Latitude
- GSO and GESN HEO earth station are assumed to be co-located
- **Downlink epfd:** The downlink epfd levels into the GSO earth station 70cm, 90 cm, 2.5 m and 5 m are shown in Figure 1
- **Maximum uplink eirp:** In this calculation, five NGSO users operating in the same frequency channel within the GSO 1.55 degrees beam was assumed. The maximum uplink epfd levels are:
 - 0.7 m: -176.2 dB (W/m²/40 kHz)
 - 1.2 m: -185.73 dB (W/m²/40 kHz)

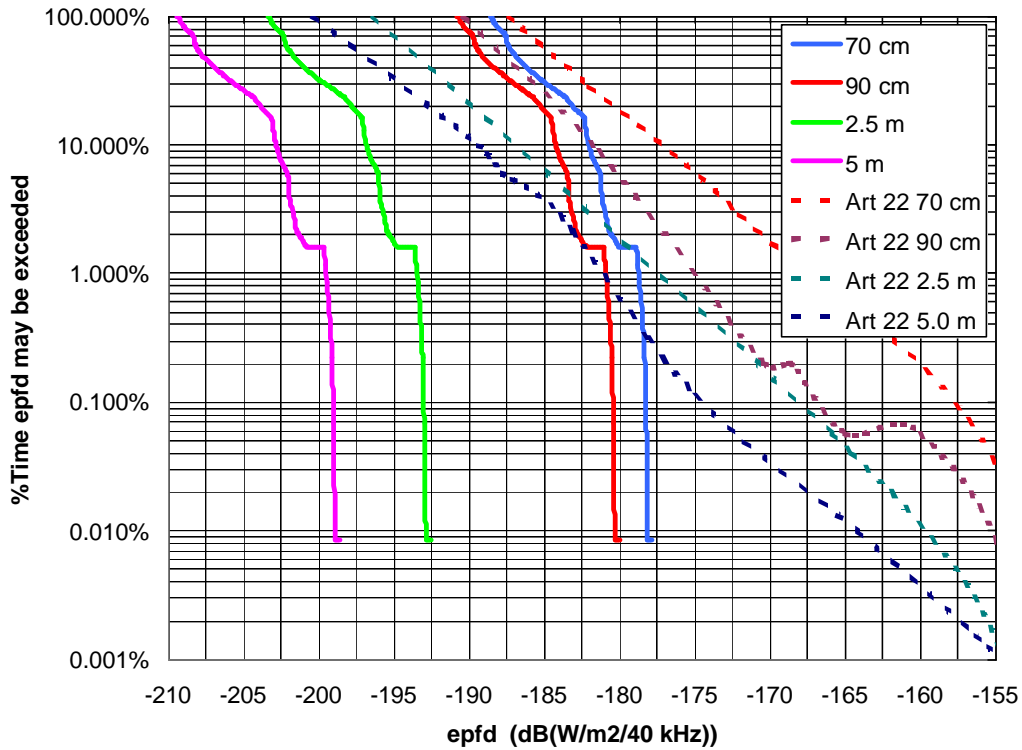

Figure 1: Downlink epfd Levels into GSO Earth Terminal Antennas

4 Conclusion

The simulation results shown in Section 3 indicate that the GESN HEO satellite system operating in the 19.7-20.2 GHz and 29.5-30 GHz bands meets the downlink and uplink epfd limits in Tables 22-1C (Limits to the downlink epfd), 22-4B (operational limits to the downlink epfd) and 22-2 (Limits to the uplink epfd).

=====

ATTACHMENT E: SUMMARY OF GESN FEATURES/PARAMETERS

- **GESN Non-GSO Component**
 - **Orbit:** Highly-Elliptical (HEO) and Geosynchronous Circular (GC)
 - **Number of satellites:** 3 HEO and 4 GC
 - **Frequency bands:**
 - Ka-band HEO:
 - Uplink: 28.6-29.1 GHz, 29.5-30 GHz
 - Downlink: 18.8-19.3 GHz, 19.7 – 20.2 GHz
 - Ka-band GC:
 - Uplink: 28.6-29.1 GHz
 - Downlink: 18.8-19.3 GHz
 - V-band (HEO and GC)
 - Uplink: 47.2-50.2 GHz
 - Downlink: 37.5-42 GHz (3 GHz spectrum of this band)
 - Earth terminal antenna size
 - Ka-band: 1.2 m and 0.7 m
 - V-band: 2.7 m and 1.5 m
 - Data rate
 - Ka-band
 - Uplink: 0.5 Mbps to 10.1 Mbps
 - Downlink: 74 Mbps to 374 Mbps
 - V-band
 - Uplink: 25 Mbps to 700 Mbps
 - Downlink: 75 Mbps to 750 Mbps
 - **Number of beams:** 48 (24 Ka-band + 24 V-band) Transmit and 60 (30 Ka + 30 V-band) Receive beams
- **GESN GSO Component**
 - **Locations:** 119°W, 89°W, 15°E and 116.5°E
 - **Number of satellites:** 4
 - **Frequency bands:**
 - Ka-band
 - Uplink: 28.35-28.6 GHz (all except 15°E)
 - Uplink: 29.25-29.5 GHz (all except 15°E)
 - Uplink: 29.5-30 GHz (119°W and 116.5°E only)
 - Downlink: 18.3-18.8 (all except 15°E)
 - Downlink: 19.7-20.2 GHz (119°W and 116.5°E only)
 - V-band
 - Uplink: 47.2-50.2 GHz
 - Downlink: 37.5-42 GHz (all except 15°E)
 - 15E: only 3 GHz spectrum of this band
 - Earth terminal antenna size
 - Ka-band: 1.2 m and 0.7 m
 - V-band: 2.7 m and 1.5 m
 - Data rate

- Ka-band
 - Uplink: 0.5 Mbps to 10.1 Mbps
 - Downlink: 74 Mbps to 374 Mbps
- V-band
 - Uplink: 25 Mbps to 700 Mbps
 - Downlink: 75 Mbps to 750 Mbps
- **Number of beams:** 48 (24 Ka + 24 V-band) Transmit and 60 (30 Ka + 30 V-band) Receive beams

- **Capacity:** ~24 Gbps per satellite/ ~165 Gbps/ system

- **Bus DC power:** 10.7 kW

TECHNICAL CERTIFICATE

I hereby certify, under penalty of perjury, that I am the technically qualified person responsible for the preparation of the engineering information contained in the technical portions of the foregoing amendment and the related attachments, that I am familiar with Part 25 of the Commission's Rules, and that the technical information is complete and accurate to the best of my knowledge and belief.

Hau H. Ho

Hau H. Ho
Senior Communications Systems Engineer
Northrop Grumman Space &
Mission Systems Corporation

Dated: March 11, 2004