

June 15, 2016

VIA IBFS

Ms. Marlene Dortch
Secretary
Federal Communications Commission
445 12th Street, SW
Washington, DC 20554

**Re: Supplement to Tampnet Inc. Application for International Section 214
Authorization; File No. ITC-214-20150901-00218**

Dear Ms. Dortch:

Tampnet Inc. (“Tampnet”), through counsel, submits the following supplement to the application for international Section 214 authority pending in the above-referenced proceeding. Specifically, this filing includes revised supplemental Attachment 2, and Exhibit 2(a).

Please refer to these supplemental pages as necessary. Thank you for your assistance with this matter. Please contact me for any additional questions that may arise.

Sincerely,

/s/ K.C. Halm

K.C. Halm
Richard Gibbs
Davis Wright Tremain LLP
1919 Pennsylvania Ave., NW, Suite 800
Washington, DC 20006
(202) 973-4200
kchalm@dwt.com

Counsel to Tampnet Inc.

cc: David Krech, International Bureau

**Attachments to
Tampnet Inc. Application for International Section 214 Authorization**

Attachment 2

Item 14 – Identity of Persons or Entities Owning at Least Ten Percent Direct or Indirect Equity (or Voting) in the Applicant.

Tampnet Inc. is owned by a 50-50 joint venture of Brent Infrastructure I S.a.r.l. and Brent Infrastructure II S.A., both organized under the laws of Luxembourg. Each of these companies, is in turn, owned and controlled by foreign private equity holders through two funds, EQT Infrastructure and EQT Infrastructure II, which were established by the European private equity firm EQT. Numerous entities and certain individuals hold voting and equity interests in the applicant through these two funds. Those shareholders with a ten percent or greater equity or voting interest (direct or indirect) in the applicant are identified herein.

1.	Name	Tampnet AS
	Address	Hinna Park, Stadionblokk C Jattavagavein 7 N-4020 Stavanger Norway
	Principal Business	Communications service provider
	Citizenship	Norway
	Percentage of Equity (and Voting ¹) of Tampnet Inc.	100% (100%)

2.	Name	Brent Invest AS
	Address	Hinna Park, Stadionblokk C Jattavagavein 7 N-4020 Stavanger Norway
	Principal Business	Investment / Holding Co.
	Citizenship	Norway
	Percentage of Equity (and Voting) of Tampnet Inc.	100% (100%)

3.	Name	Brent Holding AS
	Address	Hinna Park, Stadionblokk C Jattavagavein 7 N-4020 Stavanger Norway
	Principal Business	Investment / Holding Co.
	Citizenship	Norway
	Percentage of Equity (and Voting) of Tampnet Inc.	100% (100%)

¹ Voting interests, shown in parentheses, are provided per request from Staff. Directors of certain companies identified here do not own any equity or voting interests. Voting interests deemed to be held by such persons are disclosed on Exhibit C-2 of the pending Petition for Declaratory Ruling in docket ISP-PDR-20150507-0003.

**Attachments to
Tampnet Inc. Application for International Section 214 Authorization**

4.	Name	Brent Infrastructure I B.V.
	Address	World Trade Center Schiphol H-Tower, 4th Floor Schiphol Boulevard 355 1118 BJ Schiphol The Netherlands
	Principal Business	Investment / Holding Co.
	Citizenship	Netherlands
	Percentage of Equity (and Voting) (and Voting) of Tampnet Inc.	94.92% (100%)

5.	Name	Brent Infrastructure I S.à.r.l.
	Address	23, Rue Aldringen L-1118 Luxembourg Grand Duchy of Luxembourg
	Principal Business	Investment / Holding Co.
	Citizenship	Luxembourg
	Percentage of Equity (and Voting) of Tampnet Inc.	47.46% (100%)

6.	Name	Brent Holding Guernsey Limited
	Address	National Westminster House Le Truchot St. Peter Port Guernsey GY1 3RA
	Principal Business	Investment / Holding Co.
	Citizenship	Guernsey
	Percentage of Equity (and Voting) of Tampnet Inc.	47.46% (100%)

7.	Name	EQT Infrastructure (No. 1) Limited Partnership
	Address	Registered Address Level 4 North St Julian's Court St Julian's Avenue St Peter Port Guernsey GY1 1WA
	Principal Business	Investment / Holding Co.
	Citizenship	England & Wales
	Percentage of Equity (and Voting) of Tampnet Inc.	39.79% (84.99%)

**Attachments to
Tampnet Inc. Application for International Section 214 Authorization**

8.	Name	Brent Infrastructure II SA
	Address	23, Rue Aldringen L-1118 Luxembourg Grand Duchy of Luxembourg
	Principal Business	Investment / Holding Co.
	Citizenship	Luxembourg
	Percentage of Equity (and Voting) of Tampnet Inc.	47.46% (100%)

9.	Name	Brent Infrastructure Holding B.V.
	Address	World Trade Center Schiphol H-Tower, 4th Floor Schiphol Boulevard 355 1118 BJ Schiphol The Netherlands
	Principal Business	Investment / Holding Co.
	Citizenship	The Netherlands
	Percentage of Equity (and Voting) of Tampnet Inc.	47.46% (100%)

10.	Name	Brent Infrastructure II Holding S.à.r.l.
	Address	23, Rue Aldringen L-1118 Luxembourg Grand Duchy of Luxembourg
	Principal Business	Investment / Holding Co.
	Citizenship	Luxembourg
	Percentage of Equity (and Voting) of Tampnet Inc.	47.46% (100%)

11.	Name	EQT Infrastructure II Limited Partnership
	Address	World Trade Center Schiphol H-Tower, 4th Floor Schiphol Boulevard 355 1118 BJ Schiphol The Netherlands
	Principal Business	Investment / Holding Co.
	Citizenship	The Netherlands
	Percentage of Equity (and Voting) of Tampnet Inc.	46.92% (100%)

12.	Name	EQT Infrastructure II (No. 1) Feeder LP
	Address	Registered Office 50 Lothian Road Festival Square

**Attachments to
Tampnet Inc. Application for International Section 214 Authorization**

		Edinburgh EH3 9WJ
	Principal Business	Investment / Holding Co.
	Citizenship	U.K.
	Percentage of Equity (and Voting) of Tampnet Inc.	32.93% (70.18%)

13.	Name	EQT Infrastructure II (No. 2) Feeder LP
	Address	Registered Office 50 Lothian Road Festival Square Edinburgh EH3 9WJ
	Principal Business	Investment / Holding Co.
	Citizenship	U.K.
	Percentage of Equity (and Voting) of Tampnet Inc.	10.02% (21.36%)

14.	Name	EQT Infrastructure (No. 3) Limited Partnership
	Address	Level 4 (North), St Julian's Court, St Julian's Avenue GY1 1WA St Peter Port Guernsey Channel Islands
	Principal Business	Investment
	Citizenship	England
	Percentage of Equity (and Voting) of Tampnet Inc.	4.68% (10%)

15.	Name	EQT Infrastructure (General Partner) LP
	Address	Level 4 (North), St Julian's Court, St Julian's Avenue GY1 1WA St Peter Port Guernsey Channel Islands
	Principal Business	Investment
	Citizenship	Guernsey
	Percentage of Equity (and Voting) of Tampnet Inc.	0.47% (100%)

**Attachments to
Tampnet Inc. Application for International Section 214 Authorization**

16.	Name	EQT Infrastructure LLP
	Address	Level 4 (North), St Julian's Court, St Julian's Avenue GY1 1WA St Peter Port Guernsey Channel Islands
	Principal Business	Investment
	Citizenship	Guernsey
	Percentage of Equity (and Voting) of Tampnet Inc.	0% (100%)

17.	Name	EQT V GmbH & Co. KG
	Address	Färbergraben 18 80331 Munich Germany
	Principal Business	Investment
	Citizenship	Germany
	Percentage of Equity (and Voting) of Tampnet Inc.	0% (100%)

18.	Name	EQT V Verwaltung GmbH
	Address	Färbergraben 18 80331 Munich Germany
	Principal Business	Investment
	Citizenship	Germany
	Percentage of Equity (and Voting) of Tampnet Inc.	0% (100%)

19.	Name	CBTJ Financial Services B.V.
	Address	World Trade Center Schiphol H-Tower, 4th Floor Schiphol Boulevard 355 1118 BJ Schiphol The Netherlands
	Principal Business	Investment
	Citizenship	Netherlands
	Percentage of Equity (and Voting) of Tampnet Inc.	0% (100%)

20.	Name	EQT Infrastructure Limited
	Address	Level 4 (North), St Julian's Court, St Julian's Avenue GY1 1WA

**Attachments to
Tampnet Inc. Application for International Section 214 Authorization**

		St Peter Port Guernsey Channel Islands
	Principal Business	Investment
	Citizenship	Guernsey
	Percentage of Equity (and Voting) of Tampnet Inc.	0.3% (100%)

21.	Name	EQT Funds Management Limited
	Address	Level 4 (North), St Julian's Court, St Julian's Avenue GY1 1WA St Peter Port Guernsey Channel Islands
	Principal Business	Investment
	Citizenship	Guernsey
	Percentage of Equity (and Voting) of Tampnet Inc.	0% (100%)

22.	Name	SEP Holdings B.V.
	Address	World Trade Center Schiphol H-Tower, 4th Floor Schiphol Boulevard 355 1118 BJ Schiphol The Netherlands
	Principal Business	Investment
	Citizenship	Netherlands
	Percentage of Equity (and Voting) of Tampnet Inc.	0% (100%)

23.	Name	SEP Integrated I B.V.
	Address	World Trade Center Schiphol H-Tower, 4th Floor Schiphol Boulevard 355 1118 BJ Schiphol The Netherlands
	Principal Business	Investment
	Citizenship	Netherlands
	Percentage of Equity (and Voting) of Tampnet Inc.	0% (46.47%)

24.	Name	SEP Integrated II B.V.
	Address	World Trade Center Schiphol H-Tower, 4th Floor Schiphol Boulevard 355

**Attachments to
Tampnet Inc. Application for International Section 214 Authorization**

		1118 BJ Schiphol The Netherlands
	Principal Business	Investment
	Citizenship	Netherlands
	Percentage of Equity (and Voting) of Tampnet Inc.	0% (100%)

25.	Name	SEPCO B.V.
	Address	World Trade Center Schiphol H-Tower, 4th Floor Schiphol Boulevard 355 1118 BJ Schiphol The Netherlands
	Principal Business	Investment
	Citizenship	Netherlands
	Percentage of Equity (and Voting) of Tampnet Inc.	0% (17.58%)

26.	Name	Glen Matsumoto
	Address	World Trade Center Schiphol H-Tower, 4th Floor Schiphol Boulevard 355 1118 BJ Schiphol The Netherlands
	Principal Business	N/A
	Citizenship	U.S.
	Percentage of Equity (and Voting) of Tampnet Inc.	0% (16.59%)

27.	Name	Steep Bay B.V.
	Address	World Trade Center Schiphol H-Tower, 4th Floor Schiphol Boulevard 355 1118 BJ Schiphol The Netherlands
	Principal Business	Investment
	Citizenship	Netherlands
	Percentage of Equity (and Voting) of Tampnet Inc.	0% (18.18%)

28.	Name	Geltis Holding B.V.
	Address	World Trade Center Schiphol H-Tower, 4th Floor Schiphol Boulevard 355 1118 BJ Schiphol The Netherlands
	Principal Business	Investment
	Citizenship	Netherlands

**Attachments to
Tampnet Inc. Application for International Section 214 Authorization**

	Percentage of Equity (and Voting) of Tampnet Inc.	0% (11.18%)
--	---	-------------

29.	Name	Stefan Glevén
	Address	225 West 86th Street, Apt. 1009 New York, New York 10024 United States
	Principal Business	N/A
	Citizenship	Sweden
	Percentage of Equity (and Voting) of Tampnet Inc.	0% (16.26%)

30.	Name	Conni Jonsson
	Address	Brahegatan 39, apartment 1501 Stockholm, 114 37 Sweden
	Principal Business	N/A
	Citizenship	Sweden
	Percentage of Equity (and Voting) of Tampnet Inc.	0% (27.55%)

31.	Name	Qarlbo Associates
	Address	PO Box 621 2016 Luxembourg Luxembourg
	Principal Business	Investment
	Citizenship	Luxembourg
	Percentage of Equity (and Voting) of Tampnet Inc.	0% (22.55%)

32.	Name	Rakso Holding B.V.
	Address	World Trade Center Schiphol H-Tower, 4th Floor Schiphol Boulevard 355 1118 BJ Schiphol The Netherlands
	Principal Business	Investment
	Citizenship	Netherlands
	Percentage of Equity (and Voting) of Tampnet Inc.	0% (22.22%)

33.	Name	Christian Sinding
	Address	World Trade Center Schiphol H-Tower, 4th Floor Schiphol Boulevard 355 1118 BJ Schiphol The Netherlands
	Principal Business	N/A
	Citizenship	Norwegian

**Attachments to
Tampnet Inc. Application for International Section 214 Authorization**

	Percentage of Equity (and Voting) of Tampnet Inc.	0% (19.73%)
--	---	-------------

34.	Name	Caspar Callerstrom
	Address	World Trade Center Schiphol H-Tower, 4th Floor Schiphol Boulevard 355 1118 BJ Schiphol The Netherlands
	Principal Business	N/A
	Citizenship	Swedish
	Percentage of Equity (and Voting) of Tampnet Inc.	0% (16.73%)

35.	Name	Karl Heinz Horrer
	Address	23, rue Aldringen L-1118 Luxembourg
	Principal Business	N/A
	Citizenship	Germany
	Percentage of Equity (and Voting) of Tampnet Inc.	0% (100%)

36.	Name	EQT Infrastructure II GP B.V.
	Address	World Trade Center Schiphol H-Tower, 4th Floor Schiphol Boulevard 355 1118 BJ Schiphol The Netherlands
	Principal Business	Investment
	Citizenship	Netherlands
	Percentage of Equity (and Voting) of Tampnet Inc.	0% (100%)

37.	Name	EQT Holdings II B.V.
	Address	World Trade Center Schiphol H-Tower, 4th Floor Schiphol Boulevard 355 1118 BJ Schiphol The Netherlands
	Principal Business	Investment
	Citizenship	Netherlands
	Percentage of Equity (and Voting) of Tampnet Inc.	0% (100%)

38.	Name	EQT Infrastructure II (GP) Ltd.
	Address	50 Lothian Road Festival Square Edinburgh EH3 9WJ

**Attachments to
Tampnet Inc. Application for International Section 214 Authorization**

	Principal Business	Investment
	Citizenship	U.K.
	Percentage of Equity (and Voting) of Tampnet Inc.	0% (100%)

39.	Name	EQT Netherlands Management B.V.
	Address	World Trade Center Schiphol H-Tower, 4th Floor Schiphol Boulevard 355 1118 BJ Schiphol The Netherlands
	Principal Business	Investment
	Citizenship	Netherlands
	Percentage of Equity (and Voting) of Tampnet Inc.	0% (100%)

40.	Name	EQT AB
	Address	Hovslagargatan 3 SE-111 48 Stockholm Sweden
	Principal Business	Investment
	Citizenship	Sweden
	Percentage of Equity (and Voting) of Tampnet Inc.	0% (100%)

41.	Name	Investor Investments Holding AB
	Address	Arsenalsgatan 8C SE-103 32 Stockholm Sweden
	Principal Business	Investment
	Citizenship	Sweden
	Percentage of Equity (and Voting) of Tampnet Inc.	0% (100%)

42.	Name	EQT International Holdings B.V.
	Address	World Trade Center Schiphol H-Tower, 4th Floor Schiphol Boulevard 355 1118 BJ Schiphol The Netherlands
	Principal Business	Investment
	Citizenship	Netherlands
	Percentage of Equity (and Voting) of Tampnet Inc.	0% (100%)

**Attachments to
Tampnet Inc. Application for International Section 214 Authorization**

43.	Name	EQT Holdings Cooperatief W.A.
	Address	World Trade Center Schiphol H-Tower, 4th Floor Schiphol Boulevard 355 1118 BJ Schiphol The Netherlands
	Principal Business	Investment
	Citizenship	Netherlands
	Percentage of Equity (and Voting) of Tampnet Inc.	0% (100%)

44.	Name	Investor Growth Capital Holding B.V.
	Address	De Boelelaan 7 1083 HJ Amsterdam
	Principal Business	Investment
	Citizenship	Netherlands
	Percentage of Equity (and Voting) of Tampnet Inc.	0% (100%)

45.	Name	Investor AB
	Address	Arsenalsgatan 8C SE-103 32 Stockholm Sweden
	Principal Business	Investment
	Citizenship	Sweden
	Percentage of Equity (and Voting) of Tampnet Inc.	0% (100%)

46.	Name	Investor Netherlands B.V.
	Address	De Boelelaan 7 1083 HJ Amsterdam
	Principal Business	Investment
	Citizenship	Netherlands
	Percentage of Equity (and Voting) of Tampnet Inc.	0% (100%)

47.	Name	Knut and Alice Wallenberg Foundation
	Address	P.O. Box 16066 SE-103 22 Stockholm Sweden
	Principal Business	Research
	Citizenship	Sweden
	Percentage of Equity (and Voting) of Tampnet Inc.	0% (42.2%)

**Attachments to
Tampnet Inc. Application for International Section 214 Authorization**

48.	Name	Fredrik Åtting
	Address	EQT Partners GmbH, Leopoldstraße 8, D-80802 Munich Germany
	Principal Business	N/A
	Citizenship	Sweden
	Percentage of Equity (and Voting) of Tampnet Inc.	0% (10.29%)

49.	Name	Harry Klagsbrun
	Address	EQT Partners AB, P.O. Box 16409 S-103 27 Stockholm Sweden
	Principal Business	N/A
	Citizenship	Sweden
	Percentage of Equity (and Voting) of Tampnet Inc.	0% (12.39%)

50.	Name	Michael Föcking
	Address	World Trade Center Schiphol H-Tower, 4th Floor Schiphol Boulevard 355 1118 BJ Schiphol The Netherlands
	Principal Business	N/A
	Citizenship	Germany
	Percentage of Equity (and Voting) of Tampnet Inc.	0% (11.49%)

51.	Name	Paul de Rome
	Address	World Trade Center Schiphol H-Tower, 4th Floor Schiphol Boulevard 355 1118 BJ Schiphol The Netherlands
	Principal Business	N/A
	Citizenship	U.K.
	Percentage of Equity (and Voting) of Tampnet Inc.	0% (10.09%)

52.	Name	Patrick de Muynck
	Address	EQT Partners AB, P.O. Box 16409 S-103 27 Stockholm Sweden
	Principal Business	N/A
	Citizenship	Belgium

**Attachments to
Tampnet Inc. Application for International Section 214 Authorization**

	Percentage of Equity (and Voting) of Tampnet Inc.	0% (14.15%)
--	---	-------------

53.	Name	Jan Ståhlberg
	Address	EQT Partners Inc., Grace Building 1114 Avenue of the Americas, 45th Floor New York, NY 10036
	Principal Business	N/A
	Citizenship	Sweden
	Percentage of Equity (and Voting) of Tampnet Inc.	0% (16.19%)

54.	Name	Thomas von Koch
	Address	EQT Partners AB, P.O. Box 16409 S-103 27 Stockholm Sweden
	Principal Business	N/A
	Citizenship	Sweden
	Percentage of Equity (and Voting) of Tampnet Inc.	0% (16.1%)

55.	Name	Marcus Brennecke
	Address	World Trade Center Schiphol H-Tower, 4th Floor Schiphol Boulevard 355 1118 BJ Schiphol The Netherlands
	Principal Business	N/A
	Citizenship	Germany
	Percentage of Equity (and Voting) of Tampnet Inc.	0% (17.74%)

56.	Name	TomCo 2 B.V.
	Address	World Trade Center Schiphol H-Tower, 4th Floor Schiphol Boulevard 355 1118 BJ Schiphol The Netherlands
	Principal Business	
	Citizenship	Netherlands
	Percentage of Equity (and Voting) of Tampnet Inc.	0% (11.1%)

57.	Name	Martin Mok
	Address	EQT Partners Asia Ltd 1708 Hutchison House 10 Harcourt Road, Central

**Attachments to
Tampnet Inc. Application for International Section 214 Authorization**

		Hong Kong
	Principal Business	N/A
	Citizenship	Hong Kong S.A.R.
	Percentage of Equity (and Voting) of Tampnet Inc.	0% (16.37%)

58.	Name	EHKM Holdings Coöperatief U.A.
	Address	World Trade Center Schiphol H-Tower, 4th Floor Schiphol Boulevard 355 1118 BJ Schiphol The Netherlands
	Principal Business	Investment
	Citizenship	Netherlands
	Percentage of Equity (and Voting) of Tampnet Inc.	0% (10%)

59.	Name	Lennart Blecher
	Address	EQT Partners AB, P.O. Box 16409 S-103 27 Stockholm Sweden
	Principal Business	N/A
	Citizenship	Sweden
	Percentage of Equity (and Voting) of Tampnet Inc.	0% (18.32%)

60.	Name	Fengyu B.V.
	Address	World Trade Center Schiphol H-Tower, 4th Floor Schiphol Boulevard 355 1118 BJ Schiphol The Netherlands
	Principal Business	Investment
	Citizenship	Netherlands
	Percentage of Equity (and Voting) of Tampnet Inc.	0% (10.19%)

61.	Name	Tak Wai Chung
	Address	#04-01 Shelford View 26 Shelford Road Singapore, 288420 Singapore
	Principal Business	N/A
	Citizenship	British National (Overseas)
	Percentage of Equity (and Voting) of Tampnet Inc.	0% (10.66%)

**Attachments to
Tampnet Inc. Application for International Section 214 Authorization**

62.	Name	Anders Misund
	Address	Dronning Mauds Gate 1 0250 Oslo Norway
	Principal Business	N/A
	Citizenship	Norway
	Percentage of Equity (and Voting) of Tampnet Inc.	0% (10%)

63.	Name	Per Franzén
	Address	Hovslagargatan 3 P.O. Box 16409, 103 27 Stockholm Sweden
	Principal Business	N/A
	Citizenship	Sweden
	Percentage of Equity (and Voting) of Tampnet Inc.	0% (10.24%)

64.	Name	CM Capital B.V.
	Address	World Trade Center Schiphol H-Tower, 4th Floor Schiphol Boulevard 355 1118 BJ Schiphol The Netherlands
	Principal Business	Investment
	Citizenship	Netherlands
	Percentage of Equity (and Voting) of Tampnet Inc.	0% (100%)

65.	Name	Stichting Bawau
	Address	World Trade Center Schiphol H-Tower, 4th Floor Schiphol Boulevard 355 1118 BJ Schiphol The Netherlands
	Principal Business	Trust
	Citizenship	Netherlands
	Percentage of Equity (and Voting) of Tampnet Inc.	0% (100%)

66.	Name	IGPE LP
	Address	P.O. Box 656 East Wing Trafalgar Court Les Banques St. Peter Port Guernsey GY1 3PP

**Attachments to
Tampnet Inc. Application for International Section 214 Authorization**

	Principal Business	Investment
	Citizenship	UK
	Percentage of Equity (and Voting) of Tampnet Inc.	0.33% (70%)

67.	Name	EQT Holdings B.V. (LLC)
	Address	World Trade Center Schiphol H-Tower, 4th Floor Schiphol Boulevard 355 1118 BJ Schiphol The Netherlands
	Principal Business	Investment
	Citizenship	Netherlands
	Percentage of Equity (and Voting) of Tampnet Inc.	0% (100%)

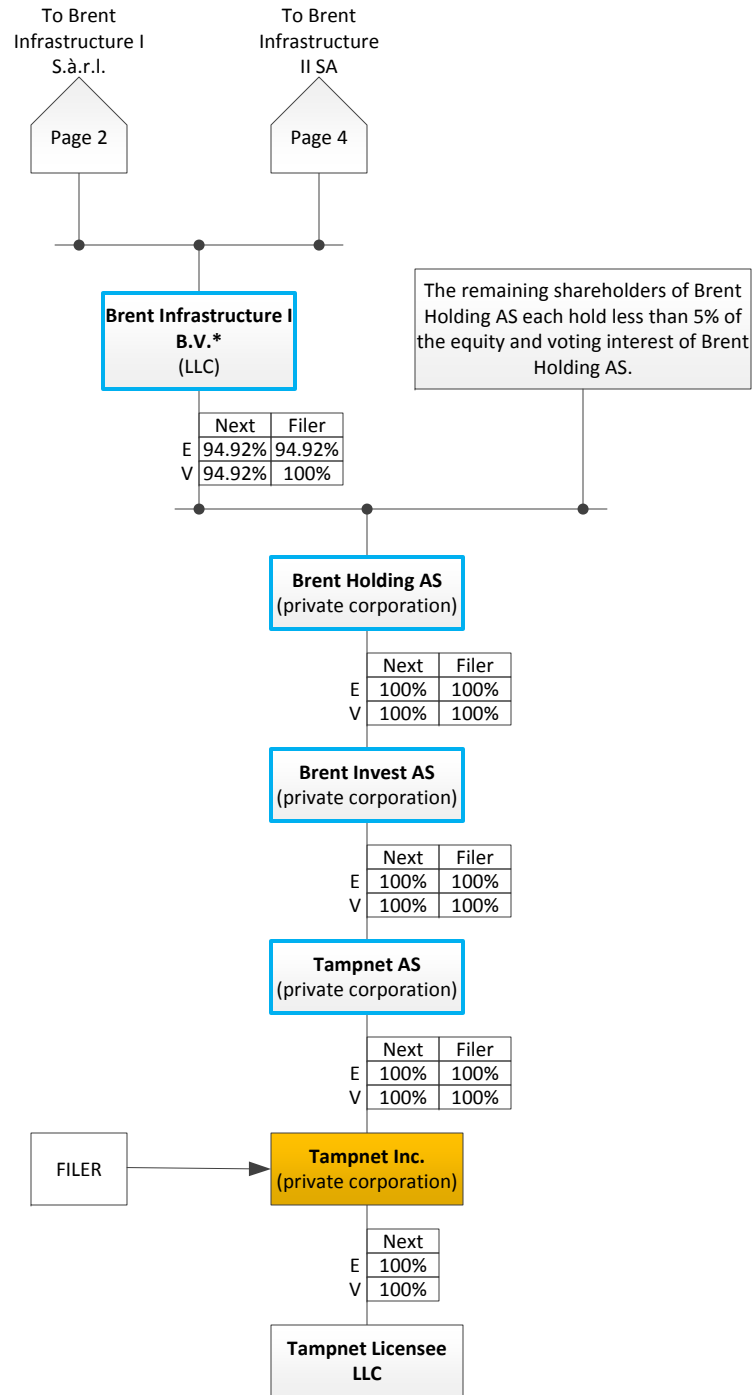

E= Equity Interest
 V=Voting Interest
 Next = Interest in next entity in structure
 Filer = Interest in Tampnet Inc.
 Note = Voting interests in the filer identified herein have been calculated in accordance with FCC rules (47 C.F.R. 1.992) and may not reflect the actual voting interest indirectly held in the filer.

Specific Approval Entity or Individual

*Non-member Directors		
Name	Citizenship	Business
Peter Veldman	Netherlands	Individual
James Arrol	UK	Individual
Martijn Sibren van der Schaaf	Netherlands	Individual

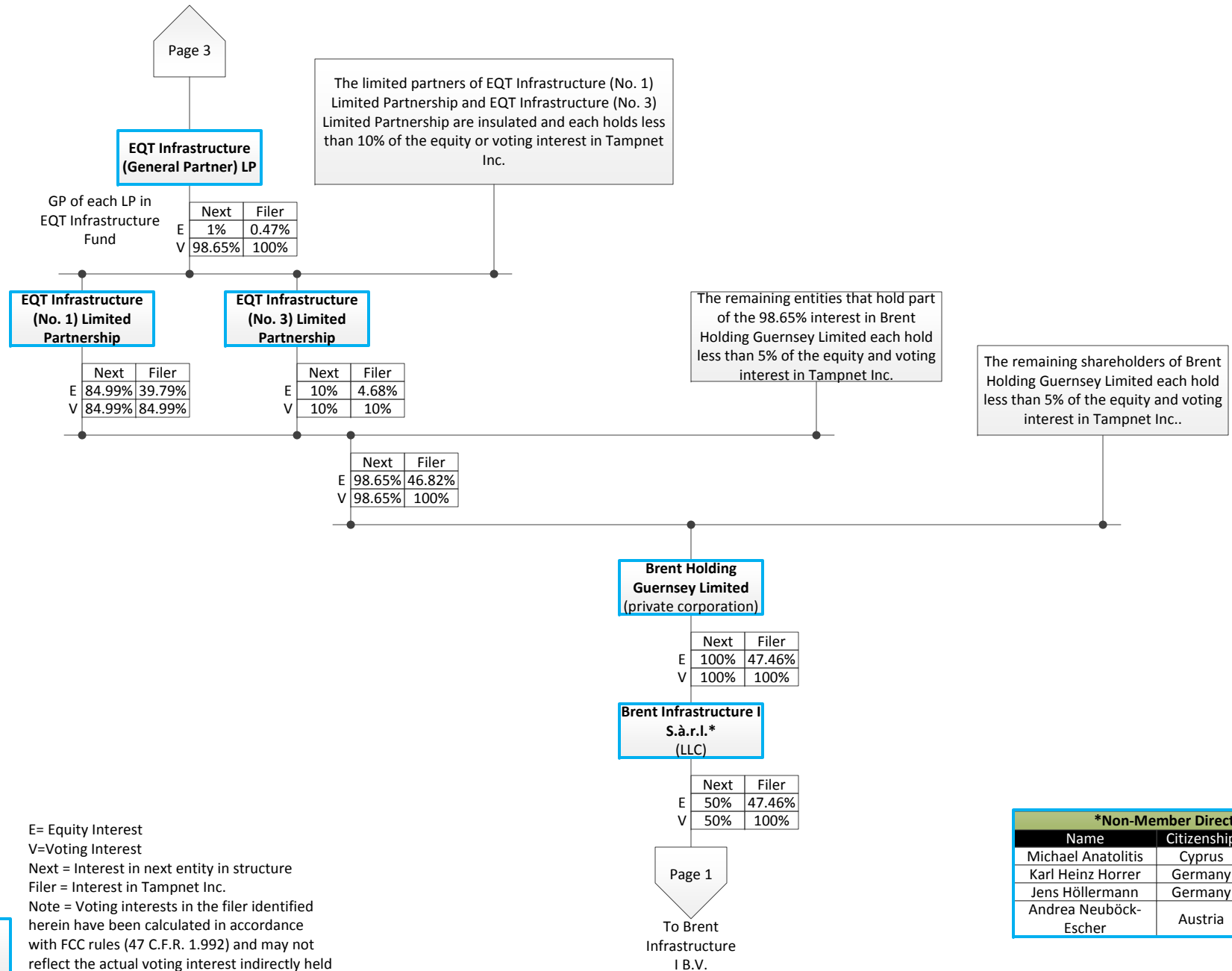

Specific Approval Entity or Individual

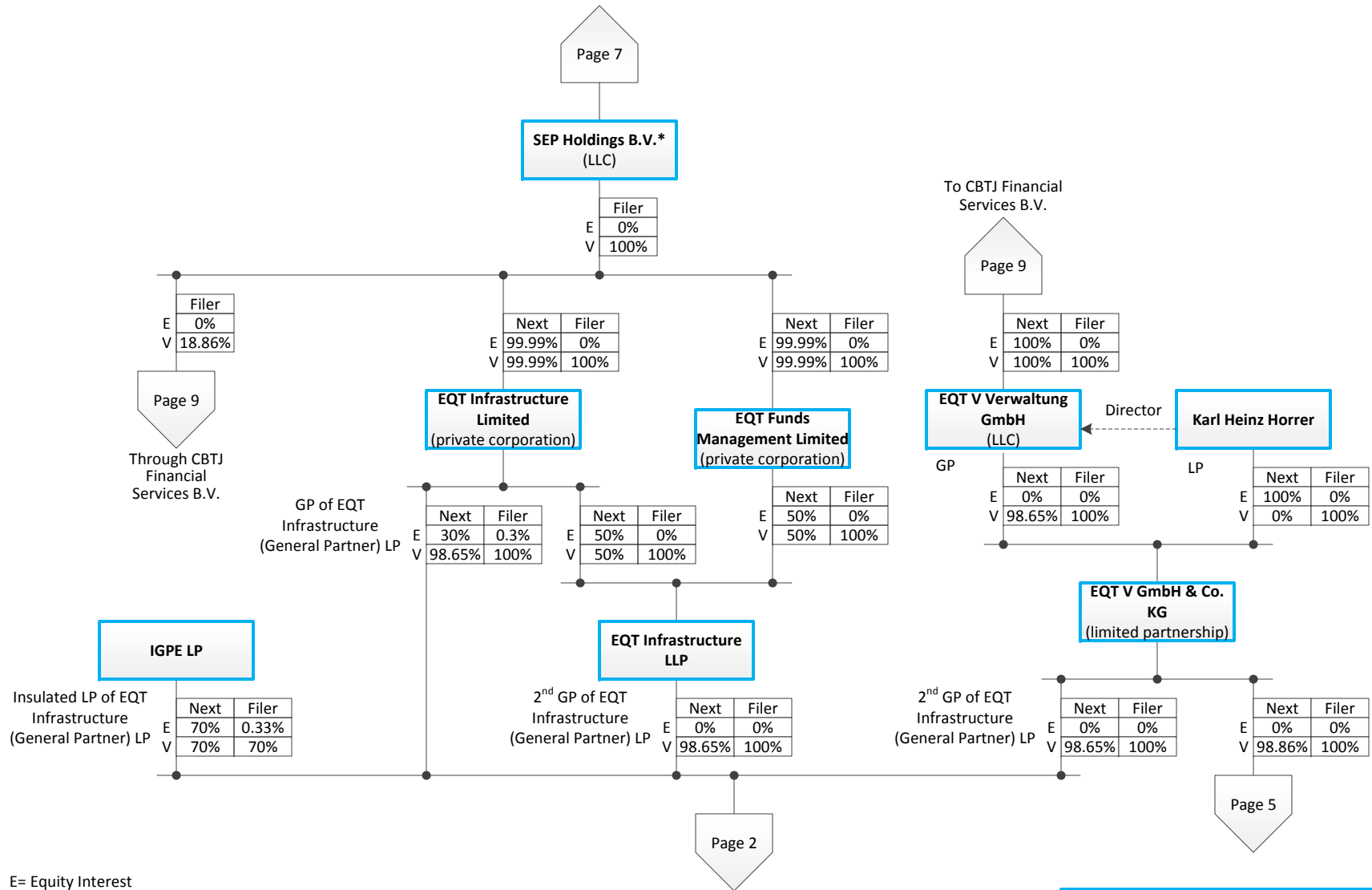

E= Equity Interest
 V=Voting Interest
 Next = Interest in next entity in structure
 Filer = Interest in Tampnet Inc.
 Note = Voting interests in the filer identified herein have been calculated in accordance with FCC rules (47 C.F.R. 1.992) and may not reflect the actual voting interest indirectly held in the filer.

Specific Approval Entity or Individual

*Non-member Directors		
Name	Citizenship	Business
Victor de Roo	Netherlands	Individual
Martijn Sibren van der Schaaf	Netherlands	Individual
Nathalie Ouwkerk	Netherlands	Individual

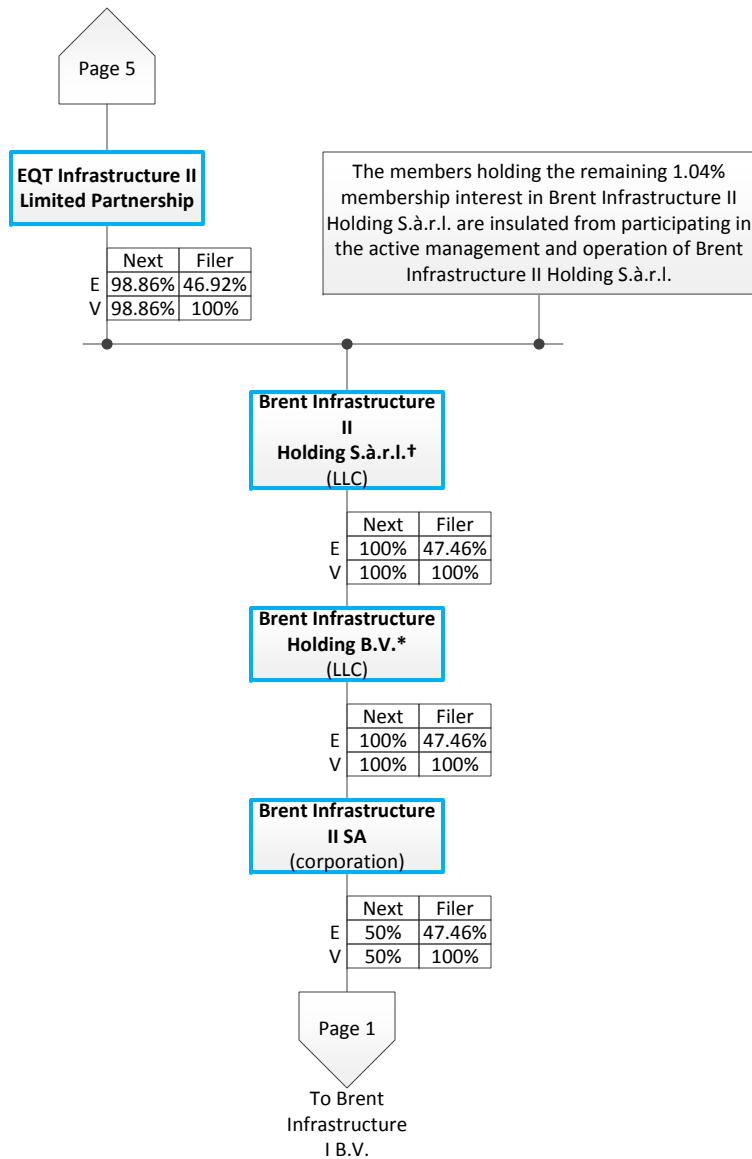

Page 5

EQT Infrastructure II Limited Partnership

The members holding the remaining 1.04% membership interest in Brent Infrastructure II Holding S.à.r.l.† are insulated from participating in the active management and operation of Brent Infrastructure II Holding S.à.r.l.†

	Next	Filer
E	98.86%	46.92%
V	98.86%	100%

Brent Infrastructure II Holding S.à.r.l.† (LLC)

	Next	Filer
E	100%	47.46%
V	100%	100%

Brent Infrastructure Holding B.V.* (LLC)

	Next	Filer
E	100%	47.46%
V	100%	100%

Brent Infrastructure II SA (corporation)

	Next	Filer
E	50%	47.46%
V	50%	100%

Page 1

To Brent Infrastructure I B.V.

E= Equity Interest
 V=Voting Interest
 Next = Interest in next entity in structure
 Filer = Interest in Tampnet Inc.
 Note = Voting interests in the filer identified herein have been calculated in accordance with FCC rules (47 C.F.R. 1.992) and may not reflect the actual voting interest indirectly held in the filer.

Specific Approval Entity or Individual

† Non-member Directors		
Name	Citizenship	Business
Michael Anatolitis	Cyprus	Individual
Karl Heinz Horrer	Germany	Individual
Jens Höllermann	Germany	Individual
Andrea Neuböck-Escher	Austria	Individual

*Non-member Directors		
Name	Citizenship	Business
Peter Veldman	Netherlands	Individual
Victor de Roo	Netherlands	Individual

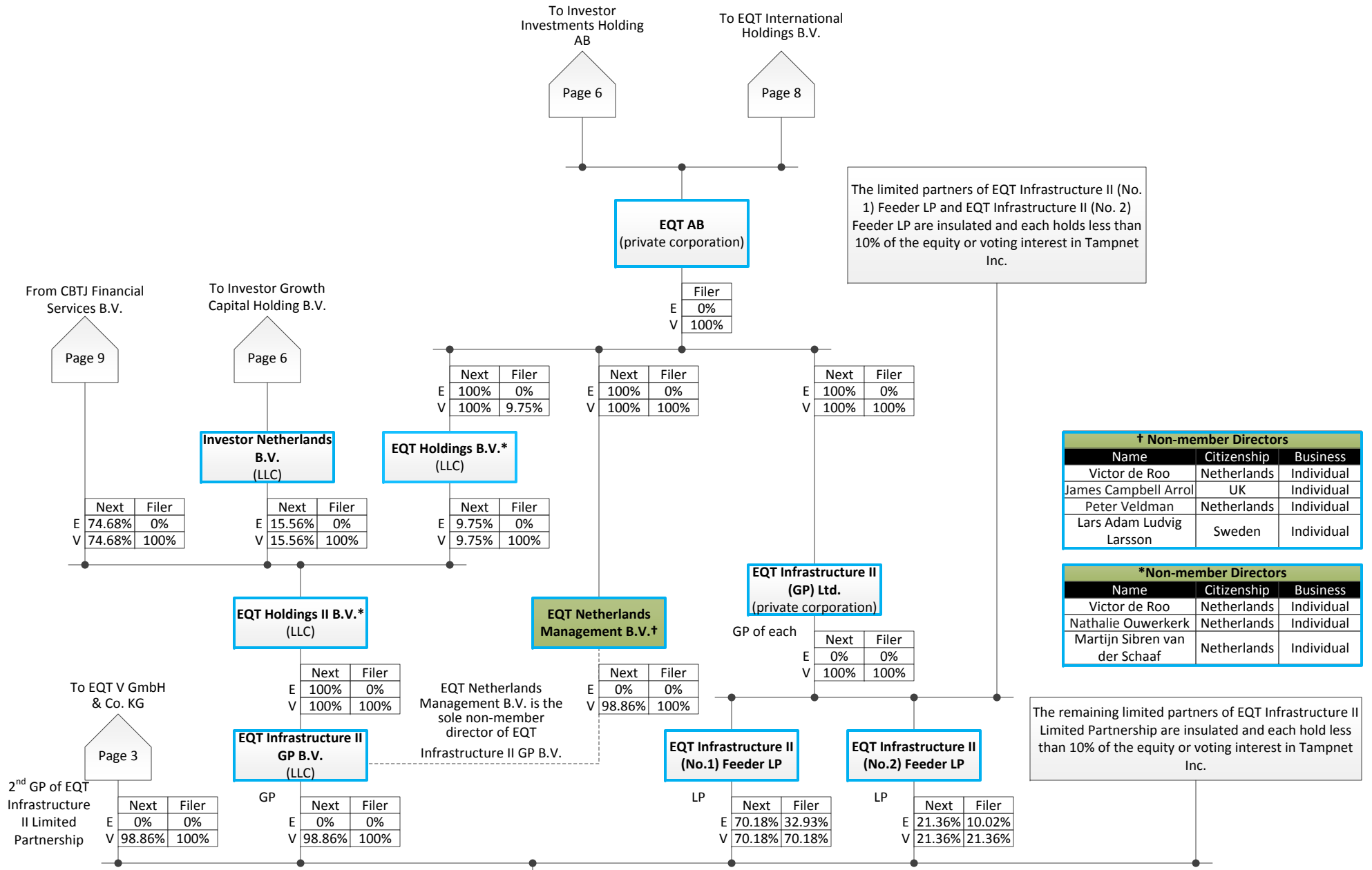

The limited partners of EQT Infrastructure II (No. 1) Feeder LP and EQT Infrastructure II (No. 2) Feeder LP are insulated and each holds less than 10% of the equity or voting interest in Tampnet Inc.

† Non-member Directors		
Name	Citizenship	Business
Victor de Roo	Netherlands	Individual
James Campbell Arrol	UK	Individual
Peter Veldman	Netherlands	Individual
Lars Adam Ludvig Larsson	Sweden	Individual

*Non-member Directors		
Name	Citizenship	Business
Victor de Roo	Netherlands	Individual
Nathalie Ouwerkerk	Netherlands	Individual
Martijn Sibren van der Schaaf	Netherlands	Individual

The remaining limited partners of EQT Infrastructure II Limited Partnership are insulated and each hold less than 10% of the equity or voting interest in Tampnet Inc.

E= Equity Interest
 V=Voting Interest
 Next = Interest in next entity in structure
 Filer = Interest in Tampnet Inc.

Note = Voting interests in the filer identified herein have been calculated in accordance with FCC rules (47 C.F.R. 1.992) and may not reflect the actual voting interest indirectly held in the filer..

Specific Approval Entity or Individual

Page 4

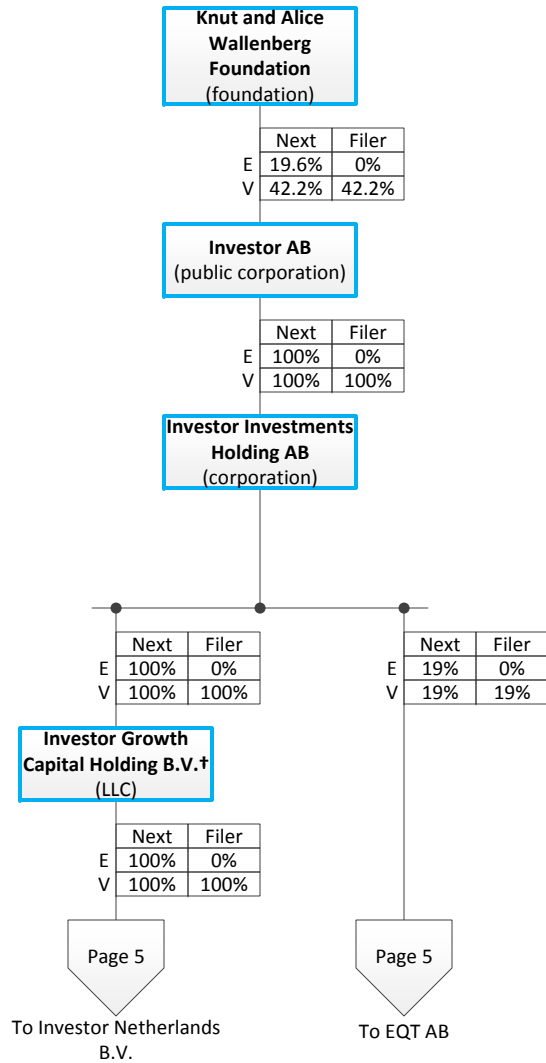

E= Equity Interest
V=Voting Interest

Next = Interest in next entity in structure
Filer = Interest in Tampnet Inc.

Note = Voting interests in the filer identified herein have been calculated in accordance with FCC rules (47 C.F.R. 1.992) and may not reflect the actual voting interest indirectly held in the filer.

Specific Approval
Entity or Individual

† Non-member Directors		
Name	Citizenship	Business
Marcus Jacobus Maria Hollander	Netherlands	Individual
Andreas Georg Christiaan Demmel	German	Individual
Robert de Heus	Netherlands	Individual
Petra Hedengran	Sweden	Individual
Anders Eckerwall	Sweden	Individual

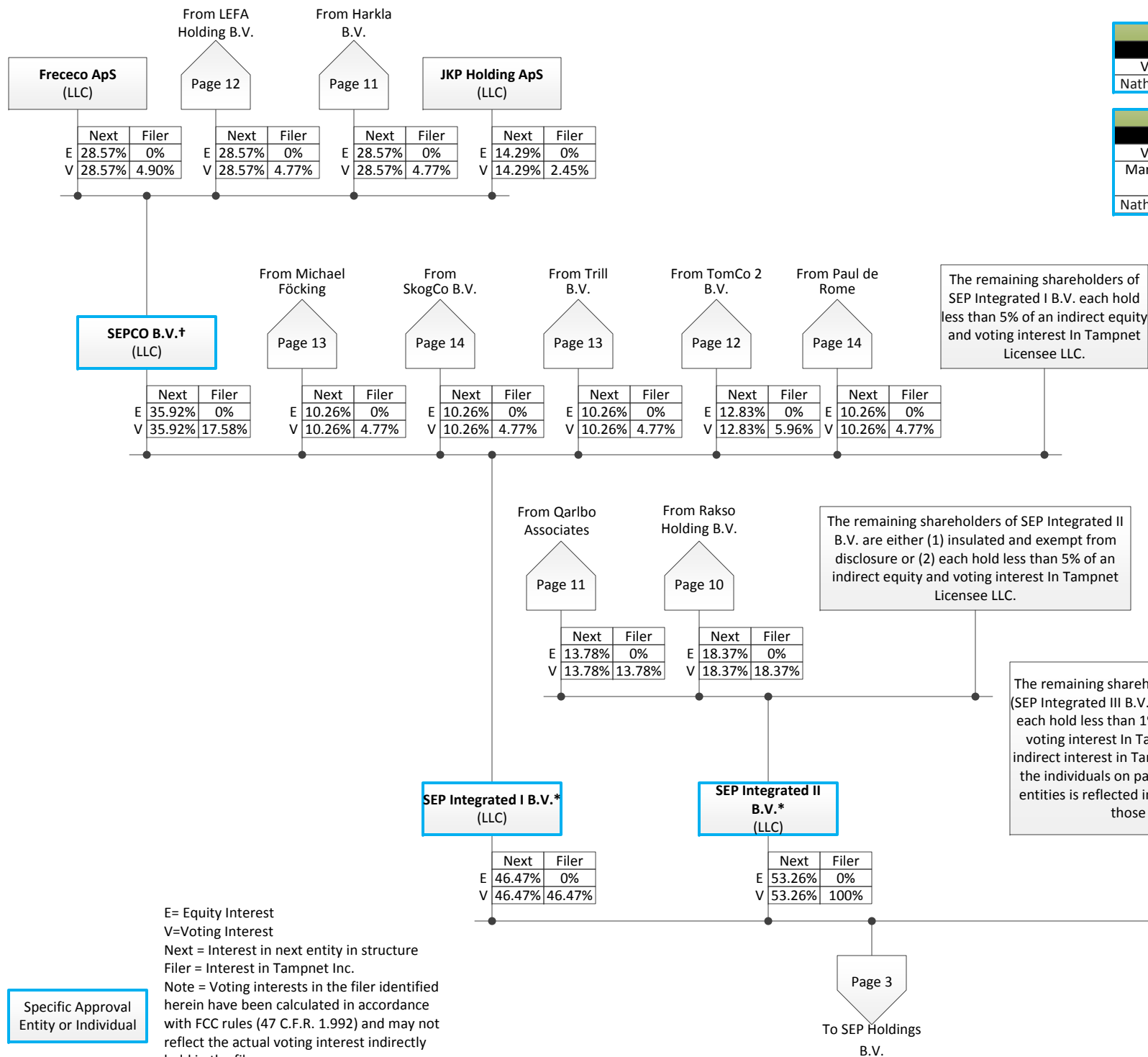

***Non-member Directors**

Name	Citizenship	Business
Victor de Roo	Netherlands	Individual
Nathalie Ouwkerk	Netherlands	Individual

† Non-member Directors

Name	Citizenship	Business
Victor de Roo	Netherlands	Individual
Martijn Sibren van der Schaaf	Netherlands	Individual
Nathalie Ouwkerk	Netherlands	Individual

E= Equity Interest
 V=Voting Interest
 Next = Interest in next entity in structure
 Filer = Interest in Tampnet Inc.
 Note = Voting interests in the filer identified herein have been calculated in accordance with FCC rules (47 C.F.R. 1.992) and may not reflect the actual voting interest indirectly held in the filer.

Specific Approval Entity or Individual

The remaining shareholders of SEP Holdings B.V. (SEP Integrated III B.V. and SEP Integrated IV B.V.) each hold less than 1% of an indirect equity and voting interest in Tampnet Licensee LLC. Any indirect interest in Tampnet Licensee LLC held by the individuals on pages 10 – 14 through these entities is reflected in the aggregate interest of those individuals.

The remaining shareholders of SEP Integrated II B.V. are either (1) insulated and exempt from disclosure or (2) each hold less than 5% of an indirect equity and voting interest in Tampnet Licensee LLC.

The remaining shareholders of SEP Integrated I B.V. each hold less than 5% of an indirect equity and voting interest in Tampnet Licensee LLC.

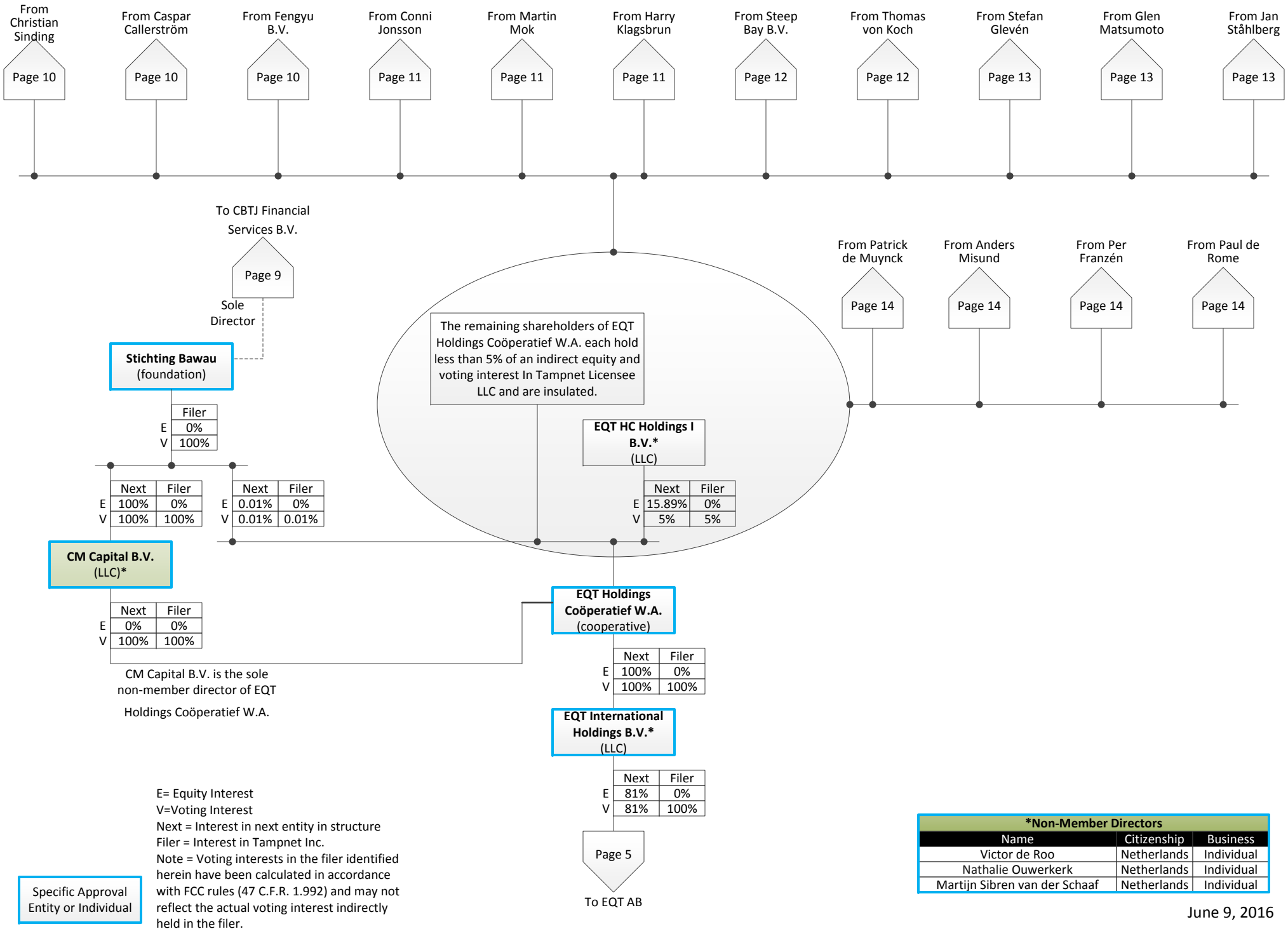

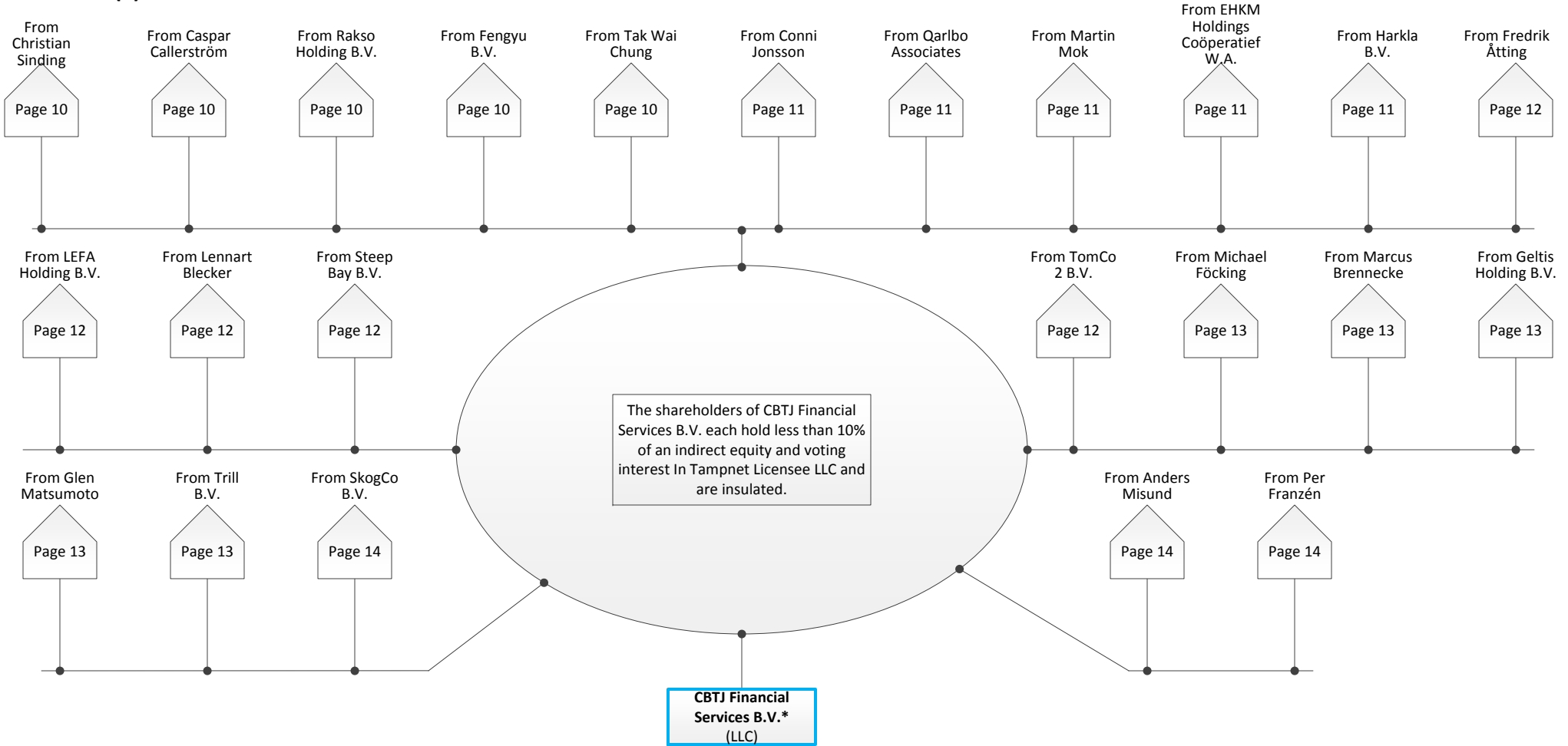

CBTJ Financial Services B.V.* (LLC)

Filer
E 0%
V 100%

Sole Director

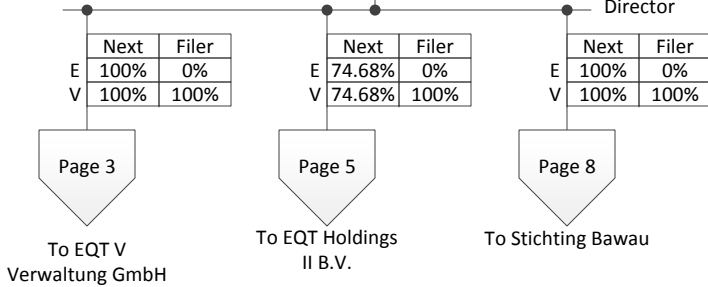

E= Equity Interest
 V=Voting Interest
 Next = Interest in next entity in structure
 Filer = Interest in Tampnet Inc.
 Note = Voting interests in the filer identified herein have been calculated in accordance with FCC rules (47 C.F.R. 1.992) and may not reflect the actual voting interest indirectly held in the filer.

Specific Approval Entity or Individual

*Non-Member Directors		
Name	Citizenship	Business
Victor de Roo	Netherlands	Individual
Nathalie Ouwkerk	Netherlands	Individual
Martijn Sibren van der Schaaf	Netherlands	Individual

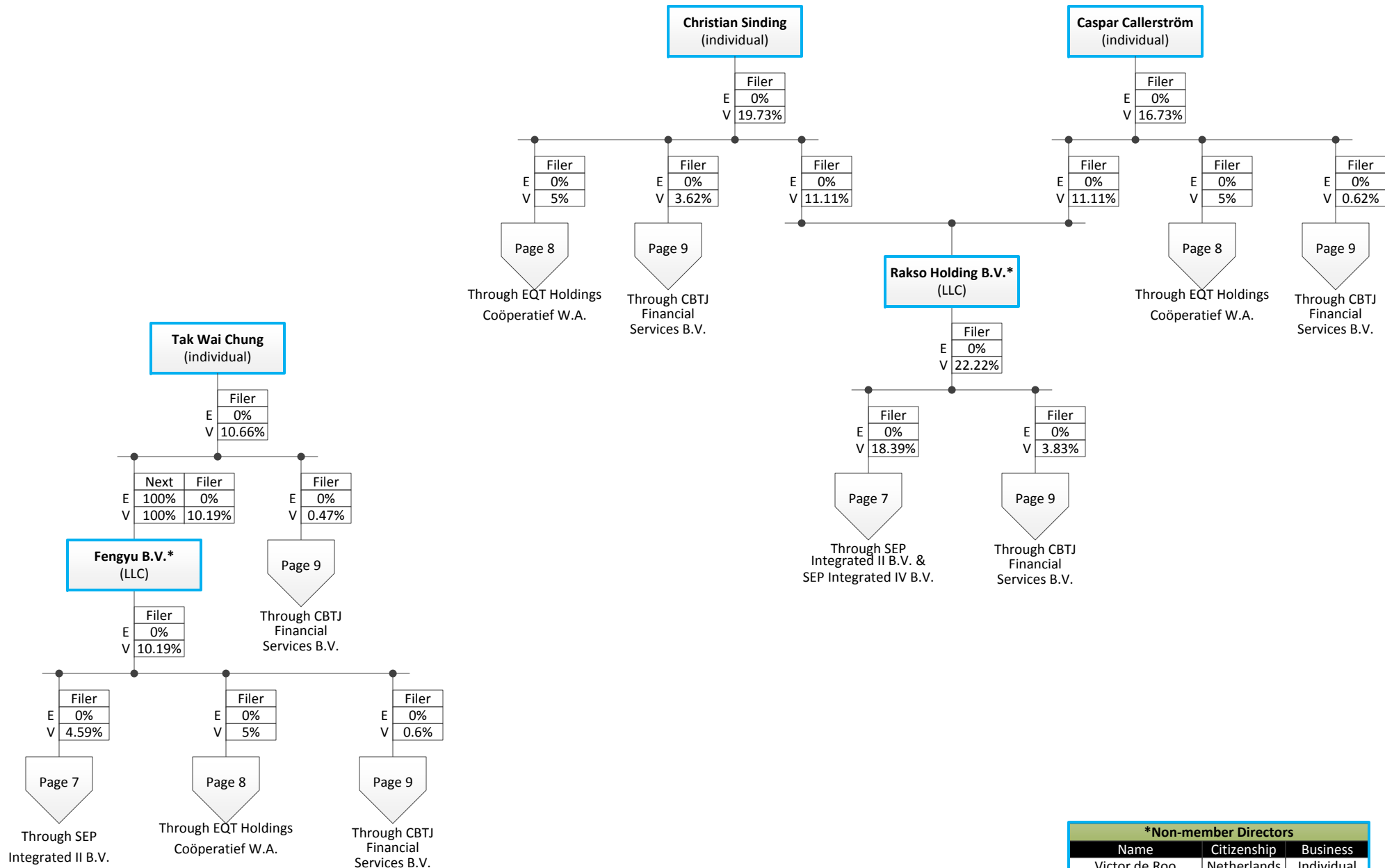

E= Equity Interest
V=Voting Interest

Next = Interest in next entity in structure

Filer = Interest in Tampnet Inc.

Note = Voting interests in the filer identified herein have been calculated in accordance with FCC rules (47 C.F.R. 1.992) and may not reflect the actual voting interest indirectly held in the filer.

Specific Approval
Entity or Individual

*Non-member Directors		
Name	Citizenship	Business
Victor de Roo	Netherlands	Individual
Martijn Sibren van der Schaaf	Netherlands	Individual
Nathalie Ouwkerk	Netherlands	Individual

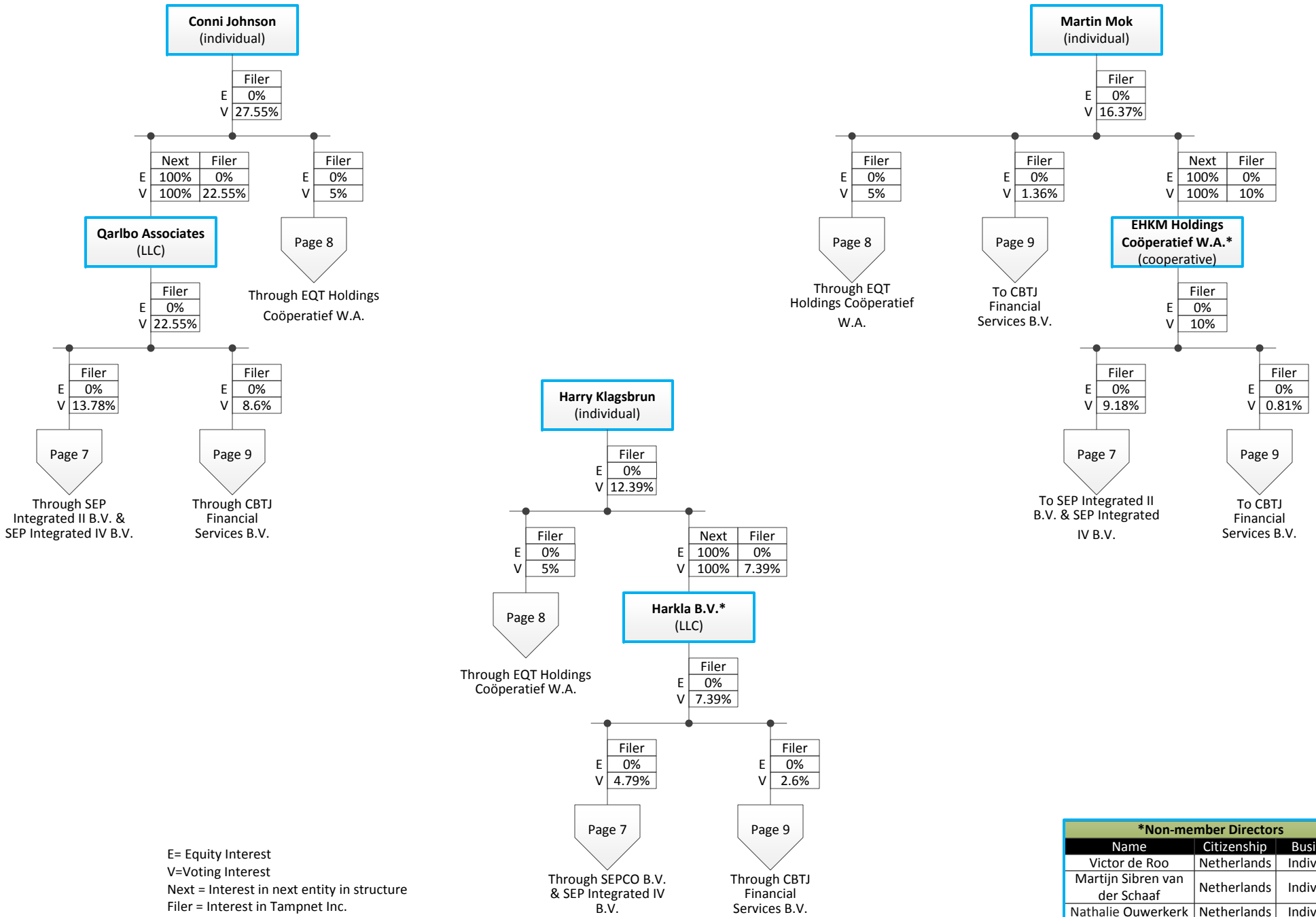

E= Equity Interest
 V=Voting Interest
 Next = Interest in next entity in structure
 Filer = Interest in Tampnet Inc.
 Note = Voting interests in the filer identified herein have been calculated in accordance with FCC rules (47 C.F.R. 1.992) and may not reflect the actual voting interest indirectly held in the filer.

Specific Approval Entity or Individual

*Non-member Directors		
Name	Citizenship	Business
Victor de Roo	Netherlands	Individual
Martijn Sibren van der Schaaf	Netherlands	Individual
Nathalie Ouwerkerk	Netherlands	Individual

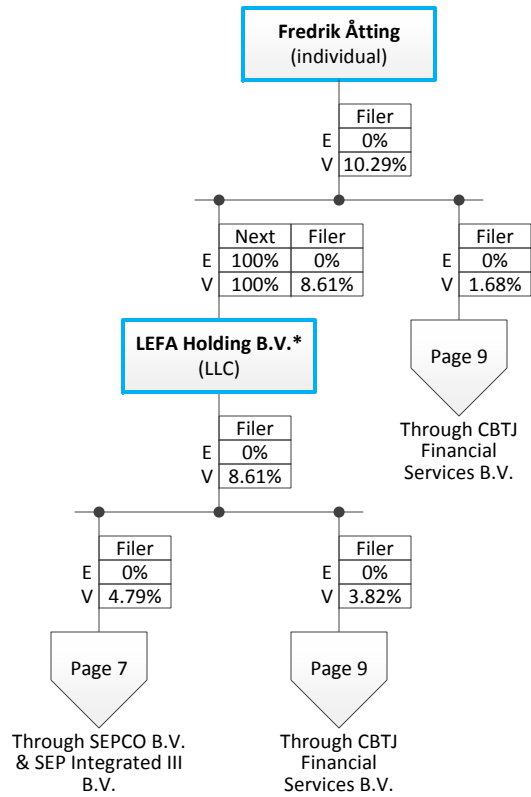

Through SEPCO B.V. & SEP Integrated III B.V.

Through CBTJ Financial Services B.V.

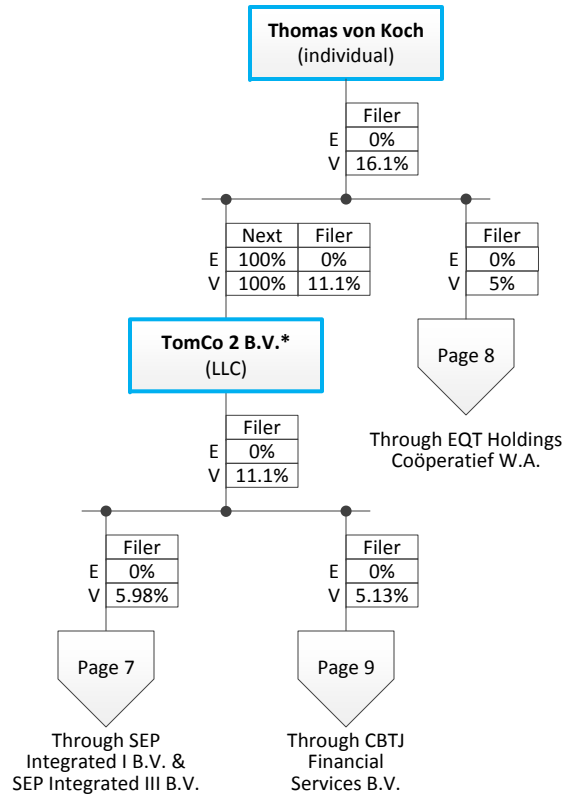

Through SEP Integrated I B.V. & SEP Integrated III B.V.

Through CBTJ Financial Services B.V.

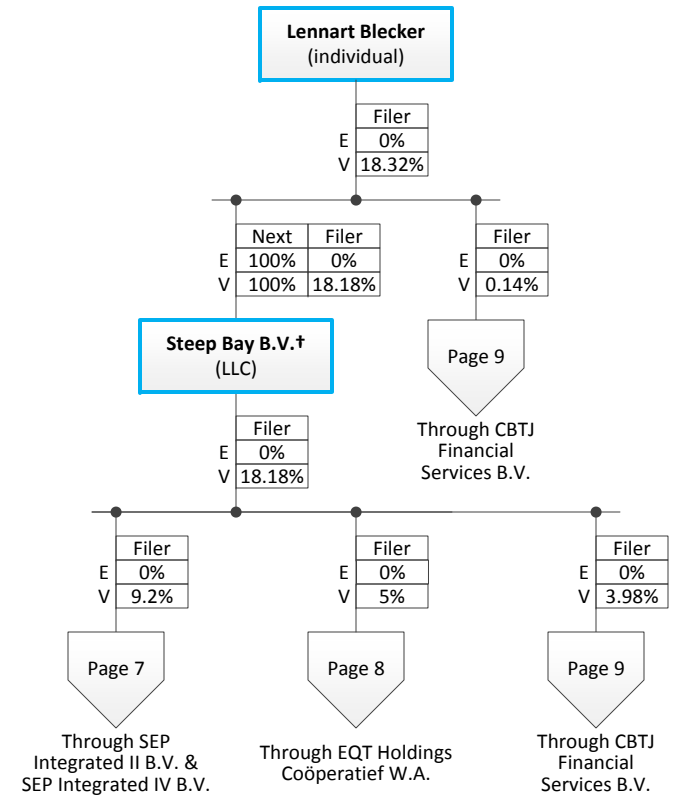

Through SEP Integrated II B.V. & SEP Integrated IV B.V.

Through EQT Holdings Coöperatief W.A.

Through CBTJ Financial Services B.V.

E= Equity Interest
 V=Voting Interest
 Next = Interest in next entity in structure
 Filer = Interest in Tampnet Inc.
 Note = Voting interests in the filer identified herein have been calculated in accordance with FCC rules (47 C.F.R. 1.992) and may not reflect the actual voting interest indirectly held in the filer.

Specific Approval Entity or Individual

† Non-member Director		
Name	Citizenship	Business
Lars Adam Ludvig Larsson	Switzerland	Individual

*Non-member Directors		
Name	Citizenship	Business
Victor de Roo	Netherlands	Individual
Martijn Sibren van der Schaaf	Netherlands	Individual
Nathalie Ouwerkerk	Netherlands	Individual

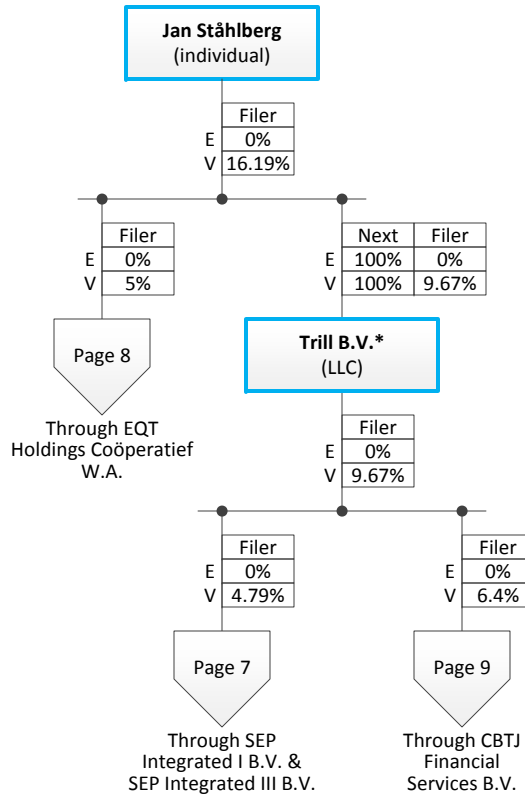
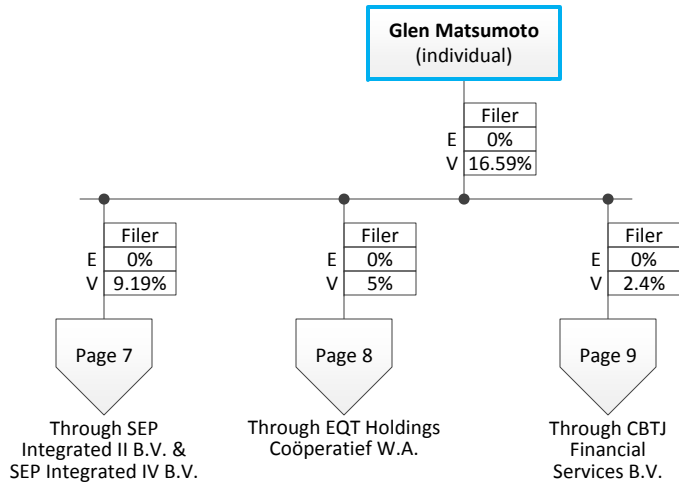
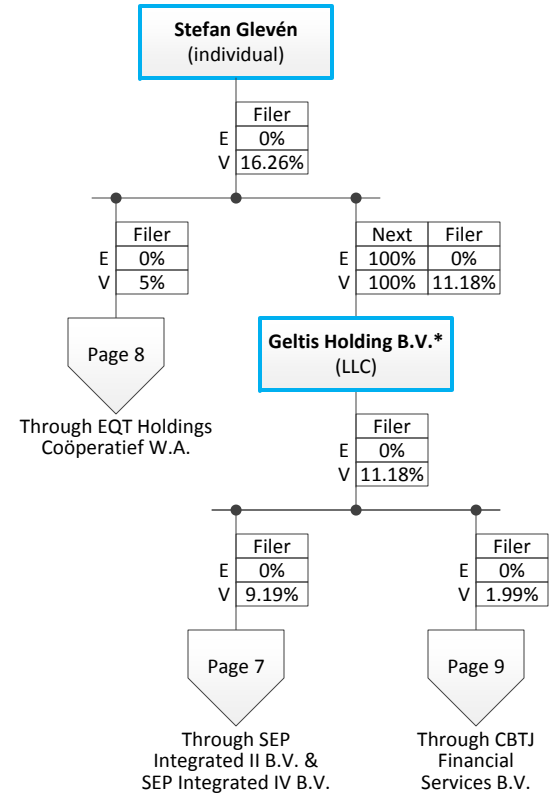
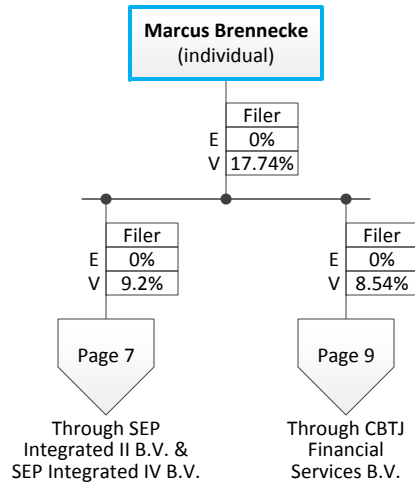
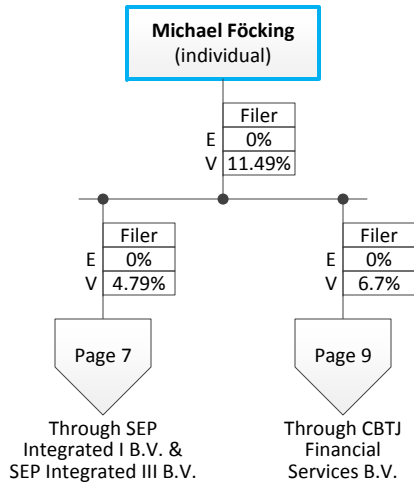

*Non-member Directors		
Name	Citizenship	Business
Victor de Roo	Netherlands	Individual
Martijn Sibren van der Schaaf	Netherlands	Individual
Nathalie Ouwerkerk	Netherlands	Individual

E= Equity Interest
 V=Voting Interest
 Next = Interest in next entity in structure
 Filer = Interest in Tampnet Inc.
 Note = Voting interests in the filer identified herein have been calculated in accordance with FCC rules (47 C.F.R. 1.992) and may not reflect the actual voting interest indirectly held in the filer.

Specific Approval Entity or Individual

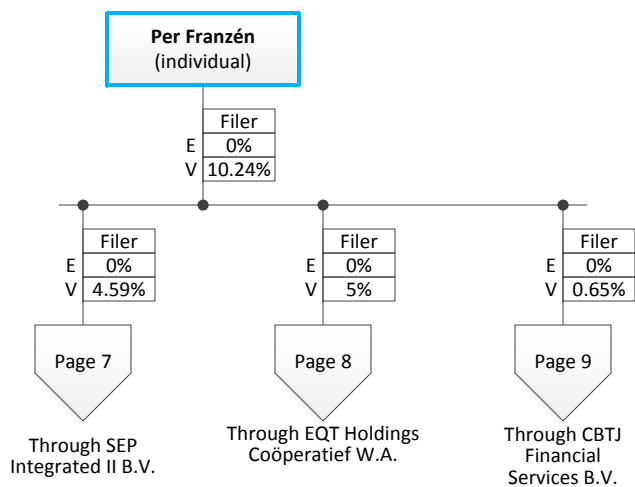
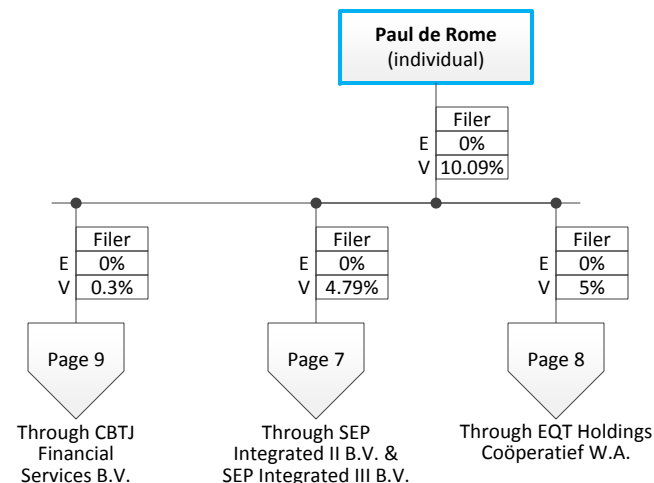
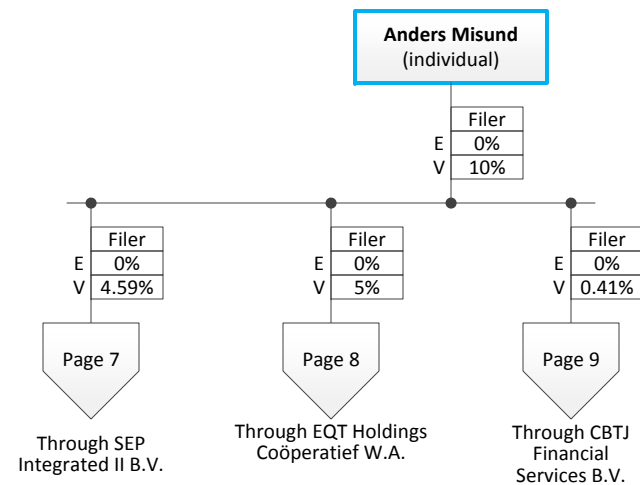
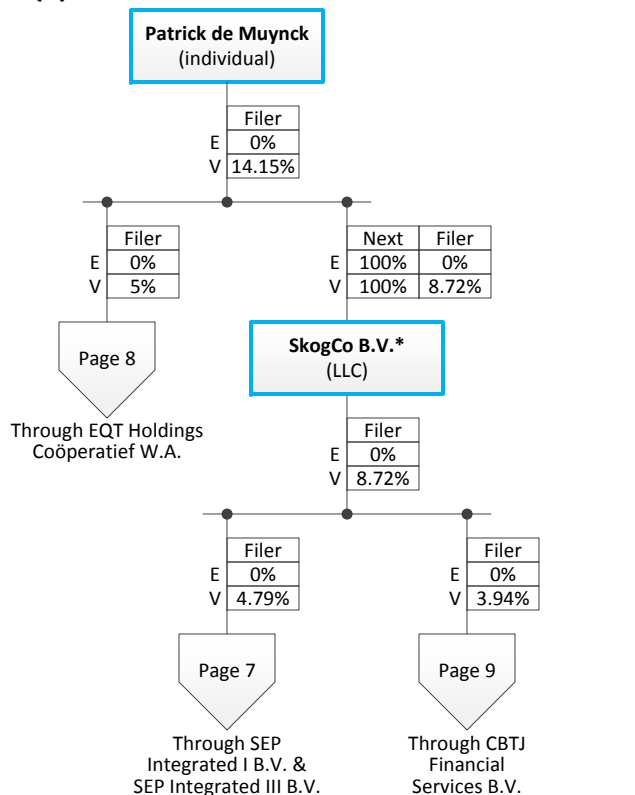

*Non-member Directors		
Name	Citizenship	Business
Victor de Roo	Netherlands	Individual
Martijn Sibren van der Schaaf	Netherlands	Individual
Nathalie Ouwkerk	Netherlands	Individual

Specific Approval Entity or Individual

E= Equity Interest
V=Voting Interest

Next = Interest in next entity in structure
Filer = Interest in Tampnet Inc.

Note = Voting interests in the filer identified herein have been calculated in accordance with FCC rules (47 C.F.R. 1.992) and may not reflect the actual voting interest indirectly held in the filer.