



SAR TEST REPORT

No. I21Z70258-SEM01

For

Samsung Electronics Co., Ltd.

Multi-band GSM/WCDMA/LTE phone with Bluetooth, WLAN

Model name: SM-A037M/DS, SM-A037M

With

Hardware Version: REV1.0

Software Version: A037M.001

FCC ID: ZCASMA037M

Issued Date: 2021-7-14

Note:

The test results in this test report relate only to the devices specified in this report. This report shall not be reproduced except in full without the written approval of CTTL.

The report must not be used by the client to claim product certification, approval, or endorsement by NVLAP, NIST, or any agency of the U.S. Government.

Test Laboratory:

CTTL, Telecommunication Technology Labs, CAICT

No. 51, Xueyuan Road, Haidian District, Beijing, P. R. China 100191.

Tel:+86(0)10-62304633-2512, Fax:+86(0)10-62304633-2504

Email: ctl_terminals@caict.ac.cn, website: www.caict.ac.cn



No.I21Z70258-SEM01

REPORT HISTORY

Report Number	Revision	Issue Date	Description
I21Z70258-SEM01	Rev.0	2021-7-7	Initial creation of test report
I21Z70258-SEM01	Rev.1	2021-7-14	Update the information for BT of test report.

TABLE OF CONTENT

1 TEST LABORATORY	5
1.1 TESTING LOCATION	5
1.2 TESTING ENVIRONMENT.....	5
1.3 PROJECT DATA	5
1.4 SIGNATURE.....	5
2 STATEMENT OF COMPLIANCE	6
3 CLIENT INFORMATION	8
3.1 APPLICANT INFORMATION	8
3.2 MANUFACTURER INFORMATION	8
4 EQUIPMENT UNDER TEST (EUT) AND ANCILLARY EQUIPMENT (AE)	9
4.1 ABOUT EUT	9
4.2 INTERNAL IDENTIFICATION OF EUT USED DURING THE TEST	9
4.3 INTERNAL IDENTIFICATION OF AE USED DURING THE TEST	9
5 TEST METHODOLOGY	10
5.1 APPLICABLE LIMIT REGULATIONS	10
5.2 APPLICABLE MEASUREMENT STANDARDS.....	10
6 SPECIFIC ABSORPTION RATE (SAR)	11
6.1 INTRODUCTION.....	11
6.2 SAR DEFINITION.....	11
7 TISSUE SIMULATING LIQUIDS	12
7.1 TARGETS FOR TISSUE SIMULATING LIQUID	12
7.2 DIELECTRIC PERFORMANCE	12
8 SYSTEM VERIFICATION	16
8.1 SYSTEM SETUP.....	16
8.2 SYSTEM VERIFICATION.....	17
9 MEASUREMENT PROCEDURES	18
9.1 TESTS TO BE PERFORMED	18
9.2 GENERAL MEASUREMENT PROCEDURE.....	20
9.3 WCDMA MEASUREMENT PROCEDURES FOR SAR	21
9.4 SAR MEASUREMENT FOR LTE.....	22
9.5 BLUETOOTH & WI-FI MEASUREMENT PROCEDURES FOR SAR	23
9.6 POWER DRIFT.....	23
10 AREA SCAN BASED 1-G SAR	24
10.1 REQUIREMENT OF KDB.....	24
10.2 FAST SAR ALGORITHMS	24



11 CONDUCTED OUTPUT POWER.....	25
11.1 GSM MEASUREMENT RESULT	25
11.2 WCDMA MEASUREMENT RESULT.....	27
11.3 LTE MEASUREMENT RESULT	28
11.4 WI-FI AND BT MEASUREMENT RESULT	44
12 SIMULTANEOUS TX SAR CONSIDERATIONS.....	45
12.1 TRANSMIT ANTENNA SEPARATION DISTANCES	45
12.3 SAR MEASUREMENT POSITIONS	45
12.4 STANDALONE SAR TEST EXCLUSION CONSIDERATIONS	45
13 EVALUATION OF SIMULTANEOUS.....	46
14 SAR TEST RESULT	47
14.1 SAR RESULTS FOR FAST SAR.....	48
14.2 SAR RESULTS FOR STANDARD PROCEDURE	59
14.3 WLAN EVALUATION FOR 2.4G	64
15 SAR MEASUREMENT VARIABILITY.....	67
16 MEASUREMENT UNCERTAINTY	68
16.1 MEASUREMENT UNCERTAINTY FOR NORMAL SAR TESTS (300MHZ~3GHZ)	68
16.2 MEASUREMENT UNCERTAINTY FOR FAST SAR TESTS (300MHZ~3GHZ)	69
17 MAIN TEST INSTRUMENTS.....	70
ANNEX A GRAPH RESULTS.....	71
ANNEX B SYSTEM VERIFICATION RESULTS	103
ANNEX C SAR MEASUREMENT SETUP	112
ANNEX D POSITION OF THE WIRELESS DEVICE IN RELATION TO THE PHANTOM	118
ANNEX E EQUIVALENT MEDIA RECIPES	121
ANNEX F SYSTEM VALIDATION	122
ANNEX G PROBE CALIBRATION CERTIFICATE.....	123
ANNEX H DIPOLE CALIBRATION CERTIFICATE	132
ANNEX I ACCREDITATION CERTIFICATE.....	180

1 Test Laboratory

1.1 Testing Location

Company Name:	CTTL(Shouxiang)
Address:	No. 51 Shouxiang Science Building, Xueyuan Road, Haidian District, Beijing, P. R. China100191

1.2 Testing Environment

Temperature:	18°C~25°C,
Relative humidity:	30%~ 70%
Ground system resistance:	< 0.5 Ω
Ambient noise & Reflection:	< 0.012 W/kg

1.3 Project Data

Project Leader:	Qi Dianyuan
Test Engineer:	Lin Xiaojun
Testing Start Date:	June 24, 2021
Testing End Date:	July 1, 2021

1.4 Signature



Lin Xiaojun
(Prepared this test report)

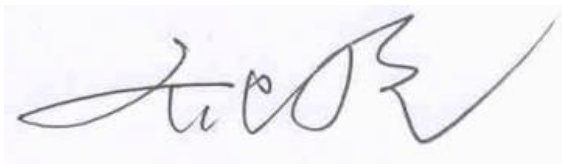

Qi Dianyuan
(Reviewed this test report)

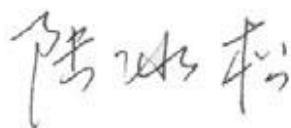

Lu Bingsong
Deputy Director of the laboratory
(Approved this test report)

2 Statement of Compliance

The maximum results of Specific Absorption Rate (SAR) found during testing for Samsung Electronics Co., Ltd. Multi-band GSM/WCDMA/LTE phone with Bluetooth, WLAN SM-A037M/DS,SM-A037M are as follows.

Table 2.1: Highest Reported SAR (1g)

Antenna	Band	Head	Body	1g SAR Limits (W/kg)
		1g SAR(W/kg)	1g SAR(W/kg)	
Main antenna	GSM 850	0.45	0.36	1.6
	PCS 1900	0.16	0.87	
	UMTS FDD 2	0.12	0.86	
	UMTS FDD 4	0.08	0.66	
	UMTS FDD 5	0.28	0.25	
	LTE Band 2	0.07	0.85	
	LTE Band 4	0.07	0.56	
	LTE Band 5	0.22	0.32	
	LTE Band 7	0.20	0.60	
	LTE Band 12	0.19	0.15	
	LTE Band 66	0.09	0.54	
WiFi antenna	WiFi 2.4G	0.18	0.21	

The SAR values found for the Mobile Phone are below the maximum recommended levels of 1.6 W/kg as averaged over any 1g tissue according to the ANSI C95.1-1992.

For body operation, this device has been tested and meets FCC RF exposure guidelines when used with any accessory that contains no metal and which provides a minimum separation distance of 10 mm between this device and the body of the user. Use of other accessories may not ensure compliance with FCC RF exposure guidelines.

The EUT battery must be fully charged and checked periodically during the test to ascertain uniform power output.

The measurement together with the test system set-up is described in annex C of this test report. A detailed description of the equipment under test can be found in chapter 4 of this test report. The highest reported SAR value is obtained at the case of **(Table 2.1)**, and the values are:

Head: 0.45 W/kg(1g).

Body: 0.87 W/kg(1g).

Table 2.2: The sum of SAR values for Main antenna + WiFi-2.4G

	Position	Cellular antenna	WiFi-2.4G	Sum
Highest reported SAR value for Head	Left hand, Cheek	0.45	0.15	0.60
Highest SAR value for Body	Rear 10mm	0.66	0.21	0.87
	Bottom 10mm	0.87	/	0.87

Table 2.4: The sum of SAR values for Main antenna + BT

	Position	Cellular antenna	BT	Sum
Highest SAR value for Head	Left hand, Cheek	0.45	0.38 ^[1]	0.83
Maximum reported SAR value for Body	Rear 10mm	0.66	0.19 ^[1]	0.85
	Bottom 10mm	0.87	/	0.87

Note1: the test positions of above tables are for the worse case that have been evaluated.

[1] - Estimated SAR for Bluetooth (see the table 13.3)

According to the above tables, the highest sum of reported SAR values is **0.87 W/kg (1g)**. The detail for simultaneous transmission consideration is described in chapter 13.



3 Client Information

3.1 Applicant Information

Company Name:	Samsung Electronics Co., Ltd.
Address/Post:	19 Chapin Rd., Building D Pine Brook, NJ 07058
Contact Person:	Jenni Chun
Contact Email:	j1.chun@samsung.com
Telephone:	+1-201-937-4203
Fax	/

3.2 Manufacturer Information

Company Name:	Samsung Electronics Co., Ltd.
Address/Post:	Samsung R5, Maetan dong 129, Samsung ro Youngtong gu, Suwon city 443 742, Korea
Contact Person:	Sunghoon Cho
Contact Email:	ggobi.cho@samsung.com
Telephone:	+82-10-2722-4159
Fax	/

4 Equipment Under Test (EUT) and Ancillary Equipment (AE)

4.1 About EUT

Description:	Multi-band GSM/WCDMA/LTE phone with Bluetooth, WLAN
Model name:	SM-A037M/DS,SM-A037M
Operating mode(s):	GSM 850/900/1800/1900, UMTS FDD 1/2/4/5/8, BT, Wi-Fi(2.4G) LTE Band 1/2/3/4/5/7/8/12/17/28/66
Tested Tx Frequency:	824 – 849 MHz (GSM 850)
	1850 – 1910 MHz (GSM 1900)
	824–849 MHz (WCDMA 850 Band V)
	1710 – 1755 MHz (WCDMA 1700 Band IV)
	1850–1910 MHz (WCDMA1900 Band II)
	1850 – 1910 MHz (LTE Band 2)
	1710 – 1755 MHz (LTE Band 4)
	824 – 849 MHz (LTE Band 5)
	2500 – 2570 MHz (LTE Band 7)
	699 – 716 MHz (LTE Band 12)
	1710 – 1780 MHz (LTE Band 66)
	2412 – 2462 MHz (Wi-Fi 2.4G)
	2402 – 2480 MHz (Bluetooth)
GPRS/EGPRS Multislot Class:	12
GPRS capability Class:	B
Test device Production information:	Production unit
Device type:	Portable device
Antenna type:	Integrated antenna

4.2 Internal Identification of EUT used during the test

EUT ID*	IMEI	HW	SW Version
EUT1	I21Z70258UT21a	REV1.0	A037M.001
EUT2	I21Z70258UT29a	REV1.0	A037M.001
EUT3	I21Z70258UT01a	REV1.0	A037M.001
EUT4	I21Z70258UT03a	REV1.0	A037M.001
EUT5	I21Z70258UT20a	REV1.0	A037M.001

*EUT ID: is used to identify the test sample in the lab internally.

Note: It is performed to test SAR with the EUT1~2 and conducted power with the EUT3~5.

4.3 Internal Identification of AE used during the test

AE ID*	Description	Model	SN	Manufacturer
AE1	Battery	Secondary Li-ion Battery	HQ-50S	SCUD (Fujian) Electronics CO.,LTD
AE2	Headset	EHS61ASFWE	/	DONGGUAN YOUNGBO ELECTRONICS CO.,LTD
AE3	Headset	EHS61ASFWE	/	WATA ELECTRONICS CO.,LTD

*AE ID: is used to identify the test sample in the lab internally.

5 TEST METHODOLOGY

5.1 Applicable Limit Regulations

ANSI C95.1–1992: IEEE Standard for Safety Levels with Respect to Human Exposure to Radio Frequency Electromagnetic Fields, 3 kHz to 300 GHz.

It specifies the maximum exposure limit of **1.6 W/kg** as averaged over any 1 gram of tissue for portable devices being used within 20 cm of the user in the uncontrolled environment.

5.2 Applicable Measurement Standards

IEEE 1528–2013: Recommended Practice for Determining the Peak Spatial-Average Specific Absorption Rate (SAR) in the Human Head from Wireless Communications Devices: Measurement Techniques.

KDB447498 D01: General RF Exposure Guidance v06: Mobile and Portable Devices RF Exposure Procedures and Equipment Authorization Policies.

KDB648474 D04 Handset SAR v01r03: SAR Evaluation Considerations for Wireless Handsets.

KDB941225 D01 SAR test for 3G devices v03r01: SAR Measurement Procedures for 3G Devices

KDB941225 D05 SAR for LTE Devices v02r05: SAR Evaluation Considerations for LTE Devices

KDB941225 D06 Hotspot Mode SAR v02r01: SAR Evaluation Procedures for Portable Devices with Wireless Router Capabilities

KDB248227 D01 802.11 Wi-Fi SAR v02r02: SAR GUIDANCE FOR IEEE 802.11 (Wi-Fi) TRANSMITTERS

KDB865664 D01 SAR measurement 100 MHz to 6 GHz v01r04: SAR Measurement Requirements for 100 MHz to 6 GHz.

KDB865664 D02 RF Exposure Reporting v01r02: RF Exposure Compliance Reporting and Documentation Considerations

6 Specific Absorption Rate (SAR)

6.1 Introduction

SAR is related to the rate at which energy is absorbed per unit mass in an object exposed to a radio field. The SAR distribution in a biological body is complicated and is usually carried out by experimental techniques or numerical modeling. The standard recommends limits for two tiers of groups, occupational/controlled and general population/uncontrolled, based on a person's awareness and ability to exercise control over his or her exposure. In general, occupational/controlled exposure limits are higher than the limits for general population/uncontrolled.

6.2 SAR Definition

The SAR definition is the time derivative (rate) of the incremental energy (dW) absorbed by (dissipated in) an incremental mass (dm) contained in a volume element (dv) of a given density (ρ). The equation description is as below:

$$SAR = \frac{d}{dt} \left(\frac{dW}{dm} \right) = \frac{d}{dt} \left(\frac{dW}{\rho dv} \right)$$

SAR is expressed in units of Watts per kilogram (W/kg)

SAR measurement can be either related to the temperature elevation in tissue by

$$SAR = c \left(\frac{\delta T}{\delta t} \right)$$

Where: C is the specific heat capacity, δT is the temperature rise and δt is the exposure duration, or related to the electrical field in the tissue by

$$SAR = \frac{\sigma |E|^2}{\rho}$$

Where: σ is the conductivity of the tissue, ρ is the mass density of tissue and E is the RMS electrical field strength.

However for evaluating SAR of low power transmitter, electrical field measurement is typically applied.

7 Tissue Simulating Liquids

7.1 Targets for tissue simulating liquid

Table 7.1: Targets for tissue simulating liquid

Frequency(MHz)	Liquid Type	Conductivity(σ)	$\pm 10\%$ Range	Permittivity(ϵ)	$\pm 10\%$ Range
750	Head	0.89	0.80~0.98	41.94	37.75~46.13
835	Head	0.90	0.81~0.99	41.5	37.35~45.65
1750	Head	1.40	1.26~1.54	40.0	36~44
1900	Head	1.40	1.26~1.54	40.0	36~44
2450	Head	1.80	1.62~1.98	39.2	35.28~43.12
2600	Head	1.96	1.76~2.16	39.01	35.11~42.91

7.2 Dielectric Performance

Table 7.2: Dielectric Performance of Tissue Simulating Liquid

Measurement Date (yyyy-mm-dd)	Type	Frequency	Permittivity ϵ	Drift (%)	Conductivity σ (S/m)	Drift (%)
2021-6-25	Head	750 MHz	43.54	3.81	0.8259	-7.20
2021-6-24	Head	835 MHz	43.18	4.05	0.8637	-4.03
2021-6-26	Head	1750 MHz	40.3	0.55	1.374	0.29
2021-6-27	Head	1750 MHz	43.75	9.16	1.358	-0.88
2021-6-28	Head	1900 MHz	40.28	0.70	1.444	3.14
2021-6-29	Head	1900 MHz	43.38	8.45	1.438	2.71
2021-6-30	Head	2450 MHz	39.08	-0.31	1.891	5.06
2021-7-1	Head	2600 MHz	42.37	8.61	1.957	-0.15

Note: The liquid temperature is 22.0°C

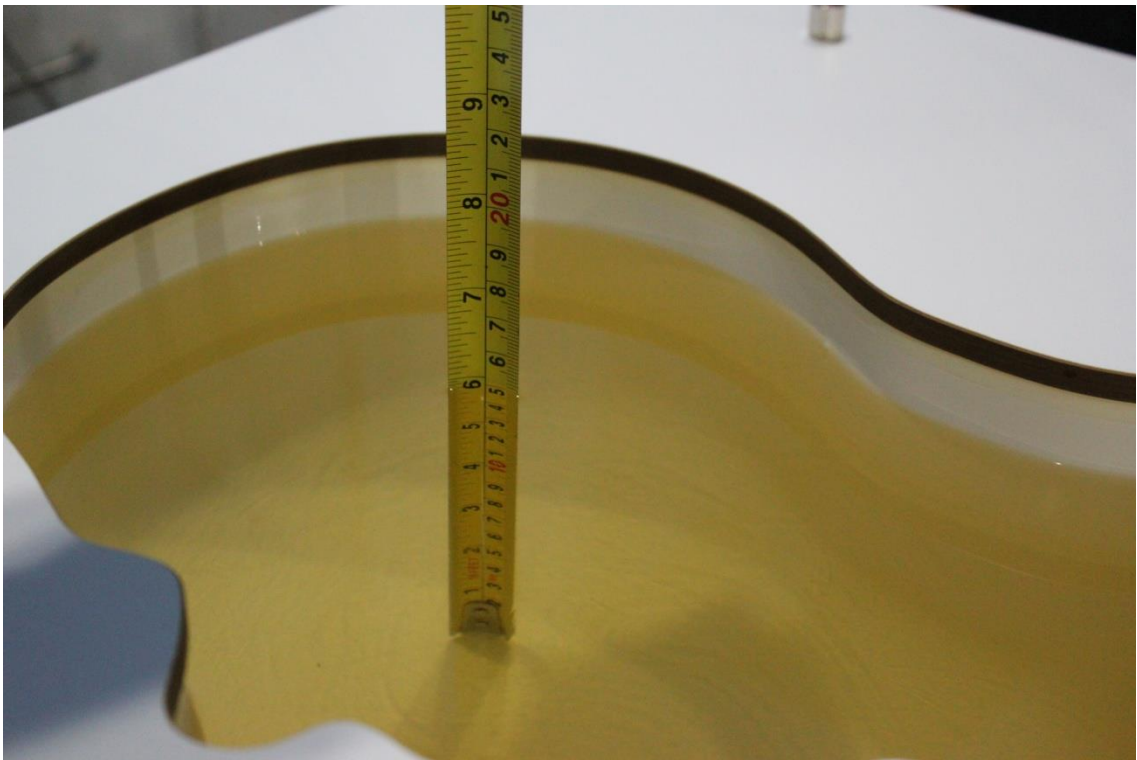

Picture 7-1 Liquid depth in the Head Phantom (750MHz)



Picture 7-2 Liquid depth in the Head Phantom (835 MHz)

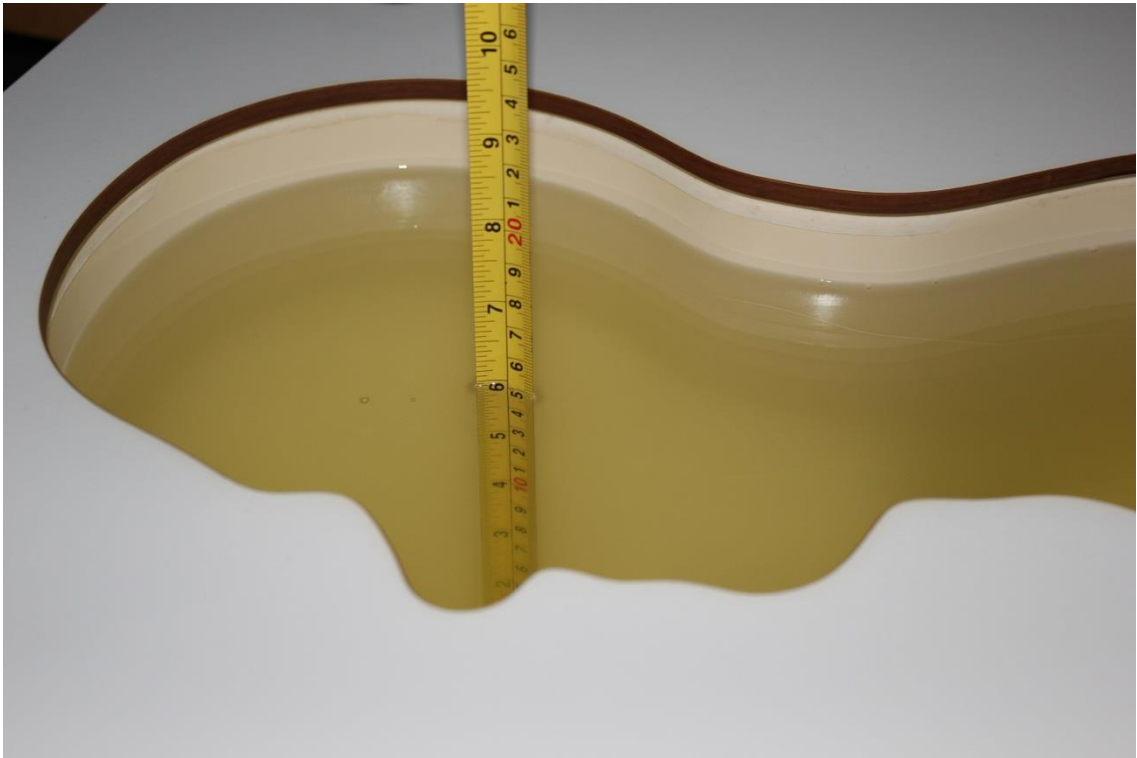

Picture 7-3 Liquid depth in the Head Phantom (1750 MHz)



Picture 7-4 Liquid depth in the Head Phantom (1900 MHz)

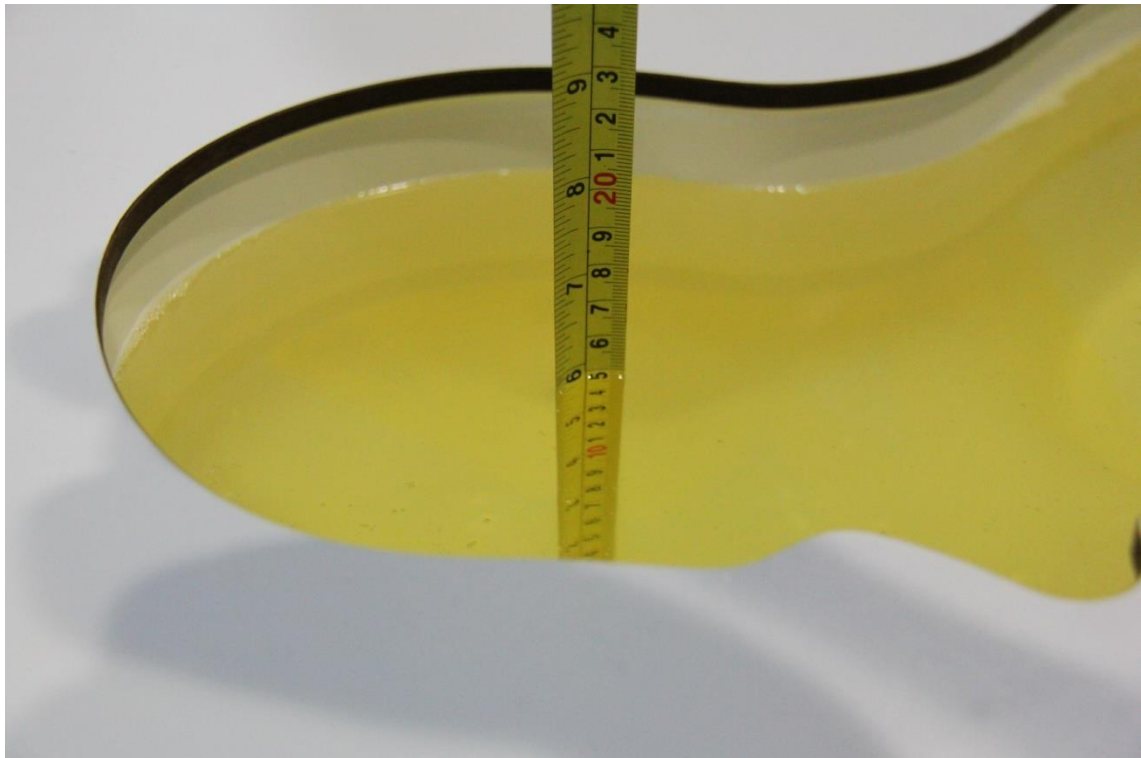

Picture 7-5 Liquid depth in the Head Phantom (2450MHz)



Picture 7-6 Liquid depth in the Head Phantom (2600 MHz)

8 System verification

8.1 System Setup

In the simplified setup for system evaluation, the DUT is replaced by a calibrated dipole and the power source is replaced by a continuous wave that comes from a signal generator. The calibrated dipole must be placed beneath the flat phantom section of the SAM twin phantom with the correct distance holder. The distance holder should touch the phantom surface with a light pressure at the reference marking and be oriented parallel to the long side of the phantom. The equipment setup is shown below:

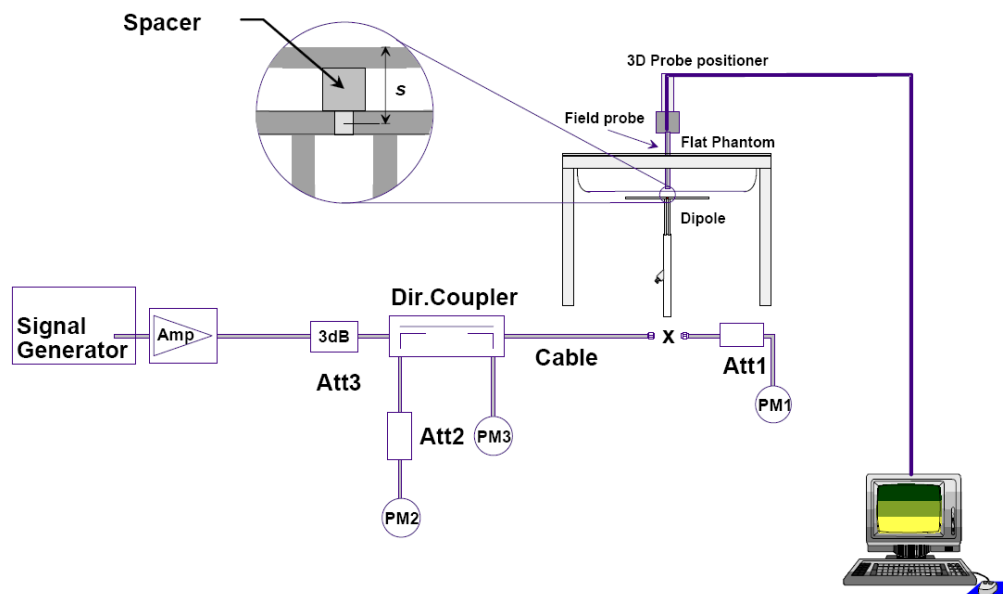

Picture 8.1 System Setup for System Evaluation



Picture 8.2 Photo of Dipole Setup

8.2 System Verification

SAR system verification is required to confirm measurement accuracy, according to the tissue dielectric media, probe calibration points and other system operating parameters required for measuring the SAR of a test device. The system verification must be performed for each frequency band and within the valid range of each probe calibration point required for testing the device.

The system verification results are required that the area scan estimated 1-g SAR is within 3% of the zoom scan 1-g SAR. The details are presented in annex B.

Table 8.1: System Verification of Head

Measurement Date (yyyy-mm-dd)	Frequency	Target value (W/kg)		Measured value(W/kg)		Deviation	
		10 g Average	1 g Average	10 g Average	1 g Average	10 g Average	1 g Average
2021-6-25	750 MHz	5.53	8.47	5.44	8.20	-1.63%	-3.19%
2021-6-24	835 MHz	6.25	9.60	6.16	9.32	-1.44%	-2.92%
2021-6-26	1750 MHz	19.1	36.5	20.5	38.8	7.43%	6.30%
2021-6-27	1750 MHz	19.1	36.5	20.2	38.4	5.97%	5.10%
2021-6-28	1900 MHz	20.6	39.6	21.5	41.6	4.27%	5.05%
2021-6-29	1900 MHz	20.6	39.6	21.4	41.6	3.69%	5.05%
2021-6-30	2450 MHz	24.5	52.5	24.0	52.8	-2.20%	0.57%
2021-7-1	2600 MHz	25.3	57.0	25.2	57.2	-0.24%	0.35%

9 Measurement Procedures

9.1 Tests to be performed

In order to determine the highest value of the peak spatial-average SAR of a handset, all device positions, configurations and operational modes shall be tested for each frequency band according to steps 1 to 3 below. A flowchart of the test process is shown in picture 9.1.

Step 1: The tests described in 9.2 shall be performed at the channel that is closest to the centre of the transmit frequency band (f_c) for:

- a) all device positions (cheek and tilt, for both left and right sides of the SAM phantom, as described in annex D),
- b) all configurations for each device position in a), e.g., antenna extended and retracted, and
- c) all operational modes, e.g., analogue and digital, for each device position in a) and configuration in b) in each frequency band.

If more than three frequencies need to be tested according to 11.1 (i.e., $N_c > 3$), then all frequencies, configurations and modes shall be tested for all of the above test conditions.

Step 2: For the condition providing highest peak spatial-average SAR determined in Step 1, perform all tests described in 9.2 at all other test frequencies, i.e., lowest and highest frequencies. In addition, for all other conditions (device position, configuration and operational mode) where the peak spatial-average SAR value determined in Step 1 is within 3 dB of the applicable SAR limit, it is recommended that all other test frequencies shall be tested as well.

Step 3: Examine all data to determine the highest value of the peak spatial-average SAR found in Steps 1 to 2.

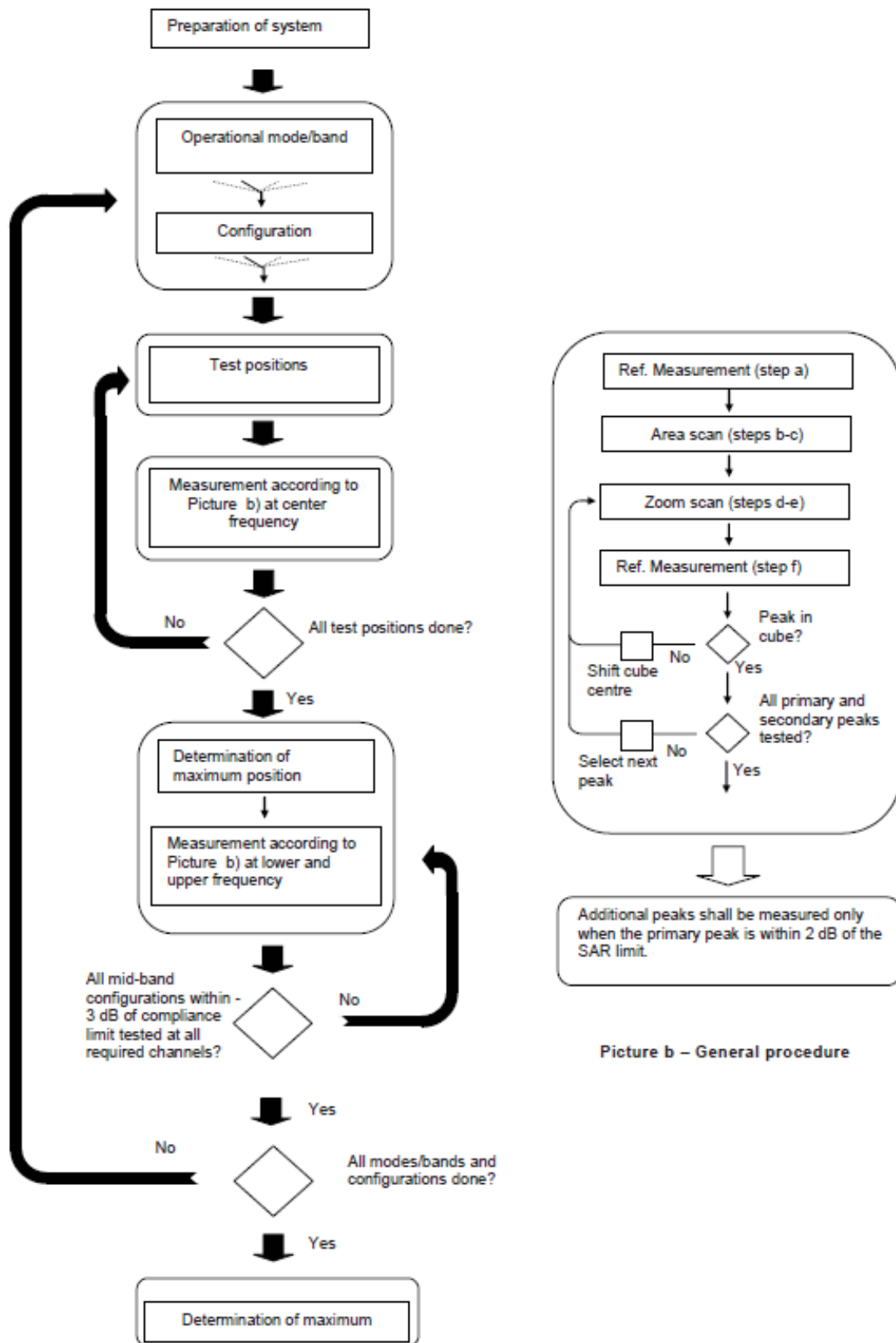

Picture a – Tests to be performed

Picture b – General procedure

Picture 9.1 Block diagram of the tests to be performed

9.2 General Measurement Procedure

The area and zoom scan resolutions specified in the table below must be applied to the SAR measurements and fully documented in SAR reports to qualify for TCB approval. Probe boundary effect error compensation is required for measurements with the probe tip closer than half a probe tip diameter to the phantom surface. Both the probe tip diameter and sensor offset distance must satisfy measurement protocols; to ensure probe boundary effect errors are minimized and the higher fields closest to the phantom surface can be correctly measured and extrapolated to the phantom surface for computing 1-g SAR. Tolerances of the post-processing algorithms must be verified by the test laboratory for the scan resolutions used in the SAR measurements, according to the reference distribution functions specified in IEEE Std 1528-2013. The results should be documented as part of the system validation records and may be requested to support test results when all the measurement parameters in the following table are not satisfied.

		≤ 3 GHz	> 3 GHz
Maximum distance from closest measurement point (geometric center of probe sensors) to phantom surface		5 ± 1 mm	$\frac{1}{2} \cdot \delta \cdot \ln(2) \pm 0.5$ mm
Maximum probe angle from probe axis to phantom surface normal at the measurement location		$30^\circ \pm 1^\circ$	$20^\circ \pm 1^\circ$
Maximum area scan spatial resolution: Δx_{Area} , Δy_{Area}		≤ 2 GHz: ≤ 15 mm 2 – 3 GHz: ≤ 12 mm	3 – 4 GHz: ≤ 12 mm 4 – 6 GHz: ≤ 10 mm
		When the x or y dimension of the test device, in the measurement plane orientation, is smaller than the above, the measurement resolution must be \leq the corresponding x or y dimension of the test device with at least one measurement point on the test device.	
Maximum zoom scan spatial resolution: Δx_{Zoom} , Δy_{Zoom}		≤ 2 GHz: ≤ 8 mm 2 – 3 GHz: ≤ 5 mm*	3 – 4 GHz: ≤ 5 mm* 4 – 6 GHz: ≤ 4 mm*
Maximum zoom scan spatial resolution, normal to phantom surface	uniform grid: $\Delta z_{Zoom}(n)$	≤ 5 mm	3 – 4 GHz: ≤ 4 mm 4 – 5 GHz: ≤ 3 mm 5 – 6 GHz: ≤ 2 mm
	graded grid	$\Delta z_{Zoom}(1)$: between 1 st two points closest to phantom surface	≤ 4 mm
		$\Delta z_{Zoom}(n>1)$: between subsequent points	$\leq 1.5 \cdot \Delta z_{Zoom}(n-1)$
Minimum zoom scan volume	x, y, z	≥ 30 mm	3 – 4 GHz: ≥ 28 mm 4 – 5 GHz: ≥ 25 mm 5 – 6 GHz: ≥ 22 mm
Note: δ is the penetration depth of a plane-wave at normal incidence to the tissue medium; see draft standard IEEE P1528-2011 for details.			
* When zoom scan is required and the <i>reported</i> SAR from the area scan based 1-g SAR estimation procedures of KDB 447498 is ≤ 1.4 W/kg, ≤ 8 mm, ≤ 7 mm and ≤ 5 mm zoom scan resolution may be applied, respectively, for 2 GHz to 3 GHz, 3 GHz to 4 GHz and 4 GHz to 6 GHz.			

9.3 WCDMA Measurement Procedures for SAR

The following procedures are applicable to WCDMA handsets operating under 3GPP Release99, Release 5 and Release 6. The default test configuration is to measure SAR with an established radio link between the DUT and a communication test set using a 12.2kbps RMC (reference measurement channel) configured in Test Loop Mode 1. SAR is selectively confirmed for other physical channel configurations (DPCCH & DPDCH_n), HSDPA and HSPA (HSUPA/HSDPA) modes according to output power, exposure conditions and device operating capabilities. Both uplink and downlink should be configured with the same RMC or AMR, when required. SAR for Release 5 HSDPA and Release 6 HSPA are measured using the applicable FRC (fixed reference channel) and E-DCH reference channel configurations. Maximum output power is verified according to applicable versions of 3GPP TS 34.121 and SAR must be measured according to these maximum output conditions. When Maximum Power Reduction (MPR) is not implemented according to Cubic Metric (CM) requirements for Release 6 HSPA, the following procedures do not apply.

For Release 5 HSDPA Data Devices:

Sub-test	β_c	β_d	β_d (SF)	β_c / β_d	β_{hs}	CM/dB
1	2/15	15/15	64	2/15	4/15	0.0
2	12/15	15/15	64	12/15	24/25	1.0
3	15/15	8/15	64	15/8	30/15	1.5
4	15/15	4/15	64	15/4	30/15	1.5

For Release 6 HSPA Data Devices

Sub-test	β_c	β_d	β_d (SF)	β_c / β_d	β_{hs}	β_{ec}	β_{ed}	β_{ed} (SF)	β_{ed} (codes)	CM (dB)	MPR (dB)	AG Index	E-TFCI
1	11/15	15/15	64	11/15	22/15	209/225	1039/225	4	1	1.5	1.5	20	75
2	6/15	15/15	64	6/15	12/15	12/15	12/15	4	1	1.5	1.5	12	67
3	15/15	9/15	64	15/9	30/15	30/15	$\beta_{ed1}:47/15$ $\beta_{ed2}:47/15$	4	2	1.5	1.5	15	92
4	2/15	15/15	64	2/15	4/15	4/15	56/75	4	1	1.5	1.5	17	71
5	15/15	15/15	64	15/15	24/15	30/15	134/15	4	1	1.5	1.5	21	81

Rel.8 DC-HSDPA (Cat 24)

SAR test exclusion for Rel.8 DC-HSDPA must satisfy the SAR test exclusion requirements of Rel.5 HSDPA. SAR test exclusion for DC-HSDPA devices is determined by power measurements according to the H-Set 12, Fixed Reference Channel (FRC) configuration in Table C.8.1.12 of 3GPP TS 34.121-1. A primary and a secondary serving HS-DSCH Cell are required to perform the power measurement and for the results to qualify for SAR test exclusion.

9.4 SAR Measurement for LTE

SAR tests for LTE are performed with a base station simulator, Rohde & Schwarz CMW500. Closed loop power control was used so the UE transmits with maximum output power during SAR testing. All powers were measured with the CMW 500.

It is performed for conducted power and SAR based on the KDB941225 D05.

SAR is evaluated separately according to the following procedures for the different test positions in each exposure condition – head, body, body-worn accessories and other use conditions. The procedures in the following subsections are applied separately to test each LTE frequency band.

1) QPSK with 1 RB allocation

Start with the largest channel bandwidth and measure SAR for QPSK with 1 RB allocation, using the RB offset and required test channel combination with the highest maximum output power among RB offsets at the upper edge, middle and lower edge of each required test channel. When the reported SAR is ≤ 0.8 W/kg, testing of the remaining RB offset configurations and required test channels is not required for 1 RB allocation; otherwise, SAR is required for the remaining required test channels and only for the RB offset configuration with the highest output power for that channel. When the reported SAR of a required test channel is > 1.45 W/kg, SAR is required for all three RB offset configurations for that required test channel.

2) QPSK with 50% RB allocation

The procedures required for 1 RB allocation in 1) are applied to measure the SAR for QPSK with 50% RB allocation.

3) QPSK with 100% RB allocation

For QPSK with 100% RB allocation, SAR is not required when the highest maximum output power for 100 % RB allocation is less than the highest maximum output power in 50% and 1 RB allocations and the highest reported SAR for 1 RB and 50% RB allocation in 1) and 2) are ≤ 0.8 W/kg. Otherwise, SAR is measured for the highest output power channel; and if the reported SAR is > 1.45 W/kg, the remaining required test channels must also be tested.

9.5 Bluetooth & Wi-Fi Measurement Procedures for SAR

Normal network operating configurations are not suitable for measuring the SAR of 802.11 transmitters in general. Unpredictable fluctuations in network traffic and antenna diversity conditions can introduce undesirable variations in SAR results. The SAR for these devices should be measured using chipset based test mode software to ensure that the results are consistent and reliable.

Chipset based test mode software is hardware dependent and generally varies among manufacturers. The device operating parameters established in a test mode for SAR measurements must be identical to those programmed in production units, including output power levels, amplifier gain settings and other RF performance tuning parameters. The test frequencies should correspond to actual channel frequencies defined for domestic use. SAR for devices with switched diversity should be measured with only one antenna transmitting at a time during each SAR measurement, according to a fixed modulation and data rate. The same data pattern should be used for all measurements.

9.6 Power Drift

To control the output power stability during the SAR test, DASY5 system calculates the power drift by measuring the E-field at the same location at the beginning and at the end of the measurement for each test position. These drift values can be found in section 14 labeled as: (Power Drift [dB]). This ensures that the power drift during one measurement is within 5%.

10 Area Scan Based 1-g SAR

10.1 Requirement of KDB

According to the KDB447498 D01 v06, when the implementation is based the specific polynomial fit algorithm as presented at the 29th Bioelectromagnetics Society meeting (2007) and the estimated 1-gSAR is ≤ 1.2 W/kg, a zoom scan measurement is not required provided it is also not needed for any other purpose; for example, if the peak SAR location required for simultaneous transmission SAR test exclusion can be determined accurately by the SAR system or manually to discriminate between distinctive peaks and scattered noisy SAR distributions from area scans.

There must not be any warning or alert messages due to various measurement concerns identified by the SAR system; for example, noise in measurements, peaks too close to scan boundary, peaks are too sharp, spatial resolution and uncertainty issues etc. The SAR system verification must also demonstrate that the area scan estimated 1-g SAR is within 3% of the zoom scan 1-g SAR (See Annex B). When all the SAR results for each exposure condition in a frequency band and wireless mode are based on estimated 1-g SAR, the 1-g SAR for the highest SAR configuration must be determined by a zoom scan.

10.2 Fast SAR Algorithms

The approach is based on the area scan measurement applying a frequency dependent attenuation parameter. This attenuation parameter was empirically determined by analyzing a large number of phones. The MOTOROLA FAST SAR was developed and validated by the MOTOROLA Research Group in Ft. Lauderdale.

In the initial study, an approximation algorithm based on Linear fit was developed. The accuracy of the algorithm has been demonstrated across a broad frequency range (136-2450 MHz) and for both 1- and 10-g averaged SAR using a sample of 264 SAR measurements from 55 wireless handsets. For the sample size studied, the root-mean-squared errors of the algorithm are 1.2% and 5.8% for 1- and 10-g averaged SAR, respectively. The paper describing the algorithm in detail is expected to be published in August 2004 within the Special Issue of Transactions on MTT.

In the second step, the same research group optimized the fitting algorithm to an Polynomial fit whereby the frequency validity was extended to cover the range 30-6000MHz. Details of this study can be found in the BEMS 2007 Proceedings.

Both algorithms are implemented in DASY software.

11 Conducted Output Power

11.1 GSM Measurement result

During the process of testing, the EUT was controlled via Agilent Digital Radio Communication tester (E5515C) to ensure the maximum power transmission and proper modulation. This result contains conducted output power for the EUT. In all cases, the measured peak output power should be greater and within 5% than EMI measurement.

Table 11.1-1: The conducted power measurement results for GSM, GPRS and EGPRS

GSM 850 Speech (GMSK)	Measured Power (dBm)			Tune up	calculation	Averaged Power (dBm)		
	251	190	128			251	190	128
1 Txslot	33.19	33.32	33.27	34.00	/	/	/	/
GSM 850 GPRS (GMSK)	Measured Power (dBm)				calculation	Averaged Power (dBm)		
	251	190	128			251	190	128
1 Txslot	33.23	33.30	33.22	34.00	-9.03	24.20	24.27	24.19
2 Txslots	32.18	32.27	32.19	33.00	-6.02	26.16	26.25	26.17
3Txslots	30.12	30.22	30.14	31.00	-4.26	25.86	25.96	25.88
4 Txslots	28.96	29.04	28.94	30.00	-3.01	25.95	26.03	25.93
GSM 850 EGPRS (GMSK)	Measured Power (dBm)				calculation	Averaged Power (dBm)		
	251	190	128			251	190	128
1 Txslot	33.11	33.22	33.16	34.00	-9.03	24.08	24.19	24.13
2 Txslots	32.10	32.20	32.14	33.00	-6.02	26.08	26.18	26.12
3Txslots	30.04	30.15	30.09	31.00	-4.26	25.78	25.89	25.83
4 Txslots	28.89	28.98	28.89	30.00	-3.01	25.88	25.97	25.88
GSM 850 EGPRS (8PSK)	Measured Power (dBm)				calculation	Averaged Power (dBm)		
	251	190	128			251	190	128
1 Txslot	27.50	27.20	27.09	28.00	-9.03	18.47	18.17	18.06
2 Txslots	26.13	25.88	26.22	27.00	-6.02	20.11	19.86	20.20
3Txslots	23.75	24.58	23.58	25.00	-4.26	19.49	20.32	19.32
4 Txslots	23.57	22.54	22.11	24.00	-3.01	20.56	19.53	19.10

NOTES:

1) Division Factors

To average the power, the division factor is as follows:

1TX-slot = 1 transmit time slot out of 8 time slots=> conducted power divided by (8/1) => -9.03dB

2TX-slots = 2 transmit time slots out of 8 time slots=> conducted power divided by (8/2) => -6.02dB

3TX-slots = 3 transmit time slots out of 8 time slots=> conducted power divided by (8/3) => -4.26dB

4TX-slots = 4 transmit time slots out of 8 time slots=> conducted power divided by (8/4) => -3.01dB

According to the conducted power as above, the body measurements are performed with 2Txslots for GSM850.

Table 11.1-2: The conducted power measurement results for GSM, GPRS and EGPRS

PCS1900 Speech (GMSK)	Measured Power (dBm)			Tune up	calculation	Averaged Power (dBm)		
	810	661	512			810	661	512
1 Txslot	30.25	30.04	30.16	30.50	/	/	/	/
PCS1900 GPRS (GMSK)	Measured Power (dBm)				calculation	Averaged Power (dBm)		
	810	661	512			810	661	512
1 Txslot	30.22	30.01	30.14	30.50	-9.03	21.19	20.98	21.11
2 Txslots	29.26	29.04	29.19	29.50	-6.02	23.24	23.02	23.17
3Txslots	27.27	27.03	27.16	27.50	-4.26	23.01	22.77	22.90
4 Txslots	26.13	25.91	26.03	26.50	-3.01	23.12	22.90	23.02
PCS1900 EGPRS (GMSK)	Measured Power (dBm)				calculation	Averaged Power (dBm)		
	810	661	512			810	661	512
1 Txslot	30.19	30.01	30.13	30.50	-9.03	21.16	20.98	21.10
2 Txslots	29.23	29.04	29.18	29.50	-6.02	23.21	23.02	23.16
3Txslots	27.23	27.02	27.16	27.50	-4.26	22.97	22.76	22.90
4 Txslots	26.11	25.90	26.04	26.50	-3.01	23.10	22.89	23.03
PCS1900 EGPRS (8PSK)	Measured Power (dBm)				calculation	Averaged Power (dBm)		
	810	661	512			810	661	512
1 Txslot	26.40	26.66	26.52	27.00	-9.03	17.37	17.63	17.49
2 Txslots	25.23	25.43	25.47	26.00	-6.02	19.21	19.41	19.45
3Txslots	23.07	23.32	23.44	24.00	-4.26	18.81	19.06	19.18
4 Txslots	21.95	22.14	22.26	23.00	-3.01	18.94	19.13	19.25

NOTES:

1) Division Factors

To average the power, the division factor is as follows:

1TX-slot = 1 transmit time slot out of 8 time slots=> conducted power divided by (8/1) => -9.03dB

2TX-slots = 2 transmit time slots out of 8 time slots=> conducted power divided by (8/2) => -6.02dB

3TX-slots = 3 transmit time slots out of 8 time slots=> conducted power divided by (8/3) => -4.26dB

4TX-slots = 4 transmit time slots out of 8 time slots=> conducted power divided by (8/4) => -3.01dB

According to the conducted power as above, the body measurements are performed with 2Txslots for GSM1900.

11.2 WCDMA Measurement result
Table 11.2-1: The conducted Power for WCDMA

Item	band	FDDV result			
	ARFCN	4233 (846.6MHz)	4182 (836.4MHz)	4132 (826.4MHz)	Tune up
WCDMA	\	24.26	24.43	24.53	25.00
HSUPA	1	22.27	22.43	22.48	22.50
	2	21.85	22.02	22.12	22.50
	3	22.62	22.78	22.79	23.50
	4	21.41	21.44	21.67	22.00
	5	22.82	22.99	23.10	23.50
DC-HSDPA	1	23.03	23.07	23.17	24.50
	2	22.89	22.93	23.05	24.50
	3	22.44	22.54	22.65	24.00
	4	22.45	22.52	22.64	24.00
Item	band	FDDIV result			
	ARFCN	1513 (1752.6MHz)	1412(1732.4MHz)	1312 (1712.4MHz)	Tune up
WCDMA	\	23.47	23.37	23.26	24.00
HSUPA	1	21.41	21.36	21.19	21.50
	2	20.92	20.87	20.74	21.50
	3	21.95	21.89	21.77	22.50
	4	20.48	20.44	20.39	21.00
	5	21.93	21.90	21.78	22.50
DC-HSDPA	1	22.01	21.90	21.91	23.50
	2	21.92	21.85	21.80	23.50
	3	21.49	21.28	21.35	23.00
	4	21.5	21.30	21.33	23.00
Item	band	FDDII result			
	ARFCN	9538 (1907.6MHz)	9400 (1880MHz)	9262 (1852.4MHz)	Tune up
WCDMA	\	22.59	22.64	22.97	23.50
HSUPA	1	20.71	20.56	20.98	21.00
	2	20.13	20.17	20.49	21.00
	3	21.2	21.16	21.49	22.00
	4	19.88	19.84	19.99	20.50
	5	21.16	21.15	21.48	22.00
DC-HSDPA	1	21.2	21.35	21.60	23.00
	2	21.11	21.24	21.54	23.00
	3	20.59	20.79	21.07	22.50
	4	20.58	20.76	21.05	22.50

11.3 LTE Measurement result

Table 13.3-1: Maximum Power Reduction (MPR) for LTE

Modulation	Channel bandwidth / Transmission bandwidth configuration [RB]						MPR (dB)
	1.4 MHz	3 MHz	5 MHz	10 MHz	15 MHz	20 MHz	
QPSK	> 5	> 4	> 8	> 12	> 16	> 18	1
16 QAM	≤ 5	≤ 4	≤ 8	≤ 12	≤ 16	≤ 18	1
16 QAM	> 5	> 4	> 8	> 12	> 16	> 18	2
64 QAM	≤ 5	≤ 4	≤ 8	≤ 12	≤ 16	≤ 18	2
64 QAM	> 5	> 4	> 8	> 12	> 16	> 18	3

Table 13.3-2: The tune up for LTE

Band	Tune up
LTE Band 2	23.5
LTE Band 4	23.5
LTE Band 5	25
LTE Band 7	23.5
LTE Band 12	25
LTE Band 66	23.5

Band 2						
Bandwidth (MHz)	RB allocation RB offset (Start RB)	Frequency (MHz)	QPSK	16QAM	64QAM	
			Actual output power (dBm)	Actual output power (dBm)	Actual output power (dBm)	
1.4 MHz	1RB High (5)	1909.3	22.44	21.66	20.57	
		1880	22.22	21.47	20.39	
		1850.7	21.96	21.34	20.13	
	1RB Middle (3)	1909.3	22.52	21.87	20.66	
		1880	22.34	21.55	20.54	
		1850.7	22.07	21.47	20.30	
	1RB Low (0)	1909.3	22.33	21.73	20.62	
		1880	22.23	21.60	20.42	
		1850.7	21.96	21.28	20.14	
	3RB High (3)	1909.3	22.43	21.44	20.61	
		1880	22.30	21.27	20.40	
		1850.7	22.08	21.10	20.08	
	3RB Middle (1)	1909.3	22.45	21.47	20.65	
		1880	22.34	21.33	20.43	
		1850.7	22.13	21.13	20.12	
	3RB Low (0)	1909.3	22.44	21.48	20.62	
		1880	22.33	21.23	20.38	
		1850.7	22.10	21.08	20.08	
	6RB (0)	1909.3	21.42	20.57	19.55	
		1880	21.28	20.35	19.34	
		1850.7	21.04	20.10	19.08	
	3 MHz	1RB High (14)	1908.5	22.53	21.83	20.65
			1880	22.23	21.64	20.50
			1851.5	22.11	21.37	20.18
1RB Middle (7)		1908.5	22.65	22.03	20.69	
		1880	22.37	21.81	20.47	
		1851.5	22.21	21.45	20.36	
1RB Low (0)		1908.5	22.43	21.80	20.65	
		1880	22.18	21.66	20.47	
		1851.5	22.00	21.32	20.12	
8RB High (7)		1908.5	21.50	20.61	19.64	
		1880	21.30	20.36	19.41	
		1851.5	21.01	20.15	19.09	
8RB Middle (4)		1908.5	21.52	20.62	19.55	
		1880	21.37	20.41	19.34	
		1851.5	21.02	20.08	19.13	
8RB Low (0)		1908.5	21.49	20.59	19.61	
		1880	21.19	20.36	19.25	
		1851.5	21.06	20.05	19.10	
15RB (0)		1908.5	21.53	20.54	19.56	
		1880	21.31	20.34	19.33	
		1851.5	20.94	20.00	19.07	

5 MHz	1RB High (24)	1907.5	22.45	21.69	20.57
		1880	22.16	21.47	20.30
		1852.5	21.94	21.25	20.13
	1RB Middle (12)	1907.5	22.66	21.97	20.79
		1880	22.48	21.77	20.63
		1852.5	22.20	21.55	20.40
	1RB Low (0)	1907.5	22.36	21.76	20.54
		1880	22.15	21.58	20.24
		1852.5	21.93	21.14	20.08
	12RB High (13)	1907.5	21.52	20.47	19.53
		1880	21.32	20.23	19.30
		1852.5	21.07	20.06	19.12
	12RB Middle (6)	1907.5	21.54	20.55	19.54
		1880	21.32	20.28	19.38
		1852.5	21.06	20.08	19.13
	12RB Low (0)	1907.5	21.46	20.46	19.53
		1880	21.24	20.23	19.28
		1852.5	21.01	19.99	19.05
25RB (0)	1907.5	21.48	20.46	19.54	
	1880	21.27	20.27	19.31	
	1852.5	21.03	20.02	19.09	
10 MHz	1RB High (49)	1905	22.58	21.73	20.67
		1880	22.30	21.65	20.43
		1855	22.24	21.49	20.42
	1RB Middle (24)	1905	22.64	21.85	20.65
		1880	22.41	21.72	20.53
		1855	22.20	21.54	20.36
	1RB Low (0)	1905	22.52	21.80	20.58
		1880	22.26	21.59	20.42
		1855	22.06	21.38	20.21
	25RB High (25)	1905	21.53	20.47	19.55
		1880	21.34	20.35	19.38
		1855	21.19	20.19	19.27
	25RB Middle (12)	1905	21.56	20.53	19.56
		1880	21.31	20.33	19.35
		1855	21.18	20.15	19.22
	25RB Low (0)	1905	21.58	20.58	19.62
		1880	21.35	20.33	19.38
		1855	21.07	20.08	19.10
50RB (0)	1905	21.55	20.53	19.56	
	1880	21.31	20.31	19.36	
	1855	21.11	20.11	19.19	
15 MHz	1RB High (74)	1902.5	22.59	21.72	20.62
		1880	22.35	21.64	20.42
		1857.5	22.18	21.50	20.30
	1RB Middle (37)	1902.5	22.58	21.69	20.69
		1880	22.38	21.74	20.55
		1857.5	22.26	21.51	20.47

	1RB Low (0)	1902.5	22.43	21.71	20.48
		1880	22.26	21.53	20.35
		1857.5	22.06	21.27	20.17
	36RB High (38)	1902.5	21.57	20.49	19.54
		1880	21.39	20.34	19.37
		1857.5	21.29	20.24	19.31
	36RB Middle (19)	1902.5	21.65	20.55	19.62
		1880	21.40	20.35	19.41
		1857.5	21.30	20.27	19.31
	36RB Low (0)	1902.5	21.66	20.56	19.61
		1880	21.43	20.35	19.42
		1857.5	21.16	20.12	19.18
	75RB (0)	1902.5	21.65	20.55	19.61
		1880	21.41	20.36	19.41
		1857.5	21.22	20.21	19.23
20 MHz	1RB High (99)	1900	22.43	21.62	20.48
		1880	22.27	21.48	20.39
		1860	22.16	21.36	20.32
	1RB Middle (50)	1900	22.70	21.95	20.84
		1880	22.62	21.78	20.70
		1860	22.55	21.96	20.62
	1RB Low (0)	1900	22.33	21.66	20.44
		1880	22.23	21.49	20.39
		1860	21.97	21.31	20.06
	50RB High (50)	1900	21.59	20.53	19.57
		1880	21.59	20.54	19.57
		1860	21.27	20.27	19.28
	50RB Middle (25)	1900	21.72	20.67	19.69
		1880	21.52	20.48	19.51
		1860	21.39	20.41	19.44
	50RB Low (0)	1900	21.69	20.64	19.66
		1880	21.62	20.56	19.59
		1860	21.29	20.27	19.29
	100RB (0)	1900	21.67	20.59	19.67
		1880	21.58	20.54	19.53
		1860	21.32	20.28	19.31

Band 4					
Bandwidth (MHz)	RB allocation	Frequency (MHz)	Actual output power (dBm)		
	RB offset		QPSK	16QAM	64QAM
1.4 MHz	1RB_High	1754.3	23.09	22.43	21.24
		1732.5	23.06	22.32	21.32
		1710.7	23.06	22.42	21.20
	1RB_Middle	1754.3	23.24	22.41	21.40
		1732.5	23.16	22.33	21.36
		1710.7	23.14	22.39	21.46
	1RB_Low	1754.3	23.10	22.44	21.24
		1732.5	23.05	22.39	21.30
		1710.7	23.06	22.40	21.28
	3RB_High	1754.3	23.22	22.19	21.26
		1732.5	23.17	22.21	21.30
		1710.7	23.18	22.16	21.23
	3RB_Middle	1754.3	23.24	22.28	21.39
		1732.5	23.23	22.17	21.36
		1710.7	23.21	22.23	21.27
	3RB_Low	1754.3	23.18	22.18	21.25
		1732.5	23.16	22.14	21.24
		1710.7	23.16	22.17	21.23
	6RB	1754.3	22.16	21.27	20.24
		1732.5	22.15	21.26	20.13
		1710.7	22.16	21.25	20.17
3 MHz	1RB_High	1753.5	23.10	22.47	21.36
		1732.5	23.13	22.39	21.36
		1711.5	23.13	22.37	21.30
	1RB_Middle	1753.5	23.25	22.43	21.45
		1732.5	23.28	22.38	21.47
		1711.5	23.31	22.31	21.47
	1RB_Low	1753.5	23.21	22.44	21.35
		1732.5	23.11	22.38	21.32
		1711.5	23.11	22.41	21.29
	8RB_High	1753.5	22.19	21.24	20.27
		1732.5	22.16	21.22	20.19
		1711.5	22.15	21.21	20.17
	8RB_Middle	1753.5	22.23	21.28	20.29
		1732.5	22.18	21.25	20.23
		1711.5	22.20	21.25	20.22
	8RB_Low	1753.5	22.21	21.28	20.24
		1732.5	22.17	21.22	20.21
		1711.5	22.15	21.24	20.18
	15RB	1753.5	22.20	21.21	20.18
		1732.5	22.13	21.15	20.14
		1711.5	22.14	21.18	20.15

5 MHz	1RB_High	1752.5	23.01	22.30	21.29
		1732.5	23.01	22.35	21.27
		1712.5	22.97	22.36	21.17
	1RB_Middle	1752.5	23.34	22.47	21.47
		1732.5	23.27	22.46	21.43
		1712.5	23.27	22.36	21.50
	1RB_Low	1752.5	23.08	22.47	21.33
		1732.5	23.00	22.41	21.25
		1712.5	23.00	22.32	21.23
	12RB_High	1752.5	22.14	21.12	20.19
		1732.5	22.18	21.16	20.10
		1712.5	22.12	21.12	20.13
	12RB_Middle	1752.5	22.25	21.24	20.24
		1732.5	22.22	21.20	20.22
		1712.5	22.20	21.19	20.21
	12RB_Low	1752.5	22.21	21.20	20.21
		1732.5	22.19	21.16	20.16
		1712.5	22.14	21.10	20.11
	25RB	1752.5	22.19	21.20	20.18
		1732.5	22.18	21.19	20.14
		1712.5	22.13	21.14	20.13
10MHz	1RB_High	1750	23.10	22.43	21.35
		1732.5	23.10	22.45	21.30
		1715	23.06	22.35	21.39
	1RB_Middle	1750	23.27	22.43	21.43
		1732.5	23.20	22.46	21.36
		1715	23.20	22.40	21.38
	1RB_Low	1750	23.16	22.46	21.35
		1732.5	23.09	22.49	21.35
		1715	23.07	22.35	21.31
	25RB_High	1750	22.19	21.22	20.19
		1732.5	22.22	21.23	20.17
		1715	22.12	21.12	20.10
	25RB_Middle	1750	22.24	21.25	20.21
		1732.5	22.20	21.21	20.18
		1715	22.15	21.16	20.14
	25RB_Low	1750	22.17	21.17	20.18
		1732.5	22.22	21.24	20.20
		1715	22.15	21.12	20.11
	50RB	1750	22.23	21.22	20.20
		1732.5	22.21	21.21	20.15
		1715	22.12	21.11	20.10
15MHz	1RB_High	1747.5	23.03	22.40	21.25
		1732.5	23.06	22.31	21.26
		1717.5	22.98	22.36	21.29
	1RB_Middle	1747.5	23.15	22.47	21.38
		1732.5	23.12	22.47	21.30
		1717.5	23.08	22.49	21.21

	1RB_Low	1747.5	23.04	22.40	21.28
		1732.5	22.99	22.31	21.23
		1717.5	23.03	22.41	21.17
	36RB_High	1747.5	22.22	21.21	20.24
		1732.5	22.21	21.19	20.16
		1717.5	22.15	21.10	20.10
	36RB_Middle	1747.5	22.21	21.19	20.21
		1732.5	22.20	21.16	20.16
		1717.5	22.13	21.08	20.14
	36RB_Low	1747.5	22.18	21.12	20.15
		1732.5	22.18	21.14	20.18
		1717.5	22.15	21.10	20.12
	75RB	1747.5	22.18	21.19	20.17
		1732.5	22.21	21.21	20.15
		1717.5	22.11	21.09	20.08
20MHz	1RB_High	1745	22.87	22.20	21.07
		1732.5	22.85	22.12	21.01
		1720	22.84	22.19	21.09
	1RB_Middle	1745	23.26	22.41	21.47
		1732.5	23.20	22.39	21.49
		1720	23.19	22.31	21.38
	1RB_Low	1745	22.89	22.23	21.12
		1732.5	22.82	22.23	21.05
		1720	22.84	22.24	21.01
	50RB_High	1745	22.26	21.27	20.28
		1732.5	22.23	21.24	20.19
		1720	22.10	21.07	20.05
	50RB_Middle	1745	22.22	21.20	20.21
		1732.5	22.22	21.22	20.18
		1720	22.13	21.14	20.12
	50RB_Low	1745	22.12	21.13	20.12
		1732.5	22.21	21.24	20.25
		1720	22.14	21.15	20.15
	100RB	1745	22.21	21.21	20.22
		1732.5	22.24	21.25	20.24
		1720	22.14	21.11	20.10

Band 5						
Bandwidth (MHz)	RB allocation RB offset (Start RB)	Frequency (MHz)	QPSK	16QAM	64QAM	
			Actual output power (dBm)	Actual output power (dBm)	Actual output power (dBm)	
1.4 MHz	1RB High (5)	848.3	23.87	23.04	22.05	
		836.5	24.07	23.39	22.30	
		824.7	24.17	23.38	22.37	
	1RB Middle (3)	848.3	23.99	23.32	22.15	
		836.5	24.19	23.43	22.46	
		824.7	24.31	23.58	22.47	
	1RB Low (0)	848.3	23.86	23.22	22.13	
		836.5	24.08	23.37	22.34	
		824.7	24.22	23.47	22.43	
	3RB High (3)	848.3	23.93	22.93	22.00	
		836.5	24.16	23.15	22.26	
		824.7	24.30	23.25	22.36	
	3RB Middle (1)	848.3	23.97	22.96	22.14	
		836.5	24.22	23.27	22.40	
		824.7	24.35	23.35	22.45	
	3RB Low (0)	848.3	23.92	22.87	22.05	
		836.5	24.19	23.12	22.30	
		824.7	24.30	23.25	22.35	
	6RB (0)	848.3	22.94	22.02	20.98	
		836.5	23.19	22.30	21.24	
		824.7	23.29	22.40	21.35	
	3 MHz	1RB High (14)	847.5	23.90	23.21	22.12
			836.5	24.13	23.42	22.31
			825.5	24.26	23.46	22.38
1RB Middle (7)		847.5	24.10	23.32	22.33	
		836.5	24.31	23.57	22.45	
		825.5	24.38	23.60	22.63	
1RB Low (0)		847.5	23.94	23.17	22.17	
		836.5	24.15	23.35	22.34	
		825.5	24.25	23.49	22.50	
8RB High (7)		847.5	22.90	21.96	21.04	
		836.5	23.20	22.29	21.30	
		825.5	23.24	22.32	21.39	
8RB Middle (4)		847.5	22.99	22.06	21.09	
		836.5	23.24	22.31	21.33	
		825.5	23.31	22.35	21.42	
8RB Low (0)		847.5	23.00	22.09	21.10	
		836.5	23.20	22.26	21.29	
		825.5	23.28	22.35	21.41	
15RB (0)		847.5	22.93	21.95	20.96	
		836.5	23.21	22.22	21.26	
		825.5	23.30	22.30	21.32	

5 MHz	1RB High (24)	846.5	23.76	23.13	21.90	
		836.5	24.00	23.25	22.31	
		826.5	24.10	23.35	22.29	
	1RB Middle (12)	846.5	24.13	23.47	22.32	
		836.5	24.27	23.67	22.50	
		826.5	24.37	23.67	22.57	
	1RB Low (0)	846.5	23.87	23.20	22.08	
		836.5	24.05	23.41	22.27	
		826.5	24.13	23.50	22.34	
	12RB High (13)	846.5	22.88	21.87	20.95	
		836.5	23.19	22.20	21.29	
		826.5	23.27	22.27	21.35	
	12RB Middle (6)	846.5	23.06	22.06	21.16	
		836.5	23.25	22.29	21.36	
		826.5	23.30	22.27	21.39	
	12RB Low (0)	846.5	23.04	22.02	21.13	
		836.5	23.20	22.22	21.30	
		826.5	23.26	22.25	21.33	
	25RB (0)	846.5	23.00	22.01	21.07	
		836.5	23.22	22.25	21.31	
		826.5	23.29	22.27	21.32	
	10 MHz	1RB High (49)	844	24.28	23.56	22.61
			836.5	24.50	23.72	22.76
			829	24.57	23.82	22.79
1RB Middle (24)		844	24.52	23.87	22.75	
		836.5	24.64	23.96	22.92	
		829	24.72	23.94	22.99	
1RB Low (0)		844	24.51	23.77	22.75	
		836.5	24.59	23.83	22.81	
		829	24.67	23.95	22.99	
25RB High (25)		844	23.40	22.43	21.45	
		836.5	23.69	22.72	21.68	
		829	23.75	22.73	21.74	
25RB Middle (12)		844	23.56	22.56	21.55	
		836.5	23.69	22.73	21.70	
		829	23.78	22.78	21.77	
25RB Low (0)		844	23.66	22.66	21.65	
		836.5	23.73	22.76	21.73	
		829	23.79	22.76	21.76	
50RB (0)		844	23.55	22.55	21.55	
		836.5	23.75	22.73	21.72	
		829	23.79	22.76	21.77	

Band 7						
Bandwidth (MHz)	RB allocation RB offset (Start RB)	Frequency (MHz)	QPSK	16QAM	64QAM	
			Actual output power (dBm)	Actual output power (dBm)	Actual output power (dBm)	
5 MHz	1RB High (24)	2567.5	23.04	22.35	21.29	
		2535	22.72	21.97	21.01	
		2502.5	22.58	22.01	20.87	
	1RB Middle (12)	2567.5	23.25	22.41	21.50	
		2535	22.99	22.31	21.15	
		2502.5	22.77	22.15	21.10	
	1RB Low (0)	2567.5	23.03	22.31	21.28	
		2535	22.68	22.12	20.93	
		2502.5	22.59	21.95	20.85	
	12RB High (13)	2567.5	22.19	21.21	20.28	
		2535	21.84	20.85	19.89	
		2502.5	21.71	20.75	19.79	
	12RB Middle (6)	2567.5	22.23	21.28	20.31	
		2535	21.88	20.87	19.96	
		2502.5	21.76	20.79	19.81	
	12RB Low (0)	2567.5	22.21	21.23	20.29	
		2535	21.82	20.85	19.89	
		2502.5	21.68	20.70	19.78	
	25RB (0)	2567.5	22.18	21.24	20.26	
		2535	21.83	20.85	19.87	
		2502.5	21.68	20.71	19.74	
	10 MHz	1RB High (49)	2565	23.14	22.37	21.38
			2535	22.82	22.13	21.08
			2505	22.67	22.01	20.92
1RB Middle (24)		2565	23.21	22.47	21.41	
		2535	22.87	22.18	21.06	
		2505	22.79	22.22	20.97	
1RB Low (0)		2565	23.12	22.45	21.33	
		2535	22.81	22.21	21.00	
		2505	22.66	21.89	20.91	
25RB High (25)		2565	22.21	21.27	20.28	
		2535	21.87	20.88	19.91	
		2505	21.74	20.80	19.81	
25RB Middle (12)		2565	22.22	21.25	20.29	
		2535	21.86	20.87	19.92	
		2505	21.72	20.77	19.77	
25RB Low (0)		2565	22.25	21.29	20.31	
		2535	21.90	20.95	19.99	
		2505	21.68	20.74	19.77	
50RB (0)		2565	22.24	21.25	20.30	
		2535	21.91	20.92	19.96	
		2505	21.72	20.76	19.78	

15 MHz	1RB High (74)	2562.5	23.06	22.28	21.29
		2535	22.77	22.02	21.05
		2507.5	22.55	21.90	20.84
	1RB Middle (37)	2562.5	23.14	22.42	21.39
		2535	22.82	22.11	21.04
		2507.5	22.67	22.12	20.95
	1RB Low (0)	2562.5	23.01	22.29	21.20
		2535	22.71	22.04	20.97
		2507.5	22.55	21.94	20.84
	36RB High (38)	2562.5	22.19	21.18	20.24
		2535	21.89	20.87	19.93
		2507.5	21.77	20.76	19.82
	36RB Middle (19)	2562.5	22.19	21.17	20.26
		2535	21.89	20.88	19.96
		2507.5	21.74	20.73	19.79
	36RB Low (0)	2562.5	22.17	21.17	20.22
		2535	21.88	20.92	19.97
		2507.5	21.70	20.71	19.74
75RB (0)	2562.5	22.18	21.18	20.19	
	2535	21.86	20.91	19.91	
	2507.5	21.71	20.74	19.77	
20 MHz	1RB High (99)	2560	22.81	22.08	21.07
		2535	22.59	21.96	20.87
		2510	22.45	21.88	20.64
	1RB Middle (50)	2560	23.17	22.41	21.40
		2535	22.88	22.31	21.17
		2510	22.84	22.19	21.03
	1RB Low (0)	2560	22.81	22.09	20.98
		2535	22.50	21.92	20.71
		2510	22.52	21.78	20.64
	50RB High (50)	2560	22.07	21.11	20.14
		2535	21.87	20.91	19.89
		2510	21.78	20.82	19.87
	50RB Middle (25)	2560	22.12	21.16	20.21
		2535	21.89	20.93	19.97
		2510	21.77	20.77	19.80
	50RB Low (0)	2560	22.04	21.05	20.09
		2535	21.90	20.92	19.97
		2510	21.72	20.75	19.78
100RB (0)	2560	22.06	21.06	20.10	
	2535	21.91	20.91	19.93	
	2510	21.73	20.77	19.81	

Band 12					
Bandwidth (MHz)	RB allocation	Frequency (MHz)	QPSK	16QAM	64QAM
	RB offset (Start RB)		Actual output power (dBm)	Actual output power (dBm)	Actual output power (dBm)
1.4 MHz	1RB High (5)	715.3	24.22	23.42	22.51
		707.5	24.23	23.45	22.50
		699.7	24.20	23.51	22.47
	1RB Middle (3)	715.3	24.31	23.53	22.57
		707.5	24.37	23.64	22.68
		699.7	24.30	23.64	22.53
	1RB Low (0)	715.3	24.25	23.57	22.48
		707.5	24.21	23.52	22.46
		699.7	24.11	23.38	22.42
	3RB High (3)	715.3	24.30	23.27	22.43
		707.5	24.30	23.27	22.48
		699.7	24.27	23.27	22.45
	3RB Middle (1)	715.3	24.34	23.29	22.49
		707.5	24.37	23.35	22.53
		699.7	24.28	23.24	22.48
	3RB Low (0)	715.3	24.30	23.32	22.49
		707.5	24.33	23.30	22.50
		699.7	24.23	23.25	22.47
	6RB (0)	715.3	23.31	22.47	21.29
		707.5	23.34	22.51	21.37
		699.7	23.26	22.39	21.32
3 MHz	1RB High (14)	714.5	24.29	23.60	22.55
		707.5	24.29	23.48	22.48
		700.5	24.27	23.54	22.49
	1RB Middle (7)	714.5	24.45	23.77	22.68
		707.5	24.39	23.63	22.69
		700.5	24.37	23.67	22.62
	1RB Low (0)	714.5	24.31	23.62	22.54
		707.5	24.31	23.54	22.54
		700.5	24.19	23.41	22.46
	8RB High (7)	714.5	23.32	22.41	21.43
		707.5	23.29	22.43	21.41
		700.5	23.30	22.39	21.41
	8RB Middle (4)	714.5	23.34	22.49	21.44
		707.5	23.34	22.51	21.46
		700.5	23.33	22.48	21.44
8RB Low (0)	714.5	23.35	22.48	21.44	
	707.5	23.34	22.44	21.44	
	700.5	23.24	22.40	21.38	
15RB (0)	714.5	23.35	22.40	21.38	
	707.5	23.31	22.40	21.38	

5 MHz	1RB High (24)	700.5	23.26	22.33	21.32
		713.5	24.17	23.40	22.44
		707.5	24.15	23.49	22.44
	1RB Middle (12)	701.5	24.19	23.55	22.43
		713.5	24.47	23.68	22.75
		707.5	24.45	23.63	22.65
	1RB Low (0)	701.5	24.44	23.65	22.66
		713.5	24.22	23.52	22.48
		707.5	24.21	23.50	22.51
	12RB High (13)	701.5	24.12	23.32	22.47
		713.5	23.30	22.34	21.34
		707.5	23.29	22.34	21.36
	12RB Middle (6)	701.5	23.29	22.32	21.39
		713.5	23.39	22.46	21.48
		707.5	23.38	22.40	21.45
	12RB Low (0)	701.5	23.35	22.43	21.42
		713.5	23.37	22.43	21.45
		707.5	23.29	22.35	21.37
	25RB (0)	701.5	23.32	22.38	21.40
		713.5	23.38	22.42	21.41
		707.5	23.28	22.36	21.35
10 MHz	1RB High (49)	701.5	23.36	22.37	21.38
		711	24.43	23.51	22.93
		707.5	24.25	23.90	22.98
	1RB Middle (24)	704	24.40	23.95	22.81
		711	24.45	23.62	22.98
		707.5	24.45	23.98	22.94
	1RB Low (0)	704	24.58	23.98	22.92
		711	24.38	23.63	22.89
		707.5	24.37	23.83	22.89
	25RB High (25)	704	24.23	23.89	23.00
		711	23.42	22.47	21.85
		707.5	23.36	22.75	21.83
	25RB Middle (12)	704	23.47	22.94	21.99
		711	23.65	22.76	21.97
		707.5	23.59	22.96	21.95
	25RB Low (0)	704	23.54	22.77	21.95
		711	23.55	22.79	22.00
		707.5	23.54	22.90	21.90
	50RB (0)	704	23.56	22.87	21.97
		711	23.71	22.86	21.94
		707.5	23.54	22.82	21.89
		704	23.43	22.95	21.91

Band 66					
Bandwidth (MHz)	RB allocation	Frequency (MHz)	QPSK	16QAM	64QAM
	RB offset (Start RB)		Actual output power (dBm)	Actual output power (dBm)	Actual output power (dBm)
1.4 MHz	1RB High (5)	1779.3	22.84	21.66	20.97
		1745	22.62	21.91	21.21
		1710.7	22.58	22.06	21.21
	1RB Middle (3)	1779.3	22.97	21.71	21.09
		1745	22.71	22.07	21.37
		1710.7	22.68	22.02	21.40
	1RB Low (0)	1779.3	22.84	21.68	21.05
		1745	22.55	21.95	21.26
		1710.7	22.59	21.88	21.23
	3RB High (3)	1779.3	22.98	21.43	21.02
		1745	22.69	21.66	21.26
		1710.7	22.69	21.76	21.25
	3RB Middle (1)	1779.3	22.89	21.41	21.11
		1745	22.72	21.76	21.27
		1710.7	22.74	21.78	21.28
	3RB Low (0)	1779.3	22.59	21.44	21.03
		1745	22.67	21.70	21.22
		1710.7	22.71	21.75	21.24
	6RB (0)	1779.3	22.02	20.81	20.02
		1745	21.63	21.01	20.20
		1710.7	21.66	21.25	20.21
3 MHz	1RB High (14)	1778.5	22.89	22.09	21.02
		1745	23.10	22.33	21.30
		1711.5	23.10	22.47	21.34
	1RB Middle (7)	1778.5	23.08	22.15	21.22
		1745	23.28	22.40	21.39
		1711.5	23.22	22.47	21.39
	1RB Low (0)	1778.5	22.92	22.10	21.08
		1745	23.07	22.30	21.25
		1711.5	23.02	22.27	21.20
	8RB High (7)	1778.5	21.92	20.99	20.01
		1745	22.10	21.19	20.24
		1711.5	22.10	21.19	20.21
	8RB Middle (4)	1778.5	21.94	20.99	20.05
		1745	22.14	21.20	20.25
		1711.5	22.15	21.21	20.24
	8RB Low (0)	1778.5	21.94	20.94	20.08
		1745	22.12	21.19	20.23
		1711.5	22.12	21.18	20.21
15RB (0)	1778.5	21.94	20.94	19.99	
	1745	22.10	21.15	20.19	

		1711.5	22.11	21.12	20.15
5 MHz	1RB High (24)	1777.5	22.80	21.95	20.98
		1745	23.02	22.36	21.17
		1712.5	22.99	22.30	21.23
		1777.5	23.07	22.29	21.28
	1RB Middle (12)	1745	23.21	22.43	21.42
		1712.5	23.24	22.44	21.47
		1777.5	22.85	22.13	21.02
	1RB Low (0)	1745	23.01	22.37	21.22
		1712.5	22.99	22.37	21.13
		1777.5	21.87	20.85	19.94
	12RB High (13)	1745	22.16	21.11	20.19
		1712.5	22.10	21.11	20.18
		1777.5	21.99	20.98	20.08
	12RB Middle (6)	1745	22.16	21.12	20.22
		1712.5	22.14	21.14	20.22
		1777.5	21.96	20.91	20.00
	12RB Low (0)	1745	22.09	21.07	20.14
		1712.5	22.08	21.06	20.16
		1777.5	21.97	20.92	19.99
	25RB (0)	1745	22.13	21.18	20.18
		1712.5	22.12	21.13	20.13
1775		22.90	22.07	21.05	
10 MHz	1RB High (49)	1745	23.11	22.36	21.34
		1715	23.03	22.39	21.20
		1775	23.06	22.28	21.21
	1RB Middle (24)	1745	23.23	22.38	21.38
		1715	23.18	22.42	21.38
		1775	23.02	22.27	21.19
	1RB Low (0)	1745	23.06	22.47	21.33
		1715	23.08	22.29	21.28
		1775	21.94	20.93	20.01
	25RB High (25)	1745	22.22	21.24	20.26
		1715	22.15	21.13	20.18
		1775	22.08	21.06	20.13
	25RB Middle (12)	1745	22.15	21.15	20.23
		1715	22.15	21.14	20.20
		1775	22.05	21.02	20.10
	25RB Low (0)	1745	22.16	21.17	20.13
		1715	22.16	21.14	20.18
		1775	22.03	20.99	20.05
	50RB (0)	1745	22.23	21.24	20.16
		1715	22.15	21.15	20.17
		1772.5	22.77	22.00	21.06
15 MHz	1RB High (74)	1745	23.03	22.27	21.17
		1717.5	22.94	22.25	21.20
		1772.5	23.02	22.15	21.18
	1RB Middle	1745	23.12	22.46	21.26

	(37)	1717.5	23.07	22.41	21.29	
	1RB Low (0)	1772.5	22.96	22.20	21.17	
		1745	22.97	22.38	21.24	
		1717.5	23.02	22.27	21.23	
	36RB High (38)	1772.5	21.96	20.92	20.03	
		1745	22.17	21.13	20.22	
		1717.5	22.10	21.04	20.11	
	36RB Middle (19)	1772.5	22.06	21.01	20.09	
		1745	22.19	21.17	20.20	
		1717.5	22.11	21.07	20.14	
	36RB Low (0)	1772.5	22.08	21.03	20.11	
		1745	22.12	21.11	20.10	
		1717.5	22.11	21.07	20.14	
	75RB (0)	1772.5	22.00	20.99	20.02	
		1745	22.12	21.12	20.15	
		1717.5	22.06	21.04	20.13	
	20 MHz	1RB High (99)	1770	22.58	21.83	20.80
			1745	22.86	22.18	20.99
			1720	22.77	22.17	21.02
		1RB Middle (50)	1770	23.04	22.37	21.34
			1745	23.18	22.46	21.37
1720			23.14	22.43	21.40	
1RB Low (0)		1770	22.80	22.12	21.02	
		1745	22.79	22.23	21.01	
		1720	22.84	22.14	20.96	
50RB High (50)		1770	21.97	21.01	20.09	
		1745	22.22	21.21	20.24	
		1720	22.01	21.02	20.05	
50RB Middle (25)		1770	22.07	21.07	20.14	
		1745	22.19	21.16	20.18	
		1720	22.12	21.11	20.18	
50RB Low (0)		1770	22.12	21.11	20.17	
		1745	22.07	21.09	20.10	
		1720	22.11	21.12	20.17	
100RB (0)		1770	22.06	21.04	20.12	
		1745	22.17	21.18	20.18	
		1720	22.08	21.06	20.12	



11.4 Wi-Fi and BT Measurement result

The maximum output power of BT is 9.43dBm.

The maximum tune up of BT is 9.6dBm.

Normal Power by Receiver off, Low power by Receiver on.

The average conducted power for Wi-Fi is as following:

Normal Power

802.11b(dBm)	
Channel\data rate	5.5Mbps
11(2462MHz)	16.54
6(2437MHz)	16.57
1(2412MHz)	16.26
Tune up	17.00
802.11g(dBm)	
Channel\data rate	6Mbps
11(2462MHz)	15.61
6(2437MHz)	15.83
1(2412MHz)	15.62
Tune up	16.00
802.11n(dBm)-20MHz	
Channel\data rate	MCS0
11(2462MHz)	15.37
6(2437MHz)	15.58
1(2412MHz)	15.38
Tune up	16.00
802.11n(dBm)-40MHz	
Channel\data rate	MCS0
9(2452MHz)	13.61
6(2437MHz)	13.82
3(2422MHz)	13.58
Tune up	14.50

Low Power

802.11b(dBm)	
Channel\data rate	1Mbps
11(2462MHz)	12.11
6(2437MHz)	12.20
1(2412MHz)	12.02
Tune up	12.50
802.11g(dBm)	
Channel\data rate	6Mbps
11(2462MHz)	11.56
6(2437MHz)	11.81
1(2412MHz)	11.63
Tune up	12.50
802.11n(dBm)-20MHz	
Channel\data rate	MCS0
11(2462MHz)	11.46
6(2437MHz)	11.92
1(2412MHz)	11.38
Tune up	12.50
802.11n(dBm)-40MHz	
Channel\data rate	MCS0
9(2452MHz)	11.96
6(2437MHz)	12.10
3(2422MHz)	11.91
Tune up	12.50

12 Simultaneous TX SAR Considerations

12.1 Transmit Antenna Separation Distances

Please refer to the picture of antenna locations in the document: "The Photos of SAR test-I21Z70258"

12.3 SAR Measurement Positions

According to the KDB941225 D06 Hot Spot SAR v01, the edges with less than 2.5 cm distance to the antennas need to be tested for SAR.

SAR measurement positions						
Mode	Front	Rear	Left edge	Right edge	Top edge	Bottom edge
Main ANT	Yes	Yes	No	Yes	No	Yes
WIFI ANT	Yes	Yes	Yes	No	Yes	No

12.4 Standalone SAR Test Exclusion Considerations

Standalone 1-g head or body SAR evaluation by measurement or numerical simulation is not required when the corresponding SAR Exclusion Threshold condition, listed below, is satisfied. The 1-g SAR test exclusion threshold for 100 MHz to 6 GHz at test separation distances ≤ 50 mm are determined by:

$[(\text{max. power of channel, including tune-up tolerance, mW}) / (\text{min. test separation distance, mm})] \cdot [\sqrt{f(\text{GHz})}] \leq 3.0$ for 1-g SAR, where

- $f(\text{GHz})$ is the RF channel transmit frequency in GHz
- Power and distance are rounded to the nearest mW and mm before calculation
- The result is rounded to one decimal place for comparison

Table 12.1: Standalone SAR test exclusion considerations

Band/Mode	F(GHz)	Position	SAR test exclusion threshold(mW)	RF output power		SAR test exclusion
				dBm	mW	
Bluetooth	2.441	Head	9.60	9.6	9.12	Yes
		Body	19.20	9.6	9.12	Yes
2.4GHz WLAN	2.45	Head	9.58	17	50.12	No
		Body	19.17	17	50.12	No

13 Evaluation of Simultaneous

Table 13.1: The sum of SAR values for Main antenna + WiFi-2.4G

	Position	Cellular antenna	WiFi-2.4G	Sum
Highest reported SAR value for Head	Left hand, Cheek	0.45	0.15	0.60
Highest SAR value for Body	Rear 10mm	0.66	0.21	0.87
	Bottom 10mm	0.87	/	0.87

Table 13.2: The sum of SAR values for Main antenna + BT

	Position	Cellular antenna	BT	Sum
Highest SAR value for Head	Left hand, Cheek	0.45	0.38 ^[1]	0.83
Maximum reported SAR value for Body	Rear 10mm	0.66	0.19 ^[1]	0.85
	Bottom 10mm	0.87	/	0.87

Note1: the test positions of above tables are for the worse case that have been evaluated.

[1] - Estimated SAR for Bluetooth (see the table 13.3)

Table 13.3: Estimated SAR for Bluetooth

Mode/Band	F (GHz)	Position	Distance (mm)	Upper limit of power *		Estimated _{1g} (W/kg)
				dBm	mW	
Bluetooth	2.441	Body	5	9.6	9.12	0.38
Bluetooth	2.441	Body	10	9.6	9.12	0.19

* - Maximum possible output power declared by manufacturer

When standalone SAR test exclusion applies to an antenna that transmits simultaneously with other antennas, the standalone SAR must be estimated according to following to determine simultaneous transmission SAR test exclusion:

(max. power of channel, including tune-up tolerance, mW)/(min. test separation distance, mm) · [$\sqrt{f(\text{GHz})/x}$] W/kg for test separation distances ≤ 50 mm;

where $x = 7.5$ for 1-g SAR.

When the minimum test separation distance is < 5 mm, a distance of 5 mm is applied to determine SAR test exclusion

Conclusion:

According to the above tables, the sum of reported SAR values is < 1.6 W/kg. So the simultaneous transmission SAR with volume scans is not required.

14 SAR Test Result

It is determined by user manual for the distance between the EUT and the phantom bottom. The distance is 10 mm and just applied to the condition of body worn accessory.

It is performed for all SAR measurements with area scan based 1-g SAR estimation (Fast SAR). A zoom scan measurement is added when the estimated 1-gSAR is the highest measured SAR in each exposure configuration, wireless mode and frequency band combination or more than 1.2W/kg.

The calculated SAR is obtained by the following formula:

$$\text{Reported SAR} = \text{Measured SAR} \times 10^{(P_{\text{Target}} - P_{\text{Measured}})/10}$$

Where P_{Target} is the power of manufacturing upper limit;

P_{Measured} is the measured power in chapter 11.

Table 14.1: Duty Cycle

Mode	Duty Cycle
Speech for GSM850/1900	1:4
GPRS&EGPRS for GSM850/1900	1:4
WCDMA<E FDD	1:1

We'll perform the head measurement in all bands with the primary SIM card depending on the evaluation of multi-SIM cards and retest on highest value point with other SIM cards. Then, repeat the measurement in the Body test.

Table 14.2: The evaluation of multi-SIM cards for Head Test

Frequency		Side	Test Position	SIM	SAR(10g) (W/kg)	Power Drift(dB)
MHz	Ch.					
897.4	37	Right	Touch	SIM1	0.290	-0.172
897.4	37	Right	Touch	SIM2	0.261	0.14

Note: According to the values in the above table, the **SIM1** is the primary SIM card.

We'll perform the head measurement with the SIM1 and retest on highest value point with others.

Table 14.3: The evaluation of multi-SIM cards for Body Test

Frequency		Test Position	Spacing (mm)	SIM	SAR(10g) (W/kg)	Power Drift(dB)
MHz	Ch.					
897.4	37	Rear	5	SIM1	0.165	-0.17
897.4	37	Rear	5	SIM2	0.141	0.13

Note: According to the values in the above table, the **SIM1** is the primary SIM card.

We'll perform the body measurement with the SIM1 and retest on highest value point with others.

Note
S2: SIM2
S3: Single SIM card slot.
14.1 SAR results for Fast SAR
Table 14.1-1: SAR Values (GSM 850 MHz Band - Head)

Ambient Temperature: 22.5°C						Liquid Temperature: 22.5°C					
Frequency		Side	Test Position	Figure No.	Conducted Power (dBm)	Max. tune-up Power (dBm)	Measured SAR(10g) (W/kg)	Reported SAR(10g) (W/kg)	Measured SAR(1g) (W/kg)	Reported SAR(1g) (W/kg)	Power Drift (dB)
Ch.	MHz										
251	848.8	Left	Touch	/	32.18	33	0.197	0.24	0.253	0.31	0.18
190	836.6	Left	Touch	/	32.27	33	0.293	0.35	0.366	0.43	0.11
128	824.2	Left	Touch	Fig.1	32.19	33	0.290	0.35	0.373	0.45	-0.17
190	836.6	Left	Tilt	/	32.27	33	0.202	0.24	0.247	0.29	-0.01
190	836.6	Right	Touch	/	32.27	33	0.290	0.34	0.364	0.43	0.14
190	836.6	Right	Tilt	/	32.27	33	0.256	0.30	0.307	0.36	0.03
128	824.2	Left	Touch	S2	32.19	33	0.261	0.31	0.319	0.38	0.14
128	824.2	Left	Touch	S3	32.19	33	0.274	0.33	0.336	0.40	0.06

Note: the head SAR of GSM850 is tested with GPRS (2Txslots) mode because of VoIP.

Table 14.1-2: SAR Values (GSM 850 MHz Band - Body)

Ambient Temperature: 22.9 ⁵⁰ °C						Liquid Temperature: 22.5°C					
Frequency		Mode (number of timeslots)	Test Position	Figure No.	Conducted Power (dBm)	Max. tune-up Power (dBm)	Measured SAR(10g) (W/kg)	Reported SAR(10g) (W/kg)	Measured SAR(1g) (W/kg)	Reported SAR(1g) (W/kg)	Power Drift (dB)
Ch.	MHz										
190	836.6	GPRS (2)	Front	/	32.27	33	0.084	0.10	0.110	0.13	-0.02
190	836.6	GPRS (2)	Rear	/	32.27	33	0.165	0.20	0.225	0.27	-0.17
190	836.6	GPRS (2)	Left	/	32.27	33	0.096	0.11	0.123	0.15	-0.08
190	836.6	GPRS (2)	Right	/	32.27	33	0.137	0.16	0.177	0.21	-0.10
251	848.8	GPRS (2)	Bottom	/	32.18	33	0.128	0.15	0.205	0.25	0.17
190	836.6	GPRS (2)	Bottom	Fig.2	32.27	33	0.167	0.20	0.301	0.36	0.14
128	824.2	GPRS (2)	Bottom	/	32.19	33	0.142	0.17	0.227	0.27	0.11
190	836.6	EGPRS (2)	Bottom	/	32.2	33	0.152	0.18	0.243	0.29	-0.01
190	836.6	GPRS (2)	Bottom	S2	32.27	33	0.147	0.17	0.276	0.33	0.02
190	836.6	GPRS (2)	Bottom	S3	32.27	33	0.161	0.19	0.291	0.34	0.07

Note: The distance between the EUT and the phantom bottom is 10mm.

Table 14.1-3: SAR Values (GSM 1900 MHz Band - Head)

Frequency		Side	Test Position	Figure No.	Conducted Power (dBm)	Max. tune-up Power (dBm)	Measured SAR(10g) (W/kg)	Reported SAR(10g) (W/kg)	Measured SAR(1g) (W/kg)	Reported SAR(1g) (W/kg)	Power Drift (dB)
Ch.	MHz										
Ambient Temperature: 23.1 °C Liquid Temperature: 22.8°C											
661	1880	Left	Touch	/	29.04	29.5	0.036	0.04	0.054	0.06	-0.14
810	1909.8	Left	Tilt	/	29.26	29.5	0.062	0.07	0.098	0.10	-0.07
661	1880	Left	Tilt	/	29.04	29.5	0.076	0.08	0.120	0.13	-0.14
512	1850.2	Left	Tilt	Fig.3	29.19	29.5	0.091	0.10	0.146	0.16	0.09
661	1880	Right	Touch	/	29.04	29.5	0.037	0.04	0.058	0.06	0.16
661	1880	Right	Tilt	/	29.04	29.5	0.034	0.04	0.051	0.06	0.12
512	1850.2	Left	Tilt	S2	29.19	29.5	0.084	0.09	0.131	0.14	0.16
512	1850.2	Left	Tilt	S3	29.19	29.5	0.081	0.09	0.126	0.14	-0.07

Note: the head SAR of GSM1900 is tested with GPRS (2Txslots) mode because of VoIP.

Table 14.1-4: SAR Values (GSM 1900 MHz Band - Body)

Frequency		Mode (number of timeslots)	Test Position	Figure No./ Note	Conducted Power (dBm)	Max. tune-up Power (dBm)	Measured SAR(10g) (W/kg)	Reported SAR(10g) (W/kg)	Measured SAR(1g) (W/kg)	Reported SAR(1g) (W/kg)	Power Drift (dB)
Ch.	MHz										
Ambient Temperature: 23.1 °C Liquid Temperature: 22.8°C											
661	1880	GPRS (2)	Front	/	29.04	29.5	0.122	0.14	0.218	0.24	0.02
661	1880	GPRS (2)	Rear	/	29.04	29.5	0.365	0.41	0.666	0.74	0.16
661	1880	GPRS (2)	Left	/	29.04	29.5	0.077	0.09	0.134	0.15	0.06
661	1880	GPRS (2)	Right	/	29.04	29.5	0.017	0.02	0.030	0.03	0.03
810	1909.8	GPRS (2)	Bottom	Fig.4	29.26	29.5	0.425	0.45	0.821	0.87	-0.09
661	1880	GPRS (2)	Bottom	/	29.04	29.5	0.404	0.45	0.749	0.83	0.10
512	1850.2	GPRS (2)	Bottom	/	29.19	29.5	0.379	0.41	0.694	0.75	0.15
810	1909.8	EGPRS (2)	Bottom	/	29.23	29.5	0.398	0.42	0.756	0.80	0.19
810	1909.8	GPRS (2)	Bottom	S2	29.26	29.5	0.417	0.44	0.804	0.85	0.13
810	1909.8	GPRS (2)	Bottom	S3	29.26	29.5	0.401	0.42	0.786	0.83	0.16

Note: The distance between the EUT and the phantom bottom is 10mm.

Table 14.1-5: SAR Values (WCDMA 1900 MHz Band - Head)

Frequency		Side	Test Position	Figure No.	Conducted Power (dBm)	Max. tune-up Power (dBm)	Measured SAR(10g) (W/kg)	Reported SAR(10g) (W/kg)	Measured SAR(1g) (W/kg)	Reported SAR(1g) (W/kg)	Power Drift (dB)
Ch.	MHz										
Ambient Temperature: 23.1 °C Liquid Temperature: 22.8°C											
9800	1880	Left	Touch	/	22.64	23.5	0.060	0.07	0.090	0.11	-0.02
9800	1880	Left	Tilt	/	22.64	23.5	0.060	0.07	0.090	0.11	-0.12
9938	1907.6	Right	Touch		22.59	23.5	0.045	0.06	0.066	0.08	-0.05
9800	1880	Right	Touch	/	22.64	23.5	0.063	0.08	0.094	0.11	0.06
9662	1852.4	Right	Touch	Fig.5	22.97	23.5	0.069	0.08	0.106	0.12	0.05
9800	1880	Right	Tilt	/	22.64	23.5	0.060	0.07	0.087	0.11	0.05
9662	1852.4	Right	Touch	S2	22.97	23.5	0.057	0.06	0.087	0.10	0.13
9662	1852.4	Right	Touch	S3	22.97	23.5	0.059	0.07	0.091	0.10	-0.14

Table 14.1-6: SAR Values (WCDMA 1900 MHz Band - Body)

Frequency		Test Position	Figure No./ Note	Conducted Power (dBm)	Max. tune-up Power (dBm)	Measured SAR(10g) (W/kg)	Reported SAR(10g) (W/kg)	Measured SAR(1g) (W/kg)	Reported SAR(1g) (W/kg)	Power Drift (dB)
Ch.	MHz									
Ambient Temperature: 23.1 °C Liquid Temperature: 22.8°C										
9800	1880	Front	/	22.64	23.5	0.150	0.18	0.243	0.30	0.07
9800	1880	Rear	/	22.64	23.5	0.361	0.44	0.535	0.65	-0.03
9800	1880	Left	/	22.64	23.5	0.102	0.12	0.182	0.22	0.15
9800	1880	Right	/	22.64	23.5	0.031	0.04	0.047	0.06	0.01
9938	1907.6	Bottom	/	22.59	23.5	0.330	0.41	0.613	0.76	0.08
9800	1880	Bottom	Fig.6	22.64	23.5	0.384	0.47	0.709	0.86	0.15
9662	1852.4	Bottom	/	22.97	23.5	0.362	0.41	0.664	0.75	-0.14
9800	1880	Bottom	S2	22.64	23.5	0.361	0.44	0.683	0.83	0.14
9800	1880	Bottom	S3	22.64	23.5	0.339	0.41	0.657	0.80	0.01

Note: The distance between the EUT and the phantom bottom is 10mm.

Table 14.1-7: SAR Values (WCDMA 1700 MHz Band - Head)

Frequency		Side	Test Position	Figure No.	Conducted Power (dBm)	Max. tune-up Power (dBm)	Measured SAR(10g) (W/kg)	Reported SAR(10g) (W/kg)	Measured SAR(1g) (W/kg)	Reported SAR(1g) (W/kg)	Power Drift (dB)
Ch.	MHz										
Ambient Temperature: 22.9 °C Liquid Temperature: 22.8 °C											
1412	1732.4	Left	Touch	/	23.37	24	0.035	0.04	0.055	0.06	-0.13
1513	1752.6	Left	Tilt	Fig.7	23.47	24	0.048	0.05	0.075	0.08	-0.09
1412	1732.4	Left	Tilt	/	23.37	24	0.031	0.04	0.048	0.06	0.06
1312	1712.4	Left	Tilt	/	23.26	24	0.044	0.05	0.071	0.08	-0.17
1412	1732.4	Right	Touch	/	23.37	24	0.043	0.05	0.066	0.08	0.07
1412	1732.4	Right	Tilt	/	23.37	24	0.027	0.03	0.040	0.05	-0.02
1513	1752.6	Left	Tilt	S2	23.47	24	0.041	0.05	0.069	0.08	0.14
1513	1752.6	Left	Tilt	S3	23.47	24	0.039	0.04	0.067	0.08	0.12

Table 14.1-8: SAR Values (WCDMA 1700 MHz Band - Body)

Frequency		Test Position	Figure No./ Note	Conducted Power (dBm)	Max. tune-up Power (dBm)	Measured SAR(10g) (W/kg)	Reported SAR(10g) (W/kg)	Measured SAR(1g) (W/kg)	Reported SAR(1g) (W/kg)	Power Drift (dB)
Ch.	MHz									
Ambient Temperature: 22.9 °C Liquid Temperature: 22.8 °C										
1412	1732.4	Front	/	23.37	24	0.071	0.08	0.115	0.13	0.12
1513	1752.6	Rear	/	23.47	24	0.300	0.34	0.497	0.56	0.05
1412	1732.4	Rear	/	23.37	24	0.322	0.37	0.529	0.61	0.09
1312	1712.4	Rear	Fig.8	23.26	24	0.340	0.40	0.556	0.66	0.03
1412	1732.4	Left	/	23.37	24	0.068	0.08	0.110	0.13	0.02
1412	1732.4	Right	/	23.37	24	0.040	0.05	0.064	0.07	-0.12
1412	1732.4	Bottom	/	23.37	24	0.269	0.31	0.467	0.54	0.11
1312	1712.4	Rear	S2	23.26	24	0.319	0.38	0.527	0.62	0.13
1312	1712.4	Rear	S3	23.26	24	0.327	0.39	0.534	0.63	0.08

Note: The distance between the EUT and the phantom bottom is 10mm.

Table 14.1-9: SAR Values (WCDMA 850 MHz Band - Head)

Frequency		Side	Test Position	Figure No.	Conducted Power (dBm)	Max. tune-up Power (dBm)	Measured SAR(10g) (W/kg)	Reported SAR(10g) (W/kg)	Measured SAR(1g) (W/kg)	Reported SAR(1g) (W/kg)	Power Drift (dB)
Ch.	MHz										
Ambient Temperature: 22.5 °C Liquid Temperature: 22.5°C											
4182	836.4	Left	Touch	/	24.43	25	0.160	0.18	0.202	0.23	-0.18
4182	836.4	Left	Tilt	/	24.43	25	0.116	0.13	0.142	0.16	0.02
4233	846.6	Right	Touch	/	24.26	25	0.143	0.17	0.183	0.22	0.10
4182	836.4	Right	Touch	/	24.43	25	0.172	0.20	0.219	0.25	0.11
4132	826.4	Right	Touch	Fig.9	24.53	25	0.192	0.21	0.248	0.28	-0.19
4182	836.4	Right	Tilt	/	24.43	25	0.151	0.17	0.180	0.21	0.12
4132	826.4	Right	Touch	S2	24.53	25	0.176	0.20	0.221	0.25	-0.16
4132	826.4	Right	Touch	S3	24.53	25	0.184	0.21	0.234	0.26	0.19

Table 14.1-10: SAR Values (WCDMA 850 MHz Band - Body)

Frequency		Test Position	Figure No.	Conducted Power (dBm)	Max. tune-up Power (dBm)	Measured SAR(10g) (W/kg)	Reported SAR(10g) (W/kg)	Measured SAR(1g) (W/kg)	Reported SAR(1g) (W/kg)	Power Drift (dB)
Ch.	MHz									
Ambient Temperature: 22.5 °C Liquid Temperature: 22.5°C										
4182	836.4	Front	/	24.43	25	0.088	0.10	0.110	0.13	-0.09
4182	836.4	Rear		24.43	25	0.111	0.13	0.211	0.24	0.15
4182	836.4	Left	/	24.43	25	0.079	0.09	0.092	0.10	-0.09
4182	836.4	Right	/	24.43	25	0.137	0.16	0.159	0.18	-0.03
4233	846.6	Bottom		24.26	25	0.105	0.12	0.191	0.23	0.18
4182	836.4	Bottom		24.43	25	0.119	0.14	0.216	0.25	0.13
4132	826.4	Bottom	Fig.10	24.53	25	0.121	0.13	0.220	0.25	-0.19
4132	826.4	Bottom	S2	24.53	25	0.114	0.13	0.204	0.23	0.17
4132	826.4	Bottom	S3	24.53	25	0.106	0.12	0.197	0.22	0.02

Note: The distance between the EUT and the phantom bottom is 10mm.

Table 14.1-11: SAR Values (LTE Band2 - Head)

Ambient Temperature: 22.9°C						Liquid Temperature: 22.4°C						
Frequency		Mode	Side	Test Position	Figure No.	Conducted Power (dBm)	Max. tune-up Power (dBm)	Measured SAR(10g) (W/kg)	Reported SAR(10g) (W/kg)	Measured SAR(1g) (W/kg)	Reported SAR(1g) (W/kg)	Power Drift (dB)
Ch.	MHz											
19100	1900	1RB_Mid	Left	Touch	/	22.7	23.5	0.030	0.04	0.047	0.06	-0.04
19100	1900	1RB_Mid	Left	Tilt	Fig.11	22.7	23.5	0.036	0.04	0.057	0.07	-0.13
19100	1900	1RB_Mid	Right	Touch	/	22.7	23.5	0.033	0.04	0.053	0.06	-0.06
19100	1900	1RB_Mid	Right	Tilt		22.7	23.5	0.032	0.04	0.053	0.06	0.12
19100	1900	50RB_Mid	Left	Touch	/	21.72	22.5	0.024	0.03	0.038	0.05	-0.15
19100	1900	50RB_Mid	Left	Tilt	/	21.72	22.5	0.033	0.04	0.055	0.07	-0.08
19100	1900	50RB_Mid	Right	Touch	/	21.72	22.5	0.027	0.03	0.044	0.05	-0.11
19100	1900	50RB_Mid	Right	Tilt	/	21.72	22.5	0.283	0.34	0.045	0.05	-0.14
19100	1900	1RB_Mid	Left	Tilt	S2	22.7	23.5	0.031	0.04	0.054	0.06	0.17
19100	1900	1RB_Mid	Left	Tilt	S3	22.7	23.5	0.030	0.04	0.054	0.06	0.11

Note1: The LTE mode is QPSK_20MHz.

Table 14.1-12: SAR Values (LTE Band2 - Body)

Ambient Temperature: 22.9°C						Liquid Temperature: 22.4°C					
Frequency		Mode	Test Position	Figure No.	Conducted Power (dBm)	Max. tune-up Power (dBm)	Measured SAR(10g) (W/kg)	Reported SAR(10g) (W/kg)	Measured SAR(1g) (W/kg)	Reported SAR(1g) (W/kg)	Power Drift (dB)
Ch.	MHz										
19100	1900	1RB_Mid	Front	/	22.7	23.5	0.120	0.14	0.202	0.24	-0.15
19100	1900	1RB_Mid	Rear	/	22.7	23.5	0.311	0.37	0.541	0.65	0.14
19100	1900	1RB_Mid	Left	/	22.7	23.5	0.169	0.20	0.291	0.35	0.15
19100	1900	1RB_Mid	Right	/	22.7	23.5	0.023	0.03	0.038	0.05	-0.14
19100	1900	1RB_Mid	Bottom	Fig.12	22.7	23.5	0.375	0.45	0.710	0.85	-0.12
18900	1880	1RB_Mid	Bottom	/	22.62	23.5	0.378	0.46	0.704	0.86	0.16
18700	1860	1RB_Mid	Bottom	/	22.55	23.5	0.323	0.40	0.593	0.74	0.03
19100	1900	50RB_Mid	Front	/	21.72	22.5	0.095	0.11	0.157	0.19	-0.02
19100	1900	50RB_Mid	Rear	/	21.72	22.5	0.237	0.28	0.400	0.48	0.08
19100	1900	50RB_Mid	Left	/	21.72	22.5	0.136	0.16	0.236	0.28	-0.09
19100	1900	50RB_Mid	Right	/	21.72	22.5	0.020	0.02	0.035	0.04	0.02
19100	1900	50RB_Mid	Bottom	/	21.72	22.5	0.276	0.33	0.513	0.61	0.09
19100	1900	100RB	Bottom	/	21.67	22.5	0.299	0.36	0.565	0.68	0.15
19100	1900	1RB_Mid	Bottom	S2	22.7	23.5	0.341	0.41	0.683	0.82	0.14
19100	1900	1RB_Mid	Bottom	S3	22.7	23.5	0.318	0.38	0.657	0.79	0.06

Note1: The distance between the EUT and the phantom bottom is 10mm.

Note2: The LTE mode is QPSK_20MHz.

Table 14.1-13: SAR Values (LTE Band4 - Head)

Ambient Temperature: 22.6 °C						Liquid Temperature: 22.5°C						
Frequency		Mode	Side	Test Position	Figure No.	Conducted Power (dBm)	Max. tune-up Power (dBm)	Measured SAR(10g) (W/kg)	Reported SAR(10g) (W/kg)	Measured SAR(1g) (W/kg)	Reported SAR(1g) (W/kg)	Power Drift (dB)
Ch.	MHz											
20300	1745	1RB_Mid	Left	Touch	/	23.26	23.5	0.032	0.03	0.049	0.05	0.16
20300	1745	1RB_Mid	Left	Tilt	Fig.13	23.26	23.5	0.046	0.05	0.070	0.07	0.11
20300	1745	1RB_Mid	Right	Touch	/	23.26	23.5	0.044	0.05	0.064	0.07	0.13
20300	1745	1RB_Mid	Right	Tilt	/	23.26	23.5	0.025	0.03	0.040	0.04	0.12
20300	1745	50RB_High	Left	Touch	/	22.26	22.5	0.024	0.03	0.037	0.04	0.09
20300	1745	50RB_High	Left	Tilt	/	22.26	22.5	0.034	0.04	0.053	0.06	-0.14
20300	1745	50RB_High	Right	Touch	/	22.26	22.5	0.030	0.03	0.045	0.05	0.03
20300	1745	50RB_High	Right	Tilt	/	22.26	22.5	0.018	0.02	0.029	0.03	0.19
20300	1745	1RB_Mid	Left	Tilt	S2	23.26	23.5	0.041	0.04	0.065	0.07	0.12
20300	1745	1RB_Mid	Left	Tilt	S3	23.26	23.5	0.038	0.04	0.062	0.07	0.17

Note1: The LTE mode is QPSK_20MHz.

Table 14.1-14: SAR Values (LTE Band4 - Body)

Ambient Temperature: 22.6 °C						Liquid Temperature: 22.5°C					
Frequency		Mode	Test Position	Figure No.	Conducted Power (dBm)	Max. tune-up Power (dBm)	Measured SAR(10g) (W/kg)	Reported SAR(10g) (W/kg)	Measured SAR(1g) (W/kg)	Reported SAR(1g) (W/kg)	Power Drift (dB)
Ch.	MHz										
20300	1745	1RB_Mid	Front	/	23.26	23.5	0.126	0.13	0.200	0.21	-0.14
20300	1745	1RB_Mid	Rear	Fig.14	23.26	23.5	0.320	0.34	0.527	0.56	0.05
20300	1745	1RB_Mid	Left	/	23.26	23.5	0.093	0.10	0.152	0.16	0.19
20300	1745	1RB_Mid	Right	/	23.26	23.5	0.046	0.05	0.087	0.09	0.08
20300	1745	1RB_Mid	Bottom	/	23.26	23.5	0.199	0.21	0.345	0.36	0.14
20300	1745	50RB_High	Front	/	22.26	22.5	0.091	0.10	0.144	0.15	-0.14
20300	1745	50RB_High	Rear	/	22.26	22.5	0.236	0.25	0.388	0.41	-0.02
20300	1745	50RB_High	Left	/	22.26	22.5	0.067	0.07	0.110	0.12	0.19
20300	1745	50RB_High	Right	/	22.26	22.5	0.032	0.03	0.059	0.06	-0.09
20300	1745	50RB_High	Bottom	/	22.26	22.5	0.172	0.18	0.299	0.32	0.13
20300	1745	1RB_Mid	Rear	S2	23.26	23.5	0.302	0.32	0.514	0.54	0.16
20300	1745	1RB_Mid	Rear	S3	23.26	23.5	0.286	0.30	0.492	0.52	0.14

Note1: The distance between the EUT and the phantom bottom is 10mm.

Note2: The LTE mode is QPSK_20MHz.

Table 14.1-15: SAR Values (LTE Band5 - Head)

Ambient Temperature: 22.5 °C						Liquid Temperature: 22.5 °C						
Frequency		Mode	Side	Test Position	Figure No.	Conducted Power (dBm)	Max. tune-up Power (dBm)	Measured SAR(10g) (W/kg)	Reported SAR(10g) (W/kg)	Measured SAR(1g) (W/kg)	Reported SAR(1g) (W/kg)	Power Drift (dB)
Ch.	MHz											
20450	829	1RB_Mid	Left	Touch	Fig.15	24.72	25	0.160	0.17	0.203	0.22	0.13
20450	829	1RB_Mid	Left	Tilt	/	24.72	25	0.094	0.10	0.114	0.12	-0.12
20450	829	1RB_Mid	Right	Touch	/	24.72	25	0.152	0.16	0.193	0.21	0.08
20450	829	1RB_Mid	Right	Tilt	/	24.72	25	0.110	0.12	0.134	0.14	0.11
20450	829	25RB_Low	Left	Touch	/	23.79	24	0.151	0.16	0.199	0.21	-0.14
20450	829	25RB_Low	Left	Tilt	/	23.79	24	0.088	0.09	0.112	0.12	0.00
20450	829	25RB_Low	Right	Touch	/	23.79	24	0.136	0.14	0.180	0.19	0.19
20450	829	25RB_Low	Right	Tilt	/	23.79	24	0.103	0.11	0.130	0.14	0.10
20450	829	1RB_Mid	Left	Touch	S2	24.72	25	0.151	0.16	0.197	0.21	0.11
20450	829	1RB_Mid	Left	Touch	S3	24.72	25	0.142	0.15	0.183	0.20	0.07

Note1: The LTE mode is QPSK_10MHz.

Table 14.1-16: SAR Values (LTE Band5 - Body)

Ambient Temperature: 22.5 °C						Liquid Temperature: 22.5 °C					
Frequency		Mode	Test Position	Figure No.	Conducted Power (dBm)	Max. tune-up Power (dBm)	Measured SAR(10g) (W/kg)	Reported SAR(10g) (W/kg)	Measured SAR(1g) (W/kg)	Reported SAR(1g) (W/kg)	Power Drift (dB)
Ch.	MHz										
20450	829	1RB_Mid	Front	/	24.72	25	0.098	0.10	0.159	0.17	-0.07
20450	829	1RB_Mid	Rear	Fig.16	24.72	25	0.183	0.20	0.304	0.32	0.01
20450	829	1RB_Mid	Left	/	24.72	25	0.086	0.09	0.126	0.13	-0.05
20450	829	1RB_Mid	Right	/	24.72	25	0.151	0.16	0.222	0.24	-0.04
20450	829	1RB_Mid	Bottom	/	24.72	25	0.135	0.14	0.250	0.27	-0.03
20450	829	25RB_Low	Front	/	23.79	24	0.078	0.08	0.126	0.13	-0.04
20450	829	25RB_Low	Rear	/	23.79	24	0.147	0.15	0.248	0.26	-0.10
20450	829	25RB_Low	Left	/	23.79	24	0.067	0.07	0.099	0.10	-0.10
20450	829	25RB_Low	Right	/	23.79	24	0.119	0.12	0.176	0.18	0.00
20450	829	25RB_Low	Bottom	/	23.79	24	0.100	0.10	0.186	0.20	-0.06
20450	829	1RB_Mid	Rear	S2	24.72	25	0.164	0.17	0.276	0.29	0.14
20450	829	1RB_Mid	Rear	S3	24.72	25	0.177	0.19	0.289	0.31	0.16

Note1: The distance between the EUT and the phantom bottom is 10mm.

Note2: The LTE mode is QPSK_10MHz.

Table 14.1-17: SAR Values (LTE Band7 - Head)

Ambient Temperature: 22.9 °C						Liquid Temperature: 22.6 °C						
Frequency		Mode	Side	Test Position	Figure No.	Conducted Power (dBm)	Max. tune-up Power (dBm)	Measured SAR(10g) (W/kg)	Reported SAR(10g) (W/kg)	Measured SAR(1g) (W/kg)	Reported SAR(1g) (W/kg)	Power Drift (dB)
Ch.	MHz											
21350	2560	1RB_Mid	Left	Touch	Fig.17	23.17	23.5	0.100	0.11	0.185	0.20	0.01
21350	2560	1RB_Mid	Left	Tilt	/	23.17	23.5	0.035	0.04	0.066	0.07	-0.02
21350	2560	1RB_Mid	Right	Touch	/	23.17	23.5	0.051	0.06	0.086	0.09	0.09
21350	2560	1RB_Mid	Right	Tilt	/	23.17	23.5	0.047	0.05	0.090	0.10	0.12
21350	2560	50RB_Mid	Left	Touch	/	22.12	22.5	0.079	0.09	0.150	0.16	0.02
21350	2560	50RB_Mid	Left	Tilt	/	22.12	22.5	0.028	0.03	0.051	0.06	0.11
21350	2560	50RB_Mid	Right	Touch	/	22.12	22.5	0.042	0.05	0.071	0.08	-0.04
21350	2560	50RB_Mid	Right	Tilt	/	22.12	22.5	0.037	0.04	0.070	0.08	-0.13
21350	2560	1RB_Mid	Left	Touch	S2	23.17	23.5	0.095	0.10	0.181	0.20	0.13
21350	2560	1RB_Mid	Left	Touch	S3	23.17	23.5	0.082	0.09	0.164	0.18	0.06

Note1: The LTE mode is QPSK_20MHz.

Table 14.1-18: SAR Values (LTE Band7 - Body)

Ambient Temperature: 22.9 °C						Liquid Temperature: 22.6 °C					
Frequency		Mode	Test Position	Figure No.	Conducted Power (dBm)	Max. tune-up Power (dBm)	Measured SAR(10g) (W/kg)	Reported SAR(10g) (W/kg)	Measured SAR(1g) (W/kg)	Reported SAR(1g) (W/kg)	Power Drift (dB)
Ch.	MHz										
21350	2560	1RB_Mid	Front	/	23.17	23.5	0.212	0.23	0.408	0.44	0.13
21350	2560	1RB_Mid	Rear	Fig.18	23.17	23.5	0.298	0.32	0.557	0.60	-0.05
21350	2560	1RB_Mid	Left	/	23.17	23.5	0.247	0.27	0.471	0.51	0.03
21350	2560	1RB_Mid	Right	/	23.17	23.5	0.063	0.07	0.123	0.13	-0.05
21350	2560	1RB_Mid	Bottom	/	23.17	23.5	0.260	0.28	0.536	0.58	0.00
21350	2560	50RB_Mid	Front	/	22.12	22.5	0.166	0.18	0.319	0.35	-0.02
21350	2560	50RB_Mid	Rear	/	22.12	22.5	0.235	0.26	0.438	0.48	-0.11
21350	2560	50RB_Mid	Left	/	22.12	22.5	0.196	0.21	0.376	0.41	0.03
21350	2560	50RB_Mid	Right	/	22.12	22.5	0.051	0.06	0.096	0.10	-0.13
21350	2560	50RB_Mid	Bottom	/	22.12	22.5	0.205	0.22	0.422	0.46	0.09
21350	2560	1RB_Mid	Rear	S2	23.17	23.5	0.261	0.28	0.524	0.57	0.16
21350	2560	1RB_Mid	Rear	S3	23.17	23.5	0.239	0.26	0.507	0.55	0.08

Note1: The distance between the EUT and the phantom bottom is 10mm.

Note2: The LTE mode is QPSK_20MHz.

Table 14.1-19: SAR Values (LTE Band12 - Head)

Ambient Temperature: 22.7 °C						Liquid Temperature: 22.3°C						
Frequency		Mode	Side	Test Position	Figure No.	Conducted Power (dBm)	Max. tune-up Power (dBm)	Measured SAR(10g) (W/kg)	Reported SAR(10g) (W/kg)	Measured SAR(1g) (W/kg)	Reported SAR(1g) (W/kg)	Power Drift (dB)
Ch.	MHz											
23060	704	1RB_Mid	Left	Touch	/	24.58	25	0.109	0.12	0.143	0.16	-0.11
23060	704	1RB_Mid	Left	Tilt	/	24.58	25	0.099	0.11	0.128	0.14	-0.11
23060	704	1RB_Mid	Right	Touch	Fig.19	24.58	25	0.133	0.15	0.169	0.19	0.13
23060	704	1RB_Mid	Right	Tilt	/	24.58	25	0.133	0.15	0.166	0.18	-0.01
23130	711	25RB_Mid	Left	Touch	/	23.65	24	0.078	0.08	0.104	0.11	0.08
23130	711	25RB_Mid	Left	Tilt	/	23.65	24	0.071	0.08	0.092	0.10	0.03
23130	711	25RB_Mid	Right	Touch	/	23.65	24	0.091	0.10	0.119	0.13	-0.06
23130	711	25RB_Mid	Right	Tilt	/	23.65	24	0.100	0.11	0.129	0.14	-0.10
23060	704	1RB_Mid	Right	Touch	S2	24.58	25	0.124	0.14	0.158	0.17	0.16
23060	704	1RB_Mid	Right	Touch	S3	24.58	25	0.111	0.12	0.147	0.16	0.06

Note1: The LTE mode is QPSK_10MHz.

Table 14.1-20: SAR Values (LTE Band12 - Body)

Ambient Temperature: 22.7 °C						Liquid Temperature: 22.3°C						
Frequency		Mode	Test Position	Figure No.	Conducted Power (dBm)	Max. tune-up Power (dBm)	Measured SAR(10g) (W/kg)	Reported SAR(10g) (W/kg)	Measured SAR(1g) (W/kg)	Reported SAR(1g) (W/kg)	Power Drift (dB)	
Ch.	MHz											
23060	704	1RB_Mid	Front	/	24.58	25	0.058	0.06	0.073	0.08	0.02	
23060	704	1RB_Mid	Rear	/	24.58	25	0.069	0.08	0.111	0.12	0.09	
23060	704	1RB_Mid	Left	/	24.58	25	0.055	0.06	0.079	0.09	-0.12	
23060	704	1RB_Mid	Right	Fig.20	24.58	25	0.097	0.11	0.138	0.15	0.11	
23060	704	1RB_Mid	Bottom	/	24.58	25	0.051	0.06	0.116	0.13	0.01	
23130	711	25RB_Mid	Front	/	23.65	24	0.038	0.04	0.049	0.05	-0.11	
23130	711	25RB_Mid	Rear	/	23.65	24	0.049	0.05	0.078	0.08	-0.10	
23130	711	25RB_Mid	Left	/	23.65	24	0.032	0.03	0.045	0.05	0.07	
23130	711	25RB_Mid	Right	/	23.65	24	0.066	0.07	0.094	0.10	-0.01	
23130	711	25RB_Mid	Bottom	/	23.65	24	0.038	0.04	0.087	0.09	0.05	
23060	704	1RB_Mid	Right	S2	24.58	25	0.086	0.09	0.114	0.13	0.13	
23060	704	1RB_Mid	Right	S3	24.58	25	0.091	0.10	0.127	0.14	-0.16	

Note1: The distance between the EUT and the phantom bottom is 10mm

Note2: The LTE mode is QPSK_10MHz.

Table 14.1-21: SAR Values (LTE Band66 - Head)

Frequency		Mode	Side	Test Position	Figure No.	Conducted Power (dBm)	Max. tune-up Power (dBm)	Measured SAR(10g) (W/kg)	Reported SAR(10g) (W/kg)	Measured SAR(1g) (W/kg)	Reported SAR(1g) (W/kg)	Power Drift (dB)
Ch.	MHz											
132322	1745	1RB_Mid	Left	Touch	/	23.18	23.5	0.045	0.05	0.068	0.07	0.01
132322	1745	1RB_Mid	Left	Tilt	/	23.18	23.5	0.040	0.04	0.060	0.06	0.08
132322	1745	1RB_Mid	Right	Touch	Fig.21	23.18	23.5	0.053	0.06	0.083	0.09	-0.10
132322	1745	1RB_Mid	Right	Tilt	/	23.18	23.5	0.030	0.03	0.047	0.05	0.01
132322	1745	50RB_High	Left	Touch	/	22.22	22.5	0.033	0.04	0.050	0.05	-0.10
132322	1745	50RB_High	Left	Tilt	/	22.22	22.5	0.030	0.03	0.047	0.05	-0.10
132322	1745	50RB_High	Right	Touch	/	22.22	22.5	0.038	0.04	0.056	0.06	-0.01
132322	1745	50RB_High	Right	Tilt	/	22.22	22.5	0.022	0.02	0.035	0.04	0.00
132322	1745	1RB_Mid	Right	Touch	S2	23.18	23.5	0.047	0.05	0.078	0.08	0.16
132322	1745	1RB_Mid	Right	Touch	S3	23.18	23.5	0.041	0.04	0.071	0.08	0.19

Note1: The LTE mode is QPSK_20MHz.

Table 14.1-22: SAR Values (LTE Band66 - Body)

Frequency		Mode	Test Position	Figure No.	Conducted Power (dBm)	Max. tune-up Power (dBm)	Measured SAR(10g) (W/kg)	Reported SAR(10g) (W/kg)	Measured SAR(1g) (W/kg)	Reported SAR(1g) (W/kg)	Power Drift (dB)
Ch.	MHz										
132322	1745	1RB_Mid	Front	/	23.18	23.5	0.074	0.08	0.116	0.12	-0.08
132322	1745	1RB_Mid	Rear	Fig.22	23.18	23.5	0.307	0.33	0.505	0.54	-0.12
132322	1745	1RB_Mid	Left	/	23.18	23.5	0.083	0.09	0.110	0.12	-0.04
132322	1745	1RB_Mid	Right	/	23.18	23.5	0.041	0.04	0.054	0.06	-0.04
132322	1745	1RB_Mid	Bottom	/	23.04	23.5	0.297	0.33	0.418	0.46	0.13
132322	1745	50RB_High	Front	/	22.22	22.5	0.054	0.06	0.085	0.09	0.11
132322	1745	50RB_High	Rear	/	22.22	22.5	0.203	0.22	0.376	0.40	0.06
132322	1745	50RB_High	Left	/	22.22	22.5	0.061	0.07	0.080	0.09	-0.09
132322	1745	50RB_High	Right	/	22.22	22.5	0.030	0.03	0.040	0.04	-0.05
132322	1745	50RB_High	Bottom	/	22.22	22.5	0.149	0.16	0.259	0.28	0.13
132322	1745	1RB_Mid	Rear	S2	23.18	23.5	0.267	0.29	0.462	0.50	0.17
132322	1745	1RB_Mid	Rear	S3	23.18	23.5	0.289	0.31	0.491	0.53	0.11

Note: The distance between the EUT and the phantom bottom is 10mm.

Note4: The LTE mode is QPSK_20MHz.

14.2 SAR results for Standard procedure

There is zoom scan measurement to be added for the highest measured SAR in each exposure configuration/band.

Table 14.2-1: SAR Values (GSM 850 MHz Band - Head)

Ambient Temperature: 22.5 °C						Liquid Temperature: 22.5 °C					
Frequency		Side	Test Position	Figure No.	Conducted Power (dBm)	Max. tune-up Power (dBm)	Measured SAR(10g) (W/kg)	Reported SAR(10g) (W/kg)	Measured SAR(1g) (W/kg)	Reported SAR(1g) (W/kg)	Power Drift (dB)
Ch.	MHz										
128	824.2	Left	Touch	Fig.1	32.19	33	0.290	0.35	0.373	0.45	-0.17

Note: the head SAR of GSM850 is tested with GPRS (2Txslots) mode because of VoIP.

Table 14.2-2: SAR Values (GSM 850 MHz Band - Body)

Ambient Temperature: 22.9 ⁵⁰ °C						Liquid Temperature: 22.5 °C					
Frequency		Mode (number of timeslots)	Test Position	Figure No.	Conducted Power (dBm)	Max. tune-up Power (dBm)	Measured SAR(10g) (W/kg)	Reported SAR(10g) (W/kg)	Measured SAR(1g) (W/kg)	Reported SAR(1g) (W/kg)	Power Drift (dB)
Ch.	MHz										
190	836.6	GPRS (2)	Bottom	Fig.2	32.27	33	0.167	0.20	0.301	0.36	0.14

Note: The distance between the EUT and the phantom bottom is 10mm.

Table 14.2-3: SAR Values (GSM 1900 MHz Band - Head)

Ambient Temperature: 23.1 °C						Liquid Temperature: 22.8 °C					
Frequency		Side	Test Position	Figure No.	Conducted Power (dBm)	Max. tune-up Power (dBm)	Measured SAR(10g) (W/kg)	Reported SAR(10g) (W/kg)	Measured SAR(1g) (W/kg)	Reported SAR(1g) (W/kg)	Power Drift (dB)
Ch.	MHz										
512	1850.2	Left	Tilt	Fig.3	29.19	29.5	0.091	0.10	0.146	0.16	0.09

Note: the head SAR of GSM1900 is tested with GPRS (2Txslots) mode because of VoIP.

Table 14.2-4: SAR Values (GSM 1900 MHz Band - Body)

Ambient Temperature: 23.1 °C						Liquid Temperature: 22.8 °C					
Frequency		Mode (number of timeslots)	Test Position	Figure No./ Note	Conducted Power (dBm)	Max. tune-up Power (dBm)	Measured SAR(10g) (W/kg)	Reported SAR(10g) (W/kg)	Measured SAR(1g) (W/kg)	Reported SAR(1g) (W/kg)	Power Drift (dB)
Ch.	MHz										
810	1909.8	GPRS (2)	Bottom	Fig.4	29.26	29.5	0.425	0.45	0.821	0.87	-0.09

Note: The distance between the EUT and the phantom bottom is 10mm.

Table 14.2-5: SAR Values (WCDMA 1900 MHz Band - Head)

Frequency		Side	Test Position	Figure No.	Conducted Power (dBm)	Max. tune-up Power (dBm)	Measured SAR(10g) (W/kg)	Reported SAR(10g) (W/kg)	Measured SAR(1g) (W/kg)	Reported SAR(1g) (W/kg)	Power Drift (dB)
Ch.	MHz										
9662	1852.4	Right	Touch	Fig.5	22.97	23.5	0.069	0.08	0.106	0.12	0.05

Table 14.2-6: SAR Values (WCDMA 1900 MHz Band - Body)

Frequency		Test Position	Figure No./ Note	Conducted Power (dBm)	Max. tune-up Power (dBm)	Measured SAR(10g) (W/kg)	Reported SAR(10g) (W/kg)	Measured SAR(1g) (W/kg)	Reported SAR(1g) (W/kg)	Power Drift (dB)
Ch.	MHz									
9800	1880	Bottom	Fig.6	22.64	23.5	0.384	0.47	0.709	0.86	0.15

Note: The distance between the EUT and the phantom bottom is 10mm.

Table 14.2-7: SAR Values (WCDMA 1700 MHz Band - Head)

Frequency		Side	Test Position	Figure No.	Conducted Power (dBm)	Max. tune-up Power (dBm)	Measured SAR(10g) (W/kg)	Reported SAR(10g) (W/kg)	Measured SAR(1g) (W/kg)	Reported SAR(1g) (W/kg)	Power Drift (dB)
Ch.	MHz										
1513	1752.6	Left	Tilt	Fig.7	23.47	24	0.048	0.05	0.075	0.08	-0.09

Table 14.2-8: SAR Values (WCDMA 1700 MHz Band - Body)

Frequency		Test Position	Figure No./ Note	Conducted Power (dBm)	Max. tune-up Power (dBm)	Measured SAR(10g) (W/kg)	Reported SAR(10g) (W/kg)	Measured SAR(1g) (W/kg)	Reported SAR(1g) (W/kg)	Power Drift (dB)
Ch.	MHz									
1312	1712.4	Rear	Fig.8	23.26	24	0.340	0.40	0.556	0.66	0.03

Note: The distance between the EUT and the phantom bottom is 10mm.

Table 14.2-9: SAR Values (WCDMA 850 MHz Band - Head)

Frequency		Side	Test Position	Figure No.	Conducted Power (dBm)	Max. tune-up Power (dBm)	Measured SAR(10g) (W/kg)	Reported SAR(10g) (W/kg)	Measured SAR(1g) (W/kg)	Reported SAR(1g) (W/kg)	Power Drift (dB)
Ch.	MHz										
4132	826.4	Right	Touch	Fig.9	24.53	25	0.192	0.21	0.248	0.28	-0.19

Table 14.2-10: SAR Values (WCDMA 850 MHz Band - Body)

Ambient Temperature: 22.5 °C						Liquid Temperature: 22.5°C				
Frequency		Test Position	Figure No.	Conducted Power (dBm)	Max. tune-up Power (dBm)	Measured SAR(10g) (W/kg)	Reported SAR(10g) (W/kg)	Measured SAR(1g) (W/kg)	Reported SAR(1g) (W/kg)	Power Drift (dB)
Ch.	MHz									
4132	826.4	Bottom	Fig.10	24.53	25	0.121	0.13	0.220	0.25	-0.19

Note: The distance between the EUT and the phantom bottom is 10mm.

Table 14.2-11: SAR Values (LTE Band2 - Head)

Ambient Temperature: 22.9 °C						Liquid Temperature: 22.4°C						
Frequency		Mode	Side	Test Position	Figure No.	Conducted Power (dBm)	Max. tune-up Power (dBm)	Measured SAR(10g) (W/kg)	Reported SAR(10g) (W/kg)	Measured SAR(1g) (W/kg)	Reported SAR(1g) (W/kg)	Power Drift (dB)
Ch.	MHz											
19100	1900	1RB_Mid	Left	Tilt	Fig.11	22.7	23.5	0.036	0.04	0.057	0.07	-0.13

Note1: The LTE mode is QPSK_20MHz.

Table 14.2-12: SAR Values (LTE Band2 - Body)

Ambient Temperature: 22.9 °C						Liquid Temperature: 22.4°C						
Frequency		Mode	Test Position	Figure No.	Conducted Power (dBm)	Max. tune-up Power (dBm)	Measured SAR(10g) (W/kg)	Reported SAR(10g) (W/kg)	Measured SAR(1g) (W/kg)	Reported SAR(1g) (W/kg)	Power Drift (dB)	
Ch.	MHz											
19100	1900	1RB_Mid	Bottom	Fig.12	22.7	23.5	0.375	0.45	0.710	0.85	-0.12	

Note1: The distance between the EUT and the phantom bottom is 10mm.

Note2: The LTE mode is QPSK_20MHz.

Table 14.2-13: SAR Values (LTE Band4 - Head)

Ambient Temperature: 22.6 °C						Liquid Temperature: 22.5°C						
Frequency		Mode	Side	Test Position	Figure No.	Conducted Power (dBm)	Max. tune-up Power (dBm)	Measured SAR(10g) (W/kg)	Reported SAR(10g) (W/kg)	Measured SAR(1g) (W/kg)	Reported SAR(1g) (W/kg)	Power Drift (dB)
Ch.	MHz											
20300	1745	1RB_Mid	Left	Tilt	Fig.13	23.26	23.5	0.046	0.05	0.070	0.07	0.11

Note1: The LTE mode is QPSK_20MHz.

Table 14.2-14: SAR Values (LTE Band4 - Body)

Ambient Temperature: 22.6 °C						Liquid Temperature: 22.5°C					
Frequency		Mode	Test Position	Figure No.	Conducted Power (dBm)	Max. tune-up Power (dBm)	Measured SAR(10g) (W/kg)	Reported SAR(10g) (W/kg)	Measured SAR(1g) (W/kg)	Reported SAR(1g) (W/kg)	Power Drift (dB)
Ch.	MHz										
20300	1745	1RB_Mid	Rear	Fig.14	23.26	23.5	0.320	0.34	0.527	0.56	0.05

Note1: The distance between the EUT and the phantom bottom is 10mm.

Note2: The LTE mode is QPSK_20MHz.

Table 14.2-15: SAR Values (LTE Band5 - Head)

Ambient Temperature: 22.5 °C						Liquid Temperature: 22.5°C						
Frequency		Mode	Side	Test Position	Figure No.	Conducted Power (dBm)	Max. tune-up Power (dBm)	Measured SAR(10g) (W/kg)	Reported SAR(10g) (W/kg)	Measured SAR(1g) (W/kg)	Reported SAR(1g) (W/kg)	Power Drift (dB)
Ch.	MHz											
20450	829	1RB_Mid	Left	Touch	Fig.15	24.72	25	0.160	0.17	0.203	0.22	0.13

Note1: The LTE mode is QPSK_10MHz.

Table 14.2-16: SAR Values (LTE Band5 - Body)

Ambient Temperature: 22.5 °C						Liquid Temperature: 22.5°C					
Frequency		Mode	Test Position	Figure No.	Conducted Power (dBm)	Max. tune-up Power (dBm)	Measured SAR(10g) (W/kg)	Reported SAR(10g) (W/kg)	Measured SAR(1g) (W/kg)	Reported SAR(1g) (W/kg)	Power Drift (dB)
Ch.	MHz										
20450	829	1RB_Mid	Rear	Fig.16	24.72	25	0.183	0.20	0.304	0.32	0.01

Note1: The distance between the EUT and the phantom bottom is 10mm.

Note2: The LTE mode is QPSK_10MHz.

Table 14.2-17: SAR Values (LTE Band7 - Head)

Ambient Temperature: 22.9 °C						Liquid Temperature: 22.6°C						
Frequency		Mode	Side	Test Position	Figure No.	Conducted Power (dBm)	Max. tune-up Power (dBm)	Measured SAR(10g) (W/kg)	Reported SAR(10g) (W/kg)	Measured SAR(1g) (W/kg)	Reported SAR(1g) (W/kg)	Power Drift (dB)
Ch.	MHz											
21350	2560	1RB_Mid	Left	Touch	Fig.17	23.17	23.5	0.100	0.11	0.185	0.20	0.01

Note1: The LTE mode is QPSK_20MHz.

Table 14.2-18: SAR Values (LTE Band7 - Body)

Frequency		Mode	Test Position	Figure No.	Conduct ed Power (dBm)	Max. tune-up Power (dBm)	Measured SAR(10g) (W/kg)	Reported SAR(10g) (W/kg)	Measured SAR(1g) (W/kg)	Reported SAR(1g) (W/kg)	Power Drift (dB)
Ch.	MHz										
21350	2560	1RB_Mid	Rear	Fig.18	23.17	23.5	0.298	0.32	0.557	0.60	-0.05

Note1: The distance between the EUT and the phantom bottom is 10mm.

Note2: The LTE mode is QPSK_20MHz.

Table 14.2-19: SAR Values (LTE Band12 - Head)

Frequency		Mode	Side	Test Position	Figure No.	Conduc ted Power (dBm)	Max. tune-up Power (dBm)	Measured SAR(10g) (W/kg)	Reported SAR(10g) (W/kg)	Measur ed SAR(1g) (W/kg)	Report ed SAR(1g) (W/kg)	Power Drift (dB)
Ch.	MHz											
23060	704	1RB_Mid	Right	Touch	Fig.19	24.58	25	0.133	0.15	0.169	0.19	0.13

Note1: The LTE mode is QPSK_10MHz.

Table 14.2-20: SAR Values (LTE Band12 - Body)

Frequency		Mode	Test Position	Figure No.	Conduct ed Power (dBm)	Max. tune-up Power (dBm)	Measured SAR(10g) (W/kg)	Reported SAR(10g) (W/kg)	Measured SAR(1g) (W/kg)	Reported SAR(1g) (W/kg)	Power Drift (dB)
Ch.	MHz										
23060	704	1RB_Mid	Right	Fig.20	24.58	25	0.097	0.11	0.138	0.15	0.11

Note1: The distance between the EUT and the phantom bottom is 10mm

Note2: The LTE mode is QPSK_10MHz.

Table 14.2-21: SAR Values (LTE Band66 - Head)

Frequency		Mode	Side	Test Position	Figure No.	Conduct ed Power (dBm)	Max. tune-up Power (dBm)	Measured SAR(10g) (W/kg)	Reported SAR(10g) (W/kg)	Measure d SAR(1g) (W/kg)	Reporte d SAR(1g) (W/kg)	Power Drift (dB)
Ch.	MHz											
132322	1745	1RB_Mid	Right	Touch	Fig.21	23.18	23.5	0.053	0.06	0.083	0.09	-0.10

Note1: The LTE mode is QPSK_20MHz.

Table 14.2-22: SAR Values (LTE Band66 - Body)

Frequency		Mode	Test Position	Figure No.	Conducted Power (dBm)	Max. tune-up Power (dBm)	Measured SAR(10g) (W/kg)	Reported SAR(10g) (W/kg)	Measured SAR(1g) (W/kg)	Reported SAR(1g) (W/kg)	Power Drift (dB)
Ch.	MHz										
132322	1745	1RB_Mid	Rear	Fig.22	23.18	23.5	0.307	0.33	0.505	0.54	-0.12

Note1: The distance between the EUT and the phantom bottom is 10mm.

Note2: The LTE mode is QPSK_20MHz.

14.3 WLAN Evaluation for 2.4G

According to the KDB248227 D01, SAR is measured for 2.4GHz 802.11b DSSS using the initial test position procedure.

Head Evaluation

Table 14.3-1: SAR Values (WLAN - Head)– 802.11b (Fast SAR) Normal Power

Frequency		Side	Test Position	Figure No.	Conducted Power (dBm)	Max. tune-up Power (dBm)	Measured SAR(10g) (W/kg)	Reported SAR(10g) (W/kg)	Measured SAR(1g) (W/kg)	Reported SAR(1g)(W/kg)	Power Drift (dB)
MHz	Ch.										
2437	6	Left	Touch	/	12.2	12.5	0.078	0.08	0.144	0.15	0.13
2437	6	Left	Tilt	/	12.2	12.5	0.075	0.08	0.167	0.18	0.16
2437	6	Right	Touch	/	12.2	12.5	0.027	0.03	0.054	0.06	-0.17
2437	6	Right	Tilt	/	12.2	12.5	0.032	0.03	0.072	0.08	0.06
2437	6	Left	Tilt	S2	12.2	12.5	0.068	0.07	0.152	0.16	0.17
2437	6	Left	Tilt	S3	12.2	12.5	0.072	0.08	0.161	0.17	0.09

As shown above table, the initial test position for head is “Left Tilt”. So the head SAR of WLAN is presented as below:

Table 14.3-2: SAR Values (WLAN - Head)– 802.11b (Full SAR) Normal Power

Frequency		Side	Test Position	Figure No.	Conducted Power (dBm)	Max. tune-up Power (dBm)	Measured SAR(10g) (W/kg)	Reported SAR(10g) (W/kg)	Measured SAR(1g) (W/kg)	Reported SAR(1g)(W/kg)	Power Drift (dB)
MHz	Ch.										
2437	6	Left	Tilt	Fig.23	12.2	12.5	0.070	0.08	0.166	0.18	0.16

Note1: When the reported SAR of the initial test position is > 0.4 W/kg, SAR is repeated for the 802.11 transmission mode configuration tested in the initial test position using subsequent highest estimated 1-g SAR conditions determined by area scans, on the highest maximum output power channel, until the reported SAR is \leq 0.8 W/kg.

Note2: For all positions/configurations tested using the initial test position and subsequent test positions, when the reported SAR is > 0.8 W/kg, SAR is measured for these test positions/configurations on the subsequent next highest measured output power channel until the reported SAR is \leq 1.2 W/kg or all required channels are tested.

According to the KDB248227 D01, The reported SAR must be scaled to 100% transmission duty factor to determine compliance at the maximum tune-up tolerance limit. The scaled reported SAR is presented as below.

Table 14.3-3: SAR Values (WLAN - Head) – 802.11b (Scaled Reported SAR)

Frequency		Side	Test Position	Actual duty factor	maximum duty factor	Reported SAR (1g)(W/kg)	Scaled reported SAR (1g)(W/kg)
MHz	Ch.						
		Ambient Temperature: 22.9 °C		Liquid Temperature: 22.5 °C			
2437	6	Left	Tilt	100%	100%	0.18	0.18

SAR is not required for OFDM because the 802.11b adjusted SAR ≤ 1.2 W/kg.

Body Evaluation

Table 14.3-4: SAR Values (WLAN - Body)– 802.11b (Fast SAR)

Frequency		Test Position	Figure No.	Conducted Power (dBm)	Max. tune-up Power (dBm)	Measured SAR(10g) (W/kg)	Reported SAR(10g) (W/kg)	Measured SAR(1g) (W/kg)	Reported SAR(1g)(W/kg)	Power Drift (dB)
MHz	Ch.									
		Ambient Temperature: 22.9 °C		Liquid Temperature: 22.5 °C						
2437	6	Front	/	16.57	17	0.087	0.10	0.182	0.20	0.15
2437	6	Rear	/	16.57	17	0.096	0.11	0.195	0.22	0.14
2437	6	Right		16.57	17	0.083	0.09	0.159	0.18	0.07
2437	6	Top	/	16.57	17	0.038	0.04	0.088	0.10	0.08
2437	6	Rear	S2	16.57	17	0.081	0.09	0.174	0.19	0.02
2437	6	Rear	S3	16.57	17	0.073	0.08	0.162	0.18	0.07

As shown above table, the initial test position for body is “Right”. So the body SAR of WLAN is presented as below:

Table 14.3-5: SAR Values (WLAN - Body)– 802.11b (Full SAR)

Frequency		Test Position	Figure No.	Conducted Power (dBm)	Max. tune-up Power (dBm)	Measured SAR(10g) (W/kg)	Reported SAR(10g) (W/kg)	Measured SAR(1g) (W/kg)	Reported SAR(1g)(W/kg)	Power Drift (dB)
MHz	Ch.									
		Ambient Temperature: 22.9 °C		Liquid Temperature: 22.5 °C						
2437	6	Rear	Fig.24	16.57	17	0.089	0.10	0.186	0.21	0.14

Note1: When the reported SAR of the initial test position is > 0.4 W/kg, SAR is repeated for the 802.11 transmission mode configuration tested in the initial test position using subsequent highest estimated 1-g SAR conditions determined by area scans, on the highest maximum output power channel, until the reported SAR is ≤ 0.8 W/kg.

Note2: For all positions/configurations tested using the initial test position and subsequent test positions, when the reported SAR is > 0.8 W/kg, SAR is measured for these test positions/configurations on the subsequent next highest measured output power channel until the reported SAR is ≤ 1.2 W/kg or all required channels are tested.

According to the KDB248227 D01, The reported SAR must be scaled to 100% transmission duty factor to determine compliance at the maximum tune-up tolerance limit. The scaled reported SAR is presented as below.

Table 14.3-6: SAR Values (WLAN - Body) – 802.11b (Scaled Reported SAR)

Frequency		Test Position	Actual duty factor	maximum duty factor	Reported SAR (1g)(W/kg)	Scaled reported SAR (1g)(W/kg)
MHz	Ch.					
2437	6	Rear	100%	100%	0.21	0.21

SAR is not required for OFDM because the 802.11b adjusted SAR ≤ 1.2 W/kg.

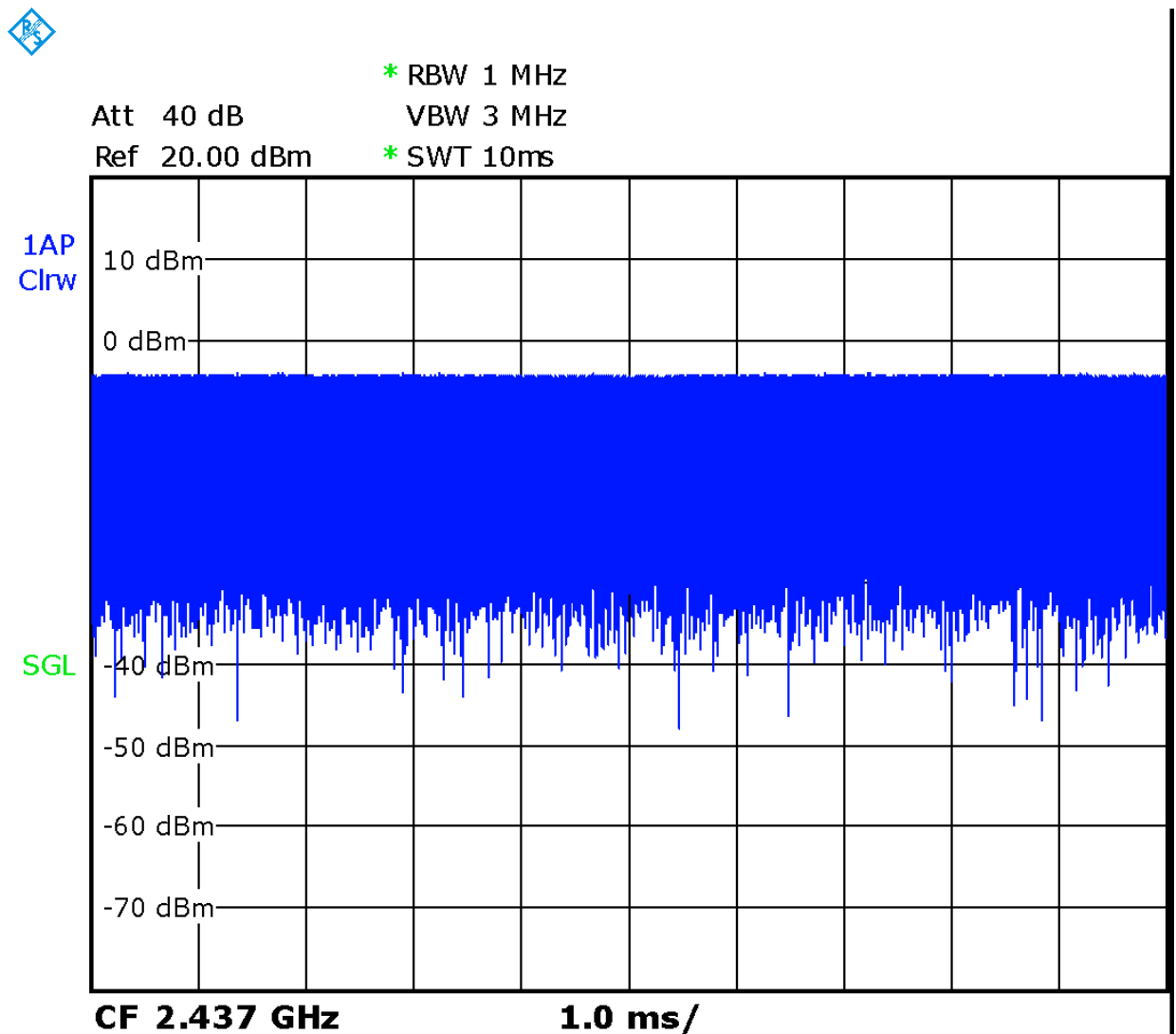
Picture 14.1 Duty factor plot

15 SAR Measurement Variability

SAR measurement variability must be assessed for each frequency band, which is determined by the SAR probe calibration point and tissue-equivalent medium used for the device measurements. When both head and body tissue-equivalent media are required for SAR measurements in a frequency band, the variability measurement procedures should be applied to the tissue medium with the highest measured SAR, using the highest measured SAR configuration for that tissue-equivalent medium.

The following procedures are applied to determine if repeated measurements are required.

- 1) Repeated measurement is not required when the original highest measured SAR is < 0.80 W/kg; steps 2) through 4) do not apply.
- 2) When the original highest measured SAR is ≥ 0.80 W/kg, repeat that measurement once.
- 3) Perform a second repeated measurement only if the ratio of largest to smallest SAR for the original and first repeated measurements is > 1.20 or when the original or repeated measurement is ≥ 1.45 W/kg ($\sim 10\%$ from the 1-g SAR limit).
- 4) Perform a third repeated measurement only if the original, first or second repeated measurement is ≥ 1.5 W/kg and the ratio of largest to smallest SAR for the original, first and second repeated measurements is > 1.20 .

16 Measurement Uncertainty

16.1 Measurement Uncertainty for Normal SAR Tests (300MHz~3GHz)

No.	Error Description	Type	Uncertainty value	Probably Distribution	Div.	(Ci) 1g	(Ci) 10g	Std. Unc. (1g)	Std. Unc. (10g)	Degree of freedom
Measurement system										
1	Probe calibration	B	6.0	N	1	1	1	6.0	6.0	∞
2	Isotropy	B	4.7	R	$\sqrt{3}$	0.7	0.7	1.9	1.9	∞
3	Boundary effect	B	1.0	R	$\sqrt{3}$	1	1	0.6	0.6	∞
4	Linearity	B	4.7	R	$\sqrt{3}$	1	1	2.7	2.7	∞
5	Detection limit	B	1.0	N	1	1	1	0.6	0.6	∞
6	Readout electronics	B	0.3	R	$\sqrt{3}$	1	1	0.3	0.3	∞
7	Response time	B	0.8	R	$\sqrt{3}$	1	1	0.5	0.5	∞
8	Integration time	B	2.6	R	$\sqrt{3}$	1	1	1.5	1.5	∞
9	RF ambient conditions-noise	B	0	R	$\sqrt{3}$	1	1	0	0	∞
10	RFambient conditions-reflection	B	0	R	$\sqrt{3}$	1	1	0	0	∞
11	Probe positioned mech. restrictions	B	0.4	R	$\sqrt{3}$	1	1	0.2	0.2	∞
12	Probe positioning with respect to phantom shell	B	2.9	R	$\sqrt{3}$	1	1	1.7	1.7	∞
13	Post-processing	B	1.0	R	$\sqrt{3}$	1	1	0.6	0.6	∞
Test sample related										
14	Test sample positioning	A	3.3	N	1	1	1	3.3	3.3	71
15	Device holder uncertainty	A	3.4	N	1	1	1	3.4	3.4	5
16	Drift of output power	B	5.0	R	$\sqrt{3}$	1	1	2.9	2.9	∞
Phantom and set-up										
17	Phantom uncertainty	B	4.0	R	$\sqrt{3}$	1	1	2.3	2.3	∞
18	Liquid conductivity (target)	B	5.0	R	$\sqrt{3}$	0.64	0.43	1.8	1.2	∞
19	Liquid conductivity (meas.)	A	2.06	N	1	0.64	0.43	1.32	0.89	43
20	Liquid permittivity (target)	B	5.0	R	$\sqrt{3}$	0.6	0.49	1.7	1.4	∞
21	Liquid permittivity (meas.)	A	1.6	N	1	0.6	0.49	1.0	0.8	521

Combined standard uncertainty	$u_c = \sqrt{\sum_{i=1}^{21} c_i^2 u_i^2}$							9.55	9.43	257
Expanded uncertainty (confidence interval of 95 %)	$u_e = 2u_c$							19.1	18.9	

16.2 Measurement Uncertainty for Fast SAR Tests (300MHz~3GHz)

No.	Error Description	Type	Uncertainty value	Probably Distribution	Div.	(Ci) 1g	(Ci) 10g	Std. Unc. (1g)	Std. Unc. (10g)	Degree of freedom
Measurement system										
1	Probe calibration	B	6.0	N	1	1	1	6.0	6.0	∞
2	Isotropy	B	4.7	R	$\sqrt{3}$	0.7	0.7	1.9	1.9	∞
3	Boundary effect	B	1.0	R	$\sqrt{3}$	1	1	0.6	0.6	∞
4	Linearity	B	4.7	R	$\sqrt{3}$	1	1	2.7	2.7	∞
5	Detection limit	B	1.0	R	$\sqrt{3}$	1	1	0.6	0.6	∞
6	Readout electronics	B	0.3	R	$\sqrt{3}$	1	1	0.3	0.3	∞
7	Response time	B	0.8	R	$\sqrt{3}$	1	1	0.5	0.5	∞
8	Integration time	B	2.6	R	$\sqrt{3}$	1	1	1.5	1.5	∞
9	RF ambient conditions-noise	B	0	R	$\sqrt{3}$	1	1	0	0	∞
10	RFambient conditions-reflection	B	0	R	$\sqrt{3}$	1	1	0	0	∞
11	Probe positioned mech. Restrictions	B	0.4	R	$\sqrt{3}$	1	1	0.2	0.2	∞
12	Probe positioning with respect to phantom shell	B	2.9	R	$\sqrt{3}$	1	1	1.7	1.7	∞
13	Post-processing	B	1.0	R	$\sqrt{3}$	1	1	0.6	0.6	∞
14	Fast SAR z-Approximation	B	7.0	R	$\sqrt{3}$	1	1	4.0	4.0	∞
Test sample related										
15	Test sample positioning	A	3.3	N	1	1	1	3.3	3.3	71
16	Device holder uncertainty	A	3.4	N	1	1	1	3.4	3.4	5
17	Drift of output power	B	5.0	R	$\sqrt{3}$	1	1	2.9	2.9	∞
Phantom and set-up										
18	Phantom uncertainty	B	4.0	R	$\sqrt{3}$	1	1	2.3	2.3	∞
19	Liquid conductivity (target)	B	5.0	R	$\sqrt{3}$	0.64	0.43	1.8	1.2	∞
20	Liquid conductivity	A	2.06	N	1	0.64	0.43	1.32	0.89	43

	(meas.)									
21	Liquid permittivity (target)	B	5.0	R	$\sqrt{3}$	0.6	0.49	1.7	1.4	∞
22	Liquid permittivity (meas.)	A	1.6	N	1	0.6	0.49	1.0	0.8	521
Combined standard uncertainty		$u_c = \sqrt{\sum_{i=1}^{22} c_i^2 u_i^2}$						10.4	10.3	257
Expanded uncertainty (confidence interval of 95 %)		$u_e = 2u_c$						20.8	20.6	

17 MAIN TEST INSTRUMENTS

Table 17.1: List of Main Instruments

No.	Name	Type	Serial Number	Calibration Date	Valid Period
01	Network analyzer	E5071C	MY46110673	January 14, 2021	One year
02	Power meter	NRVD	102083	October 23, 2020	One year
03	Power sensor	NRV-Z5	100542		
04	Signal Generator	E4438C	MY49071430	February 1, 2021	One Year
05	Amplifier	60S1G4	0331848	No Calibration Requested	
06	BTS	CMW500	159890	January 25 2021	One year
07	BTS	CMW500	159889	January 13 2021	One year
08	E-field Probe	SPEAG EX3DV4	7600	November 30, 2020	One year
09	DAE	SPEAG DAE4	1525	September 2, 2020	One year
10	Dipole Validation Kit	SPEAG D750V3	1017	July 24,2020	One year
11	Dipole Validation Kit	SPEAG D835V2	4d069	July 24,,2020	One year
12	Dipole Validation Kit	SPEAG D1750V2	1003	July 24, 2020	One year
13	Dipole Validation Kit	SPEAG D1900V2	5d101	July 28,2020	One year
14	Dipole Validation Kit	SPEAG D2450V2	853	July 21,2020	One year
15	Dipole Validation Kit	SPEAG D2600V2	1012	July 21,2020	One year

END OF REPORT BODY

ANNEX A Graph Results

GSM850_CH128 Left Cheek

Date: 6/24/2021

Electronics: DAE4 Sn1525

Medium: H835

Medium parameters used: $f = 825$ MHz; $\sigma = 0.859$ S/m; $\epsilon_r = 43.221$; $\rho = 1000$ kg/m³

Ambient Temperature: 22.5°C Liquid Temperature: 22.5°C

Communication System: GSM850 2TX Frequency: 824.2 MHz Duty Cycle: 1:4.00037

Probe: EX3DV4 - SN7600 ConvF(10.88, 10.88, 10.88)

Configuration/left cheek/Area Scan (81x131x1): Interpolated grid: dx=1.500 mm, dy=1.500 mm

Maximum value of SAR (interpolated) = 0.434 W/kg

Configuration/left cheek/Zoom Scan (6x6x7)/Cube 0: Measurement grid: dx=8mm, dy=8mm, dz=5mm

Reference Value = 7.048 V/m; Power Drift = -0.17 dB

Peak SAR (extrapolated) = 0.490 W/kg

SAR(1 g) = 0.373 W/kg; SAR(10 g) = 0.290 W/kg

Maximum value of SAR (measured) = 0.447 W/kg

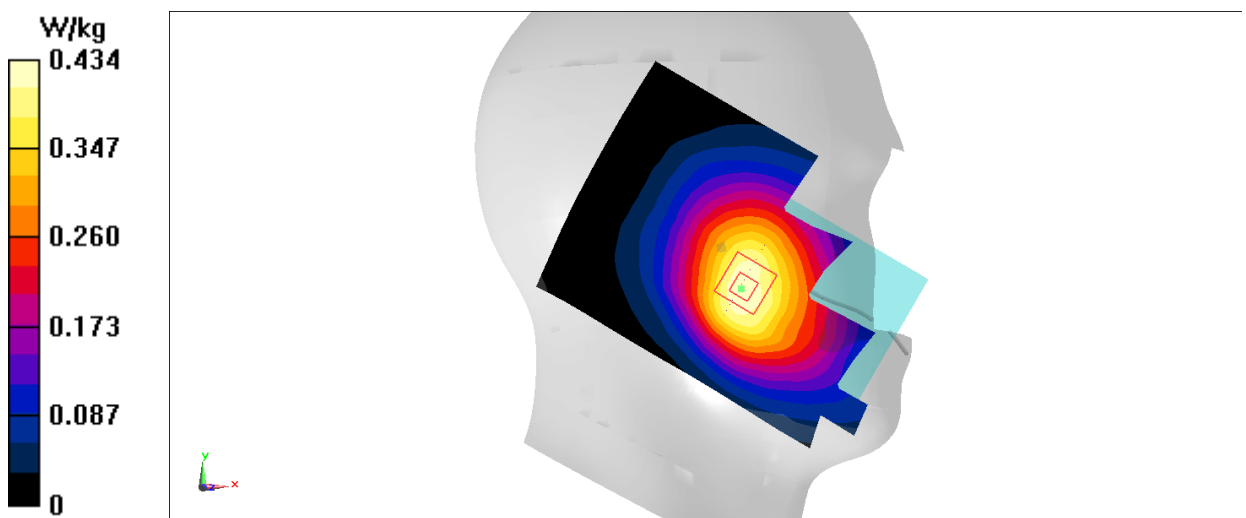

Fig A.1

GSM850_CH190 Bottom

Date: 6/24/2021

Electronics: DAE4 Sn1525

Medium: H835

Medium parameters used (interpolated): $f = 836.6$ MHz; $\sigma = 0.865$ S/m; $\epsilon_r = 43.173$; $\rho = 1000$ kg/m³

Ambient Temperature: 22.5oC Liquid Temperature: 22.5oC

Communication System: GSM850 2TX Frequency: 836.6 MHz Duty Cycle: 1:4.00037

Probe: EX3DV4 - SN7600 ConvF(10.88, 10.88, 10.88)

Area Scan (81x131x1): Interpolated grid: dx=1.500 mm, dy=1.500 mm

Maximum value of SAR (interpolated) = 0.519 W/kg

Zoom Scan (6x7x7)/Cube 0: Measurement grid: dx=8mm, dy=8mm, dz=5mm

Reference Value = 16.80 V/m; Power Drift = 0.14 dB

Peak SAR (extrapolated) = 0.689 W/kg

SAR(1 g) = 0.301 W/kg; SAR(10 g) = 0.167 W/kg

Maximum value of SAR (measured) = 0.518 W/kg

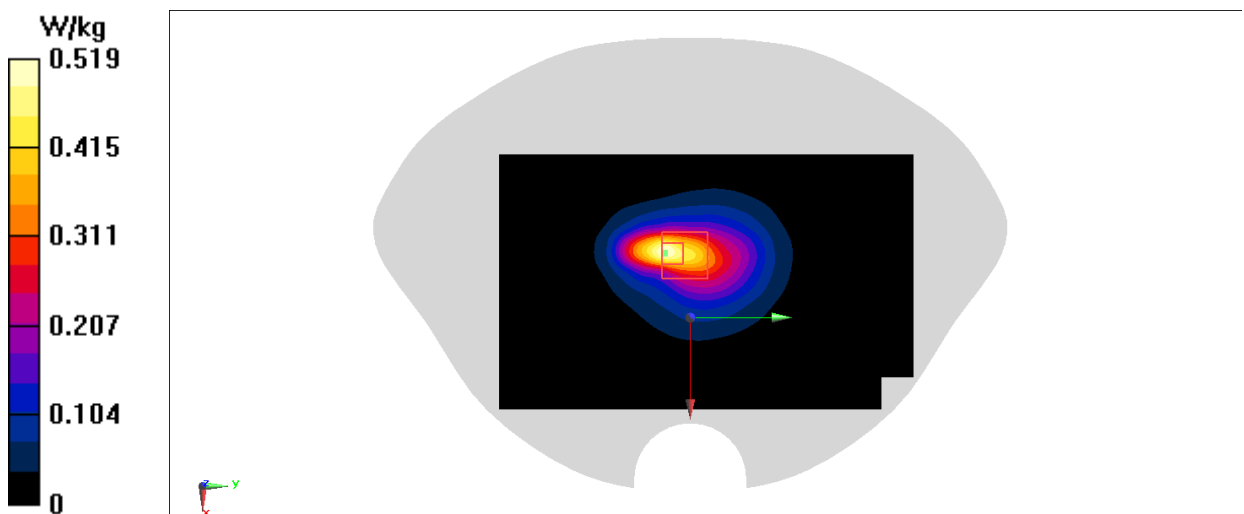
**Fig A.2**

PCS1900_CH512 Right Tilt

Date: 6/28/2021

Electronics: DAE4 Sn1525

Medium: H1900

Medium parameters used (interpolated): $f = 1850.2$ MHz; $\sigma = 1.413$ S/m; $\epsilon_r = 40.197$; $\rho = 1000$ kg/m³

Ambient Temperature: 23.1oC Liquid Temperature: 22.8oC

Communication System: GSM1900 2TX Frequency: 1850.2 MHz Duty Cycle: 1:4.00037

Probe: EX3DV4 - SN7600 ConvF(8.7, 8.7, 8.7)

Area Scan (81x131x1): Interpolated grid: dx=1.500 mm, dy=1.500 mm

Maximum value of SAR (interpolated) = 0.218 W/kg

Zoom Scan (5x6x7)/Cube 0: Measurement grid: dx=8mm, dy=8mm, dz=5mm

Reference Value = 10.07 V/m; Power Drift = 0.09 dB

Peak SAR (extrapolated) = 0.228 W/kg

SAR(1 g) = 0.146 W/kg; SAR(10 g) = 0.091 W/kg

Maximum value of SAR (measured) = 0.198 W/kg

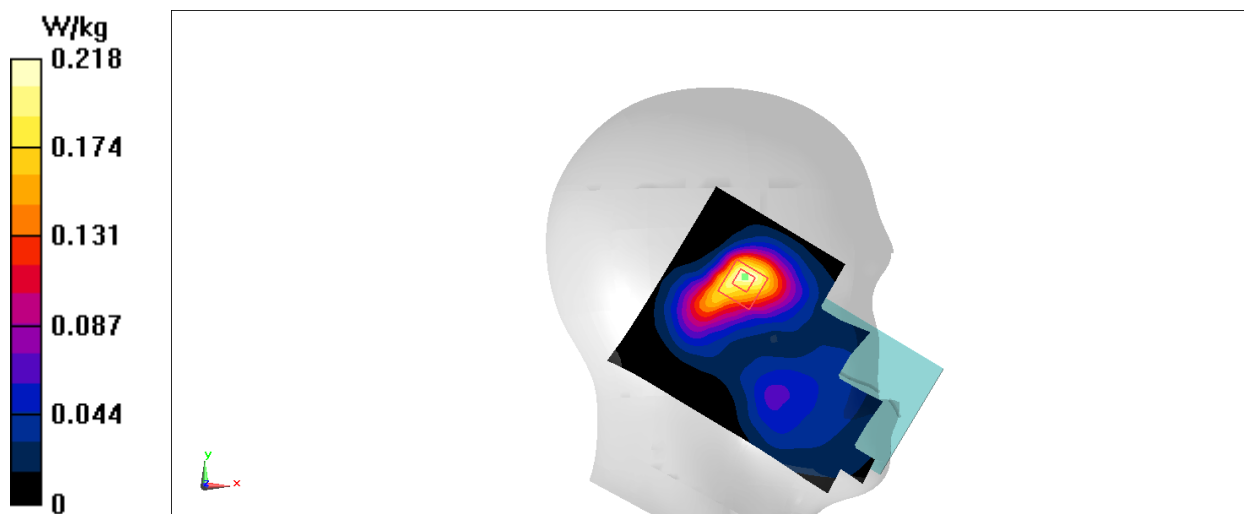
**Fig A.3**

PCS1900_CH810 Bottom

Date: 6/28/2021

Electronics: DAE4 Sn1525

Medium: H1900

Medium parameters used: $f = 1910$ MHz; $\sigma = 1.453$ S/m; $\epsilon_r = 40.289$; $\rho = 1000$ kg/m³

Ambient Temperature: 23.1oC Liquid Temperature: 22.8oC

Communication System: GSM1900 2TX Frequency: 1909.8 MHz Duty Cycle: 1:4.00037

Probe: EX3DV4 - SN7600 ConvF(8.7, 8.7, 8.7)

Area Scan (81x131x1): Interpolated grid: dx=1.500 mm, dy=1.500 mm

Maximum value of SAR (interpolated) = 1.30 W/kg

Zoom Scan (5x6x7)/Cube 0: Measurement grid: dx=8mm, dy=8mm, dz=5mm

Reference Value = 29.18 V/m; Power Drift = -0.09 dB

Peak SAR (extrapolated) = 1.60 W/kg

SAR(1 g) = 0.821 W/kg; SAR(10 g) = 0.425 W/kg

Maximum value of SAR (measured) = 1.28 W/kg

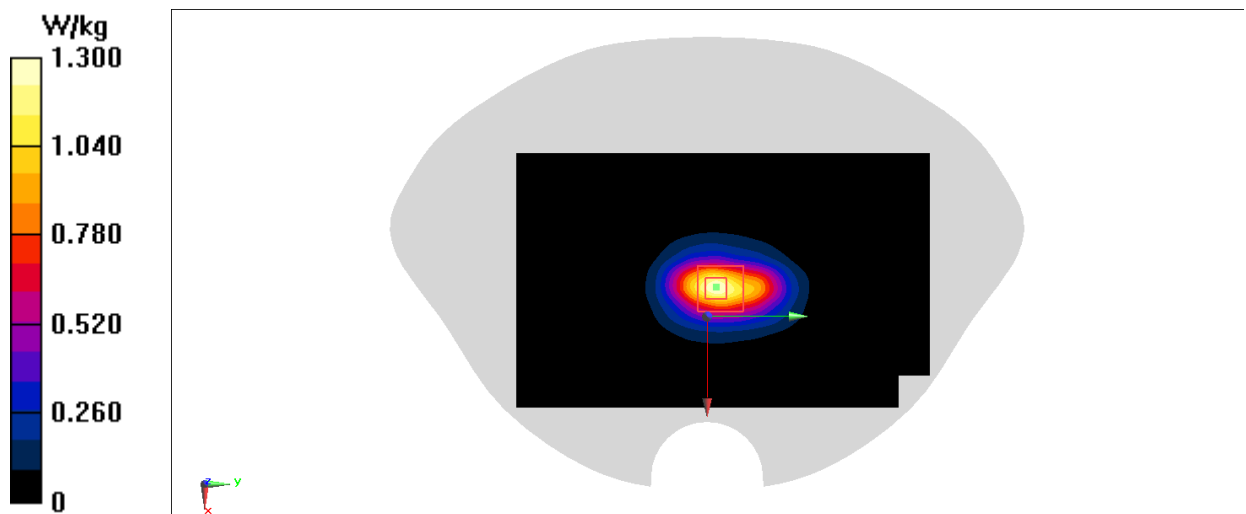
**Fig A.4**

WCDMA1900-BII_CH9262 Right Cheek

Date: 6/28/2021

Electronics: DAE4 Sn1525

Medium: H1900

Medium parameters used (interpolated): $f = 1852.4$ MHz; $\sigma = 1.414$ S/m; $\epsilon_r = 40.201$; $\rho = 1000$ kg/m³

Ambient Temperature: 23.1oC Liquid Temperature: 22.8oC

Communication System: WCDMA1900(B2) Frequency: 1852.4 MHz Duty Cycle: 1:1

Probe: EX3DV4 - SN7600 ConvF(8.7, 8.7, 8.7)

Area Scan (81x131x1): Interpolated grid: dx=1.500 mm, dy=1.500 mm

Maximum value of SAR (interpolated) = 0.151 W/kg

Zoom Scan (5x6x7)/Cube 0: Measurement grid: dx=8mm, dy=8mm, dz=5mm

Reference Value = 5.410 V/m; Power Drift = 0.05 dB

Peak SAR (extrapolated) = 0.160 W/kg

SAR(1 g) = 0.106 W/kg; SAR(10 g) = 0.069 W/kg

Maximum value of SAR (measured) = 0.137 W/kg

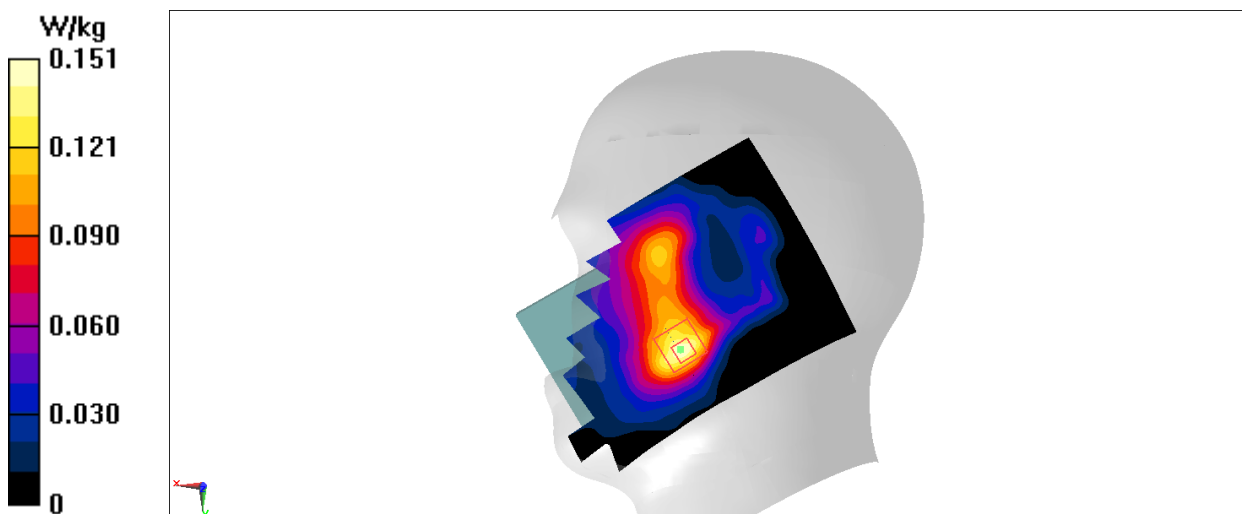
**Fig A.5**

WCDMA1900-BII_CH9400 Bottom

Date: 6/28/2021

Electronics: DAE4 Sn1525

Medium: H1900

Medium parameters used: $f = 1880$ MHz; $\sigma = 1.43$ S/m; $\epsilon_r = 40.25$; $\rho = 1000$ kg/m³

Ambient Temperature: 23.1oC Liquid Temperature: 22.8oC

Communication System: UID 0, WCDMA1900(B2) Frequency: 1880 MHz Duty Cycle: 1:1

Probe: EX3DV4 - SN7600 ConvF(8.7, 8.7, 8.7)

Area Scan (61x121x1): Interpolated grid: dx=1.500 mm, dy=1.500 mm

Maximum value of SAR (interpolated) = 1.06 W/kg

Zoom Scan (6x6x7)/Cube 0: Measurement grid: dx=8mm, dy=8mm, dz=5mm

Reference Value = 7.528 V/m; Power Drift = 0.15 dB

Peak SAR (extrapolated) = 1.34 W/kg

SAR(1 g) = 0.709 W/kg; SAR(10 g) = 0.384 W/kg

Maximum value of SAR (measured) = 1.08 W/kg

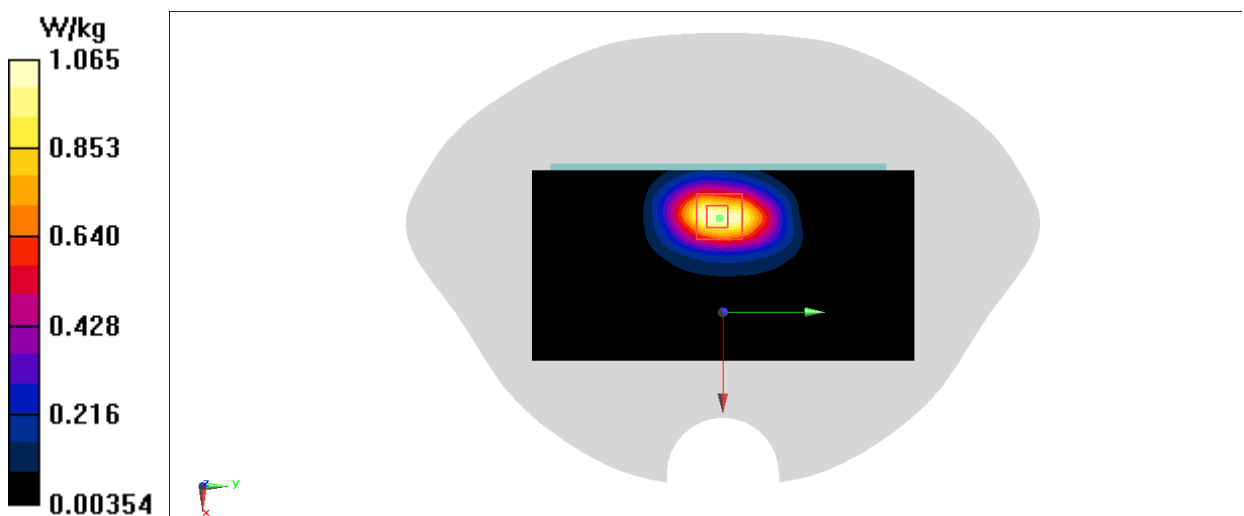
**Fig A.6**

WCDMA1700-BIV_CH1513 Left Tilt

Date: 6/26/2021

Electronics: DAE4 Sn1525

Medium: H1750

Medium parameters used (interpolated): $f = 1752.6$ MHz; $\sigma = 1.375$ S/m; $\epsilon_r = 40.297$; $\rho = 1000$ kg/m³

Ambient Temperature: 22.9°C Liquid Temperature: 22.8°C

Communication System: WCDMA1700(B4) Frequency: 1752.6 MHz Duty Cycle: 1:1

Probe: EX3DV4 - SN7600 ConvF(9.01, 9.01, 9.01); Calibrated: 11/30/2020

Area Scan (81x131x1): Interpolated grid: dx=1.500 mm, dy=1.500 mm

Maximum value of SAR (interpolated) = 0.119 W/kg

Zoom Scan (5x6x7)/Cube 0: Measurement grid: dx=8mm, dy=8mm, dz=5mm

Reference Value = 6.329 V/m; Power Drift = -0.09 dB

Peak SAR (extrapolated) = 0.119 W/kg

SAR(1 g) = 0.075 W/kg; SAR(10 g) = 0.048 W/kg

Maximum value of SAR (measured) = 0.101 W/kg

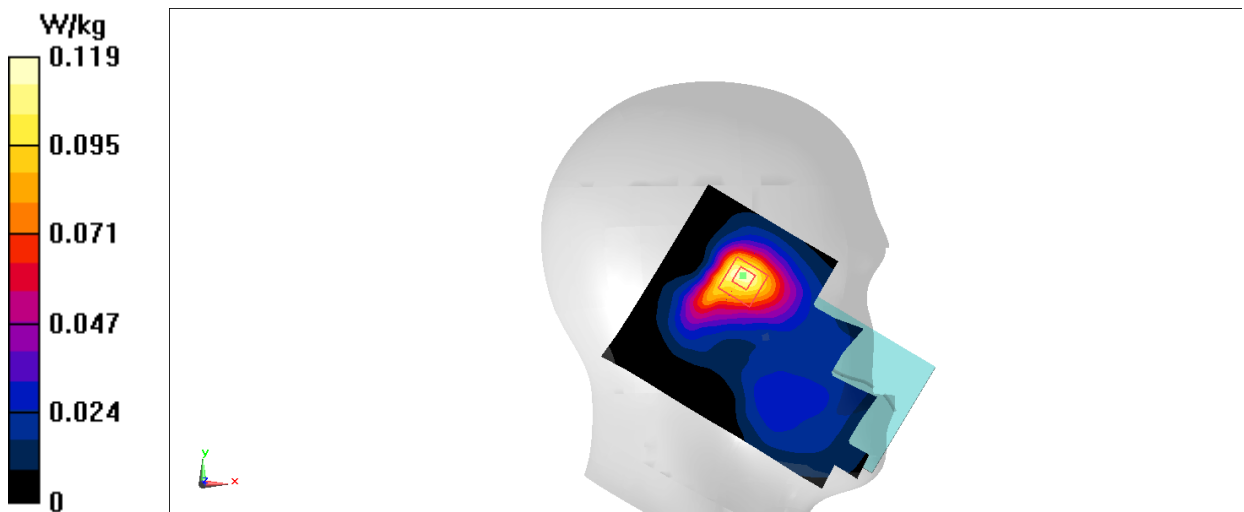
**Fig A.7**

WCDMA1700-BIV_CH1312 Rear

Date: 6/26/2021

Electronics: DAE4 Sn1525

Medium: H1750

Medium parameters used (interpolated): $f = 1712.4$ MHz; $\sigma = 1.356$ S/m; $\epsilon_r = 40.431$; $\rho = 1000$ kg/m³

Ambient Temperature: 22.9°C Liquid Temperature: 22.8°C

Communication System: WCDMA1700(B4) Frequency: 1712.4 MHz Duty Cycle: 1:1

Probe: EX3DV4 - SN7600 ConvF(9.01, 9.01, 9.01)

Area Scan (81x131x1): Interpolated grid: dx=1.500 mm, dy=1.500 mm

Maximum value of SAR (interpolated) = 0.811 W/kg

Zoom Scan (5x6x7)/Cube 0: Measurement grid: dx=8mm, dy=8mm, dz=5mm

Reference Value = 12.68 V/m; Power Drift = 0.03 dB

Peak SAR (extrapolated) = 0.942 W/kg

SAR(1 g) = 0.556 W/kg; SAR(10 g) = 0.340 W/kg

Maximum value of SAR (measured) = 0.790 W/kg

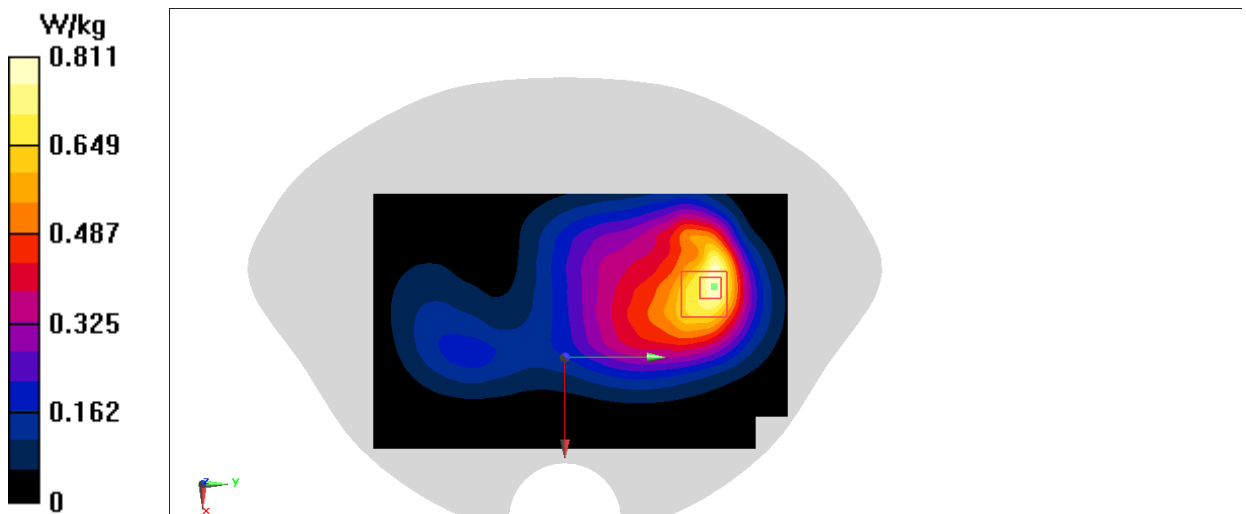
**Fig A.8**

WCDMA850-BV_CH4132 Right Cheek

Date: 6/24/2021

Electronics: DAE4 Sn1525

Medium: H835

Medium parameters used (interpolated): $f = 826.4$ MHz; $\sigma = 0.859$ S/m; $\epsilon_r = 43.21$; $\rho = 1000$ kg/m³

Ambient Temperature: 22.5°C Liquid Temperature: 22.5°C

Communication System: WCDMA850(B5) Frequency: 826.4 MHz Duty Cycle: 1:1

Probe: EX3DV4 - SN7600 ConvF(10.88, 10.88, 10.88)

Area Scan (81x131x1): Interpolated grid: dx=1.500 mm, dy=1.500 mm

Maximum value of SAR (interpolated) = 0.291 W/kg

Zoom Scan (6x6x7)/Cube 0: Measurement grid: dx=8mm, dy=8mm, dz=5mm

Reference Value = 5.726 V/m; Power Drift = -0.19 dB

Peak SAR (extrapolated) = 0.328 W/kg

SAR(1 g) = 0.248 W/kg; SAR(10 g) = 0.192 W/kg

Maximum value of SAR (measured) = 0.298 W/kg

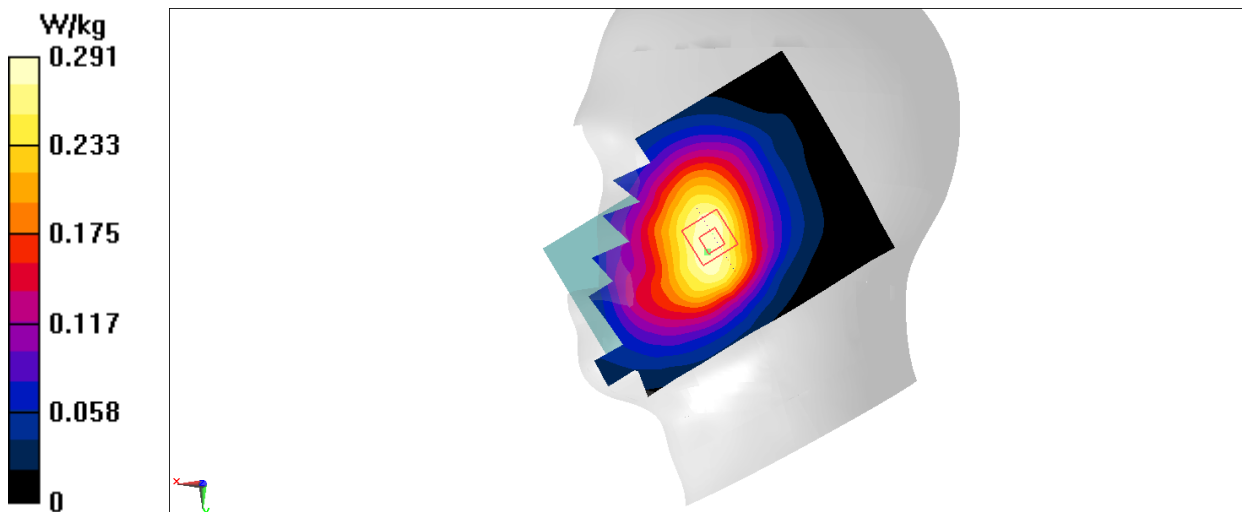
**Fig A.9**

WCDMA850-BV_CH4132 Rear

Date: 6/24/2021

Electronics: DAE4 Sn1525

Medium: H835

Medium parameters used (interpolated): $f = 826.4$ MHz; $\sigma = 0.859$ S/m; $\epsilon_r = 43.21$; $\rho = 1000$ kg/m³

Ambient Temperature: 22.5°C Liquid Temperature: 22.5°C

Communication System: WCDMA850(B5) Frequency: 826.4 MHz Duty Cycle: 1:1

Probe: EX3DV4 - SN7600 ConvF(10.88, 10.88, 10.88)

Area Scan (81x131x1): Interpolated grid: $dx=1.500$ mm, $dy=1.500$ mm

Maximum value of SAR (interpolated) = 0.351 W/kg

Zoom Scan (6x7x7)/Cube 0: Measurement grid: $dx=8$ mm, $dy=8$ mm, $dz=5$ mm

Reference Value = 20.27 V/m; Power Drift = -0.19 dB

Peak SAR (extrapolated) = 0.490 W/kg

SAR(1 g) = 0.220 W/kg; SAR(10 g) = 0.121 W/kg

Maximum value of SAR (measured) = 0.346 W/kg

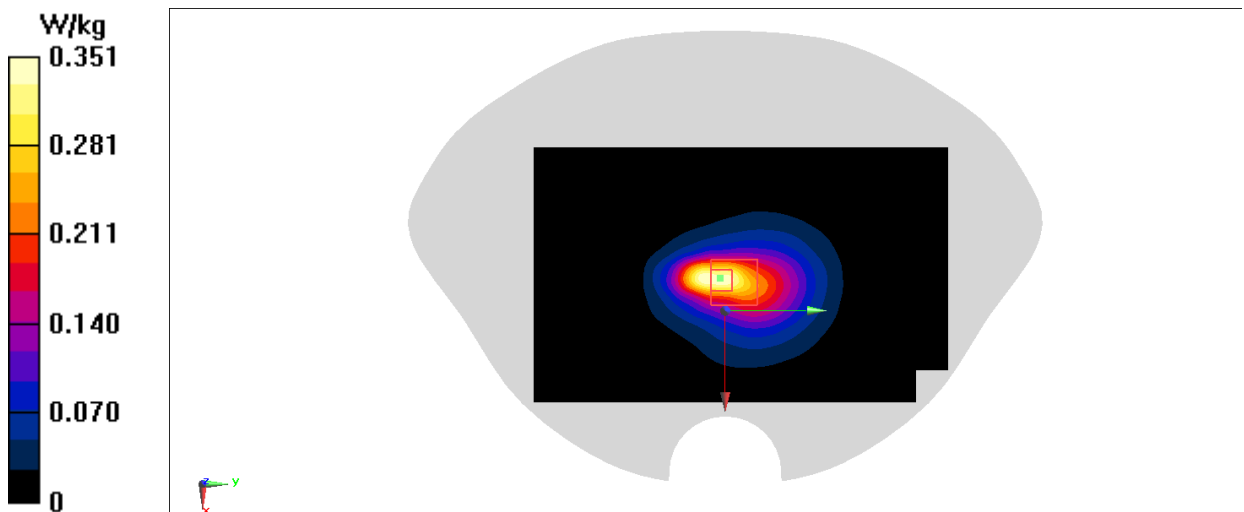
**Fig A.10**

LTE1900-FDD2_CH19100 Left Tilt

Date: 6/29/2021

Electronics: DAE4 Sn1525

Medium: H1900

Medium parameters used: $f = 1900$ MHz; $\sigma = 1.438$ S/m; $\epsilon_r = 43.378$; $\rho = 1000$ kg/m³

Ambient Temperature: 22.9oC Liquid Temperature: 22.4oC

Communication System: LTE Band2 Frequency: 1900 MHz Duty Cycle: 1:1

Probe: EX3DV4 - SN7600 ConvF(8.7, 8.7, 8.7)

Area Scan (81x131x1): Interpolated grid: dx=1.500 mm, dy=1.500 mm

Maximum value of SAR (interpolated) = 0.0906 W/kg

Zoom Scan (6x6x7)/Cube 0: Measurement grid: dx=8mm, dy=8mm, dz=5mm

Reference Value = 6.049 V/m; Power Drift = -0.13 dB

Peak SAR (extrapolated) = 0.0930 W/kg

SAR(1 g) = 0.057 W/kg; SAR(10 g) = 0.035 W/kg

Maximum value of SAR (measured) = 0.0779 W/kg

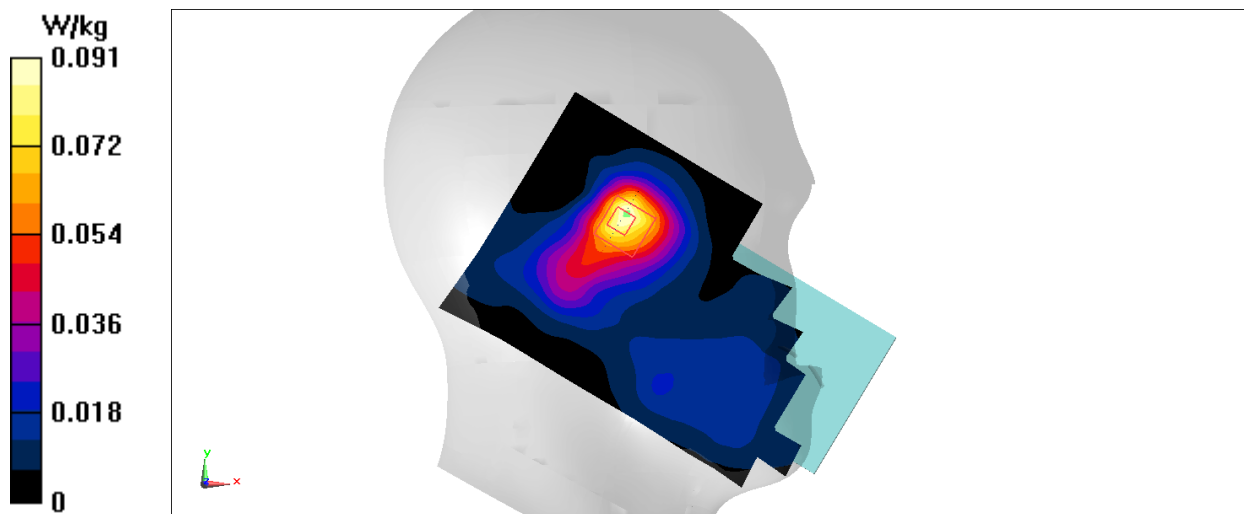
**Fig A.11**

LTE1900-FDD2_CH19100 Bottom

Date: 6/29/2021

Electronics: DAE4 Sn1525

Medium: H1900

Medium parameters used: $f = 1900$ MHz; $\sigma = 1.438$ S/m; $\epsilon_r = 43.378$; $\rho = 1000$ kg/m³

Ambient Temperature: 22.9oC Liquid Temperature: 22.4oC

Communication System: LTE Band2 Frequency: 1900 MHz Duty Cycle: 1:1

Probe: EX3DV4 - SN7600 ConvF(8.7, 8.7, 8.7)

Area Scan (81x131x1): Interpolated grid: dx=1.500 mm, dy=1.500 mm

Maximum value of SAR (interpolated) = 1.09 W/kg

/Zoom Scan (5x6x7)/Cube 0: Measurement grid: dx=8mm, dy=8mm, dz=5mm

Reference Value = 20.47 V/m; Power Drift = -0.12 dB

Peak SAR (extrapolated) = 1.36 W/kg

SAR(1 g) = 0.710 W/kg; SAR(10 g) = 0.375 W/kg

Maximum value of SAR (measured) = 1.11 W/kg

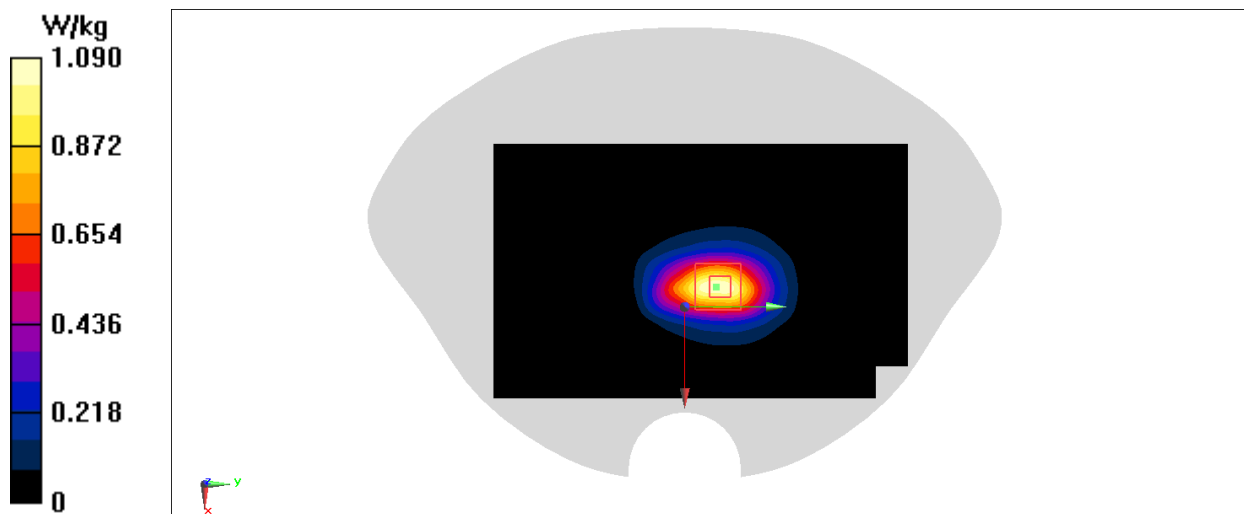

Fig A.12

LTE1750-FDD4_CH20300 Left Tilt

Date: 6/27/2021

Electronics: DAE4 Sn1525

Medium: H1750

Medium parameters used: $f = 1745$ MHz; $\sigma = 1.358$ S/m; $\epsilon_r = 43.776$; $\rho = 1000$ kg/m³

Ambient Temperature: 22.6oC Liquid Temperature: 22.5oC

Communication System: LTE Band4 Frequency: 1745 MHz Duty Cycle: 1:1

Probe: EX3DV4 - SN7600 ConvF(9.01, 9.01, 9.01)

Area Scan (81x131x1): Interpolated grid: dx=1.500 mm, dy=1.500 mm

Maximum value of SAR (interpolated) = 0.0986 W/kg

Zoom Scan (5x5x7)/Cube 0: Measurement grid: dx=8mm, dy=8mm, dz=5mm

Reference Value = 4.410 V/m; Power Drift = 0.11 dB

Peak SAR (extrapolated) = 0.111 W/kg

SAR(1 g) = 0.070 W/kg; SAR(10 g) = 0.046 W/kg

Maximum value of SAR (measured) = 0.0935 W/kg

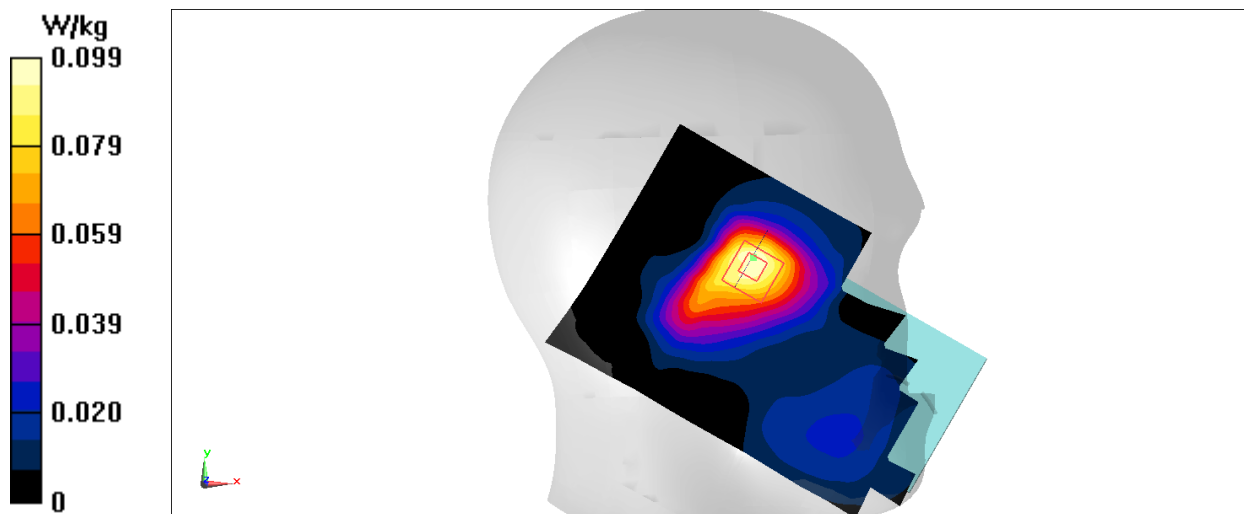

Fig A.13

LTE1750-FDD4_CH20300 Rear

Date: 6/27/2021

Electronics: DAE4 Sn1525

Medium: H1750

Medium parameters used: $f = 1745$ MHz; $\sigma = 1.358$ S/m; $\epsilon_r = 43.776$; $\rho = 1000$ kg/m³

Ambient Temperature: 22.6oC Liquid Temperature: 22.5oC

Communication System: LTE Band4 Frequency: 1745 MHz Duty Cycle: 1:1

Probe: EX3DV4 - SN7600 ConvF(9.01, 9.01, 9.01)

Area Scan (81x131x1): Interpolated grid: dx=1.500 mm, dy=1.500 mm

Maximum value of SAR (interpolated) = 0.781 W/kg

Zoom Scan (6x6x7)/Cube 0: Measurement grid: dx=8mm, dy=8mm, dz=5mm

Reference Value = 10.36 V/m; Power Drift = 0.05 dB

Peak SAR (extrapolated) = 0.881 W/kg

SAR(1 g) = 0.527 W/kg; SAR(10 g) = 0.320 W/kg

Maximum value of SAR (measured) = 0.738 W/kg

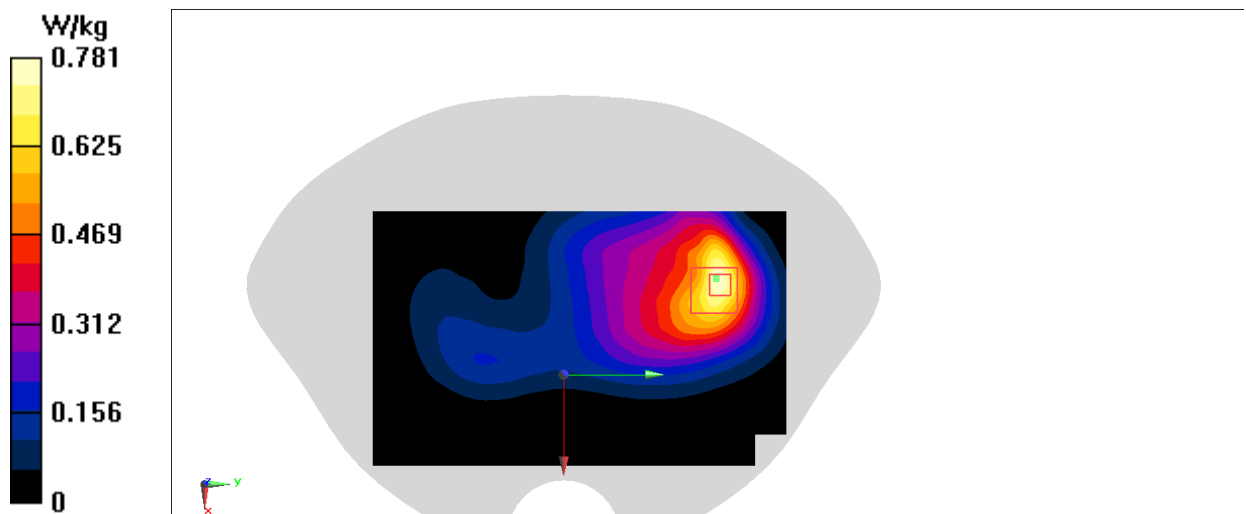

Fig A.14

LTE835-FDD5_CH20450 Left Cheek

Date: 6/24/2021

Electronics: DAE4 Sn1525

Medium: H835

Medium parameters used (interpolated): $f = 829$ MHz; $\sigma = 0.8612$ S/m; $\epsilon_r = 43.2$; $\rho = 1000$ kg/m³

Ambient Temperature: 22.5°C Liquid Temperature: 22.5°C

Communication System: LTE Band5 Frequency: 829 MHz Duty Cycle: 1:1

Probe: EX3DV4 - SN7600 ConvF(10.88, 10.88, 10.88)

Area Scan (81x131x1): Interpolated grid: dx=1.500 mm, dy=1.500 mm

Maximum value of SAR (interpolated) = 0.237 W/kg

Zoom Scan (6x5x7)/Cube 0: Measurement grid: dx=8mm, dy=8mm, dz=5mm

Reference Value = 4.943 V/m; Power Drift = 0.13 dB

Peak SAR (extrapolated) = 0.268 W/kg

SAR(1 g) = 0.203 W/kg; SAR(10 g) = 0.160 W/kg

Maximum value of SAR (measured) = 0.240 W/kg

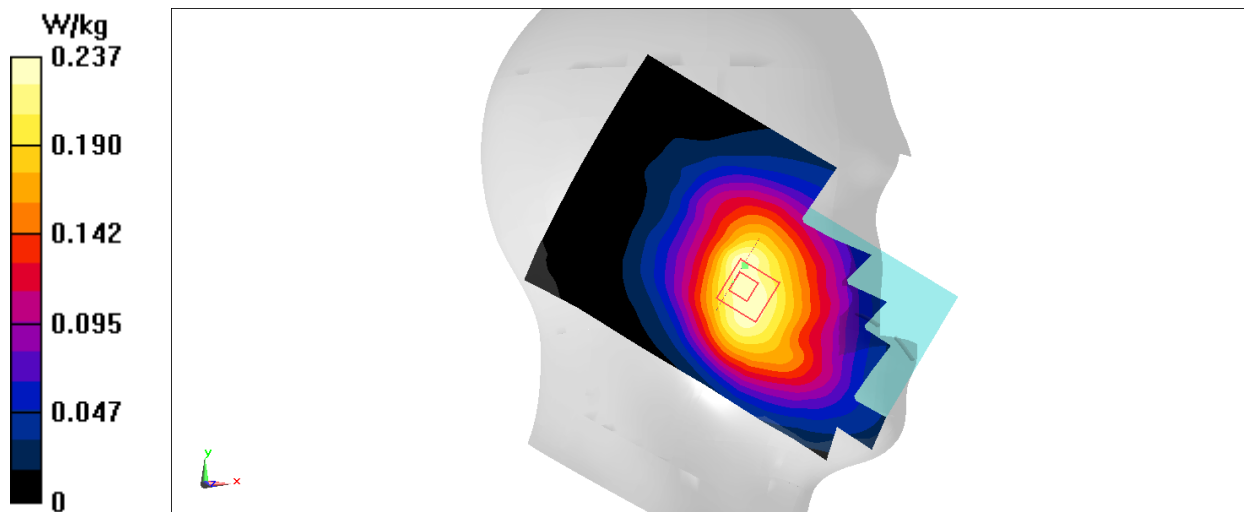

Fig A.15

LTE835-FDD5_CH20450 Rear

Date: 6/24/2021

Electronics: DAE4 Sn1525

Medium: H835

Medium parameters used (interpolated): $f = 829$ MHz; $\sigma = 0.8612$ S/m; $\epsilon_r = 43.2$; $\rho = 1000$ kg/m³

Ambient Temperature: 22.5°C Liquid Temperature: 22.5°C

Communication System: LTE Band5 Frequency: 829 MHz Duty Cycle: 1:1

Probe: EX3DV4 - SN7600 ConvF(10.88, 10.88, 10.88)

Area Scan (81x131x1): Interpolated grid: dx=1.500 mm, dy=1.500 mm

Maximum value of SAR (interpolated) = 0.424 W/kg

Zoom Scan (6x6x7)/Cube 0: Measurement grid: dx=8mm, dy=8mm, dz=5mm

Reference Value = 18.96 V/m; Power Drift = 0.01 dB

Peak SAR (extrapolated) = 0.550 W/kg

SAR(1 g) = 0.304 W/kg; SAR(10 g) = 0.183 W/kg

Maximum value of SAR (measured) = 0.437 W/kg

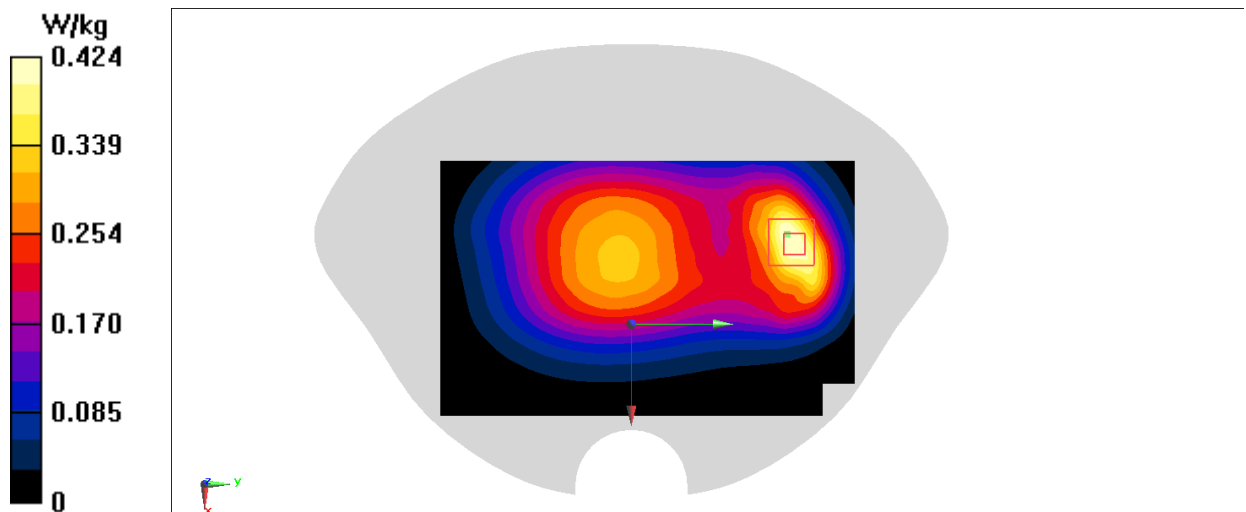
**Fig A.16**

LTE2500-FDD7_CH21350 Left Cheek

Date: 7/1/2021

Electronics: DAE4 Sn1525

Medium: H2600

Medium parameters used: $f = 2560$ MHz; $\sigma = 1.958$ S/m; $\epsilon_r = 42.49$; $\rho = 1000$ kg/m³

Ambient Temperature: 22.9oC Liquid Temperature: 22.6oC

Communication System: LTE Band7 Frequency: 2560 MHz Duty Cycle: 1:1

Probe: EX3DV4 - SN7600 ConvF(7.67, 7.67, 7.67)

Area Scan (101x161x1): Interpolated grid: dx=1.200 mm, dy=1.200 mm

Maximum value of SAR (interpolated) = 0.287 W/kg

Zoom Scan (7x7x7)/Cube 0: Measurement grid: dx=5mm, dy=5mm, dz=5mm

Reference Value = 3.592 V/m; Power Drift = 0.01 dB

Peak SAR (extrapolated) = 0.342 W/kg

SAR(1 g) = 0.185 W/kg; SAR(10 g) = 0.100 W/kg

Maximum value of SAR (measured) = 0.284 W/kg

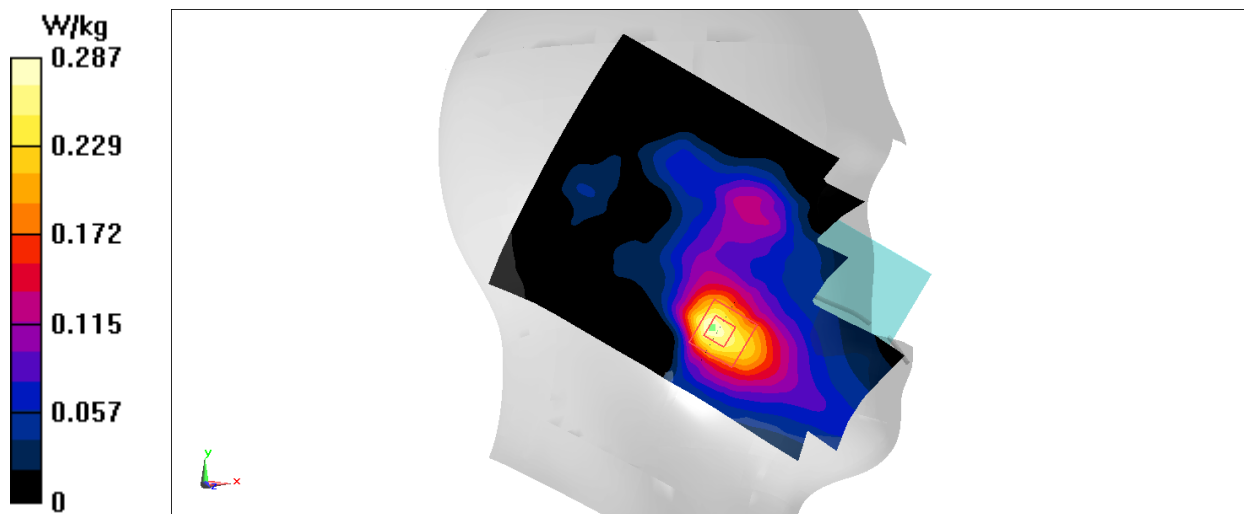

Fig A.17

LTE2500-FDD7_CH21350 Rear

Date: 7/1/2021

Electronics: DAE4 Sn1525

Medium: H2600

Medium parameters used: $f = 2560$ MHz; $\sigma = 1.958$ S/m; $\epsilon_r = 42.49$; $\rho = 1000$ kg/m³

Ambient Temperature: 22.9oC Liquid Temperature: 22.6oC

Communication System: LTE Band7 Frequency: 2560 MHz Duty Cycle: 1:1

Probe: EX3DV4 - SN7600 ConvF(7.67, 7.67, 7.67)

Area Scan (101x161x1): Interpolated grid: dx=1.200 mm, dy=1.200 mm

Maximum value of SAR (interpolated) = 0.874 W/kg

Zoom Scan (7x8x7)/Cube 0: Measurement grid: dx=5mm, dy=5mm, dz=5mm

Reference Value = 8.700 V/m; Power Drift = -0.05 dB

Peak SAR (extrapolated) = 1.06 W/kg

SAR(1 g) = 0.557 W/kg; SAR(10 g) = 0.298 W/kg

Maximum value of SAR (measured) = 0.867 W/kg

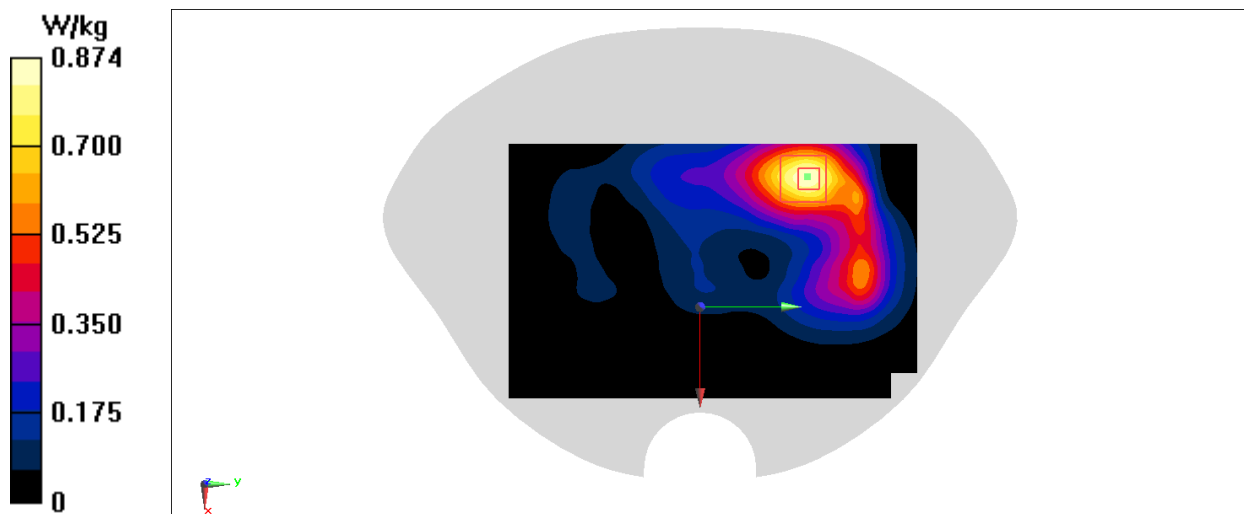

Fig A.18

LTE700-FDD12_CH23060 Right Cheek

Date: 6/25/2021

Electronics: DAE4 Sn1525

Medium: H750

Medium parameters used (interpolated): $f = 704 \text{ MHz}$; $\sigma = 0.805 \text{ S/m}$; $\epsilon_r = 43.733$; $\rho = 1000 \text{ kg/m}^3$

Ambient Temperature: 22.7°C Liquid Temperature: 22.3°C

Communication System: LTE Band12 Frequency: 704 MHz Duty Cycle: 1:1

Probe: EX3DV4 - SN7600 ConvF(10.88, 10.88, 10.88)

Area Scan (81x131x1): Interpolated grid: $dx=1.500 \text{ mm}$, $dy=1.500 \text{ mm}$

Maximum value of SAR (interpolated) = 0.197 W/kg

Zoom Scan (6x6x7)/Cube 0: Measurement grid: $dx=8\text{mm}$, $dy=8\text{mm}$, $dz=5\text{mm}$

Reference Value = 5.779 V/m; Power Drift = 0.13 dB

Peak SAR (extrapolated) = 0.218 W/kg

SAR(1 g) = 0.169 W/kg; SAR(10 g) = 0.133 W/kg

Maximum value of SAR (measured) = 0.199 W/kg

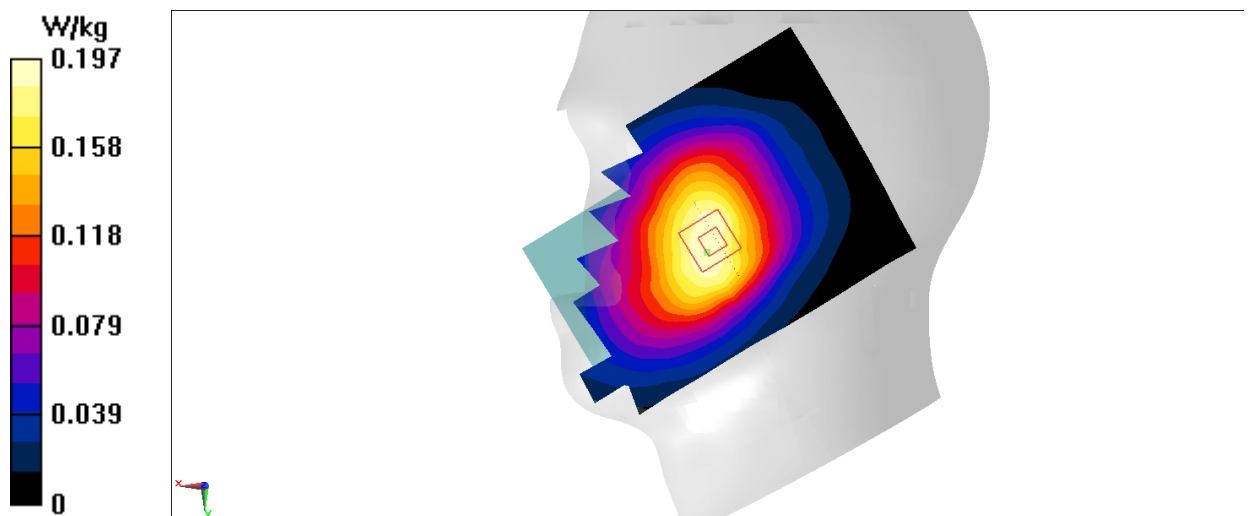

Fig A.19

LTE700-FDD12_CH23060 Right

Date: 6/25/2021

Electronics: DAE4 Sn1525

Medium: H750

Medium parameters used (interpolated): $f = 704$ MHz; $\sigma = 0.805$ S/m; $\epsilon_r = 43.733$; $\rho = 1000$ kg/m³

Ambient Temperature: 22.7°C Liquid Temperature: 22.3°C

Communication System: LTE Band12 Frequency: 704 MHz Duty Cycle: 1:1

Probe: EX3DV4 - SN7600 ConvF(10.88, 10.88, 10.88)

Area Scan (81x131x1): Interpolated grid: dx=1.500 mm, dy=1.500 mm

Maximum value of SAR (interpolated) = 0.182 W/kg

Zoom Scan (5x6x7)/Cube 0: Measurement grid: dx=8mm, dy=8mm, dz=5mm

Reference Value = 12.39 V/m; Power Drift = 0.11 dB

Peak SAR (extrapolated) = 0.211 W/kg

SAR(1 g) = 0.138 W/kg; SAR(10 g) = 0.097 W/kg

Maximum value of SAR (measured) = 0.182 W/kg

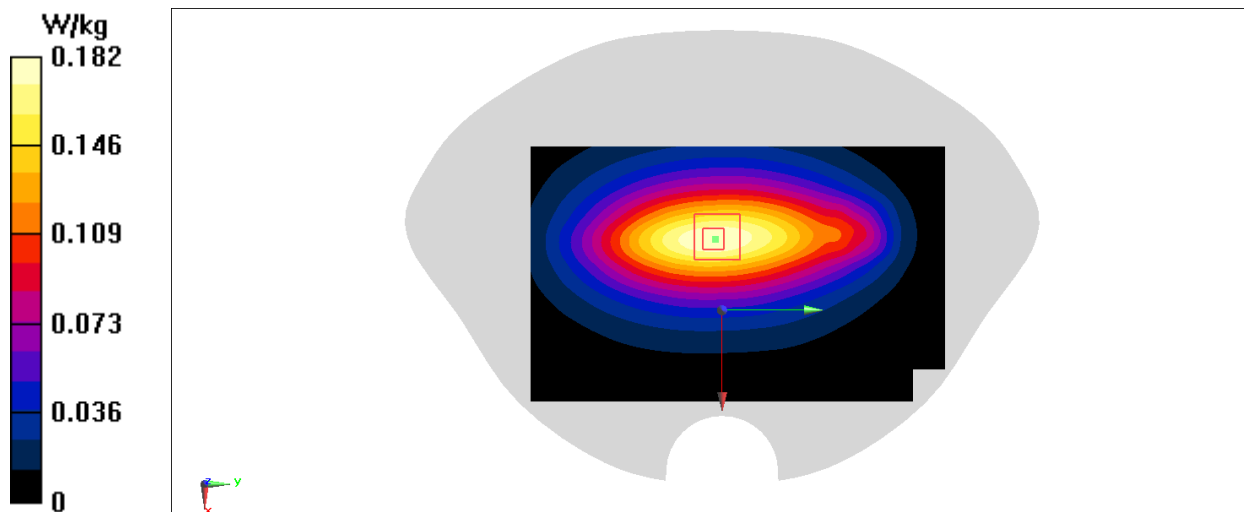
**Fig A.20**

LTE1700-FDD66_CH132322 Right Cheek

Date: 6/26/2021

Electronics: DAE4 Sn1525

Medium: H1750

Medium parameters used: $f = 1745$ MHz; $\sigma = 1.372$ S/m; $\epsilon_r = 40.319$; $\rho = 1000$ kg/m³

Ambient Temperature: 22.9oC Liquid Temperature: 22.8oC

Communication System: LTE Band66 Frequency: 1745 MHz Duty Cycle: 1:1

Probe: EX3DV4 - SN7600 ConvF(9.01, 9.01, 9.01)

Area Scan (81x131x1): Interpolated grid: dx=1.500 mm, dy=1.500 mm

Maximum value of SAR (interpolated) = 0.115 W/kg

Zoom Scan (5x6x7)/Cube 0: Measurement grid: dx=8mm, dy=8mm, dz=5mm

Reference Value = 3.839 V/m; Power Drift = -0.10 dB

Peak SAR (extrapolated) = 0.133 W/kg

SAR(1 g) = 0.083 W/kg; SAR(10 g) = 0.053 W/kg

Maximum value of SAR (measured) = 0.112 W/kg

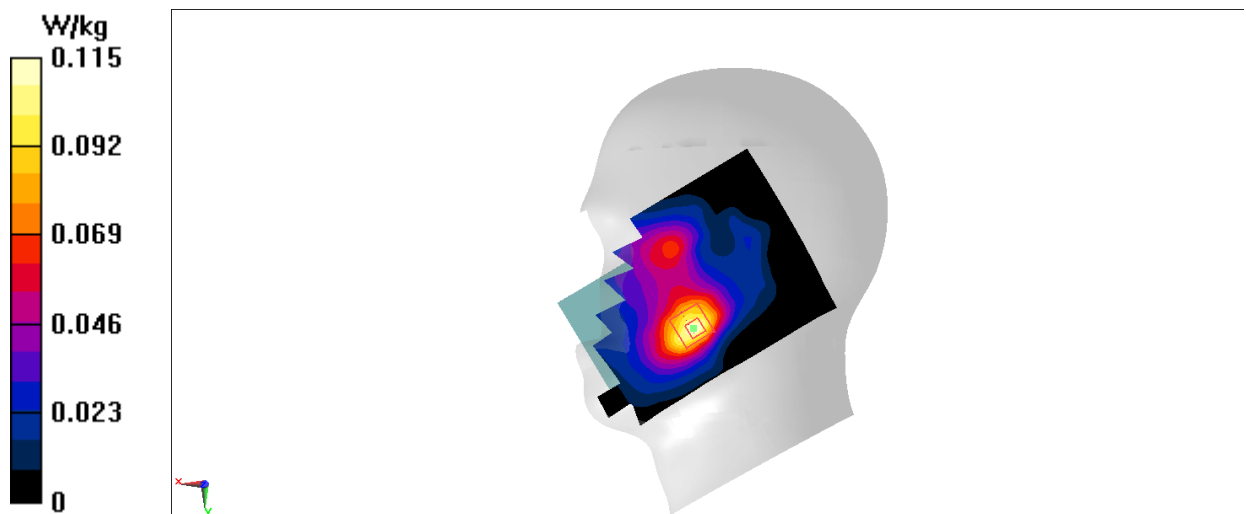

Fig A.21

LTE1700-FDD66_CH132322 Rear

Date: 6/26/2021

Electronics: DAE4 Sn1525

Medium: H1750

Medium parameters used: $f = 1745$ MHz; $\sigma = 1.372$ S/m; $\epsilon_r = 40.319$; $\rho = 1000$ kg/m³

Ambient Temperature: 22.9oC Liquid Temperature: 22.8oC

Communication System: LTE Band66 Frequency: 1745 MHz Duty Cycle: 1:1

Probe: EX3DV4 - SN7600 ConvF(9.01, 9.01, 9.01)

Area Scan (81x131x1): Interpolated grid: dx=1.500 mm, dy=1.500 mm

Maximum value of SAR (interpolated) = 1.33 W/kg

Zoom Scan (5x6x7)/Cube 0: Measurement grid: dx=8mm, dy=8mm, dz=5mm

Reference Value = 9.259 V/m; Power Drift = -0.12 dB

Peak SAR (extrapolated) = 0.848 W/kg

SAR(1 g) = 0.505 W/kg; SAR(10 g) = 0.307 W/kg

Maximum value of SAR (measured) = 0.714 W/kg

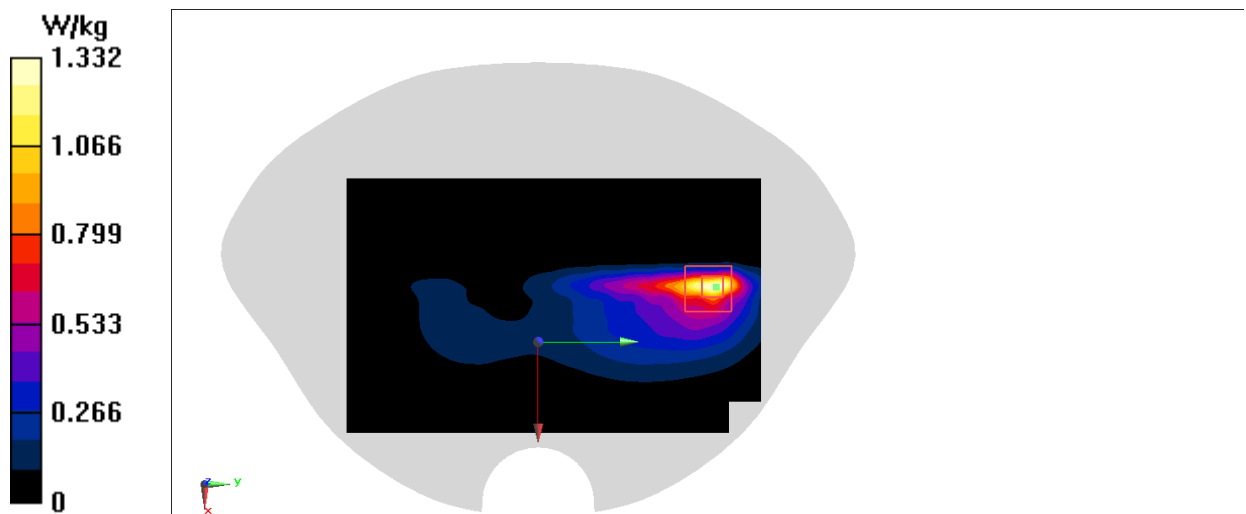

Fig A.22

WLAN2450_CH6 Left Tilt

Date: 6/30/2021

Electronics: DAE4 Sn1525

Medium: H2450

Medium parameters used (interpolated): $f = 2437$ MHz; $\sigma = 1.881$ S/m; $\epsilon_r = 39.112$; $\rho = 1000$ kg/m³

Ambient Temperature: 22.7°C Liquid Temperature: 22.5°C

Communication System: WIFI 2450 Frequency: 2437 MHz Duty Cycle: 1:1

Probe: EX3DV4 - SN7600 ConvF(7.79, 7.79, 7.79)

Area Scan (101x161x1): Interpolated grid: dx=1.200 mm, dy=1.200 mm

Maximum value of SAR (interpolated) = 0.305 W/kg

Zoom Scan (7x8x7)/Cube 0: Measurement grid: dx=5mm, dy=5mm, dz=5mm

Reference Value = 6.210 V/m; Power Drift = 0.16 dB

Peak SAR (extrapolated) = 0.433 W/kg

SAR(1 g) = 0.166 W/kg; SAR(10 g) = 0.070 W/kg

Maximum value of SAR (measured) = 0.301 W/kg

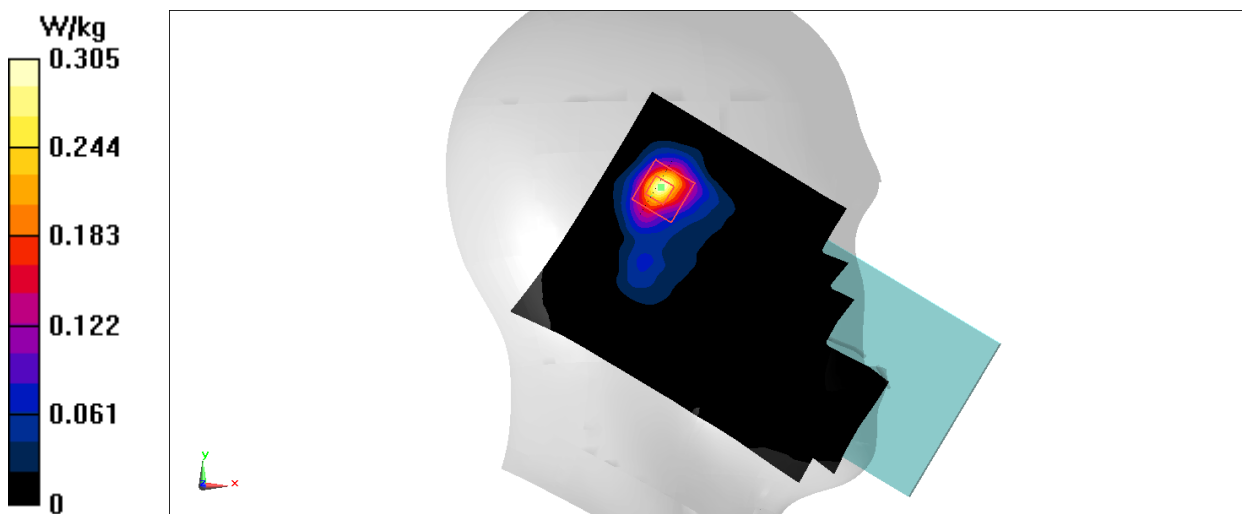

Fig A.23

WLAN2450_CH6 Rear

Date: 6/30/2021

Electronics: DAE4 Sn1525

Medium: H2450

Medium parameters used (interpolated): $f = 2437$ MHz; $\sigma = 1.881$ S/m; $\epsilon_r = 39.112$; $\rho = 1000$ kg/m³

Ambient Temperature: 22.7°C Liquid Temperature: 22.5°C

Communication System: WIFI 2450 Frequency: 2437 MHz Duty Cycle: 1:1

Probe: EX3DV4 - SN7600 ConvF(7.79, 7.79, 7.79)

Area Scan (101x161x1): Interpolated grid: dx=1.200 mm, dy=1.200 mm

Maximum value of SAR (interpolated) = 0.320 W/kg

Zoom Scan (7x9x7)/Cube 0: Measurement grid: dx=5mm, dy=5mm, dz=5mm

Reference Value = 4.983 V/m; Power Drift = 0.14 dB

Peak SAR (extrapolated) = 0.406 W/kg

SAR(1 g) = 0.186 W/kg; SAR(10 g) = 0.089 W/kg

Maximum value of SAR (measured) = 0.312 W/kg

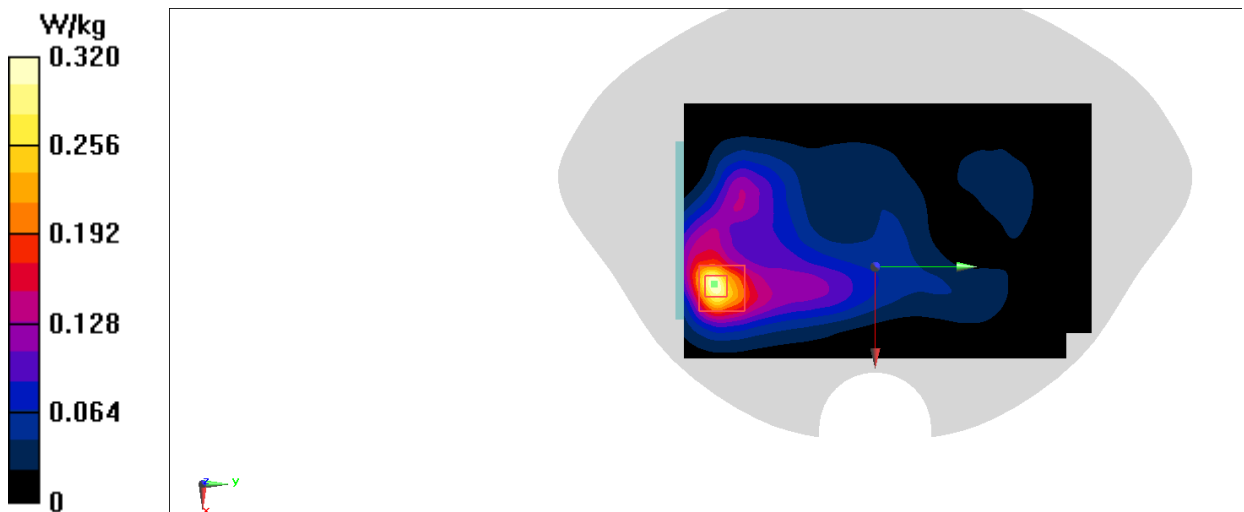

Fig A.24

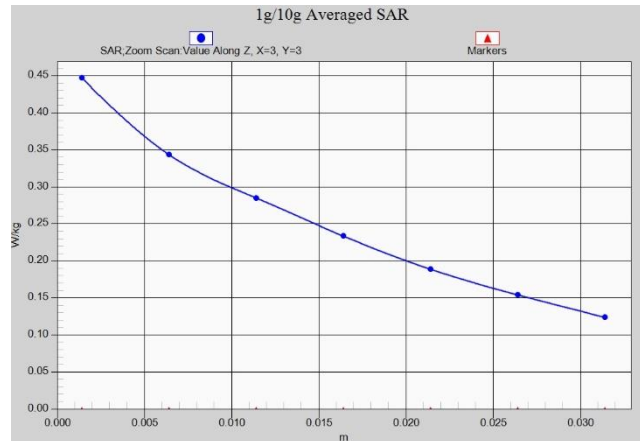

Fig. 1-1 Z-Scan at power reference point (GSM850)

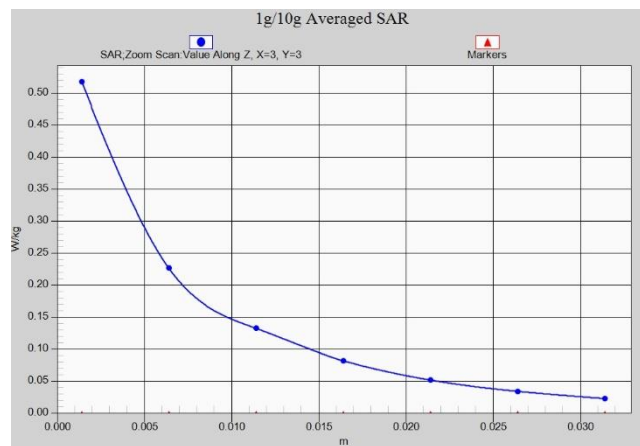

Fig. 1-2 Z-Scan at power reference point (GSM850)



Fig. 1-3 Z-Scan at power reference point (PCS1900)

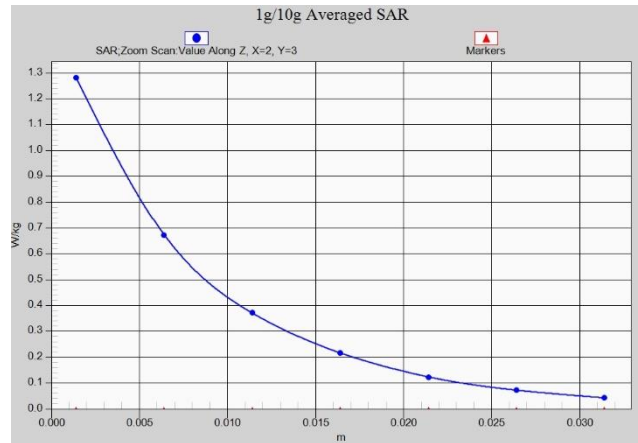

Fig. 1-4 Z-Scan at power reference point (PCS1900)

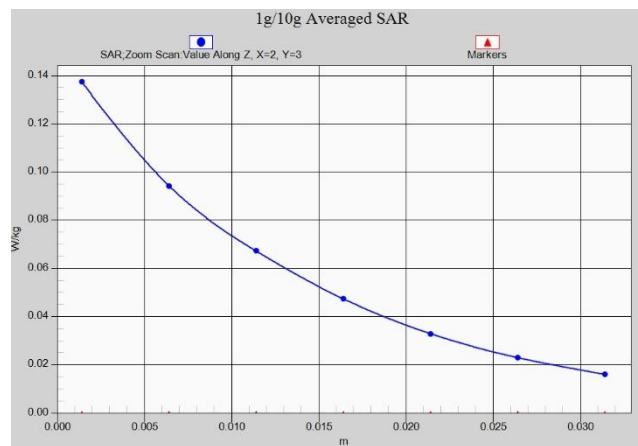

Fig. 1-5 Z-Scan at power reference point (WCDMA1900)

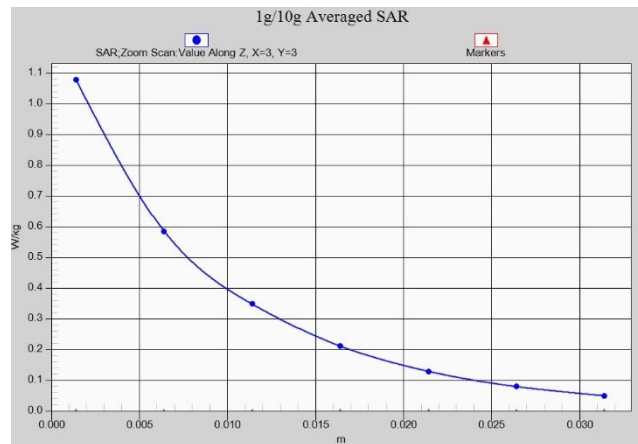

Fig. 1-6 Z-Scan at power reference point (WCDMA1900)

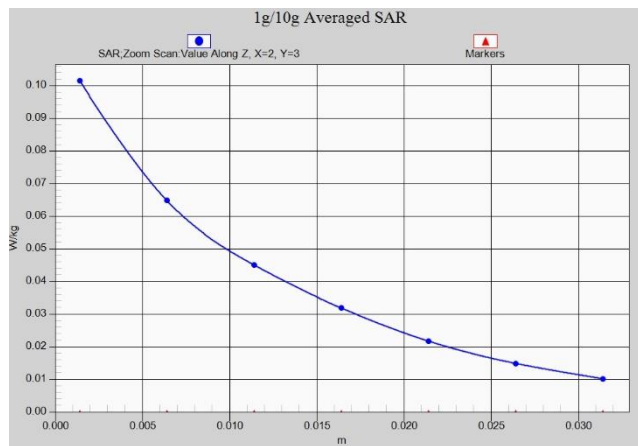

Fig. 1-7 Z-Scan at power reference point (WCDMA1700)

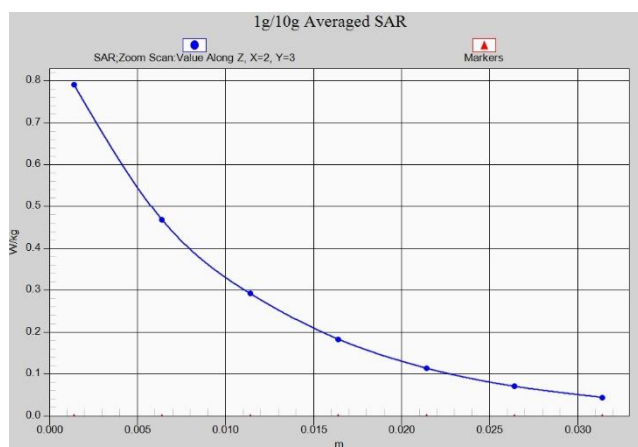

Fig. 1-8 Z-Scan at power reference point (WCDMA1700)

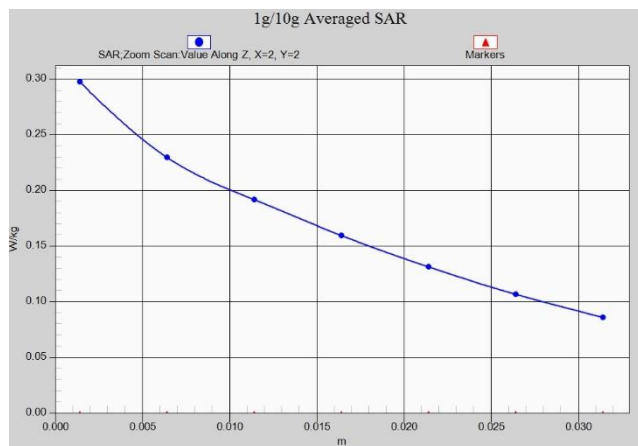

Fig. 1-9 Z-Scan at power reference point (WCDMA850)

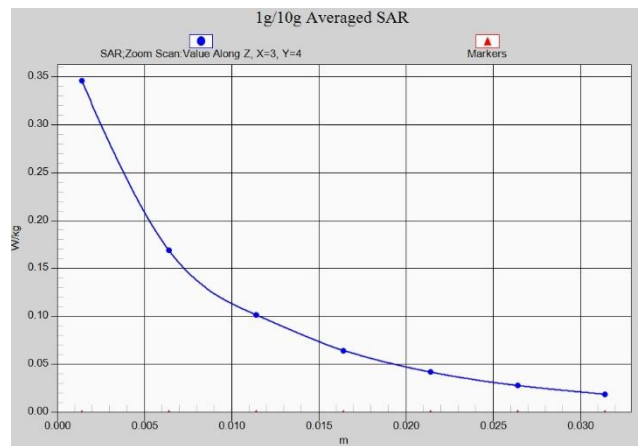

Fig. 1-10 Z-Scan at power reference point (WCDMA850)

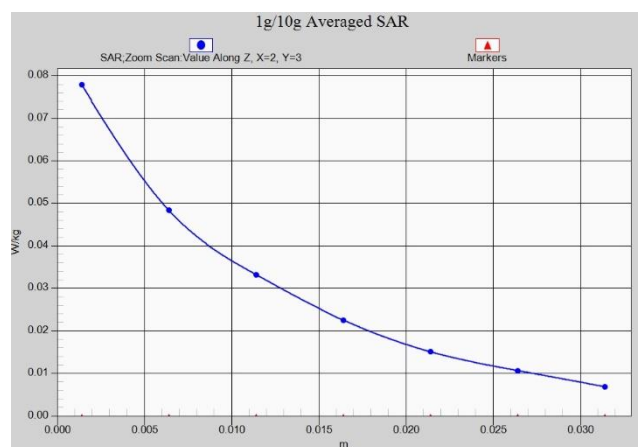

Fig. 1-11 Z-Scan at power reference point (LTE Band2)

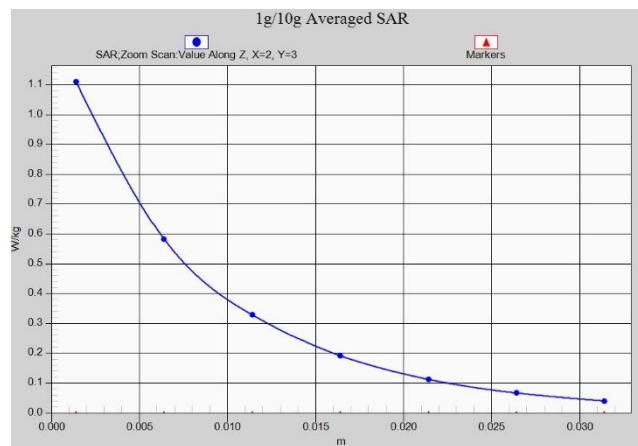

Fig. 1-12 Z-Scan at power reference point (LTE Band2)

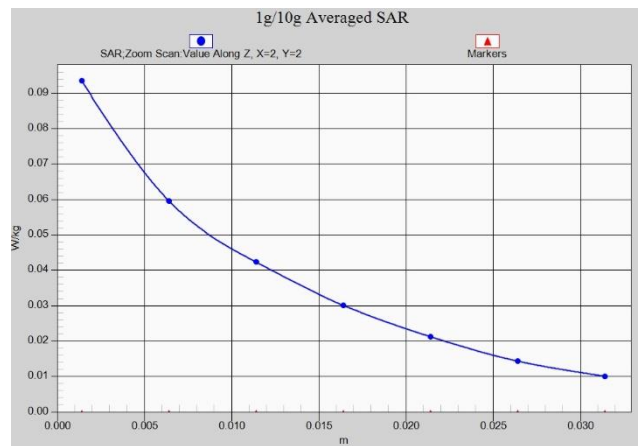

Fig. 1-13 Z-Scan at power reference point (LTE Band4)

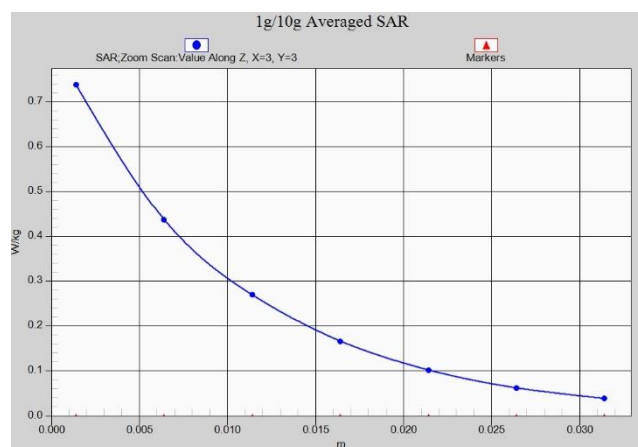

Fig. 1-14 Z-Scan at power reference point (LTE Band4)

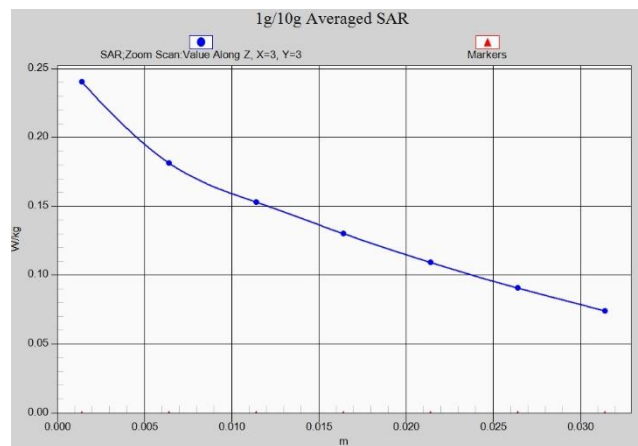

Fig. 1-15 Z-Scan at power reference point (LTE Band5)

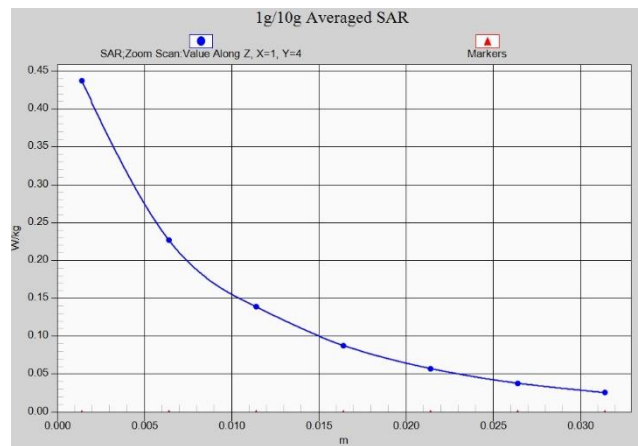

Fig. 1-16 Z-Scan at power reference point (LTE Band5)

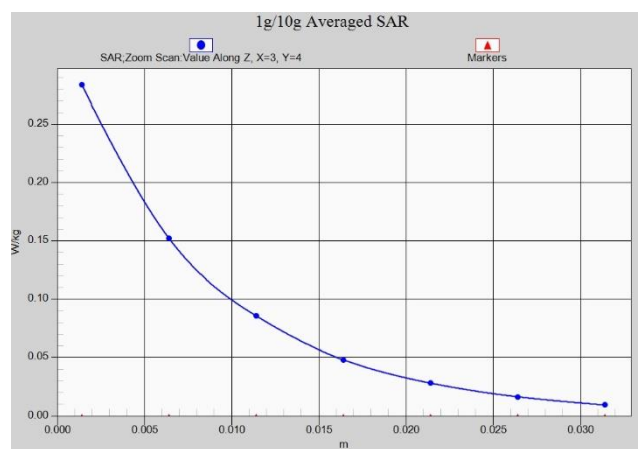

Fig. 1-17 Z-Scan at power reference point (LTE Band7)

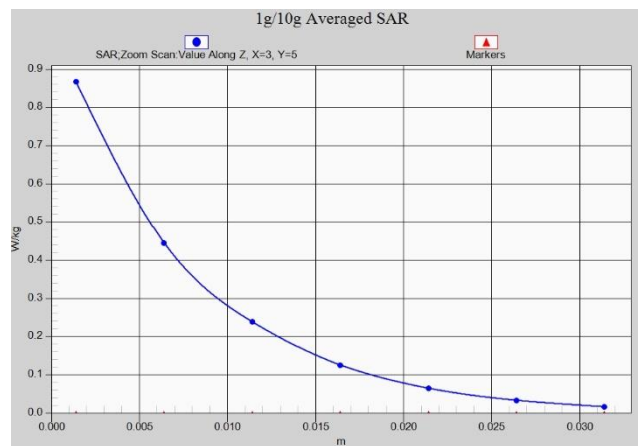

Fig. 1-18 Z-Scan at power reference point (LTE Band7)

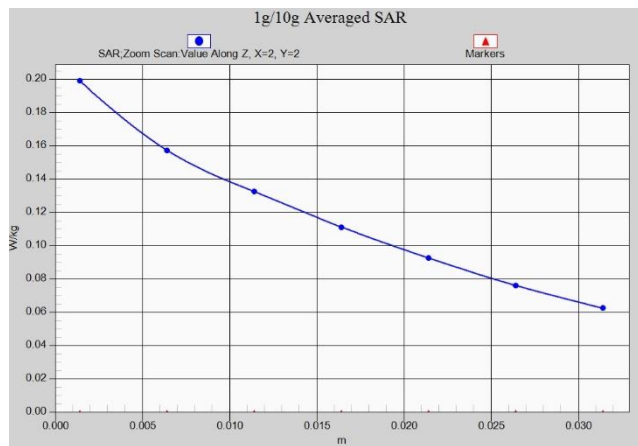

Fig. 1-19 Z-Scan at power reference point (LTE Band12)

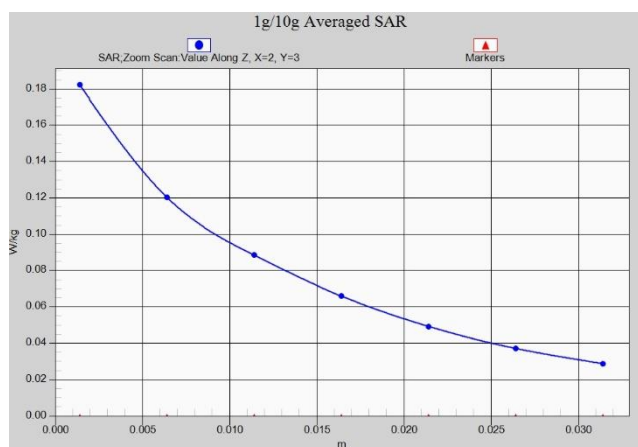

Fig. 1-20 Z-Scan at power reference point (LTE Band12)



Fig. 1-21 Z-Scan at power reference point (LTE Band66)

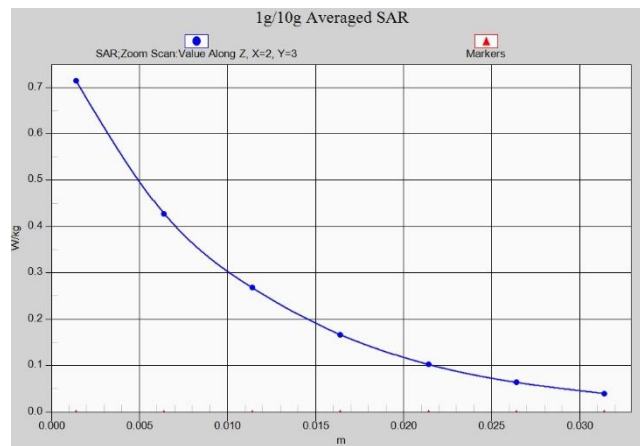

Fig. 1-22 Z-Scan at power reference point (LTE Band66)

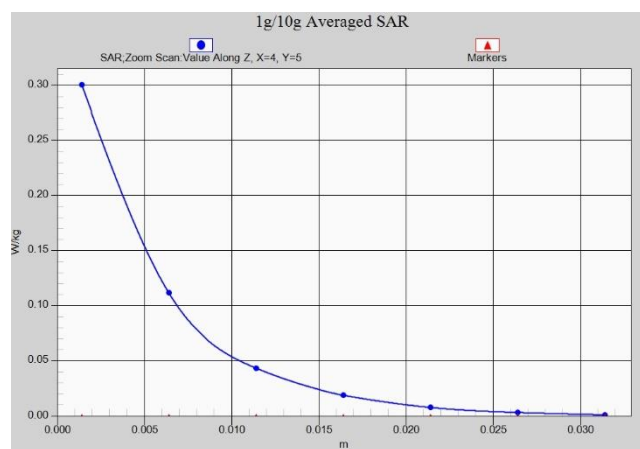

Fig. 1-23 Z-Scan at power reference point (wifi2450)

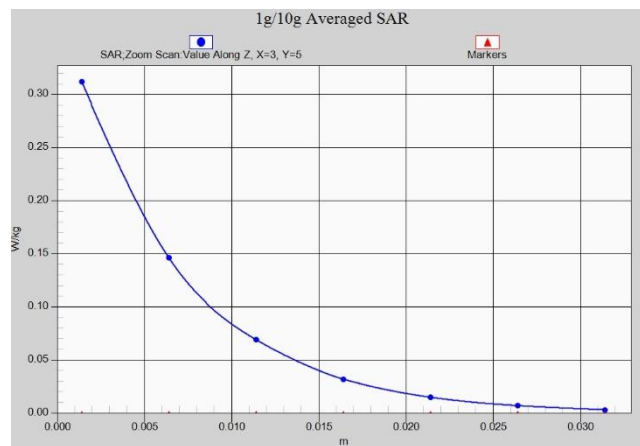

Fig. 1-24 Z-Scan at power reference point (wifi2450)

ANNEX B System Verification Results

750 MHz

Date: 6/25/2021

Electronics: DAE4 Sn1525

Medium: H750

Medium parameters used: $f = 750 \text{ MHz}$; $\sigma = 0.826 \text{ S/m}$; $\epsilon_r = 43.535$; $\rho = 1000 \text{ kg/m}^3$

Ambient Temperature: 22.7°C Liquid Temperature: 22.3°C

Communication System: CW Frequency: 750 MHz Duty Cycle: 1:1

Probe: EX3DV4 - SN7600 ConvF(10.88, 10.88, 10.88)

Area Scan (51x141x1): Interpolated grid: $dx=1.500 \text{ mm}$, $dy=1.500 \text{ mm}$

Reference Value = 43.12 V/m ; Power Drift = 0.12 dB

Fast SAR: SAR(1 g) = 2.11 W/kg ; SAR(10 g) = 1.41 W/kg

Maximum value of SAR (interpolated) = 2.85 W/kg

Zoom Scan (5x5x7)/Cube 0: Measurement grid: $dx=8\text{mm}$, $dy=8\text{mm}$, $dz=5\text{mm}$

Reference Value = 43.12 V/m ; Power Drift = 0.12 dB

Peak SAR (extrapolated) = 3.29 W/kg

SAR(1 g) = 2.05 W/kg ; SAR(10 g) = 1.36 W/kg

Maximum value of SAR (measured) = 2.79 W/kg

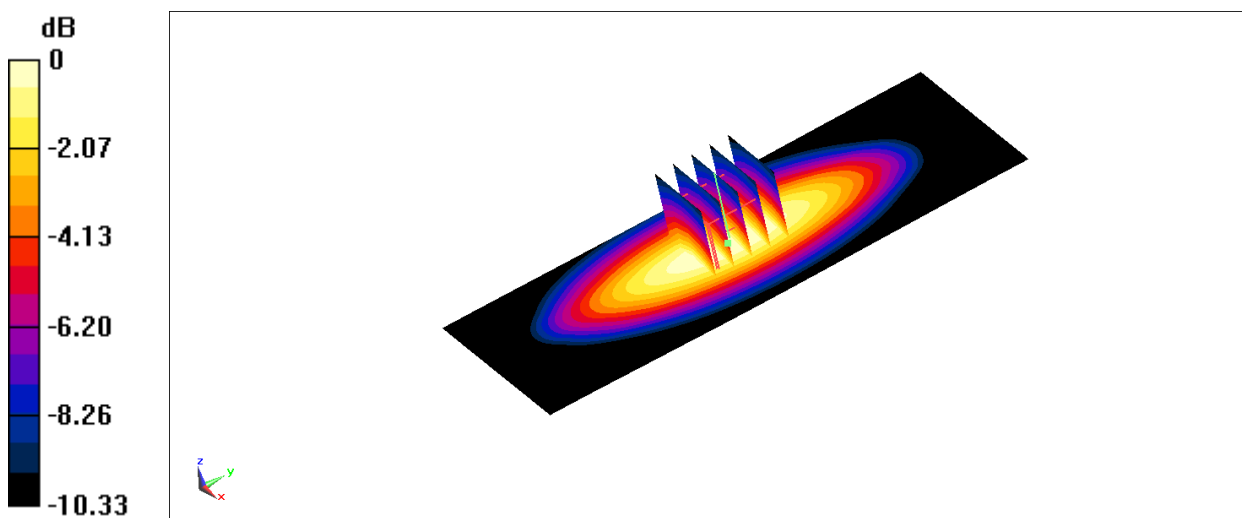

0 dB = 2.79 W/kg = 4.46 dBW/kg

Fig.B.1 validation 750 MHz 250mW

835 MHz

Date: 6/24/2021

Electronics: DAE4 Sn1525

Medium: H835

Medium parameters used: $f = 835 \text{ MHz}$; $\sigma = 0.864 \text{ S/m}$; $\epsilon_r = 43.179$; $\rho = 1000 \text{ kg/m}^3$

Ambient Temperature: 22.5°C Liquid Temperature: 22.5°C

Communication System: CW Frequency: 835 MHz Duty Cycle: 1:1

Probe: EX3DV4 - SN7600 ConvF(10.88, 10.88, 10.88)

Area Scan (51x141x1): Interpolated grid: $dx=1.500 \text{ mm}$, $dy=1.500 \text{ mm}$

Reference Value = 47.37 V/m; Power Drift = 0.05 dB

Fast SAR: SAR(1 g) = 2.31 W/kg; SAR(10 g) = 1.52 W/kg

Maximum value of SAR (interpolated) = 2.99 W/kg

Zoom Scan (5x5x7)/Cube 0: Measurement grid: $dx=8\text{mm}$, $dy=8\text{mm}$, $dz=5\text{mm}$

Reference Value = 47.37 V/m; Power Drift = 0.05 dB

Peak SAR (extrapolated) = 3.65 W/kg

SAR(1 g) = 2.33 W/kg; SAR(10 g) = 1.54 W/kg

Maximum value of SAR (measured) = 3.11 W/kg

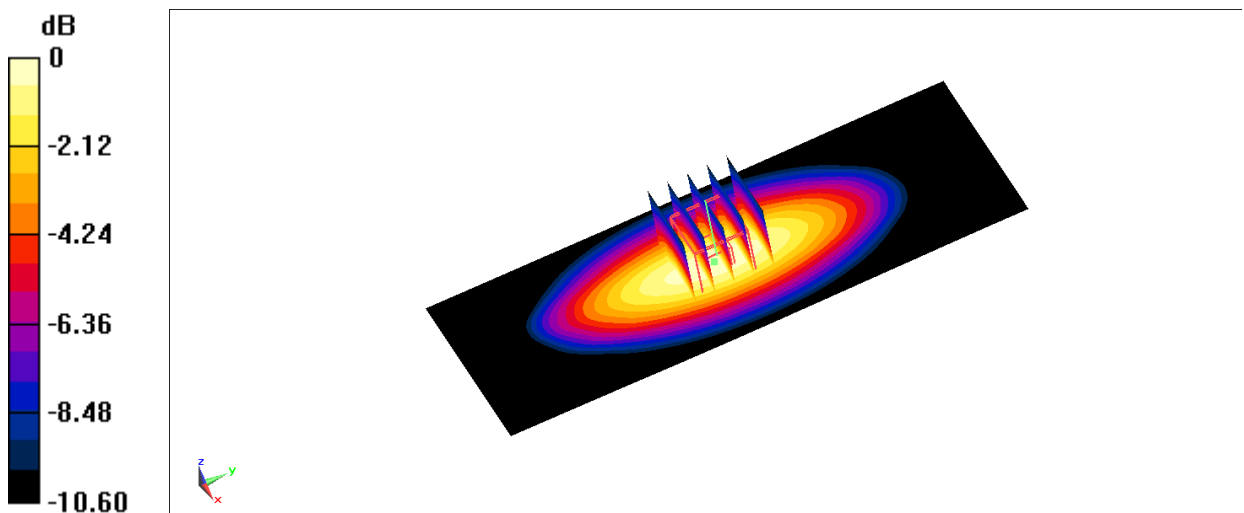

$$0 \text{ dB} = 3.11 \text{ W/kg} = 4.93 \text{ dBW/kg}$$

Fig.B.2 validation 835 MHz 250mW

1750 MHz

Date: 6/26/2021

Electronics: DAE4 Sn1525

Medium: H1750

Medium parameters used: $f = 1750$ MHz; $\sigma = 1.374$ S/m; $\epsilon_r = 40.305$; $\rho = 1000$ kg/m³

Ambient Temperature: 22.9°C Liquid Temperature: 22.8°C

Communication System: CW Frequency: 1750 MHz Duty Cycle: 1:1

Probe: EX3DV4 - SN7600 ConvF(9.01, 9.01, 9.01)

Area Scan (51x141x1): Interpolated grid: dx=1.500 mm, dy=1.500 mm

Reference Value = 55.22 V/m; Power Drift = 0.03 dB

Fast SAR: SAR(1 g) = 9.77 W/kg; SAR(10 g) = 5.17 W/kg

Maximum value of SAR (interpolated) = 14.8 W/kg

Zoom Scan (5x5x7)/Cube 0: Measurement grid: dx=8mm, dy=8mm, dz=5mm

Reference Value = 55.22 V/m; Power Drift = 0.03 dB

Peak SAR (extrapolated) = 18.4 W/kg

SAR(1 g) = 9.7 W/kg; SAR(10 g) = 5.13 W/kg

Maximum value of SAR (measured) = 14.8 W/kg

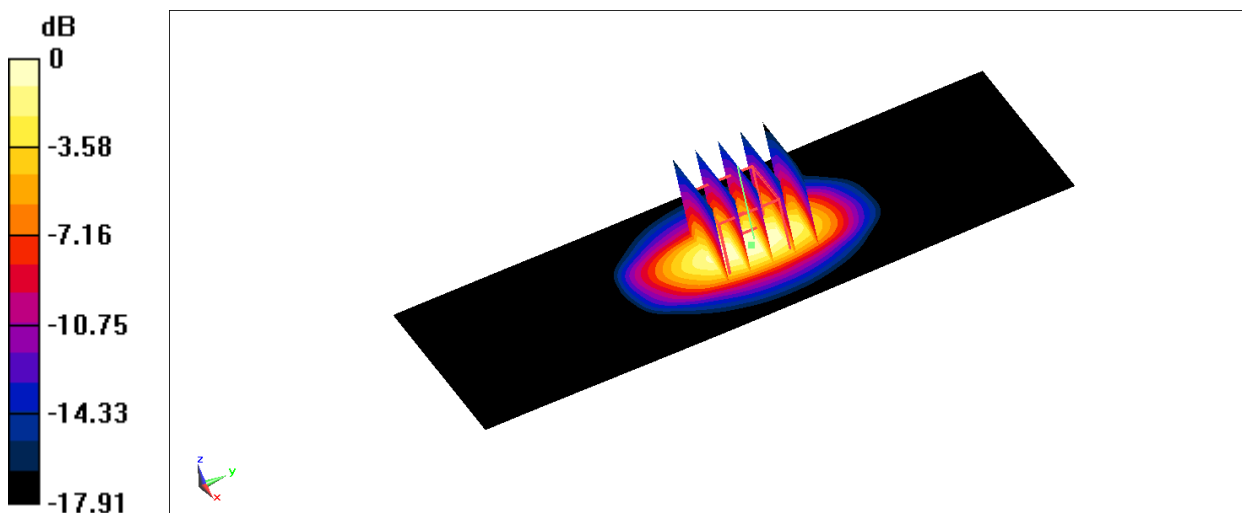

$$0 \text{ dB} = 14.8 \text{ W/kg} = 11.70 \text{ dBW/kg}$$

Fig.B.3 validation 1750 MHz 250mW

1750 MHz

Date: 6/27/2021

Electronics: DAE4 Sn1525

Medium: H1750

Medium parameters used: $f = 1750$ MHz; $\sigma = 1.358$ S/m; $\epsilon_r = 43.755$; $\rho = 1000$ kg/m³

Ambient Temperature: 22.6°C Liquid Temperature: 22.5°C

Communication System: CW Frequency: 1750 MHz Duty Cycle: 1:1

Probe: EX3DV4 - SN7600 ConvF(9.01, 9.01, 9.01)

Area Scan (51x141x1): Interpolated grid: dx=1.500 mm, dy=1.500 mm

Reference Value = 55.31 V/m; Power Drift = 0.11 dB

Fast SAR: SAR(1 g) = 9.66 W/kg; SAR(10 g) = 5.11 W/kg

Maximum value of SAR (interpolated) = 14.6 W/kg

Zoom Scan (5x5x7)/Cube 0: Measurement grid: dx=8mm, dy=8mm, dz=5mm

Reference Value = 55.31 V/m; Power Drift = 0.11 dB

Peak SAR (extrapolated) = 18.2 W/kg

SAR(1 g) = 9.59 W/kg; SAR(10 g) = 5.06 W/kg

Maximum value of SAR (measured) = 14.6 W/kg

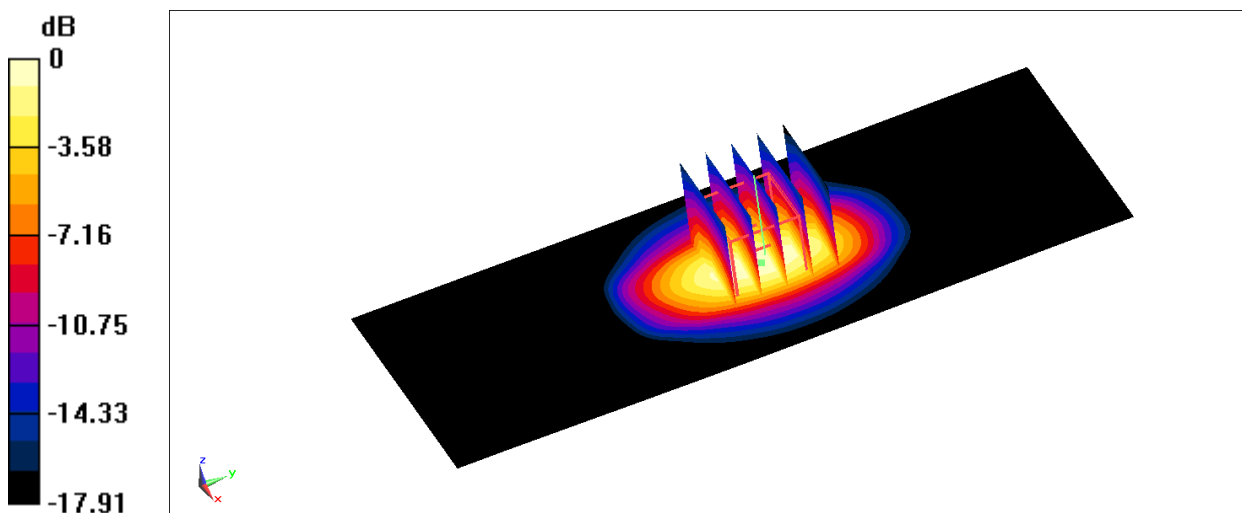

$$0 \text{ dB} = 14.6 \text{ W/kg} = 11.64 \text{ dBW/kg}$$

Fig.B.4 validation 1750 MHz 250mW

1900 MHz

Date: 6/28/2021

Electronics: DAE4 Sn1525

Medium: H1900

Medium parameters used: $f = 1900$ MHz; $\sigma = 1.444$ S/m; $\epsilon_r = 40.279$; $\rho = 1000$ kg/m³

Ambient Temperature: 23.1°C Liquid Temperature: 22.8°C

Communication System: CW Frequency: 1900 MHz Duty Cycle: 1:1

Probe: EX3DV4 - SN7600 ConvF(8.7, 8.7, 8.7)

Area Scan (51x141x1): Interpolated grid: $dx=1.500$ mm, $dy=1.500$ mm

Reference Value = 63.62 V/m; Power Drift = 0.08 dB

Fast SAR: SAR(1 g) = 10.71 W/kg; SAR(10 g) = 5.532 W/kg

Maximum value of SAR (interpolated) = 17.1 W/kg

Zoom Scan (5x5x7)/Cube 0: Measurement grid: $dx=8$ mm, $dy=8$ mm, $dz=5$ mm

Reference Value = 63.62 V/m; Power Drift = 0.08 dB

Peak SAR (extrapolated) = 19.8 W/kg

SAR(1 g) = 10.4 W/kg; SAR(10 g) = 5.37 W/kg

Maximum value of SAR (measured) = 15.8 W/kg

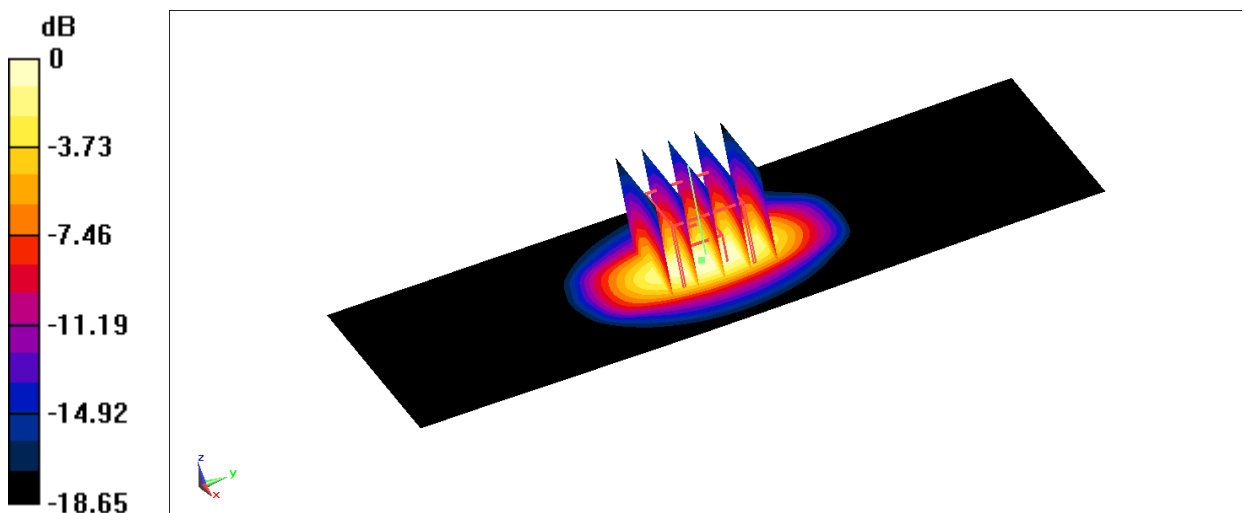

0 dB = 15.8 W/kg = 11.99 dBW/kg

Fig.B.5 validation 1900 MHz 250mW

1900 MHz

Date: 6/29/2021

Electronics: DAE4 Sn1525

Medium: H1900

Medium parameters used: $f = 1900$ MHz; $\sigma = 1.438$ S/m; $\epsilon_r = 43.378$; $\rho = 1000$ kg/m³

Ambient Temperature: 22.9°C Liquid Temperature: 22.4°C

Communication System: CW Frequency: 1900 MHz Duty Cycle: 1:1

Probe: EX3DV4 - SN7600 ConvF(8.7, 8.7, 8.7)

Area Scan (51x141x1): Interpolated grid: $dx=1.500$ mm, $dy=1.500$ mm

Reference Value = 63.88 V/m; Power Drift = 0.12 dB

Fast SAR: SAR(1 g) = 10.67 W/kg; SAR(10 g) = 5.47 W/kg

Maximum value of SAR (interpolated) = 17.0 W/kg

Zoom Scan (5x5x7)/Cube 0: Measurement grid: $dx=8$ mm, $dy=8$ mm, $dz=5$ mm

Reference Value = 63.88 V/m; Power Drift = 0.12 dB

Peak SAR (extrapolated) = 19.8 W/kg

SAR(1 g) = 10.4 W/kg; SAR(10 g) = 5.34 W/kg

Maximum value of SAR (measured) = 15.7 W/kg

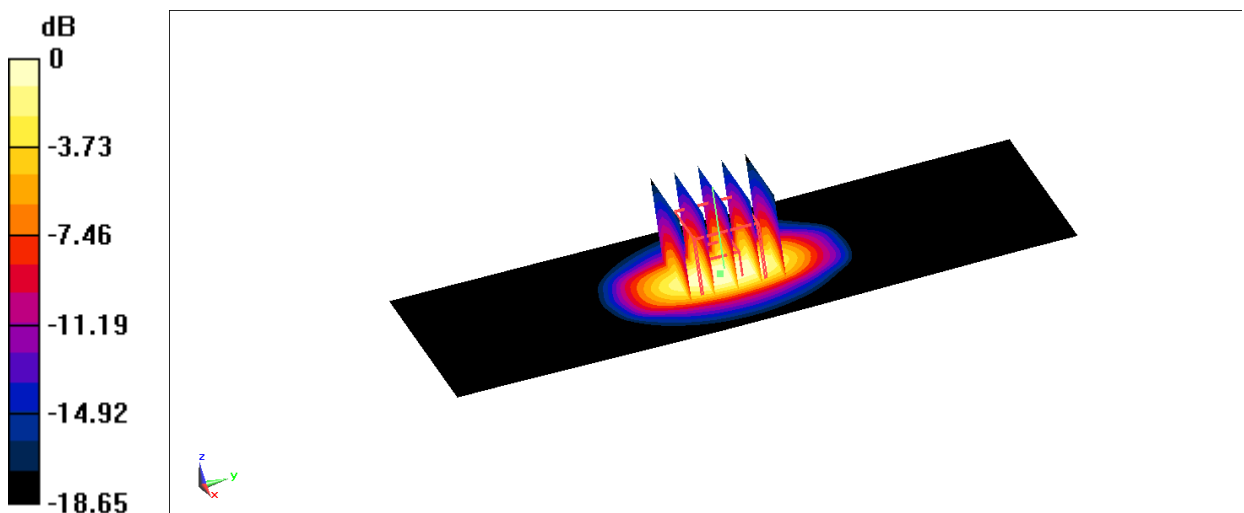

0 dB = 15.7 W/kg = 11.96 dBW/kg

Fig.B.6 validation 1900 MHz 250mW

2450 MHz

Date: 6/30/2021

Electronics: DAE4 Sn1525

Medium: H2450

Medium parameters used: $f = 2450$ MHz; $\sigma = 1.891$ S/m; $\epsilon_r = 39.083$; $\rho = 1000$ kg/m³

Ambient Temperature: 22.7°C Liquid Temperature: 22.5°C

Communication System: CW Frequency: 2450 MHz Duty Cycle: 1:1

Probe: EX3DV4 - SN7600 ConvF(7.79, 7.79, 7.79)

Area Scan (61x171x1): Interpolated grid: $dx=1.200$ mm, $dy=1.200$ mm

Reference Value = 102.2 V/m; Power Drift = 0.02 dB

Fast SAR: SAR(1 g) = 12.89 W/kg; SAR(10 g) = 5.86 W/kg

Maximum value of SAR (interpolated) = 20.9 W/kg

Zoom Scan (7x7x7)/Cube 0: Measurement grid: $dx=5$ mm, $dy=5$ mm, $dz=5$ mm

Reference Value = 102.2 V/m; Power Drift = 0.02 dB

Peak SAR (extrapolated) = 28.4 W/kg

SAR(1 g) = 13.2 W/kg; SAR(10 g) = 5.99 W/kg

Maximum value of SAR (measured) = 22.3 W/kg

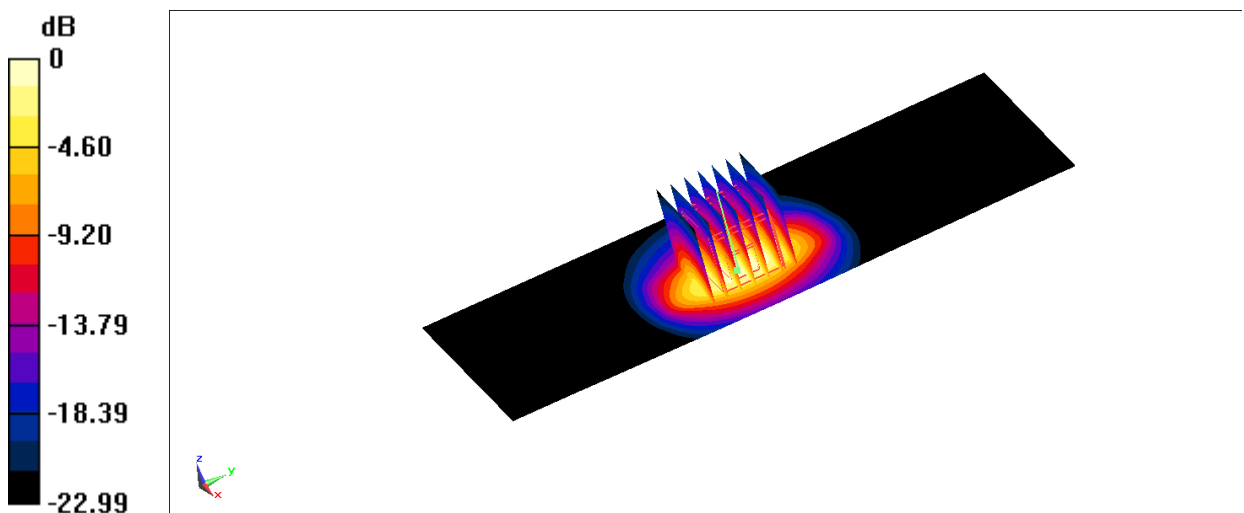

$$0 \text{ dB} = 22.3 \text{ W/kg} = 13.48 \text{ dBW/kg}$$

Fig.B.7 validation 2450 MHz 250mW

2600 MHz

Date: 7/1/2021

Electronics: DAE4 Sn1525

Medium: H2600

Medium parameters used: $f = 2600$ MHz; $\sigma = 1.954$ S/m; $\epsilon_r = 42.372$; $\rho = 1000$ kg/m³

Ambient Temperature: 22.9°C Liquid Temperature: 22.6°C

Communication System: CW Frequency: 2600 MHz Duty Cycle: 1:1

Probe: EX3DV4 - SN7600 ConvF(7.67, 7.67, 7.67)

Area Scan 3 (61x81x1): Interpolated grid: $dx=1.200$ mm, $dy=1.200$ mm

Reference Value = 47.06 V/m; Power Drift = 0.07 dB

Fast SAR: SAR(1 g) = 14.69 W/kg; SAR(10 g) = 6.32 W/kg

Maximum value of SAR (interpolated) = 25.9 W/kg

Zoom Scan (7x7x7)/Cube 0: Measurement grid: $dx=5$ mm, $dy=5$ mm, $dz=5$ mm

Reference Value = 47.06 V/m; Power Drift = 0.07 dB

Peak SAR (extrapolated) = 31.8 W/kg

SAR(1 g) = 14.3 W/kg; SAR(10 g) = 6.31 W/kg

Maximum value of SAR (measured) = 24.7 W/kg

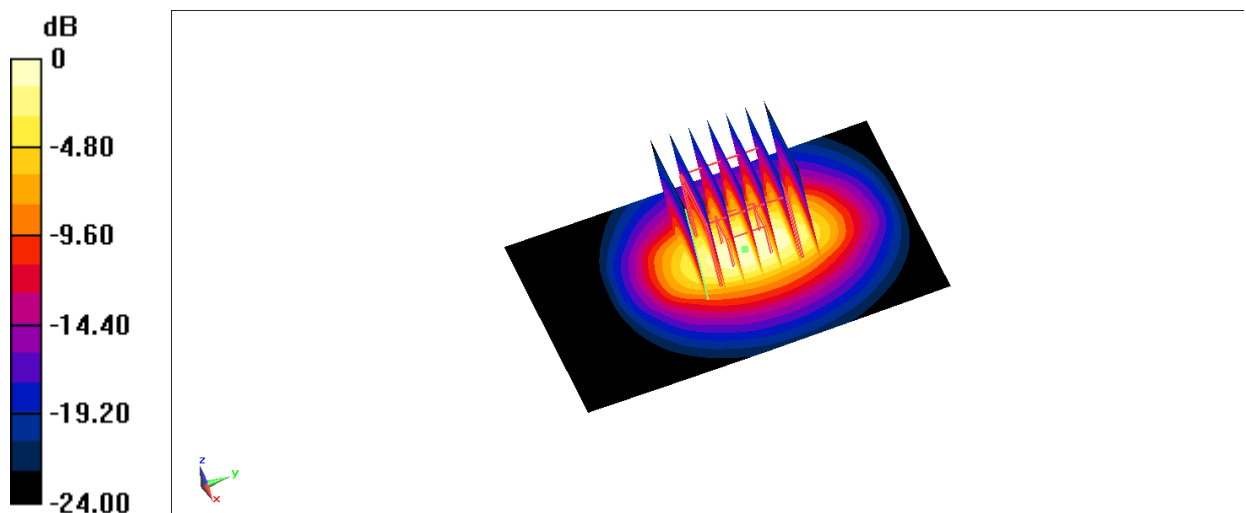

$$0 \text{ dB} = 24.7 \text{ W/kg} = 13.93 \text{ dBW/kg}$$

Fig.B.8 validation 2600 MHz 250mW



The SAR system verification must be required that the area scan estimated 1-g SAR is within 3% of the zoom scan 1-g SAR.

Table B.1 Comparison between area scan and zoom scan for system verification

Date	Band	Position	Area scan (1g)	Zoom scan (1g)	Drift (%)
2021-6-25	750 MHz	Head	2.11	2.05	2.93
2021-6-24	835 MHz	Head	2.31	2.33	-0.86
2021-6-26	1750 MHz	Head	9.77	9.7	0.72
2021-6-27	1750 MHz	Head	9.66	9.59	0.73
2021-6-28	1900 MHz	Head	10.71	10.4	2.98
2021-6-29	1900 MHz	Head	10.67	10.4	2.60
2021-6-30	2450 MHz	Head	12.89	13.2	-2.35
2021-7-1	2600 MHz	Head	14.69	14.3	2.73

ANNEX C SAR Measurement Setup

C.1 Measurement Set-up

The Dasy4 or DASY5 system for performing compliance tests is illustrated above graphically. This system consists of the following items:

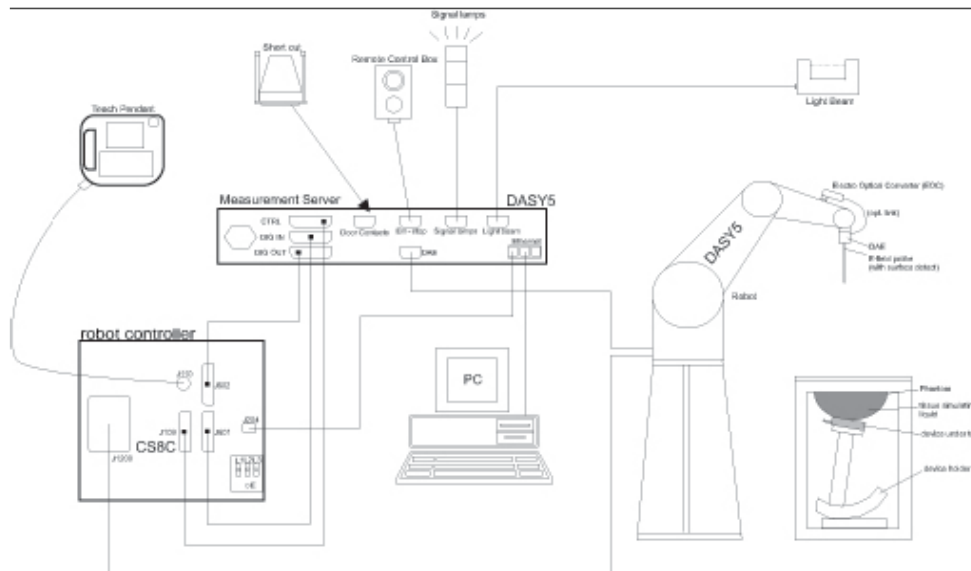

Picture C.1 SAR Lab Test Measurement Set-up

- A standard high precision 6-axis robot (StäubliTX=RX family) with controller, teach pendant and software. An arm extension for accommodating the data acquisition electronics (DAE).
- An isotropic field probe optimized and calibrated for the targeted measurement.
- A data acquisition electronics (DAE) which performs the signal amplification, signal multiplexing, AD-conversion, offset measurements, mechanical surface detection, collision detection, etc. The unit is battery powered with standard or rechargeable batteries. The signal is optically transmitted to the EOC.
- The Electro-optical converter (EOC) performs the conversion from optical to electrical signals for the digital communication to the DAE. To use optical surface detection, a special version of the EOC is required. The EOC signal is transmitted to the measurement server.
- The function of the measurement server is to perform the time critical tasks such as signal filtering, control of the robot operation and fast movement interrupts.
- The Light Beam used is for probe alignment. This improves the (absolute) accuracy of the probe positioning.
- A computer running WinXP and the DASY4 or DASY5 software.
- Remote control and teach pendant as well as additional circuitry for robot safety such as
- warning lamps, etc.
- The phantom, the device holder and other accessories according to the targeted measurement.

C.2 Dasy4 or DASY5 E-field Probe System

The SAR measurements were conducted with the dosimetric probe designed in the classical triangular configuration and optimized for dosimetric evaluation. The probe is constructed using the thick film technique; with printed resistive lines on ceramic substrates. The probe is equipped with an optical multifiber line ending at the front of the probe tip. It is connected to the EOC box on the robot arm and provides an automatic detection of the phantom surface. Half of the fibers are connected to a pulsed infrared transmitter, the other half to a synchronized receiver. As the probe approaches the surface, the reflection from the surface produces a coupling from the transmitting to the receiving fibers. This reflection increases first during the approach, reaches maximum and then decreases. If the probe is flatly touching the surface, the coupling is zero. The distance of the coupling maximum to the surface is independent of the surface reflectivity and largely independent of the surface to probe angle. The DASY4 or DASY5 software reads the reflection during a software approach and looks for the maximum using 2nd order curve fitting. The approach is stopped at reaching the maximum.

Probe Specifications:

Model:	ES3DV3, EX3DV4
Frequency	10MHz — 6.0GHz(EX3DV4)
Range:	10MHz — 4GHz(ES3DV3)
Calibration:	In head and body simulating tissue at Frequencies from 835 up to 5800MHz
Linearity:	± 0.2 dB(30 MHz to 6 GHz) for EX3DV4 ± 0.2 dB(30 MHz to 4 GHz) for ES3DV3
DynamicRange:	10 mW/kg — 100W/kg
Probe Length:	330 mm
Probe Tip	
Length:	20 mm
Body Diameter:	12 mm
Tip Diameter:	2.5 mm (3.9 mm for ES3DV3)
Tip-Center:	1 mm (2.0mm for ES3DV3)
Application:	SAR Dosimetry Testing Compliance tests of mobile phones Dosimetry in strong gradient fields



Picture C.2 Near-field Probe



Picture C.3 E-field Probe

C.3 E-field Probe Calibration

Each E-Probe/Probe Amplifier combination has unique calibration parameters. A TEM cell calibration procedure is conducted to determine the proper amplifier settings to enter in the probe parameters. The amplifier settings are determined for a given frequency by subjecting the probe to a known E-field density (1 mW/cm²) using an RF Signal generator, TEM cell, and RF Power Meter.

The free space E-field from amplified probe outputs is determined in a test chamber. This calibration can be performed in a TEM cell if the frequency is below 1 GHz and in a waveguide or

other methodologies above 1 GHz for free space. For the free space calibration, the probe is placed in the volumetric center of the cavity and at the proper orientation with the field. The probe is then rotated 360 degrees until the three channels show the maximum reading. The power density readings equates to 1 mW/cm².

E-field temperature correlation calibration is performed in a flat phantom filled with the appropriate simulated brain tissue. The E-field in the medium correlates with the temperature rise in the dielectric medium. For temperature correlation calibration a RF transparent thermistor-based temperature probe is used in conjunction with the E-field probe.

$$SAR = C \frac{\Delta T}{\Delta t}$$

Where:

Δt = Exposure time (30 seconds),

C = Heat capacity of tissue (brain or muscle),

ΔT = Temperature increase due to RF exposure.

$$SAR = \frac{|E|^2 \cdot \sigma}{\rho}$$

Where:

σ = Simulated tissue conductivity,

ρ = Tissue density (kg/m³).

C.4 Other Test Equipment

C.4.1 Data Acquisition Electronics(DAE)

The data acquisition electronics consist of a highly sensitive electrometer-grade preamplifier with auto-zeroing, a channel and gain-switching multiplexer, a fast 16 bit AD-converter and a command decoder with a control logic unit. Transmission to the measurement server is accomplished through an optical downlink for data and status information, as well as an optical uplink for commands and the clock.

The mechanical probe mounting device includes two different sensor systems for frontal and sideways probe contacts. They are used for mechanical surface detection and probe collision detection.

The input impedance of the DAE is 200 MOhm; the inputs are symmetrical and floating. Common mode rejection is above 80 dB.



PictureC.4: DAE

C.4.2 Robot

The SPEAG DASY system uses the high precision robots (DASY4: RX90XL; DASY5: RX160L) type from Stäubli SA (France). For the 6-axis controller system, the robot controller version from Stäubli is used. The Stäubli robot series have many features that are important for our application:

- High precision (repeatability 0.02mm)
- High reliability (industrial design)
- Low maintenance costs (virtually maintenance free due to direct drive gears; no belt drives)
- Jerk-free straight movements (brushless synchron motors; no stepper motors)
- Low ELF interference (motor control fields shielded via the closed metallic construction shields)



Picture C.5DASY 4



Picture C.6DASY 5

C.4.3 Measurement Server

The Measurement server is based on a PC/104 CPU board with CPU (dasy4: 166 MHz, Intel Pentium; DASY5: 400 MHz, Intel Celeron), chipdisk (DASY4: 32 MB; DASY5: 128MB), RAM (DASY4: 64 MB, DASY5: 128MB). The necessary circuits for communication with the DAE electronic box, as well as the 16 bit AD converter system for optical detection and digital I/O interface are contained on the DASY I/O board, which is directly connected to the PC/104 bus of the CPU board.

The measurement server performs all real-time data evaluation of field measurements and surface detection, controls robot movements and handles safety operation. The PC operating system cannot interfere with these time critical processes. All connections are supervised by a watchdog, and disconnection of any of the cables to the measurement server will automatically disarm the robot and disable all program-controlled robot movements. Furthermore, the measurement server is equipped with an expansion port which is reserved for future applications. Please note that this expansion port does not have a standardized pinout, and therefore only devices provided by SPEAG can be connected. Devices from any other supplier could seriously damage the measurement server.



Picture C.7 Server for DASY 4



Picture C.8 Server for DASY 5

C.4.4 Device Holder for Phantom

The SAR in the phantom is approximately inversely proportional to the square of the distance between the source and the liquid surface. For a source at 5mm distance, a positioning uncertainty of $\pm 0.5\text{mm}$ would produce a SAR uncertainty of $\pm 20\%$. Accurate device positioning is therefore crucial for accurate and repeatable measurements. The positions in which the devices must be measured are defined by the standards.

The DASY device holder is designed to cope with the different positions given in the standard. It has two scales for device rotation (with respect to the body axis) and device inclination (with respect to the line between the ear reference points). The rotation centers for both scales are the ear reference point (ERP). Thus the device needs no repositioning when changing the angles.

The DASY device holder is constructed of low-loss POM material having the following dielectric parameters: relative permittivity $\epsilon = 3$ and loss tangent $\delta = 0.02$. The amount of dielectric material has been reduced in the closest vicinity of the device, since measurements have suggested that the influence of the clamp on the test results could thus be lowered.

<Laptop Extension Kit>

The extension is lightweight and made of POM, acrylic glass and foam. It fits easily on the upper part of the Mounting Device in place of the phone positioner. The extension is fully compatible with the Twin-SAM and ELI phantoms.



Picture C.9-1: Device Holder

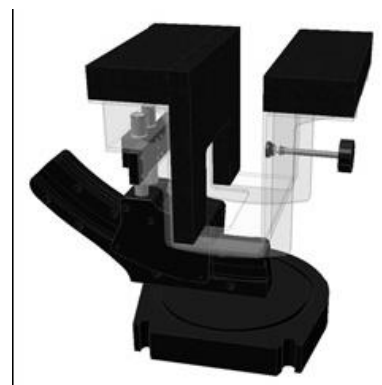

Picture C.9-2: Laptop Extension Kit

C.4.5 Phantom

The SAM Twin Phantom V4.0 is constructed of a fiberglass shell integrated in a table. The shape of the shell is based on data from an anatomical study designed to represent the 90th percentile of the population. The phantom enables the dissymmetric evaluation of SAR for both left and right handed handset usage, as well as body-worn usage using the flat phantom region. Reference markings on the Phantom allow the complete setup of all predefined phantom positions and measurement grids by manually teaching three points in the robot. The shell phantom has a 2mm shell thickness (except the ear region where shell thickness increases to 6 mm).

Shell Thickness: 2 ± 0.2 mm

Filling Volume: Approx. 25 liters

Dimensions: 810 x 1000 x 500 mm (H x L x W)

Available: Special



Picture C.10: SAM Twin Phantom

ANNEX D Position of the wireless device in relation to the phantom

D.1 General considerations

This standard specifies two handset test positions against the head phantom – the “cheek” position and the “tilt” position.

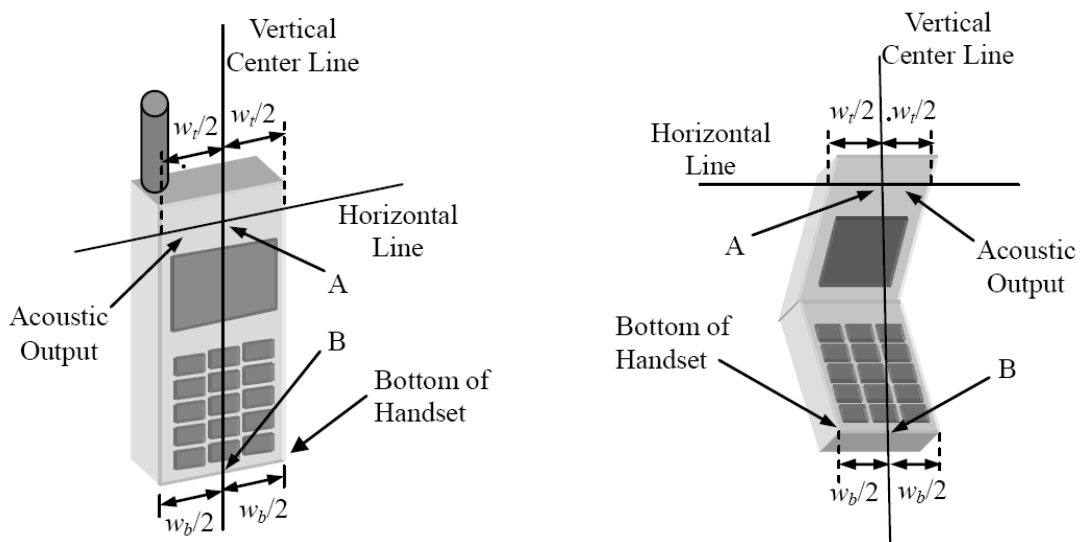

- w_t Width of the handset at the level of the acoustic
- w_b Width of the bottom of the handset
- A Midpoint of the width w_t of the handset at the level of the acoustic output
- B Midpoint of the width w_b of the bottom of the handset

Picture D.1-a Typical “fixed” case handset Picture D.1-b Typical “clam-shell” case handset

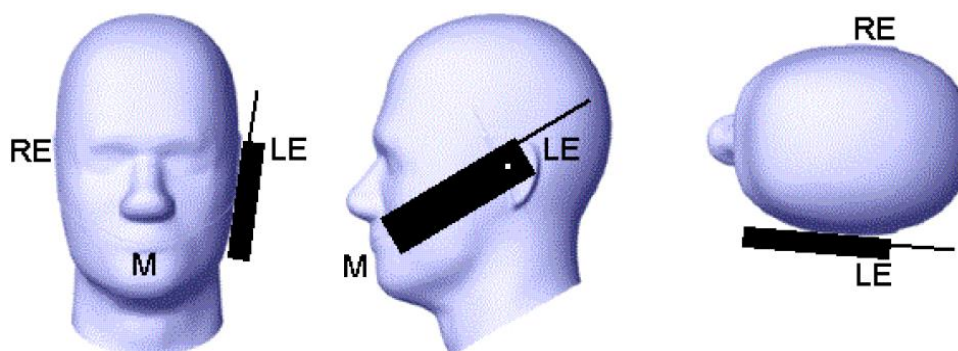

Picture D.2 Cheek position of the wireless device on the left side of SAM

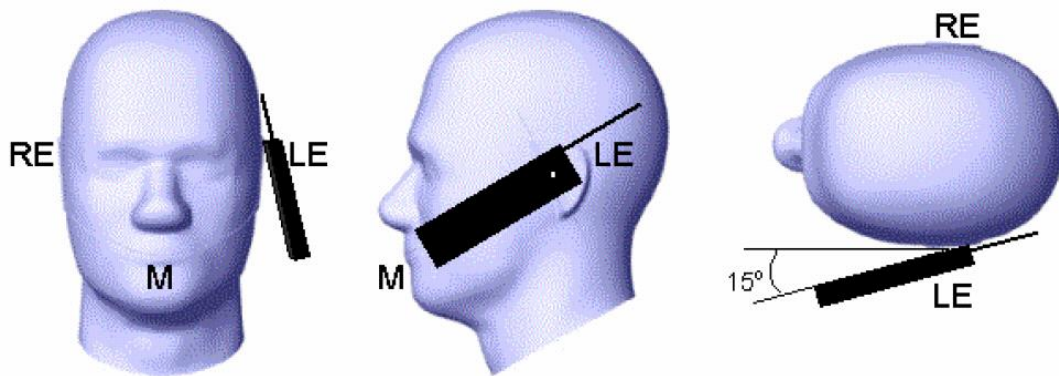

Picture D.3 Tilt position of the wireless device on the left side of SAM

D.2 Body-worn device

A typical example of a body-worn device is a mobile phone, wireless enabled PDA or other battery operated wireless device with the ability to transmit while mounted on a person's body using a carry accessory approved by the wireless device manufacturer.

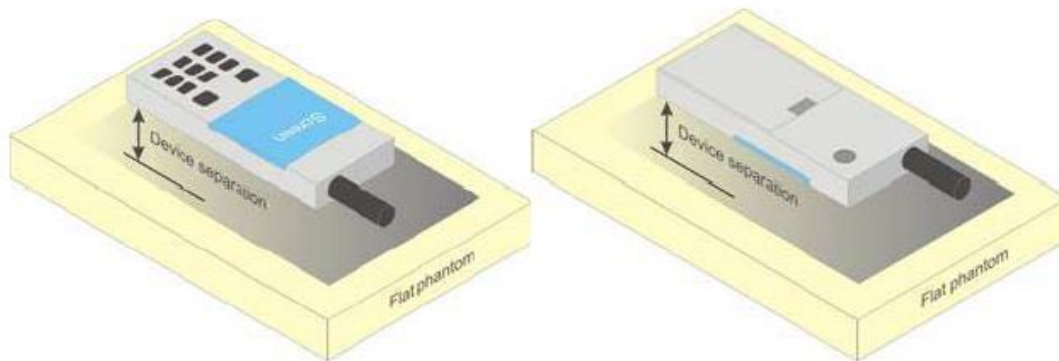

Picture D.4 Test positions for body-worn devices

D.3 Desktop device

A typical example of a desktop device is a wireless enabled desktop computer placed on a table or desk when used.

The DUT shall be positioned at the distance and in the orientation to the phantom that corresponds to the intended use as specified by the manufacturer in the user instructions. For devices that employ an external antenna with variable positions, tests shall be performed for all antenna positions specified. Picture 8.5 show positions for desktop device SAR tests. If the intended use is not specified, the device shall be tested directly against the flat phantom.

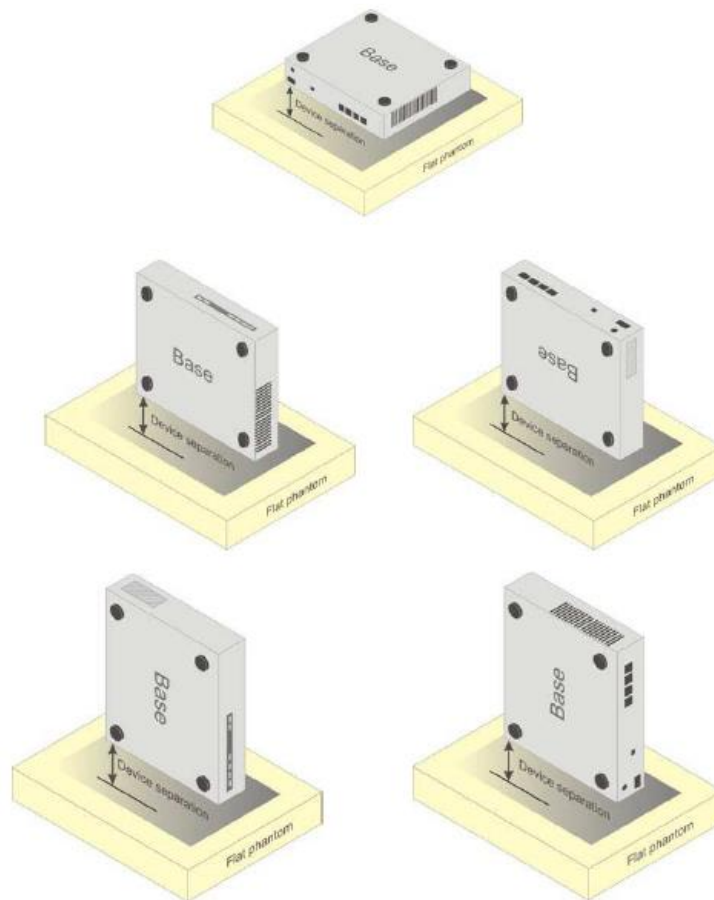

Picture D.5 Test positions for desktop devices

D.4 DUT Setup Photos



Picture D.6

ANNEX E Equivalent Media Recipes

The liquid used for the frequency range of 800-3000 MHz consisted of water, sugar, salt, preventol, glycol monobutyl and Cellulose. The liquid has been previously proven to be suited for worst-case. The Table E.1 shows the detail solution. It's satisfying the latest tissue dielectric parameters requirements proposed by the IEEE 1528 and IEC 62209.

TableE.1: Composition of the Tissue Equivalent Matter

Frequency (MHz)	835Head	835Body	1900 Head	1900 Body	2450 Head	2450 Body	5800 Head	5800 Body
Ingredients (% by weight)								
Water	41.45	52.5	55.242	69.91	58.79	72.60	65.53	65.53
Sugar	56.0	45.0	\	\	\	\	\	\
Salt	1.45	1.4	0.306	0.13	0.06	0.18	\	\
Preventol	0.1	0.1	\	\	\	\	\	\
Cellulose	1.0	1.0	\	\	\	\	\	\
Glycol Monobutyl	\	\	44.452	29.96	41.15	27.22	\	\
Diethylenglycol monohexylether	\	\	\	\	\	\	17.24	17.24
Triton X-100	\	\	\	\	\	\	17.24	17.24
Dielectric Parameters Target Value	$\epsilon=41.5$ $\sigma=0.90$	$\epsilon=55.2$ $\sigma=0.97$	$\epsilon=40.0$ $\sigma=1.40$	$\epsilon=53.3$ $\sigma=1.52$	$\epsilon=39.2$ $\sigma=1.80$	$\epsilon=52.7$ $\sigma=1.95$	$\epsilon=35.3$ $\sigma=5.27$	$\epsilon=48.2$ $\sigma=6.00$

Note: There are a little adjustment respectively for 750, 1750, 2600, 5200, 5300 and 5600 based on the recipe of closest frequency in table E.1.

ANNEX F System Validation

The SAR system must be validated against its performance specifications before it is deployed. When SAR probes, system components or software are changed, upgraded or recalibrated, these must be validated with the SAR system(s) that operates with such components.

Table F.1: System Validation for 7600

Probe SN.	Liquid name	Validation date	Frequency point	Status (OK or Not)
7600	Head 750MHz	December 2, 2020	750 MHz	OK
7600	Head 900MHz	December 2, 2020	900 MHz	OK
7600	Head 1450MHz	December 3, 2020	1450 MHz	OK
7600	Head 1640MHz	December 3, 2020	1640 MHz	OK
7600	Head 1750MHz	December 3, 2020	1750 MHz	OK
7600	Head 1900MHz	December 4, 2020	1900 MHz	OK
7600	Head 2000MHz	December 4, 2020	2000 MHz	OK
7600	Head 2300MHz	December 4, 2020	2300 MHz	OK
7600	Head 2450MHz	December 5, 2020	2450 MHz	OK
7600	Head 2600MHz	December 5, 2020	2600 MHz	OK
7600	Head 3300MHz	December 6, 2020	3300 MHz	OK
7600	Head 3500MHz	December 6, 2020	3500 MHz	OK
7600	Head 3700MHz	December 6, 2020	3700 MHz	OK
7600	Head 3900MHz	December 7, 2020	3900 MHz	OK
7600	Head 4100MHz	December 7, 2020	4100MHz	OK
7600	Head 4200MHz	December 7, 2020	4200MHz	OK
7600	Head 4400MHz	December 8, 2020	4400MHz	OK
7600	Head 4600MHz	December 8, 2020	4600MHz	OK
7600	Head 4800MHz	December 8, 2020	4800MHz	OK
7600	Head 4950MHz	December 8, 2020	4950MHz	OK
7600	Head 5250MHz	December 9, 2020	5250MHz	OK
7600	Head 5600MHz	December 9, 2020	5600 MHz	OK
7600	Head 5750MHz	December 9, 2020	5750 MHz	OK



No.I21Z70258-SEM01

ANNEX G Probe Calibration Certificate

Probe 7600 Calibration Certificate



中国认可
国际互认
校准
CALIBRATION
CNAS L0570

Add: No.51 Xueyuan Road, Haidian District, Beijing, 100191, China
Tel: +86-10-62304633-2512 Fax: +86-10-62304633-2504
E-mail: cttl@chinattl.com [Http://www.chinattl.cn](http://www.chinattl.cn)

Client **CTTL**

Certificate No: **Z20-60421**

CALIBRATION CERTIFICATE			
Object	EX3DV4 - SN : 7600		
Calibration Procedure(s)	FF-Z11-004-02 Calibration Procedures for Dosimetric E-field Probes		
Calibration date:	November 30, 2020		
<p>This calibration Certificate documents the traceability to national standards, which realize the physical units of measurements(SI). The measurements and the uncertainties with confidence probability are given on the following pages and are part of the certificate.</p> <p>All calibrations have been conducted in the closed laboratory facility: environment temperature(22±3)°C and humidity<70%.</p> <p>Calibration Equipment used (M&TE critical for calibration)</p>			
Primary Standards	ID #	Cal Date(Calibrated by, Certificate No.)	Scheduled Calibration
Power Meter NRP2	101919	16-Jun-20(CTTL, No.J20X04344)	Jun-21
Power sensor NRP-Z91	101547	16-Jun-20(CTTL, No.J20X04344)	Jun-21
Power sensor NRP-Z91	101548	16-Jun-20(CTTL, No.J20X04344)	Jun-21
Reference 10dBAttenuator	18N50W-10dB	10-Feb-20(CTTL, No.J20X00525)	Feb-22
Reference 20dBAttenuator	18N50W-20dB	10-Feb-20(CTTL, No.J20X00526)	Feb-22
Reference Probe EX3DV4	SN 7307	29-May-20(SPEAG, No.EX3-7307_May20)	May-21
DAE4	SN 1556	4-Feb-20(SPEAG, No.DAE4-1556_Feb20)	Feb-21
Secondary Standards	ID #	Cal Date(Calibrated by, Certificate No.)	Scheduled Calibration
SignalGenerator MG3700A	6201052605	23-Jun-20(CTTL, No.J20X04343)	Jun-21
Network Analyzer E5071C	MY46110673	10-Feb-20(CTTL, No.J20X00515)	Feb-21
Calibrated by:	Name Yu Zongying	Function SAR Test Engineer	Signature
Reviewed by:	Lin Hao	SAR Test Engineer	
Approved by:	Qi Dianyuan	SAR Project Leader	
Issued: December 02, 2020			
This calibration certificate shall not be reproduced except in full without written approval of the laboratory.			

Certificate No: Z20-60421

Page 1 of 9



Add: No.51 Xueyuan Road, Haidian District, Beijing, 100191, China
Tel: +86-10-62304633-2512 Fax: +86-10-62304633-2504
E-mail: cttl@chinattl.com [Http://www.chinattl.cn](http://www.chinattl.cn)

Glossary:

TSL	tissue simulating liquid
NORM _{x,y,z}	sensitivity in free space
ConvF	sensitivity in TSL / NORM _{x,y,z}
DCP	diode compression point
CF	crest factor (1/duty_cycle) of the RF signal
A,B,C,D	modulation dependent linearization parameters
Polarization Φ	Φ rotation around probe axis
Polarization θ	θ rotation around an axis that is in the plane normal to probe axis (at measurement center), $\theta=0$ is normal to probe axis

Connector Angle information used in DASY system to align probe sensor X to the robot coordinate system

Calibration is Performed According to the Following Standards:

- IEEE Std 1528-2013, "IEEE Recommended Practice for Determining the Peak Spatial-Averaged Specific Absorption Rate (SAR) in the Human Head from Wireless Communications Devices: Measurement Techniques", June 2013
- IEC 62209-1, "Measurement procedure for the assessment of Specific Absorption Rate (SAR) from hand-held and body-mounted devices used next to the ear (frequency range of 300 MHz to 6 GHz)", July 2016
- IEC 62209-2, "Procedure to determine the Specific Absorption Rate (SAR) for wireless communication devices used in close proximity to the human body (frequency range of 30 MHz to 6 GHz)", March 2010
- KDB 865664, "SAR Measurement Requirements for 100 MHz to 6 GHz"

Methods Applied and Interpretation of Parameters:

- NORM_{x,y,z}:** Assessed for E-field polarization $\theta=0$ ($f \leq 900$ MHz in TEM-cell; $f > 1800$ MHz: waveguide). NORM_{x,y,z} are only intermediate values, i.e., the uncertainties of NORM_{x,y,z} does not effect the E^2 -field uncertainty inside TSL (see below ConvF).
- NORM(f)_{x,y,z} = NORM_{x,y,z} * frequency_response** (see Frequency Response Chart). This linearization is implemented in DASY4 software versions later than 4.2. The uncertainty of the frequency response is included in the stated uncertainty of ConvF.
- DCP_{x,y,z}:** DCP are numerical linearization parameters assessed based on the data of power sweep (no uncertainty required). DCP does not depend on frequency nor media.
- PAR:** PAR is the Peak to Average Ratio that is not calibrated but determined based on the signal characteristics.
- A_{x,y,z}; B_{x,y,z}; C_{x,y,z}; VR_{x,y,z}:** A,B,C are numerical linearization parameters assessed based on the data of power sweep for specific modulation signal. The parameters do not depend on frequency nor media. VR is the maximum calibration range expressed in RMS voltage across the diode.
- ConvF and Boundary Effect Parameters:** Assessed in flat phantom using E-field (or Temperature Transfer Standard for $f \leq 800$ MHz) and inside waveguide using analytical field distributions based on power measurements for $f > 800$ MHz. The same setups are used for assessment of the parameters applied for boundary compensation (alpha, depth) of which typical uncertainty valued are given. These parameters are used in DASY4 software to improve probe accuracy close to the boundary. The sensitivity in TSL corresponds to NORM_{x,y,z} * ConvF whereby the uncertainty corresponds to that given for ConvF. A frequency dependent ConvF is used in DASY version 4.4 and higher which allows extending the validity from ± 50 MHz to ± 100 MHz.
- Spherical isotropy (3D deviation from isotropy):** in a field of low gradients realized using a flat phantom exposed by a patch antenna.
- Sensor Offset:** The sensor offset corresponds to the offset of virtual measurement center from the probe tip (on probe axis). No tolerance required.
- Connector Angle:** The angle is assessed using the information gained by determining the NORM_x (no uncertainty required).



Add: No.51 Xueyuan Road, Haidian District, Beijing, 100191, China
 Tel: +86-10-62304633-2512 Fax: +86-10-62304633-2504
 E-mail: cttl@chinattl.com [Http://www.chinattl.cn](http://www.chinattl.cn)

DASY/EASY – Parameters of Probe: EX3DV4 – SN:7600

Basic Calibration Parameters

	Sensor X	Sensor Y	Sensor Z	Unc (k=2)
Norm($\mu\text{V}/(\text{V}/\text{m})^2$) ^A	0.70	0.65	0.67	±10.0%
DCP(mV) ^B	109.4	109.2	108.7	

Modulation Calibration Parameters

UID	Communication System Name		A dB	B dB $\sqrt{\mu\text{V}}$	C	D dB	VR mV	Unc ^E (k=2)
0	CW	X	0.0	0.0	1.0	0.00	225.0	±2.1%
		Y	0.0	0.0	1.0		206.5	
		Z	0.0	0.0	1.0		212.8	

The reported uncertainty of measurement is stated as the standard uncertainty of Measurement multiplied by the coverage factor $k=2$, which for a normal distribution Corresponds to a coverage probability of approximately 95%.

^A The uncertainties of Norm X, Y, Z do not affect the E^2 -field uncertainty inside TSL (see Page 4).

^B Numerical linearization parameter: uncertainty not required.

^E Uncertainty is determined using the max. deviation from linear response applying rectangular distribution and is expressed for the square of the field value.



Add: No.51 Xueyuan Road, Haidian District, Beijing, 100191, China
 Tel: +86-10-62304633-2512 Fax: +86-10-62304633-2504
 E-mail: cttl@chinattl.com [Http://www.chinattl.cn](http://www.chinattl.cn)

DASY/EASY – Parameters of Probe: EX3DV4 – SN:7600

Calibration Parameter Determined in Head Tissue Simulating Media

f [MHz] ^C	Relative Permittivity ^F	Conductivity (S/m) ^F	ConvF X	ConvF Y	ConvF Z	Alpha ^G	Depth ^G (mm)	Unct. (k=2)
750	41.9	0.89	10.88	10.88	10.88	0.40	0.77	±12.1%
900	41.5	0.97	10.45	10.45	10.45	0.17	1.31	±12.1%
1450	40.5	1.20	9.28	9.28	9.28	0.10	1.40	±12.1%
1640	40.3	1.29	9.10	9.10	9.10	0.21	1.03	±12.1%
1750	40.1	1.37	9.01	9.01	9.01	0.20	1.11	±12.1%
1900	40.0	1.40	8.70	8.70	8.70	0.26	1.03	±12.1%
2000	40.0	1.40	8.68	8.68	8.68	0.21	1.16	±12.1%
2300	39.5	1.67	8.19	8.19	8.19	0.37	0.88	±12.1%
2450	39.2	1.80	7.79	7.79	7.79	0.35	1.00	±12.1%
2600	39.0	1.96	7.67	7.67	7.67	0.46	0.80	±12.1%
3300	38.2	2.71	7.35	7.35	7.35	0.43	0.95	±13.3%
3500	37.9	2.91	7.01	7.01	7.01	0.44	0.94	±13.3%
3700	37.7	3.12	6.77	6.77	6.77	0.42	1.02	±13.3%
3900	37.5	3.32	6.85	6.85	6.85	0.35	1.30	±13.3%
4100	37.2	3.53	6.75	6.75	6.75	0.40	1.15	±13.3%
4200	37.1	3.63	6.65	6.65	6.65	0.35	1.35	±13.3%
4400	36.9	3.84	6.54	6.54	6.54	0.35	1.35	±13.3%
4600	36.7	4.04	6.39	6.39	6.39	0.45	1.25	±13.3%
4800	36.4	4.25	6.34	6.34	6.34	0.40	1.42	±13.3%
4950	36.3	4.40	6.01	6.01	6.01	0.45	1.30	±13.3%
5250	35.9	4.71	5.68	5.68	5.68	0.45	1.30	±13.3%
5600	35.5	5.07	5.11	5.11	5.11	0.50	1.25	±13.3%
5750	35.4	5.22	5.07	5.07	5.07	0.50	1.25	±13.3%

^C Frequency validity above 300 MHz of ±100MHz only applies for DASY v4.4 and higher (Page 2), else it is restricted to ±50MHz. The uncertainty is the RSS of ConvF uncertainty at calibration frequency and the uncertainty for the indicated frequency band. Frequency validity below 300 MHz is ± 10, 25, 40, 50 and 70 MHz for ConvF assessments at 30, 64, 128, 150 and 220 MHz respectively. Above 5 GHz frequency validity can be extended to ± 110 MHz.

^F At frequency below 3 GHz, the validity of tissue parameters (ϵ and σ) can be relaxed to ±10% if liquid compensation formula is applied to measured SAR values. At frequencies above 3 GHz, the validity of tissue parameters (ϵ and σ) is restricted to ±5%. The uncertainty is the RSS of the ConvF uncertainty for indicated target tissue parameters.

^G Alpha/Depth are determined during calibration. SPEAG warrants that the remaining deviation due to the boundary effect after compensation is always less than ± 1% for frequencies below 3 GHz and below ± 2% for the frequencies between 3-6 GHz at any distance larger than half the probe tip diameter from the boundary.