

FCC Test Report

Report No.: RFCBVX-WTW-P22051015-1

FCC ID: YUQ-P991MV01

Test Model: P991MV-01

Received Date: May 31, 2022

Test Date: Jun. 06, 2022 ~ Jun. 09, 2022

Issued Date: Jul. 20, 2022

Applicant: Citizen Watch CO., LTD.

Address: 6-1-12 TANASHICHO, NISHITOKYO-SHI, TOKYO 188--8511, JAPAN

Issued By: Bureau Veritas Consumer Products Services (H.K.) Ltd., Taoyuan Branch
Lin Kou Laboratories

Lab Address: No. 47-2, 14th Ling, Chia Pau Vil., Lin Kou Dist., New Taipei City, Taiwan

Test Location: No.19, Hwa Ya 2nd Rd., Wen Hwa Vil., Kwei Shan Dist., Taoyuan City
33383, Taiwan

**FCC Registration /
Designation Number:** 788550 / TW0003



This report is governed by, and incorporates by reference, the Conditions of Testing as posted at the date of issuance of this report at <http://www.bureauveritas.com/home/about-us/our-business/cps/about-us/terms-conditions/> and is intended for your exclusive use. Any copying or replication of this report to or for any other person or entity, or use of our name or trademark, is permitted only with our prior written permission. This report sets forth our findings solely with respect to the test samples identified herein. The results set forth in this report are not indicative or representative of the quality or characteristics of the lot from which a test sample was taken or any similar or identical product unless specifically and expressly noted. Our report includes all of the tests requested by you and the results thereof based upon the information that you provided to us. Measurement uncertainty is only provided upon request for accredited tests. Statements of conformity are based on simple acceptance criteria without taking measurement uncertainty into account, unless otherwise requested in writing. You have 60 days from date of issuance of this report to notify us of any material error or omission caused by our negligence or if you require measurement uncertainty; provided, however, that such notice shall be in writing and shall specifically address the issue you wish to raise. A failure to raise such issue within the prescribed time shall constitute your unqualified acceptance of the completeness of this report, the tests conducted and the correctness of the report contents.

Table of Contents

Release Control Record	3
1 Certificate of Conformity	4
2 Summary of Test Results.....	5
2.1 Measurement Uncertainty.....	5
2.2 Modification Record	5
3 General Information	6
3.1 General Description of EUT	6
3.2 Description of Test Modes.....	7
3.2.1 Test Mode Applicability and Tested Channel Detail.....	8
3.3 Duty Cycle of Test Signal	10
3.4 Description of Support Units	11
3.4.1 Configuration of System under Test	11
3.5 General Description of Applied Standards and References	12
4 Test Types and Results	13
4.1 Radiated Emission and Bandedge Measurement	13
4.1.1 Limits of Radiated Emission and Bandedge Measurement	13
4.1.2 Test Instruments	14
4.1.3 Test Procedures.....	15
4.1.4 Deviation from Test Standard	16
4.1.5 Test Set Up	16
4.1.6 EUT Operating Conditions.....	17
4.1.7 Test Results	18
4.2 Conducted Emission Measurement.....	22
4.2.1 Limits of Conducted Emission Measurement	22
4.2.2 Test Instruments	22
4.2.3 Test Procedures.....	23
4.2.4 Deviation from Test Standard	23
4.2.5 Test Setup.....	23
4.2.6 EUT Operating Conditions.....	23
4.2.7 Test Results	24
5 Pictures of Test Arrangements.....	28
Annex A- Band Edge Measurement	29
Appendix – Information of the Testing Laboratories	31



Release Control Record

Issue No.	Description	Date Issued
RFCBVX-WTW-P22051015-1	Original Release	Jul. 20, 2022

1 Certificate of Conformity

Product: CZ Smart

Brand: Citizen

Test Model: P991MV-01

Sample Status: Engineering Sample

Applicant: Citizen Watch CO., LTD.

Test Date: Jun. 06, 2022 ~ Jun. 09, 2022

Standards: 47 CFR FCC Part 15, Subpart C (Section 15.247)
ANSI C63.10:2013

The above equipment has been tested by **Bureau Veritas Consumer Products Services (H.K.) Ltd., Taoyuan Branch**, and found compliance with the requirement of the above standards. The test record, data evaluation & Equipment Under Test (EUT) configurations represented herein are true and accurate accounts of the measurements of the sample's RF characteristics under the conditions specified in this report.

Prepared by : *Vera Huang* , **Date:** Jul. 20, 2022
Vera Huang / Specialist

Approved by : *Jeremy Lin* , **Date:** Jul. 20, 2022
Jeremy Lin / Project Engineer

2 Summary of Test Results

47 CFR FCC Part 15, Subpart C (Section 15.247)			
FCC Clause	Test Item	Result	Remarks
15.207	AC Power Conducted Emission	Pass	Meet the requirement of limit. Minimum passing margin is -15.28 dB at 0.24200 MHz.
15.205 & 209	Radiated Emissions	Pass	Meet the requirement of limit. Minimum passing margin is -7.2 dB at 2483.50 MHz.
15.247(d)	Band Edge Measurement	N/A	Refer to Note 1
15.247(d)	Antenna Port Emission	N/A	Refer to Note 1
15.247(a)(2)	6 dB Bandwidth	N/A	Refer to Note 1
---	Occupied Bandwidth Measurement	N/A	Refer to Note 1
15.247(b)	Conducted Power	N/A	Refer to Note 1
15.247(e)	Power Spectral Density	N/A	Refer to Note 1
15.203	Antenna Requirement	N/A	Refer to Note 1

Note:

1. Only worst mode of conducted emission and radiated emissions tests were performed for this addendum. Refer to original report for other test data.
2. For 2.4G band compliance with rule 15.247(d) of the band-edge items, the test plots were recorded in Annex A. Test Procedures refer to report 4.1.3.
3. Determining compliance based on the results of the compliance measurement, not taking into account measurement instrumentation uncertainty.

2.1 Measurement Uncertainty

Where relevant, the following measurement uncertainty levels have been estimated for tests performed on the EUT as specified in CISPR 16-4-2:

Measurement	Frequency	Expanded Uncertainty (k=2) (\pm)
Conducted Emissions at mains ports	150 kHz ~ 30 MHz	2.79 dB
Radiated Emissions up to 1 GHz	9 kHz ~ 30 MHz	3.04 dB
	30 MHz ~ 200 MHz	2.93 dB
	200 MHz ~ 1000 MHz	2.95 dB
Radiated Emissions above 1 GHz	1 GHz ~ 18 GHz	2.26 dB
	18 GHz ~ 40 GHz	1.94 dB

2.2 Modification Record

There were no modifications required for compliance.

3 General Information

3.1 General Description of EUT

Product	CZ Smart
Brand	Citizen
Test Model	P991MV-01
Status of EUT	Engineering Sample
Power Supply Rating	5.0 Vdc (adapter or host equipment) 3.88 Vdc (Li-ion battery)
Modulation Type	GFSK
Transfer Rate	LE 4.0: 1 Mbps LE 5.0: 2 Mbps
Operating Frequency	2402 ~ 2480 MHz
Number of Channel	40
Antenna Type	PIFA antenna with -5.72 dBi gain
Antenna Connector	N/A
Accessory Device	Refer to Note as below
Data Cable Supplied	Refer to Note as below

Note:

1. This report is prepared for FCC class II permissive change. The difference compared with the original report (BV CPS report no.: RFBHJP-WTW-P21010398-1) are changing applicant, brand name, model name, product name, appearance, and antenna gain. Therefore, only worst mode of conducted emission and radiated emissions were verified and recorded in this report.
2. The EUT contains following accessory devices.

Product	Brand	Model	Description
Charging Dock	Simula	CB407D-6040-202	Voltage Rating: 5V 0.95m shielded cable w/o core
Battery	Lishen	DAGP382427SA	3.88 Vdc, 300 mAh

3. The above Antenna information refers to the manufacturer's antenna specifications, the laboratory shall not be held responsible.
4. The above EUT information is declared by manufacturer and for more detailed features description, please refers to the manufacturer's specifications or User's Manual.

3.2 Description of Test Modes

40 channels are provided to this EUT:

Channel	Freq. (MHz)	Channel	Freq. (MHz)	Channel	Freq. (MHz)	Channel	Freq. (MHz)
0	2402	10	2422	20	2442	30	2462
1	2404	11	2424	21	2444	31	2464
2	2406	12	2426	22	2446	32	2466
3	2408	13	2428	23	2448	33	2468
4	2410	14	2430	24	2450	34	2470
5	2412	15	2432	25	2452	35	2472
6	2414	16	2434	26	2454	36	2474
7	2416	17	2436	27	2456	37	2476
8	2418	18	2438	28	2458	38	2478
9	2420	19	2440	29	2460	39	2480

3.2.1 Test Mode Applicability and Tested Channel Detail

<LE 4.0>

EUT Configure Mode	Applicable To				Description
	RE \geq 1G	RE<1G	PLC	APCM	
A	√	-	-	-	EUT + Adapter
B	-	-	-	-	EUT + Notebook

Where **RE \geq 1G**: Radiated Emission above 1 GHz **RE<1G**: Radiated Emission below 1 GHz
PLC: Power Line Conducted Emission **APCM**: Antenna Port Conducted Measurement

Note:

1. The EUT had been pre-tested on the positioned of each 3 axis. The worst case was found when positioned on Z-plane.
2. "-" means no effect.

Radiated Emission Test (Above 1 GHz):

- Pre-Scan has been conducted to determine the worst-case mode from all possible combinations between available modulations, data rates and antenna ports (if EUT with antenna diversity architecture).
- Following channel(s) was (were) selected for the final test as listed below.

EUT Configure Mode	Available Channel	Tested Channel	Modulation Type	Data Rate (Mbps)
A	0 to 39	39	GFSK	1

<LE 5.0>

EUT Configure Mode	Applicable To				Description
	RE \geq 1G	RE<1G	PLC	APCM	
A	√	√	√	-	EUT + Adapter
B	-	-	√	-	EUT + Notebook

Where **RE \geq 1G**: Radiated Emission above 1 GHz **RE<1G**: Radiated Emission below 1 GHz
PLC: Power Line Conducted Emission **APCM**: Antenna Port Conducted Measurement

Note:

1. The EUT had been pre-tested on the positioned of each 3 axis. The worst case was found when positioned on Z-plane.
2. "-" means no effect.

Radiated Emission Test (Above 1 GHz):

- Pre-Scan has been conducted to determine the worst-case mode from all possible combinations between available modulations, data rates and antenna ports (if EUT with antenna diversity architecture).
- Following channel(s) was (were) selected for the final test as listed below.

EUT Configure Mode	Available Channel	Tested Channel	Modulation Type	Data Rate (Mbps)
A	0 to 39	39	GFSK	2

Radiated Emission Test (Below 1 GHz):

- Pre-Scan has been conducted to determine the worst-case mode from all possible combinations between available modulations, data rates and antenna ports (if EUT with antenna diversity architecture).
- Following channel(s) was (were) selected for the final test as listed below.

EUT Configure Mode	Available Channel	Tested Channel	Modulation Type	Data Rate (Mbps)
A	0 to 39	39	GFSK	2

Power Line Conducted Emission Test:

- Pre-Scan has been conducted to determine the worst-case mode from all possible combinations between available modulations, data rates and antenna ports (if EUT with antenna diversity architecture).
- Following channel(s) was (were) selected for the final test as listed below.

EUT Configure Mode	Available Channel	Tested Channel	Modulation Type	Data Rate (Mbps)
A, B	0 to 39	39	GFSK	2

Test Condition:

Applicable To	Environmental Conditions	Input Power	Tested by
RE \geq 1G	21 deg. C, 71 % RH	120 Vac, 60 Hz	Thomas Cheng
RE<1G	21 deg. C, 68 % RH	120 Vac, 60 Hz	Thomas Cheng
PLC	23 deg. C, 68 % RH	120 Vac, 60 Hz	Thomas Cheng

3.3 Duty Cycle of Test Signal

Duty cycle of test signal is < 98 %, duty factor shall be considered.

<LE 4.0>

Duty cycle = $0.382/0.632 = 0.604$, Duty factor = $10 * \log(1/0.604) = 2.19$

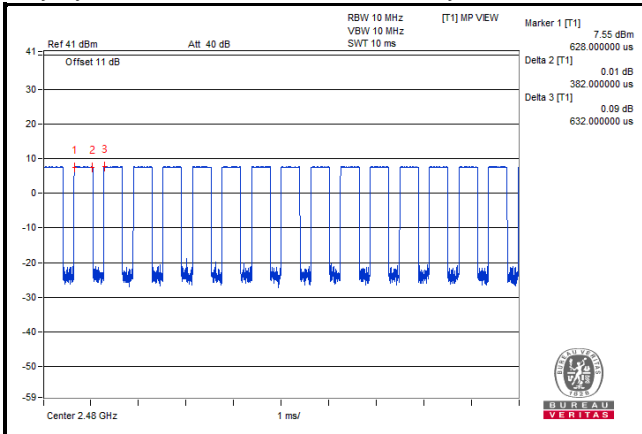

<LE 5.0>

Duty cycle = $0.195/0.634 = 0.308$, Duty factor = $10 * \log(1/0.308) = 5.12$

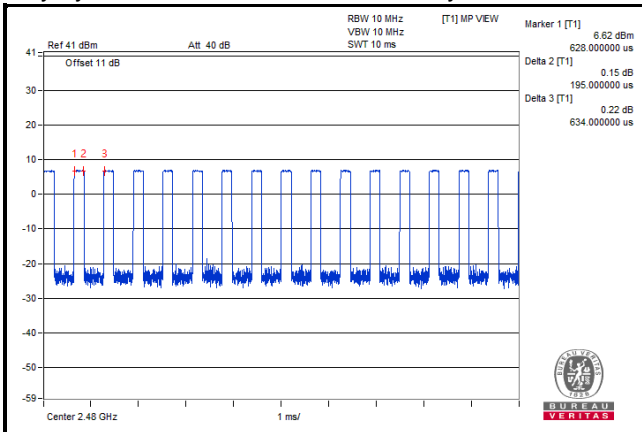

3.4 Description of Support Units

The EUT has been tested as an independent unit together with other necessary accessories or support units. The following support units or accessories were used to form a representative test configuration during the tests.

ID	Product	Brand	Model No.	Serial No.	FCC ID	Remarks
A	Adapter	ASUS	AD827M	NA	NA	Provided by Lab
B	Notebook	Lenovo	80Q7	PF0KUGU6	NA	Provided by Lab

Note:

1. All power cords of the above support units are non-shielded (1.8m).

ID	Descriptions	Qty.	Length (m)	Shielding (Yes/No)	Cores (Qty.)	Remarks
1.	Charging Cable	1	0.95	Y	0	Accessory of the EUT

3.4.1 Configuration of System under Test

Mode A

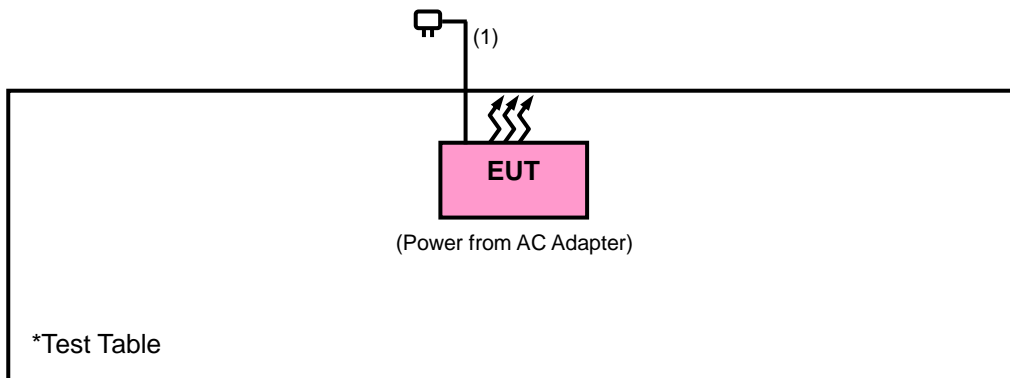

Mode B

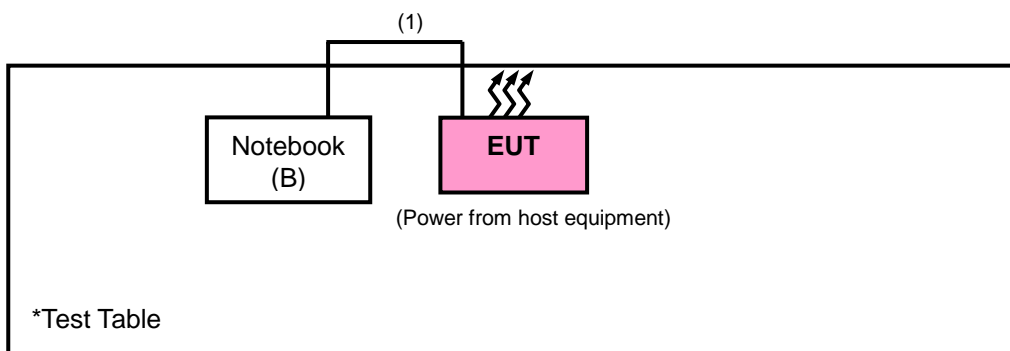

3.5 General Description of Applied Standards and References

The EUT is a RF Product. According to the specifications of the manufacturer, it must comply with the requirements of the following standards and references:

Test Standard:

FCC Part 15, Subpart C (15.247)

ANSI C63.10-2013

All test items have been performed and recorded as per the above standards.

References Test Guidance:

KDB 558074 D01 15.247 Meas Guidance v05r02

All test items have been performed as a reference to the above KDB test guidance.

4 Test Types and Results

4.1 Radiated Emission and Bandedge Measurement

4.1.1 Limits of Radiated Emission and Bandedge Measurement

Radiated emissions which fall in the restricted bands must comply with the radiated emission limits specified as below table. Other emissions shall be at least 20 dB below the highest level of the desired power:

Frequencies (MHz)	Field Strength (microvolts/meter)	Measurement Distance (meters)
0.009 ~ 0.490	2400/F (kHz)	300
0.490 ~ 1.705	24000/F (kHz)	30
1.705 ~ 30.0	30	30
30 ~ 88	100	3
88 ~ 216	150	3
216 ~ 960	200	3
Above 960	500	3

Note:

1. The lower limit shall apply at the transition frequencies.
2. Emission level (dBuV/m) = 20 log Emission level (uV/m).
3. For frequencies above 1000 MHz, the field strength limits are based on average detector, however, the peak field strength of any emission shall not exceed the maximum permitted average limits, specified above by more than 20 dB under any condition of modulation.

4.1.2 Test Instruments

Description & Manufacturer	Model No.	Serial No.	Date of Calibration	Due Date of Calibration
Spectrum Analyzer Agilent	N9038A	MY51210203	Sep. 22, 2021	Sep. 21, 2022
Spectrum Analyzer Agilent	N9010A	MY52220207	Jan. 06, 2022	Jan. 05, 2023
HORN Antenna SCHWARZBECK	BBHA 9170	9170-480	Nov. 14, 2021	Nov. 13, 2022
HORN Antenna SCHWARZBECK	BBHA 9120D	9120D-969	Nov. 14, 2021	Nov. 13, 2022
BILOG Antenna SCHWARZBECK	VULB 9168	9168-472	Oct. 28, 2021	Oct. 27, 2022
Fixed Attenuator WOKEN	MDCS18N-10	MDCS18N-10-01	Apr. 05, 2022	Apr. 04, 2023
Loop Antenna	EM-6879	269	Sep. 16, 2021	Sep. 15, 2022
Preamplifier EMCI	EMC001340	980201	Sep. 15, 2021	Sep. 14, 2022
Preamplifier EMCI	EMC 012645	980115	Oct. 05, 2021	Oct. 04, 2022
Preamplifier EMCI	EMC 330H	980112	Oct. 05, 2021	Oct. 04, 2022
RF Coaxial Cable EMCI	EMC104-SM-SM-8000	171005	Oct. 05, 2021	Oct. 04, 2022
RF Coaxial Cable HUBER+SUHNNER	SUCOFLEX 104	EMC104-SM-SM-1000(140807)	Oct. 05, 2021	Oct. 04, 2022
RF Coaxial Cable WOKEN	8D-FB	Cable-Ch10-01	Oct. 05, 2021	Oct. 04, 2022
Boresight Antenna Fixture	FBA-01	FBA-SIP01	NA	NA
Software BV ADT	E3 6.120103	NA	NA	NA
Antenna Tower MF	MFA-440H	NA	NA	NA
Turn Table MF	MFT-201SS	NA	NA	NA
Antenna Tower & Turn Table Controller MF	MF-7802	NA	NA	NA

- Note: 1. The calibration interval of the above test instruments is 12 months and the calibrations are traceable to NML/ROC and NIST/USA.
2. The test was performed in HwaYa Chamber 10.

4.1.3 Test Procedures

For Radiated Emission below 30 MHz

- a. The EUT was placed on the top of a rotating table 0.8 meters above the ground at a 3 meter chamber room. The table was rotated 360 degrees to determine the position of the highest radiation.
- b. The EUT was set 3 meters away from the interference-receiving antenna, which was mounted on the top of a variable-height antenna tower.
- c. Parallel, perpendicular, and ground-parallel orientations of the antenna are set to make the measurement.
- d. For each suspected emission, the EUT was arranged to its worst case and the rotatable table was turned from 0 degrees to 360 degrees to find the maximum reading.
- e. The test-receiver system was set to Quasi-Peak Detect Function and Specified Bandwidth with Maximum Hold Mode.

Note:

1. The resolution bandwidth and video bandwidth of test receiver/spectrum analyzer is 9 kHz at frequency below 30 MHz.

For Radiated Emission above 30 MHz

- a. The EUT was placed on the top of a rotating table 0.8 meters (for 30 MHz ~ 1 GHz) / 1.5 meters (for above 1 GHz) above the ground at 3 meter chamber room for test. The table was rotated 360 degrees to determine the position of the highest radiation.
- b. The EUT was set 3 meters away from the interference-receiving antenna, which was mounted on the top of a variable-height antenna tower.
- c. The height of antenna is varied from one meter to four meters above the ground to determine the maximum value of the field strength. Both horizontal and vertical polarizations of the antenna are set to make the measurement.
- d. For each suspected emission, the EUT was arranged to its worst case and then the antenna was tuned to heights from 1 meter to 4 meters and the rotatable table was turned from 0 degrees to 360 degrees to find the maximum reading.
- e. The test-receiver system was set to quasi-peak detect function and specified bandwidth with maximum hold mode when the test frequency is below 1 GHz.
- f. The test-receiver system was set to peak and average detected function and specified bandwidth with maximum hold mode when the test frequency is above 1 GHz. If the peak reading value also meets average limit, measurement with the average detector is unnecessary.

Note:

1. The resolution bandwidth and video bandwidth of test receiver/spectrum analyzer is 120 kHz for Quasi-peak detection (QP) at frequency below 1 GHz.
2. The resolution bandwidth of test receiver/spectrum analyzer is 1 MHz and the video bandwidth is 3 MHz for Peak detection (PK) at frequency above 1 GHz.
3. The resolution bandwidth of test receiver/spectrum analyzer is 1 MHz and the video bandwidth is $\geq 1/T$ (Duty cycle < 98 %) or 10 Hz (Duty cycle ≥ 98 %) for Average detection (AV) at frequency above 1 GHz. (LE 4.0: RBW = 1 MHz, VBW = 10 Hz ; LE 5.0: RBW = 1 MHz, VBW = 10 Hz)
4. All modes of operation were investigated and the worst-case emissions are reported.

4.1.4 Deviation from Test Standard

No deviation.

4.1.5 Test Set Up

<Radiated Emission below 30 MHz>

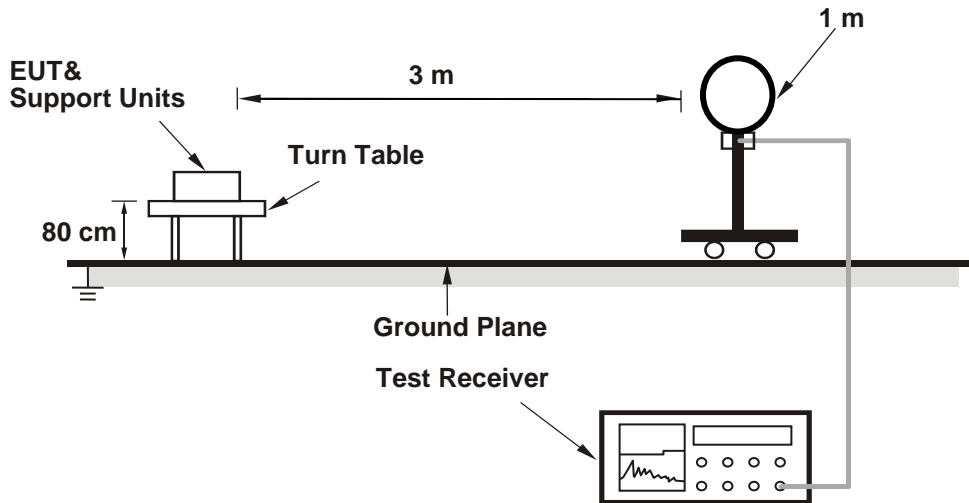

<Radiated Emission 30 MHz to 1 GHz>

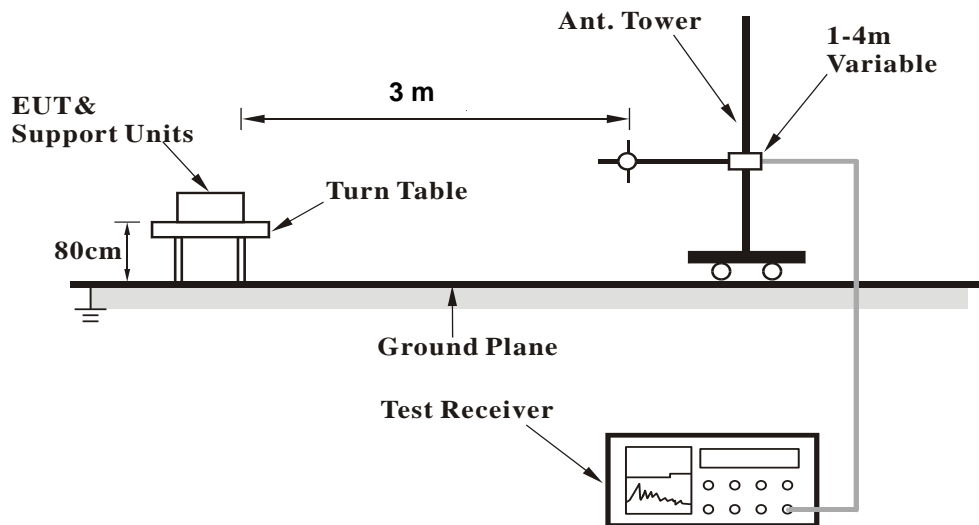

<Radiated Emission above 1 GHz>

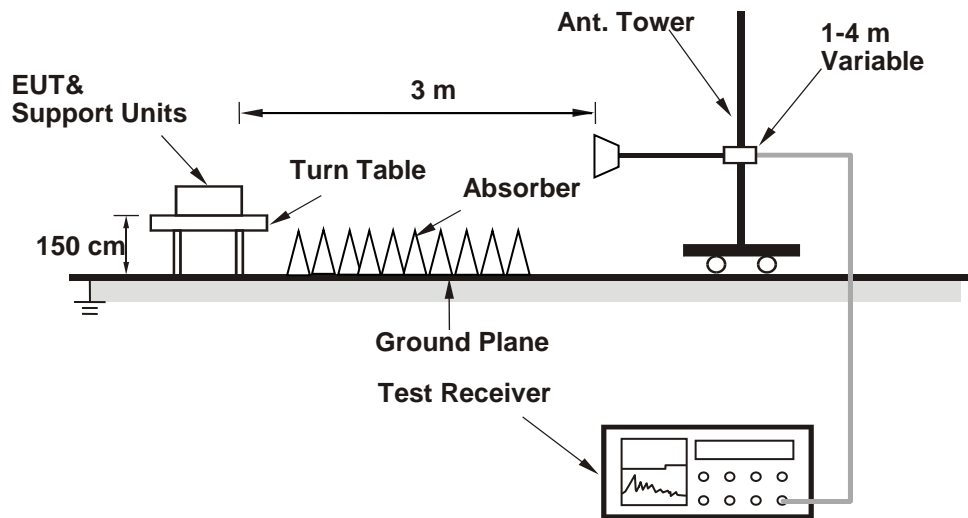

For the actual test configuration, please refer to the attached file (Test Setup Photo).

4.1.6 EUT Operating Conditions

- a. Placed the EUT on the testing table.
- b. Set the EUT under transmission condition continuously at specific channel frequency.

4.1.7 Test Results

Above 1 GHz Data:

RF Mode	TX BT-LE 1M	Channel	CH 39 : 2480 MHz
Frequency Range	1GHz ~ 25GHz	Detector Function	Peak (PK) Average (AV)

Antenna Polarity & Test Distance : Horizontal at 3 m								
No	Frequency (MHz)	Emission Level (dBuV/m)	Limit (dBuV/m)	Margin (dB)	Antenna Height (m)	Table Angle (Degree)	Raw Value (dBuV)	Correction Factor (dB/m)
1	*2480.00	95.4 PK			1.00 H	190	64.3	31.1
2	*2480.00	94.3 AV			1.00 H	190	63.2	31.1
3	2483.50	57.9 PK	74.0	-16.1	1.00 H	190	26.8	31.1
4	2483.50	46.7 AV	54.0	-7.3	1.00 H	190	15.6	31.1
5	4960.00	41.6 PK	74.0	-32.4	1.08 H	286	58.2	-16.6
6	4960.00	32.0 AV	54.0	-22.0	1.08 H	286	48.6	-16.6
Antenna Polarity & Test Distance : Vertical at 3 m								
No	Frequency (MHz)	Emission Level (dBuV/m)	Limit (dBuV/m)	Margin (dB)	Antenna Height (m)	Table Angle (Degree)	Raw Value (dBuV)	Correction Factor (dB/m)
1	*2480.00	92.3 PK			1.35 V	108	61.2	31.1
2	*2480.00	91.7 AV			1.35 V	108	60.6	31.1
3	2483.50	57.8 PK	74.0	-16.2	1.35 V	108	26.7	31.1
4	2483.50	46.6 AV	54.0	-7.4	1.35 V	108	15.5	31.1
5	4960.00	41.3 PK	74.0	-32.7	1.41 V	310	57.9	-16.6
6	4960.00	31.8 AV	54.0	-22.2	1.41 V	310	48.4	-16.6

Remarks:

1. Emission Level(dBuV/m) = Raw Value(dBuV) + Correction Factor(dB/m)
2. Correction Factor(dB/m) = Antenna Factor(dB/m) + Cable Factor(dB) – Pre-Amplifier Factor(dB)
3. Margin value = Emission Level – Limit value
4. The other emission levels were very low against the limit.
5. " * ": Fundamental frequency.

RF Mode	TX BT-LE 2M	Channel	CH 39 : 2480 MHz
Frequency Range	1GHz ~ 25GHz	Detector Function	Peak (PK) Average (AV)

Antenna Polarity & Test Distance : Horizontal at 3 m								
No	Frequency (MHz)	Emission Level (dBuV/m)	Limit (dBuV/m)	Margin (dB)	Antenna Height (m)	Table Angle (Degree)	Raw Value (dBuV)	Correction Factor (dB/m)
1	*2480.00	95.6 PK			1.00 H	190	64.5	31.1
2	*2480.00	92.0 AV			1.00 H	190	60.9	31.1
3	2483.50	57.9 PK	74.0	-16.1	1.00 H	190	26.8	31.1
4	2483.50	46.8 AV	54.0	-7.2	1.00 H	190	15.7	31.1
5	4960.00	43.2 PK	74.0	-30.8	2.76 H	92	59.1	-15.9
6	4960.00	33.0 AV	54.0	-21.0	2.76 H	92	48.9	-15.9

Antenna Polarity & Test Distance : Vertical at 3 m								
No	Frequency (MHz)	Emission Level (dBuV/m)	Limit (dBuV/m)	Margin (dB)	Antenna Height (m)	Table Angle (Degree)	Raw Value (dBuV)	Correction Factor (dB/m)
1	*2480.00	93.1 PK			1.33 V	109	62.0	31.1
2	*2480.00	89.5 AV			1.33 V	109	58.4	31.1
3	2483.50	57.8 PK	74.0	-16.2	1.33 V	109	26.7	31.1
4	2483.50	46.7 AV	54.0	-7.3	1.33 V	109	15.6	31.1
5	4960.00	42.9 PK	74.0	-31.1	1.75 V	47	58.8	-15.9
6	4960.00	32.7 AV	54.0	-21.3	1.75 V	47	48.6	-15.9

Remarks:

1. Emission Level(dBuV/m) = Raw Value(dBuV) + Correction Factor(dB/m)
2. Correction Factor(dB/m) = Antenna Factor(dB/m) + Cable Factor(dB) – Pre-Amplifier Factor(dB)
3. Margin value = Emission Level – Limit value
4. The other emission levels were very low against the limit.
5. " * ": Fundamental frequency.

Below 1 GHz Worst-Case Data:

RF Mode	TX BT-LE 2M	Channel	CH 39 : 2480 MHz
Frequency Range	9kHz ~ 1GHz	Detector Function	Quasi-Peak (QP)

Antenna Polarity & Test Distance : Horizontal at 3 m								
No	Frequency (MHz)	Emission Level (dBuV/m)	Limit (dBuV/m)	Margin (dB)	Antenna Height (m)	Table Angle (Degree)	Raw Value (dBuV)	Correction Factor (dB/m)
1	61.04	26.9 QP	40.0	-13.1	2.31 H	153	40.4	-13.5
2	179.40	29.4 QP	43.5	-14.1	2.29 H	269	43.6	-14.2
3	304.54	28.1 QP	46.0	-17.9	2.28 H	298	40.0	-11.9
4	452.96	30.9 QP	46.0	-15.1	2.53 H	9	38.1	-7.2
5	687.73	29.0 QP	46.0	-17.0	3.46 H	215	30.9	-1.9
6	831.30	32.8 QP	46.0	-13.2	1.16 H	254	31.8	1.0

Remarks:

1. Emission Level(dBuV/m) = Raw Value(dBuV) + Correction Factor(dB/m)
2. Correction Factor(dB/m) = Antenna Factor(dB/m) + Cable Factor(dB) – Pre-Amplifier Factor(dB)
3. Margin value = Emission Level – Limit value
4. The other emission levels were very low against the limit of frequency range 30MHz~1000MHz.
5. The emission levels were very low against the limit of frequency range 9kHz~30MHz: the amplitude of spurious emissions attenuated more than 20 dB below the permissible value to be report.

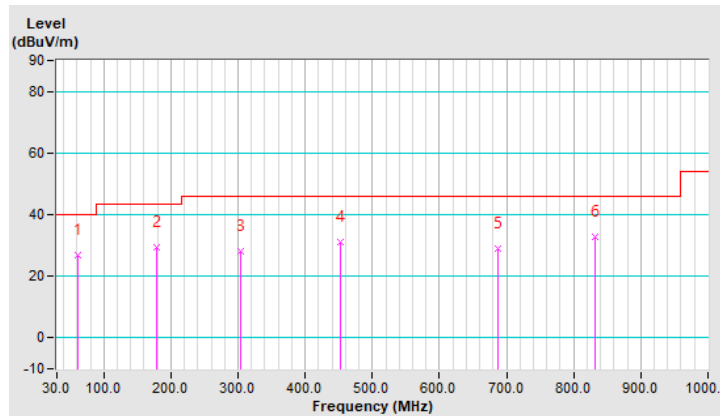

RF Mode	TX BT-LE 2M	Channel	CH 39 : 2480 MHz
Frequency Range	9kHz ~ 1GHz	Detector Function	Quasi-Peak (QP)

Antenna Polarity & Test Distance : Vertical at 3 m								
No	Frequency (MHz)	Emission Level (dBuV/m)	Limit (dBuV/m)	Margin (dB)	Antenna Height (m)	Table Angle (Degree)	Raw Value (dBuV)	Correction Factor (dB/m)
1	34.85	28.0 QP	40.0	-12.0	1.05 V	248	41.7	-13.7
2	129.92	29.9 QP	43.5	-13.6	2.95 V	349	43.3	-13.4
3	324.91	30.2 QP	46.0	-15.8	1.53 V	168	41.3	-11.1
4	480.13	28.4 QP	46.0	-17.6	2.46 V	278	35.2	-6.8
5	650.86	29.6 QP	46.0	-16.4	3.03 V	269	32.2	-2.6
6	858.47	32.6 QP	46.0	-13.4	1.56 V	162	31.4	1.2

Remarks:

1. Emission Level(dBuV/m) = Raw Value(dBuV) + Correction Factor(dB/m)
2. Correction Factor(dB/m) = Antenna Factor(dB/m) + Cable Factor(dB) – Pre-Amplifier Factor(dB)
3. Margin value = Emission Level – Limit value
4. The other emission levels were very low against the limit of frequency range 30MHz~1000MHz.
5. The emission levels were very low against the limit of frequency range 9kHz~30MHz: the amplitude of spurious emissions attenuated more than 20 dB below the permissible value to be report.

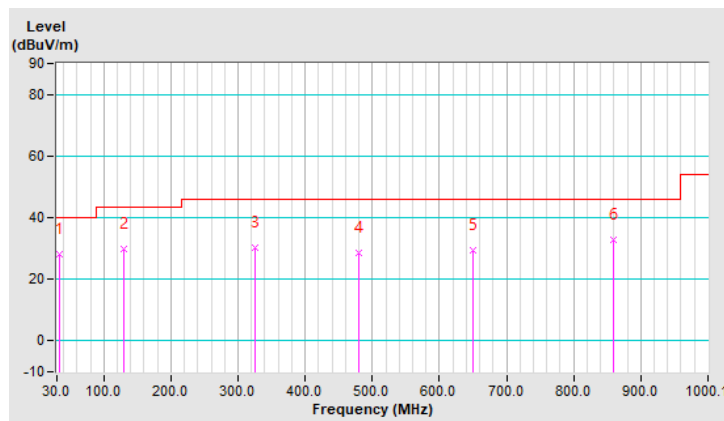

4.2 Conducted Emission Measurement

4.2.1 Limits of Conducted Emission Measurement

Frequency (MHz)	Conducted Limit (dBuV)	
	Quasi-Peak	Average
0.15 - 0.5	66 - 56	56 - 46
0.50 - 5.0	56	46
5.0 - 30.0	60	50

- Note: 1. The lower limit shall apply at the transition frequencies.
 2. The limit decreases in line with the logarithm of the frequency in the range of 0.15 to 0.50 MHz.

4.2.2 Test Instruments

Description & Manufacturer	Model No.	Serial No.	Date of Calibration	Due Date of Calibration
Test Receiver ROHDE & SCHWARZ	ESR3	102783	Dec. 20, 2021	Dec. 19, 2022
RF signal cable (with 10dB PAD) Woken	5D-FB	Cable-cond2-01	Sep. 04, 2021	Sep. 03, 2022
LISN/AMN ROHDE & SCHWARZ (EUT)	ESH2-Z5	100100	Feb. 17, 2022	Feb. 16, 2023
LISN/AMN ROHDE & SCHWARZ (Peripheral)	ESH3-Z5	100312	Sep. 17, 2021	Sep. 16, 2022
Software ADT	BV ADT_Cond_ V7.3.7.4	NA	NA	NA

- Note: 1. The calibration interval of the above test instruments is 12 months and the calibrations are traceable to NML/ROC and NIST/USA.
 2. The test was performed in HwaYa Shielded Room 2.
 3. The VCCI Site Registration No. is C-12047.

4.2.3 Test Procedures

- The EUT was placed 0.4 meters from the conducting wall of the shielded room with EUT being connected to the power mains through a line impedance stabilization network (LISN). Other support units were connected to the power mains through another LISN. The two LISNs provide 50 ohm/50 uH of coupling impedance for the measuring instrument.
- Both lines of the power mains connected to the EUT were checked for maximum conducted interference.
- The frequency range from 150 kHz to 30 MHz was searched. Emission levels under (Limit – 20 dB) was not recorded.

Note: The resolution bandwidth and video bandwidth of test receiver is 9 kHz for quasi-peak detection (QP) and average detection (AV) at frequency 0.15 MHz - 30 MHz.

4.2.4 Deviation from Test Standard

No deviation.

4.2.5 Test Setup

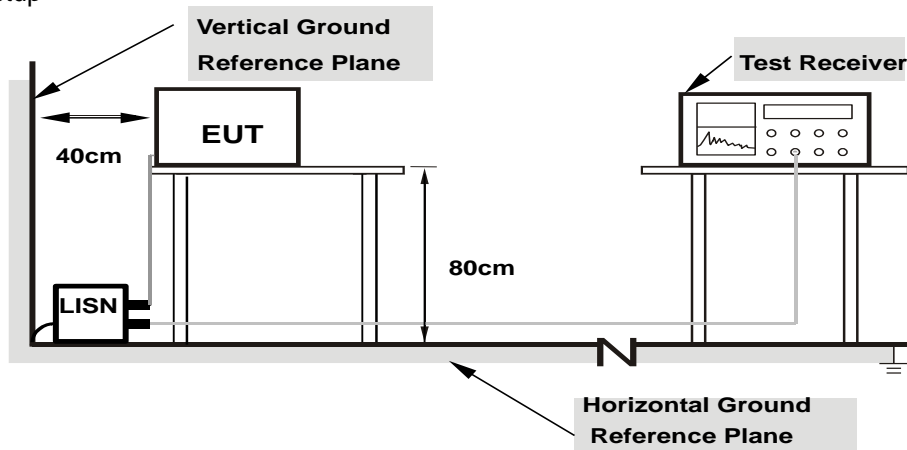

- Note:**
- Support units were connected to second LISN.
 - Both of LISNs (AMN) are 80 cm from EUT and at least 80 from other units and other metal planes

4.2.6 EUT Operating Conditions

- Placed the EUT on the testing table.
- Set the EUT under transmission condition continuously at specific channel frequency.

4.2.7 Test Results

Mode A

Frequency Range	150 kHz ~ 30 MHz	Detector Function & Resolution Bandwidth	Quasi-Peak (QP) / Average (AV), 9kHz
Input Power	120 Vac, 60 Hz	Environmental Conditions	23°C, 68% RH
Tested by	Thomas Cheng		

Phase Of Power : Line (L)										
No	Frequency (MHz)	Correction Factor (dB)	Reading Value (dBuV)		Emission Level (dBuV)		Limit (dBuV)		Margin (dB)	
			Q.P.	AV.	Q.P.	AV.	Q.P.	AV.	Q.P.	AV.
1	0.16200	10.14	37.34	25.52	47.48	35.66	65.36	55.36	-17.88	-19.70
2	0.23785	10.18	33.22	17.78	43.40	27.96	62.17	52.17	-18.77	-24.21
3	0.81400	10.28	23.85	12.36	34.13	22.64	56.00	46.00	-21.87	-23.36
4	4.52600	10.41	22.22	11.60	32.63	22.01	56.00	46.00	-23.37	-23.99
5	6.07000	10.42	22.41	11.00	32.83	21.42	60.00	50.00	-27.17	-28.58
6	25.27000	10.45	18.50	7.35	28.95	17.80	60.00	50.00	-31.05	-32.20

Remarks:

1. Q.P. and AV. are abbreviations of quasi-peak and average individually.
2. The emission levels of other frequencies were very low against the limit.
3. Margin value = Emission level – Limit value
4. Correction factor = Insertion loss + Cable loss
5. Emission Level = Correction Factor + Reading Value

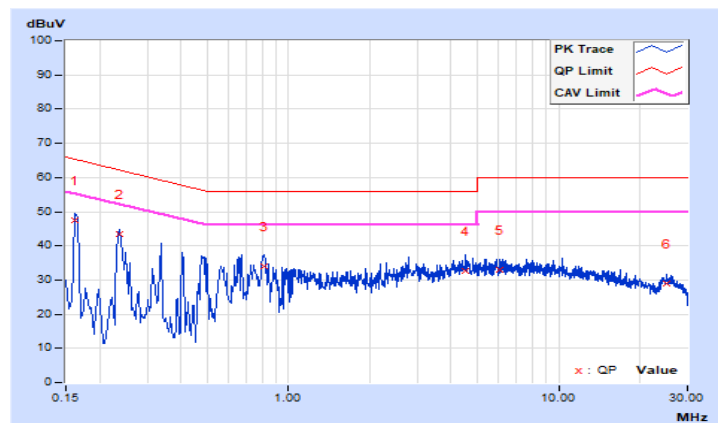

Frequency Range	150 kHz ~ 30 MHz	Detector Function & Resolution Bandwidth	Quasi-Peak (QP) / Average (AV), 9kHz
Input Power	120 Vac, 60 Hz	Environmental Conditions	23°C, 68% RH
Tested by	Thomas Cheng		

Phase Of Power : Neutral (N)										
No	Frequency (MHz)	Correction Factor (dB)	Reading Value (dBuV)		Emission Level (dBuV)		Limit (dBuV)		Margin (dB)	
			Q.P.	AV.	Q.P.	AV.	Q.P.	AV.	Q.P.	AV.
1	0.15770	10.15	39.46	26.27	49.61	36.42	65.58	55.58	-15.97	-19.16
2	0.24200	10.20	36.55	20.99	46.75	31.19	62.03	52.03	-15.28	-20.84
3	0.79800	10.29	24.92	14.62	35.21	24.91	56.00	46.00	-20.79	-21.09
4	4.22200	10.40	23.44	11.81	33.84	22.21	56.00	46.00	-22.16	-23.79
5	5.45000	10.43	23.17	11.37	33.60	21.80	60.00	50.00	-26.40	-28.20
6	11.11800	10.53	22.29	9.50	32.82	20.03	60.00	50.00	-27.18	-29.97

Remarks:

1. Q.P. and AV. are abbreviations of quasi-peak and average individually.
2. The emission levels of other frequencies were very low against the limit.
3. Margin value = Emission level – Limit value
4. Correction factor = Insertion loss + Cable loss
5. Emission Level = Correction Factor + Reading Value

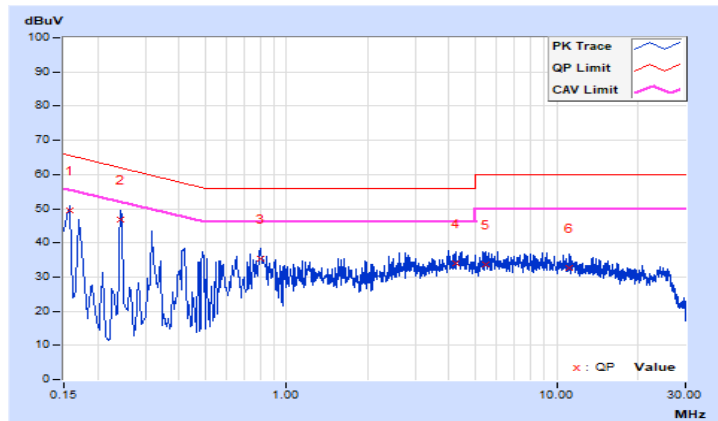

Mode B

Frequency Range	150 kHz ~ 30 MHz	Detector Function & Resolution Bandwidth	Quasi-Peak (QP) / Average (AV), 9kHz
Input Power	120 Vac, 60 Hz	Environmental Conditions	23°C, 68% RH
Tested by	Thomas Cheng		

Phase Of Power : Line (L)										
No	Frequency (MHz)	Correction Factor (dB)	Reading Value (dBuV)		Emission Level (dBuV)		Limit (dBuV)		Margin (dB)	
			Q.P.	AV.	Q.P.	AV.	Q.P.	AV.	Q.P.	AV.
1	0.15687	10.13	39.69	19.60	49.82	29.73	65.63	55.63	-15.81	-25.90
2	0.21800	10.14	33.41	14.47	43.55	24.61	62.89	52.89	-19.34	-28.28
3	1.99800	10.22	22.81	13.49	33.03	23.71	56.00	46.00	-22.97	-22.29
4	3.53000	10.24	22.16	8.19	32.40	18.43	56.00	46.00	-23.60	-27.57
5	5.73800	10.26	20.75	8.27	31.01	18.53	60.00	50.00	-28.99	-31.47
6	19.04200	10.39	18.33	9.73	28.72	20.12	60.00	50.00	-31.28	-29.88

Remarks:

1. Q.P. and AV. are abbreviations of quasi-peak and average individually.
2. The emission levels of other frequencies were very low against the limit.
3. Margin value = Emission level – Limit value
4. Correction factor = Insertion loss + Cable loss
5. Emission Level = Correction Factor + Reading Value

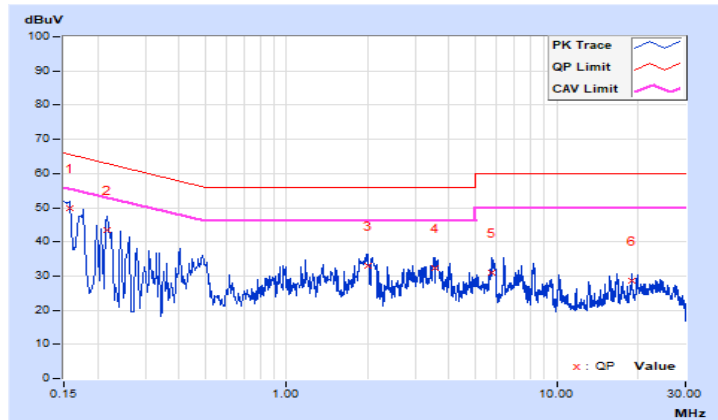

Frequency Range	150 kHz ~ 30 MHz	Detector Function & Resolution Bandwidth	Quasi-Peak (QP) / Average (AV), 9kHz
Input Power	120 Vac, 60 Hz	Environmental Conditions	23°C, 68% RH
Tested by	Thomas Cheng		

Phase Of Power : Neutral (N)										
No	Frequency (MHz)	Correction Factor (dB)	Reading Value (dBuV)		Emission Level (dBuV)		Limit (dBuV)		Margin (dB)	
			Q.P.	AV.	Q.P.	AV.	Q.P.	AV.	Q.P.	AV.
1	0.15800	10.14	39.71	19.84	49.85	29.98	65.57	55.57	-15.72	-25.59
2	0.19400	10.15	37.16	16.58	47.31	26.73	63.86	53.86	-16.55	-27.13
3	0.48200	10.17	24.37	14.41	34.54	24.58	56.30	46.30	-21.76	-21.72
4	3.20200	10.25	18.97	10.00	29.22	20.25	56.00	46.00	-26.78	-25.75
5	5.34200	10.29	18.06	7.57	28.35	17.86	60.00	50.00	-31.65	-32.14
6	22.72200	10.45	16.37	9.47	26.82	19.92	60.00	50.00	-33.18	-30.08

Remarks:

1. Q.P. and AV. are abbreviations of quasi-peak and average individually.
2. The emission levels of other frequencies were very low against the limit.
3. Margin value = Emission level – Limit value
4. Correction factor = Insertion loss + Cable loss
5. Emission Level = Correction Factor + Reading Value

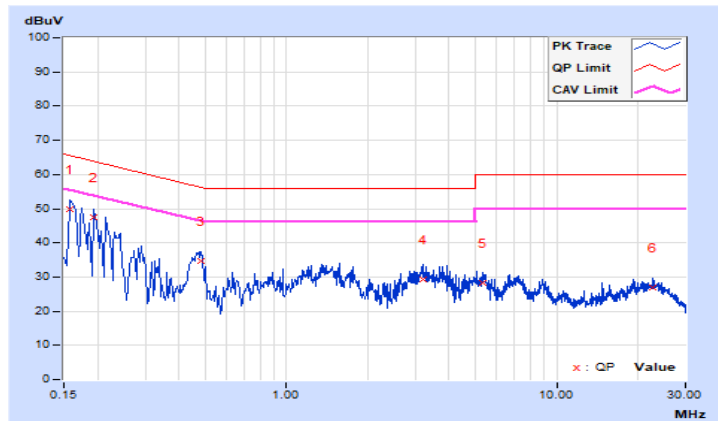

5 Pictures of Test Arrangements

Please refer to the attached file (Test Setup Photo).

Annex A- Band Edge Measurement

BT-LE 1M Channel 39

Horizontal (Peak)

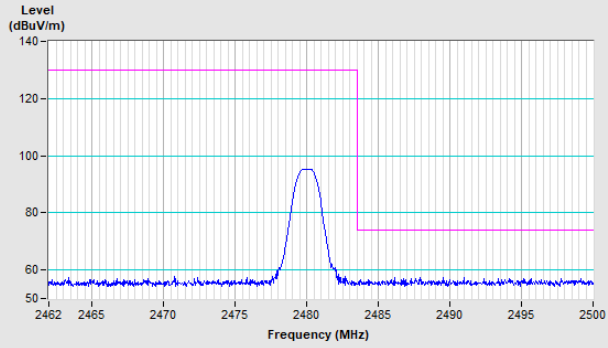

Horizontal (Average)

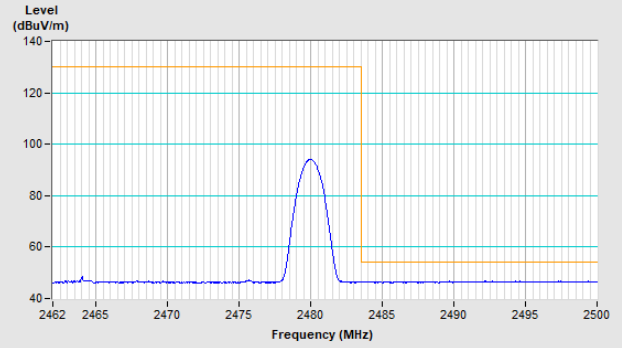

Vertical (Peak)

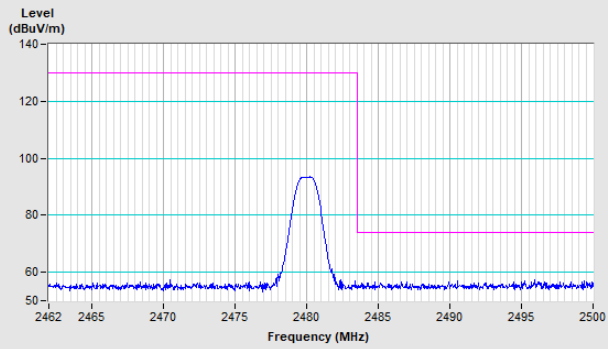

Vertical (Average)

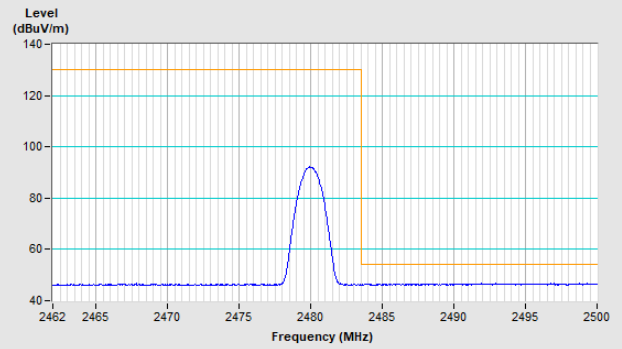

BT-LE 2M Channel 39

Horizontal (Peak)

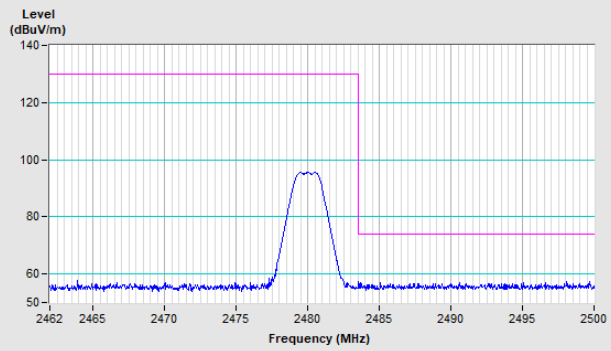

Horizontal (Average)

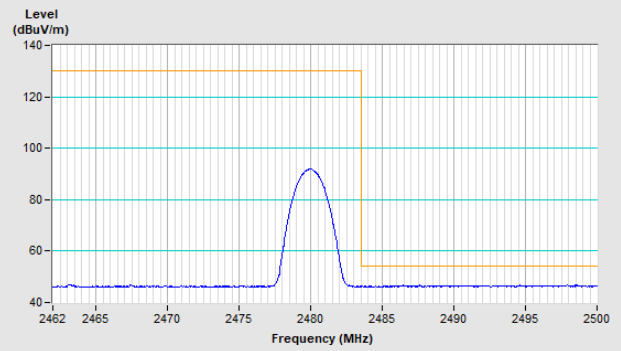

Vertical (Peak)

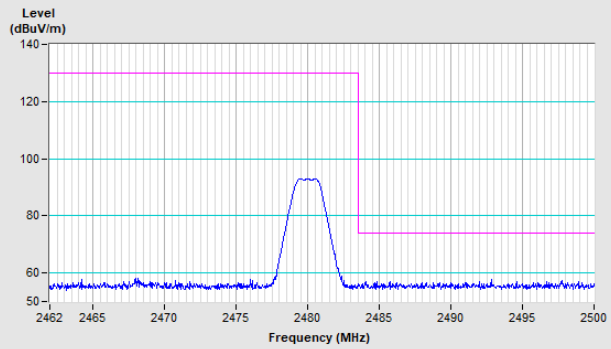

Vertical (Average)

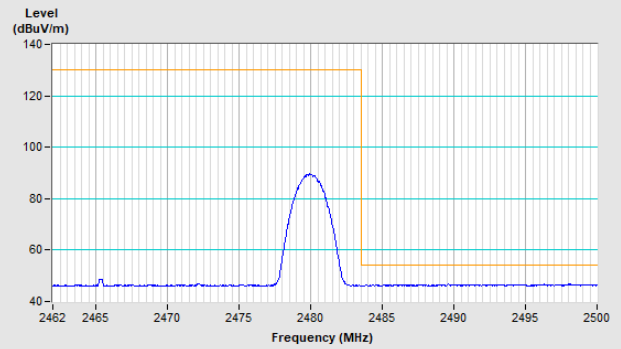

Appendix – Information of the Testing Laboratories

We, Bureau Veritas Consumer Products Services (H.K.) Ltd., Taoyuan Branch, were founded in 1988 to provide our best service in EMC, Radio, Telecom and Safety consultation. Our laboratories are FCC recognized accredited test firms and accredited according to ISO/IEC 17025.

If you have any comments, please feel free to contact us at the following:

Lin Kou EMC/RF Lab

Tel: 886-2-26052180

Fax: 886-2-26051924

Hsin Chu EMC/RF/Telecom Lab

Tel: 886-3-6668565

Fax: 886-3-6668323

Hwa Ya EMC/RF/Safety Lab

Tel: 886-3-3183232

Fax: 886-3-3270892

Email: service.adt@tw.bureauveritas.com

Web Site: www.bureauveritas-adt.com

The address and road map of all our labs can be found in our web site also.

--- END ---