



FCC RADIO TEST REPORT

FCC ID : UZ7TC78A1
Equipment : Touch Computer
Brand Name : Zebra
Model Name : TC78A1
Applicant : Zebra Technologies Corporation
1 Zebra Plaza, Holtsville, NY 11742
Manufacturer : Zebra Technologies Corporation
1 Zebra Plaza, Holtsville, NY 11742
Standard : FCC PART 15 Subpart C §15.247

The product was received on Jul. 15, 2022 and testing was performed from Aug. 08, 2022 to Oct. 11, 2022. We, Sporton International Inc. Wensan Laboratory, would like to declare that the tested sample has been evaluated in accordance with the test procedures and has been in compliance with the applicable technical standards.

The test results in this report apply exclusively to the tested model / sample. Without written approval from Sporton International Inc. Wensan Laboratory, the test report shall not be reproduced except in full.

Approved by: Louis Wu

Sporton International Inc. Wensan Laboratory

No.58, Aly. 75, Ln. 564, Wenhua 3rd, Rd., Guishan Dist., Taoyuan City 333010, Taiwan (R.O.C.)



Table of Contents

History of this test report.....	3
Summary of Test Result.....	4
1 General Description	5
1.1 Product Feature of Equipment Under Test.....	5
1.2 Product Specification of Equipment Under Test.....	9
1.3 Modification of EUT	10
1.4 Testing Location	11
1.5 Applicable Standards.....	11
2 Test Configuration of Equipment Under Test	12
2.1 Carrier Frequency and Channel	12
2.2 Test Mode.....	13
2.3 Connection Diagram of Test System.....	15
2.4 Support Unit used in test configuration and system	16
2.5 EUT Operation Test Setup	16
2.6 Measurement Results Explanation Example.....	16
3 Test Result	17
3.1 6dB and 99% Bandwidth Measurement	17
3.2 Output Power Measurement.....	21
3.3 Power Spectral Density Measurement	23
3.4 Conducted Band Edges and Spurious Emission Measurement	27
3.5 Radiated Band Edges and Spurious Emission Measurement	64
3.6 AC Conducted Emission Measurement.....	70
3.7 Antenna Requirements.....	72
4 List of Measuring Equipment.....	73
5 Uncertainty of Evaluation	75
Appendix A. Conducted Test Results	
Appendix B. AC Conducted Emission Test Result	
Appendix C. Radiated Spurious Emission	
Appendix D. Radiated Spurious Emission Plots	
Appendix E. Duty Cycle Plots	
Appendix F. Setup Photographs	



Summary of Test Result

Report Clause	Ref Std. Clause	Test Items	Result (PASS/FAIL)	Remark
3.1	15.247(a)(2)	6dB Bandwidth	Pass	-
3.1	2.1049	99% Occupied Bandwidth	Reporting only	-
3.2	15.247(b)	Power Output Measurement	Pass	-
3.3	15.247(e)	Power Spectral Density	Pass	-
3.4	15.247(d)	Conducted Band Edges	Pass	-
		Conducted Spurious Emission	Pass	-
3.5	15.247(d)	Radiated Band Edges and Radiated Spurious Emission	Pass	1.32 dB under the limit at 2483.960 MHz
3.6	15.207	AC Conducted Emission	Pass	18.29 dB under the limit at 0.184 MHz
3.7	15.203	Antenna Requirement	Pass	-

Declaration of Conformity:

1. The test results (PASS/FAIL) with all measurement uncertainty excluded are presented in accordance with the regulation limits or requirements declared by manufacturers.
It's means measurement values may risk exceeding the limit of regulation standards, if measurement uncertainty is include in test results.
2. The measurement uncertainty please refer to report "Uncertainty of Evaluation".

Comments and Explanations:

The product specifications of the EUT presented in the report are declared by the manufacturer who shall take full responsibility for the authenticity.

Reviewed by: Wei Chen**Report Producer: Dewi Huang**



1 General Description

1.1 Product Feature of Equipment Under Test

Product Feature	
Equipment	Touch Computer
Brand Name	Zebra
Model Name	TC78A1
FCC ID	UZ7TC78A1
Sample 1	SE5500 + Premium config
Sample 2	SE4770 + Base config
Sample 3	SE5500 + Base config
EUT supports Radios application	GSM/EGPRS/WCDMA/HSPA/LTE/5G NR/NFC/GNSS WLAN 11a/b/g/n HT20/HT40 WLAN 11ac VHT20/VHT40/VHT80/VHT160 WLAN 11ax HE20/HE40/HE80/HE160 Bluetooth BR/EDR/LE
HW Version	EV2
SW Version	athena_A11_userdebug_GMS_RelKey_2022-07-14-1733_product_SE
FW Version	FUSION_QA_4_1.2.0.001_R
MFD	11JUN22
EUT Stage	Identical Prototype

Remark: The EUT's information above is declared by manufacturer.

Specification of Accessories				
Adapter	Brand Name	Zebra	Part Number	PWR-WUA5V12W0US
Battery 1X	Brand Name	Zebra	Part Number	BT-000442-0020
Battery 1.5X	Brand Name	Zebra	Part Number	BT-000442-0820
Wireless Battery	Brand Name	Zebra	Part Number	BT-000442-002A
USB TYPE A to TYPE C cable	Brand Name	Zebra	Part Number	CBL-TC5X-USBC2A-01
USB TYPE C to 3.5mm audio connector	Brand Name	Zebra	Part Number	ADP-USBC-35MM1-01
3.5mm Earphone	Brand Name	Zebra	Part Number	HDST-35MM-PTVP-01
USB TYPE C Earphone	Brand Name	Zebra	Part Number	HPST-USBC-PTT1-01
Trigger Handle	Brand Name	Zebra	Part Number	TRG-NGTC5-ELEC-01
Soft Holster	Brand Name	Zebra	Part Number	SG-NGTC5TC7-HLSTR-01
TC53/TC58 RUGGED BOOT	Brand Name	Zebra	Part Number	SG-NGTC5EXO1-01

1.1.1 Antenna Gain

<For CDD Mode>

Follows FCC KDB 662911 D01 Multiple Transmitter Output v02r01 F2)f)ii)

Directional gain = G_{ANT} + Array Gain, where Array Gain is as follows:

For power measurements on IEEE 802.11 devices,

Array Gain = 0 dB (i.e., no array gain) for $N_{ANT} \leq 4$.

G_{ANT} is set equal to the gain of the antenna having the highest gain.

For PSD measurements, the directional gain calculation.

$$DirectionalGain = 10 \cdot \log \left[\frac{\sum_{j=1}^{N_{SS}} \left\{ \sum_{k=1}^{N_{ANT}} g_{j,k} \right\}^2}{N_{ANT}} \right]$$

where

Each antenna is driven by no more than one spatial stream;

N_{SS} = the number of independent spatial streams of data;

N_{ANT} = the total number of antennas

$g_{j,k} = 10^{G_k / 20}$ if the k th antenna is being fed by spatial stream j , or zero if it is not;
 G_k is the gain in dBi of the k th antenna.

As minimum $N_{SS}=1$ is supported by EUT, the formula can be simplified as:

Directional gain = $10 \cdot \log[(10^{G_1 / 20} + 10^{G_2 / 20} + \dots + 10^{G_N / 20})^2 / N_{ANT}]$ dBi

Where G_1, G_2, \dots, G_N denote single antenna gain.



The directional gain "DG" is calculated as following table.

			DG	DG	Power	PSD
			for	for	Limit	Limit
	Ant 9	Ant 8	Power	PSD	Reduction	Reduction
	(dBi)	(dBi)	(dBi)	(dBi)	(dB)	(dB)
2.4GHz	1.65	-0.60	1.65	3.61	0.00	0.00

Calculation example:

If a device has two antenna, $G_{ANT1} = 1.65\text{dBi}$; $G_{ANT2} = -0.60\text{dBi}$

Directional gain of power measurement = $\max(1.65, -0.60) + 0 = 1.65 \text{ dBi}$

Directional gain of PSD derived from formula which is

$$10 \times \log \left\{ \left[10^{(1.65 \text{ dBi} / 20)} + 10^{(-0.60 \text{ dBi} / 20)} \right]^2 / 2 \right\}$$

= 3.61 dBi

Power and PSD limit reduction = Composite gain – 6dBi, (min = 0)

<TXBF Modes>

The EUT supports beamforming modes , then

Follows FCC KDB 662911 D01 Multiple Transmitter Output v02r01 F)2)e)ii)

$$DirectionalGain = 10 \cdot \log \left[\frac{\sum_{j=1}^{N_{SS}} \left\{ \sum_{k=1}^{N_{ANT}} g_{j,k} \right\}^2}{N_{ANT}} \right]$$

where

Each antenna is driven by no more than one spatial stream;

N_{SS} = the number of independent spatial streams of data;

N_{ANT} = the total number of antennas

$g_{j,k} = 10^{G_k / 20}$ if the k th antenna is being fed by spatial stream j , or zero if it is not;
 G_k is the gain in dBi of the k th antenna.

The directional gain “DG” is calculated as following table.

			DG	DG	Power	PSD
			for	for	Limit	Limit
	Ant 9	Ant 8	Power	PSD	Reduction	Reduction
	(dBi)	(dBi)	(dBi)	(dBi)	(dB)	(dB)
2.4GHz	1.65	-0.60	3.61	3.61	0.00	0.00

Calculation example:

Directional gain is derived from formula which is

$$10 \times \log \left\{ \left[10^{(1.65 \text{ dBi} / 20)} + 10^{(-0.60 \text{ dBi} / 20)} \right]^2 / 2 \right\}$$

= 3.61 dBi

Power and PSD limit reduction = Composite gain -6dBi, (min = 0)

1.2 Product Specification of Equipment Under Test

Product Specification is subject to this standard	
Tx/Rx Channel Frequency Range	2412 MHz ~ 2462 MHz
Maximum Output Power to Antenna <CDD Modes>	MIMO <Ant. 9+8> 802.11b : 23.36 dBm / 0.2168 W 802.11g : 22.01 dBm / 0.1589 W 802.11n HT20 : 21.06 dBm / 0.1276 W 802.11n HT40 : 21.06 dBm / 0.1276 W 802.11ac VHT20: 21.46 dBm / 0.1400 W 802.11ac VHT40: 21.06 dBm / 0.1276 W 802.11ax HE20: 21.56 dBm / 0.1432 W 802.11ax HE40: 21.16 dBm / 0.1306 W
Maximum Output Power <TXBF Modes>	MIMO <Ant. 9+8> 802.11ax HE20: 22.76 dBm / 0.1888 W 802.11ax HE40: 22.11 dBm / 0.1626 W
99% Occupied Bandwidth <CDD Mode>	MIMO <Ant. 9> 802.11b : 14.29 MHz 802.11g : 18.33 MHz 802.11ax HE20 : 19.78 MHz 802.11ax HE40 : 38.16 MHz MIMO <Ant. 8> 802.11b : 14.04 MHz 802.11g : 18.83 MHz 802.11ax HE20 : 19.78 MHz 802.11ax HE40 : 38.06 MHz
99% Occupied Bandwidth <TXBF Mode>	MIMO <Ant. 9> 802.11ax HE20 : 20.63 MHz 802.11ax HE40 : 38.56 MHz MIMO <Ant. 8> 802.11ax HE20 : 21.08 MHz 802.11ax HE40 : 38.46 MHz
Antenna Type / Gain	<Ant. 9> : PIFA Antenna with gain 1.65 dBi <Ant. 8> : PIFA Antenna with gain -0.60 dBi
Type of Modulation	802.11b : DSSS (DBPSK / DQPSK / CCK) 802.11g/n : OFDM (BPSK / QPSK / 16QAM / 64QAM) 802.11ac : OFDM (BPSK / QPSK / 16QAM / 64QAM / 256QAM) 802.11ax : OFDMA (BPSK / QPSK / 16QAM / 64QAM / 256QAM / 1024QAM)



Product Specification is subject to this standard			
Antenna Function Description		Ant. 9	Ant. 8
	802.11 b/g/n/ac/ax MIMO	V	V
	802.11 n/ac/ax TXBF	V	V

Remark:

1. MIMO Ant. 9+8 Directional Gain is a calculated result from MIMO Ant. 9 and MIMO Ant. 8. The formula used in calculation is documented in section 1.1.1.
2. Power of MIMO Ant. 9 + Ant. 8 is a calculated result from sum of the power MIMO Ant. 9 and MIMO Ant. 8.
3. The EUT's information above is declared by manufacturer. Please refer to Comments and Explanations in report summary.

1.3 Modification of EUT

No modifications made to the EUT during the testing.



1.4 Testing Location

Test Site	Sporton International Inc. EMC & Wireless Communications Laboratory
Test Site Location	No.52, Huaya 1st Rd., Guishan Dist., Taoyuan City 333, Taiwan (R.O.C.) TEL: +886-3-327-3456 FAX: +886-3-328-4978
Test Site No.	Sporton Site No. CO05-HY (TAF Code: 1190)
Remark	The Conducted Emission test item subcontracted to Sporton International Inc. EMC & Wireless Communications Laboratory.

Note: The test site complies with ANSI C63.4 2014 requirement.

Test Site	Sporton International Inc. Wensan Laboratory
Test Site Location	No.58, Aly. 75, Ln. 564, Wenhua 3rd, Rd., Guishan Dist., Taoyuan City 333010, Taiwan (R.O.C.) TEL: +886-3-327-0868 FAX: +886-3-327-0855
Test Site No.	Sporton Site No. TH05-HY,03CH16-HY

Note: The test site complies with ANSI C63.4 2014 requirement.

FCC designation No.: TW1190 and TW3786

1.5 Applicable Standards

According to the specifications declared by the manufacturer, the EUT must comply with the requirements of the following standards:

- ♦ FCC Part 15 Subpart C §15.247
- ♦ FCC KDB Publication No. 558074 D01 15.247 Meas Guidance v05r02
- ♦ FCC KDB 414788 D01 Radiated Test Site v01r01.
- ♦ FCC KDB 662911 D01 Multiple Transmitter Output v02r01.
- ♦ ANSI C63.10-2013

Remark:

1. All the test items were validated and recorded in accordance with the standards without any modification during the testing.
2. The TAF code is not including all the FCC KDB listed without accreditation.
3. This EUT has also been tested and complied with the requirements of FCC Part 15, Subpart B, recorded in a separate test report.



2 Test Configuration of Equipment Under Test

- a. The EUT has been associated with peripherals and configuration operated in a manner tended to maximize its emission characteristics in a typical application. Frequency range investigated: conduction emission (150 kHz to 30 MHz), radiation emission (9 kHz to the 10th harmonic of the highest fundamental frequency or to 40 GHz, whichever is lower). For radiated measurement, the measured emission level of the EUT was maximized by rotating the EUT on a turntable, adjusting the orientation of the EUT and EUT antenna in three orthogonal axis (X: flat, Y: portrait, Z: landscape), and adjusting the measurement antenna orientation, following C63.10 exploratory test procedures and only the worst case emissions were reported in this report..

- b. AC power line Conducted Emission was tested under maximum output power.

2.1 Carrier Frequency and Channel

Frequency Band	Channel	Freq. (MHz)	Channel	Freq. (MHz)
2400-2483.5 MHz	1	2412	7	2442
	2	2417	8	2447
	3	2422	9	2452
	4	2427	10	2457
	5	2432	11	2462
	6	2437		



2.2 Test Mode

This device support 26/52/106/242-tone RU.

The PSD of partial RU is reduced to be smaller than full RU according to TCB workshop interim guidance Oct. 2018.

The 802.11ax mode is investigated among different tones, full resource units (RU), partial resource units. The partial RU has no higher power than full RU's, thus the full RU is chosen as main test configuration.

The 242-tone RU is covered by 20MHz channel, 484-tone RU is covered by 40MHz channel
The SISO mode conducted power is covered by MIMO mode per chain, so only the MIMO mode is tested.

The SISO mode conducted power is covered by MIMO mode per chain, so only the MIMO mode is tested.

The power for 802.11n and 802.11ac mode is smaller than 802.11ax mode, so all other conducted and radiated test is covered by 802.11ax mode.

The final test modes include the worst data rates for each modulation shown in the table below.

CDD Mode

Modulation	Data Rate
802.11b	1 Mbps
802.11g	6 Mbps
802.11n HT20 (Covered by HE20)	MCS0
802.11n HT40 (Covered by HE40)	MCS0
802.11ac VHT20 (Covered by HE20)	MCS0
802.11ac VHT40 (Covered by HE40)	MCS0
802.11ax HE20	MCS0
802.11ax HE40	MCS0

TXBF Mode

Modulation	Data Rate
802.11ax HE20	MCS0
802.11ax HE40	MCS0



Test Cases	
AC Conducted Emission	Mode 1 : WCDMA Band V Link+ Bluetooth Link + WLAN (2.4GHz) Link + GPS Rx + USB TYPE-A to TYPE-C cable (Charging from AC Adapter) + Battery 1X for Sample 1
Remark: For Radiated Test Cases, the tests were performed with Battery 1X and Sample 1	

<CDD Mode>

<Sample 1>

Ch. #	2400-2483.5 MHz			
	802.11b	802.11g	802.11ax HE20	802.11ax HE40
Low	01	01	01	03
Middle	06	06	06	06
High	11	11	11	09

<Sample 2>

Ch. #	2400-2483.5 MHz			
	802.11ax HE20			
Low	-			
Middle	-			
High	11			

<TXBF Mode>

<Sample 1>

Ch. #	2400-2483.5 MHz	
	802.11ax HE20	802.11ax HE40
Low	01	03
Middle	06	06
High	11	09

Remark: For radiation spurious emission, the modulation and the data rate picked for testing are determined by the Max. RF conducted power.

2.3 Connection Diagram of Test System

<AC Conducted Emission Mode>

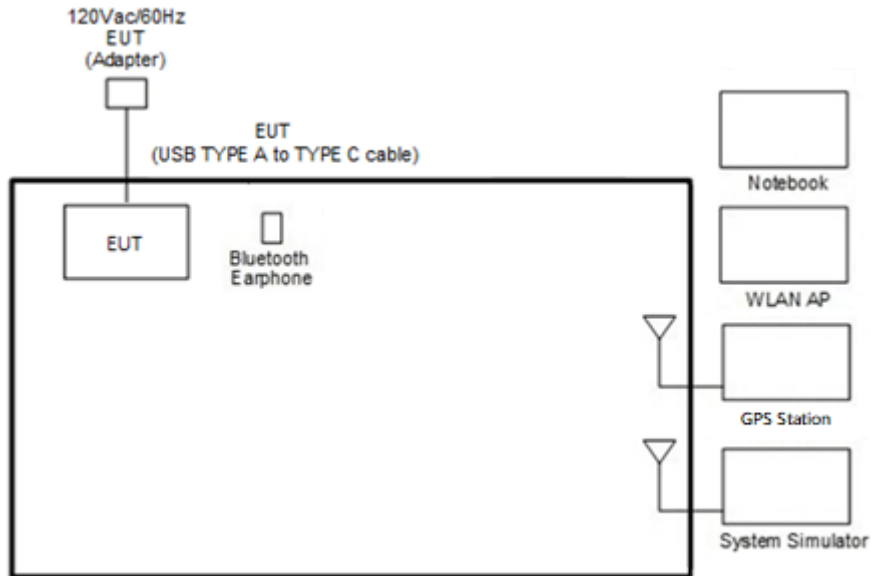

<WLAN Tx Mode>

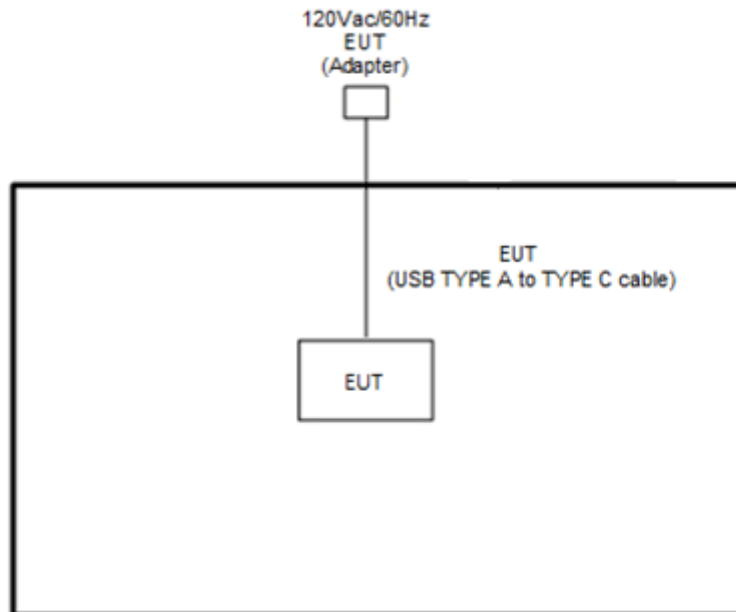

2.4 Support Unit used in test configuration and system

Item	Equipment	Brand Name	Model Name	FCC ID	Data Cable	Power Cord
1.	System Simulator	Anritsu	MT8820C	N/A	N/A	Unshielded, 1.8 m
2.	Bluetooth Earphone	Sony Ericsson	MW600	PY7DDA-2029	N/A	N/A
3.	WLAN AP	ASUS	RT-AC66U	MSQ-RTAC66U	N/A	Unshielded, 1.8 m
4.	Notebook	DELL	Latitude 3420	FCC DoC	N/A	AC I/P: Unshielded, 1.2 m DC O/P: Shielded, 1.8 m
5.	Bluetooth Earphone	Sony	SBH20	PY7-RD0010	N/A	N/A
6.	GPS Station	Pendulum	GSG-54	N/A	N/A	Unshielded, 1.8 m

2.5 EUT Operation Test Setup

The RF test items, utility “QRCT 4.0.00197.0” was installed in Notebook which was programmed in order to make the EUT get into the engineering modes to provide channel selection, power level, data rate and the application type and for continuous transmitting signals.

For TXBF mode, the modulation modes and data rates manipulated by the command lines in the engineering program made the EUT link to another EUT by power under the normal operation. The “iperf-3.1.3-win64 / Command v10.0.17134.1304” software tool was used to enable the EUT to transmit signals continuously.

2.6 Measurement Results Explanation Example

For all conducted test items:

The offset level is set in the spectrum analyzer to compensate the RF cable loss and attenuator factor between EUT conducted output port and spectrum analyzer. With the offset compensation, the spectrum analyzer reading level is exactly the EUT RF output level.

Example:

The spectrum analyzer offset is derived from RF cable loss and attenuator factor.

Offset = RF cable loss + attenuator factor.

Following shows an offset computation example with cable loss 4.2 dB and 10 dB attenuator.

Offset(dB) = RF cable loss(dB) + attenuator factor(dB).

= 4.2 + 10 = 14.2 (dB)

3 Test Result

3.1 6dB and 99% Bandwidth Measurement

3.1.1 Limit of 6dB and 99% Bandwidth

The minimum 6 dB bandwidth shall be at least 500 kHz.

3.1.2 Measuring Instruments

Please refer to the measuring equipment list in this test report.

3.1.3 Test Procedures

1. The testing follows the ANSI C63.10 Section 6.9.3 (OBW) and 11.8.1 (6dB BW).
2. The RF output of EUT is connected to the spectrum analyzer by RF cable and attenuator. The path loss is compensated to the results for each measurement.
3. Set the maximum power setting and enable the EUT to transmit continuously.
4. Make the measurement with the spectrum analyzer's resolution bandwidth (RBW) = 100 kHz. Set the Video bandwidth (VBW) = 300 kHz. In order to make an accurate measurement. The 6 dB bandwidth must be greater than 500 kHz.
5. For 99% Bandwidth Measurement, the spectrum analyzer's resolution bandwidth (RBW) is set 1-5% of the emission bandwidth and set the Video bandwidth (VBW) $\geq 3 * RBW$.
6. Measure and record the results in the test report.

3.1.4 Test Setup

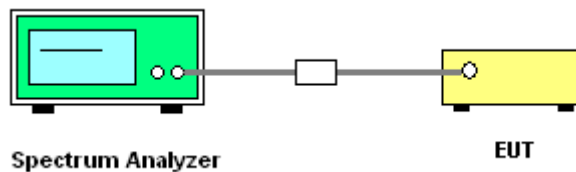



3.1.5 Test Result of 6dB and 99% Occupied Bandwidth

Please refer to Appendix A.

<CDD Mode>

MIMO <Ant. 9+8>

<802.11b>

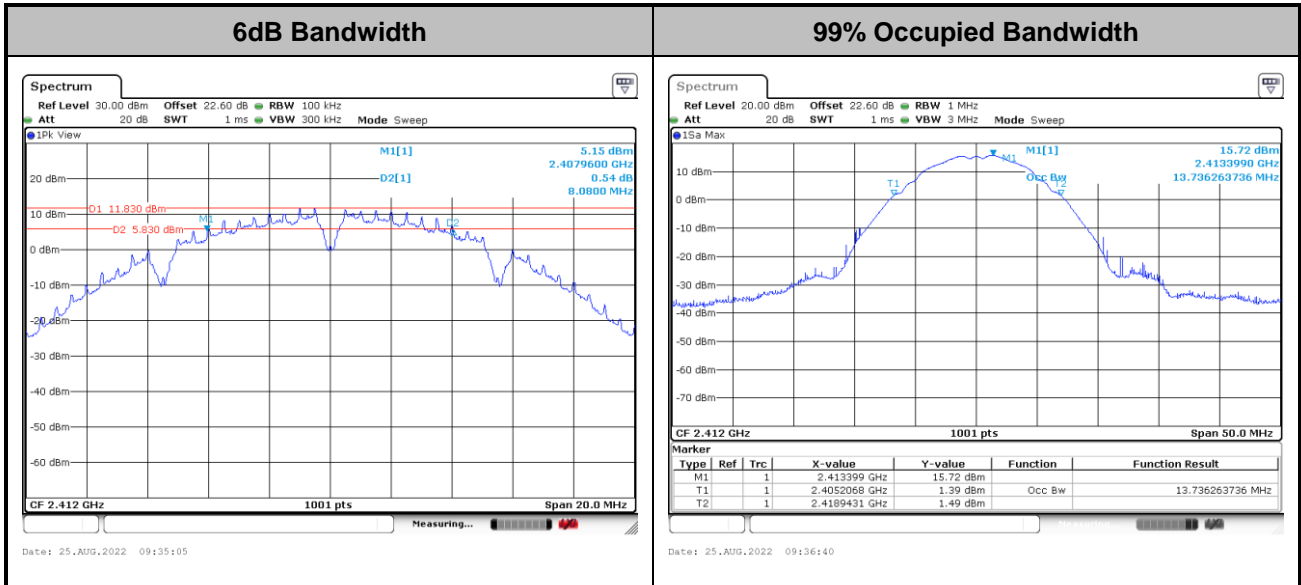

Note: The occupied channel bandwidth is maintained within the band of operation for all of the modulations.

<802.11g>

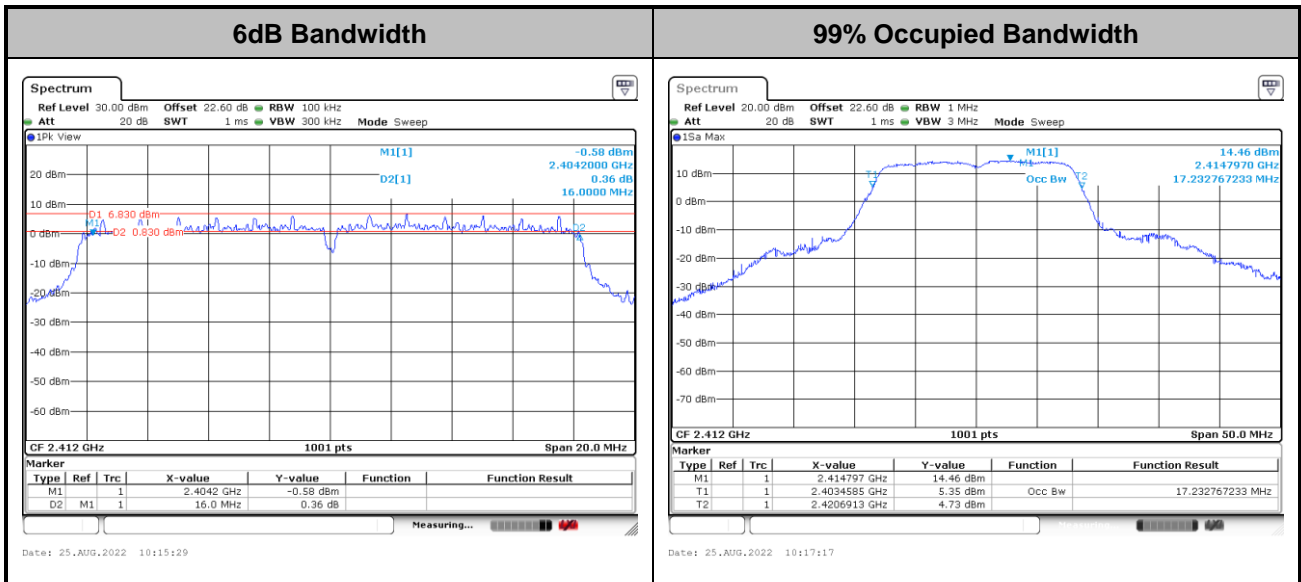

Note: The occupied channel bandwidth is maintained within the band of operation for all of the modulations.



<802.11ax HE20>

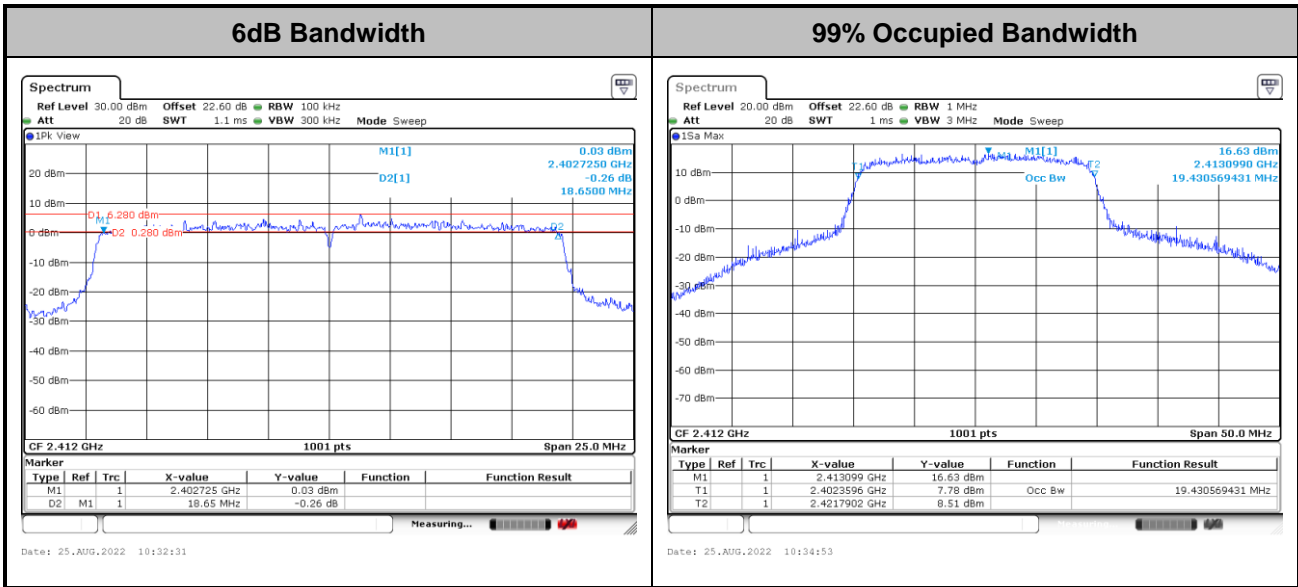

Note: The occupied channel bandwidth is maintained within the band of operation for all of the modulations.

<802.11ax HE40>

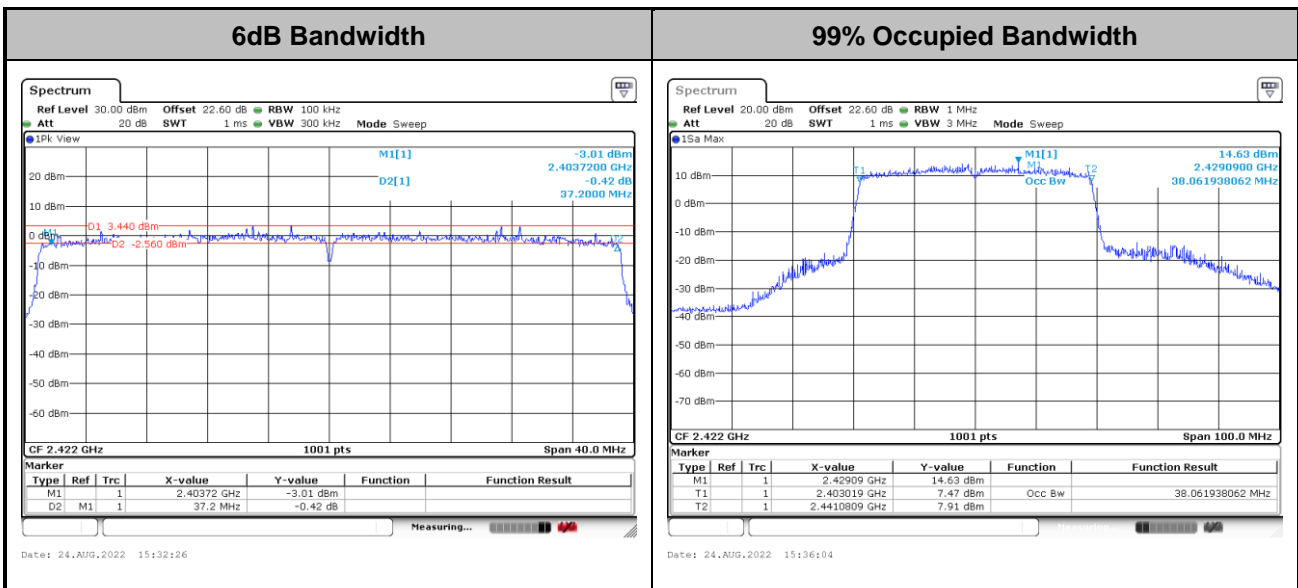

Note: The occupied channel bandwidth is maintained within the band of operation for all of the modulations.



<TXBF Modes>

MIMO <Ant. 9+8>

<802.11ax HE20>

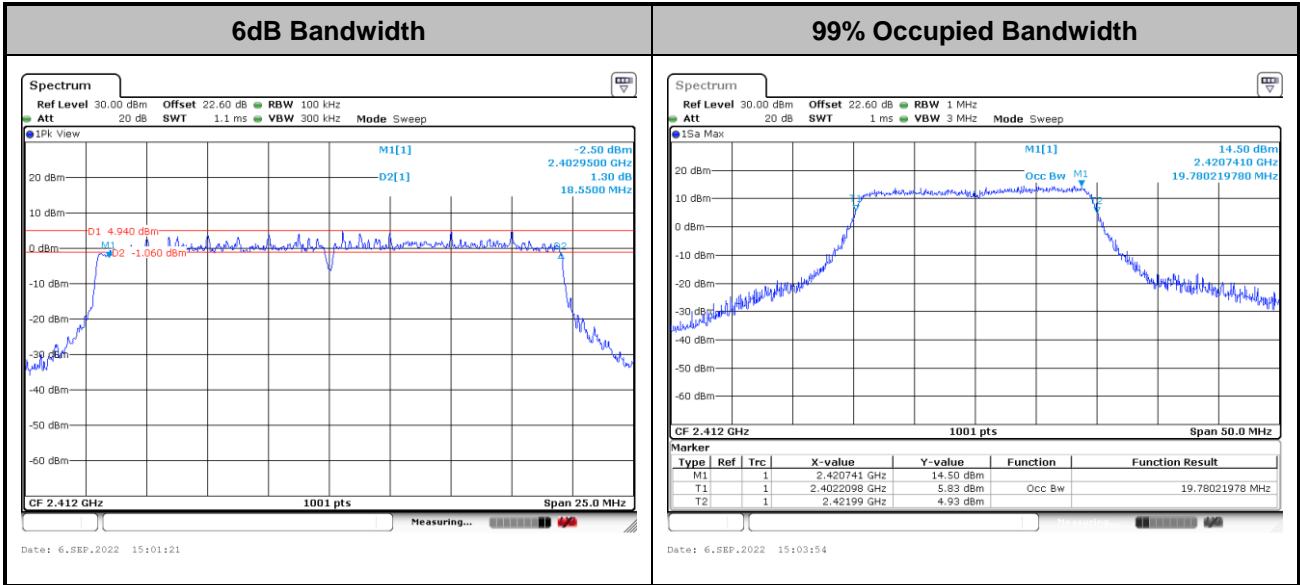

Note: The occupied channel bandwidth is maintained within the band of operation for all of the modulations.

<802.11ax HE40>

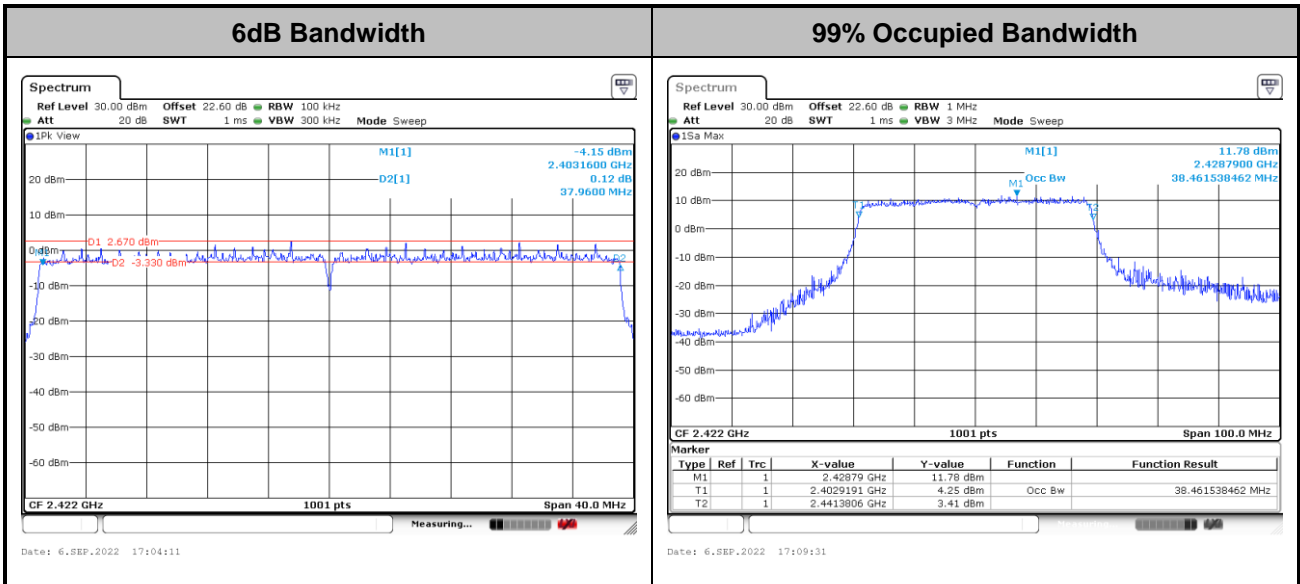

Note: The occupied channel bandwidth is maintained within the band of operation for all of the modulations.



3.2 Output Power Measurement

3.2.1 Limit of Output Power

For systems using digital modulation in the 2400-2483.5 MHz, the limit for output power is 30 dBm. If transmitting antenna with directional gain greater than 6 dBi is used, the output power from the intentional radiator shall be reduced below the above stated value by the amount in dB that the directional gain of the antenna exceeds 6 dBi. In case of point-to-point operation, the limit has to be reduced by 1 dB for every 3 dB that the directional gain of the antenna exceeds 6 dBi.

3.2.2 Measuring Instruments

Please refer to the measuring equipment list in this test report.

3.2.3 Test Procedures

<CDD Modes>

1. For Average Power, the testing follows ANSI C63.10 Section 11.9.2.3.2 Method AVGPM-G
2. The RF output of EUT is connected to the power meter by RF cable and attenuator. The path loss is compensated to the results for each measurement.
3. Set the maximum power setting and enable the EUT to transmit continuously.
4. Measure the conducted output power and record the results in the test report.
5. For MIMO mode, calculation method follows FCC KDB 662911 D01 Multiple Transmitter Output v02r01.

<TXBF Modes>

1. For Average Power, the testing follows ANSI C63.10 Section 11.9.2.3.2 Method AVGPM-G
2. The RF output of EUT is connected to the power meter by RF cable and attenuator. The path loss is compensated to the results for each measurement.
3. Set the maximum power setting and enable the EUT to transmit continuously.
4. Measure the conducted output power and record the results in the test report.
5. For MIMO mode, calculation method follows FCC KDB 662911 D01 Multiple Transmitter Output v02r01.

3.2.4 Test Setup

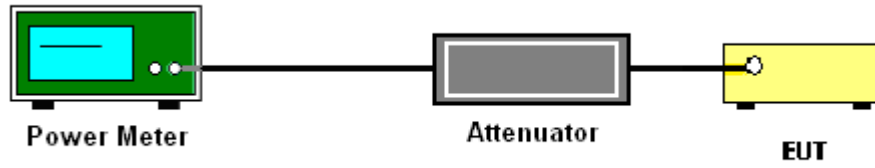

3.2.5 Test Result of Average Output Power

Please refer to Appendix A.

3.3 Power Spectral Density Measurement

3.3.1 Limit of Power Spectral Density

The peak power spectral density shall not be greater than 8 dBm in any 3 kHz band at any time interval of continuous transmission.

3.3.2 Measuring Instruments

Please refer to the measuring equipment list in this test report.

3.3.3 Test Procedures

1. The testing follows the ANSI C63.10 Section 11.10.2 Method PKPSD.
2. The RF output of EUT is connected to the spectrum analyzer by RF cable and attenuator. The path loss is compensated to the results for each measurement.
3. Set the maximum power setting and enable the EUT to transmit continuously.
4. Make the measurement with the spectrum analyzer's resolution bandwidth (RBW) = 3 kHz. Video bandwidth VBW = 10 kHz In order to make an accurate measurement, set the span to 1.5 times DTS Channel Bandwidth. (6dB BW)
5. Detector = peak, Sweep time = auto couple, Trace mode = max hold, Allow trace to fully stabilize. Use the peak marker function to determine the maximum power level.
6. Measure and record the results in the test report.
7. For MIMO mode, calculation method follows FCC KDB 662911 D01 Multiple Transmitter Output v02r01.

Method (c): Measure and add $10 \log(N_{ANT})$ dB.

With this technique, spectrum measurements are performed at each output of the device, but rather than summing the spectra or the spectral peaks across the outputs, the quantity $10 \log(N_{ANT})$ dB is added to each spectrum value before comparing to the emission limit. The addition of $10 \log(N_{ANT})$ dB serves to apportion the emission limit among the N_{ANT} outputs so that each output is permitted to contribute no more than $1/N_{ANT}^{th}$ of the PSD limit .

3.3.4 Test Setup

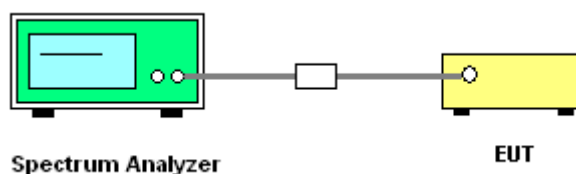



3.3.5 Test Result of Power Spectral Density

Please refer to Appendix A.

<CDD Modes>

<802.11b>

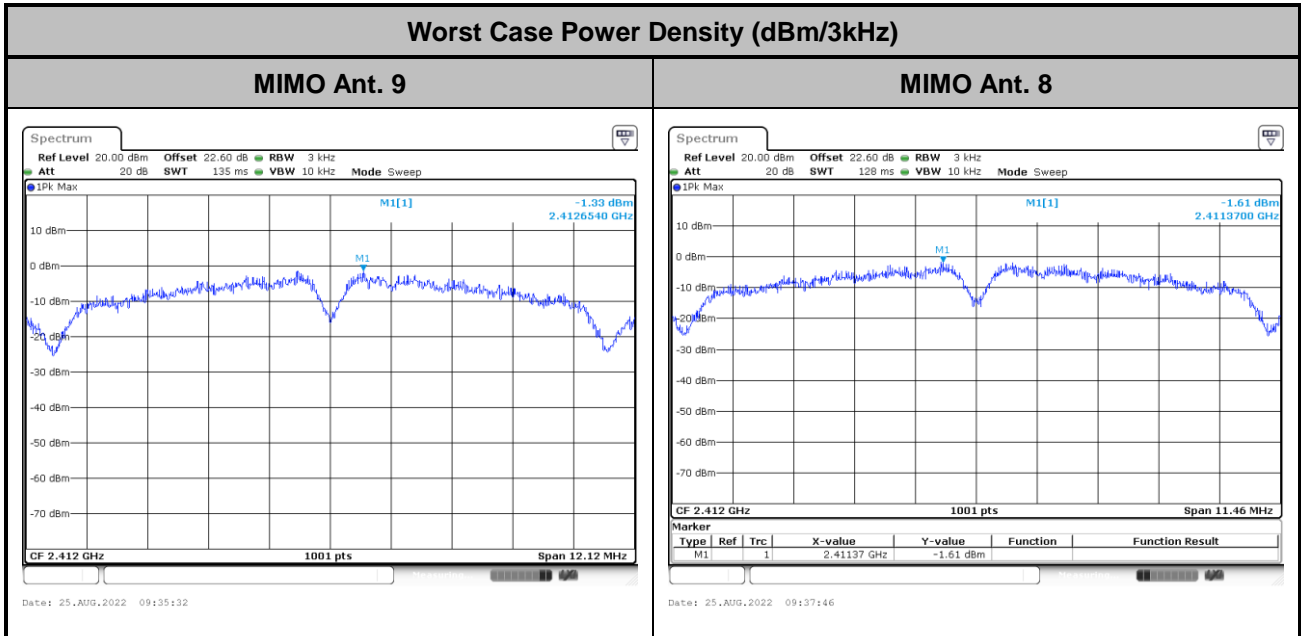

<802.11g>

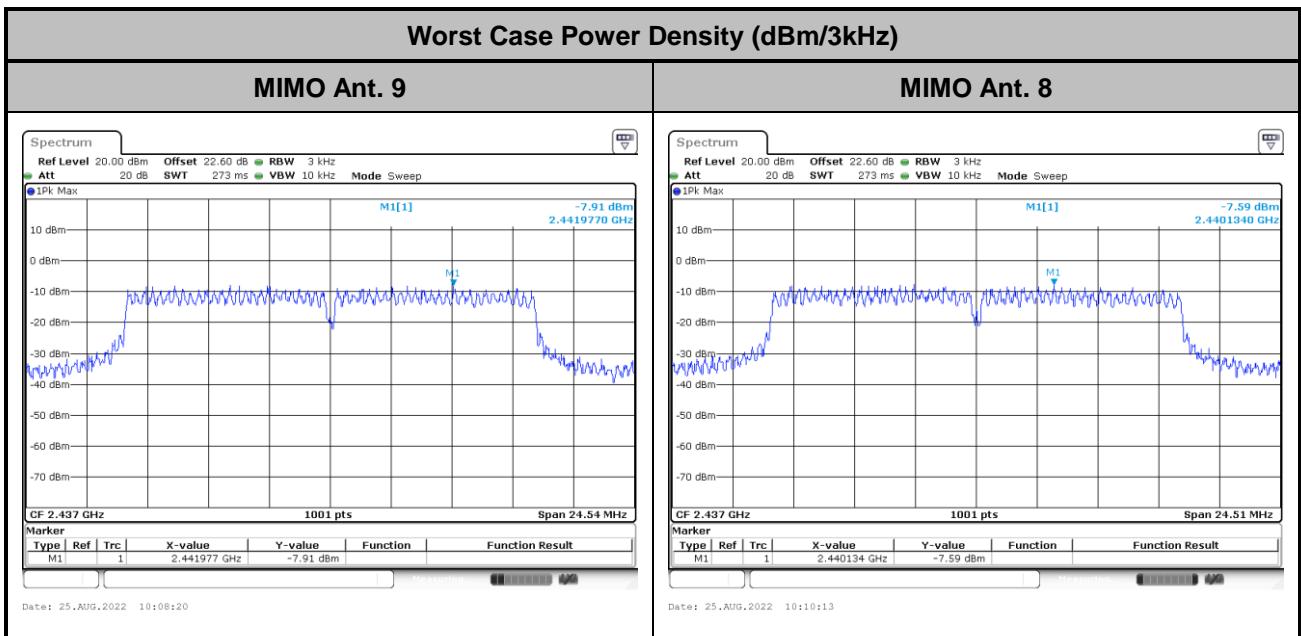



<802.11ax HE20>

Worst Case Power Density (dBm/3kHz)

MIMO Ant. 9

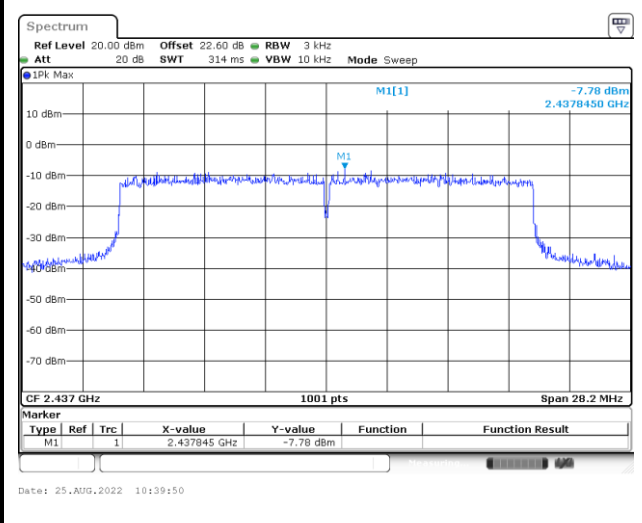

MIMO Ant. 8

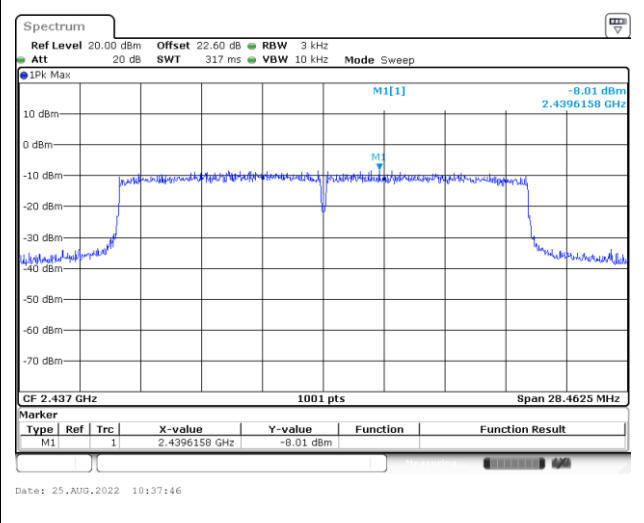

<802.11ax HE40>

Worst Case Power Density (dBm/3kHz)

MIMO Ant. 9

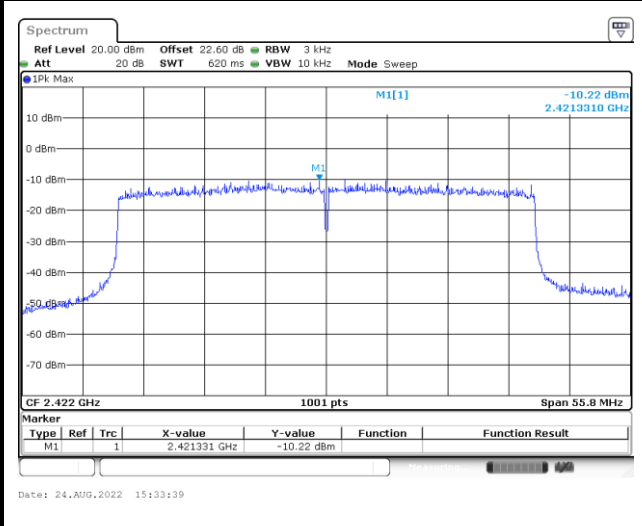

MIMO Ant. 8

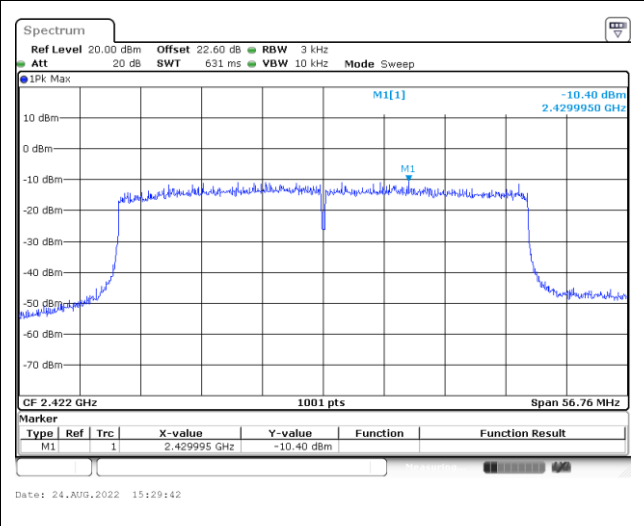



<TXBF Modes>

<802.11ax HE20>

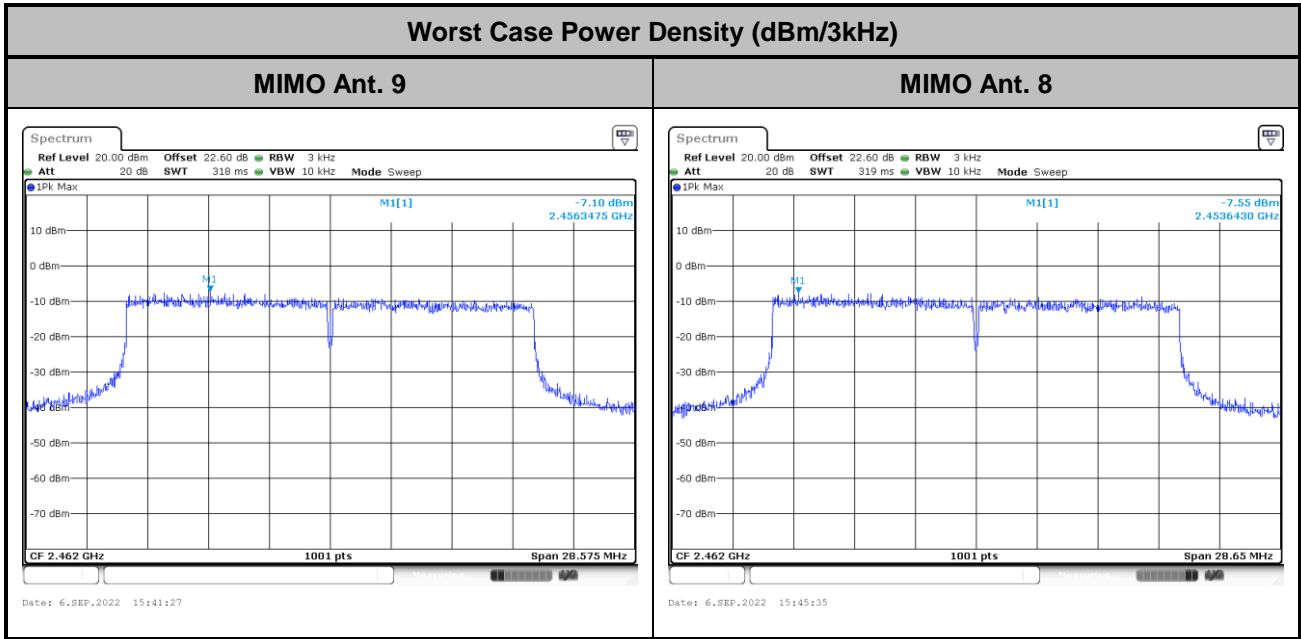

<802.11ax HE40>

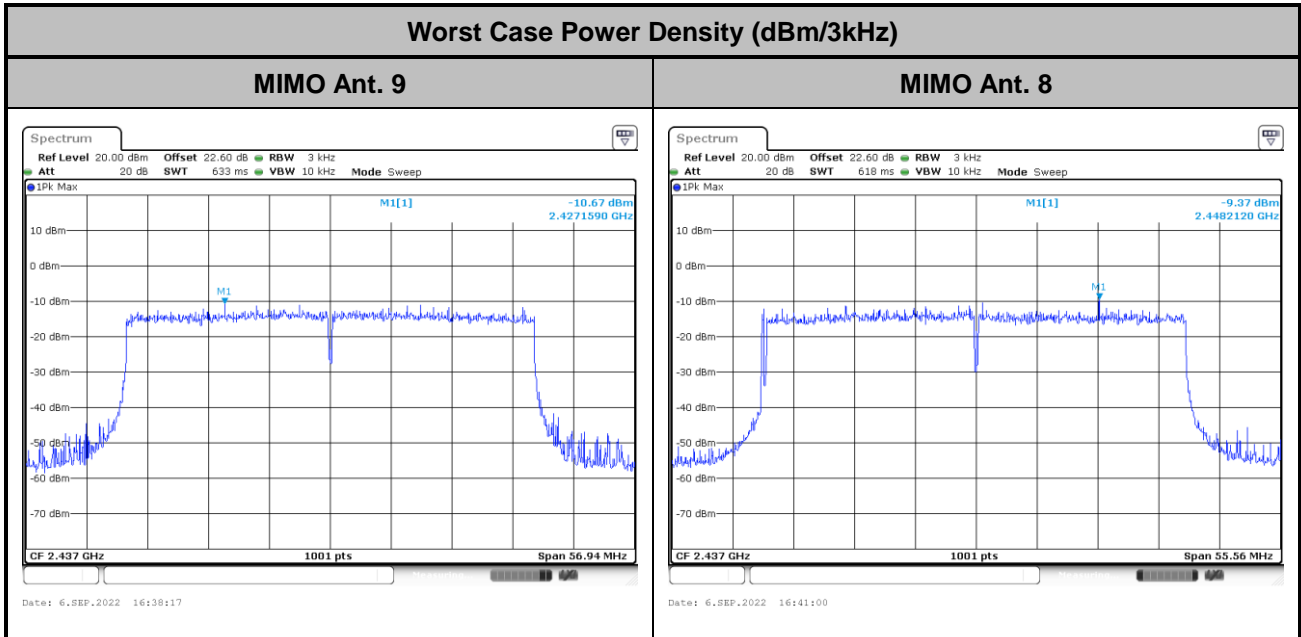

3.4 Conducted Band Edges and Spurious Emission Measurement

3.4.1 Limit of Conducted Band Edges and Spurious Emission Measurement

In any 100 kHz bandwidth outside of the authorized frequency band, the emissions which fall in the non-restricted bands shall be attenuated at least 20 dB / 30dB relative to the maximum PSD level in 100 kHz by RF conducted measurement.

3.4.2 Measuring Instruments

Please refer to the measuring equipment list in this test report.

3.4.3 Test Procedures

1. The testing follows the ANSI C63.10 Section 11.11.3 Emission level measurement
2. The RF output of EUT is connected to the spectrum analyzer by RF cable and attenuator. The path loss is compensated to the results for each measurement.
3. Set the maximum power setting and enable the EUT to transmit continuously.
4. Set RBW = 100 kHz, VBW = 300 kHz, Peak Detector. Unwanted Emissions measured in any 100 kHz bandwidth outside of the authorized frequency band shall be attenuated by at least 20 dB relative to the maximum in-band peak PSD level in 100 kHz when maximum peak conducted output power procedure is used. If the transmitter complies with the conducted power limits based on the use of RMS averaging over a time interval, the attenuation required under this paragraph shall be 30 dB instead of 20 dB per 15.247(d).
5. Measure and record the results in the test report.
6. The RF fundamental frequency should be excluded against the limit line in the operating frequency band.

3.4.4 Test Setup

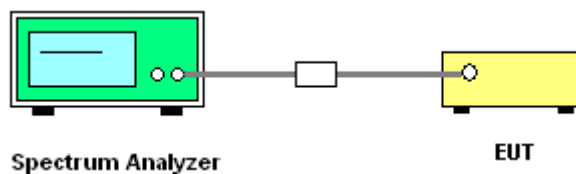



3.4.5 Test Result of Conducted Band Edges and Spurious Emission

<CDD Modes>

Number of TX = 2, Ant. 9 (Measured)

Test Mode :	802.11b	Test Channel :	01
-------------	---------	----------------	----

100kHz PSD reference Level	Low Channel Plot
----------------------------	------------------

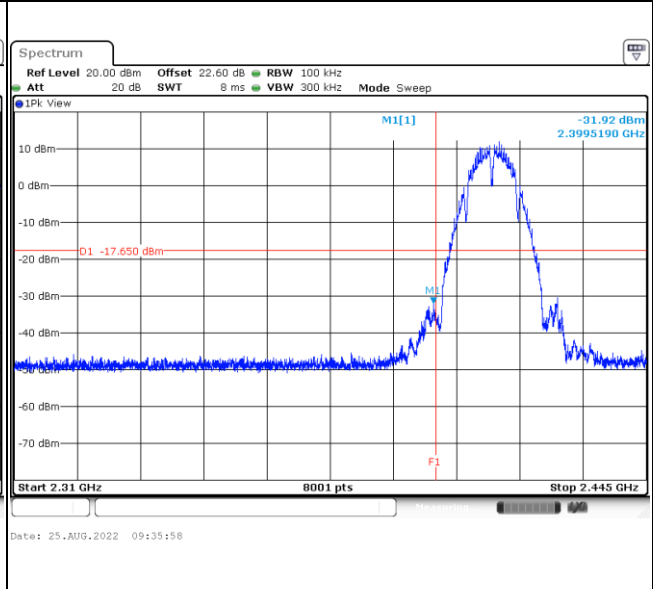
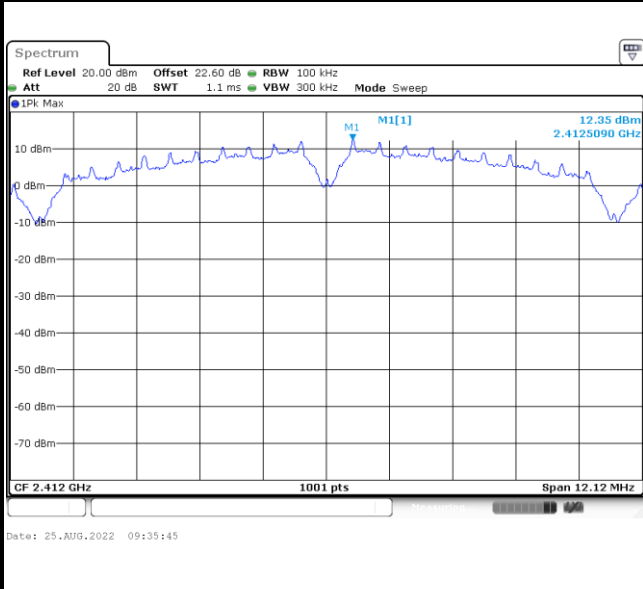

Spurious Emission 30MHz~3GHz	Spurious Emission 2GHz~25GHz
------------------------------	------------------------------

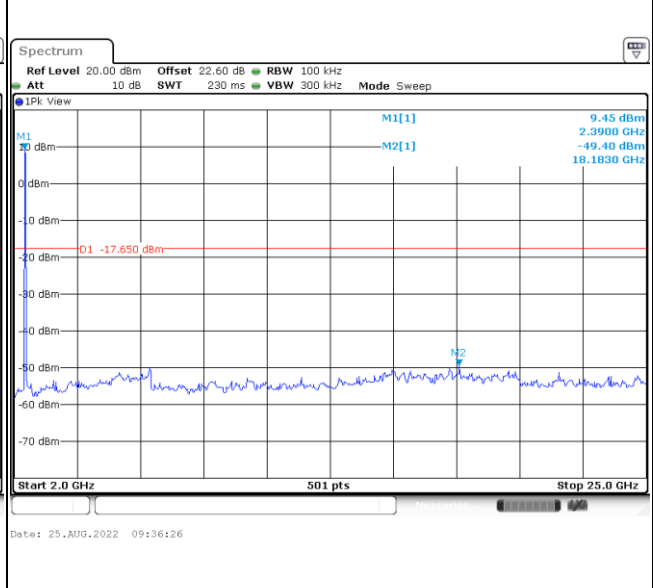
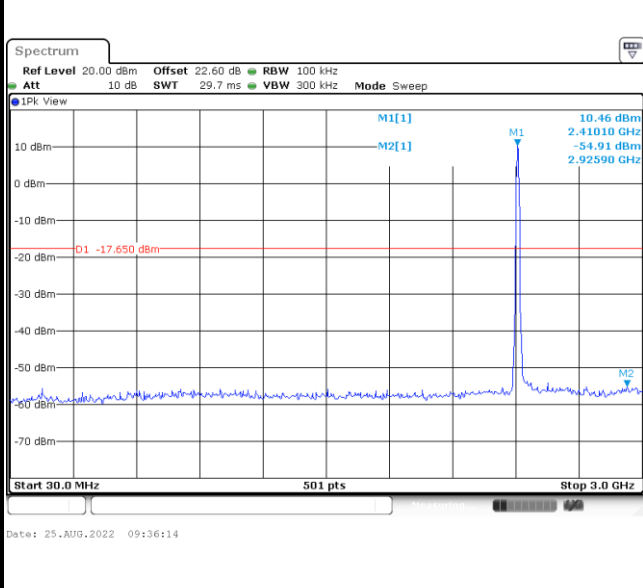



Test Mode :	802.11b	Test Channel :	06
-------------	---------	----------------	----

100kHz PSD reference Level	Mid Channel Plot
-----------------------------------	-------------------------

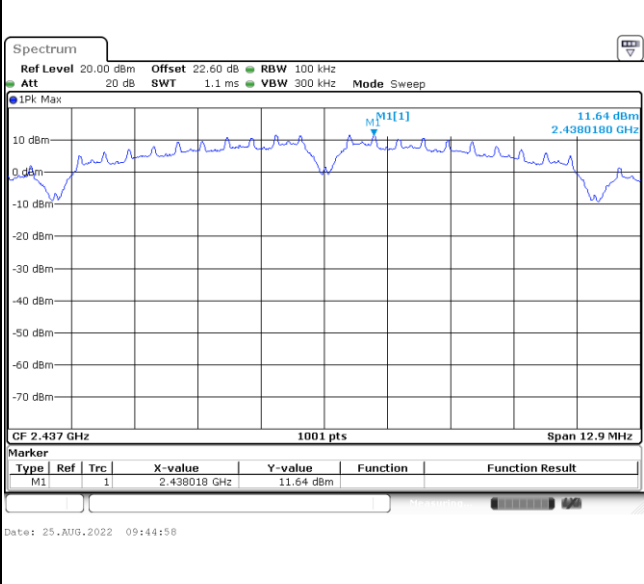

Spurious Emission 30MHz~3GHz

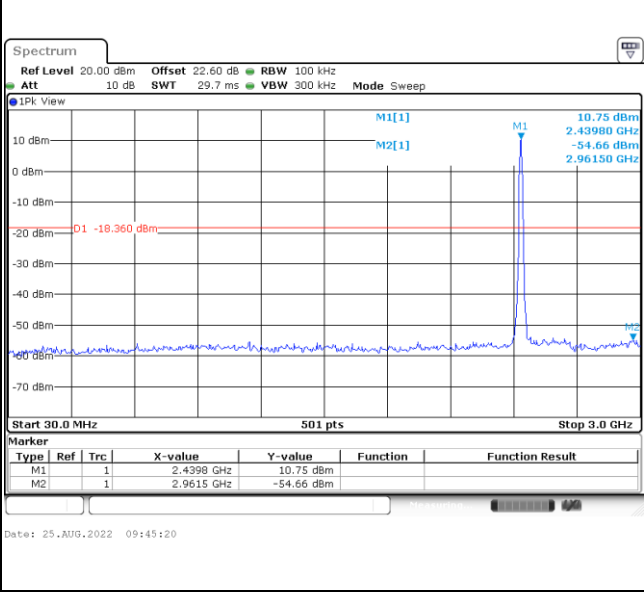

Spurious Emission 2GHz~25GHz

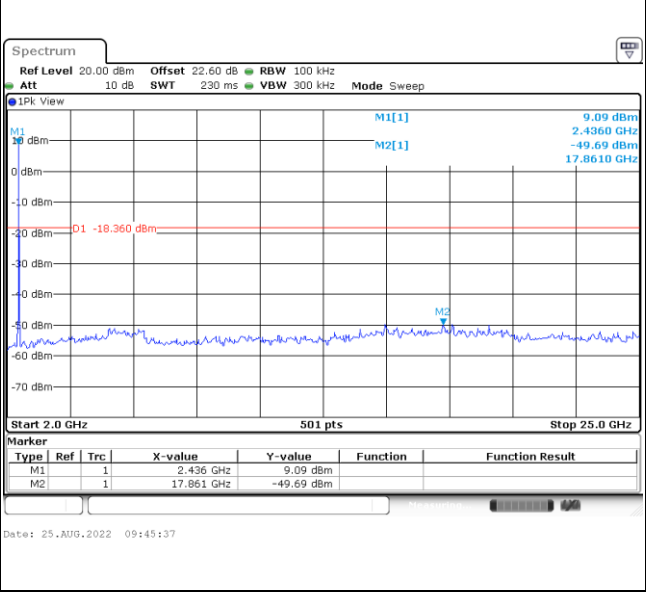



Test Mode :	802.11b	Test Channel :	11
-------------	---------	----------------	----

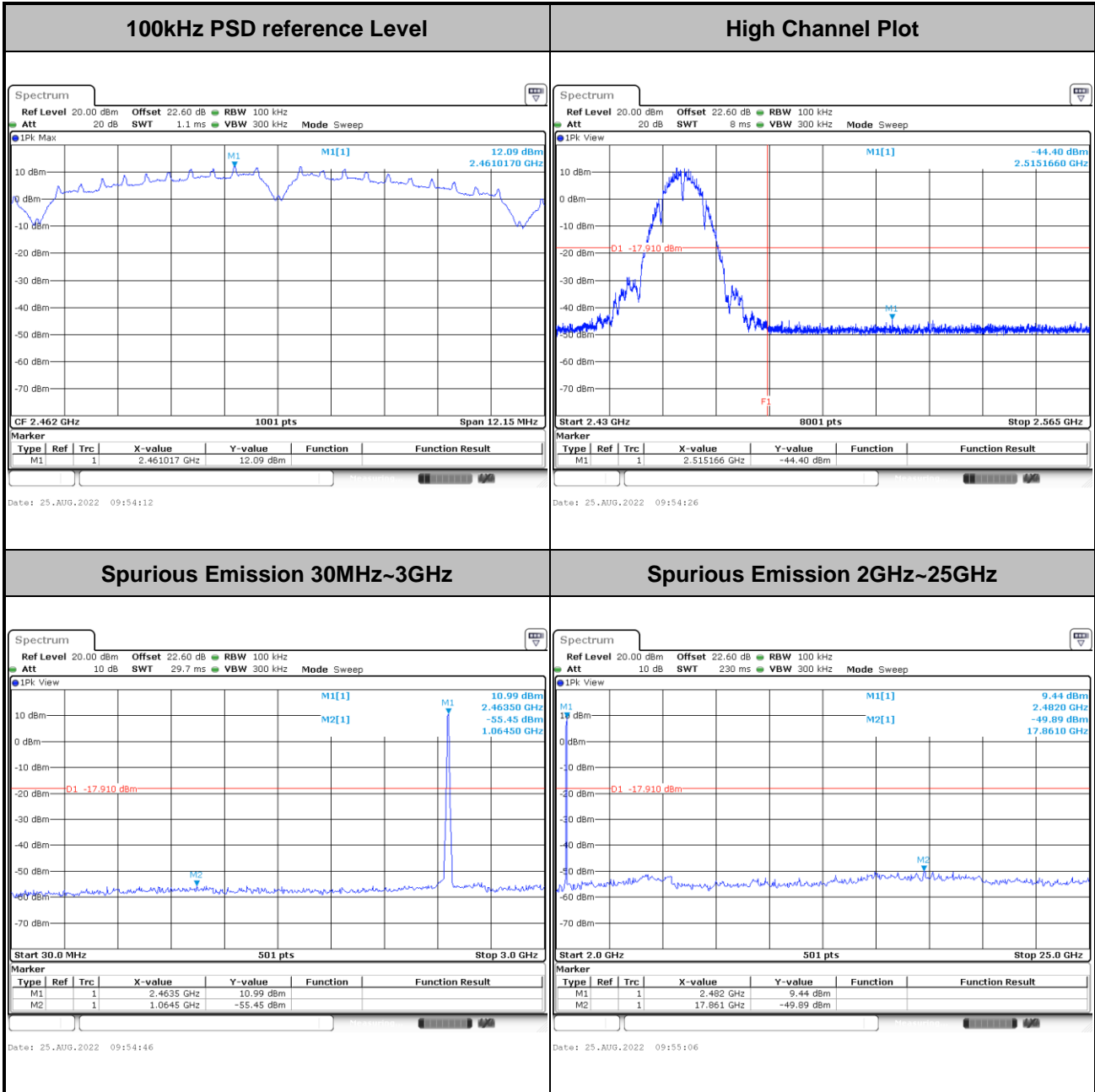



Test Mode :	802.11g	Test Channel :	01
-------------	---------	----------------	----

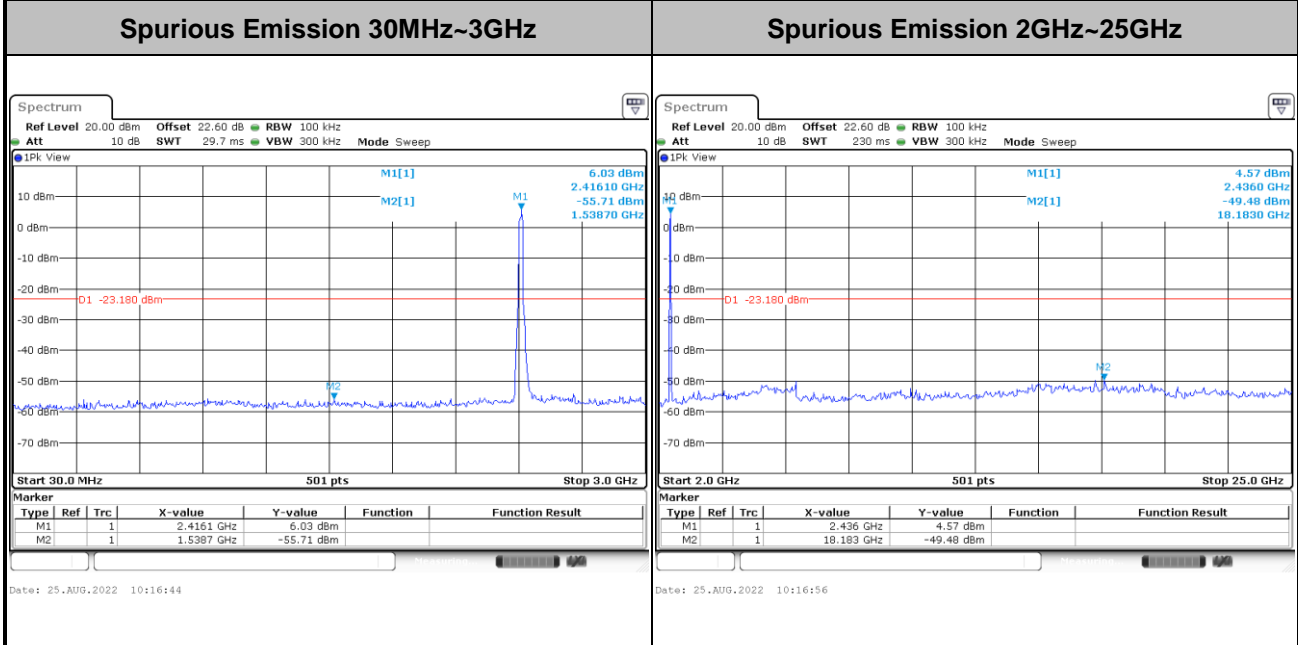
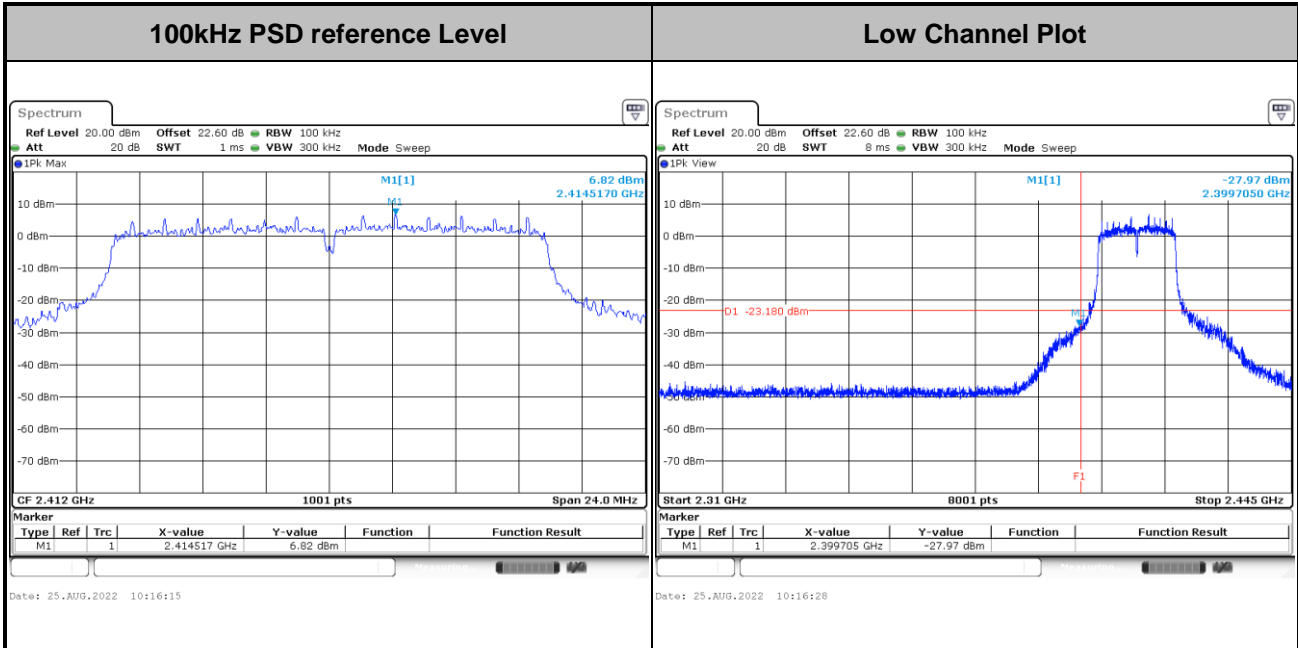



Test Mode :	802.11g	Test Channel :	06
-------------	---------	----------------	----

100kHz PSD reference Level	Mid Channel Plot
-----------------------------------	-------------------------

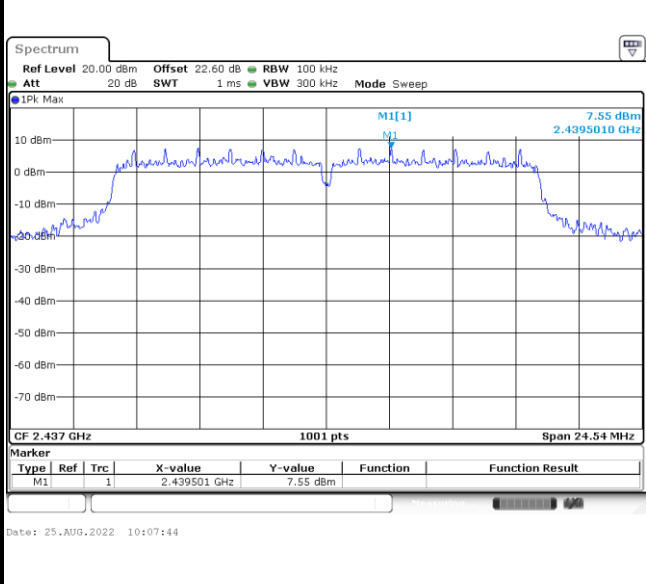

Spurious Emission 30MHz~3GHz

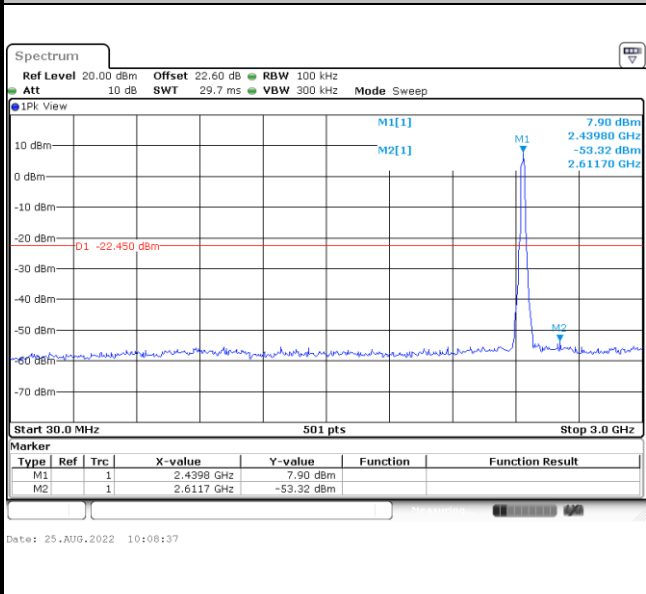

Spurious Emission 2GHz~25GHz

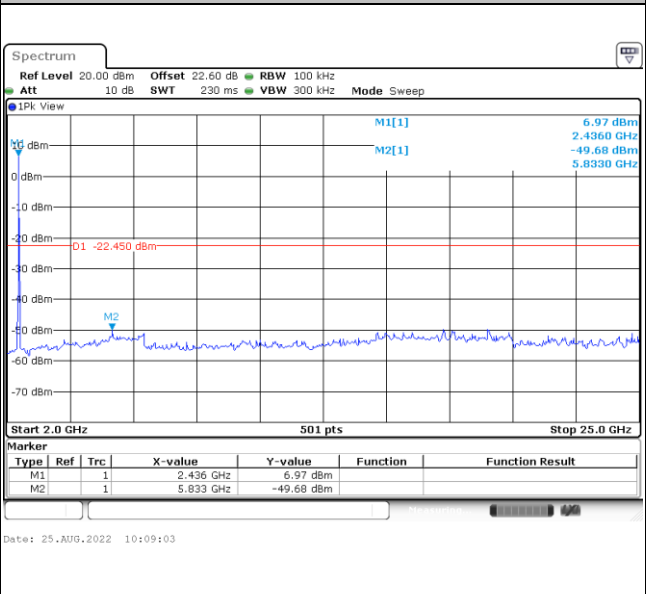



Test Mode :	802.11g	Test Channel :	11
-------------	---------	----------------	----

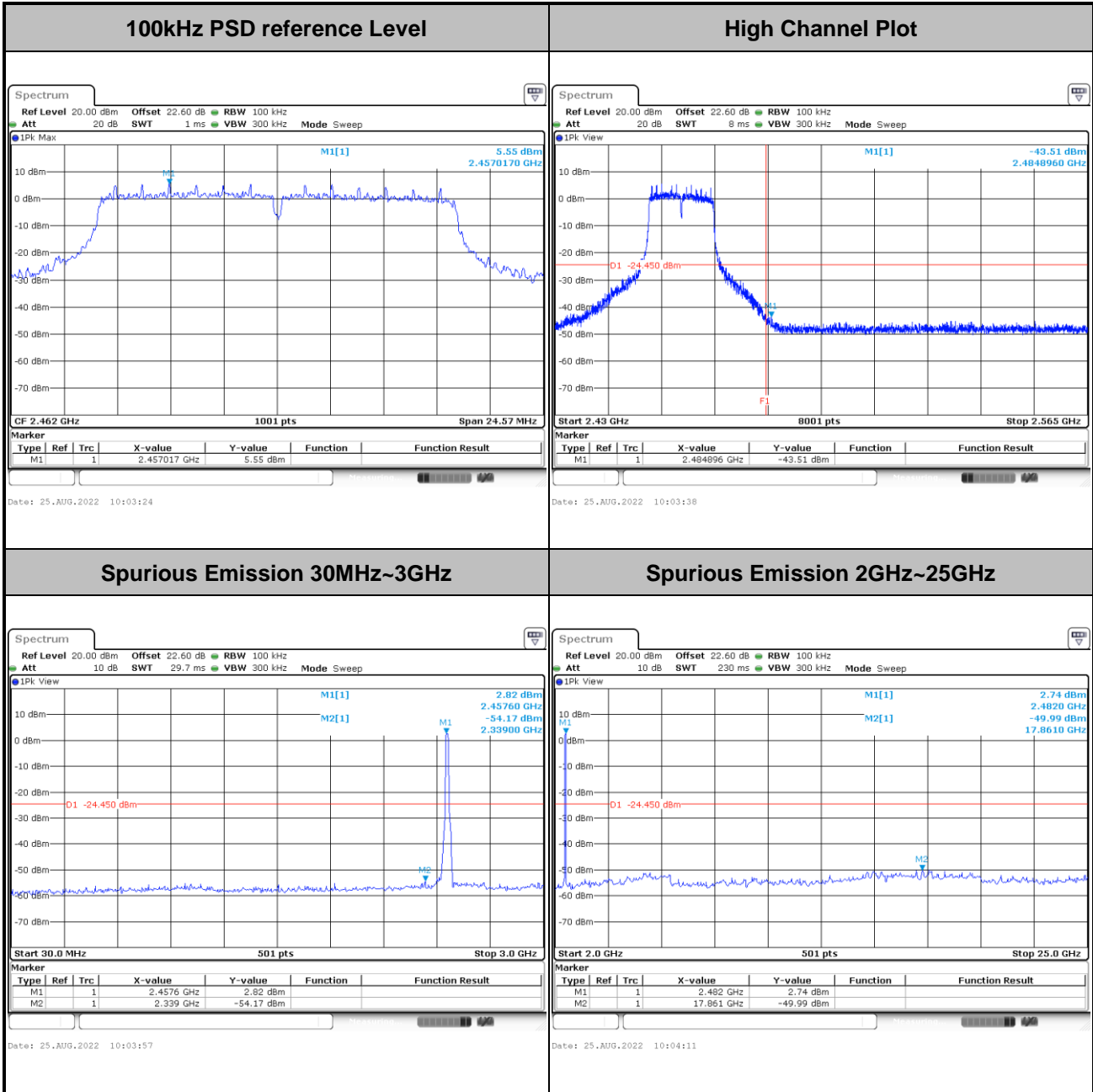



Test Mode :	802.11ax HE20	Test Channel :	01 Full RU
-------------	---------------	----------------	------------

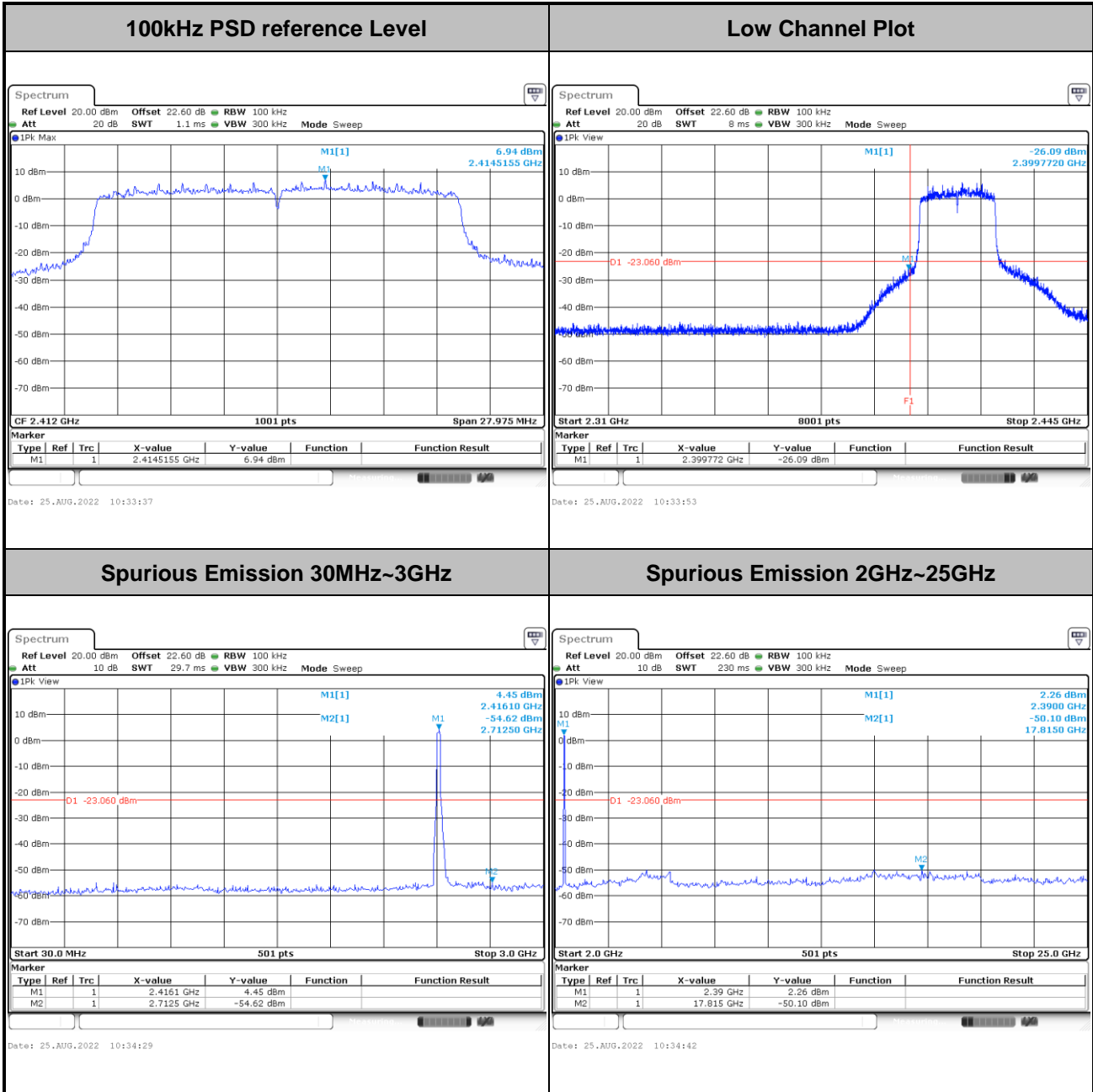



Test Mode :	802.11ax HE20	Test Channel :	06 Full RU
-------------	---------------	----------------	------------

100kHz PSD reference Level	Mid Channel Plot
-----------------------------------	-------------------------

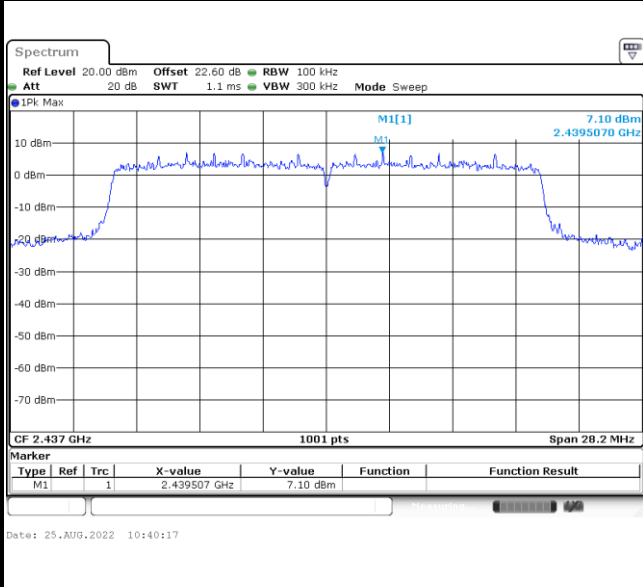

Spurious Emission 30MHz~3GHz

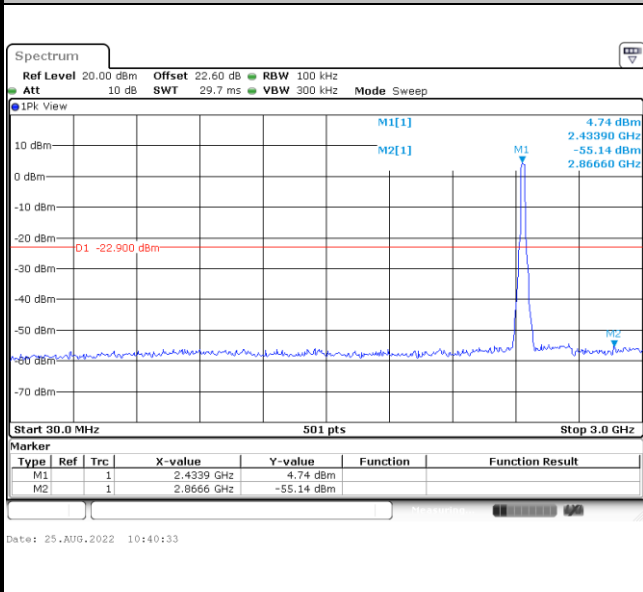

Spurious Emission 2GHz~25GHz

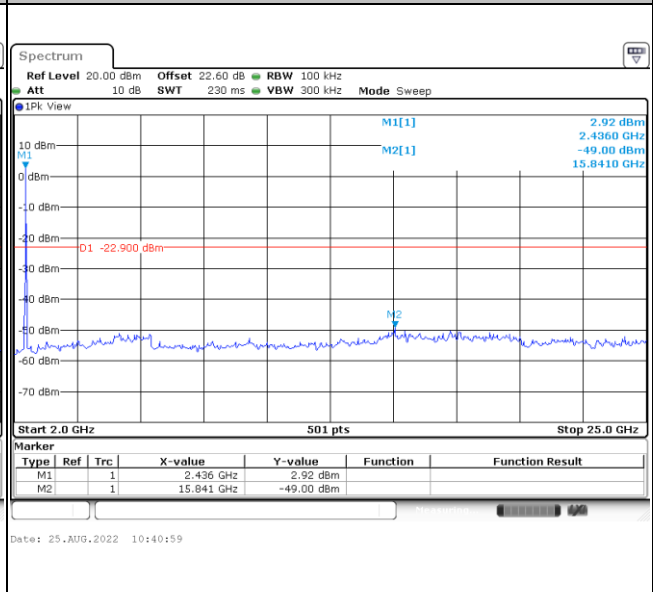



Test Mode :	802.11ax HE20	Test Channel :	11 Full RU
-------------	---------------	----------------	------------

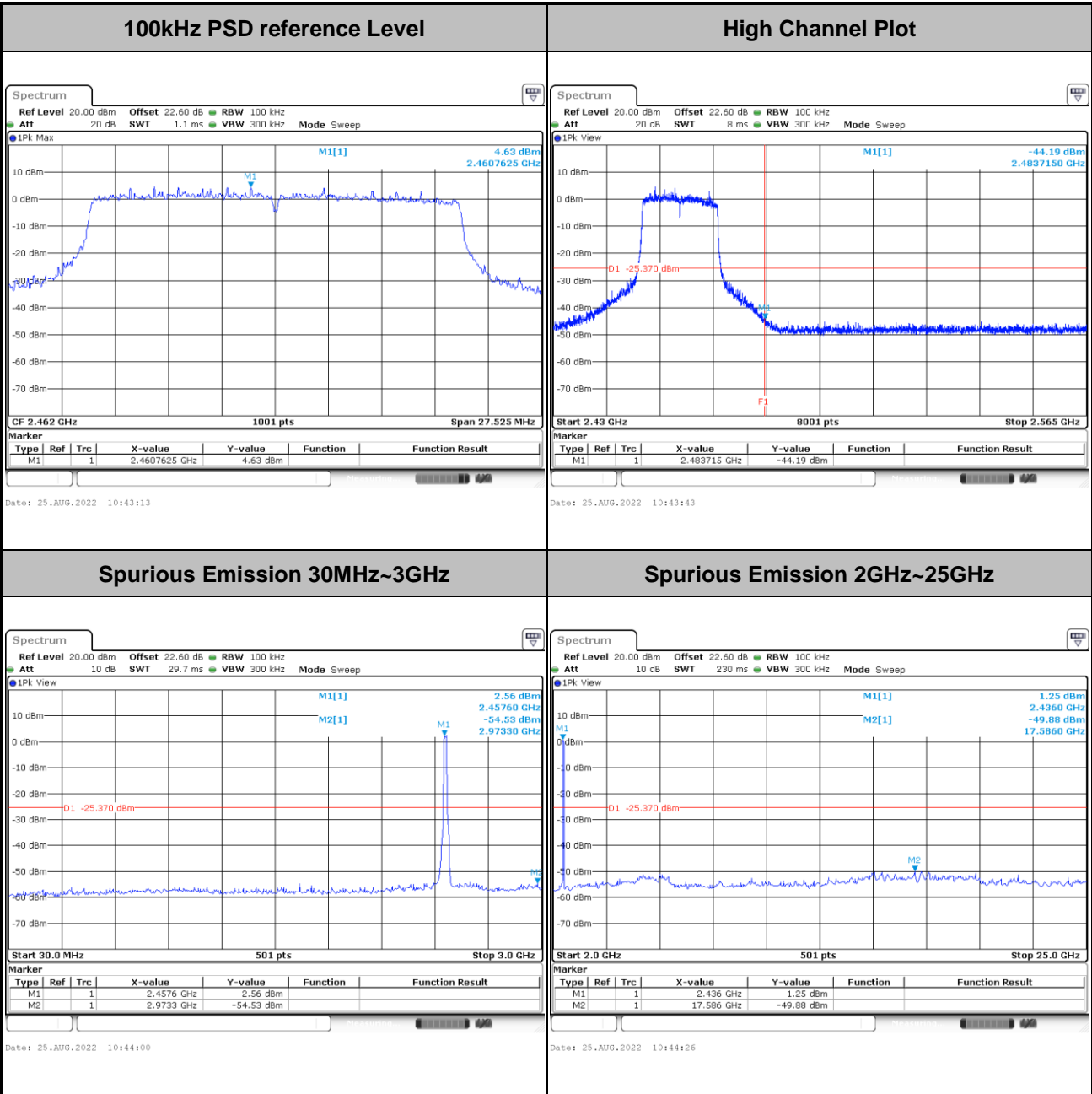



Test Mode :	802.11ax HE40	Test Channel :	03 Full RU
-------------	---------------	----------------	------------

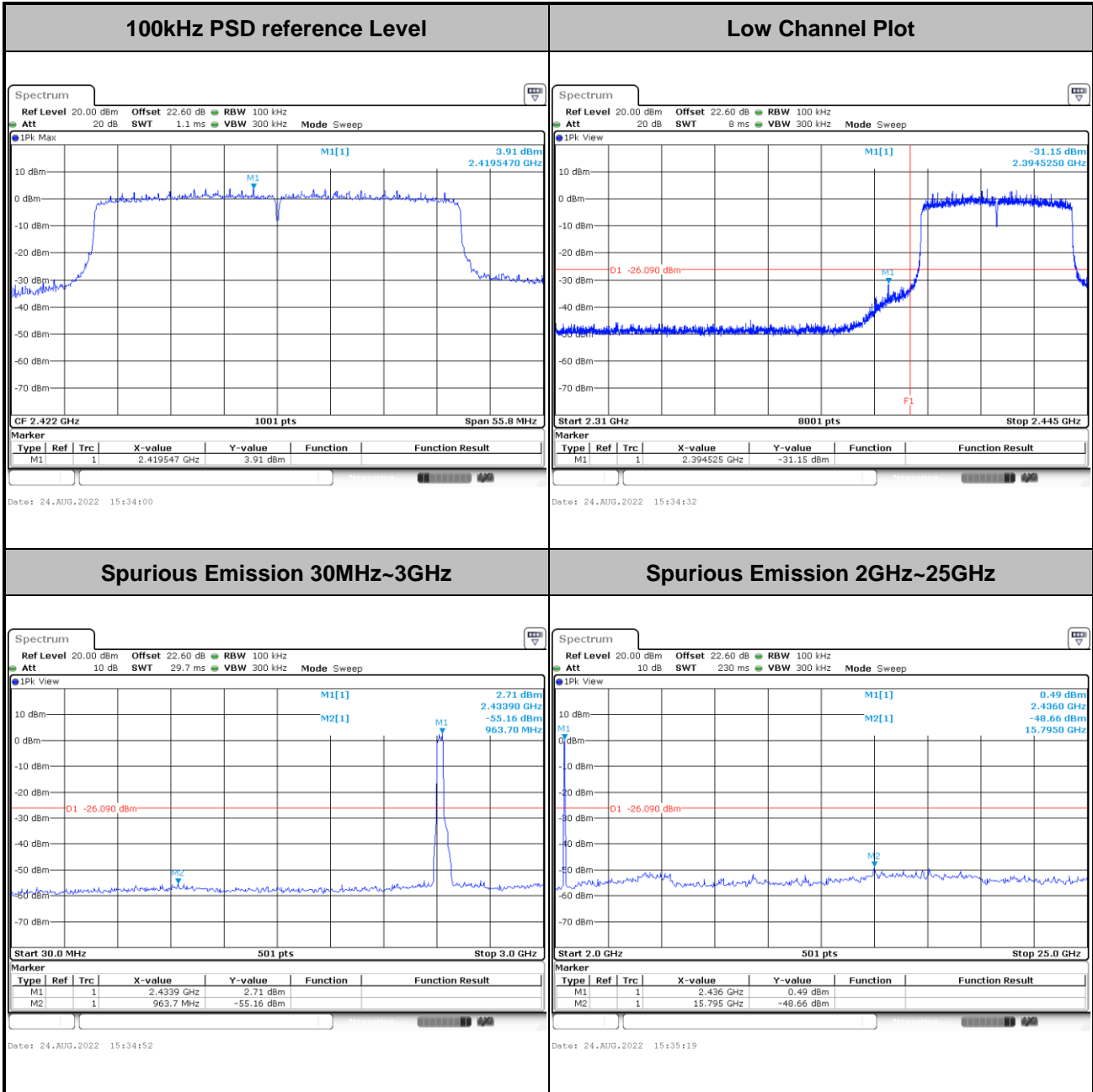



Test Mode :	802.11ax HE40	Test Channel :	06 Full RU
-------------	---------------	----------------	------------

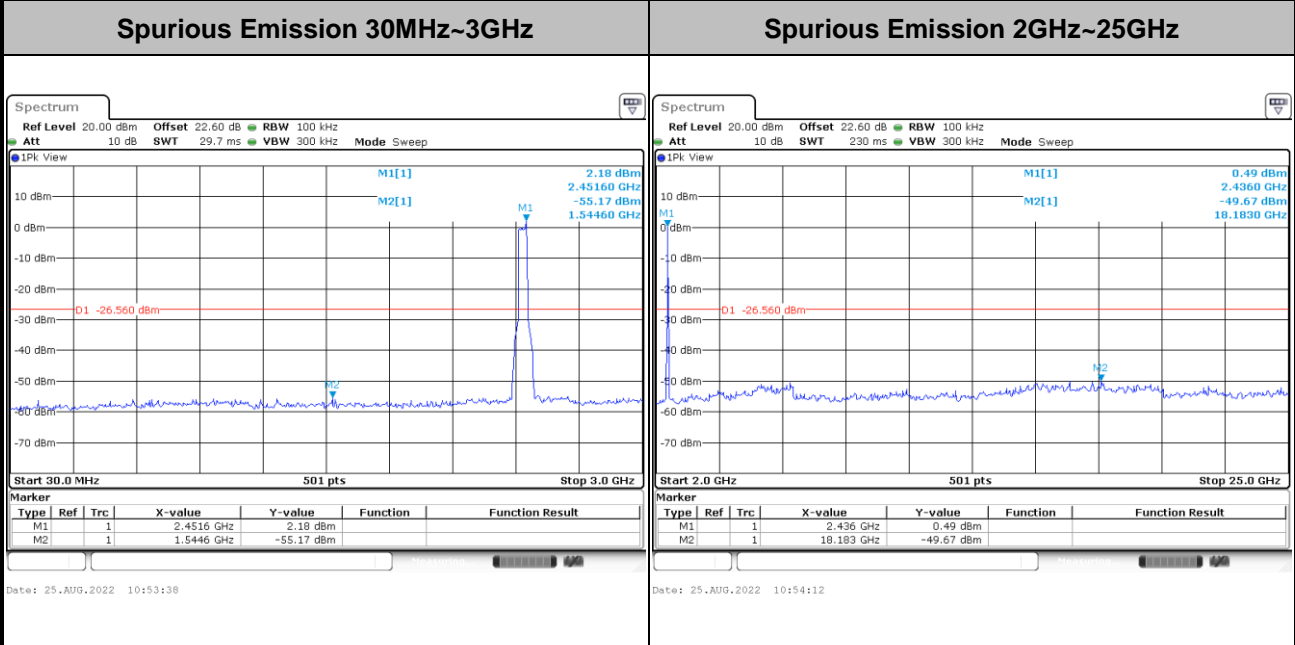
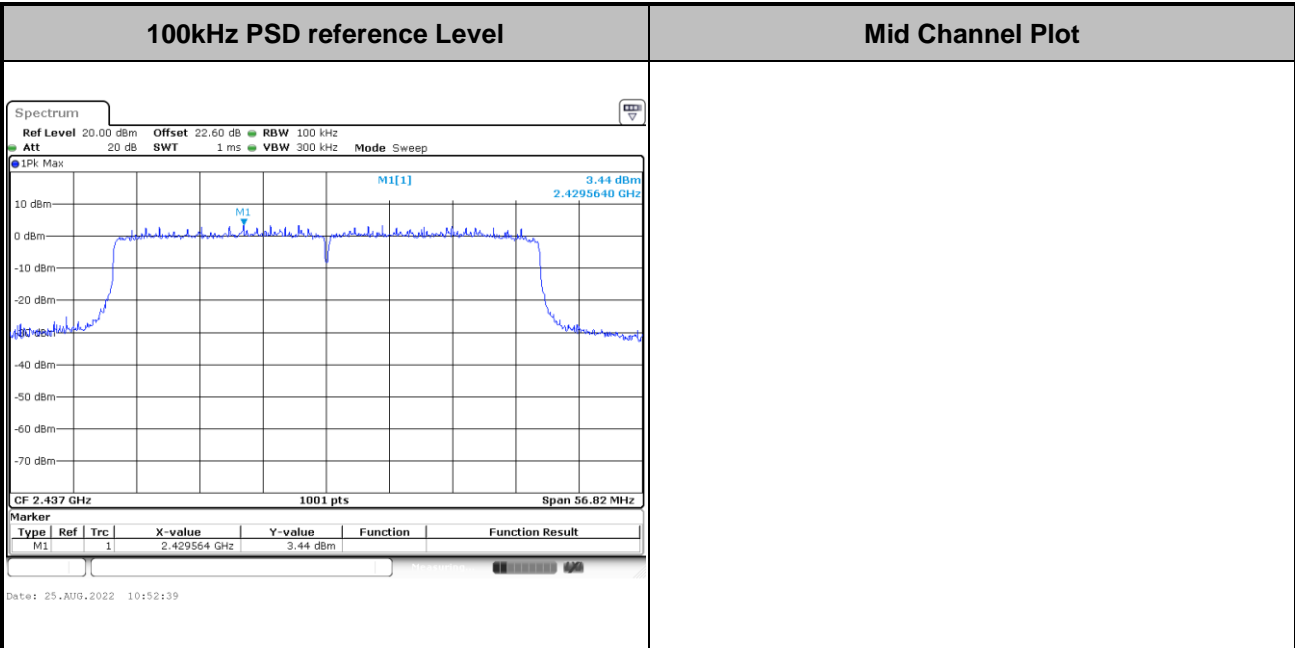



Test Mode :	802.11ax HE40	Test Channel :	09 Full RU
--------------------	---------------	-----------------------	------------

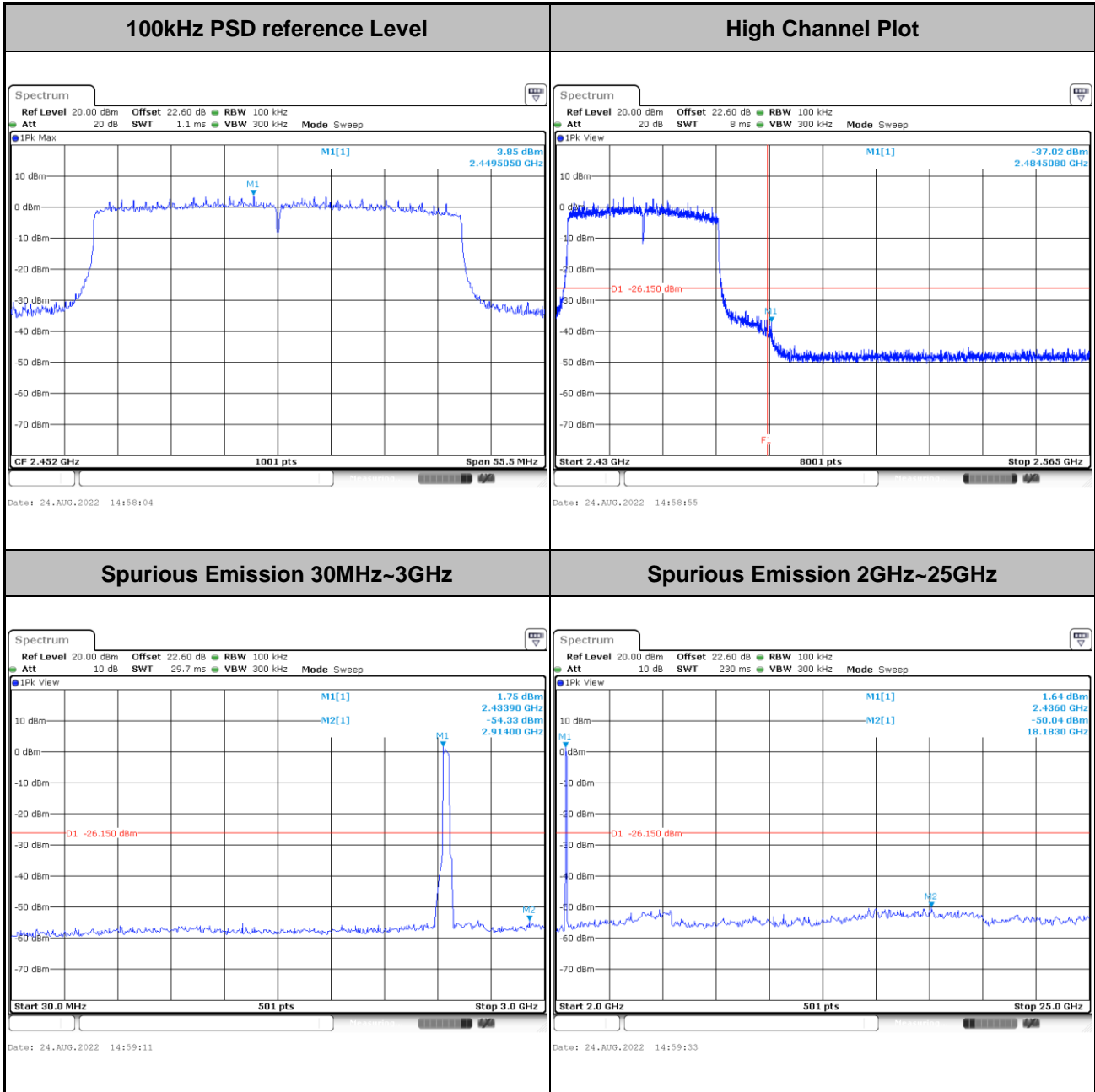



Number of TX = 2, Ant. 8 (Measured)

Test Mode :	802.11b	Test Channel :	01
-------------	---------	----------------	----

100kHz PSD reference Level	Low Channel Plot
-----------------------------------	-------------------------

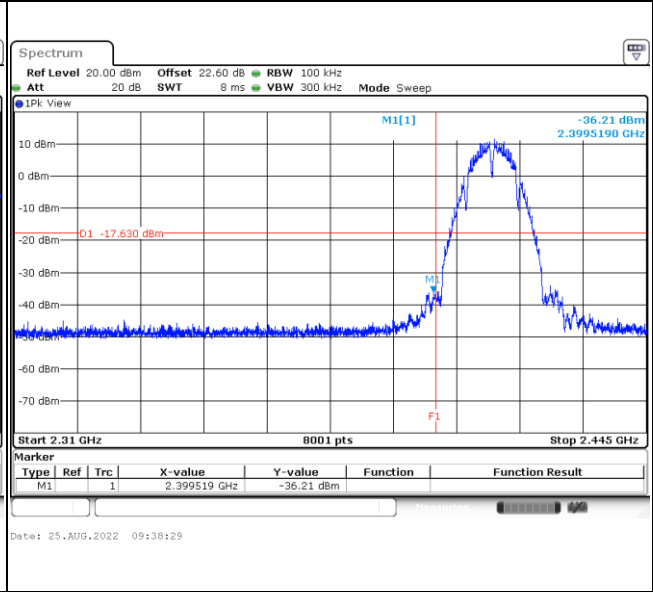
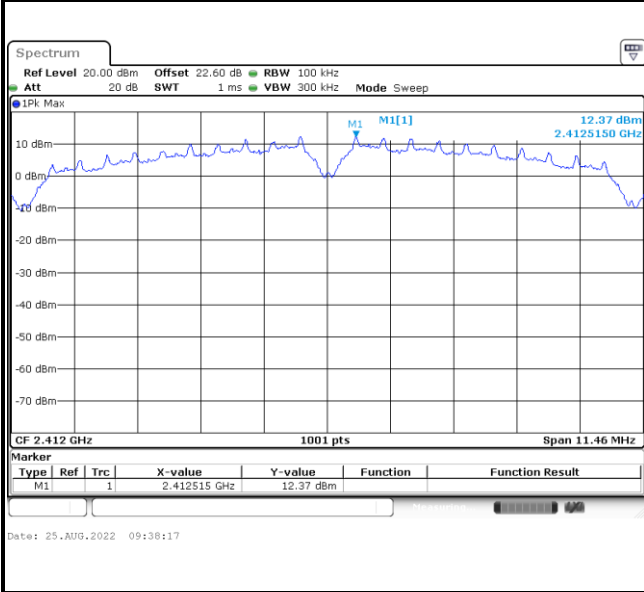

Spurious Emission 30MHz~3GHz

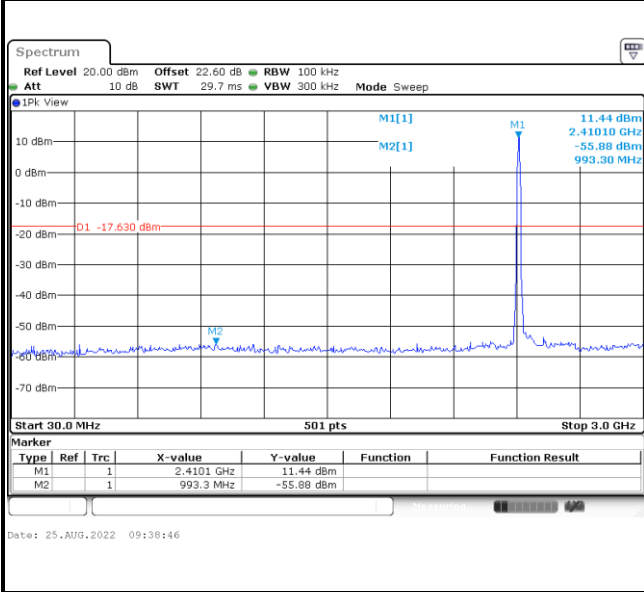

Spurious Emission 2GHz~25GHz

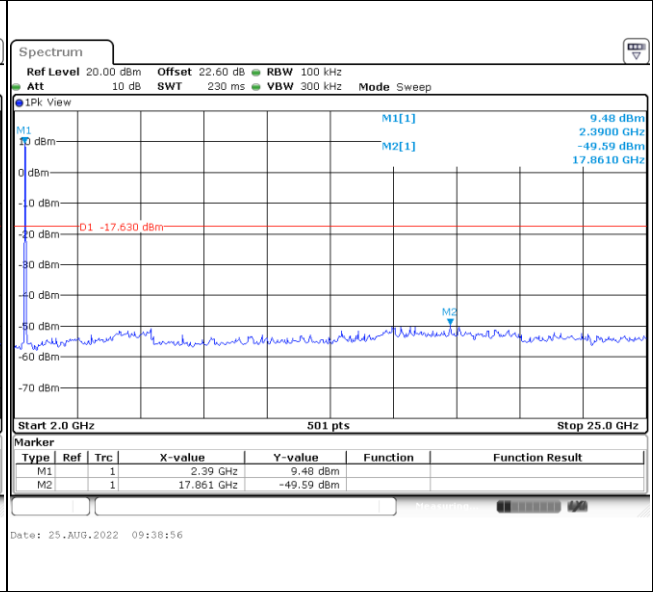



Test Mode :	802.11b	Test Channel :	06
-------------	---------	----------------	----

100kHz PSD reference Level	Mid Channel Plot
-----------------------------------	-------------------------

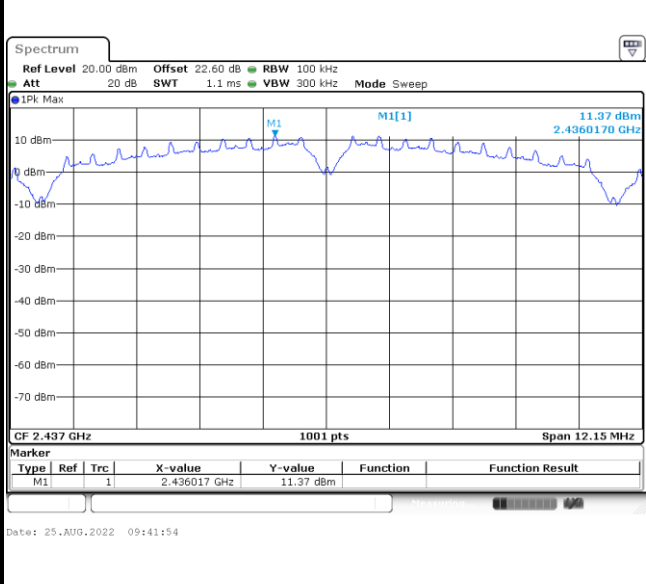

Spurious Emission 30MHz~3GHz

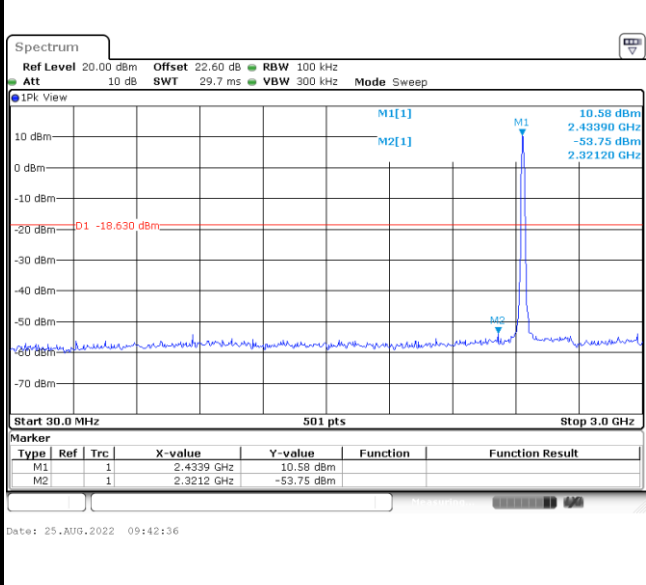

Spurious Emission 2GHz~25GHz

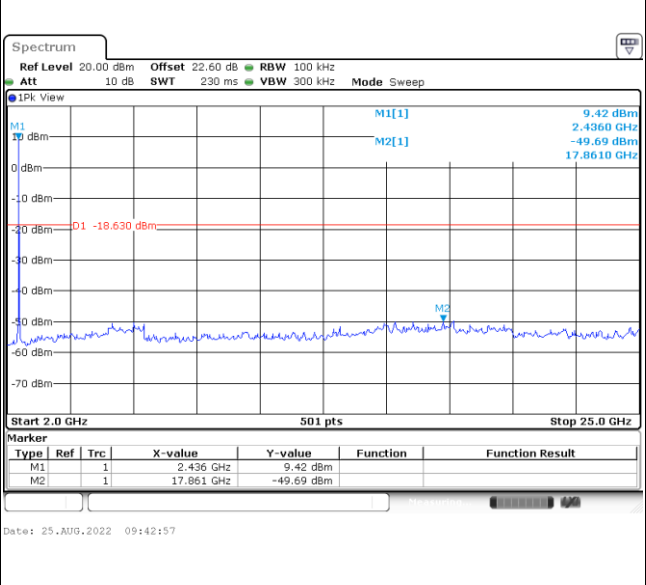



Test Mode :	802.11b	Test Channel :	11
-------------	---------	----------------	----

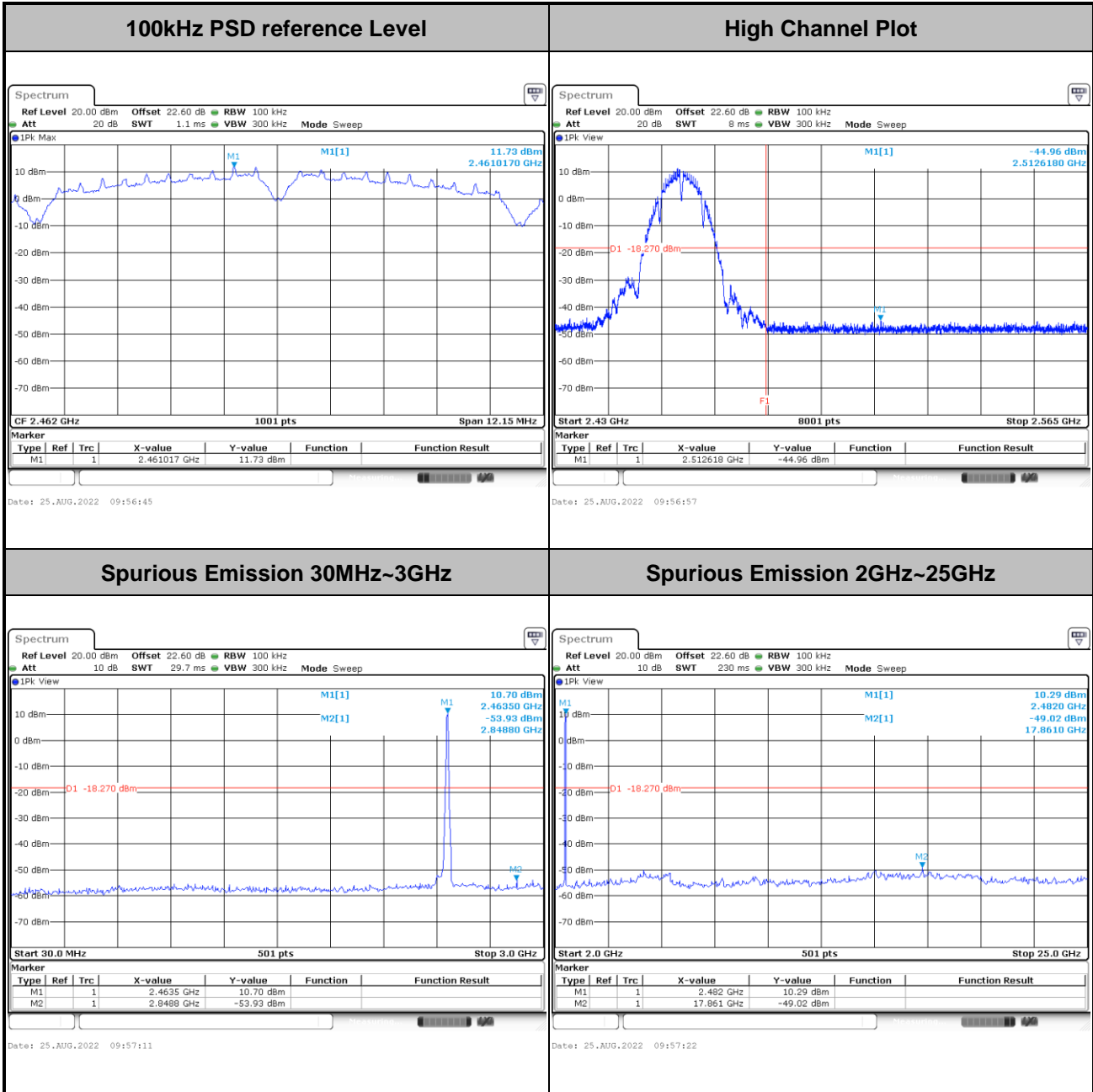



Test Mode :	802.11g	Test Channel :	01
-------------	---------	----------------	----

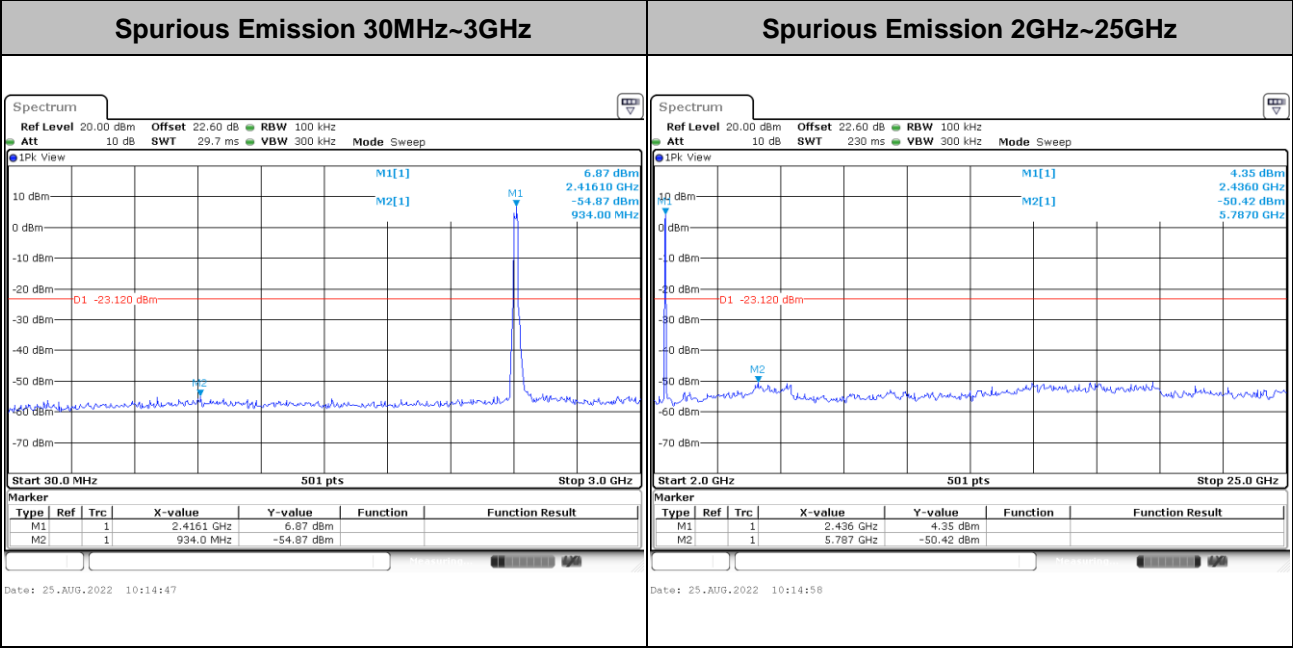
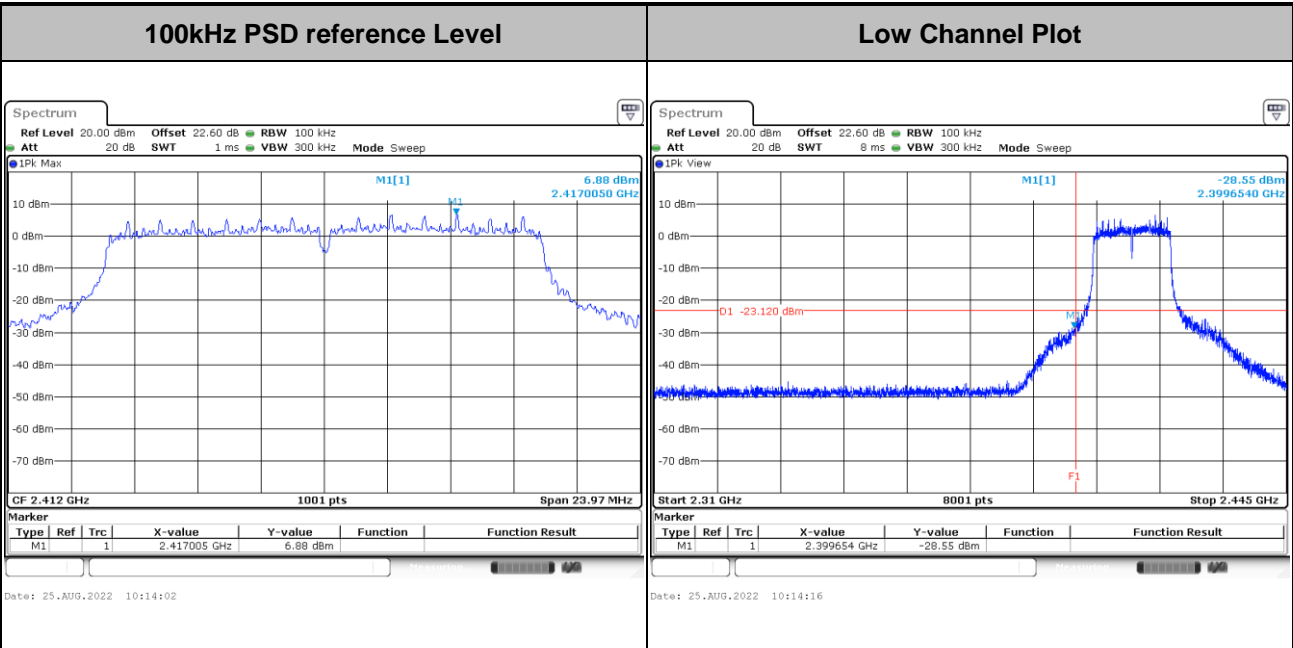



Test Mode :	802.11g	Test Channel :	06
-------------	---------	----------------	----

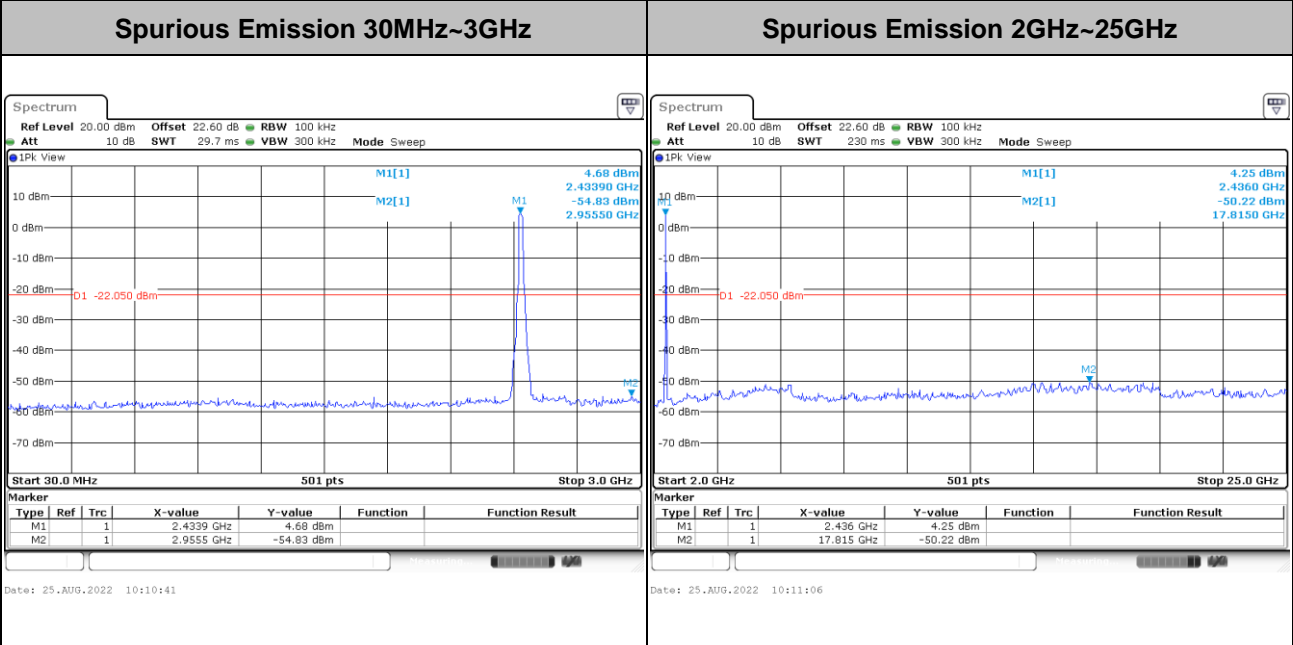
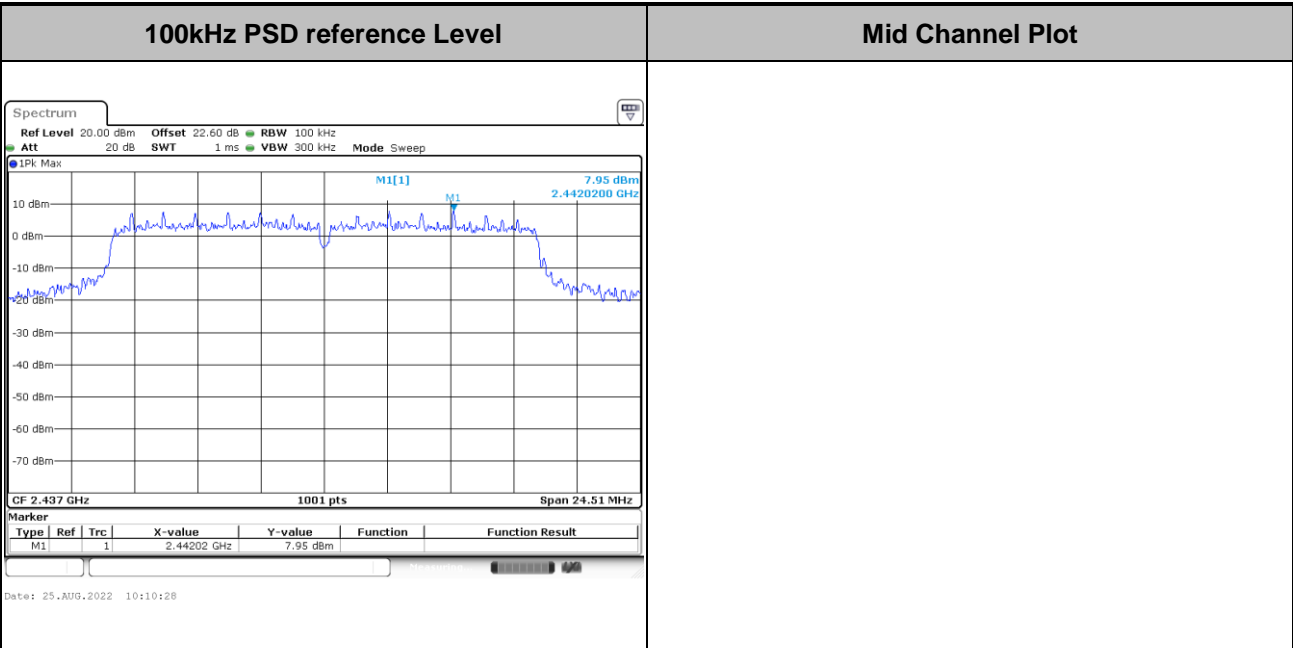



Test Mode :	802.11g	Test Channel :	11
-------------	---------	----------------	----

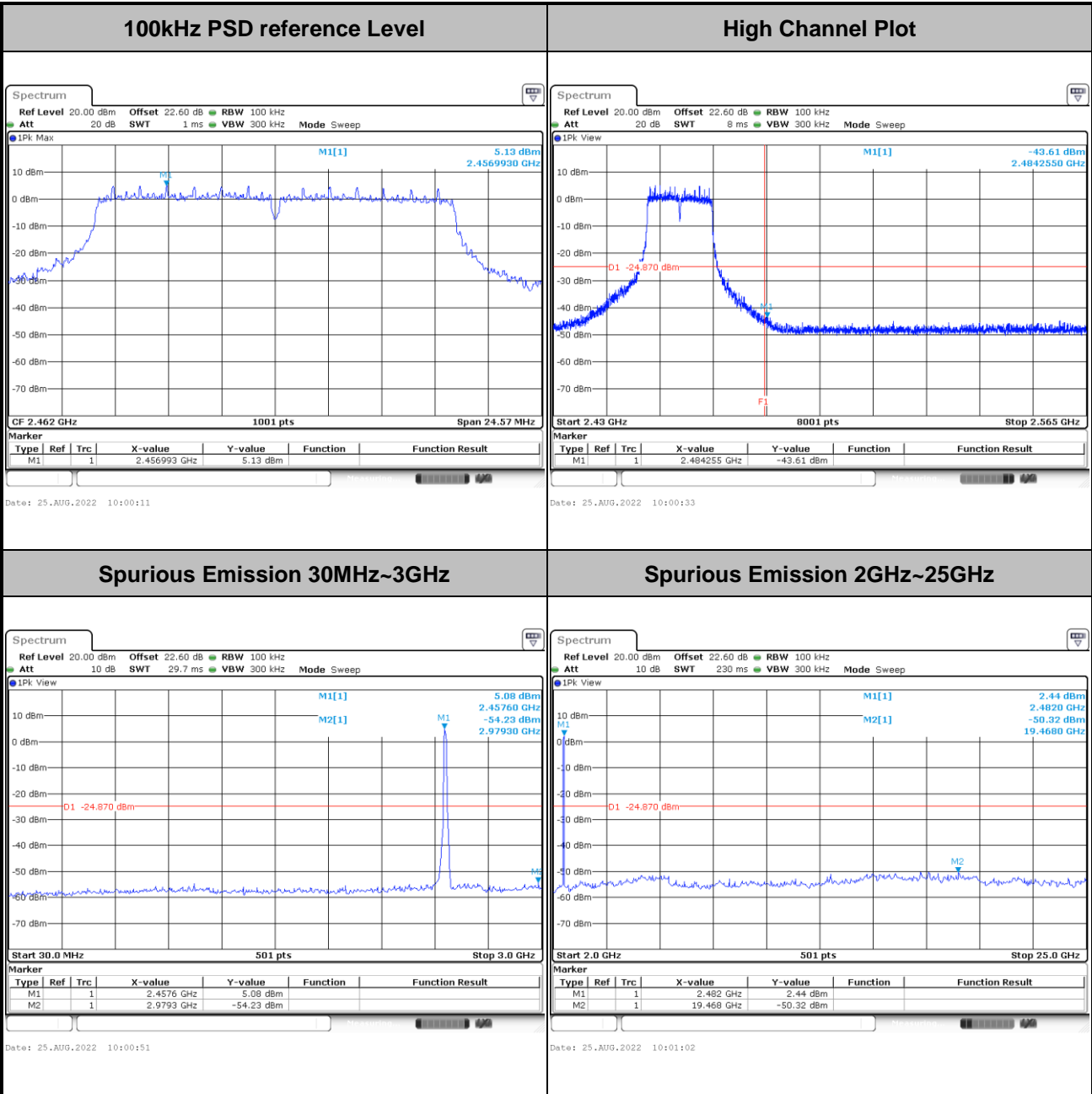



Test Mode :	802.11ax HE20	Test Channel :	01 Full RU
-------------	---------------	----------------	------------

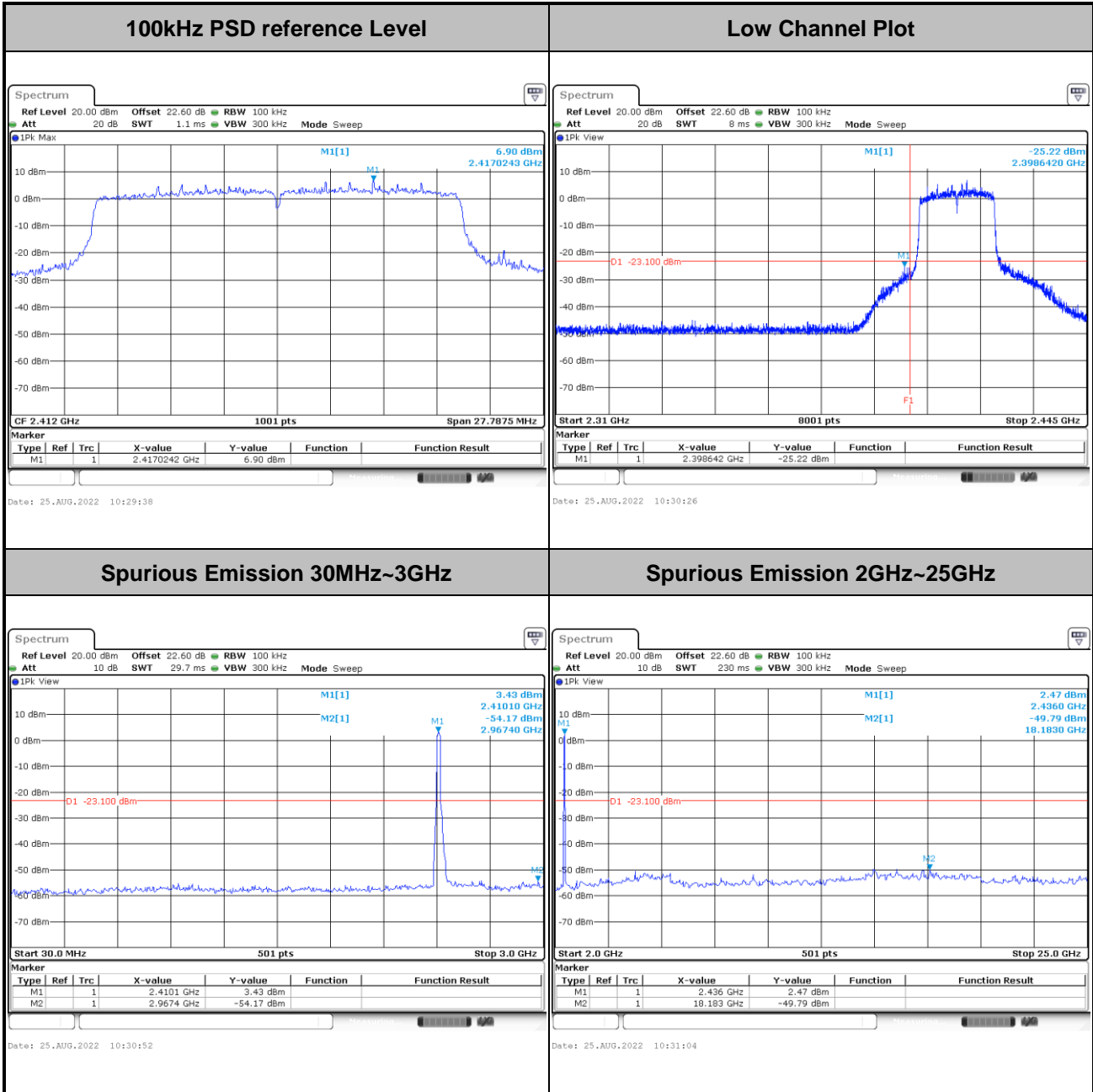



Test Mode :	802.11ax HE20	Test Channel :	06 Full RU
-------------	---------------	----------------	------------

100kHz PSD reference Level	Mid Channel Plot
-----------------------------------	-------------------------

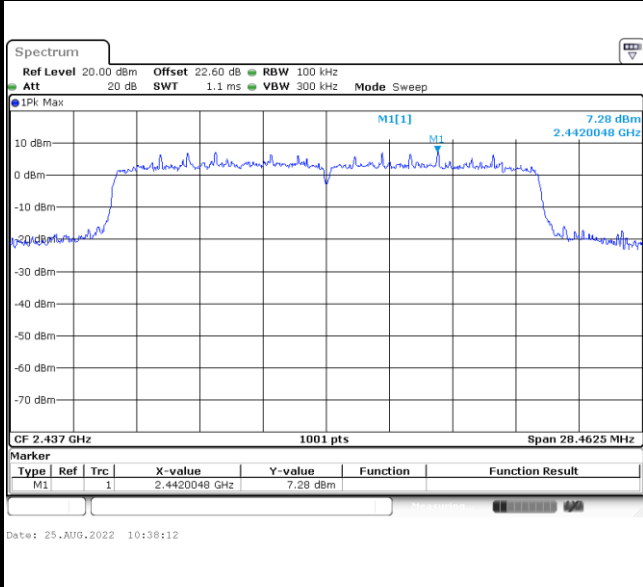

Spurious Emission 30MHz~3GHz

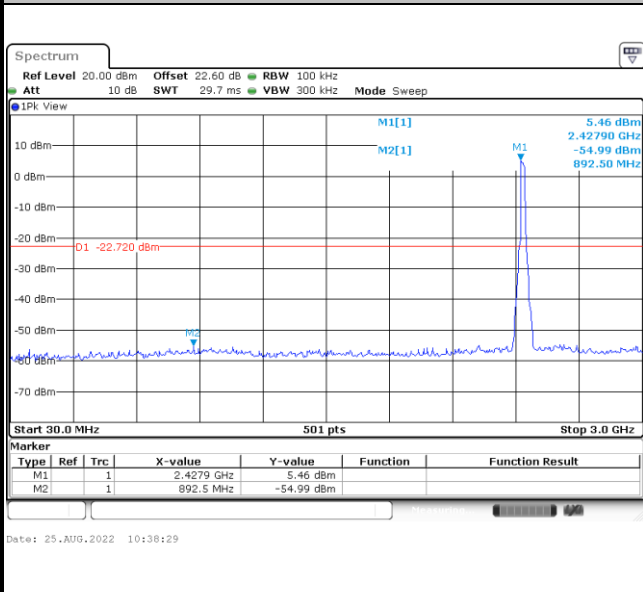

Spurious Emission 2GHz~25GHz

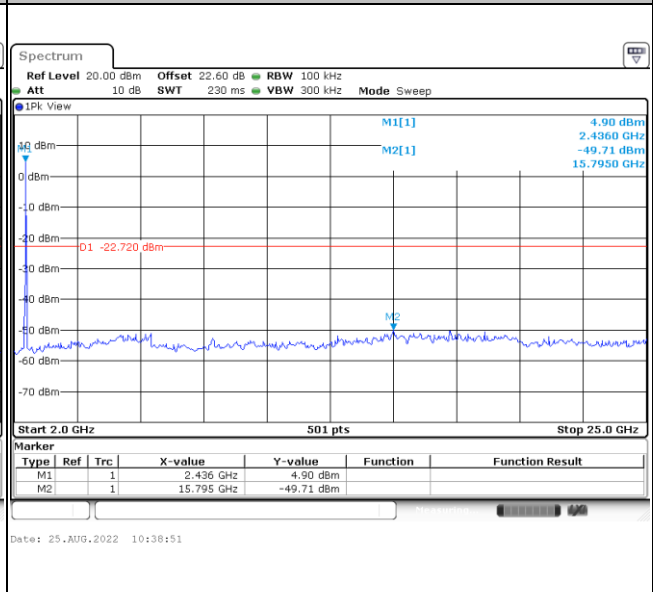



Test Mode :	802.11ax HE20	Test Channel :	11 Full RU
-------------	---------------	----------------	------------

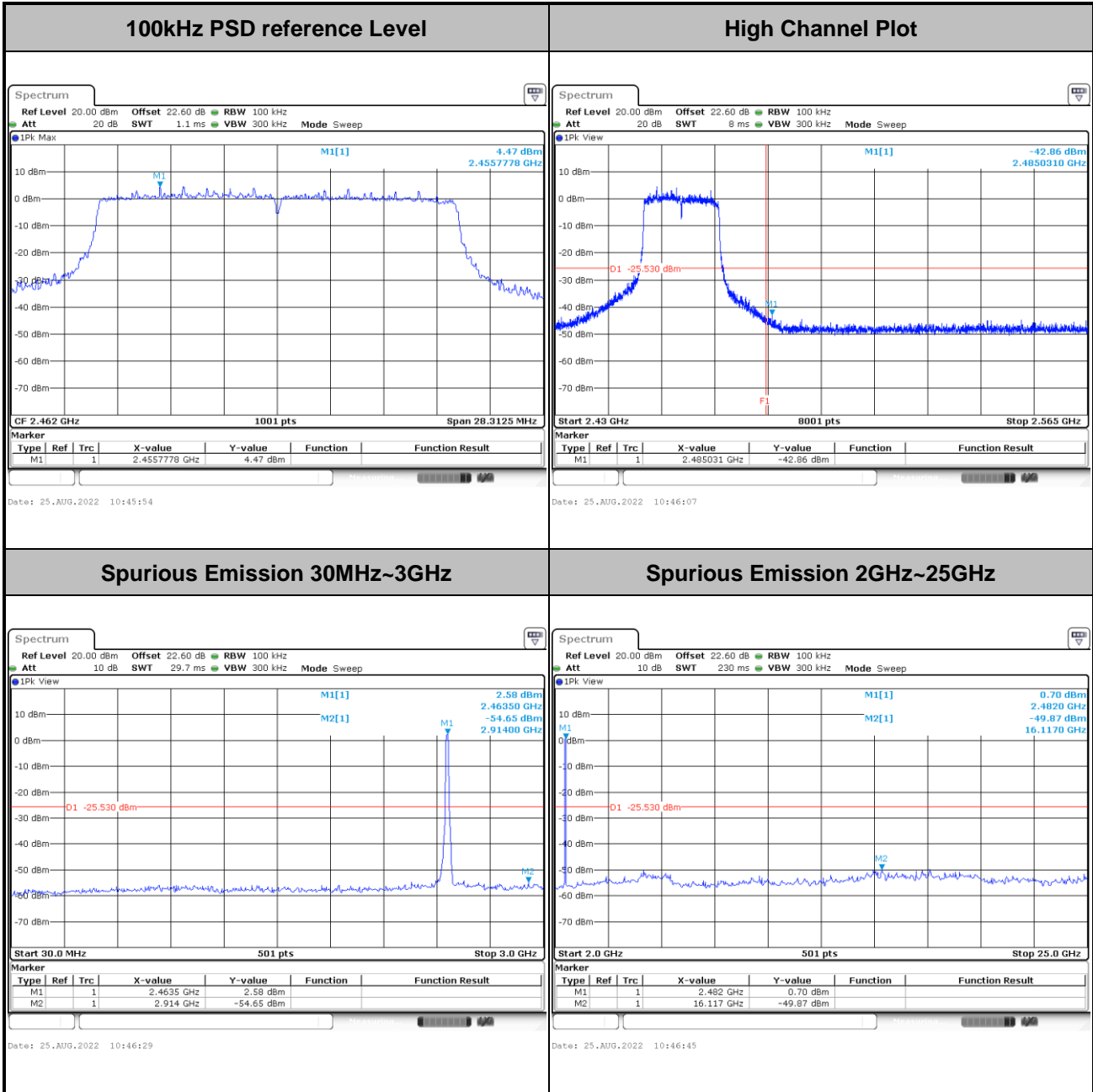



Test Mode :	802.11ax HE40	Test Channel :	03 Full RU
-------------	---------------	----------------	------------

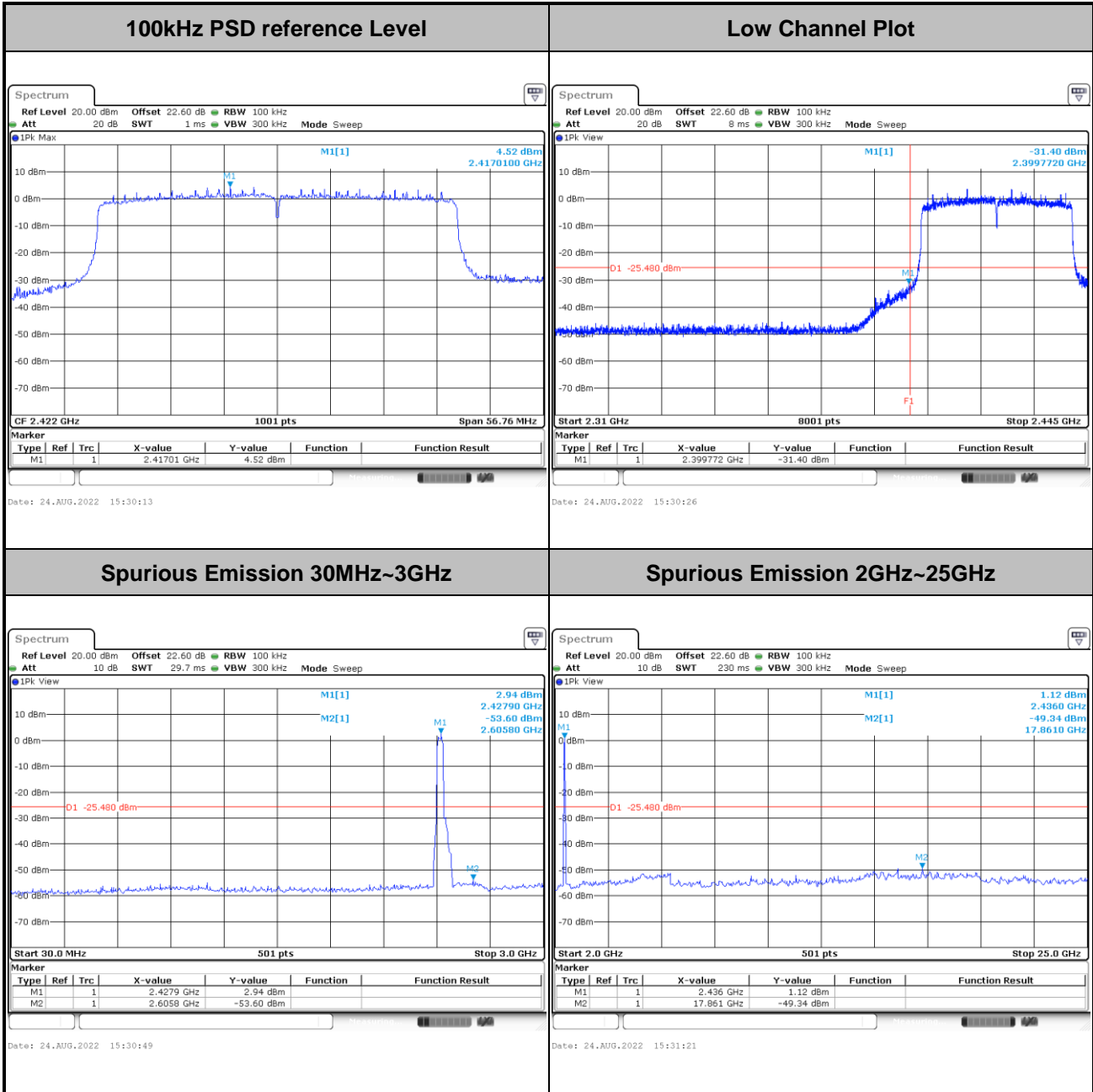



Test Mode :	802.11ax HE40	Test Channel :	06 Full RU
-------------	---------------	----------------	------------

100kHz PSD reference Level	Mid Channel Plot
-----------------------------------	-------------------------

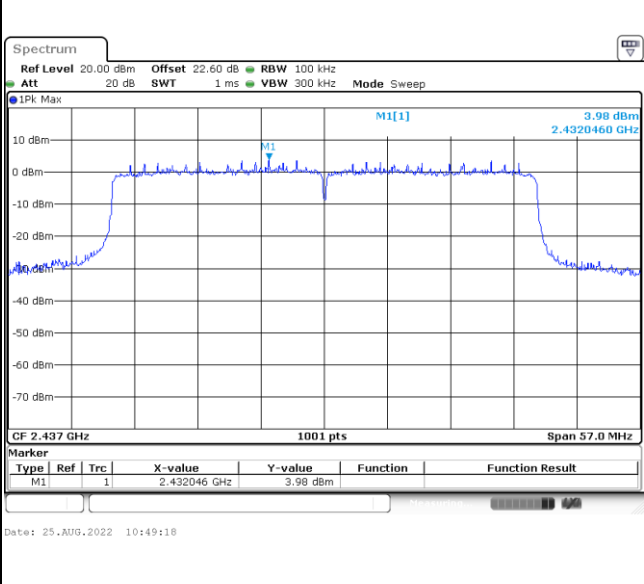

Spurious Emission 30MHz~3GHz

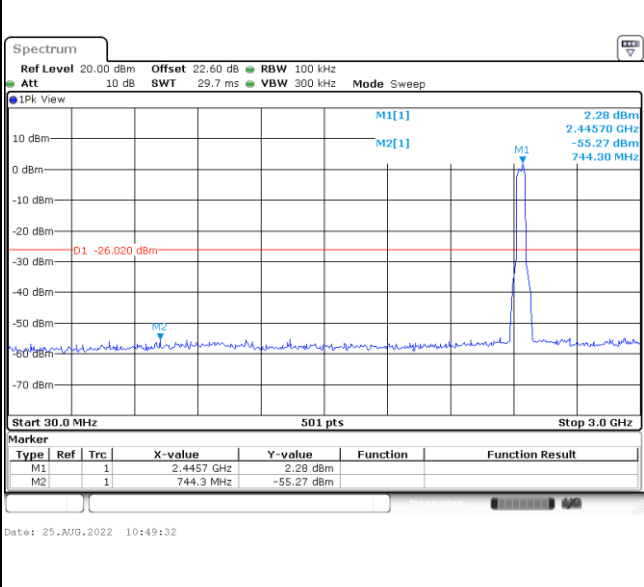

Spurious Emission 2GHz~25GHz

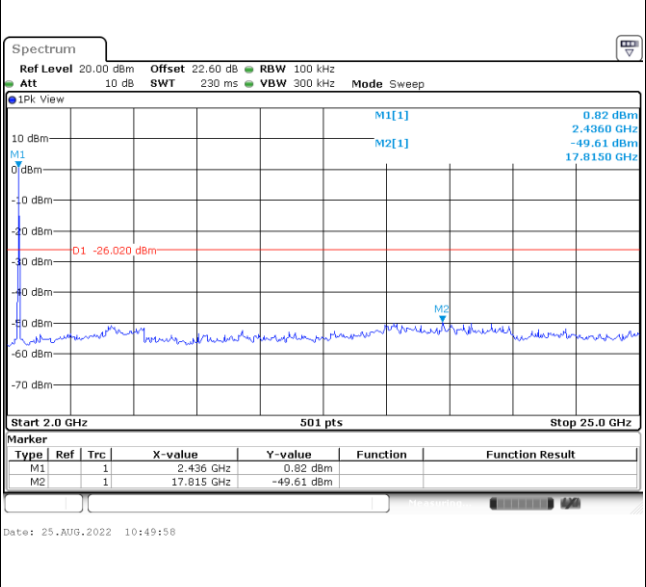



Test Mode :	802.11ax HE40	Test Channel :	09 Full RU
-------------	---------------	----------------	------------

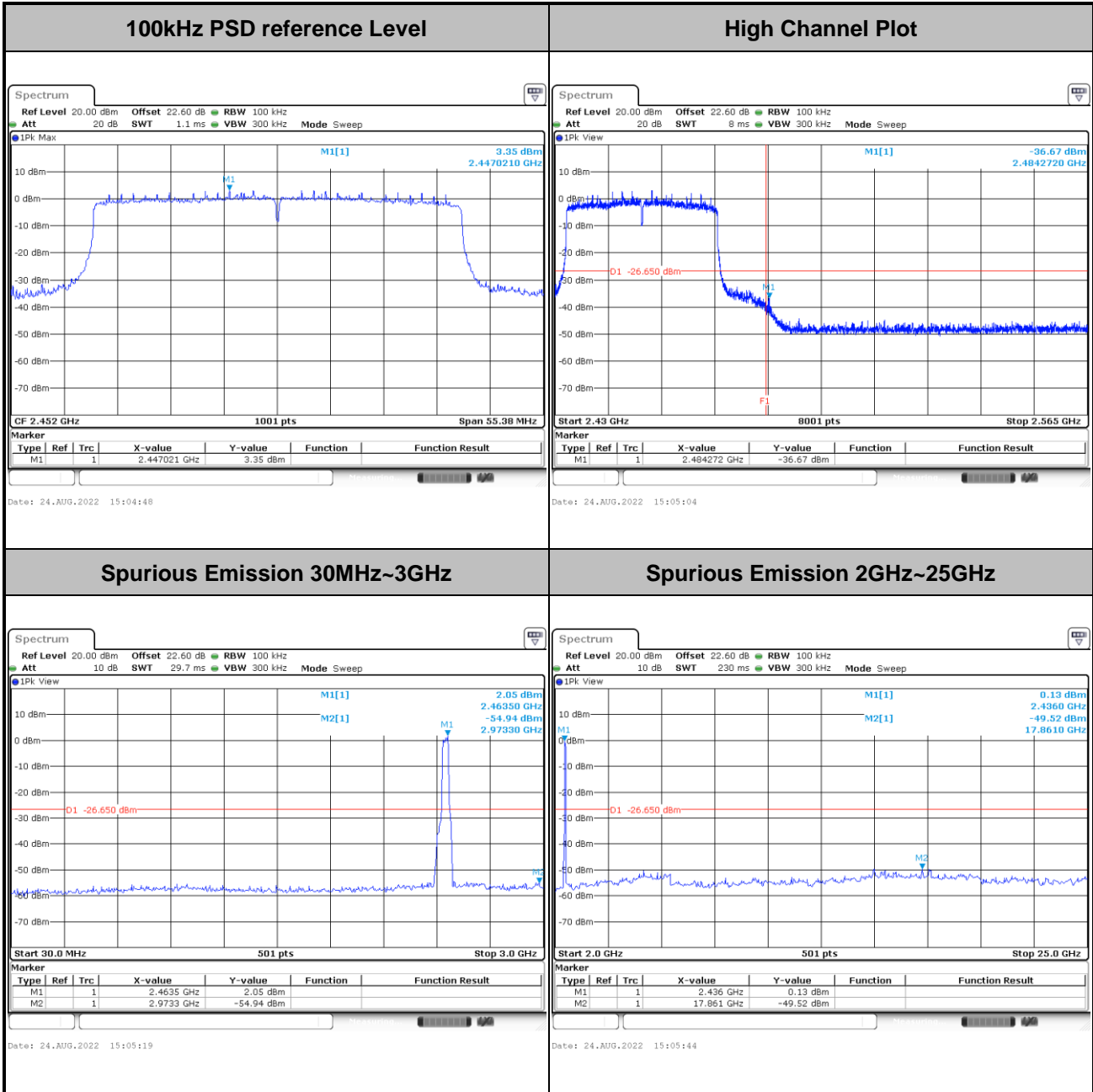



<TXBF Modes>

Number of TX = 2, Ant. 9 (Measured)

Test Mode :	802.11ax HE20	Test Channel :	01 Full RU
-------------	---------------	----------------	------------

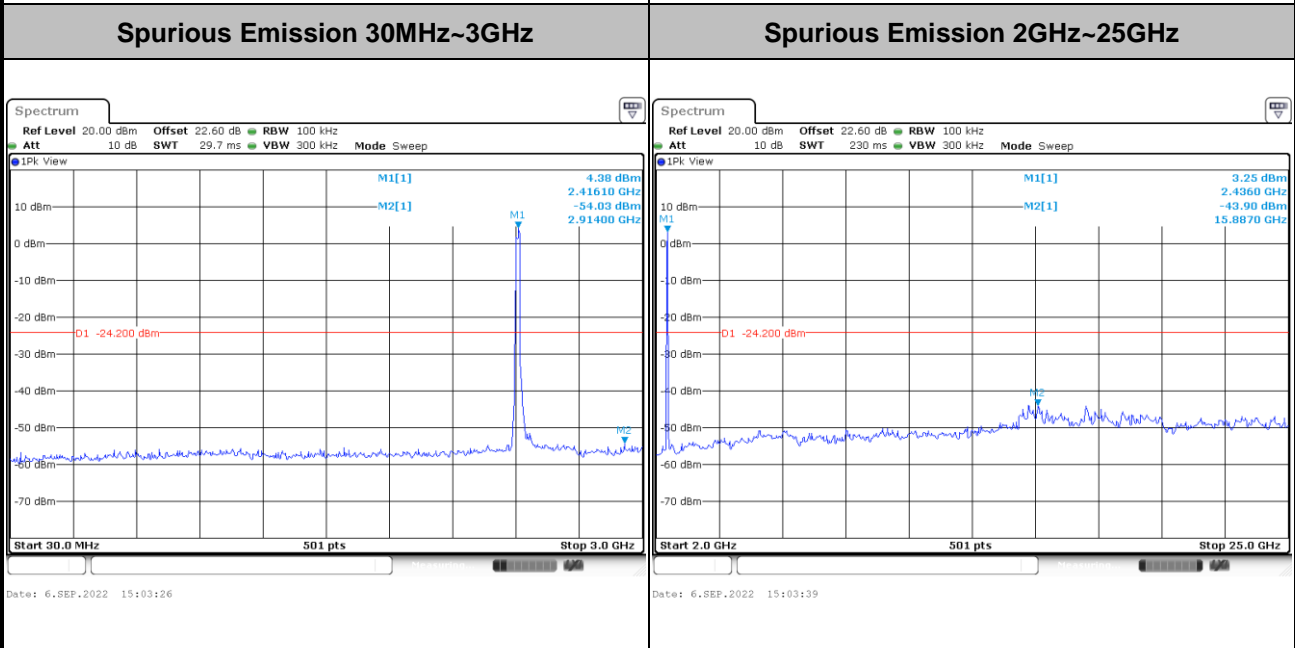
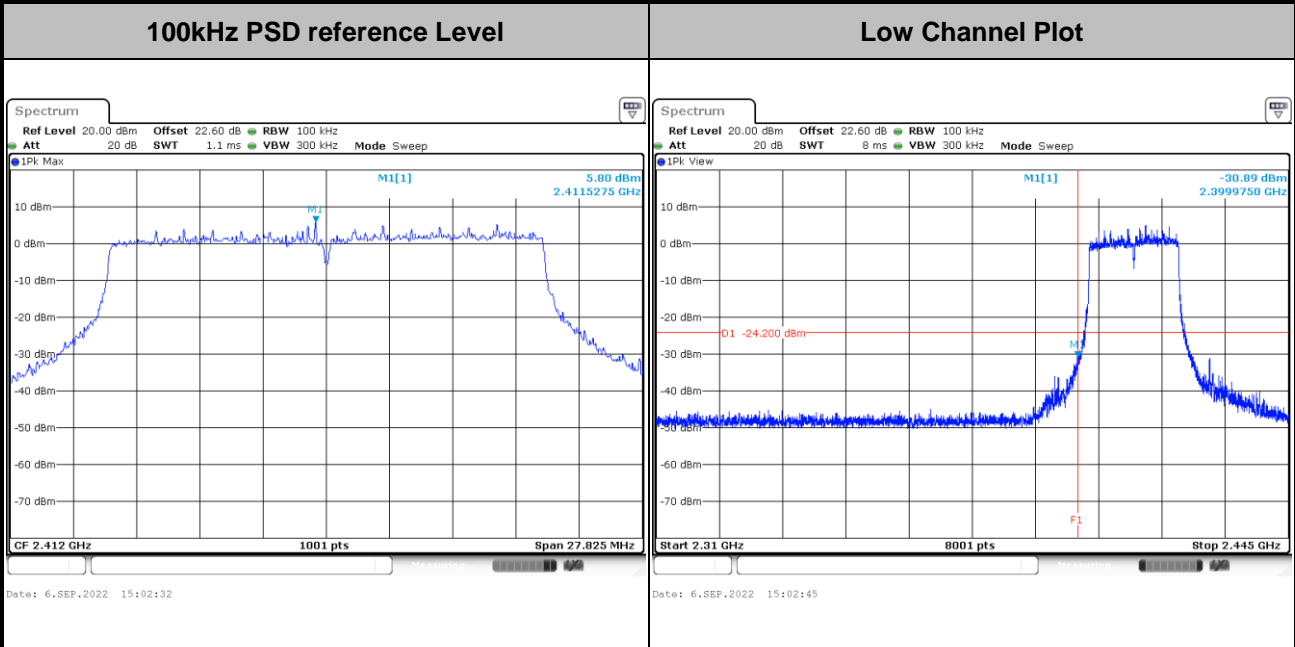



Test Mode :	802.11ax HE20	Test Channel :	06 Full RU
--------------------	---------------	-----------------------	------------

