



FCC RADIO TEST REPORT

FCC ID : UZ7TC58AE
Equipment : Touch Computer
Brand Name : Zebra
Model Name : TC58AE
Applicant : Zebra Technologies Corporation
1 Zebra Plaza, Holtsville, NY 11742
Manufacturer : Zebra Technologies Corporation
1 Zebra Plaza, Holtsville, NY 11742
Standard : FCC Part 15 Subpart C §15.247

The product was received on Jan. 10, 2024 and testing was performed from Jan. 28, 2024 to Apr. 16, 2024. We, Sporton International Inc. Wensan Laboratory, would like to declare that the tested sample has been evaluated in accordance with the test procedures and has been in compliance with the applicable technical standards.

The test results in this report apply exclusively to the tested model / sample. Without written approval from Sporton International Inc. Wensan Laboratory, the test report shall not be reproduced except in full.

Louis Wu

Approved by: Louis Wu

Sporton International Inc. Wensan Laboratory

No.58, Aly. 75, Ln. 564, Wenhua 3rd, Rd., Guishan Dist., Taoyuan City 333010, Taiwan (R.O.C.)



Table of Contents

History of this test report.....	3
Summary of Test Result.....	4
1 General Description.....	5
1.1 Product Feature of Equipment Under Test.....	5
1.2 Product Specification of Equipment Under Test.....	6
1.3 Modification of EUT	7
1.4 Testing Location	7
1.5 Applicable Standards.....	7
2 Test Configuration of Equipment Under Test.....	8
2.1 Carrier Frequency Channel	8
2.2 Test Mode.....	9
2.3 Connection Diagram of Test System.....	10
2.4 Support Unit used in test configuration and system	11
2.5 EUT Operation Test Setup	11
2.6 Measurement Results Explanation Example.....	11
3 Test Result.....	12
3.1 6dB and 99% Bandwidth Measurement	12
3.2 Output Power Measurement.....	13
3.3 Power Spectral Density Measurement	14
3.4 Conducted Band Edges and Spurious Emission Measurement	15
3.5 Radiated Band Edges and Spurious Emission Measurement	16
3.6 AC Conducted Emission Measurement.....	20
3.7 Antenna Requirements.....	22
4 List of Measuring Equipment	23
5 Measurement Uncertainty	24
Appendix A. Conducted Test Results	
Appendix B. AC Conducted Emission Test Result	
Appendix C. Radiated Spurious Emission	
Appendix D. Radiated Spurious Emission Plots	
Appendix E. Duty Cycle Plots	
Appendix F. Setup Photographs	



History of this test report

Report No.	Version	Description	Issue Date
FR411111B	01	Initial issue of report	May 10, 2024



Summary of Test Result

Report Clause	Ref Std. Clause	Test Items	Result (PASS/FAIL)	Remark
3.1	15.247(a)(2)	6dB Bandwidth	Pass	-
3.1	2.1049	99% Occupied Bandwidth	Reporting only	-
3.2	15.247(b)(3) 15.247(b)(4)	Output Power	Pass	-
3.3	15.247(e)	Power Spectral Density	Pass	-
3.4	15.247(d)	Conducted Band Edges and Spurious Emission	Pass	-
3.5	15.247(d)	Radiated Band Edges and Spurious Emission	Pass	7.30 dB under the limit at 52.61 MHz
3.6	15.207	AC Conducted Emission	Pass	17.48 dB under the limit at 0.17 MHz
3.7	15.203	Antenna Requirement	Pass	-

Conformity Assessment Condition:

1. The test results (PASS/FAIL) with all measurement uncertainty excluded are presented against the regulation limits or in accordance with the requirements stipulated by the applicant/manufacturer who shall bear all the risks of non-compliance that may potentially occur if measurement uncertainty is taken into account.
2. The measurement uncertainty please refer to each test result in the section "Measurement Uncertainty".

Disclaimer:

The product specifications of the EUT presented in the test report that may affect the test assessments are declared by the manufacturer who shall take full responsibility for the authenticity.

Reviewed by: Wei Chen

Report Producer: Wilda Wei



1 General Description

1.1 Product Feature of Equipment Under Test

Product Feature	
Equipment	Touch Computer
Brand Name	Zebra
Model Name	TC58AE
FCC ID	UZ7TC58AE
Sample 1	SE55 + 8GB 128G (Samsung/SK Hynix)
Sample 2	SE4720 + 6GB 64G (SK Hynix/WD)
Sample 3	SE4770 + 6GB 64G (SK Hynix/WD)
EUT supports Radios application	WCDMA/HSPA/LTE/5G NR/NFC/GNSS WLAN 11a/b/g/n HT20/HT40 WLAN 11ac VHT20/VHT40/VHT80/VHT160 WLAN 11ax HE20/HE40/HE80/HE160 Bluetooth BR/EDR/LE
HW Version	DV1-2
SW Version	nemesis_A13_userdebug_GMS_RelKey_2023-12-12-0451_main_SE
FW Version	FUSION_QA_6_1.1.0.004_T
MFD	06DEC23
EUT Stage	Identical Prototype

Remark: The EUT's information above is declared by manufacturer.

Specification of Accessories				
Adapter	Brand Name	Zebra	Part Number	PWR-WUA5V12W0US
Battery 1 (1x)	Brand Name	Zebra	Part Number	BT-000442-0020
Battery 2 (1.5x)	Brand Name	Zebra	Part Number	BT-000442-0820
Battery 3 (BLE battery)	Brand Name	Zebra	Part Number	BT-000442-002B
Battery 4 (Wireless Battery)	Brand Name	Zebra	Part Number	BT-000442-002A
Battery 5 (1x)	Brand Name	Zebra	Part Number	BT-000442-1020
USB TYPE A to TYPE C cable	Brand Name	Zebra	Part Number	CBL-TC5X-USBC2A-01
USB TYPE C to 3.5mm audio connector	Brand Name	Zebra	Part Number	ADP-USBC-35MM1-01
3.5mm Earphone	Brand Name	Zebra	Part Number	HDST-35MM-PTT1-01
Rugged Headset	Brand Name	Zebra	Part Number	HS2100-OTH
USB TYPE C Earphone	Brand Name	Zebra	Part Number	HPST-USBC-PTT1-01
Trigger Handle	Brand Name	Zebra	Part Number	TRG-NGTC5-ELEC-01
Soft Holster	Brand Name	Zebra	Part Number	SG-NGTC5TC7-HLSTR-01
TC53/TC58 RUGGED BOOT	Brand Name	Zebra	Part Number	SG-NGTC5EXO1-01
3.5mm to 3.5mm audio connector	Brand Name	Zebra	Part Number	CBL-HS2100-3MS1-01



1.2 Product Specification of Equipment Under Test

Product Specification is subject to this standard	
Tx/Rx Frequency Range	2402 MHz ~ 2480 MHz
Number of Channels	40
Carrier Frequency of Each Channel	40 Channel (37 hopping + 3 advertising channel)
Maximum Output Power to Antenna	<p><Class 1> <Ant. 6> Bluetooth – LE (1Mbps): 5.90 dBm / 0.0039 W Bluetooth – LE (2Mbps): 5.80 dBm / 0.0038 W <Ant. 7> Bluetooth – LE (1Mbps): 6.30 dBm / 0.0043 W Bluetooth – LE (2Mbps): 6.30 dBm / 0.0043 W <Class 2> <Ant. 6> Bluetooth – LE (1Mbps): 2.90 dBm / 0.0019 W Bluetooth – LE (2Mbps): 2.90 dBm / 0.0019 W <Ant. 7> Bluetooth – LE (1Mbps): 3.00 dBm / 0.0020 W Bluetooth – LE (2Mbps): 3.10 dBm / 0.0020 W</p>
99% Occupied Bandwidth	<p><Class 1> <Ant. 6> 1.029 MHz for 1Mbps 1.998 MHz for 2Mbps <Ant. 7> 1.019 MHz for 1Mbps 1.998 MHz for 2Mbps <Class 2> <Ant. 6> 1.019 MHz for 1Mbps 2.006 MHz for 2Mbps <Ant. 7> 1.019 MHz for 1Mbps 2.002 MHz for 2Mbps</p>
Antenna Type / Gain	<p><Ant. 6>: PIFA with gain 2.32 dBi <Ant. 7>: PIFA with gain 0.14 dBi</p>
Type of Modulation	Bluetooth LE: GFSK

Remark: The EUT's information above is declared by manufacturer. Please refer to Disclaimer in report summary.



1.3 Modification of EUT

No modifications made to the EUT during the testing.

1.4 Testing Location

Test Site	Sporton International Inc. EMC & Wireless Communications Laboratory
Test Site Location	No.52, Huaya 1st Rd., Guishan Dist., Taoyuan City 333, Taiwan (R.O.C.) TEL: +886-3-327-3456 FAX: +886-3-328-4978
Test Site No.	Sporton Site No. CO05-HY (TAF Code: 1190)
Remark	The Conducted Emission test item subcontracted to Sporton International Inc. EMC & Wireless Communications Laboratory.

Note: The test site complies with ANSI C63.4 2014 requirement.

Test Site	Sporton International Inc. Wensan Laboratory
Test Site Location	No.58, Aly. 75, Ln. 564, Wenhua 3rd, Rd., Guishan Dist., Taoyuan City 333010, Taiwan (R.O.C.) TEL: +886-3-327-0868 FAX: +886-3-327-0855
Test Site No.	Sporton Site No. TH05-HY, 03CH20-HY

Note: The test site complies with ANSI C63.4 2014 requirement.

FCC designation No.: TW1190 and TW3786

1.5 Applicable Standards

According to the specifications declared by the manufacturer, the EUT must comply with the requirements of the following standards:

- ♦ FCC Part 15 Subpart C §15.247
- ♦ FCC KDB Publication No. 558074 D01 15.247 Meas Guidance v05r02
- ♦ FCC KDB 414788 D01 Radiated Test Site v01r01
- ♦ ANSI C63.10-2013

Remark:

1. All the test items were validated and recorded in accordance with the standards without any modification during the testing.
2. The TAF code is not including all the FCC KDB listed without accreditation.
3. This EUT has also been tested and complied with the requirements of FCC Part 15, Subpart B, recorded in a separate test report.



2 Test Configuration of Equipment Under Test

2.1 Carrier Frequency Channel

Frequency Band	Channel	Freq. (MHz)	Channel	Freq. (MHz)
2400-2483.5 MHz	0	2402	21	2444
	1	2404	22	2446
	2	2406	23	2448
	3	2408	24	2450
	4	2410	25	2452
	5	2412	26	2454
	6	2414	27	2456
	7	2416	28	2458
	8	2418	29	2460
	9	2420	30	2462
	10	2422	31	2464
	11	2424	32	2466
	12	2426	33	2468
	13	2428	34	2470
	14	2430	35	2472
	15	2432	36	2474
	16	2434	37	2476
	17	2436	38	2478
	18	2438	39	2480
	19	2440	-	-
20	2442	-	-	



2.2 Test Mode

- a. The EUT has been associated with peripherals and configuration operated in a manner tended to maximize its emission characteristics in a typical application. Frequency range investigated: conduction emission (150 kHz to 30 MHz), radiation emission (9 kHz to the 10th harmonic of the highest fundamental frequency or to 40 GHz, whichever is lower). For radiated measurement, the measured emission level of the EUT was maximized by rotating the EUT on a turntable, adjusting the orientation of the EUT and EUT antenna in three orthogonal axis (X: flat, Y: portrait, Z: landscape), and adjusting the measurement antenna orientation, following C63.10 exploratory test procedures and only the worst case emissions were reported in this report.
- b. AC power line Conducted Emission was tested under maximum output power.

The following summary table is showing all test modes to demonstrate in compliance with the standard.

Summary table of Test Cases	
Test Item	Data Rate / Modulation
Conducted Test Cases	Bluetooth – LE / GFSK
	Mode 1: Bluetooth Tx CH00_2402 MHz_1Mbps
	Mode 2: Bluetooth Tx CH19_2440 MHz_1Mbps
	Mode 3: Bluetooth Tx CH39_2480 MHz_1Mbps
	Mode 4: Bluetooth Tx CH00_2402 MHz_2Mbps
	Mode 5: Bluetooth Tx CH19_2440 MHz_2Mbps
	Mode 6: Bluetooth Tx CH39_2480 MHz_2Mbps
Radiated Test Cases	Mode 1: Bluetooth Tx CH00_2402 MHz_1Mbps
	Mode 2: Bluetooth Tx CH19_2440 MHz_1Mbps
	Mode 3: Bluetooth Tx CH39_2480 MHz_1Mbps
	Mode 4: Bluetooth Tx CH00_2402 MHz_2Mbps
	Mode 5: Bluetooth Tx CH19_2440 MHz_2Mbps
	Mode 6: Bluetooth Tx CH39_2480 MHz_2Mbps
AC Conducted Emission	Mode 1: Bluetooth Link + WLAN (2.4GHz) Link + USB TYPE-A to TYPE-C cable (Charging with Adapter) + Battery 2 (1.5x) for Sample 1
Remark:	
1. For Radiated Test Cases, the tests were performed with Battery 1 (1x) and Sample 1.	
2. For radiation spurious emission, the modulation and the data rate picked for testing are determined by the Max. RF conducted power.	

2.3 Connection Diagram of Test System

<AC Conducted Emission Mode>

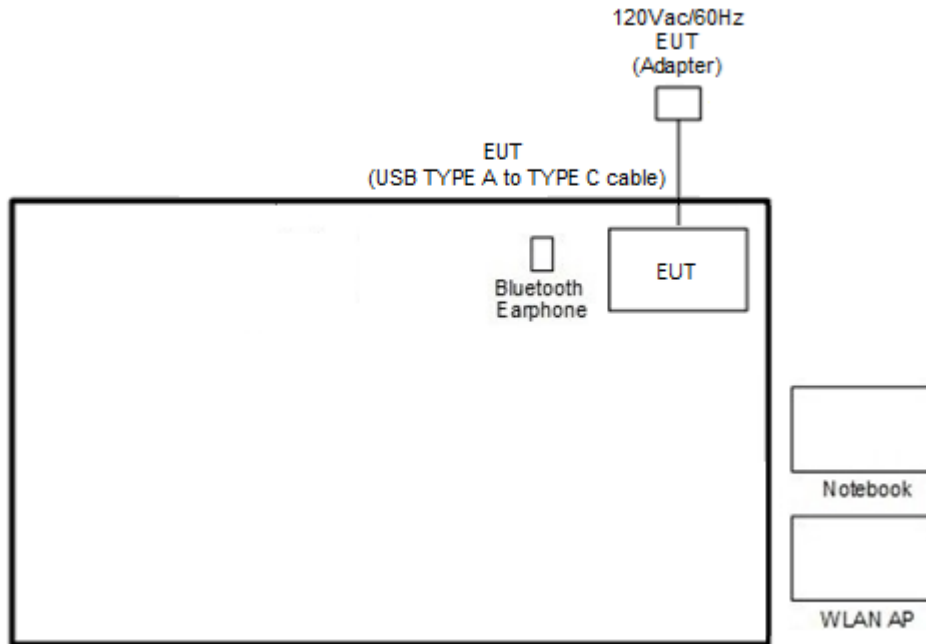

<Bluetooth-LE Tx Mode>

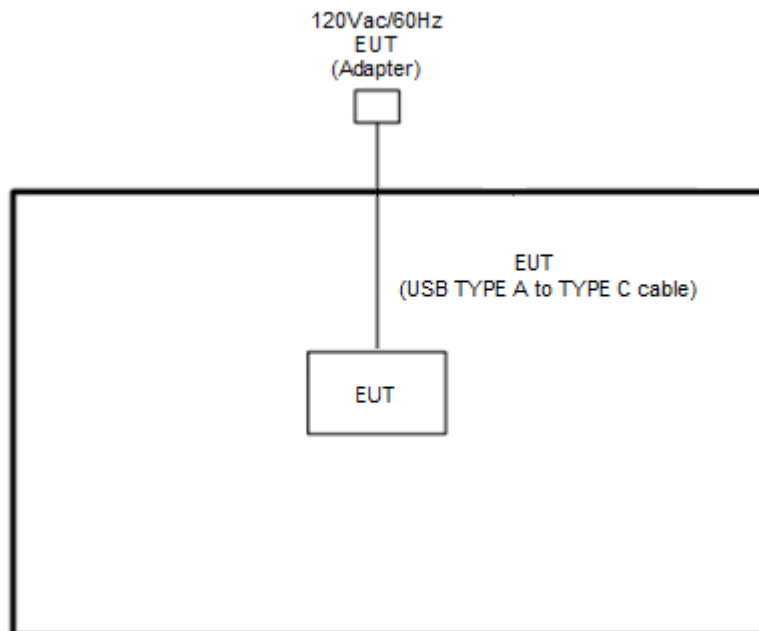



2.4 Support Unit used in test configuration and system

Item	Equipment	Brand Name	Model Name	FCC ID	Data Cable	Power Cord
1.	Bluetooth Earphone	Sony Ericsson	MW600	PY7DDA-2029	N/A	N/A
2.	WLAN AP	ASUS	RT-AC66U	MSQ-RTAC66U	N/A	Unshielded, 1.8m
3.	Notebook	Dell	Latitude 3420	FCC DoC	N/A	AC I/P: Unshielded, 1.2 m DC O/P: Shielded, 1.8 m
4.	SD Card	SanDisk	MicroSD HC	FCC DoC	N/A	N/A

2.5 EUT Operation Test Setup

The RF test items, utility “QRCT Version 4.0.211.0” was installed in Notebook which was programmed in order to make the EUT get into the engineering modes to provide channel selection, power level, data rate and the application type and for continuous transmitting signals.

2.6 Measurement Results Explanation Example

For all conducted test items:

The offset level is set in the spectrum analyzer to compensate the RF cable loss and attenuator factor between EUT conducted output port and spectrum analyzer. With the offset compensation, the spectrum analyzer reading level is exactly the EUT RF output level.

Example :

The spectrum analyzer offset is derived from RF cable loss and attenuator factor.

Offset = RF cable loss + attenuator factor.

Following shows an offset computation example with cable loss 4.2 dB and 10 dB attenuator.

$$\begin{aligned} \text{Offset(dB)} &= \text{RF cable loss(dB)} + \text{attenuator factor(dB)}. \\ &= 4.2 + 10 = 14.2 \text{ (dB)} \end{aligned}$$

3 Test Result

3.1 6dB and 99% Bandwidth Measurement

3.1.1 Limit of 6dB and 99% Bandwidth

The minimum 6 dB bandwidth shall be at least 500 kHz.

3.1.2 Measuring Instruments

Please refer to the measuring equipment list in this test report.

3.1.3 Test Procedures

1. The testing follows the ANSI C63.10 Section 6.9.3 (OBW) and 11.8.1 (6dB BW).
2. The RF output of EUT is connected to the spectrum analyzer by RF cable and attenuator. The path loss is compensated to the results for each measurement.
3. Set the maximum power setting and enable the EUT to transmit continuously.
4. Make the measurement with the spectrum analyzer's resolution bandwidth (RBW) = 100 kHz. Set the Video bandwidth (VBW) = 300 kHz. In order to make an accurate measurement. The 6dB bandwidth must be greater than 500 kHz.
5. For 99% Bandwidth Measurement, the spectrum analyzer's resolution bandwidth (RBW) is set 1-5% of the emission bandwidth and set the Video bandwidth (VBW) $\geq 3 * RBW$.
6. Measure and record the results in the test report.

3.1.4 Test Setup



3.1.5 Test Result of 6dB Bandwidth

Please refer to Appendix A.

3.1.6 Test Result of 99% Occupied Bandwidth

Please refer to Appendix A.

3.2 Output Power Measurement

3.2.1 Limit of Output Power

For systems using digital modulation in the 2400-2483.5 MHz, the limit for output power is 30 dBm. If transmitting antenna of directional gain greater than 6 dBi is used, the peak output power from the intentional radiator shall be reduced below the above stated value by the amount in dB that the directional gain of the antenna exceeds 6 dBi. In case of point-to-point operation, the limit has to be reduced by 1 dB for every 3 dB that the directional gain of the antenna exceeds 6 dBi.

3.2.2 Measuring Instruments

Please refer to the measuring equipment list in this test report.

3.2.3 Test Procedures

1. For Average Power, the testing follows ANSI C63.10 Section 11.9.2.3.2 Method AVGPM-G
2. The RF output of EUT is connected to the power meter by RF cable and attenuator.
3. The path loss is compensated to the results for each measurement.
4. Set the maximum power setting and enable the EUT to transmit continuously.
5. Measure the conducted output power and record the results in the test report.

3.2.4 Test Setup

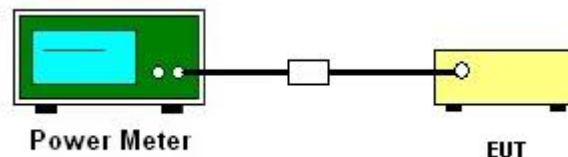

3.2.5 Test Result of Average Output Power

Please refer to Appendix A.

3.3 Power Spectral Density Measurement

3.3.1 Limit of Power Spectral Density

The peak power spectral density shall not be greater than 8 dBm in any 3 kHz band at any time interval of continuous transmission.

3.3.2 Measuring Instruments

Please refer to the measuring equipment list in this test report.

3.3.3 Test Procedures

1. The testing follows the ANSI C63.10 Section 11.10.2 Method PKPSD.
2. The RF output of EUT is connected to the spectrum analyzer by RF cable and attenuator. The path loss is compensated to the results for each measurement.
3. Set the maximum power setting and enable the EUT to transmit continuously.
4. Make the measurement with the spectrum analyzer's resolution bandwidth (RBW) = 3 kHz. Video bandwidth (VBW) = 10 kHz. In order to make an accurate measurement, set the span to 1.5 times DTS Channel Bandwidth. (6 dB BW)
5. Detector = peak, Sweep time = auto couple, Trace mode = max hold, Allow trace to fully stabilize. Use the peak marker function to determine the maximum power level.
6. Measure and record the results in the test report.
7. The Measured power density (dBm)/ 100 kHz is a reference level and is used as 20 dBc down limit line for Conducted Band Edges and Conducted Spurious Emission.

3.3.4 Test Setup



3.3.5 Test Result of Power Spectral Density

Please refer to Appendix A.

3.4 Conducted Band Edges and Spurious Emission Measurement

3.4.1 Limit of Conducted Band Edges and Spurious Emission

All harmonics/spurious must be at least 30 dB down from the highest emission level within the authorized band.

3.4.2 Measuring Instruments

Please refer to the measuring equipment list in this test report.

3.4.3 Test Procedure

1. The testing follows the ANSI C63.10 Section 11.11.3 Emission level measurement.
2. The RF output of EUT is connected to the spectrum analyzer by RF cable and attenuator. The path loss is compensated to the results for each measurement.
3. Set the maximum power setting and enable the EUT to transmit continuously.
4. Set RBW = 100 kHz, VBW = 300 kHz, Peak Detector. Unwanted Emissions measured in any 100 kHz bandwidth outside of the authorized frequency band shall be attenuated by at least 20 dB relative to the maximum in-band peak PSD level in 100 kHz when maximum peak conducted output power procedure is used. If the transmitter complies with the conducted power limits based on the use of RMS averaging over a time interval, the attenuation required under this paragraph shall be 30 dB instead of 20 dB.
5. Measure and record the results in the test report.
6. The RF fundamental frequency should be excluded against the limit line in the operating frequency band.

3.4.4 Test Setup

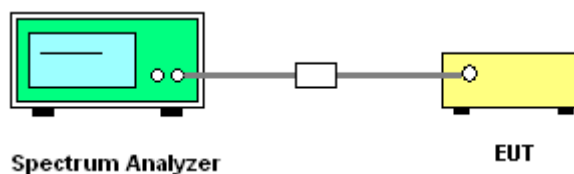

3.4.5 Test Result of Conducted Band Edges Plots

Please refer to Appendix A.

3.4.6 Test Result of Conducted Spurious Emission Plots

Please refer to Appendix A.



3.5 Radiated Band Edges and Spurious Emission Measurement

3.5.1 Limit of Radiated Band Edges and Spurious Emission

In any 100 kHz bandwidth outside the intentional radiator frequency band, all harmonics/spurious must be at least 20 dB below the highest emission level within the authorized band. If the output power of this device is measured by spectrum analyzer, the attenuation under this paragraph shall be 30 dB instead of 20 dB. In addition, radiated emissions which fall in the restricted bands must also comply with the limits as below.

Frequency (MHz)	Field Strength (microvolts/meter)	Measurement Distance (meters)
0.009 – 0.490	2400/F(kHz)	300
0.490 – 1.705	24000/F(kHz)	30
1.705 – 30.0	30	30
30 – 88	100	3
88 – 216	150	3
216 - 960	200	3
Above 960	500	3

3.5.2 Measuring Instruments

Please refer to the measuring equipment list in this test report.



3.5.3 Test Procedures

1. The testing follows the ANSI C63.10 Section 11.12.1 Radiated emission measurements.
2. The EUT is arranged to its worst case and then tune the antenna tower (from 1 m to 4 m) and turntable (from 0 degree to 360 degrees) to find the maximum reading. A pre-amp and a high pass filter are used for the test in order to get better signal level.
3. The EUT is placed on a turntable with 0.8 meter for frequency below 1 GHz and 1.5 meter for frequency above 1 GHz respectively above ground.
4. The EUT is set 3 meters away from the receiving antenna, which is mounted on the top of a variable height antenna tower.
5. Corrected Reading: Antenna Factor + Cable Loss + Read Level - Preamp Factor = Level
6. Radiated testing below 1 GHz is performed by adjusting the antenna tower from 1 m to 4 m and by rotating the turn table from 0 degree to 360 degrees to find the peak maximum hold reading. When there is no suspected emission found and the emission level is with at least 6 dB margin against QP limit line, the position is marked as “-“.
7. Radiated testing above 1 GHz is performed by adjusting the antenna tower from 1 m to 4 m and by rotating the turn table from 0 degree to 360 degrees to find the peak maximum hold reading for scanning all frequencies. When there is no suspected emission found and the harmonic emission level is with at least 6 dB margin against average limit line, the position is marked as “-“.
8. Use the following spectrum analyzer settings:
 - (1) Span shall wide enough to fully capture the emission being measured;
 - (2) Set RBW = 100 kHz for $f < 1$ GHz; VBW \geq RBW; Sweep = auto; Detector function = peak; Trace = max hold;
 - (3) Set RBW = 1 MHz, VBW = 3 MHz for $f \geq 1$ GHz for peak measurement.
For average measurement:
 - VBW = 10 Hz, when duty cycle is no less than 98 percent.
 - VBW $\geq 1/T$, when duty cycle is less than 98 percent where T is the minimum transmission duration over which the transmitter is on and is transmitting at its maximum power control level for the tested mode of operation.

3.5.4 Test Setup

For radiated test below 30MHz

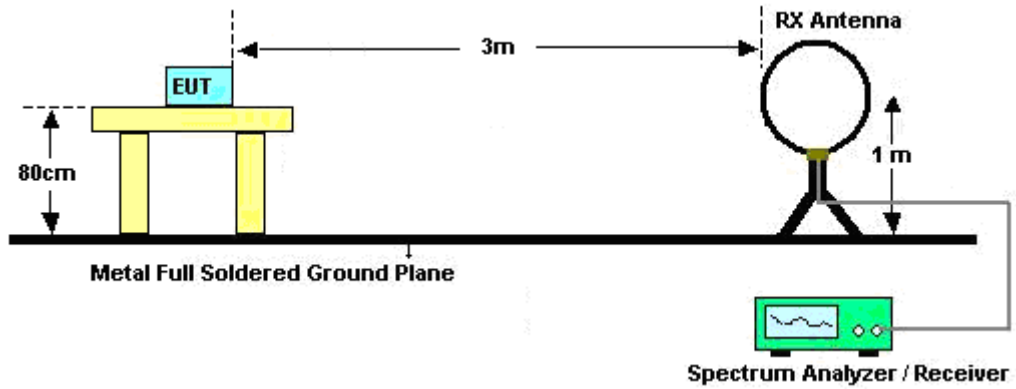

For radiated test from 30MHz to 1GHz

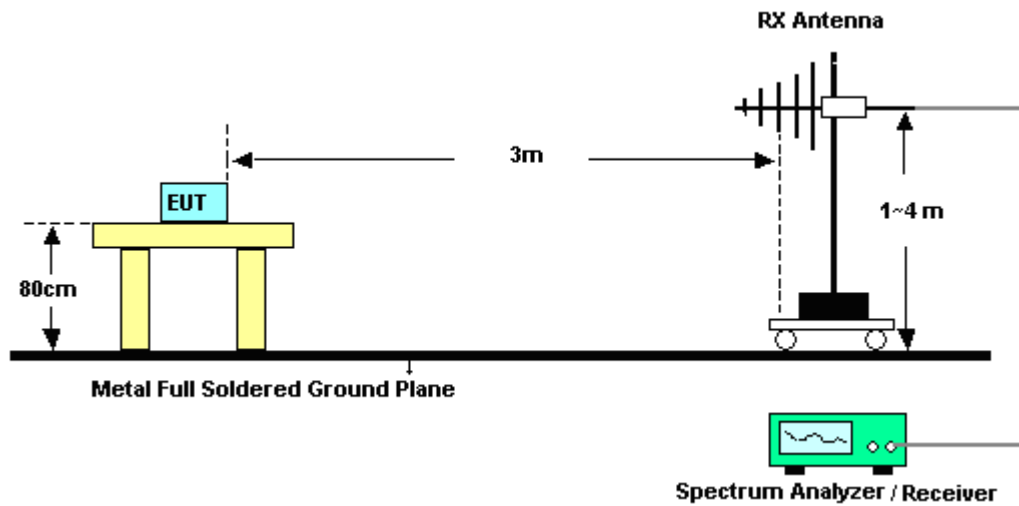

For radiated test from 1GHz to 18GHz

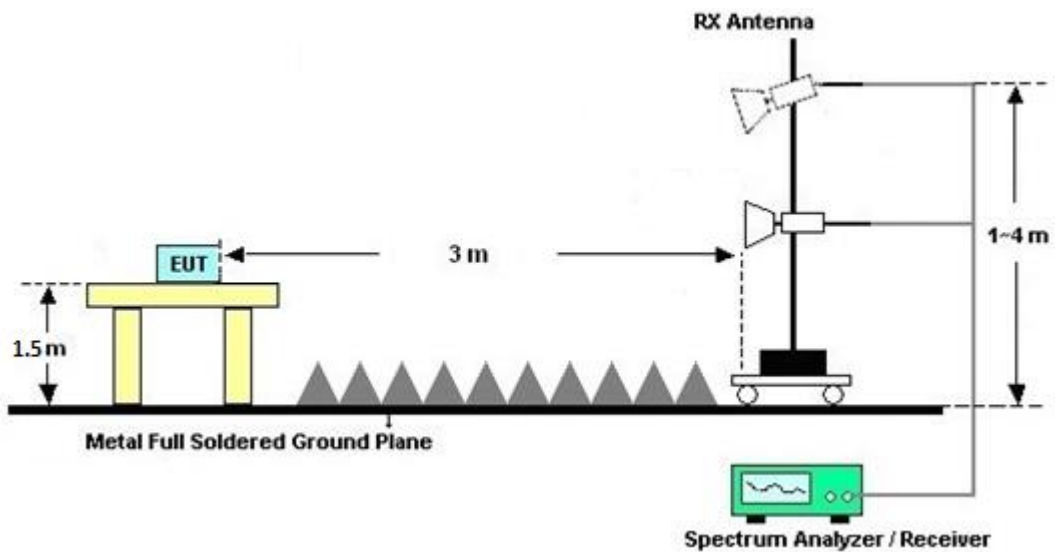

For radiated test above 18GHz

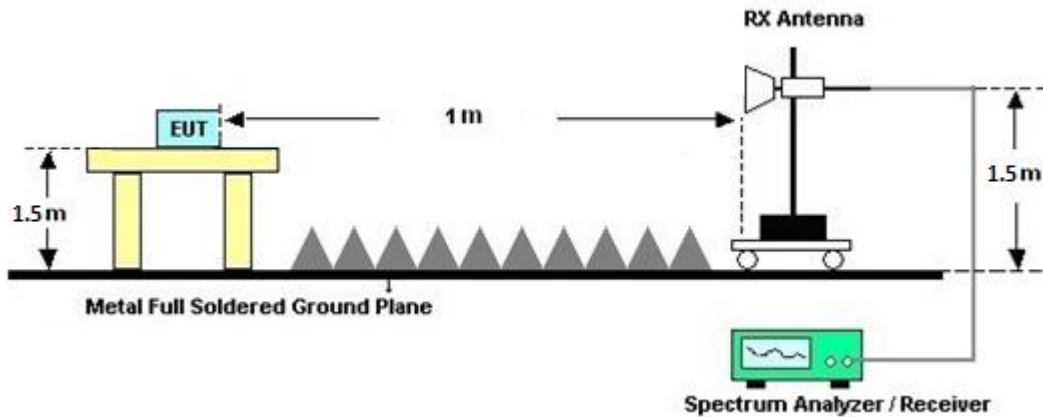

3.5.5 Test Results of Radiated Spurious Emissions (9 kHz ~ 30 MHz)

The low frequency, which starts from 9 kHz to 30 MHz, is pre-scanned and the result which is 20 dB lower than the limit line is not reported.

There is adequate comparison measurement of both open-field test site and alternative test site - semi-Anechoic chamber according to 414788 D01 Radiated Test Site v01r01, and the result comes out very similar.

3.5.6 Test Result of Radiated Spurious at Band Edges

Please refer to Appendix C and D.

3.5.7 Duty Cycle

Please refer to Appendix E.

3.5.8 Test Result of Radiated Spurious Emission (30 MHz ~ 10th Harmonic)

Please refer to Appendix C and D.



3.6 AC Conducted Emission Measurement

3.6.1 Limit of AC Conducted Emission

For equipment that is designed to be connected to the public utility (AC) power line, the radio frequency voltage that is conducted back onto the AC power line on any frequency or frequencies within the band 150 kHz to 30 MHz shall not exceed the limits in the following table.

Frequency of emission (MHz)	Conducted limit (dB μ V)	
	Quasi-peak	Average
0.15-0.5	66 to 56*	56 to 46*
0.5-5	56	46
5-30	60	50

*Decreases with the logarithm of the frequency.

3.6.2 Measuring Instruments

Please refer to the measuring equipment list in this test report.

3.6.3 Test Procedures

1. The EUT is placed 0.4 meter away from the conducting wall of the shielding room, and is kept at least 80 centimeters from any other grounded conducting surface.
2. Connect EUT to the power mains through a line impedance stabilization network (LISN).
3. All the support units are connecting to the other LISN.
4. The LISN provides 50 ohm coupling impedance for the measuring instrument.
5. The FCC states that a 50 ohm, 50 microhenry LISN shall be used.
6. Both Line and Neutral shall be tested in order to find out the maximum conducted emission.
7. The frequency range from 150 kHz to 30 MHz is scanned.
8. Set the test-receiver system to Peak Detect Function and specified bandwidth (IF Bandwidth = 9 kHz) with Maximum Hold Mode. Then measurement is also conducted by Average Detector and Quasi-Peak Detector Function respectively.

3.6.4 Test Setup

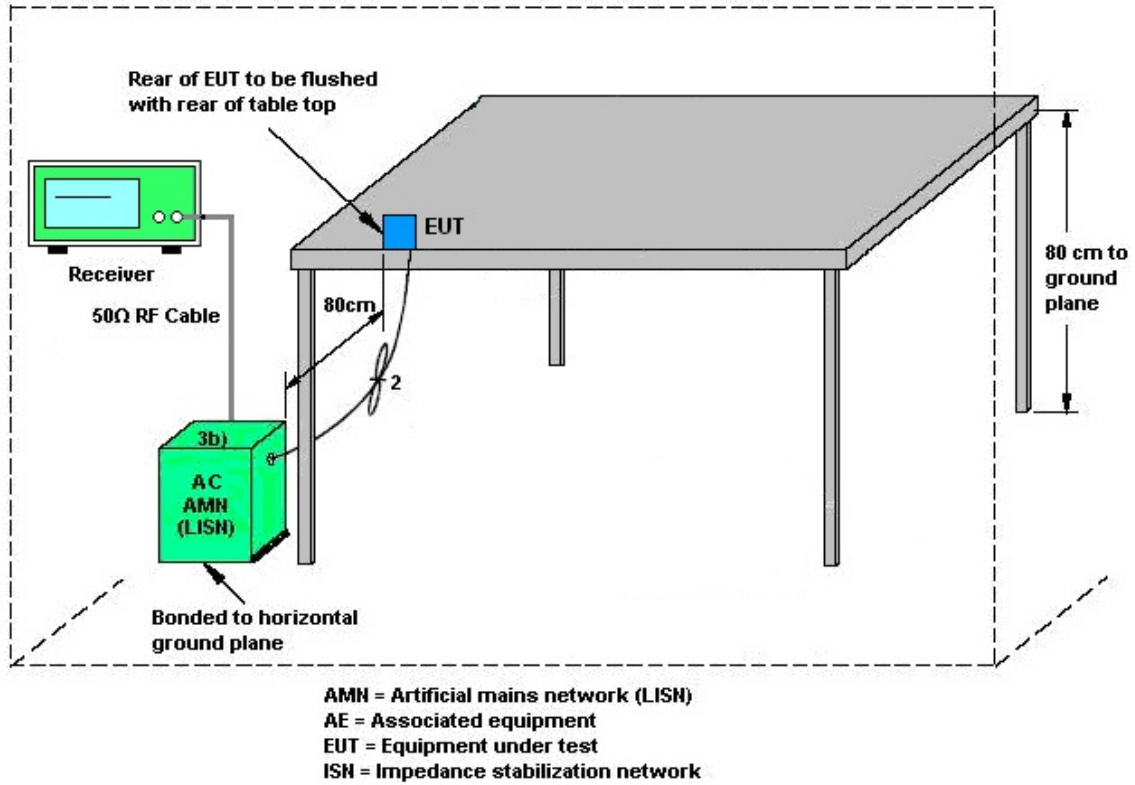

3.6.5 Test Result of AC Conducted Emission

Please refer to Appendix B.



3.7 Antenna Requirements

3.7.1 Standard Applicable

The use of a permanently attached antenna or of an antenna that uses a unique coupling to the intentional radiator shall be considered sufficient to comply with the rule.

3.7.2 Antenna Anti-Replacement Construction

An embedded-in antenna design is used.



4 List of Measuring Equipment

Instrument	Brand Name	Model No.	Serial No.	Characteristics	Calibration Date	Test Date	Due Date	Remark
EMI Test Receiver	Keysight	N9038A(MXE)	MY54130085	N/A	Oct. 06, 2023	Feb. 11, 2024~ Apr. 16, 2024	Oct. 05, 2024	Radiation (03CH20-HY)
Loop Antenna	Rohde & Schwarz	HFH2-Z2	100488	9 kHz~30 MHz	Sep. 12, 2023	Feb. 11, 2024~ Apr. 16, 2024	Sep. 11, 2024	Radiation (03CH20-HY)
Preamplifier	EMEC	EM18G40G	060801	18GHz~40GHz	Jun. 27, 2023	Feb. 11, 2024~ Apr. 16, 2024	Jun. 26, 2024	Radiation (03CH20-HY)
Controller	ChainTek	3000-1	N/A	Control Turn table & Ant Mast	N/A	Feb. 11, 2024~ Apr. 16, 2024	N/A	Radiation (03CH20-HY)
Antenna Mast	ChainTek	MBS-520-1	N/A	1m~4m	N/A	Feb. 11, 2024~ Apr. 16, 2024	N/A	Radiation (03CH20-HY)
Turn Table	ChainTek	T-200-S-1	N/A	0~360 Degree	N/A	Feb. 11, 2024~ Apr. 16, 2024	N/A	Radiation (03CH20-HY)
Signal Analyzer	Keysight	N9010B	MY60240520	N/A	Dec. 12, 2023	Feb. 11, 2024~ Apr. 16, 2024	Dec. 11, 2024	Radiation (03CH20-HY)
Bilog Antenna	TESEQ	CBL 6111D&00802N 1D01N-06	55606 & 08	30MHz~1GHz	Oct. 20, 2023	Feb. 11, 2024~ Apr. 16, 2024	Oct. 19, 2024	Radiation (03CH20-HY)
Horn Antenna	SCHWARZBE CK	BBHA 9120 D	02360	1GHz-18GHz	Oct. 30, 2023	Feb. 11, 2024~ Apr. 16, 2024	Oct. 29, 2024	Radiation (03CH20-HY)
SHF-EHF Horn Antenna	SCHWARZBE CK	BBHA 9170	1224	18GHz-40GHz	Jul. 10, 2023	Feb. 11, 2024~ Apr. 16, 2024	Jul. 09, 2024	Radiation (03CH20-HY)
Preamplifier	COM-POWER	PAM-103	18020201	1MHz-1000MHz	Jan. 01, 2024	Feb. 11, 2024~ Apr. 16, 2024	Dec. 31, 2024	Radiation (03CH20-HY)
Amplifier	EMCI	EMC118A45SE	980792	N/A	Nov. 13, 2023	Feb. 11, 2024~ Apr. 16, 2024	Nov. 12, 2024	Radiation (03CH20-HY)
RF Cable	HUBER + SUHNER	SUCOFLEX 102	519229/2,8040 15/2,804027/2	N/A	Jan. 17, 2024	Feb. 11, 2024~ Apr. 16, 2024	Jan. 16, 2025	Radiation (03CH20-HY)
Hygrometer	TECPEL	DTM-303B	TP200728	N/A	Mar. 28, 2023	Feb. 11, 2024~ Mar. 26, 2024	Mar. 27, 2024	Radiation (03CH20-HY)
Hygrometer	TECPEL	DTM-303A	TP211382	N/A	Mar. 27, 2024	Mar. 27, 2024~ Apr. 16, 2024	Mar. 26, 2025	Radiation (03CH20-HY)
Software	Audix	N/A	RK-002156	N/A	N/A	Feb. 11, 2024~ Apr. 16, 2024	N/A	Radiation (03CH20-HY)
AC Power Source	ChainTek	APC-1000W	N/A	N/A	N/A	Feb. 02, 2024	N/A	Conduction (CO05-HY)
EMI Test Receiver	Rohde & Schwarz	ESR3	102388	9kHz~3.6GHz	Dec. 06, 2023	Feb. 02, 2024	Dec. 05, 2024	Conduction (CO05-HY)
Hygrometer	Testo	608-H1	34913912	N/A	Oct. 26, 2023	Feb. 02, 2024	Oct. 25, 2024	Conduction (CO05-HY)
LISN	Rohde & Schwarz	ENV216	100081	9kHz~30MHz	Nov. 22, 2023	Feb. 02, 2024	Nov. 21, 2024	Conduction (CO05-HY)
Software	Rohde & Schwarz	EMC32	N/A	N/A	N/A	Feb. 02, 2024	N/A	Conduction (CO05-HY)
ISN Cable	MVE	RG-400	200260	N/A	Dec. 28, 2023	Feb. 02, 2024	Dec. 27, 2024	Conduction (CO05-HY)
Pulse Limiter	SCHWARZBE CK	VTSD 9561-F N	00691	9kHz-200MHz	Jul. 28, 2023	Feb. 02, 2024	Jul. 27, 2024	Conduction (CO05-HY)
LISN Cable	MVE	RG-400	260260	N/A	Dec. 28, 2023	Feb. 02, 2024	Dec. 27, 2024	Conduction (CO05-HY)
Hygrometer	TECPEL	DTM-303A	TP201996	N/A	Nov. 07, 2023	Jan. 28, 2024~ Feb. 22, 2024	Nov. 06, 2024	Conducted (TH05-HY)
Power Sensor	DARE	RPR3006W	15100041SNO 10 (NO:248)	10MHz~6GHz	Jun. 05, 2023	Jan. 28, 2024~ Feb. 22, 2024	Jun. 04, 2024	Conducted (TH05-HY)
Signal Analyzer	Rohde & Schwarz	FSV40	101566	10Hz~40GHz	Aug. 23, 2023	Jan. 28, 2024~ Feb. 22, 2024	Aug. 22, 2024	Conducted (TH05-HY)



5 Measurement Uncertainty

Uncertainty of Conducted Emission Measurement (150 kHz ~ 30 MHz)

Measuring Uncertainty for a Level of Confidence of 95% ($U = 2Uc(y)$)	3.5 dB
-------------------------------------------------------------------------	--------

Uncertainty of Radiated Emission Measurement (30 MHz ~ 1000 MHz)

Measuring Uncertainty for a Level of Confidence of 95% ($U = 2Uc(y)$)	6.4 dB
-------------------------------------------------------------------------	--------

Uncertainty of Radiated Emission Measurement (1000 MHz ~ 6000 MHz)

Measuring Uncertainty for a Level of Confidence of 95% ($U = 2Uc(y)$)	4.5 dB
-------------------------------------------------------------------------	--------

Uncertainty of Radiated Emission Measurement (6000 MHz ~ 18000 MHz)

Measuring Uncertainty for a Level of Confidence of 95% ($U = 2Uc(y)$)	4.6 dB
-------------------------------------------------------------------------	--------

Uncertainty of Radiated Emission Measurement (18000 MHz ~ 40000 MHz)

Measuring Uncertainty for a Level of Confidence of 95% ($U = 2Uc(y)$)	5.4 dB
-------------------------------------------------------------------------	--------

Appendix A. Test Result of Conducted Test Items

Test Engineer:	Sylvia Li	Temperature:	21~25	°C
Test Date:	2024/01/28~2024/02/22	Relative Humidity:	51~54	%

<Class 1>

<Ant. 6>

TEST RESULTS DATA
6dB and 99% Occupied Bandwidth

Mod.	Data Rate	NTX	CH.	Freq. (MHz)	99% Occupied BW (MHz)	6dB BW (MHz)	6dB BW Limit (MHz)	Pass/Fail
BLE	1Mbps	1	0	2402	1.021	0.670	0.50	Pass
BLE	1Mbps	1	19	2440	1.017	0.673	0.50	Pass
BLE	1Mbps	1	39	2480	1.029	0.668	0.50	Pass

TEST RESULTS DATA
Average Power Table

Mod.	Data Rate	NTX	CH.	Freq. (MHz)	Average Conducted Power (dBm)	Conducted Power Limit (dBm)	DG (dBi)	EIRP Power (dBm)	EIRP Power Limit (dBm)	Pass /Fail
BLE	1Mbps	1	0	2402	5.80	30.00	2.32	8.12	36.00	Pass
BLE	1Mbps	1	19	2440	5.90	30.00	2.32	8.22	36.00	Pass
BLE	1Mbps	1	39	2480	5.50	30.00	2.32	7.82	36.00	Pass

TEST RESULTS DATA
Peak Power Density

Mod.	Data Rate	NTX	CH.	Freq. (MHz)	Peak PSD (dBm /100kHz)	Peak PSD (dBm /3kHz)	DG (dBi)	Peak PSD Limit (dBm /3kHz)	Pass/Fail
BLE	1Mbps	1	0	2402	5.41	-8.97	2.32	8.00	Pass
BLE	1Mbps	1	19	2440	5.34	-9.03	2.32	8.00	Pass
BLE	1Mbps	1	39	2480	5.21	-9.18	2.32	8.00	Pass

Note: PSD (dBm/ 100kHz) is a reference level used for Conducted Band Edges and Conducted Spurious Emission 30dBc limit.

TEST RESULTS DATA
6dB and 99% Occupied Bandwidth

Mod.	Data Rate	NTX	CH.	Freq. (MHz)	99% Occupied BW (MHz)	6dB BW (MHz)	6dB BW Limit (MHz)	Pass/Fail
BLE	2Mbps	1	0	2402	1.998	1.142	0.50	Pass
BLE	2Mbps	1	19	2440	1.994	1.141	0.50	Pass
BLE	2Mbps	1	39	2480	1.998	1.140	0.50	Pass

TEST RESULTS DATA
Average Power Table

Mod.	Data Rate	NTX	CH.	Freq. (MHz)	Average Conducted Power (dBm)	Conducted Power Limit (dBm)	DG (dBi)	EIRP Power (dBm)	EIRP Power Limit (dBm)	Pass /Fail
BLE	2Mbps	1	0	2402	5.80	30.00	2.32	8.12	36.00	Pass
BLE	2Mbps	1	19	2440	5.80	30.00	2.32	8.12	36.00	Pass
BLE	2Mbps	1	39	2480	5.50	30.00	2.32	7.82	36.00	Pass

TEST RESULTS DATA
Peak Power Density

Mod.	Data Rate	NTX	CH.	Freq. (MHz)	Peak PSD (dBm /100kHz)	Peak PSD (dBm /3kHz)	DG (dBi)	Peak PSD Limit (dBm /3kHz)	Pass/Fail
BLE	2Mbps	1	0	2402	5.44	-11.87	2.32	8.00	Pass
BLE	2Mbps	1	19	2440	5.36	-11.93	2.32	8.00	Pass
BLE	2Mbps	1	39	2480	5.22	-12.02	2.32	8.00	Pass

Note: PSD (dBm/ 100kHz) is a reference level used for Conducted Band Edges and Conducted Spurious Emission 30dBc limit.

<Ant. 7>

TEST RESULTS DATA
6dB and 99% Occupied Bandwidth

Mod.	Data Rate	NTX	CH.	Freq. (MHz)	99% Occupied BW (MHz)	6dB BW (MHz)	6dB BW Limit (MHz)	Pass/Fail
BLE	1Mbps	1	0	2402	1.017	0.689	0.50	Pass
BLE	1Mbps	1	19	2440	1.017	0.673	0.50	Pass
BLE	1Mbps	1	39	2480	1.019	0.667	0.50	Pass

TEST RESULTS DATA
Average Power Table

Mod.	Data Rate	NTX	CH.	Freq. (MHz)	Average Conducted Power (dBm)	Conducted Power Limit (dBm)	DG (dBi)	EIRP Power (dBm)	EIRP Power Limit (dBm)	Pass /Fail
BLE	1Mbps	1	0	2402	5.80	30.00	0.14	5.94	36.00	Pass
BLE	1Mbps	1	19	2440	6.30	30.00	0.14	6.44	36.00	Pass
BLE	1Mbps	1	39	2480	5.60	30.00	0.14	5.74	36.00	Pass

TEST RESULTS DATA
Peak Power Density

Mod.	Data Rate	NTX	CH.	Freq. (MHz)	Peak PSD (dBm /100kHz)	Peak PSD (dBm /3kHz)	DG (dBi)	Peak PSD Limit (dBm /3kHz)	Pass/Fail
BLE	1Mbps	1	0	2402	5.42	-8.99	0.14	8.00	Pass
BLE	1Mbps	1	19	2440	5.70	-8.64	0.14	8.00	Pass
BLE	1Mbps	1	39	2480	5.24	-9.14	0.14	8.00	Pass

Note: PSD (dBm/ 100kHz) is a reference level used for Conducted Band Edges and Conducted Spurious Emission 30dBc limit.

TEST RESULTS DATA
6dB and 99% Occupied Bandwidth

Mod.	Data Rate	NTX	CH.	Freq. (MHz)	99% Occupied BW (MHz)	6dB BW (MHz)	6dB BW Limit (MHz)	Pass/Fail
BLE	2Mbps	1	0	2402	1.998	1.136	0.50	Pass
BLE	2Mbps	1	19	2440	1.998	1.143	0.50	Pass
BLE	2Mbps	1	39	2480	1.994	1.146	0.50	Pass

TEST RESULTS DATA
Average Power Table

Mod.	Data Rate	NTX	CH.	Freq. (MHz)	Average Conducted Power (dBm)	Conducted Power Limit (dBm)	DG (dBi)	EIRP Power (dBm)	EIRP Power Limit (dBm)	Pass /Fail
BLE	2Mbps	1	0	2402	5.80	30.00	0.14	5.94	36.00	Pass
BLE	2Mbps	1	19	2440	6.30	30.00	0.14	6.44	36.00	Pass
BLE	2Mbps	1	39	2480	5.60	30.00	0.14	5.74	36.00	Pass

TEST RESULTS DATA
Peak Power Density

Mod.	Data Rate	NTX	CH.	Freq. (MHz)	Peak PSD (dBm /100kHz)	Peak PSD (dBm /3kHz)	DG (dBi)	Peak PSD Limit (dBm /3kHz)	Pass/Fail
BLE	2Mbps	1	0	2402	5.44	-11.95	0.14	8.00	Pass
BLE	2Mbps	1	19	2440	5.69	-11.69	0.14	8.00	Pass
BLE	2Mbps	1	39	2480	5.20	-12.18	0.14	8.00	Pass

Note: PSD (dBm/ 100kHz) is a reference level used for Conducted Band Edges and Conducted Spurious Emission 30dBc limit.

<Class 2>

<Ant. 6>

TEST RESULTS DATA
6dB and 99% Occupied Bandwidth

Mod.	Data Rate	NTX	CH.	Freq. (MHz)	99% Occupied BW (MHz)	6dB BW (MHz)	6dB BW Limit (MHz)	Pass/Fail
BLE	1Mbps	1	0	2402	1.015	0.672	0.50	Pass
BLE	1Mbps	1	19	2440	1.019	0.670	0.50	Pass
BLE	1Mbps	1	39	2480	1.019	0.669	0.50	Pass

TEST RESULTS DATA
Average Power Table

Mod.	Data Rate	NTX	CH.	Freq. (MHz)	Average Conducted Power (dBm)	Conducted Power Limit (dBm)	DG (dBi)	EIRP Power (dBm)	EIRP Power Limit (dBm)	Pass /Fail
BLE	1Mbps	1	0	2402	1.90	30.00	2.32	4.22	36.00	Pass
BLE	1Mbps	1	19	2440	1.60	30.00	2.32	3.92	36.00	Pass
BLE	1Mbps	1	39	2480	2.90	30.00	2.32	5.22	36.00	Pass

TEST RESULTS DATA
Peak Power Density

Mod.	Data Rate	NTX	CH.	Freq. (MHz)	Peak PSD (dBm /100kHz)	Peak PSD (dBm /3kHz)	DG (dBi)	Peak PSD Limit (dBm /3kHz)	Pass/Fail
BLE	1Mbps	1	0	2402	1.61	-12.85	2.32	8.00	Pass
BLE	1Mbps	1	19	2440	1.12	-13.22	2.32	8.00	Pass
BLE	1Mbps	1	39	2480	2.62	-11.73	2.32	8.00	Pass

Note: PSD (dBm/ 100kHz) is a reference level used for Conducted Band Edges and Conducted Spurious Emission 30dBc limit.

TEST RESULTS DATA
6dB and 99% Occupied Bandwidth

Mod.	Data Rate	NTX	CH.	Freq. (MHz)	99% Occupied BW (MHz)	6dB BW (MHz)	6dB BW Limit (MHz)	Pass/Fail
BLE	2Mbps	1	0	2402	2.006	1.144	0.50	Pass
BLE	2Mbps	1	19	2440	2.002	1.144	0.50	Pass
BLE	2Mbps	1	39	2480	1.998	1.146	0.50	Pass

TEST RESULTS DATA
Average Power Table

Mod.	Data Rate	NTX	CH.	Freq. (MHz)	Average Conducted Power (dBm)	Conducted Power Limit (dBm)	DG (dBi)	EIRP Power (dBm)	EIRP Power Limit (dBm)	Pass /Fail
BLE	2Mbps	1	0	2402	1.90	30.00	2.32	4.22	36.00	Pass
BLE	2Mbps	1	19	2440	1.60	30.00	2.32	3.92	36.00	Pass
BLE	2Mbps	1	39	2480	2.90	30.00	2.32	5.22	36.00	Pass

TEST RESULTS DATA
Peak Power Density

Mod.	Data Rate	NTX	CH.	Freq. (MHz)	Peak PSD (dBm /100kHz)	Peak PSD (dBm /3kHz)	DG (dBi)	Peak PSD Limit (dBm /3kHz)	Pass/Fail
BLE	2Mbps	1	0	2402	1.45	-16.94	2.32	8.00	Pass
BLE	2Mbps	1	19	2440	1.12	-16.21	2.32	8.00	Pass
BLE	2Mbps	1	39	2480	2.65	-14.69	2.32	8.00	Pass

Note: PSD (dBm/ 100kHz) is a reference level used for Conducted Band Edges and Conducted Spurious Emission 30dBc limit.

<Ant. 7>

TEST RESULTS DATA
6dB and 99% Occupied Bandwidth

Mod.	Data Rate	NTX	CH.	Freq. (MHz)	99% Occupied BW (MHz)	6dB BW (MHz)	6dB BW Limit (MHz)	Pass/Fail
BLE	1Mbps	1	0	2402	1.015	0.669	0.50	Pass
BLE	1Mbps	1	19	2440	1.019	0.674	0.50	Pass
BLE	1Mbps	1	39	2480	1.017	0.668	0.50	Pass

TEST RESULTS DATA
Average Power Table

Mod.	Data Rate	NTX	CH.	Freq. (MHz)	Average Conducted Power (dBm)	Conducted Power Limit (dBm)	DG (dBi)	EIRP Power (dBm)	EIRP Power Limit (dBm)	Pass /Fail
BLE	1Mbps	1	0	2402	1.80	30.00	0.14	1.94	36.00	Pass
BLE	1Mbps	1	19	2440	2.10	30.00	0.14	2.24	36.00	Pass
BLE	1Mbps	1	39	2480	3.00	30.00	0.14	3.14	36.00	Pass

TEST RESULTS DATA
Peak Power Density

Mod.	Data Rate	NTX	CH.	Freq. (MHz)	Peak PSD (dBm /100kHz)	Peak PSD (dBm /3kHz)	DG (dBi)	Peak PSD Limit (dBm /3kHz)	Pass/Fail
BLE	1Mbps	1	0	2402	1.34	-12.96	0.14	8.00	Pass
BLE	1Mbps	1	19	2440	1.54	-12.82	0.14	8.00	Pass
BLE	1Mbps	1	39	2480	2.57	-11.71	0.14	8.00	Pass

Note: PSD (dBm/ 100kHz) is a reference level used for Conducted Band Edges and Conducted Spurious Emission 30dBc limit.

TEST RESULTS DATA
6dB and 99% Occupied Bandwidth

Mod.	Data Rate	NTX	CH.	Freq. (MHz)	99% Occupied BW (MHz)	6dB BW (MHz)	6dB BW Limit (MHz)	Pass/Fail
BLE	2Mbps	1	0	2402	2.002	1.141	0.50	Pass
BLE	2Mbps	1	19	2440	2.002	1.148	0.50	Pass
BLE	2Mbps	1	39	2480	2.002	1.148	0.50	Pass

TEST RESULTS DATA
Average Power Table

Mod.	Data Rate	NTX	CH.	Freq. (MHz)	Average Conducted Power (dBm)	Conducted Power Limit (dBm)	DG (dBi)	EIRP Power (dBm)	EIRP Power Limit (dBm)	Pass /Fail
BLE	2Mbps	1	0	2402	1.70	30.00	0.14	1.84	36.00	Pass
BLE	2Mbps	1	19	2440	2.10	30.00	0.14	2.24	36.00	Pass
BLE	2Mbps	1	39	2480	3.10	30.00	0.14	3.24	36.00	Pass

TEST RESULTS DATA
Peak Power Density

Mod.	Data Rate	NTX	CH.	Freq. (MHz)	Peak PSD (dBm /100kHz)	Peak PSD (dBm /3kHz)	DG (dBi)	Peak PSD Limit (dBm /3kHz)	Pass/Fail
BLE	2Mbps	1	0	2402	1.33	-16.35	0.14	8.00	Pass
BLE	2Mbps	1	19	2440	1.50	-15.81	0.14	8.00	Pass
BLE	2Mbps	1	39	2480	2.68	-14.65	0.14	8.00	Pass

Note: PSD (dBm/ 100kHz) is a reference level used for Conducted Band Edges and Conducted Spurious Emission 30dBc limit.



<Class 1>

<Ant. 6>

6dB Bandwidth

<1Mbps>

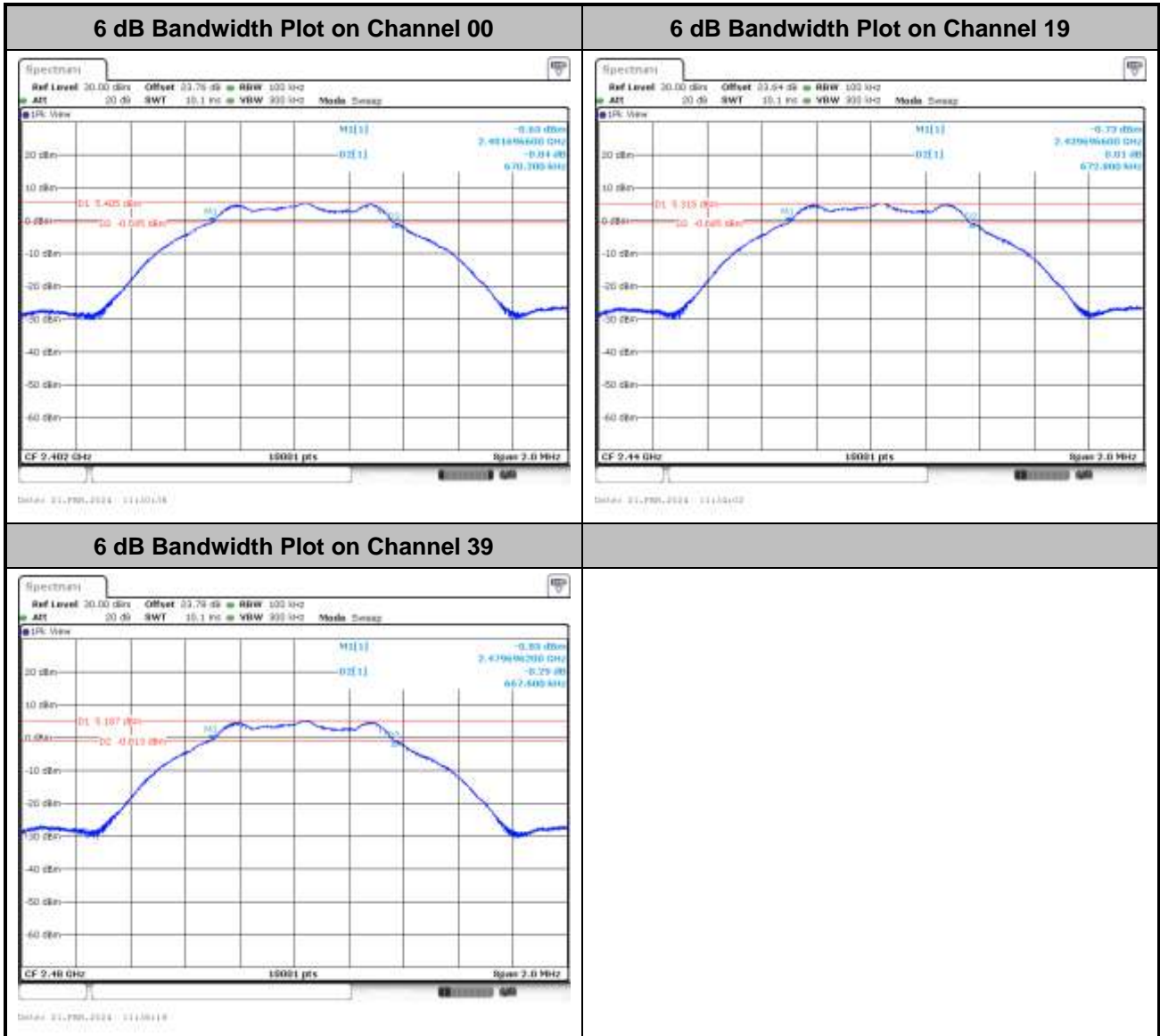



<2Mbps>

6 dB Bandwidth Plot on Channel 00

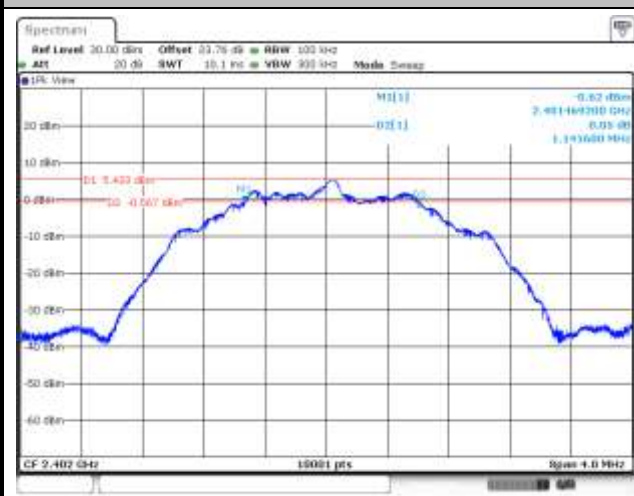

6 dB Bandwidth Plot on Channel 19

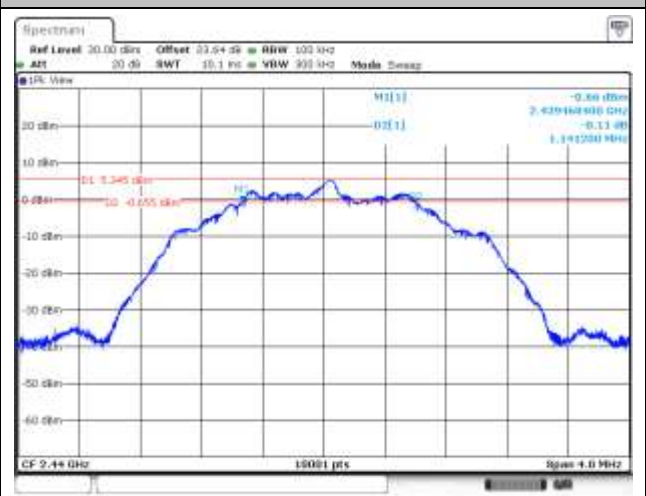

6 dB Bandwidth Plot on Channel 39

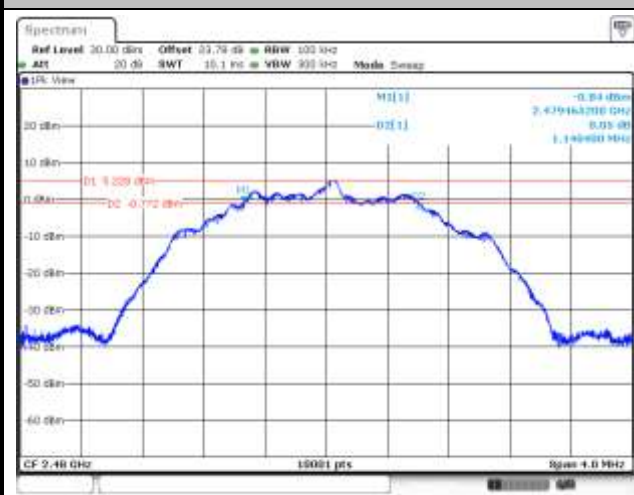



99% Occupied Bandwidth

<1Mbps>

99% Occupied Bandwidth Plot on Channel 00



99% Occupied Bandwidth Plot on Channel 19



99% Occupied Bandwidth Plot on Channel 39





<2Mbps>

99% Occupied Bandwidth Plot on Channel 00



99% Occupied Bandwidth Plot on Channel 19



99% Occupied Bandwidth Plot on Channel 39





Power Spectral Density (dBm/3kHz)

<1Mbps>

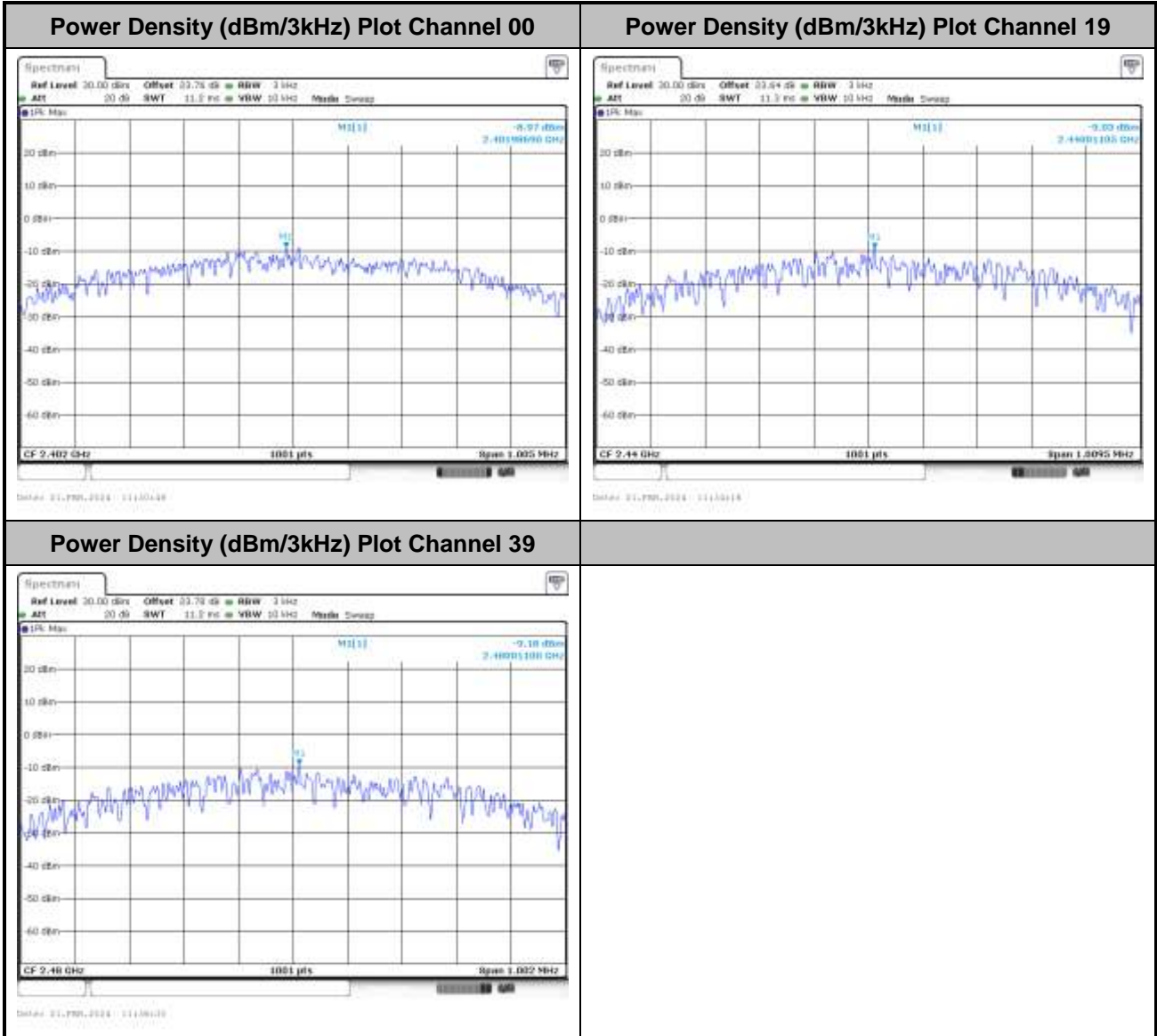



<2Mbps>

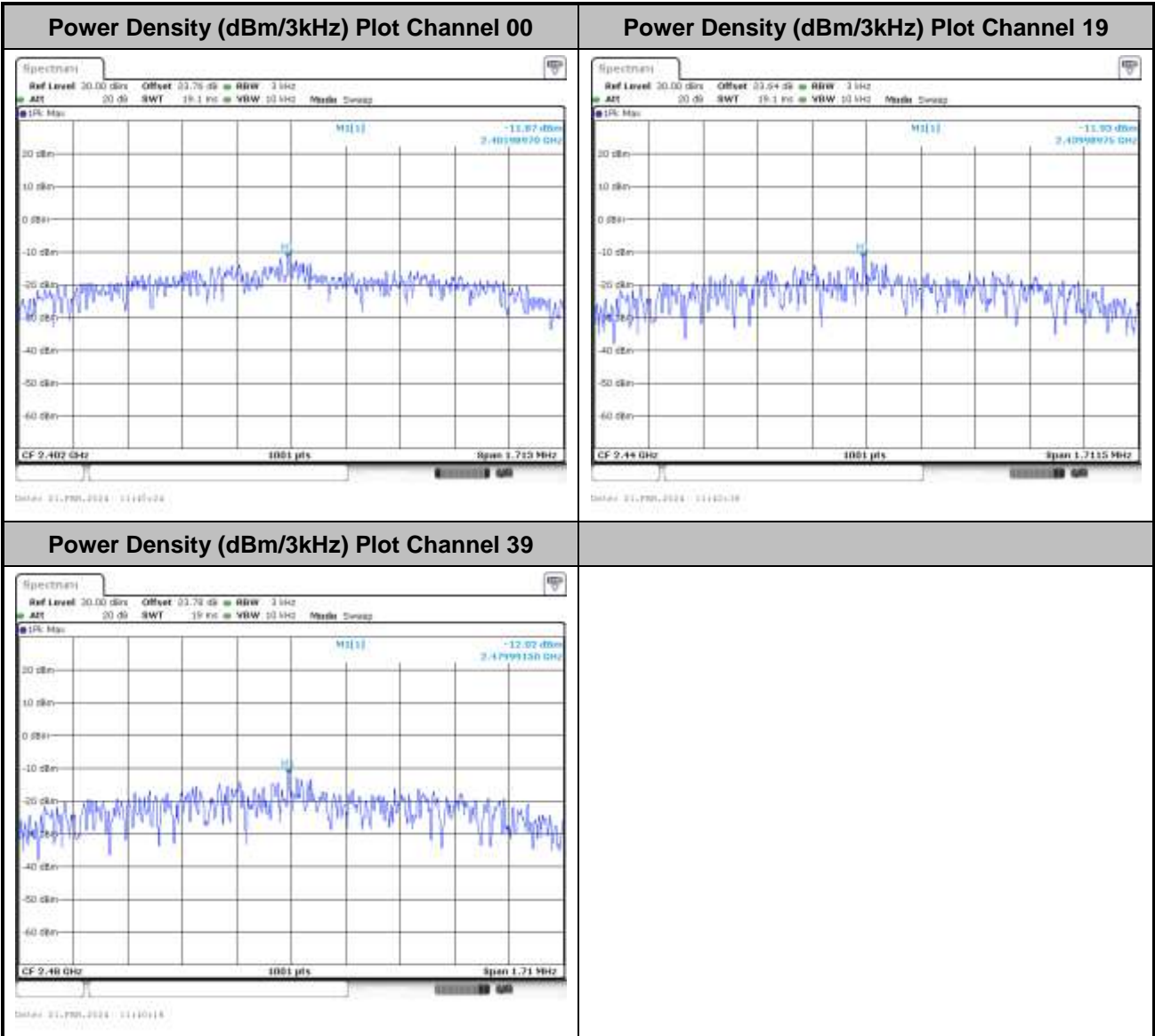



Band Edge and Conducted Spurious Emission

<1Mbps>

Channel 00

100kHz PSD reference Level Plot

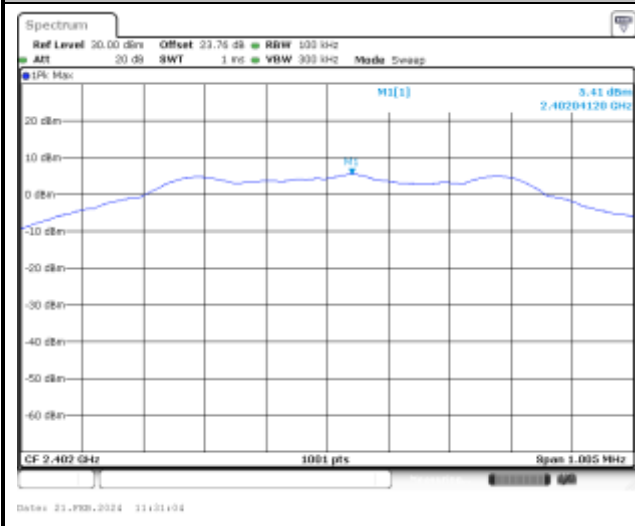

Low Channel Plot

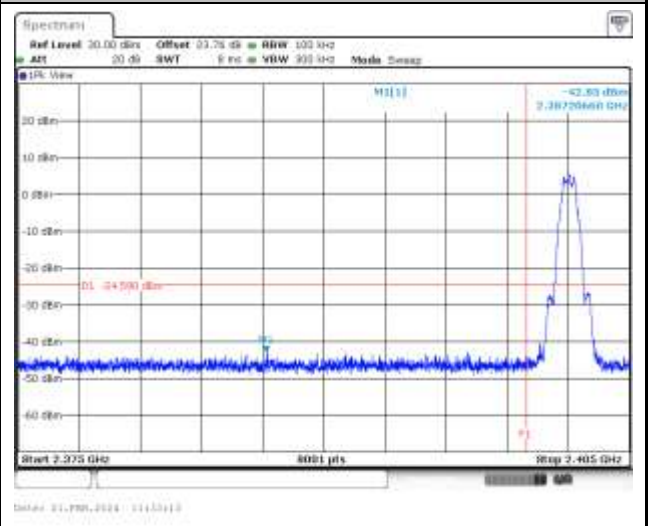

Spurious Emission 30MHz~1GHz Plot

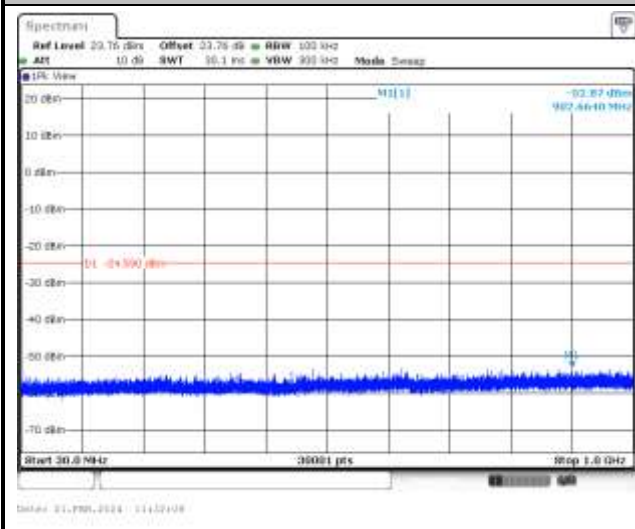

Spurious Emission 1GHz~26.5GHz Plot

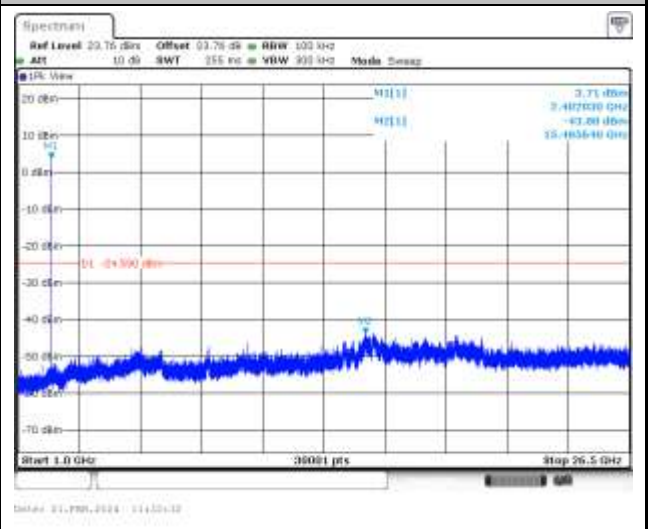



Channel 19

100kHz PSD reference Level Plot

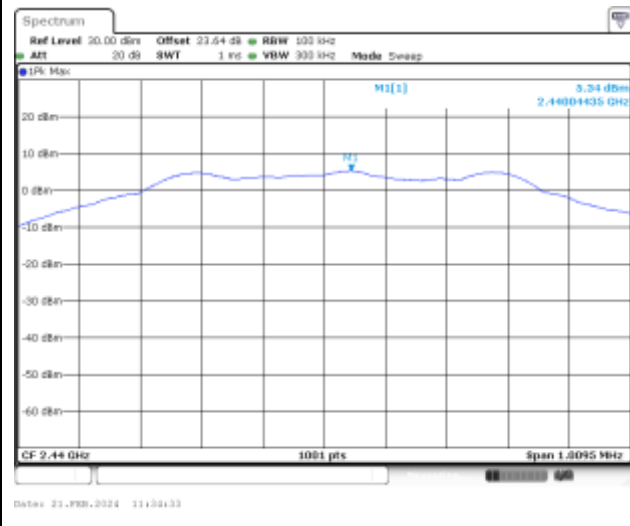

Mid Channel Plot



Spurious Emission 30MHz~1GHz Plot

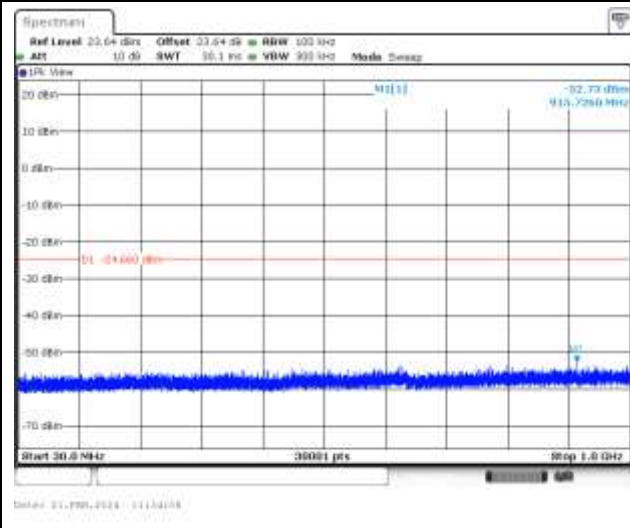

Spurious Emission 1GHz~26.5GHz Plot

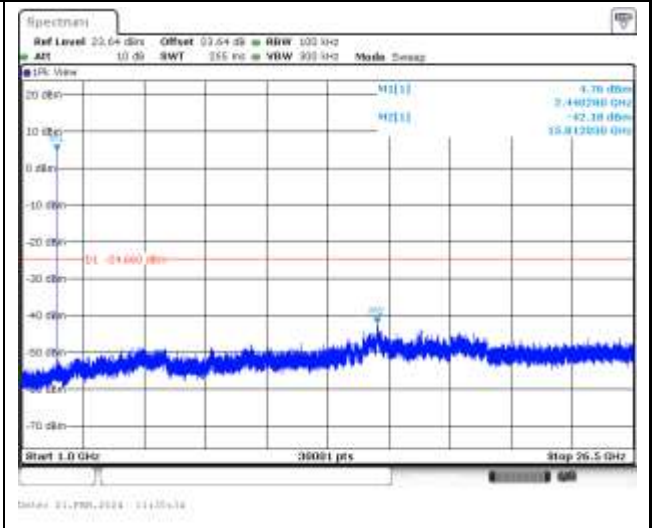



Channel 39

100kHz PSD reference Level Plot

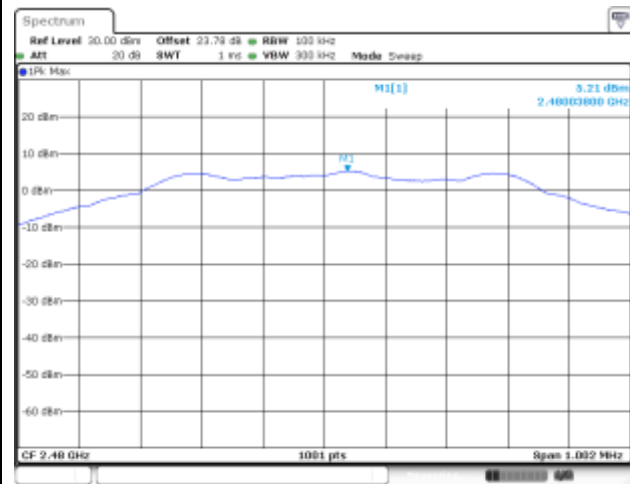

Date: 21-Feb-2024 11:36:58

High Channel Plot

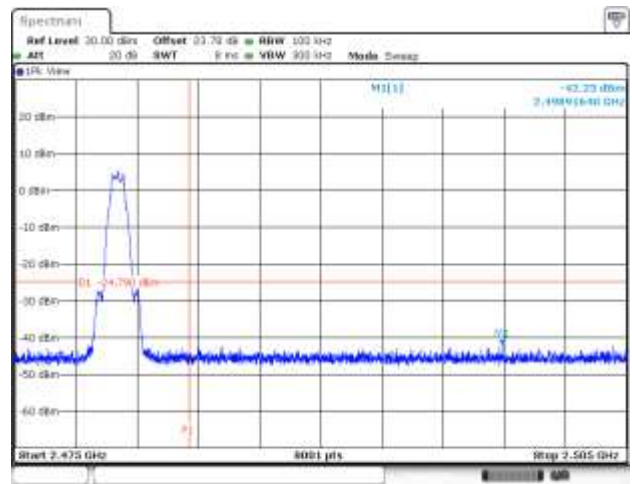

Date: 21-Feb-2024 11:39:00

Spurious Emission 30MHz~1GHz Plot

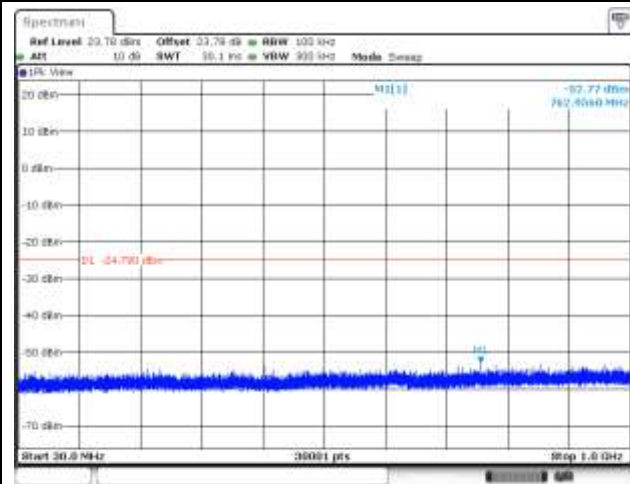

Date: 21-Feb-2024 11:37:07

Spurious Emission 1GHz~26.5GHz Plot

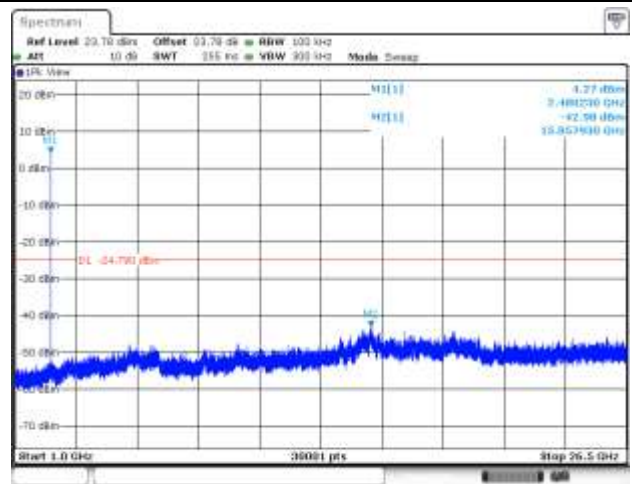

Date: 21-Feb-2024 11:37:20



<2Mbps>

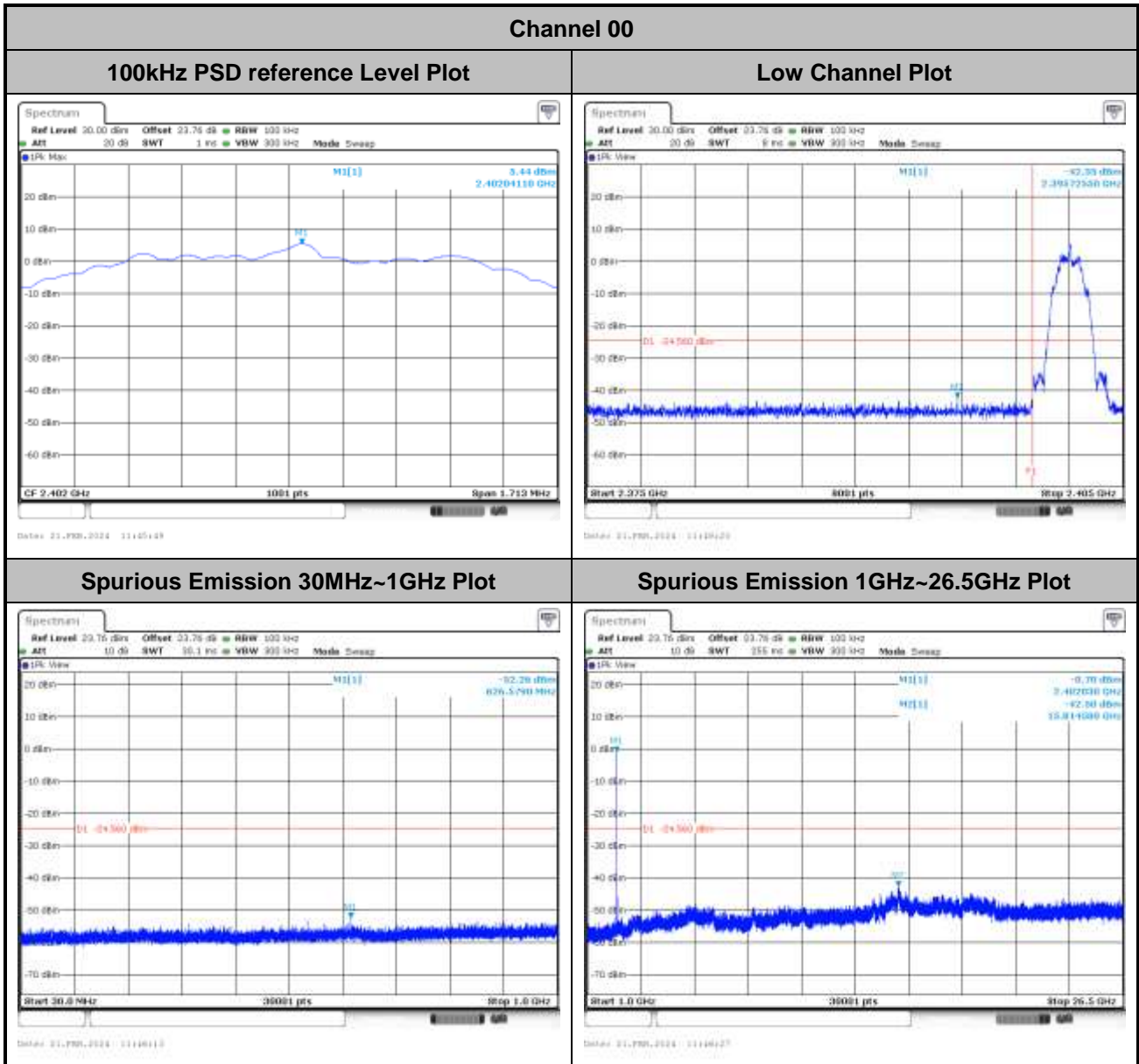



Channel 19

100kHz PSD reference Level Plot

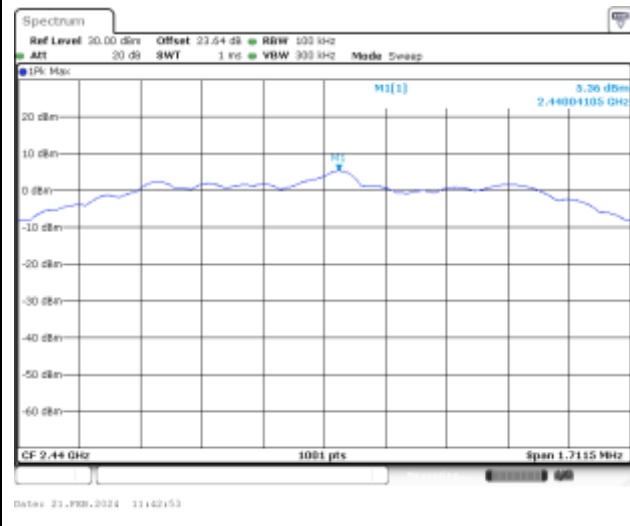

Mid Channel Plot



Spurious Emission 30MHz~1GHz Plot

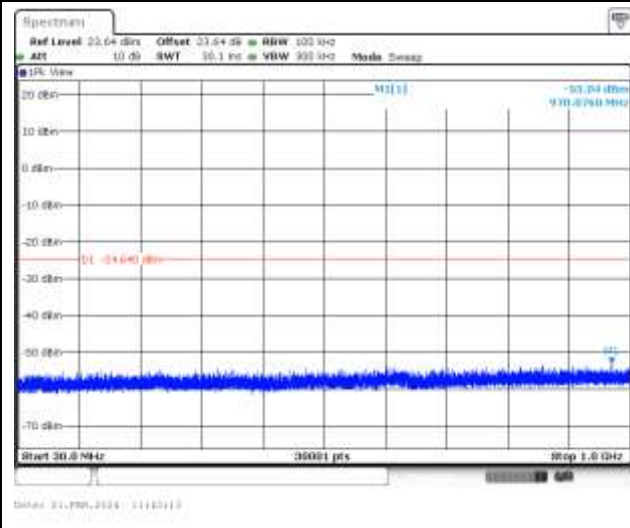

Spurious Emission 1GHz~26.5GHz Plot

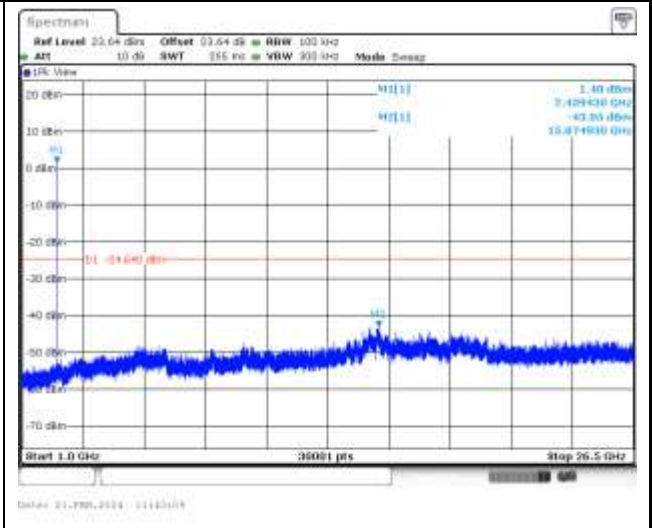



Channel 39

100kHz PSD reference Level Plot

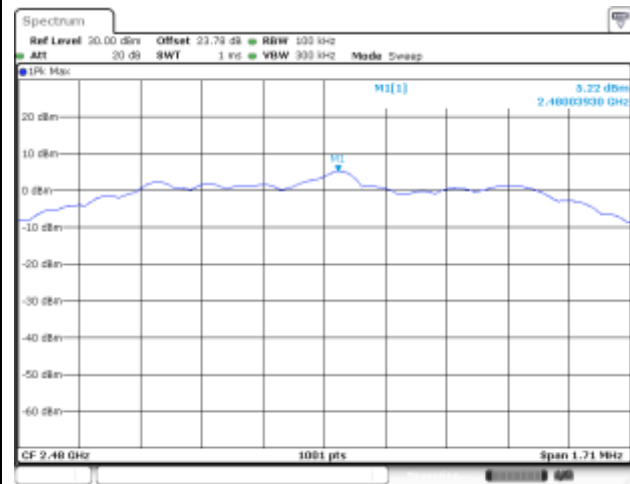

High Channel Plot

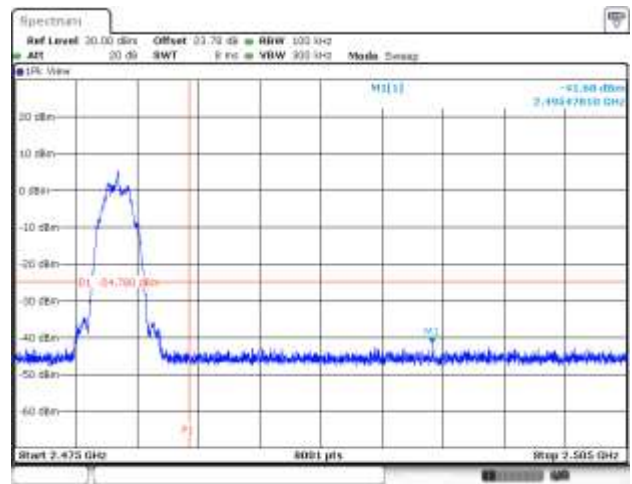

Spurious Emission 30MHz~1GHz Plot

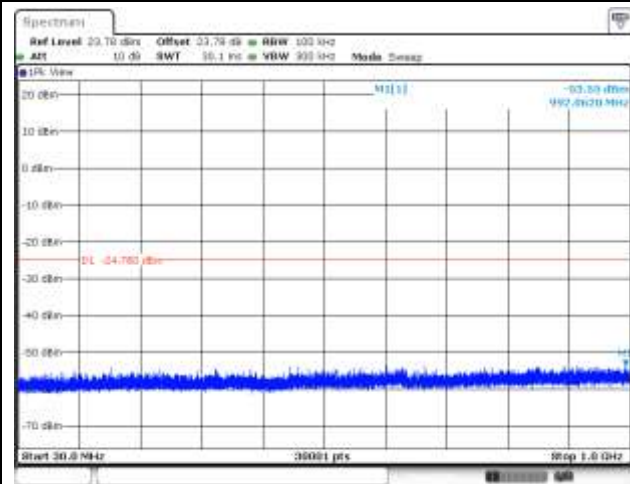

Spurious Emission 1GHz~26.5GHz Plot

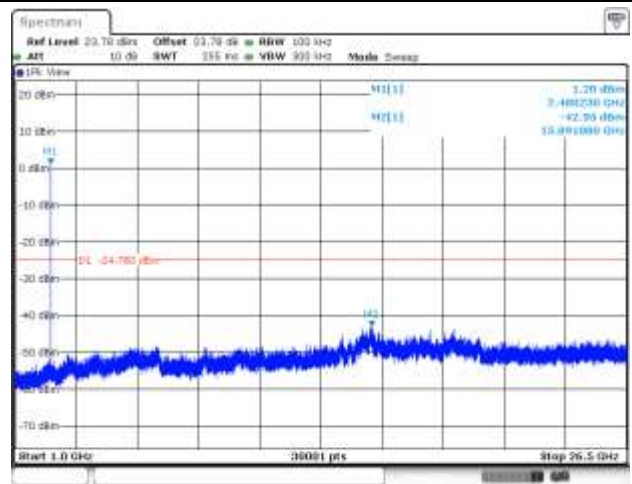



<Ant. 7>

6dB Bandwidth

<1Mbps>

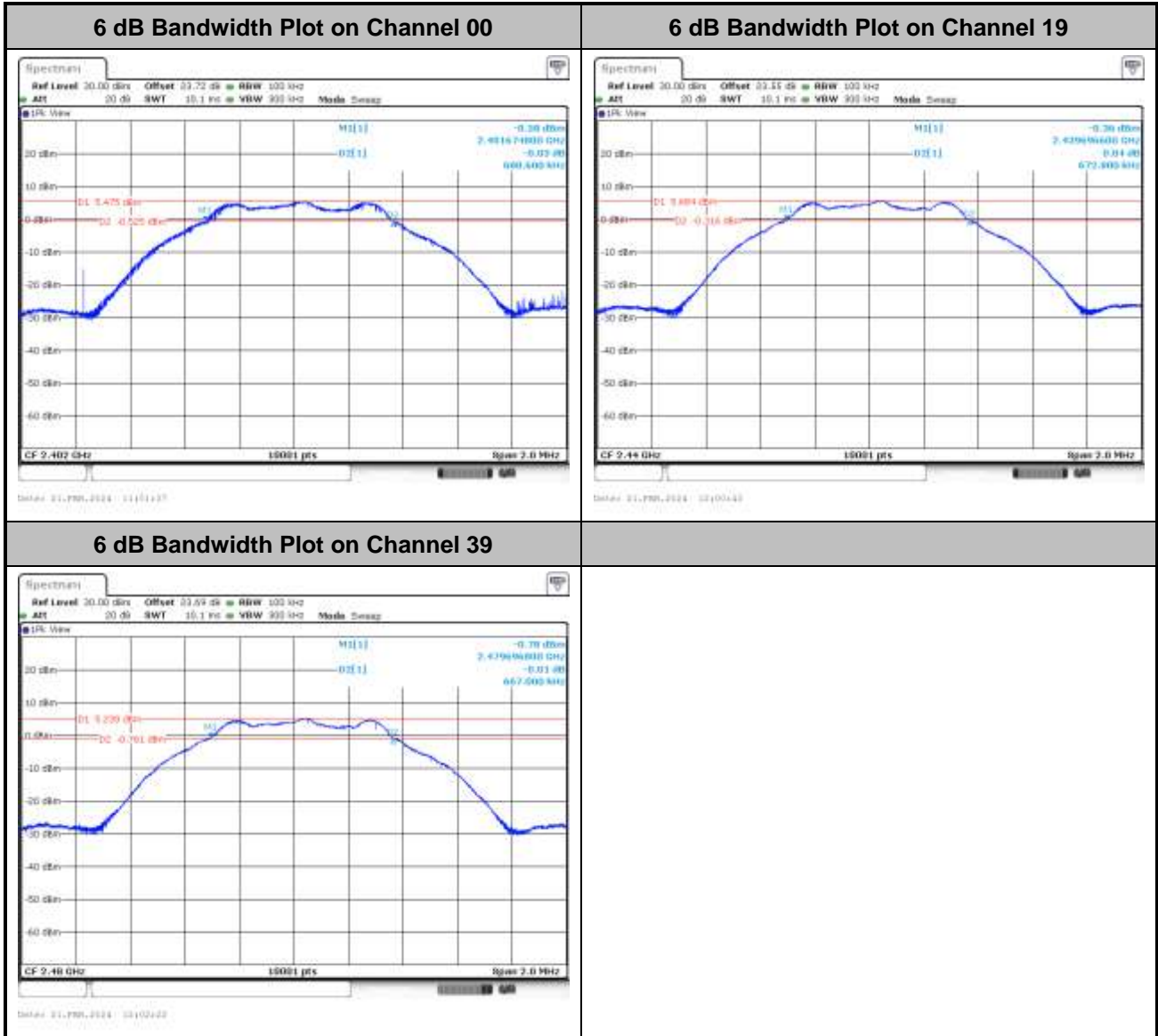



<2Mbps>

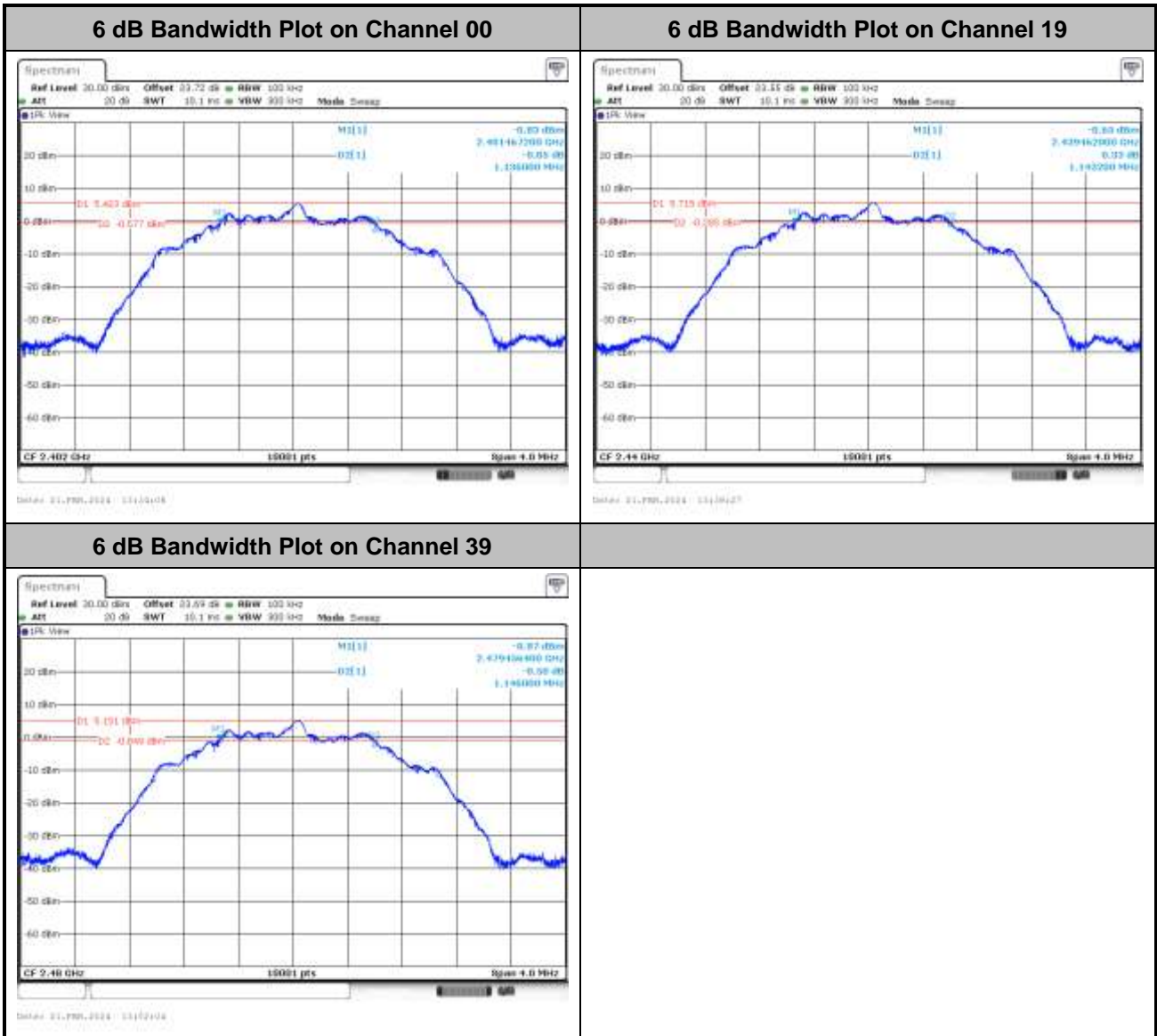



99% Occupied Bandwidth

<1Mbps>

99% Occupied Bandwidth Plot on Channel 00



99% Occupied Bandwidth Plot on Channel 19



99% Occupied Bandwidth Plot on Channel 39

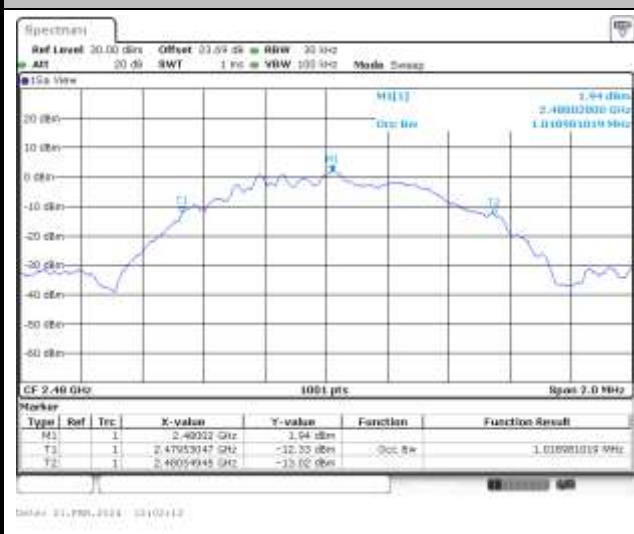



<2Mbps>

99% Occupied Bandwidth Plot on Channel 00



99% Occupied Bandwidth Plot on Channel 19



99% Occupied Bandwidth Plot on Channel 39





Power Spectral Density (dBm/3kHz)

<1Mbps>

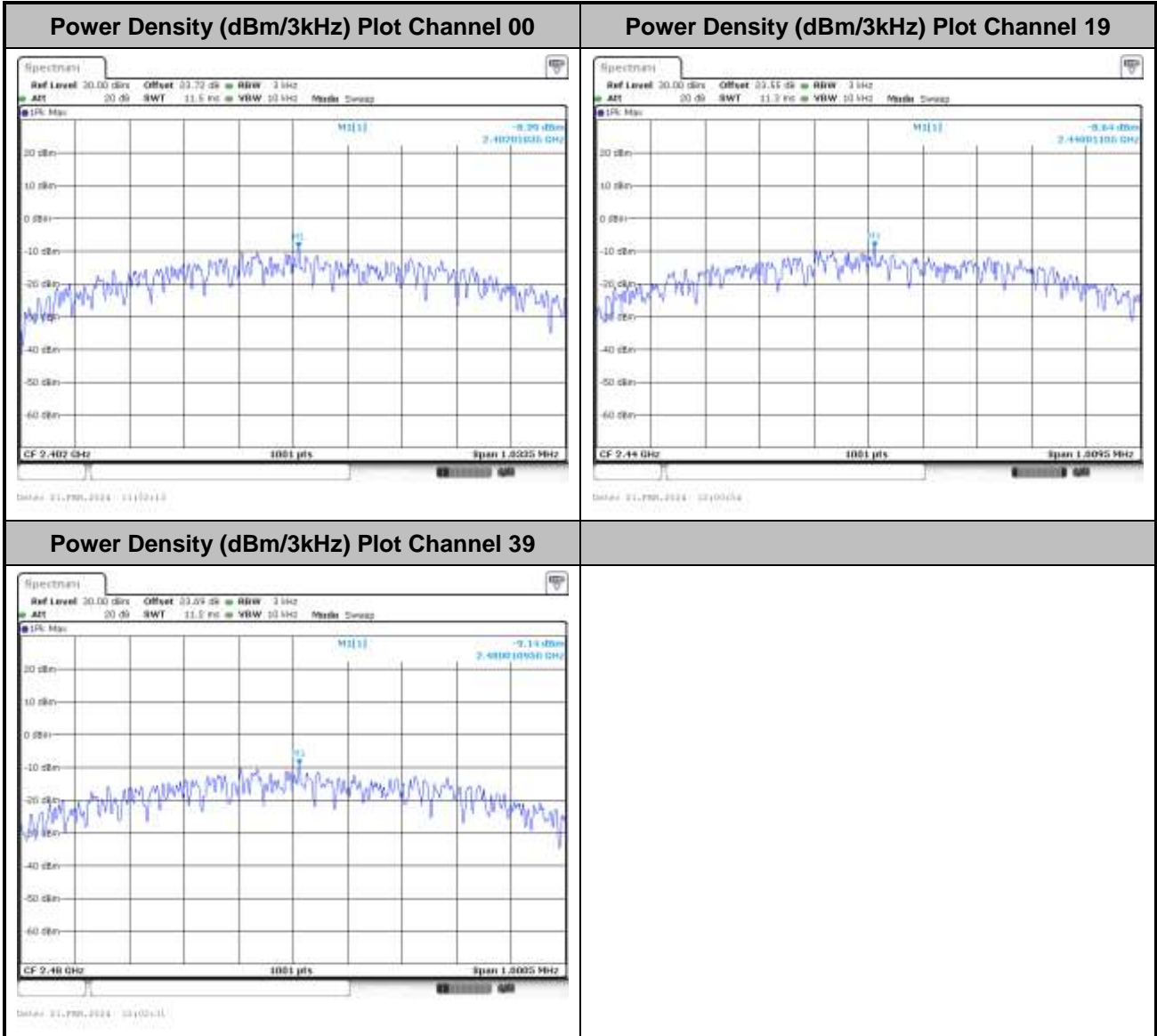



<2Mbps>

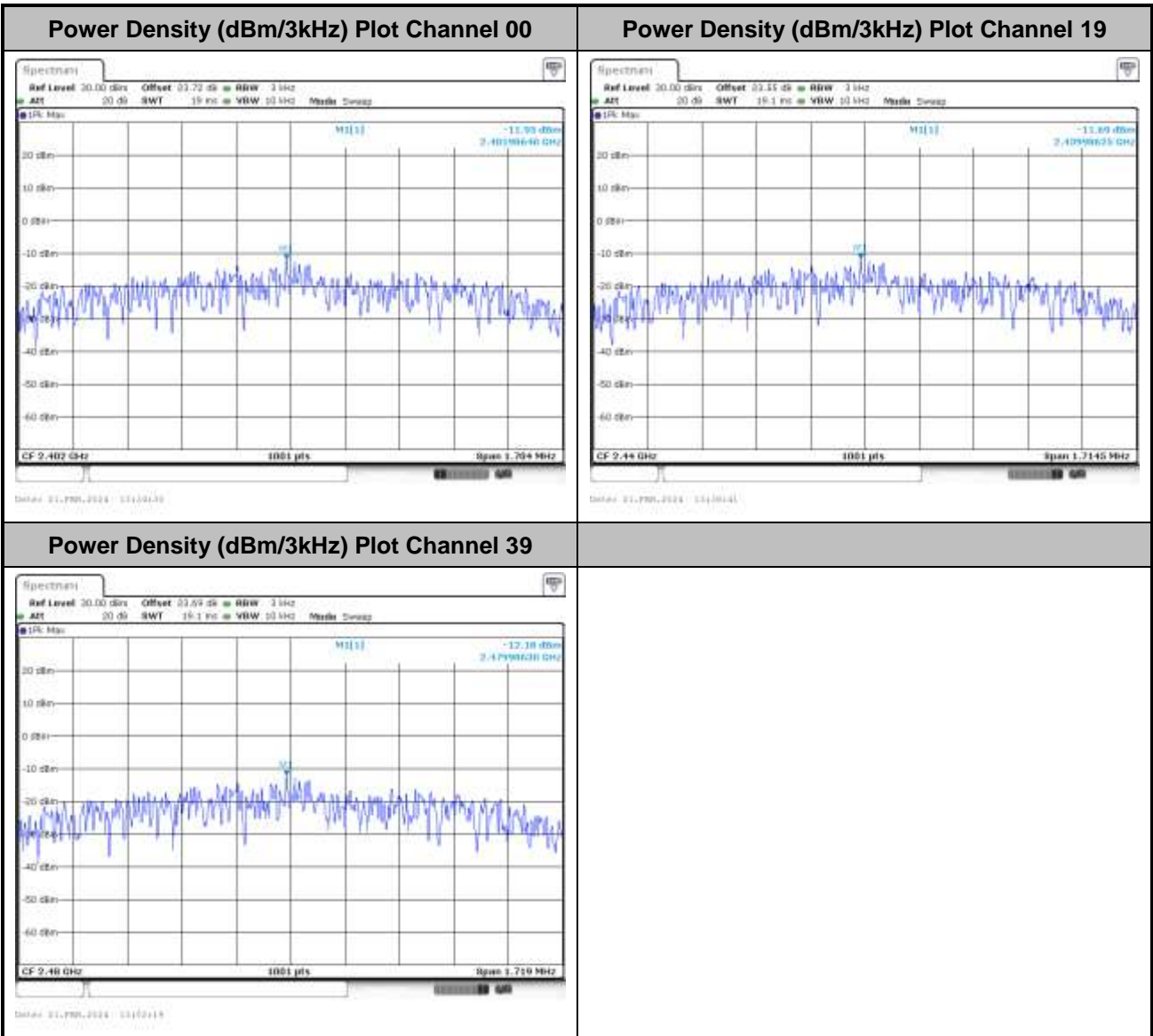



Band Edge and Conducted Spurious Emission

<1Mbps>

Channel 00

100kHz PSD reference Level Plot

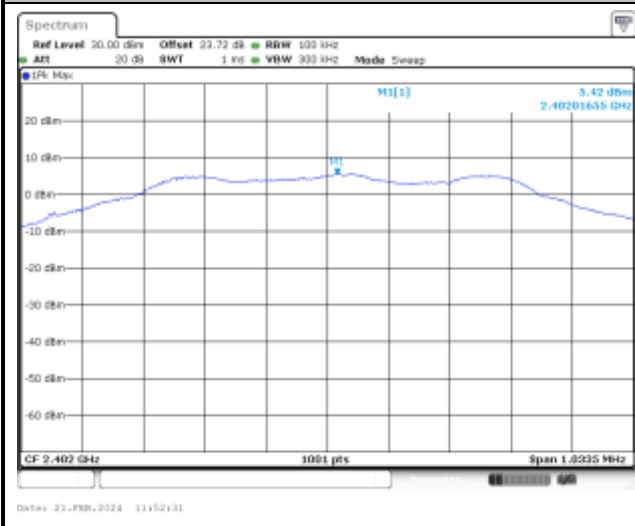

Low Channel Plot

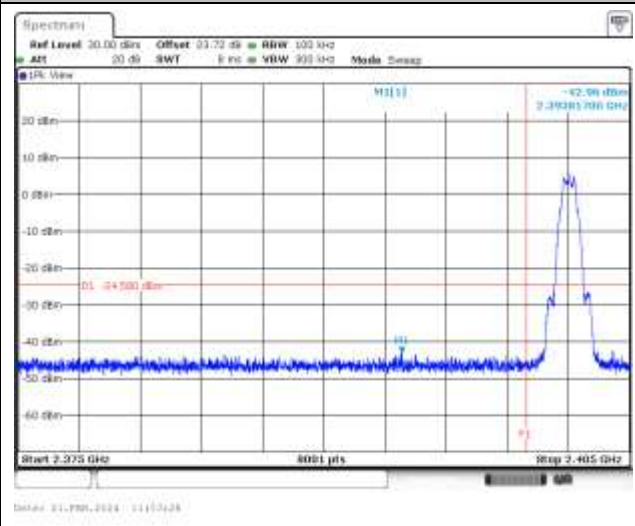

Spurious Emission 30MHz~1GHz Plot

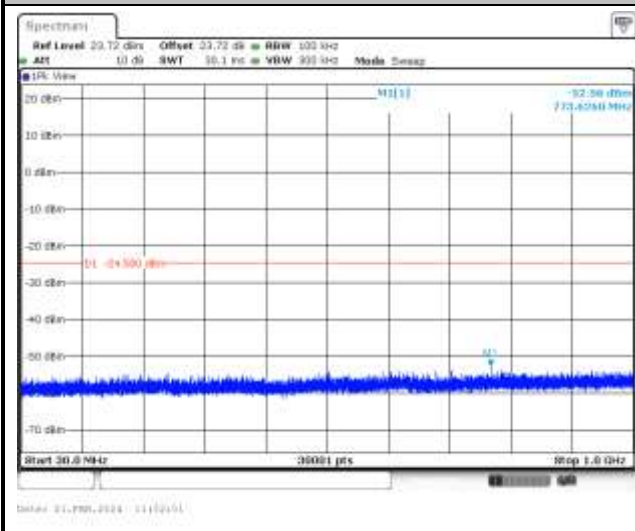

Spurious Emission 1GHz~26.5GHz Plot

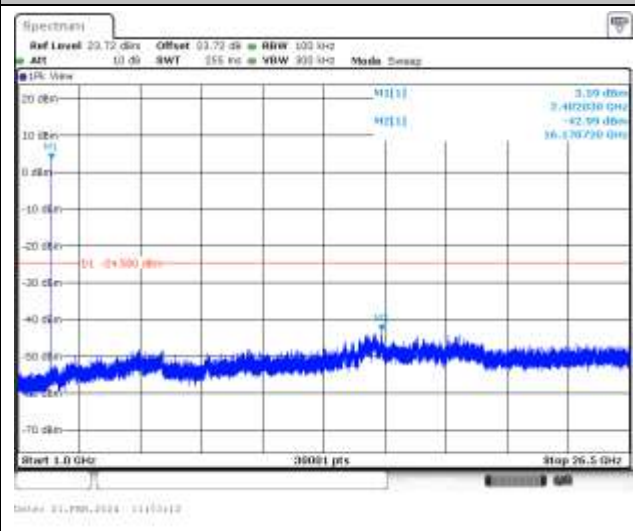



Channel 19

100kHz PSD reference Level Plot

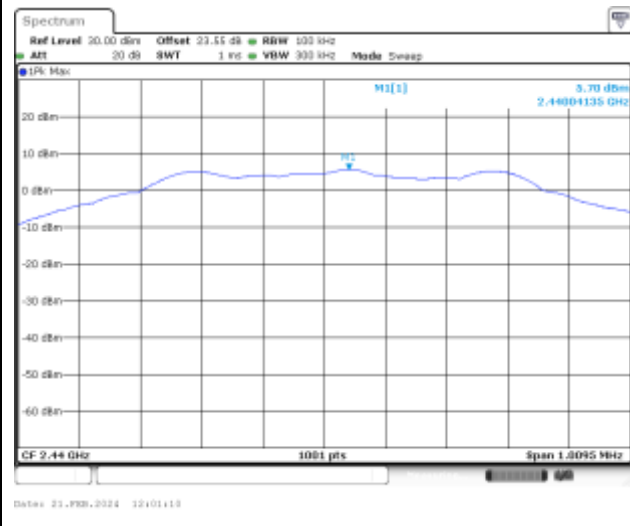

Mid Channel Plot



Spurious Emission 30MHz~1GHz Plot

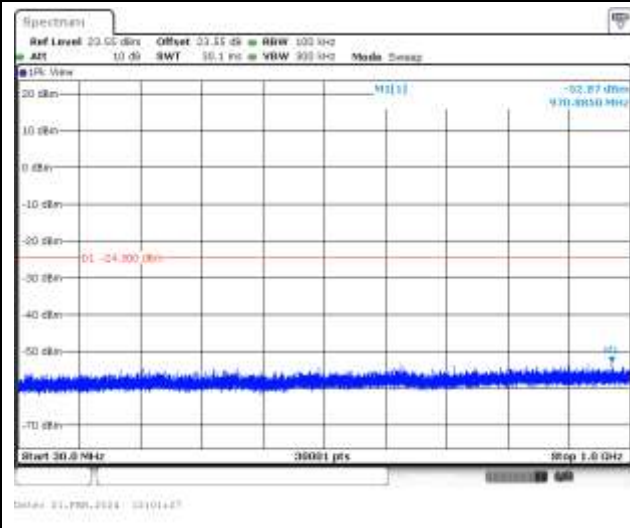

Spurious Emission 1GHz~26.5GHz Plot

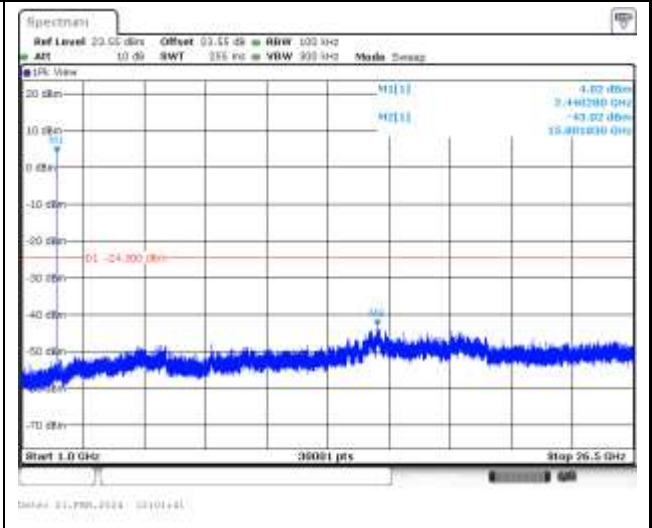



Channel 39

100kHz PSD reference Level Plot

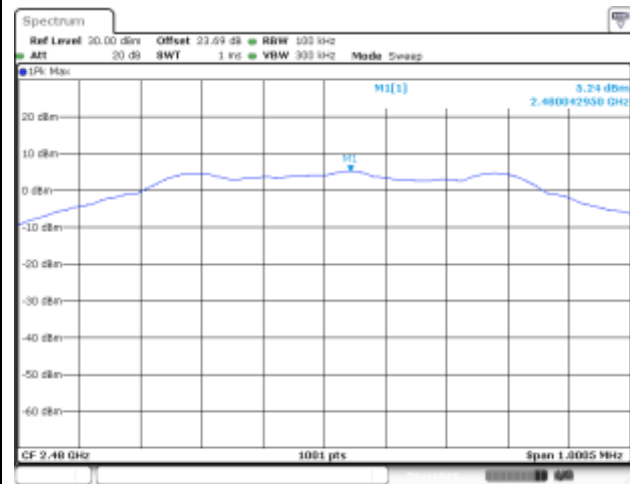

Date: 21-Feb-2024 12:02:47

High Channel Plot

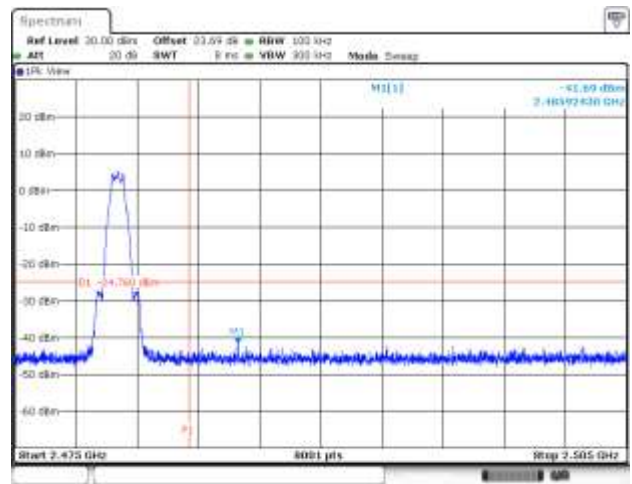

Date: 21-Feb-2024 03:03:38

Spurious Emission 30MHz~1GHz Plot

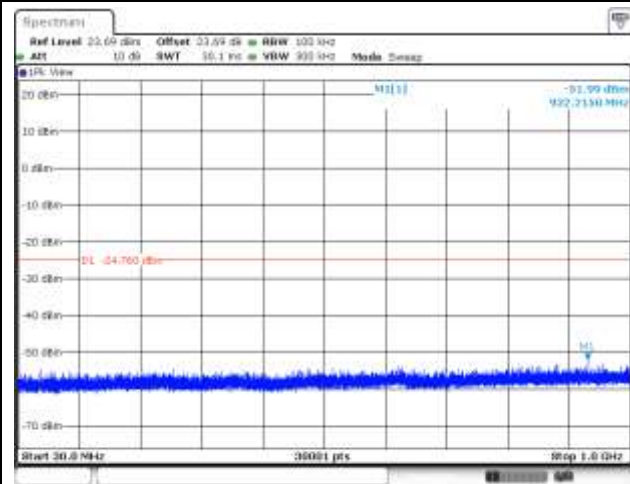

Date: 21-Feb-2024 03:03:42

Spurious Emission 1GHz~26.5GHz Plot

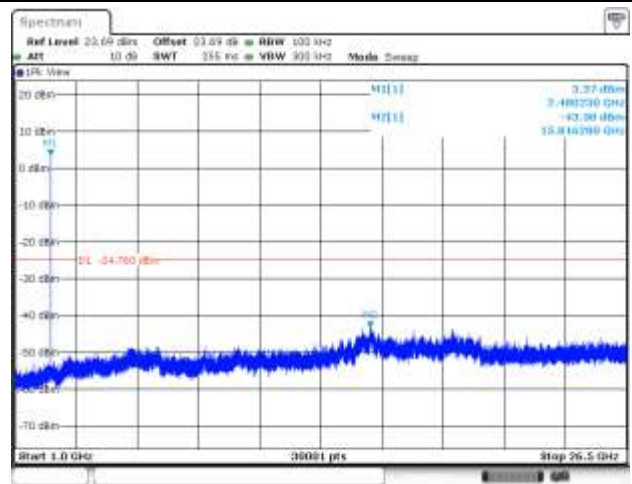

Date: 21-Feb-2024 03:03:48



<2Mbps>

Channel 00

100kHz PSD reference Level Plot

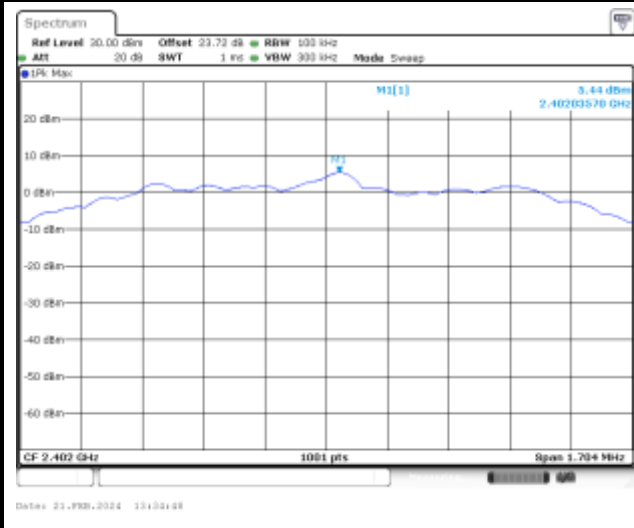

Low Channel Plot

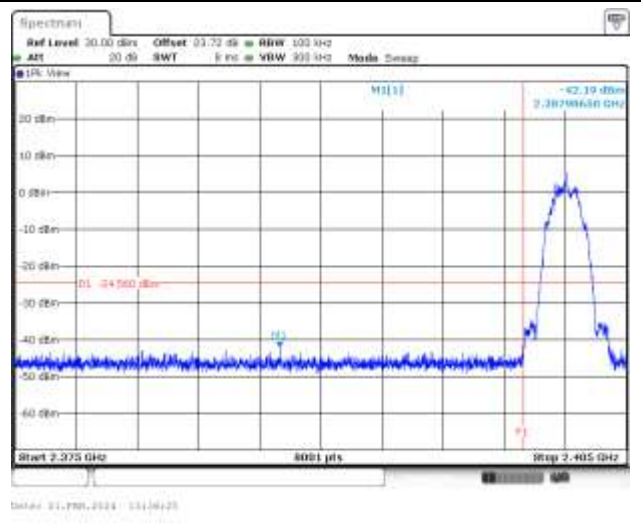

Spurious Emission 30MHz~1GHz Plot

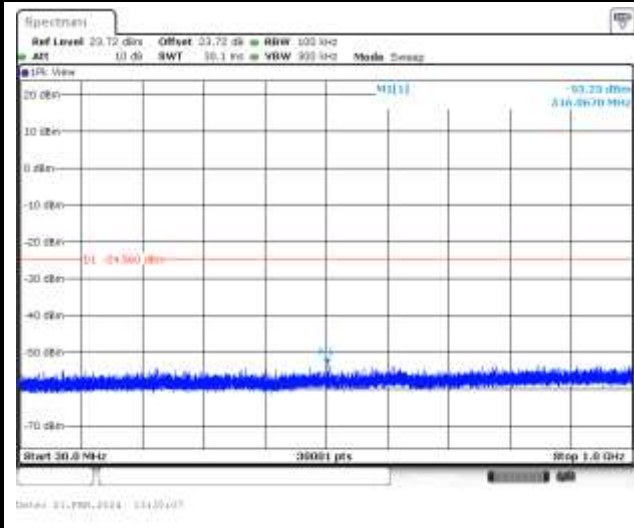

Spurious Emission 1GHz~26.5GHz Plot

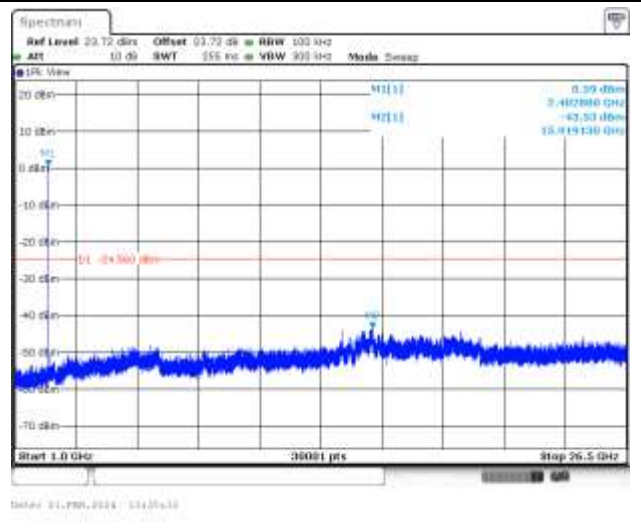



Channel 19

100kHz PSD reference Level Plot

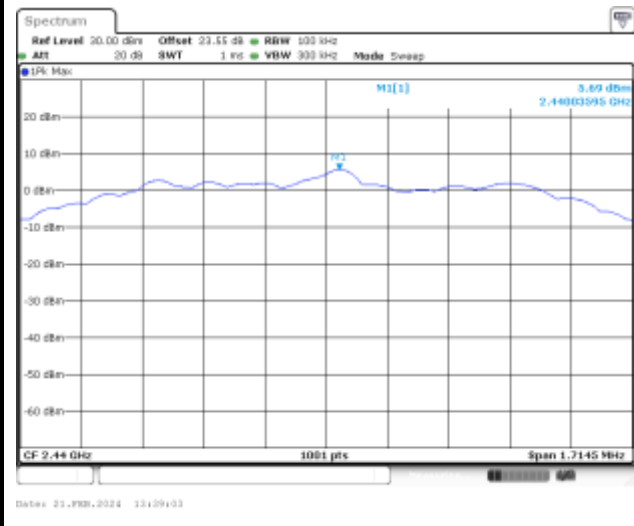

Mid Channel Plot



Spurious Emission 30MHz~1GHz Plot

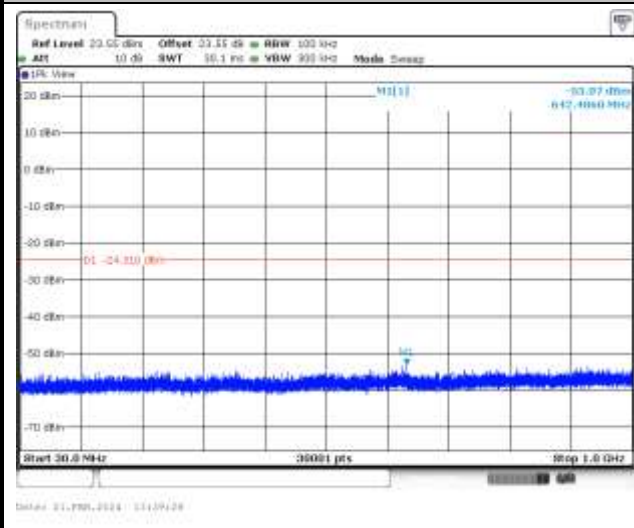

Spurious Emission 1GHz~26.5GHz Plot

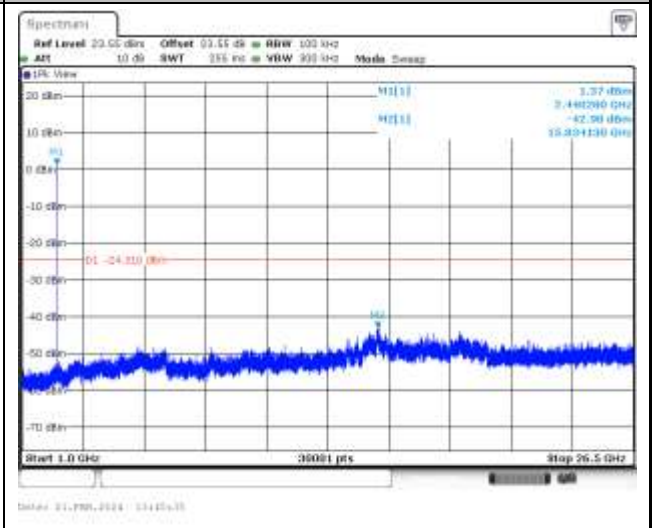



Channel 39

100kHz PSD reference Level Plot

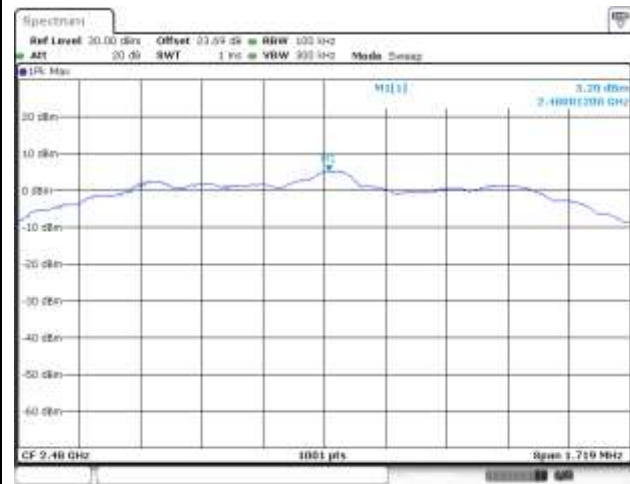

High Channel Plot

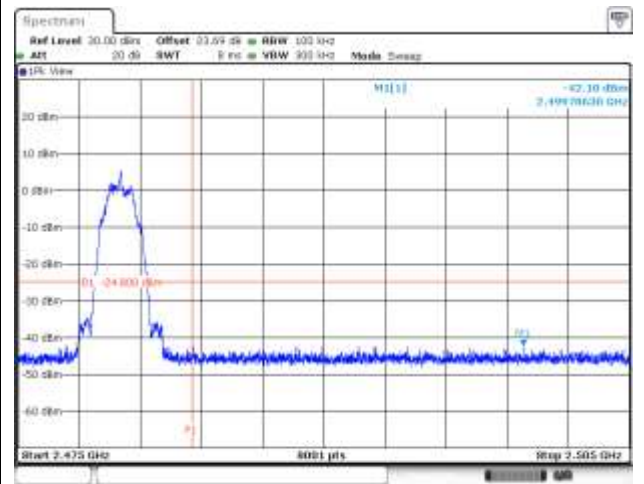

Spurious Emission 30MHz~1GHz Plot

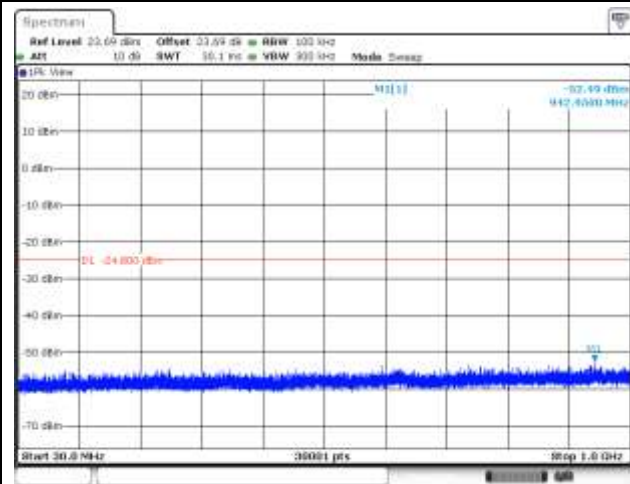

Spurious Emission 1GHz~26.5GHz Plot

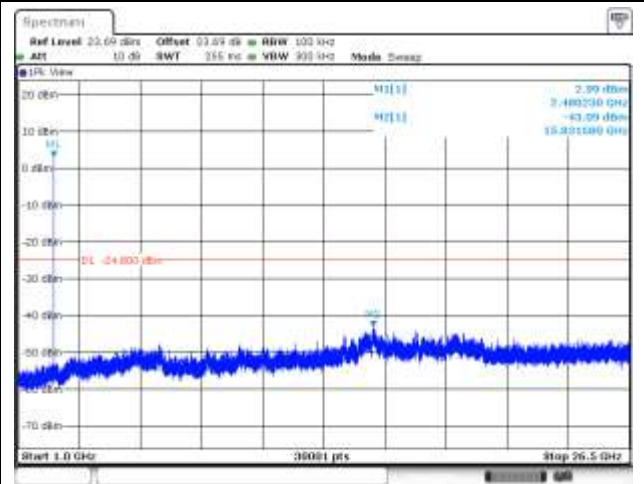



<Class 2>

<Ant. 6 >

6dB Bandwidth

<1Mbps>

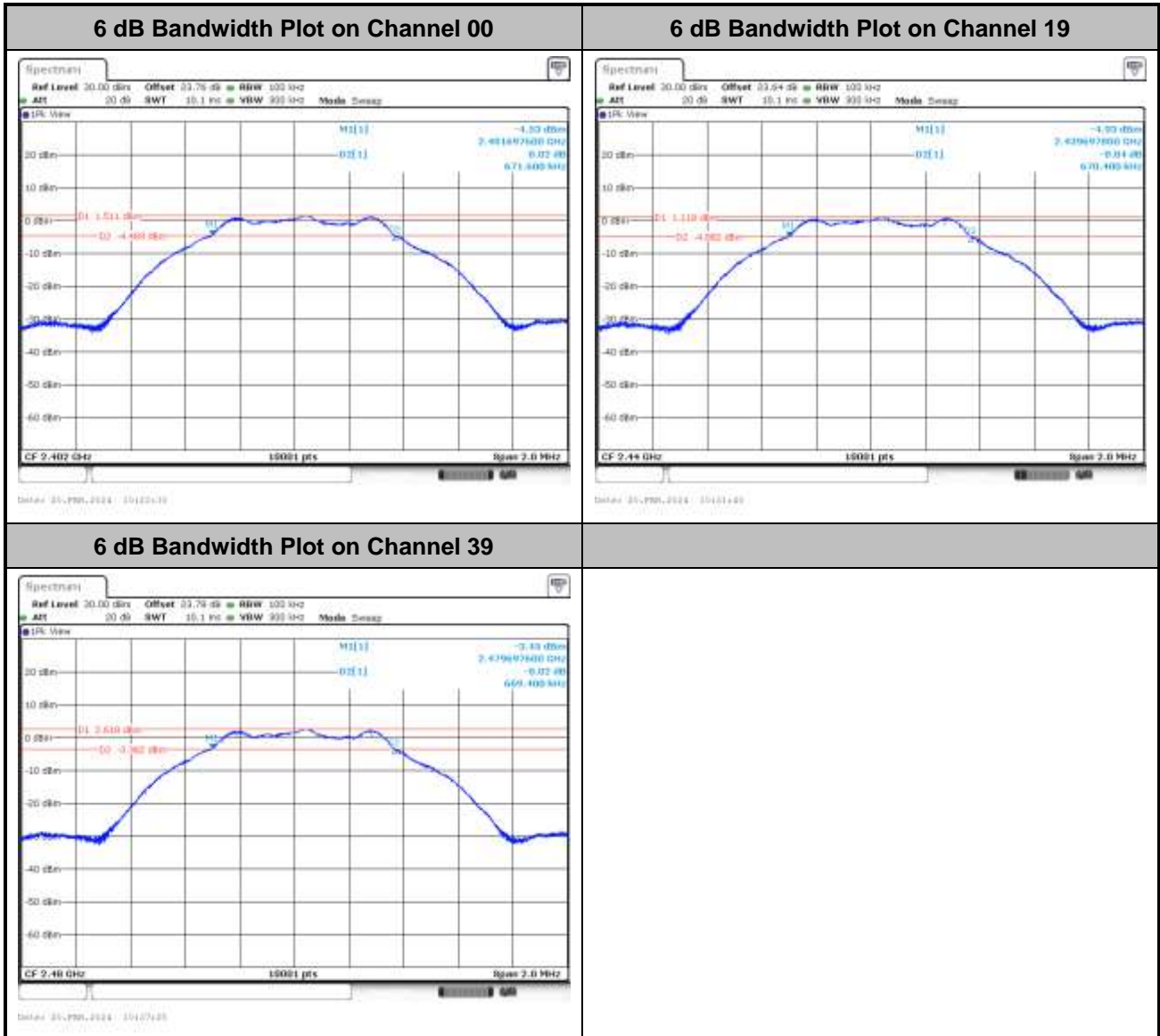



<2Mbps>

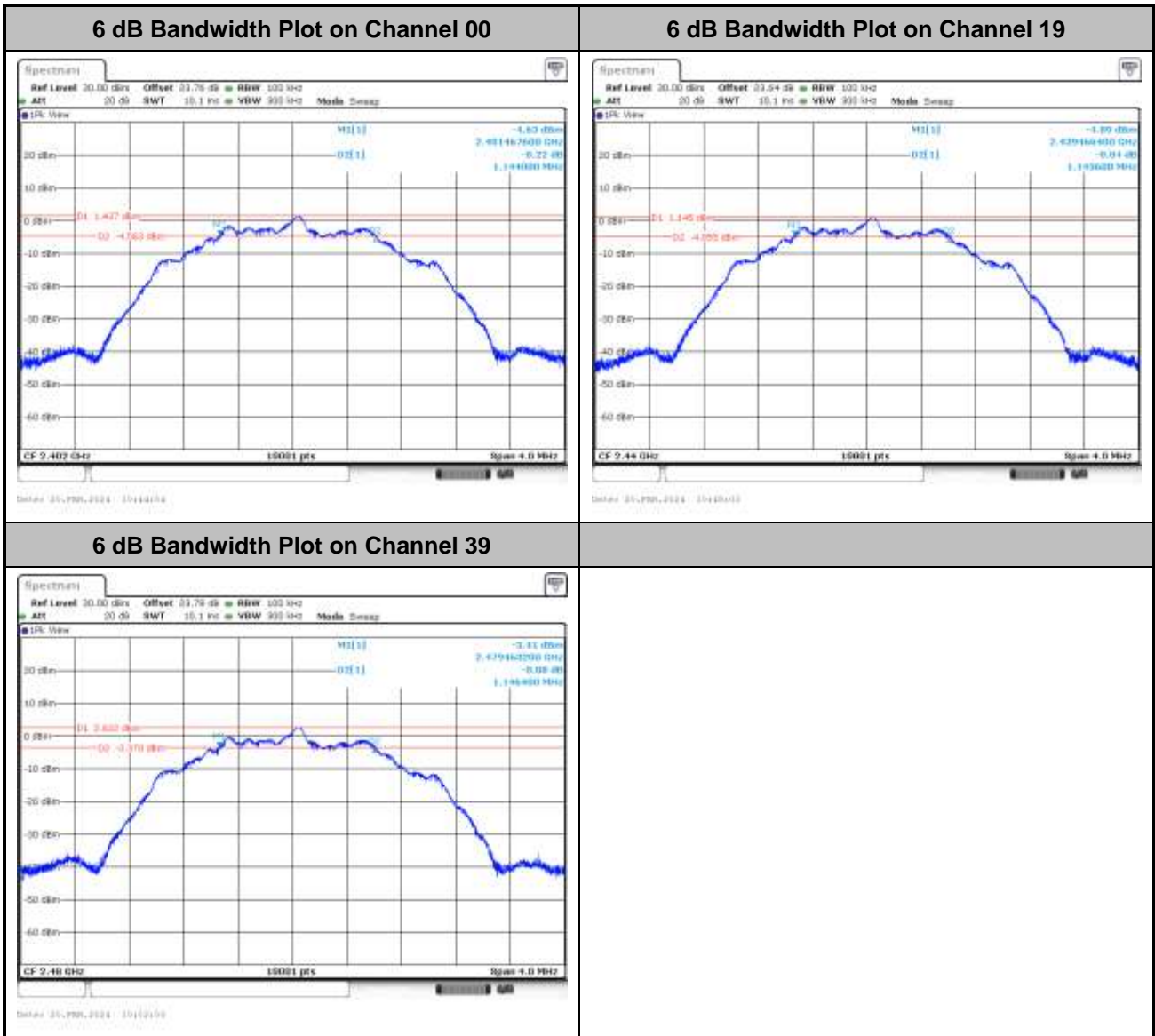



99% Occupied Bandwidth

<1Mbps>

99% Occupied Bandwidth Plot on Channel 00



99% Occupied Bandwidth Plot on Channel 19



99% Occupied Bandwidth Plot on Channel 39





<2Mbps>

99% Occupied Bandwidth Plot on Channel 00



Date: 25-FEB-2024 10:14:20

99% Occupied Bandwidth Plot on Channel 19



Date: 25-FEB-2024 10:17:25

99% Occupied Bandwidth Plot on Channel 39



Date: 25-FEB-2024 10:18:28



Power Spectral Density (dBm/3kHz)

<1Mbps>

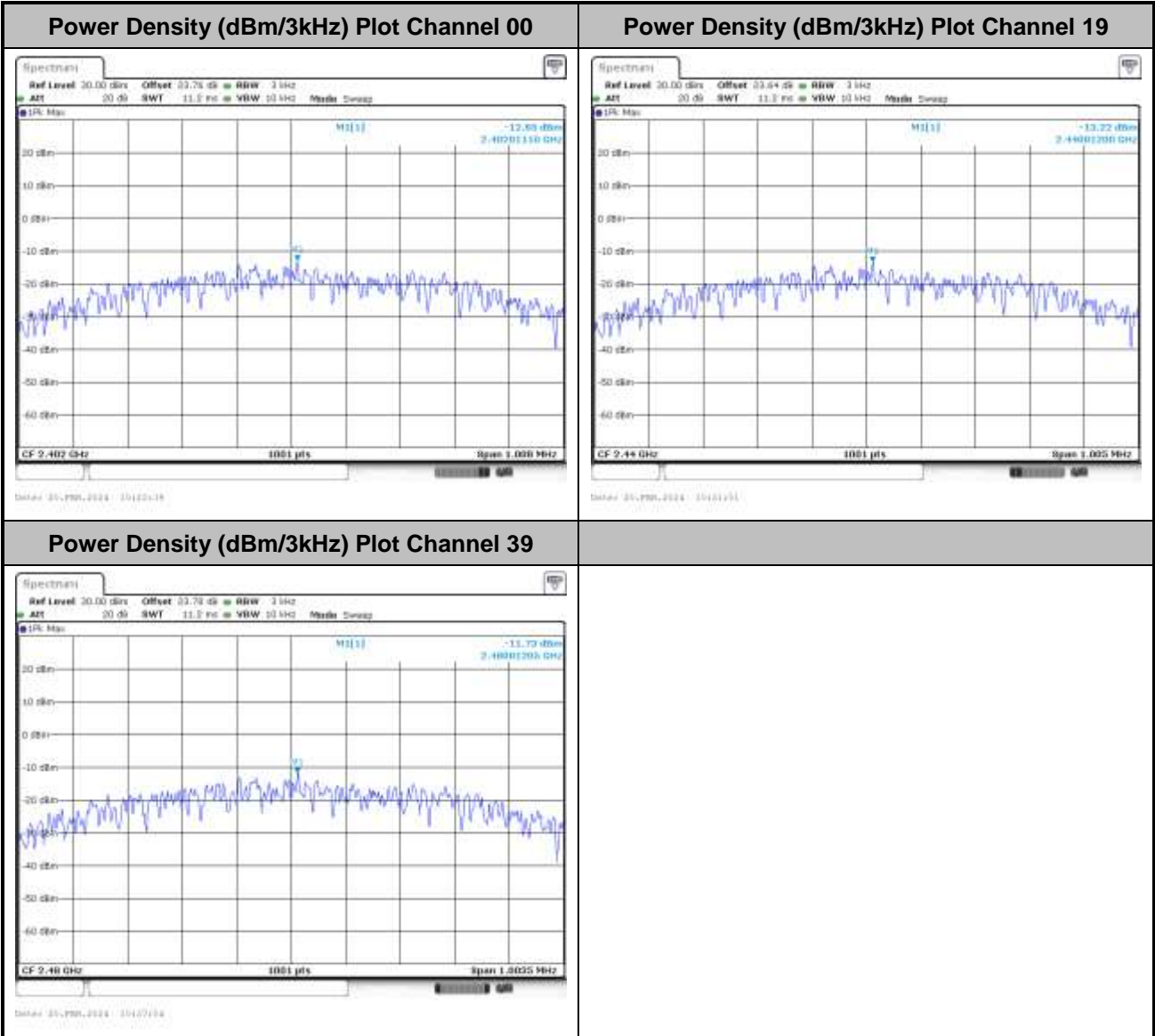



<2Mbps>

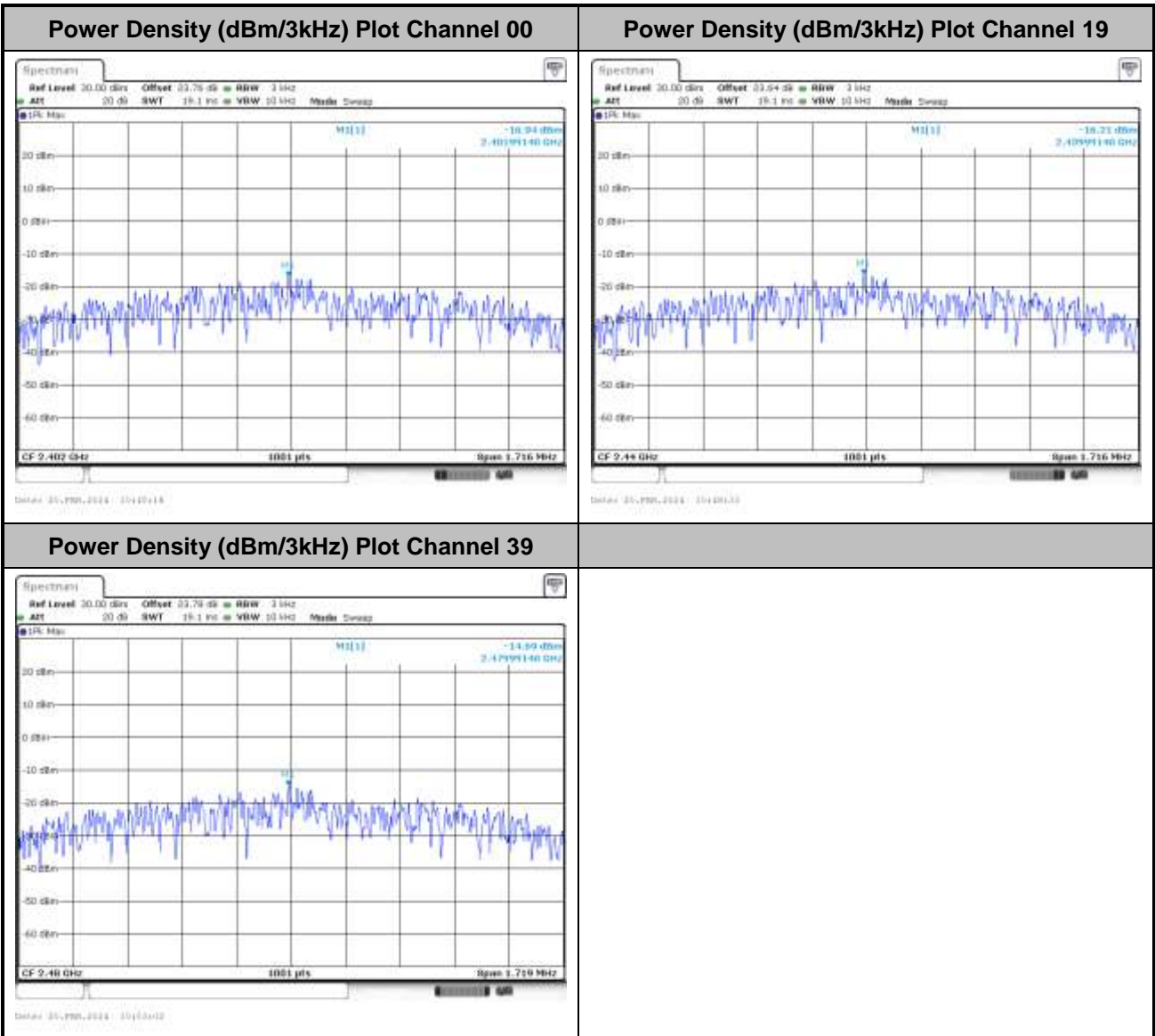



Band Edge and Conducted Spurious Emission

<1Mbps>

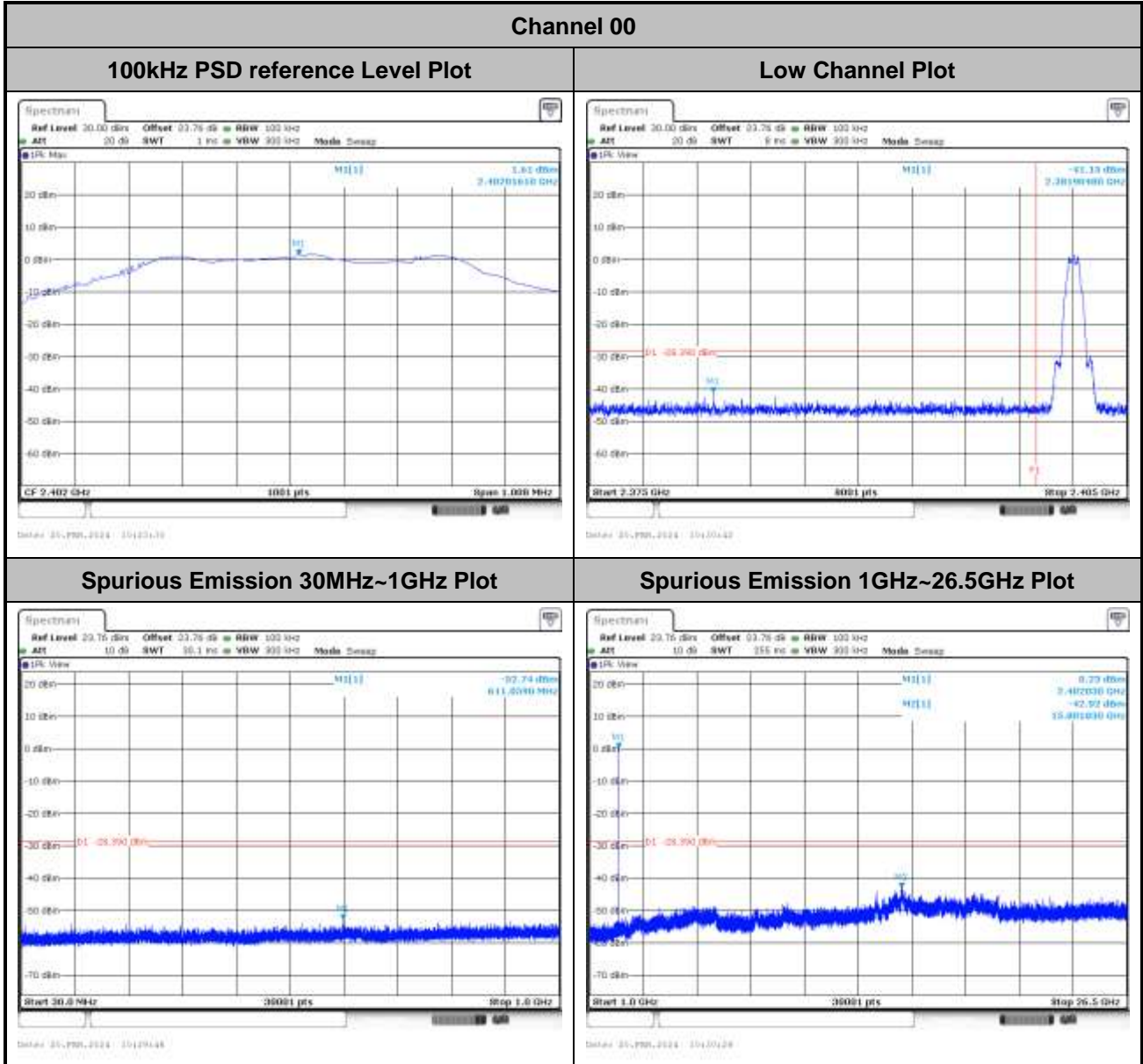



Channel 19

100kHz PSD reference Level Plot

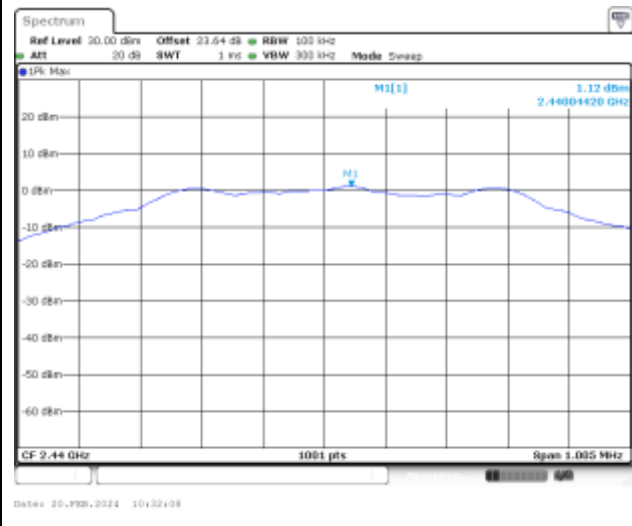

Mid Channel Plot



Spurious Emission 30MHz~1GHz Plot

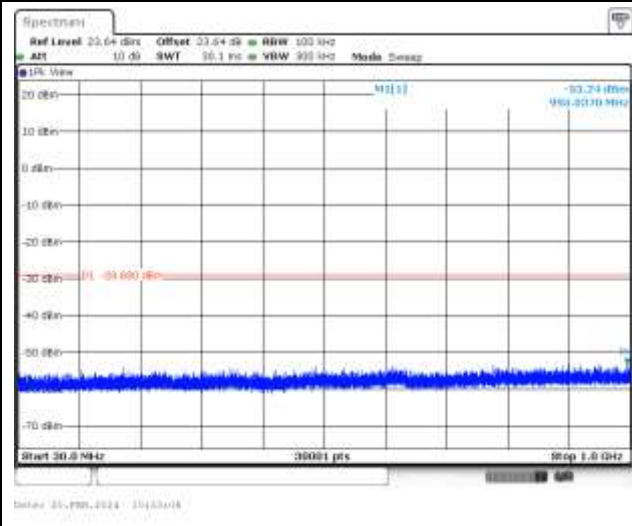

Spurious Emission 1GHz~26.5GHz Plot

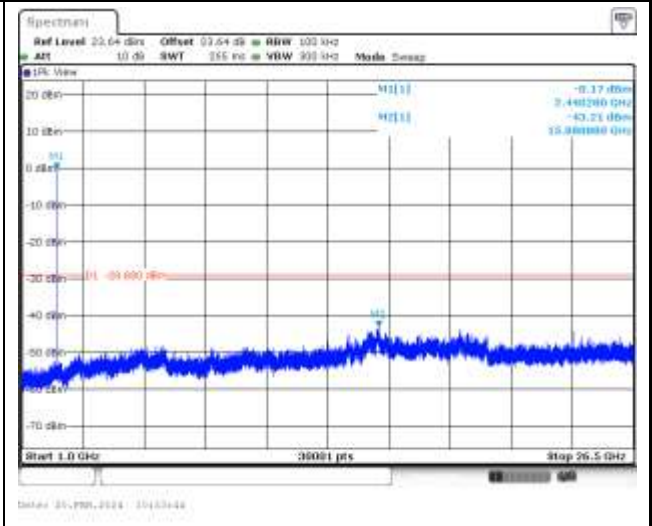



Channel 39

100kHz PSD reference Level Plot

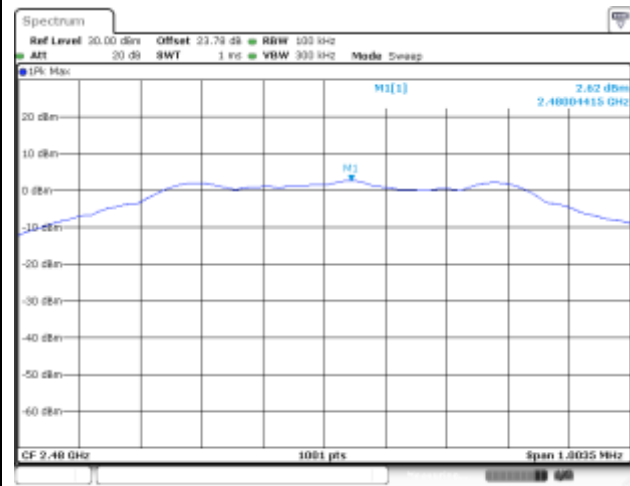

Date: 25-Feb-2024 10:29:15

High Channel Plot

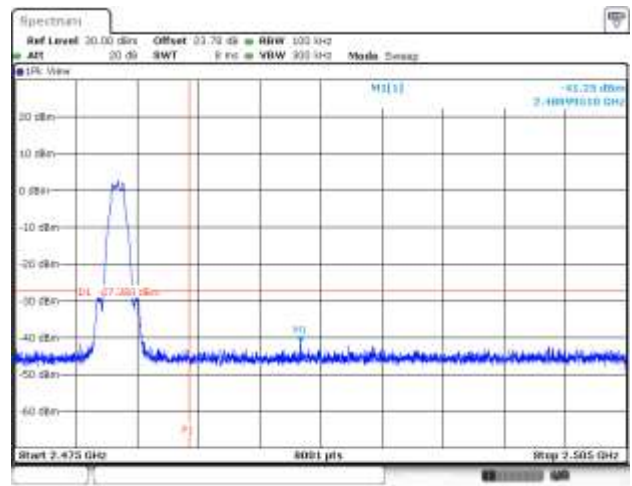

Date: 25-Feb-2024 10:40:59

Spurious Emission 30MHz~1GHz Plot

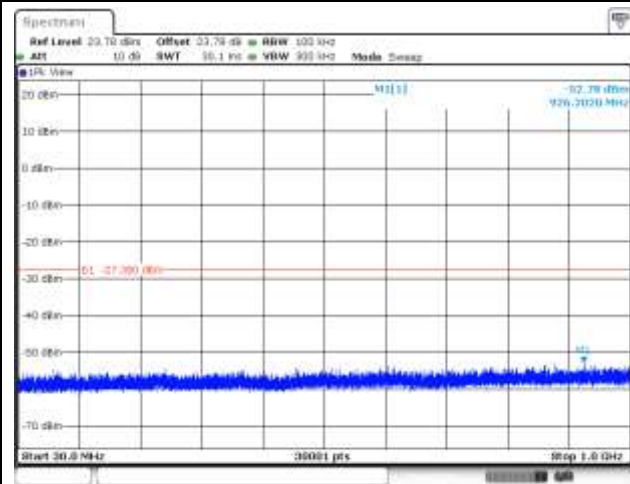

Date: 25-Feb-2024 10:49:45

Spurious Emission 1GHz~26.5GHz Plot

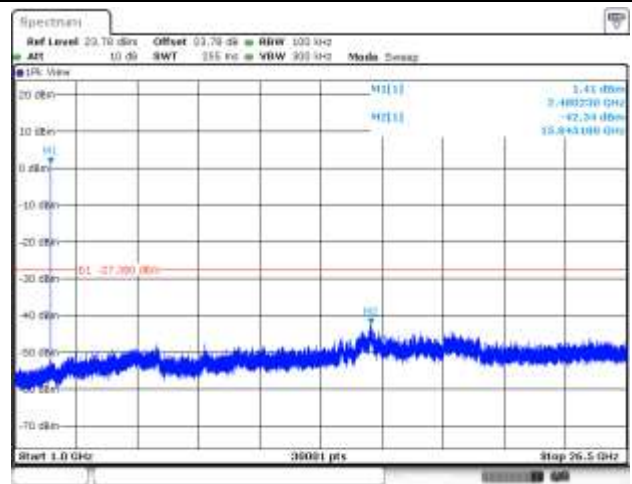

Date: 25-Feb-2024 10:49:28



<2Mbps>

Channel 00

100kHz PSD reference Level Plot

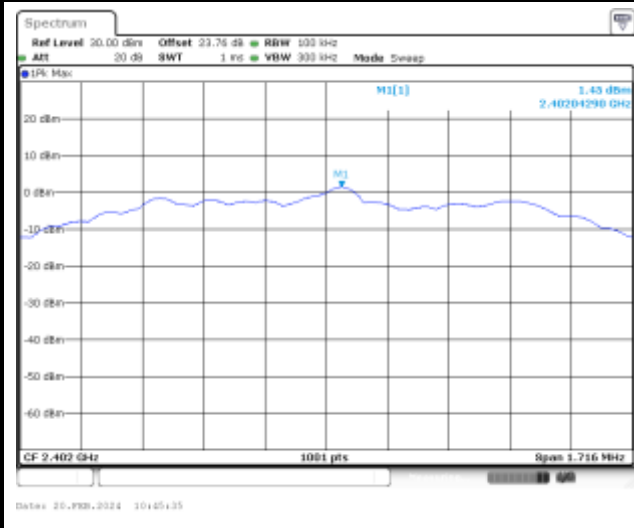

Low Channel Plot

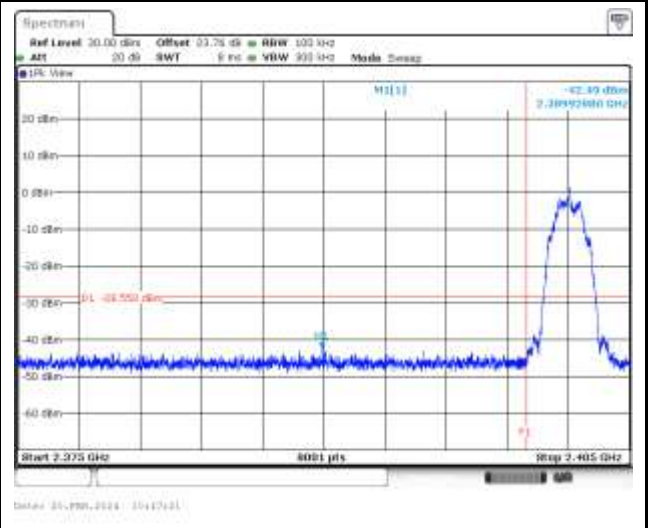

Spurious Emission 30MHz~1GHz Plot

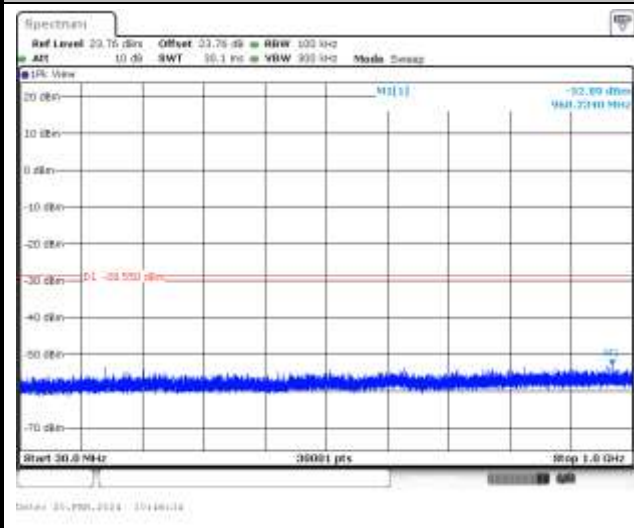

Spurious Emission 1GHz~26.5GHz Plot

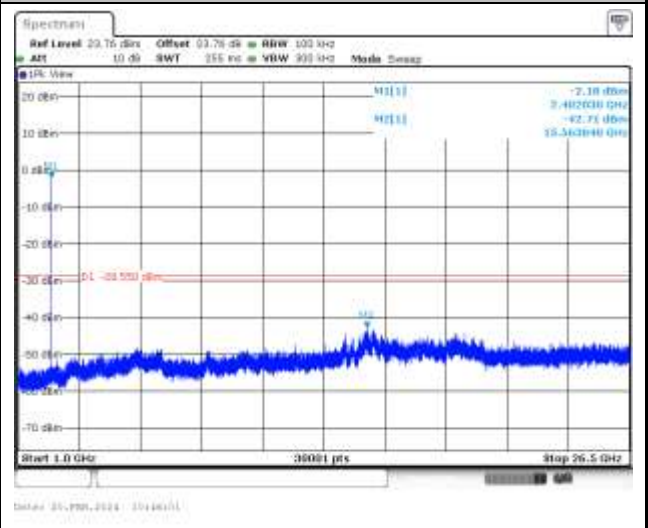



Channel 19

100kHz PSD reference Level Plot

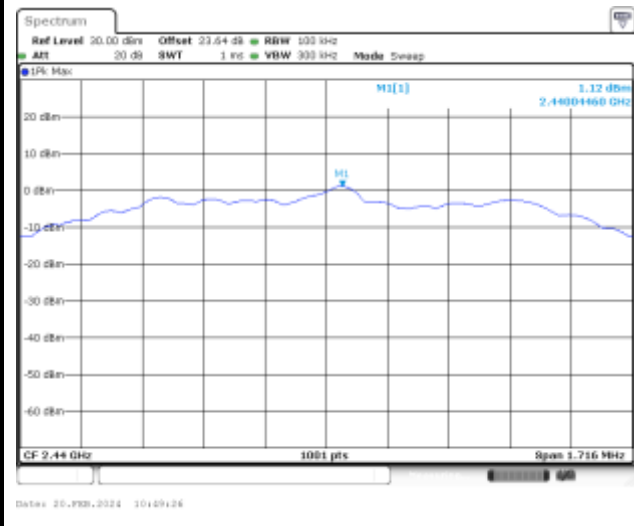

Mid Channel Plot



Spurious Emission 30MHz~1GHz Plot

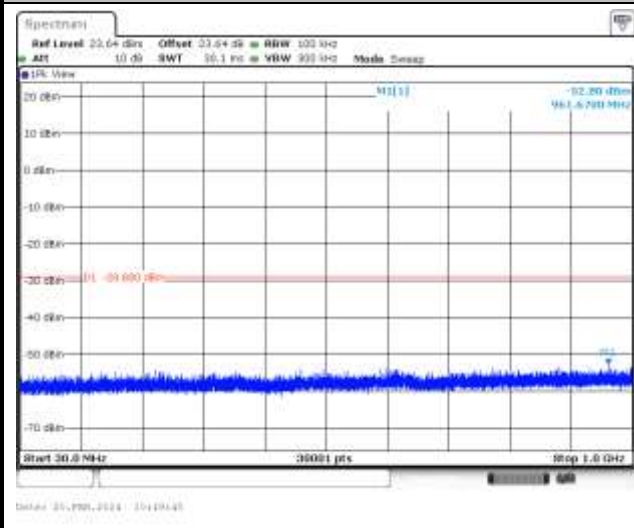

Spurious Emission 1GHz~26.5GHz Plot

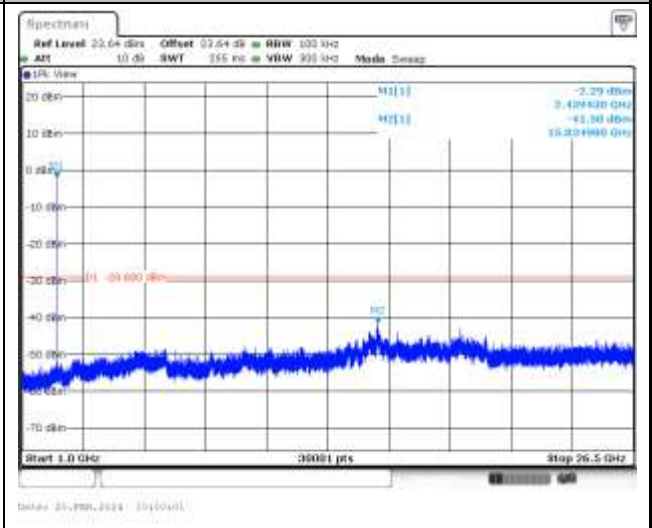



Channel 39

100kHz PSD reference Level Plot

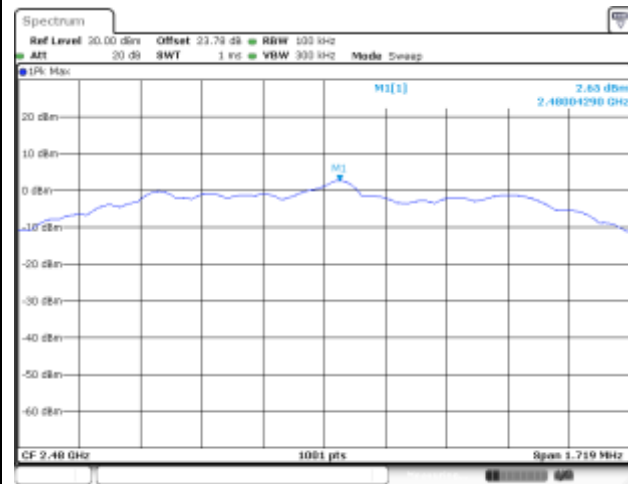

Date: 25-Feb-2024 10:53:33

High Channel Plot

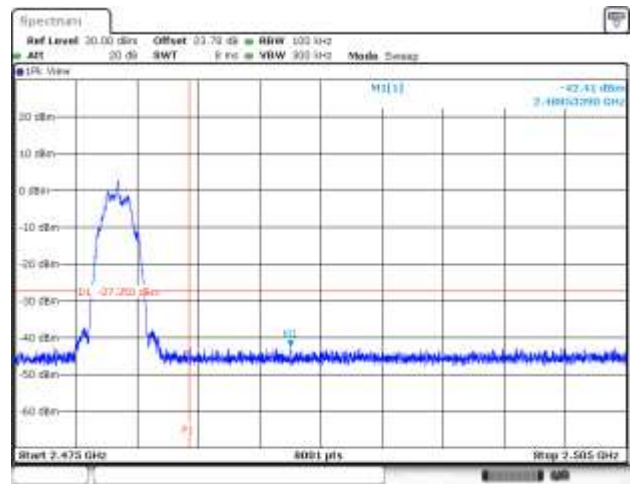

Date: 25-Feb-2024 10:54:48

Spurious Emission 30MHz~1GHz Plot

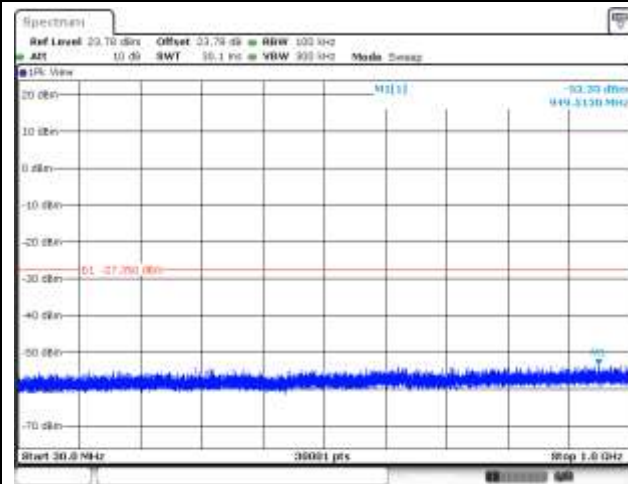

Date: 25-Feb-2024 10:53:47

Spurious Emission 1GHz~26.5GHz Plot

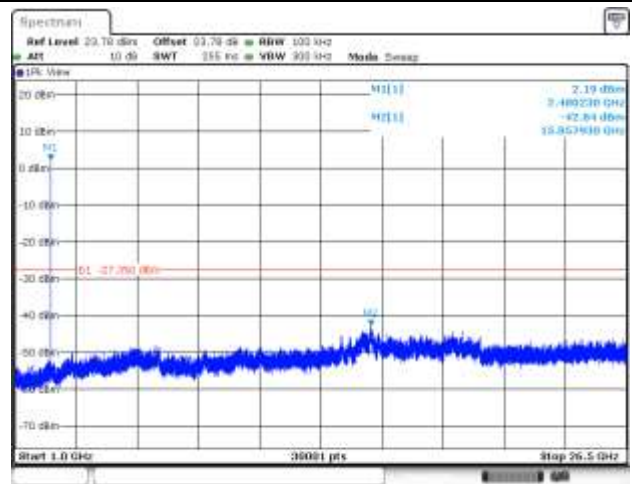

Date: 25-Feb-2024 10:54:27



<Ant. 7>

6dB Bandwidth

<1Mbps>

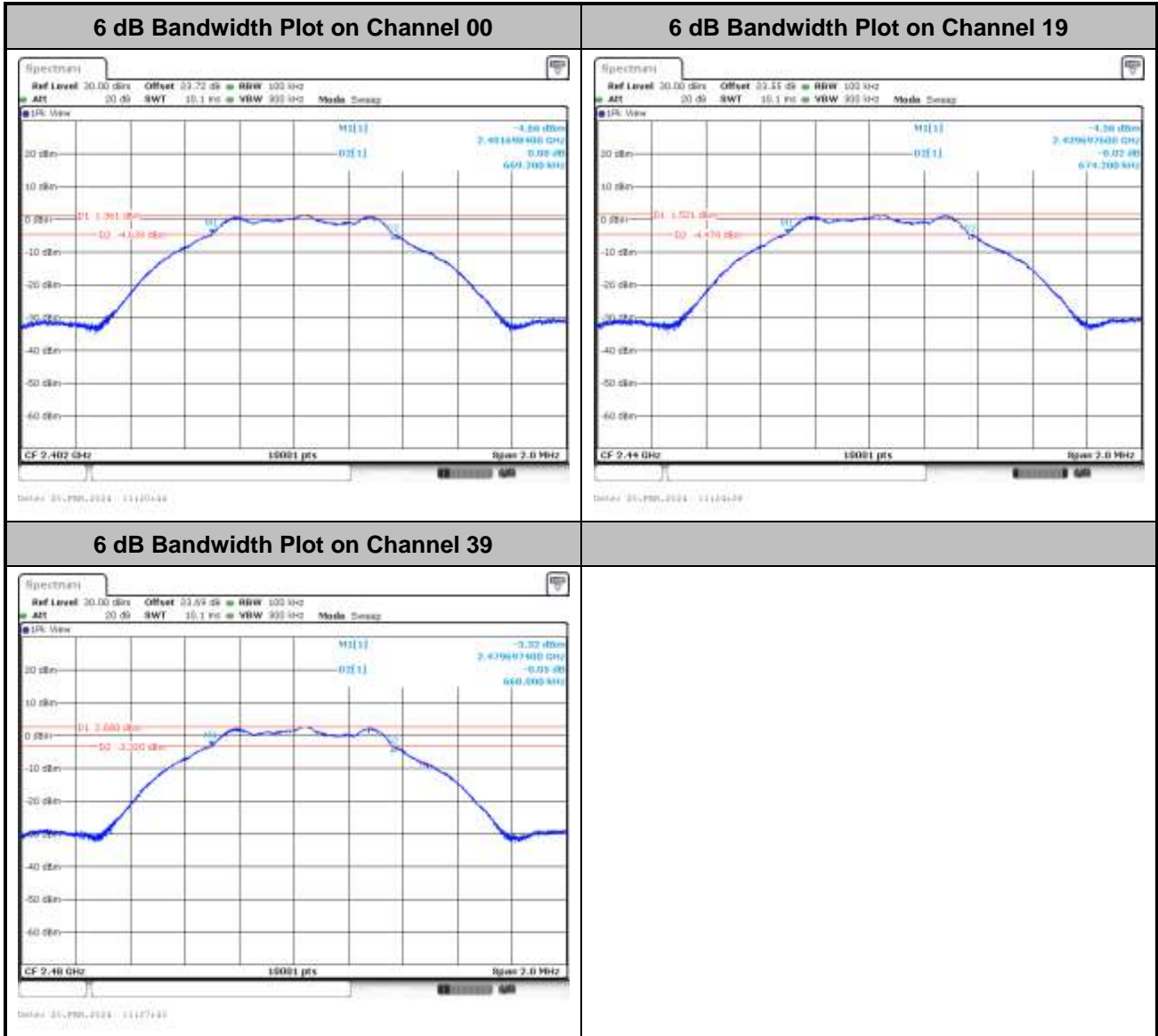



<2Mbps>

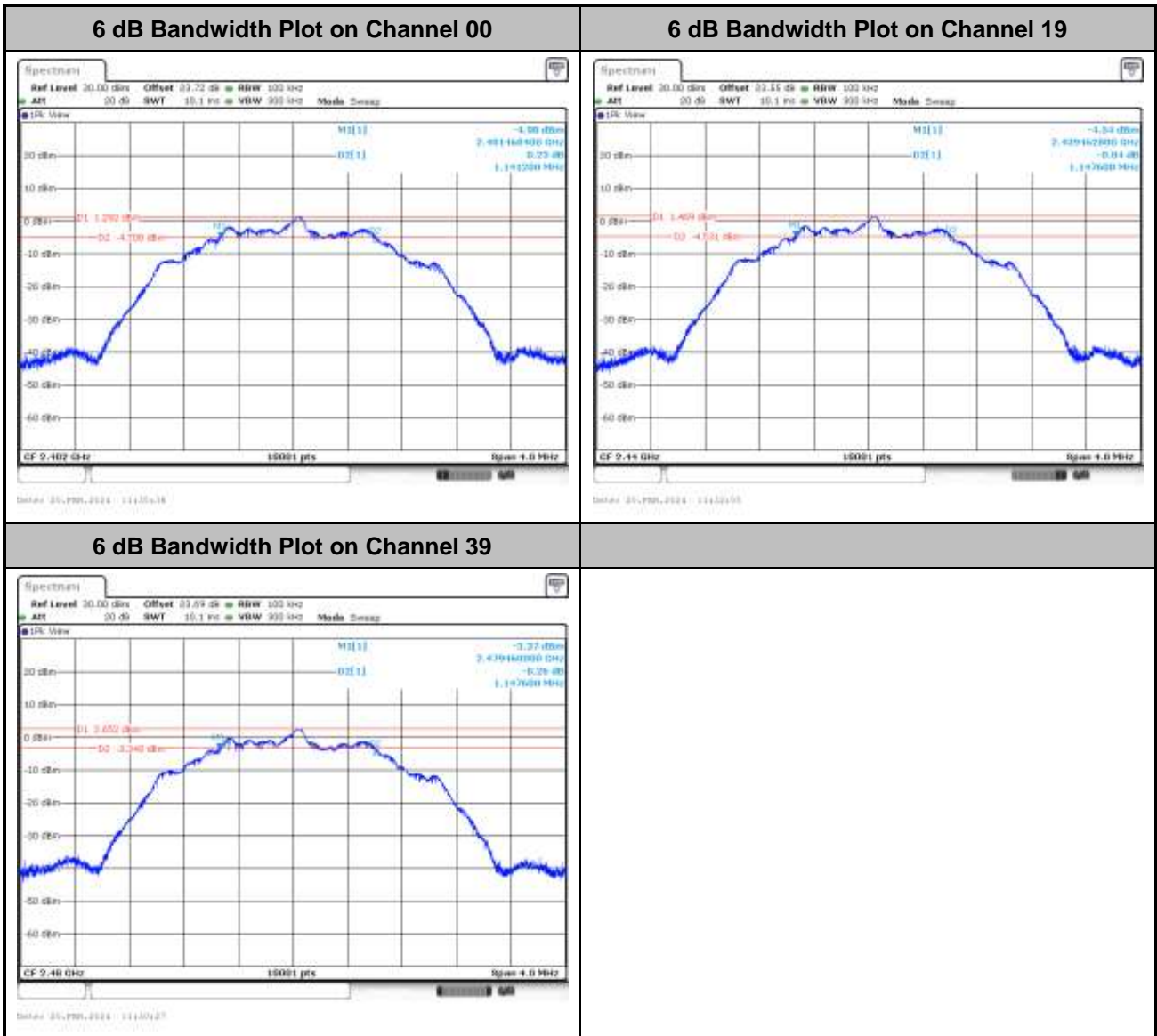



99% Occupied Bandwidth

<1Mbps>

99% Occupied Bandwidth Plot on Channel 00



99% Occupied Bandwidth Plot on Channel 19



99% Occupied Bandwidth Plot on Channel 39





<2Mbps>

99% Occupied Bandwidth Plot on Channel 00



99% Occupied Bandwidth Plot on Channel 19



99% Occupied Bandwidth Plot on Channel 39





Power Spectral Density (dBm/3kHz)

<1Mbps>

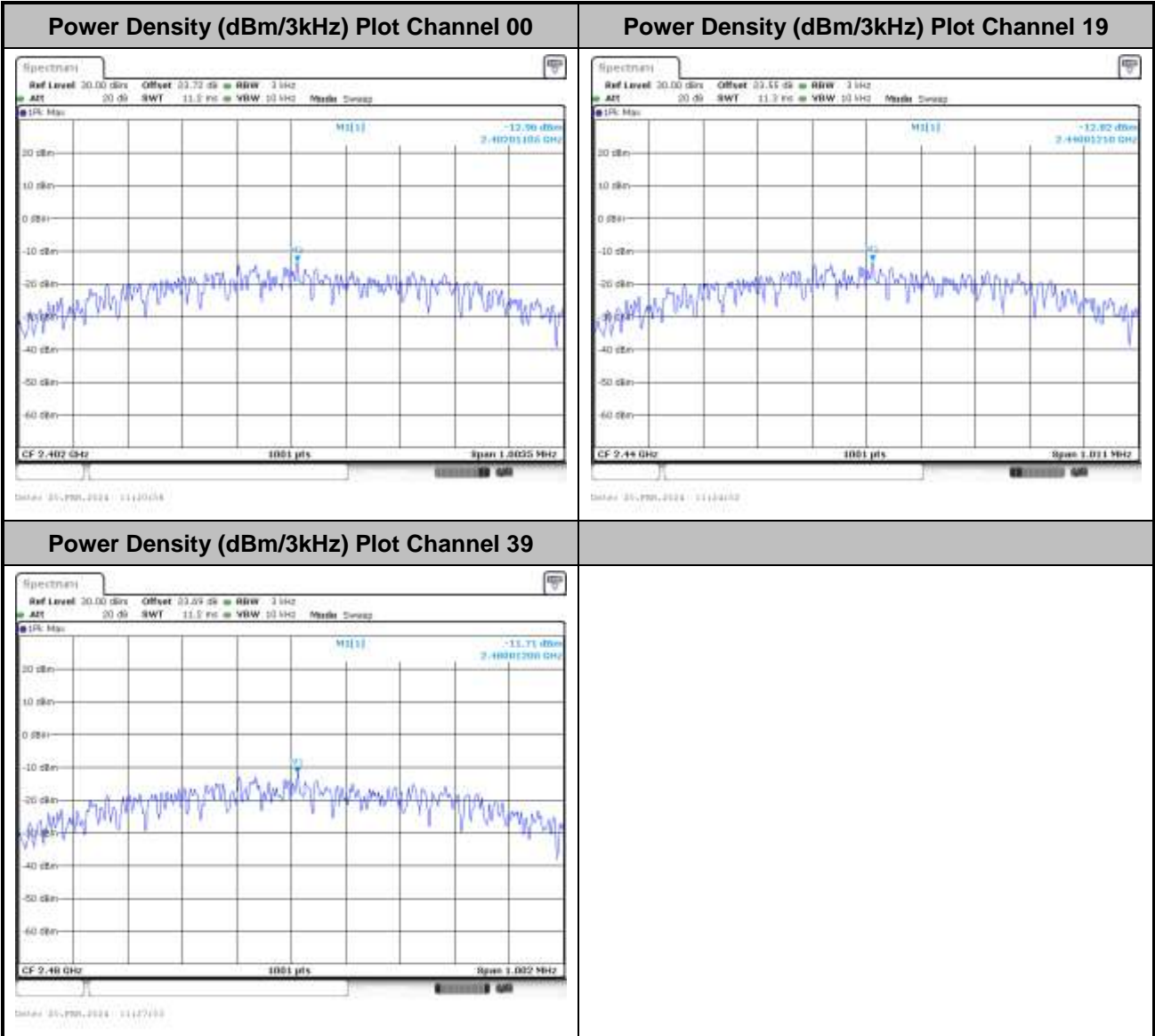



<2Mbps>

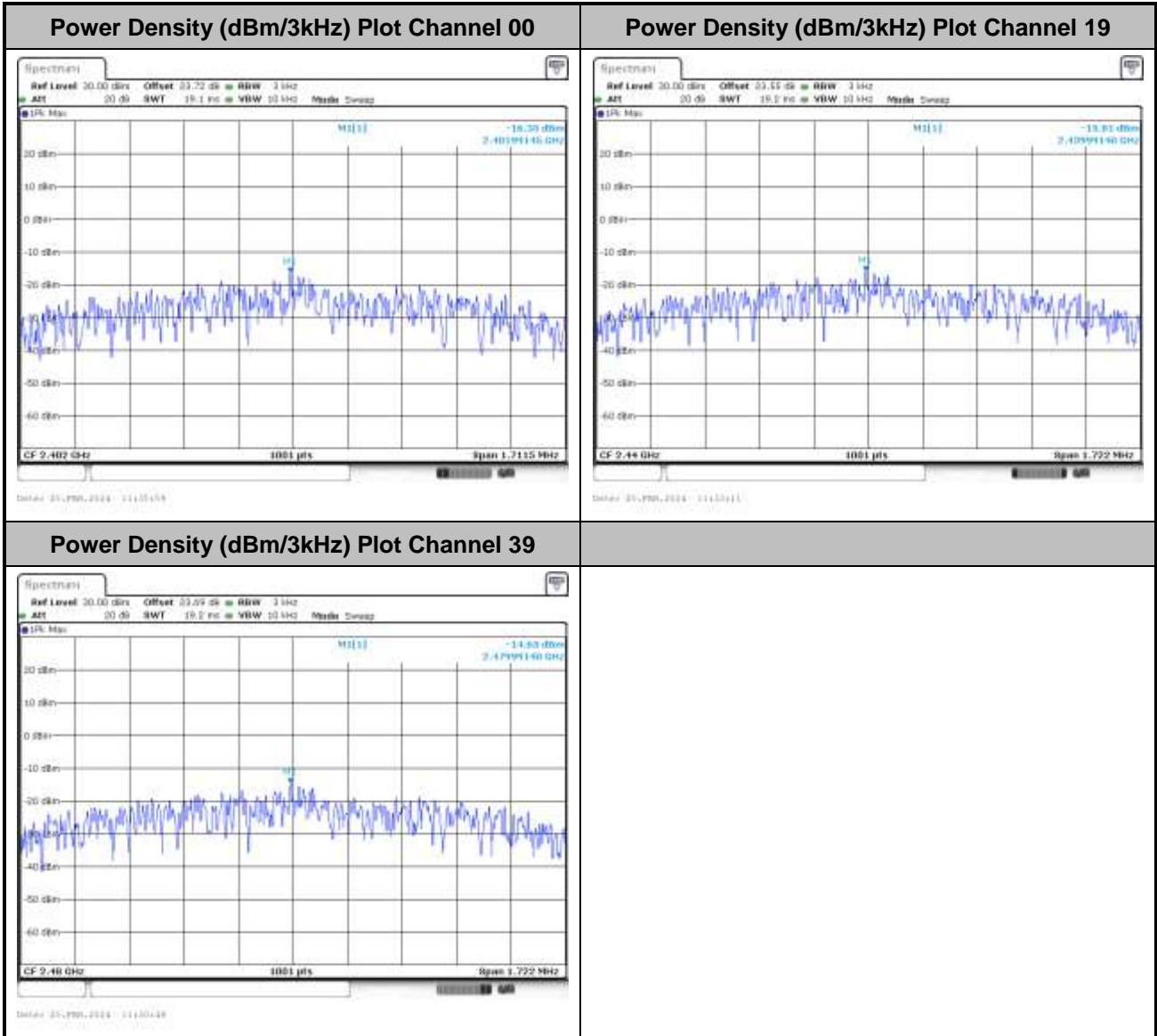



Band Edge and Conducted Spurious Emission

<1Mbps>

Channel 00

100kHz PSD reference Level Plot

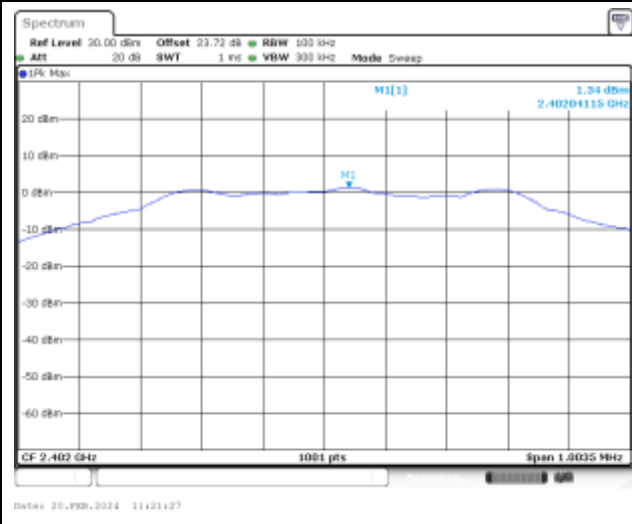

Low Channel Plot

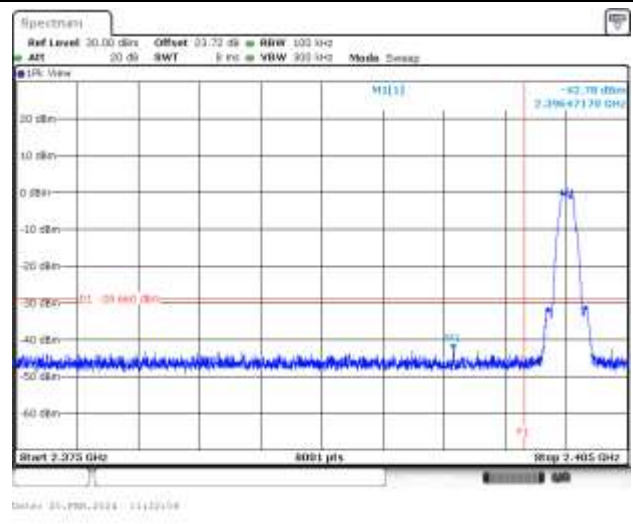

Spurious Emission 30MHz~1GHz Plot

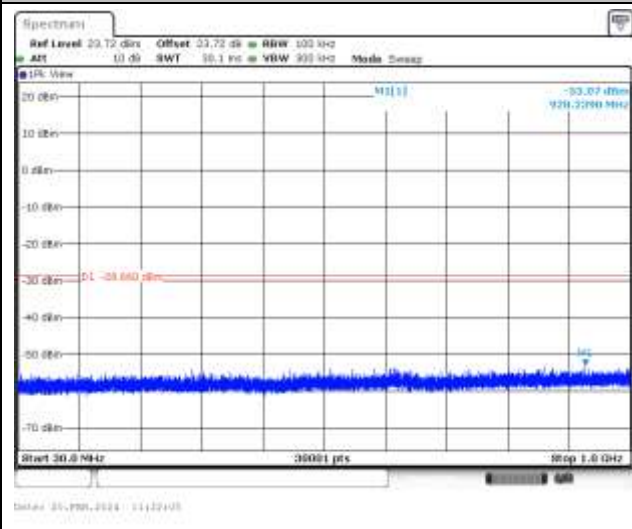

Spurious Emission 1GHz~26.5GHz Plot

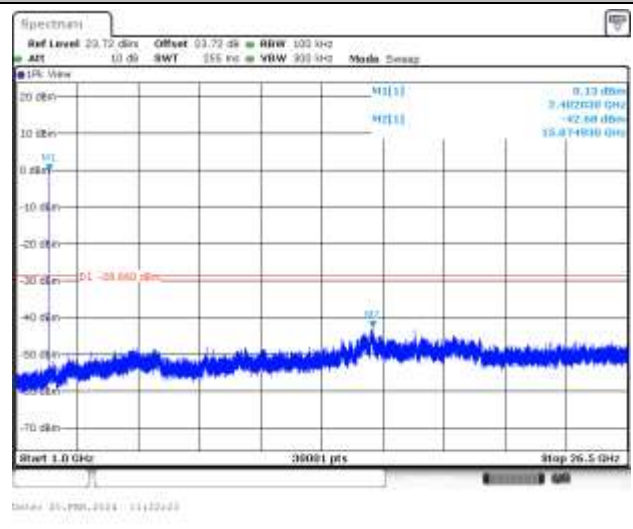



Channel 19

100kHz PSD reference Level Plot

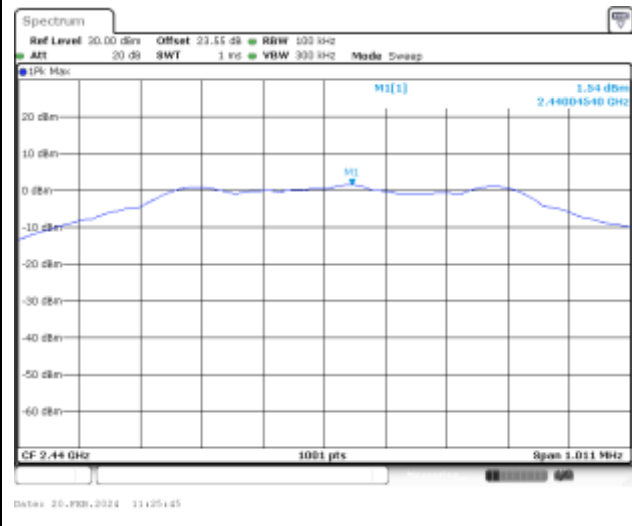

Mid Channel Plot



Spurious Emission 30MHz~1GHz Plot

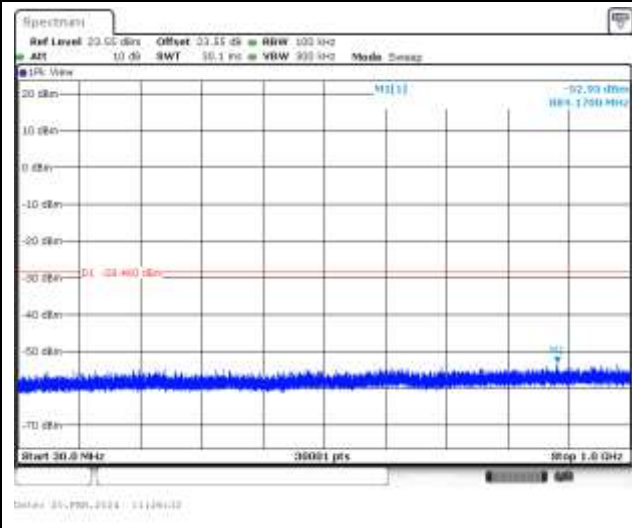

Spurious Emission 1GHz~26.5GHz Plot

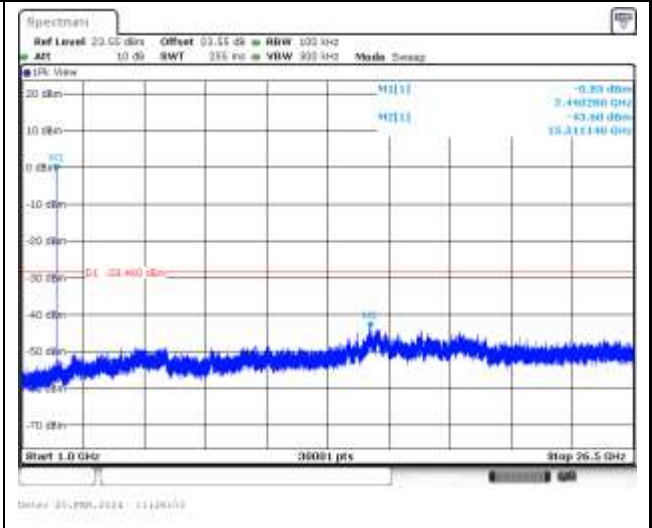



Channel 39

100kHz PSD reference Level Plot

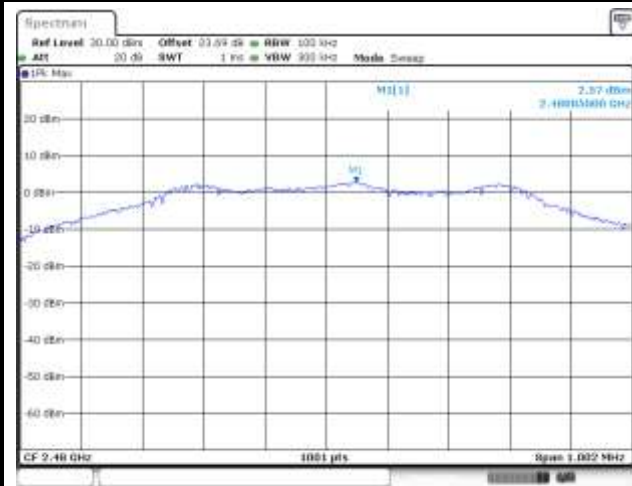

High Channel Plot

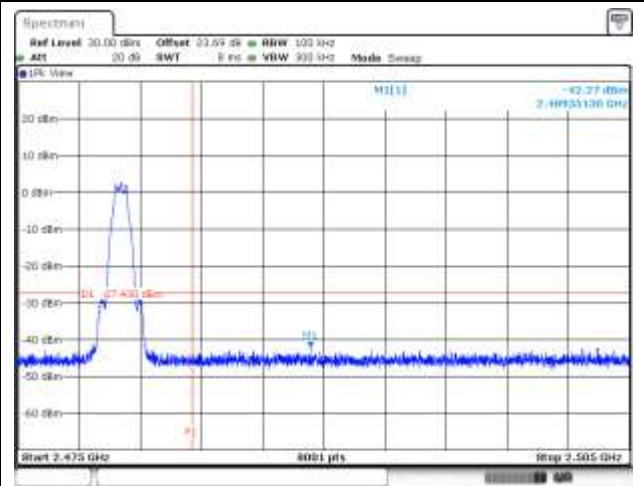

Spurious Emission 30MHz~1GHz Plot

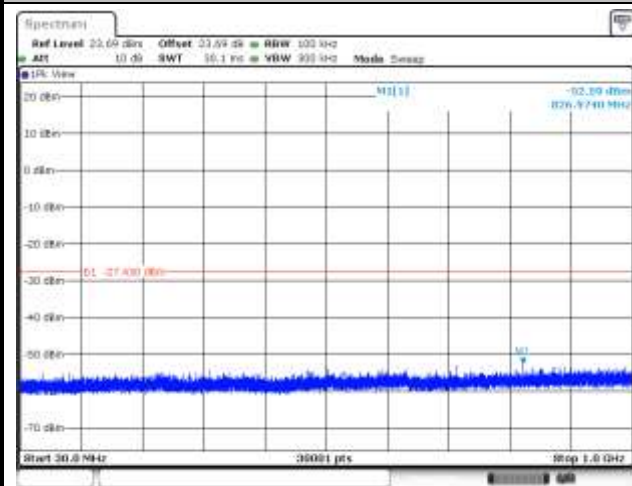

Spurious Emission 1GHz~26.5GHz Plot

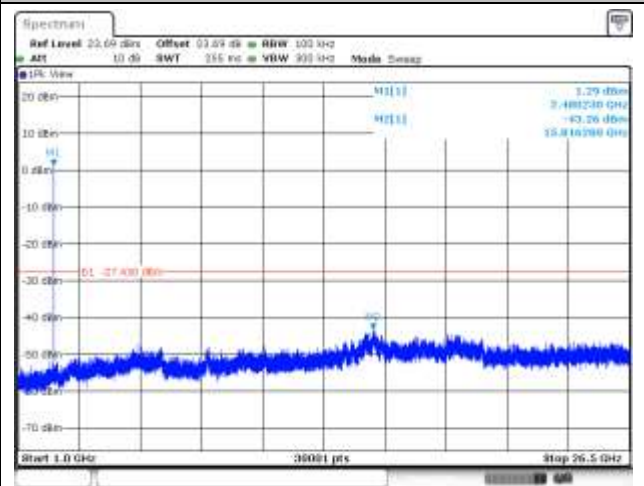



<2Mbps>

Channel 00

100kHz PSD reference Level Plot

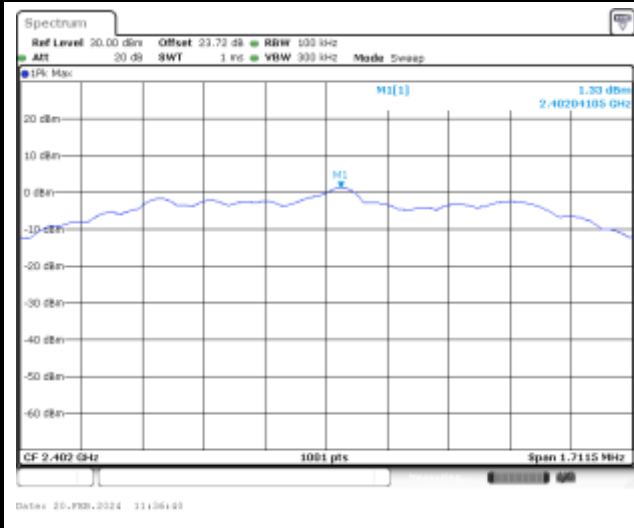

Low Channel Plot

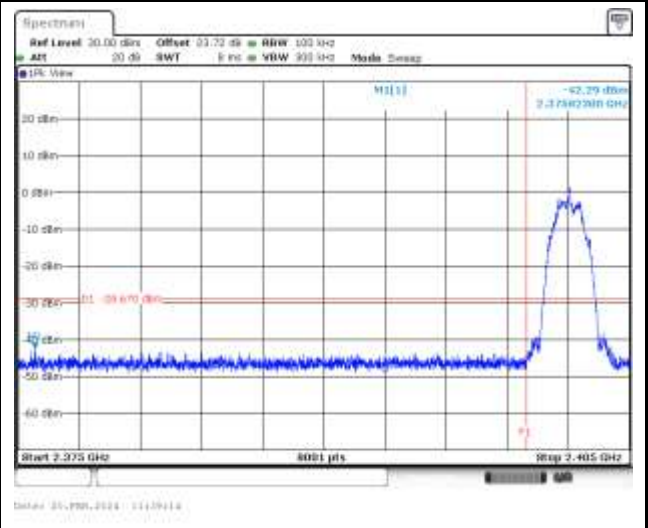

Spurious Emission 30MHz~1GHz Plot

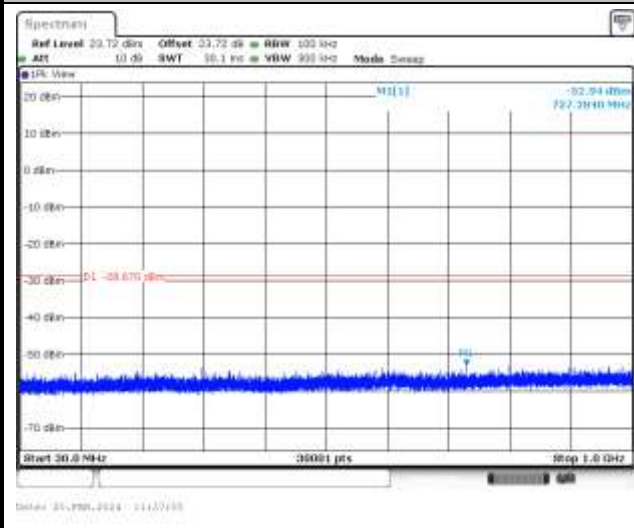

Spurious Emission 1GHz~26.5GHz Plot

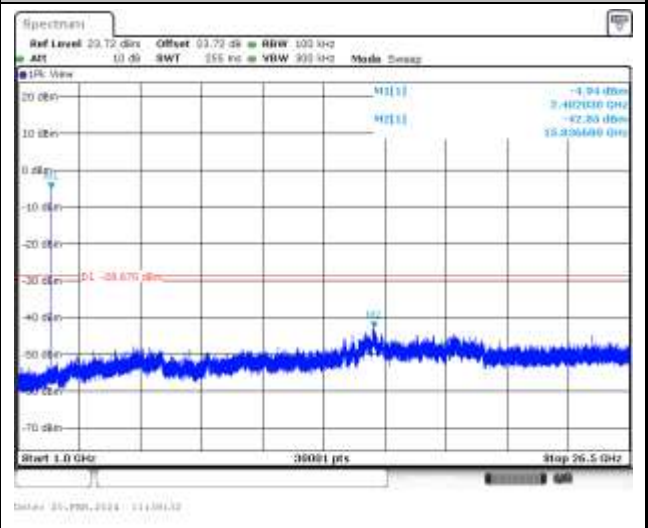



Channel 19

100kHz PSD reference Level Plot

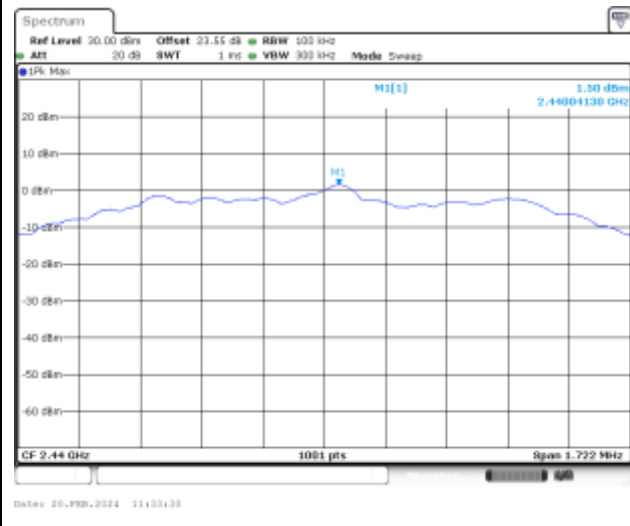

Mid Channel Plot



Spurious Emission 30MHz~1GHz Plot

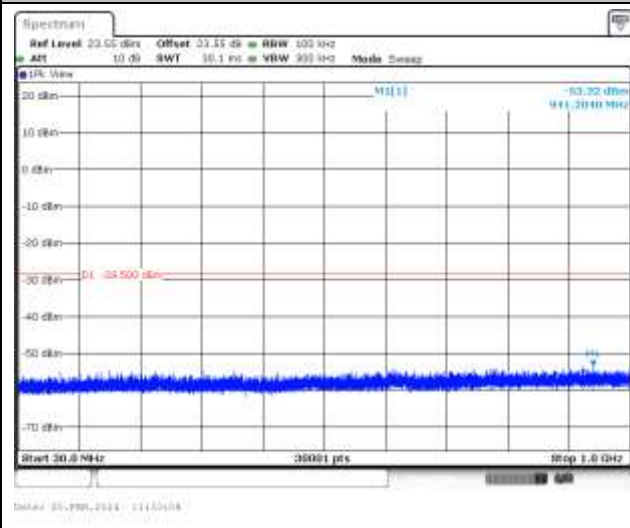

Spurious Emission 1GHz~26.5GHz Plot

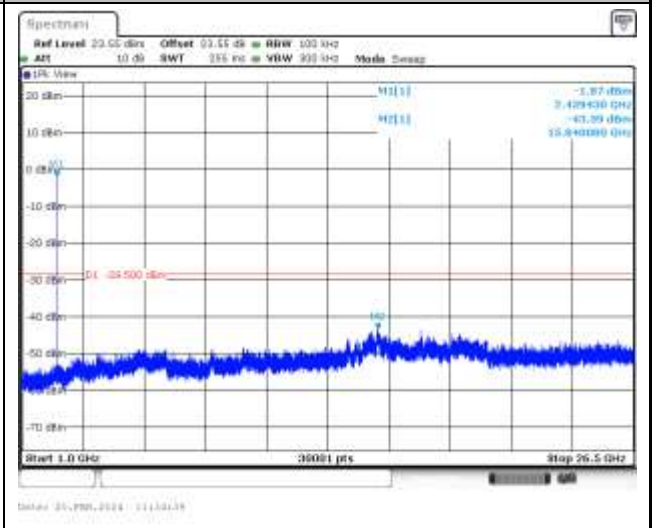



Channel 39

100kHz PSD reference Level Plot

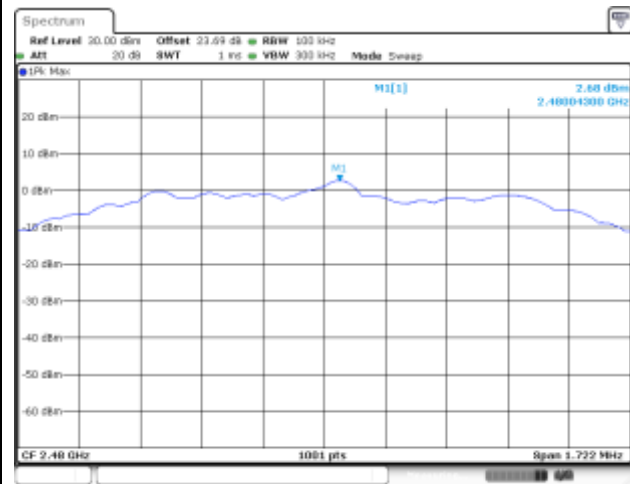

Date: 20-09-2024 11:31:11

High Channel Plot

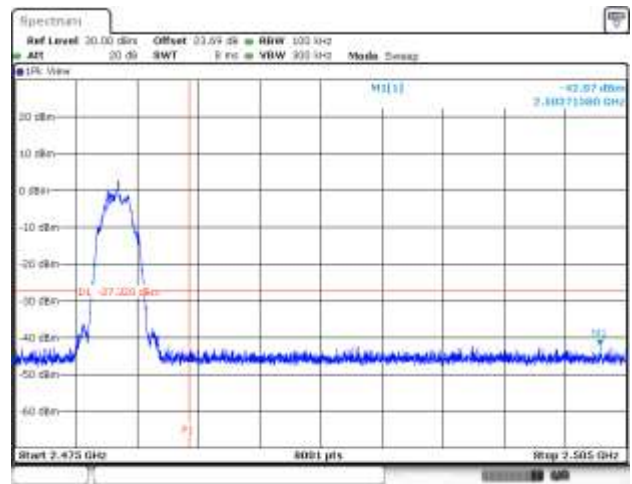

Date: 20-09-2024 11:32:00

Spurious Emission 30MHz~1GHz Plot

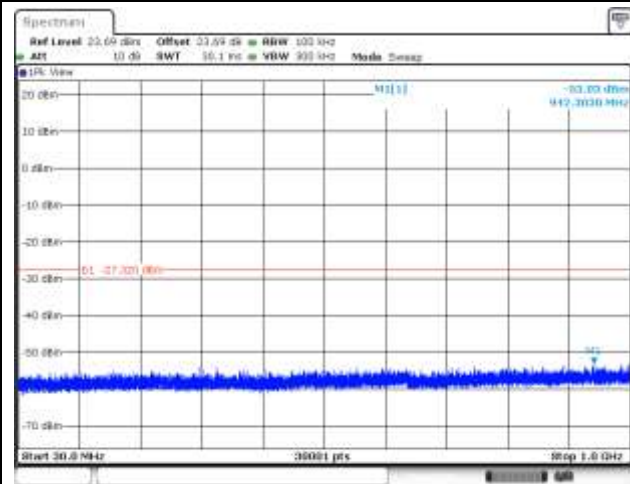

Date: 20-09-2024 11:31:28

Spurious Emission 1GHz~26.5GHz Plot

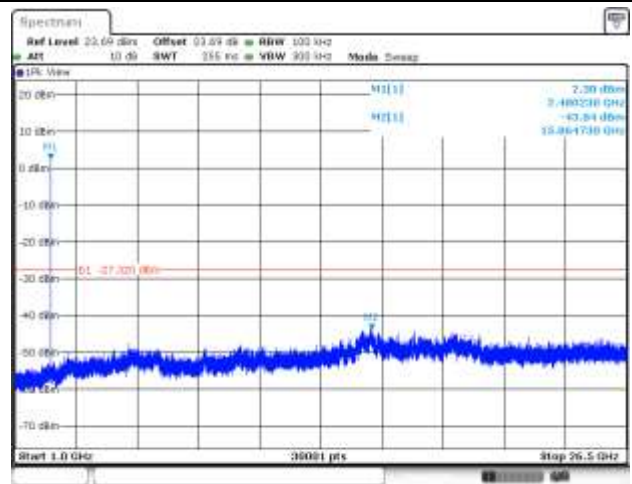

Date: 20-09-2024 11:31:48



Appendix B. AC Conducted Emission Test Results

Test Engineer :	Calvin Wang	Temperature :	23~26°C
		Relative Humidity :	45~55%

EUT Information

Report NO : 411111
 Test Mode : Mode 1
 Test Voltage : 120Vac/60Hz
 Phase : Line

Full Spectrum

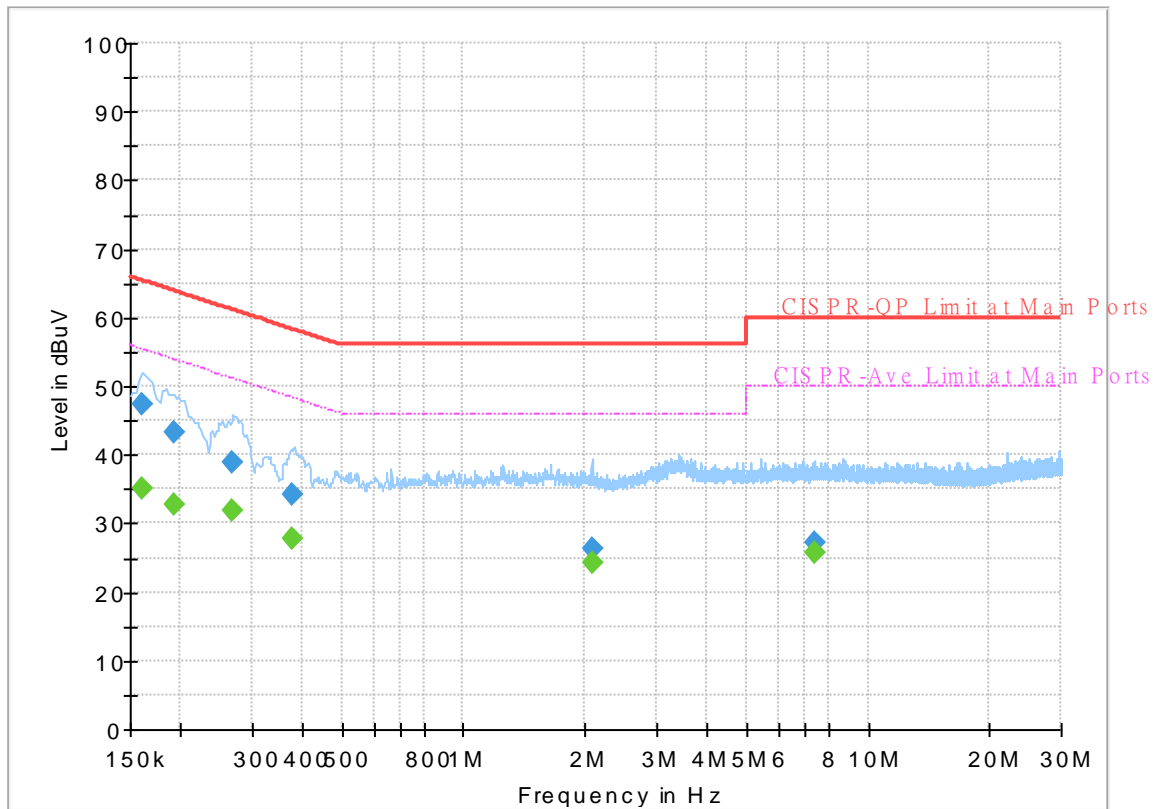

Final_Result

Frequency (MHz)	QuasiPeak (dBuV)	CAverage (dBuV)	Limit (dBuV)	Margin (dB)	Line	Filter	Corr. (dB)
0.161250	---	35.00	55.40	20.40	L1	OFF	19.8
0.161250	47.38	---	65.40	18.02	L1	OFF	19.8
0.192750	---	32.65	53.92	21.27	L1	OFF	19.8
0.192750	43.19	---	63.92	20.73	L1	OFF	19.8
0.269250	---	31.99	51.14	19.15	L1	OFF	19.8
0.269250	38.95	---	61.14	22.19	L1	OFF	19.8
0.377250	---	27.67	48.34	20.67	L1	OFF	19.8
0.377250	34.11	---	58.34	24.23	L1	OFF	19.8
2.073750	---	24.21	46.00	21.79	L1	OFF	19.9
2.073750	26.43	---	56.00	29.57	L1	OFF	19.9
7.345500	---	25.66	50.00	24.34	L1	OFF	20.0
7.345500	27.05	---	60.00	32.95	L1	OFF	20.0

EUT Information

Report NO : 411111
 Test Mode : Mode 1
 Test Voltage : 120Vac/60Hz
 Phase : Neutral

Full Spectrum

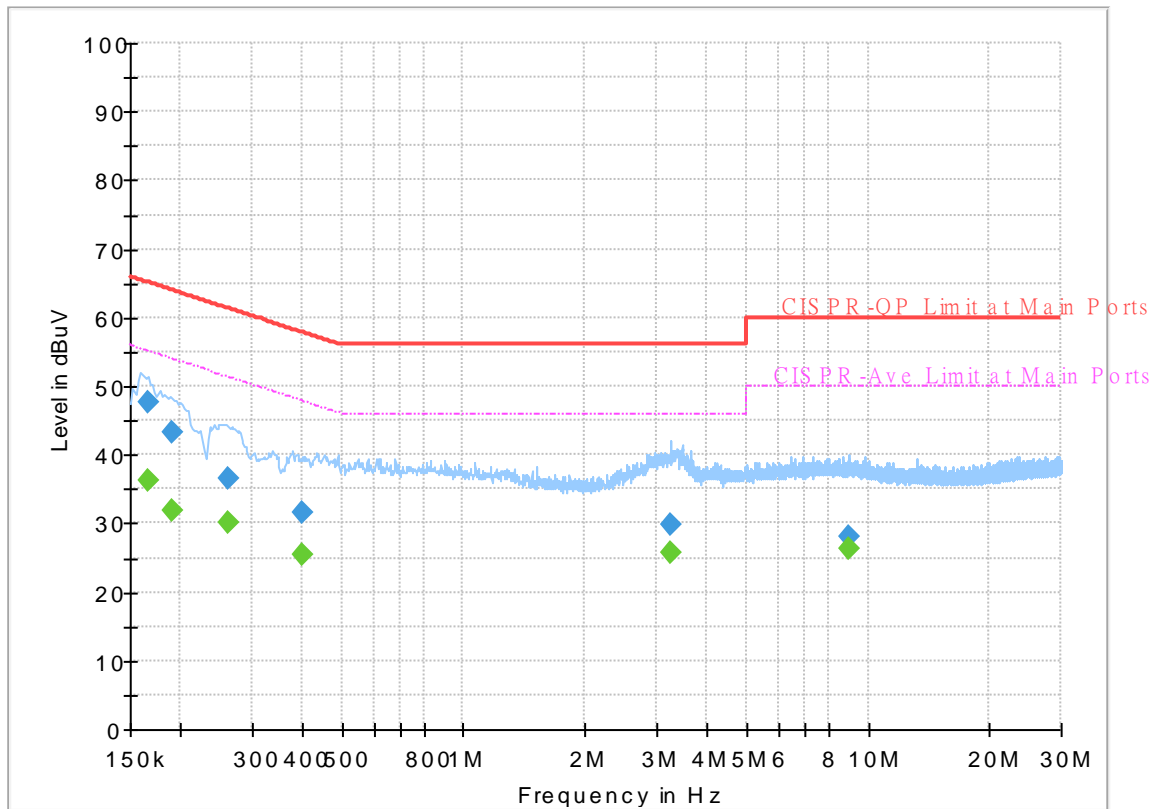

Final Result

Frequency (MHz)	QuasiPeak (dBuV)	CAverage (dBuV)	Limit (dBuV)	Margin (dB)	Line	Filter	Corr. (dB)
0.165750	---	36.31	55.17	18.86	N	OFF	19.8
0.165750	47.69	---	65.17	17.48	N	OFF	19.8
0.190500	---	31.97	54.02	22.05	N	OFF	19.8
0.190500	43.34	---	64.02	20.68	N	OFF	19.8
0.262500	---	30.23	51.35	21.12	N	OFF	19.8
0.262500	36.64	---	61.35	24.71	N	OFF	19.8
0.399750	---	25.52	47.86	22.34	N	OFF	19.8
0.399750	31.65	---	57.86	26.21	N	OFF	19.8
3.241500	---	25.66	46.00	20.34	N	OFF	19.9
3.241500	29.73	---	56.00	26.27	N	OFF	19.9
8.934000	---	26.24	50.00	23.76	N	OFF	20.1
8.934000	27.95	---	60.00	32.05	N	OFF	20.1



Appendix B. Radiated Spurious Emission

Test Engineer :	John Chuang, David Dai and Howard Huang	Temperature :	19.5~23.5°C
		Relative Humidity :	64.9~70.7%

<1Mbps>

2.4GHz 2400~2483.5MHz

BLE (Band Edge @ 3m)

BLE Ant	Note	Frequency (MHz)	Level (dBμV/m)	Margin (dB)	Limit Line (dBμV/m)	Read Level (dBμV)	Antenna Factor (dB/m)	Path Loss (dB)	Preamp Factor (dB)	Ant Pos (cm)	Table Pos (deg)	Peak Avg. (P/A)	Pol. (H/V)	
BLE CH 00 2402MHz		2364.075	50.13	-23.87	74	40.53	27.16	18.67	36.23	240	342	P	H	
		2366.385	40.15	-13.85	54	30.53	27.17	18.68	36.23	240	342	A	H	
	*	2402	104.1	-	-	94.3	27.31	18.74	36.25	240	342	P	H	
	*	2402	103.54	-	-	93.74	27.31	18.74	36.25	240	342	A	H	
													H	
			2358.195	49.82	-24.18	74	40.26	27.13	18.66	36.23	204	248	P	V
			2374.995	40.13	-13.87	54	30.48	27.2	18.69	36.24	204	248	A	V
	*		2402	102.05	-	-	92.25	27.31	18.74	36.25	204	248	P	V
	*		2402	101.46	-	-	91.66	27.31	18.74	36.25	204	248	A	V
														V
BLE CH 19 2440MHz		2376.56	49.78	-24.22	74	40.11	27.21	18.7	36.24	200	345	P	H	
		2385.2	40.08	-13.92	54	30.37	27.24	18.71	36.24	200	345	A	H	
	*	2440	105.17	-	-	95.16	27.46	18.81	36.26	200	345	P	H	
	*	2440	104.62	-	-	94.61	27.46	18.81	36.26	200	345	A	H	
			2492.56	50.69	-23.31	74	40.39	27.67	18.91	36.28	200	345	P	H
			2487.44	40.64	-13.36	54	30.37	27.65	18.9	36.28	200	345	A	H
			2388.56	50.66	-23.34	74	40.93	27.25	18.72	36.24	200	239	P	V
			2363.76	40.27	-13.73	54	30.67	27.16	18.67	36.23	200	239	A	V
	*		2440	100.61	-	-	90.6	27.46	18.81	36.26	200	239	P	V
	*		2440	100.02	-	-	90.01	27.46	18.81	36.26	200	239	A	V
			2485.6	50.03	-23.97	74	39.77	27.64	18.9	36.28	200	239	P	V
			2488.88	41.1	-12.9	54	30.82	27.66	18.9	36.28	200	239	A	V



BLE Ant 6	Note	Frequency (MHz)	Level (dBμV/m)	Margin (dB)	Limit Line (dBμV/m)	Read Level (dBμV)	Antenna Factor (dB/m)	Path Loss (dB)	Preamp Factor (dB)	Ant Pos (cm)	Table Pos (deg)	Peak Avg. (P/A)	Pol. (H/V)	
BLE CH 39 2480MHz	*	2480	103.49	-	-	93.25	27.62	18.89	36.27	100	342	P	H	
	*	2480	102.91	-	-	92.67	27.62	18.89	36.27	100	342	A	H	
		2498.88	50.41	-23.59	74	40.07	27.7	18.92	36.28	100	342	P	H	
		2484.16	40.8	-13.2	54	30.53	27.64	18.9	36.27	100	342	A	H	
													H	
													H	
	*	2480	99.57	-	-	89.33	27.62	18.89	36.27	400	252	P	V	
	*	2480	99.04	-	-	88.8	27.62	18.89	36.27	400	252	A	V	
		2485	50.32	-23.68	74	40.05	27.64	18.9	36.27	400	252	P	V	
		2498.76	40.65	-13.35	54	30.31	27.7	18.92	36.28	400	252	A	V	
													V	
													V	
	Remark	1. No other spurious found. 2. All results are PASS against Peak and Average limit line.												



2.4GHz 2400~2483.5MHz
BLE (Harmonic @ 3m)

BLE Ant 6	Note	Frequency (MHz)	Level (dBµV/m)	Margin (dB)	Limit Line (dBµV/m)	Read Level (dBµV)	Antenna Factor (dB/m)	Path Loss (dB)	Preamp Factor (dB)	Ant Pos (cm)	Table Pos (deg)	Peak Avg. (P/A)	Pol. (H/V)
BLE CH 00		4804	43.85	-30.15	74	36.03	32.4	12.92	37.5	-	-	P	H
													H
													H
													H
													H
													H
													H
													H
													H
													H
2402MHz		4804	42.46	-31.54	74	34.64	32.4	12.92	37.5	-	-	P	V
													V
													V
													V
													V
													V
													V
													V
													V
													V



BLE Ant 6	Note	Frequency (MHz)	Level (dBµV/m)	Margin (dB)	Limit Line (dBµV/m)	Read Level (dBµV)	Antenna Factor (dB/m)	Path Loss (dB)	Preamp Factor (dB)	Ant Pos (cm)	Table Pos (deg)	Peak Avg. (P/A)	Pol. (H/V)	
BLE CH 19 2440MHz		4880	43.08	-30.92	74	35.05	32.52	13.07	37.56	-	-	P	H	
		7320	48.48	-25.52	74	34.23	36.9	15.96	38.61	100	45	P	H	
		7320	39.23	-14.77	54	24.98	36.9	15.96	38.61	100	45	A	H	
													H	
													H	
													H	
													H	
													H	
													H	
													H	
													H	
													H	
			4880	43.75	-30.25	74	35.72	32.52	13.07	37.56	-	-	P	V
			7320	49.1	-24.9	74	34.85	36.9	15.96	38.61	200	267	P	V
			7320	39.5	-14.5	54	25.25	36.9	15.96	38.61	200	267	A	V
														V
														V
														V
														V
													V	
													V	
													V	
													V	



BLE Ant 6	Note	Frequency (MHz)	Level (dBμV/m)	Margin (dB)	Limit Line (dBμV/m)	Read Level (dBμV)	Antenna Factor (dB/m)	Path Loss (dB)	Preamp Factor (dB)	Ant Pos (cm)	Table Pos (deg)	Peak Avg. (P/A)	Pol. (H/V)
BLE CH 39 2480MHz		4960	44.1	-29.9	74	35.56	32.94	13.23	37.63	-	-	P	H
		7440	47.48	-26.52	74	33.55	36.52	16.12	38.71	-	-	P	H
													H
													H
													H
													H
													H
													H
													H
													H
													H
													H
													H
													H
													H
													H
													H
													H
													H
			4960	43.64	-30.36	74	35.1	32.94	13.23	37.63	-	-	P
		7440	47.57	-26.43	74	33.64	36.52	16.12	38.71	-	-	P	V
													V
													V
													V
													V
													V
													V
													V
													V
													V
													V
													V
													V
													V
													V
Remark	1. No other spurious found. 2. All results are PASS against Peak and Average limit line. 3. The emission position marked as "-" means no suspected emission found with sufficient margin against limit line or noise floor only.												



2.4GHz 2400~2483.5MHz

BLE (Band Edge @ 3m)

BLE	Note	Frequency	Level	Margin	Limit	Read	Antenna	Path	Preamp	Ant	Table	Peak	Pol.	
Ant					Line	Level	Factor	Loss	Factor	Pos	Pos	Avg.		
7		(MHz)	(dBμV/m)	(dB)	(dBμV/m)	(dBμV)	(dB/m)	(dB)	(dB)	(cm)	(deg)	(P/A)	(H/V)	
BLE CH 00 2402MHz		2342.34	50.43	-23.57	74	40.93	27.1	18.63	36.23	126	343	P	H	
		2382.555	40.08	-13.92	54	30.38	27.23	18.71	36.24	126	343	A	H	
	*	2402	104.52	-	-	94.72	27.31	18.74	36.25	126	343	P	H	
	*	2402	104.01	-	-	94.21	27.31	18.74	36.25	126	343	A	H	
													H	
													H	
			2364.39	49.89	-24.11	74	40.29	27.16	18.67	36.23	103	298	P	V
			2363.13	40.03	-13.97	54	30.44	27.15	18.67	36.23	103	298	A	V
	*		2402	101.81	-	-	92.01	27.31	18.74	36.25	103	298	P	V
	*		2402	101.28	-	-	91.48	27.31	18.74	36.25	103	298	A	V
													V	
													V	
BLE CH 19 2440MHz		2386.64	49.45	-24.55	74	39.73	27.25	18.71	36.24	201	345	P	H	
		2330.48	39.89	-14.11	54	30.4	27.1	18.61	36.22	201	345	A	H	
	*	2440	104.91	-	-	94.9	27.46	18.81	36.26	201	345	P	H	
	*	2440	104.41	-	-	94.4	27.46	18.81	36.26	201	345	A	H	
			2493.2	49.69	-24.31	74	39.39	27.67	18.91	36.28	201	345	P	H
			2492.96	40.37	-13.63	54	30.07	27.67	18.91	36.28	201	345	A	H
			2319.76	50.37	-23.63	74	40.9	27.1	18.59	36.22	100	239	P	V
			2373.36	40.14	-13.86	54	30.5	27.19	18.69	36.24	100	239	A	V
	*		2440	100.87	-	-	90.86	27.46	18.81	36.26	100	239	P	V
	*		2440	100.3	-	-	90.29	27.46	18.81	36.26	100	239	A	V
			2497.92	50.32	-23.68	74	39.99	27.69	18.92	36.28	100	239	P	V
			2495.04	40.44	-13.56	54	30.12	27.68	18.92	36.28	100	239	A	V



BLE Ant 7	Note	Frequency (MHz)	Level (dBμV/m)	Margin (dB)	Limit Line (dBμV/m)	Read Level (dBμV)	Antenna Factor (dB/m)	Path Loss (dB)	Preamp Factor (dB)	Ant Pos (cm)	Table Pos (deg)	Peak Avg. (P/A)	Pol. (H/V)	
BLE CH 39 2480MHz	*	2480	103.97	-	-	93.73	27.62	18.89	36.27	299	345	P	H	
	*	2480	103.42	-	-	93.18	27.62	18.89	36.27	299	345	A	H	
		2496.48	50.56	-23.44	74	40.23	27.69	18.92	36.28	299	345	P	H	
		2483.84	40.72	-13.28	54	30.45	27.64	18.9	36.27	299	345	A	H	
													H	
													H	
	*	2480	99.5	-	-	89.26	27.62	18.89	36.27	306	269	P	V	
	*	2480	98.99	-	-	88.75	27.62	18.89	36.27	306	269	A	V	
		2496.12	50.34	-23.66	74	40.02	27.68	18.92	36.28	306	269	P	V	
		2485.24	40.61	-13.39	54	30.34	27.64	18.9	36.27	306	269	A	V	
													V	
													V	
	Remark	1. No other spurious found. 2. All results are PASS against Peak and Average limit line.												



2.4GHz 2400~2483.5MHz
BLE (Harmonic @ 3m)

BLE Ant 7	Note	Frequency (MHz)	Level (dBμV/m)	Margin (dB)	Limit Line (dBμV/m)	Read Level (dBμV)	Antenna Factor (dB/m)	Path Loss (dB)	Preamp Factor (dB)	Ant Pos (cm)	Table Pos (deg)	Peak Avg. (P/A)	Pol. (H/V)
BLE CH 00 2402MHz		4804	42.95	-31.05	74	35.13	32.4	12.92	37.5	-	-	P	H
													H
													H
													H
													H
													H
													H
													H
													H
													H
													H
BLE CH 00 2402MHz		4804	43.43	-30.57	74	35.61	32.4	12.92	37.5	-	-	P	V
													V
													V
													V
													V
													V
													V
													V
													V
													V
													V



BLE Ant 7	Note	Frequency (MHz)	Level (dBμV/m)	Margin (dB)	Limit Line (dBμV/m)	Read Level (dBμV)	Antenna Factor (dB/m)	Path Loss (dB)	Preamp Factor (dB)	Ant Pos (cm)	Table Pos (deg)	Peak Avg. (P/A)	Pol. (H/V)	
BLE CH 19 2440MHz		4880	43.69	-30.31	74	35.66	32.52	13.07	37.56	-	-	P	H	
		7320	47.95	-26.05	74	33.7	36.9	15.96	38.61	-	-	P	H	
													H	
													H	
													H	
													H	
													H	
													H	
													H	
													H	
													H	
													H	
			4880	43.44	-30.56	74	35.41	32.52	13.07	37.56	-	-	P	V
			7320	47.87	-26.13	74	33.62	36.9	15.96	38.61	-	-	P	V
														V
														V
														V
														V
														V
														V
													V	
													V	



BLE Ant 7	Note	Frequency (MHz)	Level (dBμV/m)	Margin (dB)	Limit Line (dBμV/m)	Read Level (dBμV)	Antenna Factor (dB/m)	Path Loss (dB)	Preamp Factor (dB)	Ant Pos (cm)	Table Pos (deg)	Peak Avg. (P/A)	Pol. (H/V)
BLE CH 39 2480MHz		4960	44.39	-29.61	74	35.85	32.94	13.23	37.63	-	-	P	H
		7440	46.85	-27.15	74	32.92	36.52	16.12	38.71	-	-	P	H
													H
													H
													H
													H
													H
													H
													H
													H
													H
													H
													H
													H
													H
													H
													H
													H
													H
			4960	44.48	-29.52	74	35.94	32.94	13.23	37.63	-	-	P
		7440	47.29	-26.71	74	33.36	36.52	16.12	38.71	-	-	P	V
													V
													V
													V
													V
													V
													V
													V
													V
													V
													V
													V
													V
													V
													V
													V
Remark	1. No other spurious found. 2. All results are PASS against Peak and Average limit line. 3. The emission position marked as "-" means no suspected emission found with sufficient margin against limit line or noise floor only.												



<2Mbps>

2.4GHz 2400~2483.5MHz

BLE (Band Edge @ 3m)

BLE Ant	Note	Frequency	Level	Margin	Limit Line	Read Level	Antenna Factor	Path Loss	Preamp Factor	Ant Pos	Table Pos	Peak Avg.	Pol.	
6		(MHz)	(dBμV/m)	(dB)	(dBμV/m)	(dBμV)	(dB/m)	(dB)	(dB)	(cm)	(deg)	(P/A)	(H/V)	
BLE CH 00 2402MHz		2373	50.65	-23.35	74	41.01	27.19	18.69	36.24	100	340	P	H	
		2350.845	40.95	-13.05	54	31.43	27.1	18.65	36.23	100	340	A	H	
	*	2402	104.13	-	-	94.33	27.31	18.74	36.25	100	340	P	H	
	*	2402	102.79	-	-	92.99	27.31	18.74	36.25	100	340	A	H	
													H	
													H	
			2321.655	50.45	-23.55	74	40.98	27.1	18.59	36.22	200	250	P	V
			2357.565	40.82	-13.18	54	31.26	27.13	18.66	36.23	200	250	A	V
	*		2402	101.75	-	-	91.95	27.31	18.74	36.25	200	250	P	V
	*		2402	100.42	-	-	90.62	27.31	18.74	36.25	200	250	A	V
													V	
													V	
BLE CH 19 2440MHz		2387.44	49.88	-24.12	74	40.15	27.25	18.72	36.24	200	344	P	H	
		2370.8	41.04	-12.96	54	31.42	27.18	18.68	36.24	200	344	A	H	
	*	2440	105.19	-	-	95.18	27.46	18.81	36.26	200	344	P	H	
	*	2440	103.79	-	-	93.78	27.46	18.81	36.26	200	344	A	H	
			2493.6	50.17	-23.83	74	39.87	27.67	18.91	36.28	200	344	P	H
			2499.28	41.21	-12.79	54	30.87	27.7	18.92	36.28	200	344	A	H
			2355.44	50.14	-23.86	74	40.59	27.12	18.66	36.23	250	242	P	V
			2324.56	40.89	-13.11	54	31.41	27.1	18.6	36.22	250	242	A	V
	*		2440	101.39	-	-	91.38	27.46	18.81	36.26	250	242	P	V
	*		2440	99.98	-	-	89.97	27.46	18.81	36.26	250	242	A	V
			2486.8	49.92	-24.08	74	39.65	27.65	18.9	36.28	250	242	P	V
			2484.96	41.61	-12.39	54	31.34	27.64	18.9	36.27	250	242	A	V



BLE Ant 6	Note	Frequency (MHz)	Level (dBμV/m)	Margin (dB)	Limit Line (dBμV/m)	Read Level (dBμV)	Antenna Factor (dB/m)	Path Loss (dB)	Preamp Factor (dB)	Ant Pos (cm)	Table Pos (deg)	Peak Avg. (P/A)	Pol. (H/V)	
BLE CH 39 2480MHz	*	2480	104.1	-	-	93.86	27.62	18.89	36.27	300	344	P	H	
	*	2480	102.7	-	-	92.46	27.62	18.89	36.27	300	344	A	H	
		2483.52	52.14	-21.86	74	41.89	27.63	18.89	36.27	300	344	P	H	
		2483.64	42.05	-11.95	54	31.8	27.63	18.89	36.27	300	344	A	H	
													H	
													H	
	*	2480	99.81	-	-	89.57	27.62	18.89	36.27	350	277	P	V	
	*	2480	98.46	-	-	88.22	27.62	18.89	36.27	350	277	A	V	
		2499.2	50.3	-23.7	74	39.96	27.7	18.92	36.28	350	277	P	V	
		2492.88	41.5	-12.5	54	31.2	27.67	18.91	36.28	350	277	A	V	
													V	
													V	
	Remark	1. No other spurious found. 2. All results are PASS against Peak and Average limit line.												



2.4GHz 2400~2483.5MHz
BLE (Harmonic @ 3m)

BLE Ant 6	Note	Frequency (MHz)	Level (dBµV/m)	Margin (dB)	Limit Line (dBµV/m)	Read Level (dBµV)	Antenna Factor (dB/m)	Path Loss (dB)	Preamp Factor (dB)	Ant Pos (cm)	Table Pos (deg)	Peak Avg. (P/A)	Pol. (H/V)
BLE CH 00		4804	42.85	-31.15	74	35.03	32.4	12.92	37.5	-	-	P	H
													H
													H
													H
													H
													H
													H
													H
													H
													H
2402MHz		4804	43.5	-30.5	74	35.68	32.4	12.92	37.5	-	-	P	V
													V
													V
													V
													V
													V
													V
													V
													V
													V



BLE Ant 6	Note	Frequency (MHz)	Level (dBμV/m)	Margin (dB)	Limit Line (dBμV/m)	Read Level (dBμV)	Antenna Factor (dB/m)	Path Loss (dB)	Preamp Factor (dB)	Ant Pos (cm)	Table Pos (deg)	Peak Avg. (P/A)	Pol. (H/V)	
BLE CH 19 2440MHz		4880	43.93	-30.07	74	35.9	32.52	13.07	37.56	-	-	P	H	
		7320	48.66	-25.34	74	34.41	36.9	15.96	38.61	350	108	P	H	
		7320	38.89	-15.11	54	24.64	36.9	15.96	38.61	350	108	A	H	
													H	
													H	
													H	
													H	
													H	
													H	
													H	
													H	
			4880	42.81	-31.19	74	34.78	32.52	13.07	37.56	-	-	P	V
			7320	48.51	-25.49	74	34.26	36.9	15.96	38.61	300	305	P	V
			7320	39.15	-14.85	54	24.9	36.9	15.96	38.61	300	305	A	V
														V
														V
														V
														V
														V
														V
													V	
													V	
													V	



BLE Ant 6	Note	Frequency (MHz)	Level (dBμV/m)	Margin (dB)	Limit Line (dBμV/m)	Read Level (dBμV)	Antenna Factor (dB/m)	Path Loss (dB)	Preamp Factor (dB)	Ant Pos (cm)	Table Pos (deg)	Peak Avg. (P/A)	Pol. (H/V)
BLE CH 39 2480MHz		4960	43.48	-30.52	74	34.94	32.94	13.23	37.63	-	-	P	H
		7440	47.84	-26.16	74	33.91	36.52	16.12	38.71	-	-	P	H
													H
													H
													H
													H
													H
													H
													H
													H
													H
													H
													H
													H
													H
													H
													H
													H
													H
			4960	44.41	-29.59	74	35.87	32.94	13.23	37.63	-	-	P
		7440	47.16	-26.84	74	33.23	36.52	16.12	38.71	-	-	P	V
													V
													V
													V
													V
													V
													V
													V
													V
													V
													V
													V
													V
													V
													V
Remark	<ol style="list-style-type: none"> No other spurious found. All results are PASS against Peak and Average limit line. The emission position marked as "-" means no suspected emission found with sufficient margin against limit line or noise floor only. 												



Emission above 18GHz

2.4GHz BLE (SHF)

BT	Note	Frequency	Level	Margin	Limit	Read	Antenna	Path	Preamp	Ant	Table	Peak	Pol.
Ant					Line	Level	Factor	Loss	Factor	Pos	Pos	Avg.	
6		(MHz)	(dBμV/m)	(dB)	(dBμV/m)	(dBμV)	(dB/m)	(dB)	(dB)	(cm)	(deg)	(P/A)	(H/V)
2.4GHz BLE SHF		24573	41.54	-32.46	74	36.31	39.38	19.32	53.47	-	-	P	H
													H
													H
													H
													H
													H
													H
													H
													H
													H
													H
													H
													H
													H
													H
													H
													H
													H
													H
			24839	41.98	-32.02	74	36.17	39.71	19.46	53.36	-	-	P
													V
													V
													V
													V
													V
													V
													V
													V
													V
													V
													V
													V
													V
													V
Remark	1. No other spurious found. 2. All results are PASS against limit line. 3. The emission position marked as "-" means no suspected emission found with sufficient margin against limit line or noise floor only.												



Emission below 1GHz

2.4GHz BLE (LF)

BLE	Note	Frequency	Level	Margin	Limit	Read	Antenna	Path	Preamp	Ant	Table	Peak	Pol.	
Ant					Line	Level	Factor	Loss	Factor	Pos	Pos	Avg.		
6		(MHz)	(dBμV/m)	(dB)	(dBμV/m)	(dBμV)	(dB/m)	(dB)	(dB)	(cm)	(deg)	(P/A)	(H/V)	
2.4GHz BLE LF		31.02	24.3	-15.7	40	34.14	24.45	1.3	35.59	-	-	P	H	
		94.26	27.88	-15.62	43.5	46.28	15.21	1.9	35.51	-	-	P	H	
		149.51	27.75	-15.75	43.5	43.34	17.45	2.39	35.43	-	-	P	H	
		353.6	23.69	-22.31	46	34.46	20.6	3.56	34.93	-	-	P	H	
		744	33.27	-12.73	46	33.65	28.23	5.09	33.7	-	-	P	H	
		978.4	36.55	-17.45	54	32.82	30.69	5.88	32.84	-	-	P	H	
														H
														H
														H
														H
														H
														H
			52.61	32.7	-7.3	40	53.23	13.58	1.46	35.57	-	-	P	V
			92.73	28.41	-15.09	43.5	47.01	15.03	1.89	35.52	-	-	P	V
			184.02	23.8	-19.7	43.5	41.55	15.01	2.6	35.36	-	-	P	V
			263.2	21.72	-24.28	46	33.58	20.28	3.06	35.2	-	-	P	V
			662.4	30.37	-15.63	46	33.23	26.43	4.8	34.09	-	-	P	V
			945.6	35.77	-10.23	46	32.42	30.59	5.76	33	-	-	P	V
														V
														V
													V	
													V	
													V	
													V	
Remark	1. No other spurious found. 2. All results are PASS against limit line. 3. The emission position marked as "-" means no suspected emission found and emission level has at least 6dB margin against limit or emission is noise floor only.													



2.4GHz 2400~2483.5MHz

BLE (Band Edge @ 3m)

BLE	Note	Frequency	Level	Margin	Limit	Read	Antenna	Path	Preamp	Ant	Table	Peak	Pol.	
Ant					Line	Level	Factor	Loss	Factor	Pos	Pos	Avg.		
7		(MHz)	(dBμV/m)	(dB)	(dBμV/m)	(dBμV)	(dB/m)	(dB)	(dB)	(cm)	(deg)	(P/A)	(H/V)	
BLE CH 00 2402MHz		2386.965	49.95	-24.05	74	40.22	27.25	18.72	36.24	129	342	P	H	
		2372.055	40.87	-13.13	54	31.23	27.19	18.69	36.24	129	342	A	H	
	*	2402	104.95	-	-	95.15	27.31	18.74	36.25	129	342	P	H	
	*	2402	103.59	-	-	93.79	27.31	18.74	36.25	129	342	A	H	
													H	
													H	
			2368.275	50.52	-23.48	74	40.91	27.17	18.68	36.24	101	298	P	V
			2385.495	40.73	-13.27	54	31.02	27.24	18.71	36.24	101	298	A	V
	*		2402	101.58	-	-	91.78	27.31	18.74	36.25	101	298	P	V
	*		2402	100.22	-	-	90.42	27.31	18.74	36.25	101	298	A	V
													V	
													V	
BLE CH 19 2440MHz		2314.64	49.76	-24.24	74	40.3	27.1	18.58	36.22	201	345	P	H	
		2374.16	40.89	-13.11	54	31.24	27.2	18.69	36.24	201	345	A	H	
	*	2440	105.35	-	-	95.34	27.46	18.81	36.26	201	345	P	H	
	*	2440	103.91	-	-	93.9	27.46	18.81	36.26	201	345	A	H	
			2487.28	50.18	-23.82	74	39.91	27.65	18.9	36.28	201	345	P	H
			2486.64	41.3	-12.7	54	31.03	27.65	18.9	36.28	201	345	A	H
			2341.04	49.6	-24.4	74	40.1	27.1	18.63	36.23	100	239	P	V
			2362.48	41.12	-12.88	54	31.53	27.15	18.67	36.23	100	239	A	V
	*		2440	100.66	-	-	90.65	27.46	18.81	36.26	100	239	P	V
	*		2440	99.26	-	-	89.25	27.46	18.81	36.26	100	239	A	V
			2491.36	49.48	-24.52	74	39.18	27.67	18.91	36.28	100	239	P	V
			2491.84	41.36	-12.64	54	31.06	27.67	18.91	36.28	100	239	A	V



BLE Ant 7	Note	Frequency (MHz)	Level (dBμV/m)	Margin (dB)	Limit Line (dBμV/m)	Read Level (dBμV)	Antenna Factor (dB/m)	Path Loss (dB)	Preamp Factor (dB)	Ant Pos (cm)	Table Pos (deg)	Peak Avg. (P/A)	Pol. (H/V)
BLE CH 39 2480MHz	*	2480	104.55	-	-	94.31	27.62	18.89	36.27	298	346	P	H
	*	2480	103.19	-	-	92.95	27.62	18.89	36.27	298	346	A	H
		2483.6	52.68	-21.32	74	42.43	27.63	18.89	36.27	298	346	P	H
		2483.52	41.92	-12.08	54	31.67	27.63	18.89	36.27	298	346	A	H
													H
													H
	*	2480	99.72	-	-	89.48	27.62	18.89	36.27	400	256	P	V
	*	2480	98.38	-	-	88.14	27.62	18.89	36.27	400	256	A	V
		2484.52	50.78	-23.22	74	40.51	27.64	18.9	36.27	400	256	P	V
		2484.92	41.94	-12.06	54	31.67	27.64	18.9	36.27	400	256	A	V
													V
													V
Remark	1. No other spurious found. 2. All results are PASS against Peak and Average limit line.												



2.4GHz 2400~2483.5MHz
BLE (Harmonic @ 3m)

BLE Ant 7	Note	Frequency (MHz)	Level (dBμV/m)	Margin (dB)	Limit Line (dBμV/m)	Read Level (dBμV)	Antenna Factor (dB/m)	Path Loss (dB)	Preamp Factor (dB)	Ant Pos (cm)	Table Pos (deg)	Peak Avg. (P/A)	Pol. (H/V)
BLE CH 00 2402MHz		4804	42.79	-31.21	74	34.97	32.4	12.92	37.5	-	-	P	H
													H
													H
													H
													H
													H
													H
													H
													H
													H
BLE CH 00 2402MHz		4804	42.63	-31.37	74	34.81	32.4	12.92	37.5	-	-	P	V
													V
													V
													V
													V
													V
													V
													V
													V
													V



BLE Ant 7	Note	Frequency (MHz)	Level (dBμV/m)	Margin (dB)	Limit Line (dBμV/m)	Read Level (dBμV)	Antenna Factor (dB/m)	Path Loss (dB)	Preamp Factor (dB)	Ant Pos (cm)	Table Pos (deg)	Peak Avg. (P/A)	Pol. (H/V)	
BLE CH 19 2440MHz		4880	43.51	-30.49	74	35.48	32.52	13.07	37.56	-	-	P	H	
		7320	47.63	-26.37	74	33.38	36.9	15.96	38.61	-	-	P	H	
													H	
													H	
													H	
													H	
													H	
													H	
													H	
													H	
													H	
			4880	42.88	-31.12	74	34.85	32.52	13.07	37.56	-	-	P	V
			7320	49.09	-24.91	74	34.84	36.9	15.96	38.61	400	47	P	V
			7320	39.75	-14.25	54	25.5	36.9	15.96	38.61	400	47	A	V
														V
														V
														V
														V
														V
														V
													V	



BLE Ant 7	Note	Frequency (MHz)	Level (dBμV/m)	Margin (dB)	Limit Line (dBμV/m)	Read Level (dBμV)	Antenna Factor (dB/m)	Path Loss (dB)	Preamp Factor (dB)	Ant Pos (cm)	Table Pos (deg)	Peak Avg. (P/A)	Pol. (H/V)
BLE CH 39 2480MHz		4960	44.12	-29.88	74	35.58	32.94	13.23	37.63	-	-	P	H
		7440	46.94	-27.06	74	33.01	36.52	16.12	38.71	-	-	P	H
													H
													H
													H
													H
													H
													H
													H
													H
													H
													H
													H
													H
													H
													H
													H
													H
													H
			4960	44.24	-29.76	74	35.7	32.94	13.23	37.63	-	-	P
		7440	47.34	-26.66	74	33.41	36.52	16.12	38.71	-	-	P	V
													V
													V
													V
													V
													V
													V
													V
													V
													V
													V
													V
													V
													V
													V
Remark	1. No other spurious found. 2. All results are PASS against Peak and Average limit line. 3. The emission position marked as "-" means no suspected emission found with sufficient margin against limit line or noise floor only.												



Note symbol

*	Fundamental Frequency which can be ignored. However, the level of any unwanted emissions shall not exceed the level of the fundamental frequency.
!	Test result is Margin line.
P/A	Peak or Average
H/V	Horizontal or Vertical



A calculation example for radiated spurious emission is shown as below:

BLE	Note	Frequency	Level	Margin	Limit	Read	Antenna	Path	Preamp	Ant	Table	Peak	Pol.
		(MHz)	(dBμV/m)	(dB)	(dBμV/m)	(dBμV)	(dB/m)	(dB)	(dB)	(cm)	(deg)	(P/A)	(H/V)
BLE CH 00 2402MHz		2390	55.45	-18.55	74	54.51	32.22	4.58	35.86	103	308	P	H
		2390	43.54	-10.46	54	42.6	32.22	4.58	35.86	103	308	A	H

1. Path Loss(dB) = Cable loss(dB) + Filter loss(dB) + Attenuator loss(dB)
2. Level(dBμV/m) =
Antenna Factor(dB/m) + Path Loss(dB) + Read Level(dBμV) - Preamp Factor(dB)
3. Margin (dB) = Level(dBμV/m) – Limit Line(dBμV/m)

For Peak Limit @ 2390MHz:

1. Level(dBμV/m)
= Antenna Factor(dB/m) + Path Loss(dB) + Read Level(dBμV) - Preamp Factor(dB)
= 32.22(dB/m) + 4.58(dB) + 54.51(dBμV) – 35.86 (dB)
= 55.45 (dBμV/m)
2. Margin (dB)
= Level(dBμV/m) – Limit Line(dBμV/m)
= 55.45(dBμV/m) – 74(dBμV/m)
= -18.55(dB)

For Average Limit @ 2390MHz:

1. Level(dBμV/m)
= Antenna Factor(dB/m) + Path Loss(dB) + Read Level(dBμV) - Preamp Factor(dB)
= 32.22(dB/m) + 4.58(dB) + 42.6(dBμV) – 35.86 (dB)
= 43.54 (dBμV/m)
2. Margin (dB)
= Level(dBμV/m) – Limit Line(dBμV/m)
= 43.54(dBμV/m) – 54(dBμV/m)
= -10.46(dB)

Both peak and average measured complies with the limit line, so test result is “PASS”.



Appendix D. Radiated Spurious Emission Plots

Test Engineer :	John Chuang, David Dai and Howard Huang	Temperature :	19.5~23.5°C
		Relative Humidity :	64.9~70.7%

Note symbol

-L	Low channel location
-R	High channel location



<1Mbps>

2.4GHz 2400~2483.5MHz

BLE (Band Edge @ 3m)

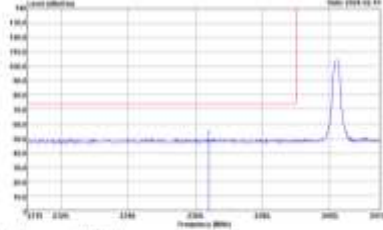
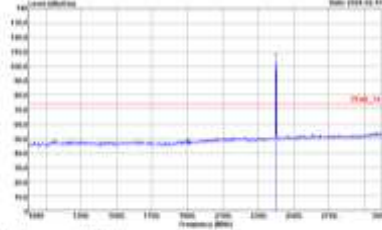
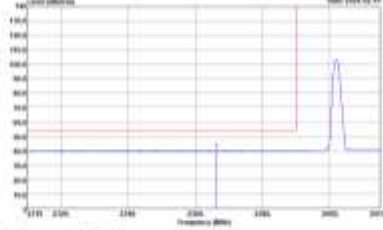
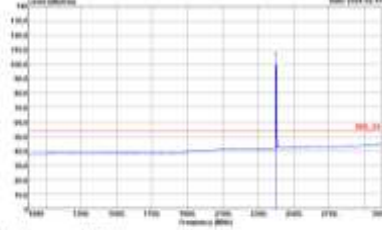
BLE	2.4GHz 2400~2483.5MHz Band Edge @ 3m	
ANT	BLE CH00 2402MHz	
6	Horizontal	Fundamental
Peak	 <p>Site: 05305149 Condition: 2402_M_24_000000_2402_248350 HORIZONTAL BW: 3000000 VFA: 3000000 DWT: 400</p>	 <p>Site: 05305149 Condition: 2402_M_24_000000_2402_248350 HORIZONTAL BW: 3000000 VFA: 3000000 DWT: 400</p>
Avg.	 <p>Site: 05305149 Condition: 2402_M_24_000000_2402_248350 HORIZONTAL BW: 3000000 VFA: 3000000 DWT: 400</p>	 <p>Site: 05305149 Condition: 2402_M_24_000000_2402_248350 HORIZONTAL BW: 3000000 VFA: 3000000 DWT: 400</p>

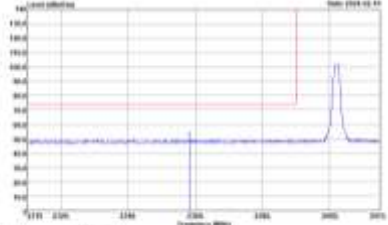
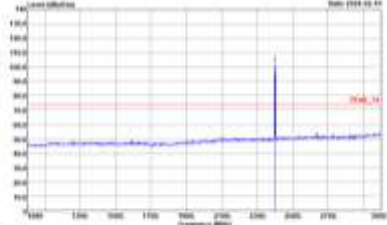
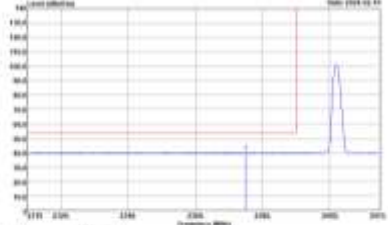
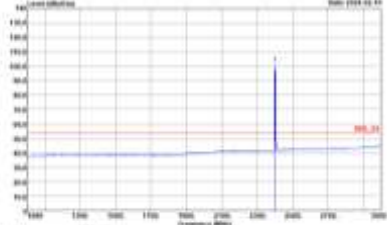

BLE	2.4GHz 2400~2483.5MHz Band Edge @ 3m	
ANT	BLE CH00 2402MHz	
6	Vertical	Fundamental
Peak	 <p>Site: 053024M Condition: 764L_78 8u 8100L_320M_23000 VERTICAL BW:3000000 VFA:3000000 U-DAT:Auto</p>	 <p>Site: 053024M Condition: 764L_78 8u 8100L_320M_23000 VERTICAL BW:3000000 VFA:3000000 U-DAT:Auto</p>
Avg	 <p>Site: 053024M Condition: 764L_78 8u 8100L_320M_23000 VERTICAL BW:3000000 VFA:3000000 U-DAT:Auto</p>	 <p>Site: 053024M Condition: 764L_78 8u 8100L_320M_23000 VERTICAL BW:3000000 VFA:3000000 U-DAT:Auto</p>

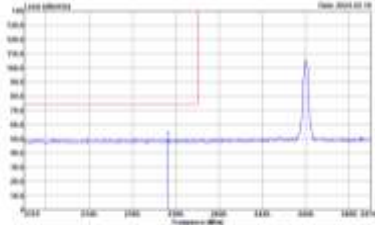
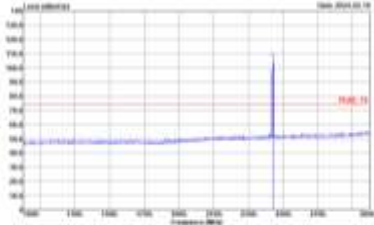
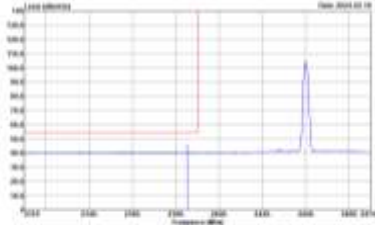
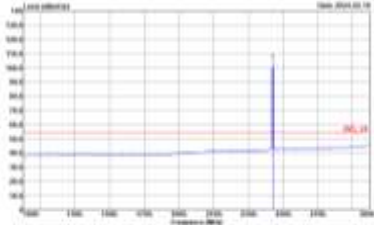

BLE	2.4GHz 2400~2483.5MHz Band Edge @ 3m	
ANT	BLE CH19 2440MHz - L	
6	Horizontal	Fundamental
Peak	 <p>Site: -031115-117 Coord: 34.34, 124.34 to 34.3500, 124.3400 (HORIZ/VERT) -MW-1200.000MHz to 1200.000000MHz to 1201.4000</p>	 <p>Site: -031115-117 Coord: 34.34, 124.34 to 34.3500, 124.3400 (HORIZ/VERT) -MW-1200.000MHz to 1200.000000MHz to 1201.4000</p>
Avg.	 <p>Site: -031115-117 Coord: 34.34, 124.34 to 34.3500, 124.3400 (HORIZ/VERT) -MW-1200.000MHz to 1200.000000MHz to 1201.4000</p>	 <p>Site: -031115-117 Coord: 34.34, 124.34 to 34.3500, 124.3400 (HORIZ/VERT) -MW-1200.000MHz to 1200.000000MHz to 1201.4000</p>

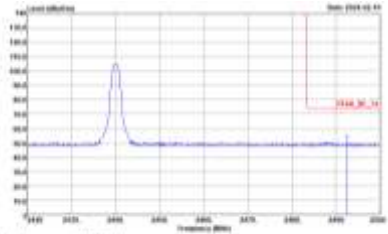
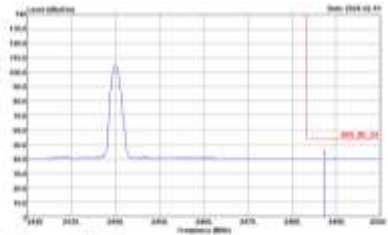

BLE	2.4GHz 2400~2483.5MHz Band Edge @ 3m	
ANT	BLE CH19 2440MHz - R	
6	Horizontal	Fundamental
Peak	 <p>File: 05102414M Condition: PEAK_36_34 In USE, CHAN_2440 HORIZONTAL BW: 3000000 VFA: 3000000 SMT:Auto</p>	Left blank
Avg.	 <p>File: 05102414M Condition: Avg_36_34 In USE, CHAN_2440 HORIZONTAL BW: 3000000 VFA: 3000000 SMT:Auto</p>	Left blank

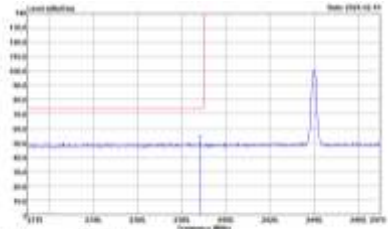
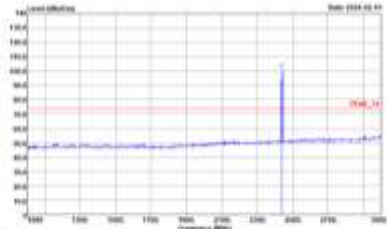
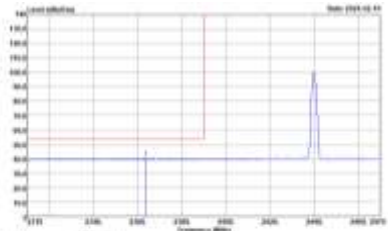
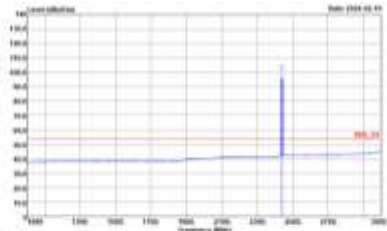

BLE	2.4GHz 2400~2483.5MHz Band Edge @ 3m	
ANT	BLE CH19 2440MHz - L	
6	Vertical	Fundamental
Peak	 <p>Site: 053024M Condition: ANT_06_04_0a_0100_0100_0100 VERTICAL BW: 3000000 Hz VFA: 3000000 Hz DWT: 400</p>	 <p>Site: 053024M Condition: ANT_06_04_0a_0100_0100_0100 VERTICAL BW: 3000000 Hz VFA: 3000000 Hz DWT: 400</p>
Avg.	 <p>Site: 053024M Condition: ANT_06_04_0a_0100_0100_0100 VERTICAL BW: 3000000 Hz VFA: 3000000 Hz DWT: 400</p>	 <p>Site: 053024M Condition: ANT_06_04_0a_0100_0100_0100 VERTICAL BW: 3000000 Hz VFA: 3000000 Hz DWT: 400</p>



BLE	2.4GHz 2400~2483.5MHz Band Edge @ 3m	
ANT	BLE CH19 2440MHz - R	
6	Vertical	Fundamental
Peak		Left blank
Avg.		Left blank



BLE	2.4GHz 2400~2483.5MHz Band Edge @ 3m	
ANT	BLE CH39 2480MHz	
6	Horizontal	Fundamental
Peak	<p>Site: 053024M Condition: 2480_39_74 80 2480_39 2480_39 HORIZONTAL BW: 3000000 VFA: 3000000 DUT: Auto</p>	<p>Site: 053024M Condition: 2480_39 80 2480_39 2480_39 HORIZONTAL BW: 3000000 VFA: 3000000 DUT: Auto</p>
Avg.	<p>Site: 053024M Condition: Avg_39_74 80 2480_39 2480_39 HORIZONTAL BW: 3000000 VFA: 3000000 DUT: Auto</p>	<p>Site: 053024M Condition: Avg_39 80 2480_39 2480_39 HORIZONTAL BW: 3000000 VFA: 3000000 DUT: Auto</p>

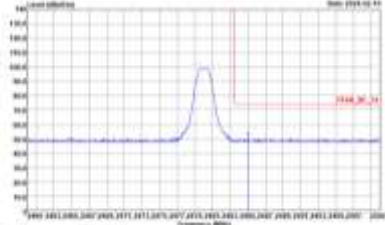
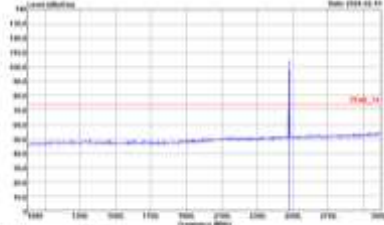
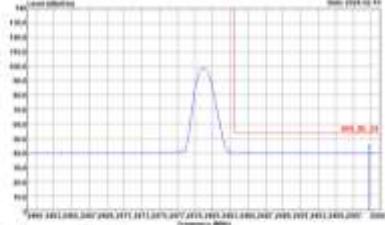
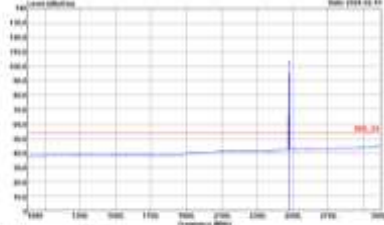

BLE	2.4GHz 2400~2483.5MHz Band Edge @ 3m	
ANT	BLE CH39 2480MHz	
6	Vertical	Fundamental
Peak	 <p>Site: 05302414M Condition: PEAK_39_74 80 0.000 0.0000 0.0000 VERTICAL BW: 30000000 VFA: 30000000.0 DAT:Auto</p>	 <p>Site: 05302414M Condition: PEAK_74 80 0.000 0.0000 0.0000 VERTICAL BW: 30000000 VFA: 30000000.0 DAT:Auto</p>
Avg.	 <p>Site: 05302414M Condition: Avg_39_74 80 0.000 0.0000 0.0000 VERTICAL BW: 30000000 VFA: 30000000.0 DAT:Auto</p>	 <p>Site: 05302414M Condition: Avg_74 80 0.000 0.0000 0.0000 VERTICAL BW: 30000000 VFA: 30000000.0 DAT:Auto</p>



2.4GHz 2400~2483.5MHz

BLE (Harmonic @ 3m)

BLE	2.4GHz 2400~2483.5MHz Harmonic @ 3m	
ANT	BLE CH00 2402MHz	
6	Horizontal	Vertical
Peak Avg.	<p>Site: 053004M Condition: PEAK_74 No PEAK_100M_2402 HORIZONTAL</p>	<p>Site: 053004M Condition: PEAK_74 No PEAK_100M_2402 VERTICAL</p>

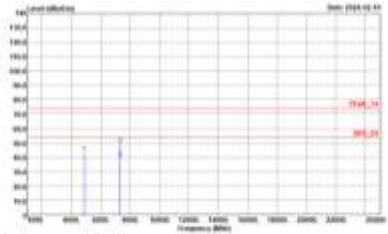
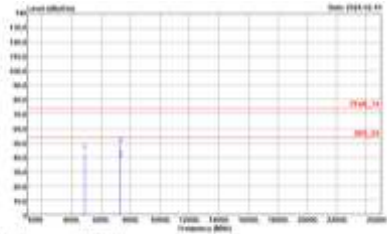

BLE	2.4GHz 2400~2483.5MHz Harmonic @ 3m	
ANT	BLE CH19 2440MHz	
6	Horizontal	Vertical
Peak Avg.	 <p>Site: 053103414 Condition: PEAK_74 No. 16400_16784_16820 HORIZONTAL</p>	 <p>Site: 053103414 Condition: PEAK_74 No. 16400_16784_16820 VERTICAL</p>

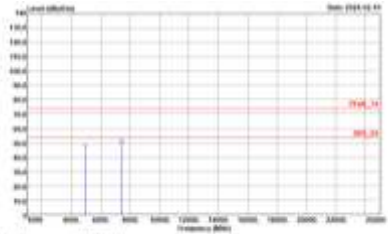
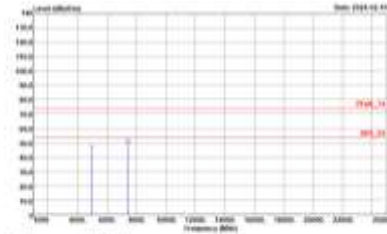

BLE	2.4GHz 2400~2483.5MHz Harmonic @ 3m	
ANT	BLE CH39 2480MHz	
6	Horizontal	Vertical
Peak	 <p>File: 0521024147 Condition: PEAK_74 No. 16400_167841_24800 HORIZONTAL</p>	 <p>File: 0521024147 Condition: PEAK_74 No. 16400_167841_24800 VERTICAL</p>



2.4GHz 2400~2483.5MHz

BLE (Band Edge @ 3m)

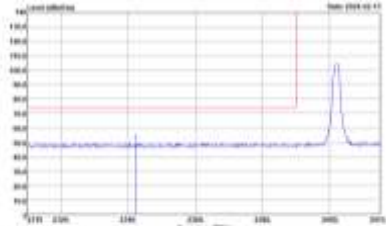
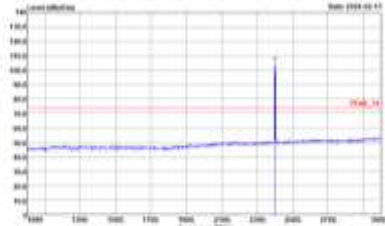
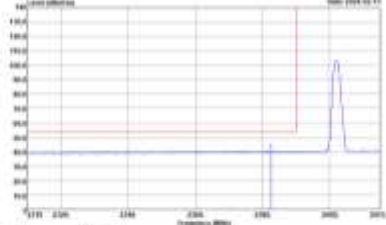
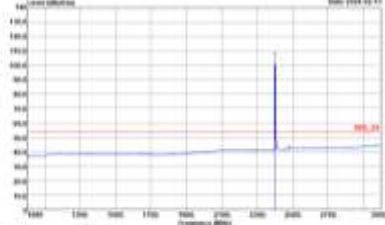
BLE	2.4GHz 2400~2483.5MHz Band Edge @ 3m	
ANT	BLE CH00 2402MHz	
7	Horizontal	Fundamental
Peak	 <p>Site: 05302419 Coord: PEAK_36_74 Hz FREQ_3200_2402 HORIZONTAL BW: 300000 Hz VFA: 3000000 Hz SWT: 40</p>	 <p>Site: 05302419 Coord: PEAK_74 Hz FREQ_3200_2402 HORIZONTAL BW: 300000 Hz VFA: 3000000 Hz SWT: 40</p>
Avg.	 <p>Site: 05302419 Coord: AVG_36_74 Hz FREQ_3200_2402 HORIZONTAL BW: 300000 Hz VFA: 3000000 Hz SWT: 40</p>	 <p>Site: 05302419 Coord: AVG_74 Hz FREQ_3200_2402 HORIZONTAL BW: 300000 Hz VFA: 3000000 Hz SWT: 40</p>

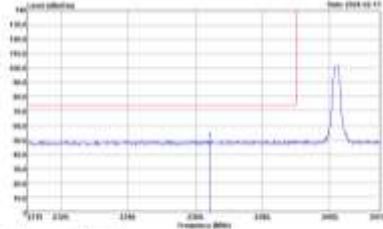
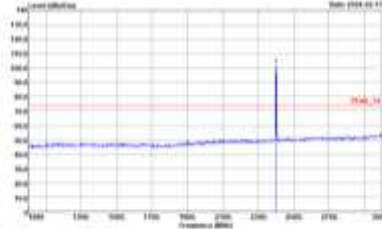
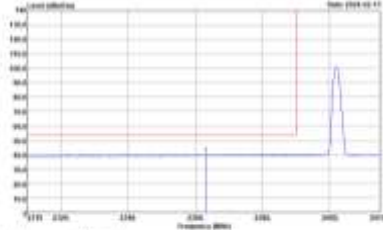
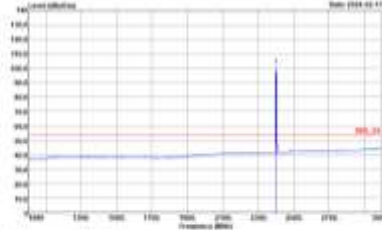

BLE	2.4GHz 2400~2483.5MHz Band Edge @ 3m	
ANT	BLE CH00 2402MHz	
7	Vertical	Fundamental
Peak	 <p>Site: 053024M Condition: 70dB, 70 dB BW, 2000, 2000 VERTICAL, BW: 3000000 VFA: 3000000 U: 0MT:Auto</p>	 <p>Site: 053024M Condition: 70dB, 70 dB BW, 2000, 2000 VERTICAL, BW: 3000000 VFA: 3000000 U: 0MT:Auto</p>
Avg	 <p>Site: 053024M Condition: 70dB, 70 dB BW, 2000, 2000 VERTICAL, BW: 3000000 VFA: 3000000 U: 0MT:Auto</p>	 <p>Site: 053024M Condition: 70dB, 70 dB BW, 2000, 2000 VERTICAL, BW: 3000000 VFA: 3000000 U: 0MT:Auto</p>

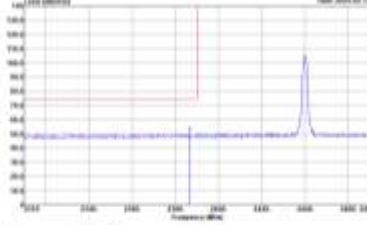
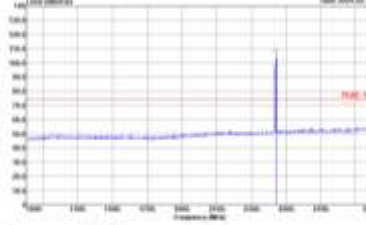
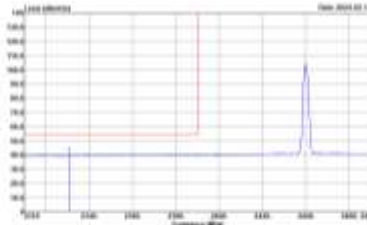
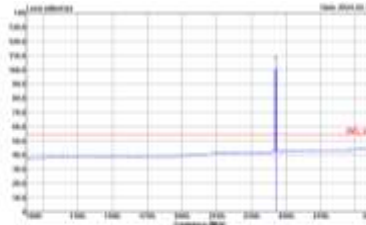

BLE	2.4GHz 2400~2483.5MHz Band Edge @ 3m	
ANT	BLE CH19 2440MHz - L	
7	Horizontal	Fundamental
Peak	 <p>Site: -031111-111 Coord Name: -1E, 41, 74 to 1E, 41, 74 (2440.000000) (2440.000000) (HORIZONTAL) -MAX (2440.000000) to VIEW (2440.000000) to SWT 4.000</p>	 <p>Site: -031111-111 Coord Name: -1E, 41, 74 to 1E, 41, 74 (2440.000000) (2440.000000) (FUNDAMENTAL) -MAX (2440.000000) to VIEW (2440.000000) to SWT 4.000</p>
Avg.	 <p>Site: -031111-111 Coord Name: -1E, 41, 74 to 1E, 41, 74 (2440.000000) (2440.000000) (HORIZONTAL) -MAX (2440.000000) to VIEW (2440.000000) to SWT 4.000</p>	 <p>Site: -031111-111 Coord Name: -1E, 41, 74 to 1E, 41, 74 (2440.000000) (2440.000000) (FUNDAMENTAL) -MAX (2440.000000) to VIEW (2440.000000) to SWT 4.000</p>

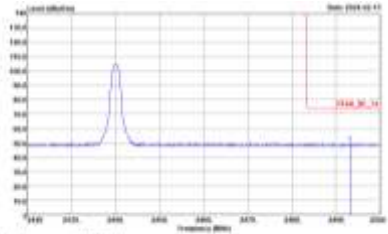
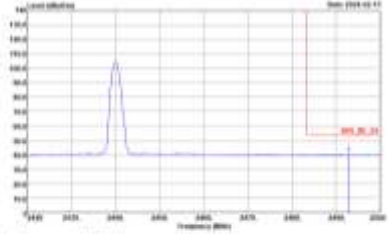

BLE	2.4GHz 2400~2483.5MHz Band Edge @ 3m	
ANT	BLE CH19 2440MHz - R	
7	Horizontal	Fundamental
Peak	 <p>Spectrum Analyzer Date: 2018-03-14 Peak: 2440 MHz Power: 100 dBm</p>	Left blank
Avg.	 <p>Spectrum Analyzer Date: 2018-03-14 Peak: 2440 MHz Power: 100 dBm</p>	Left blank

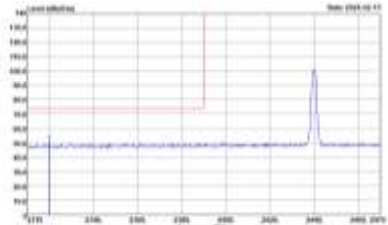
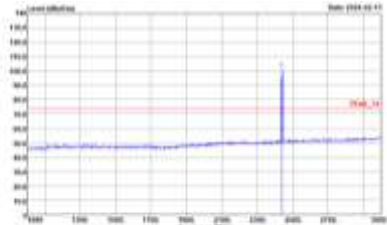
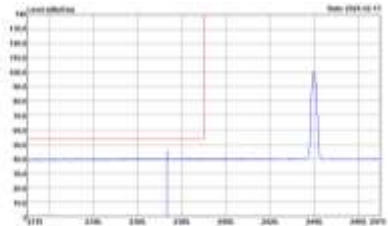
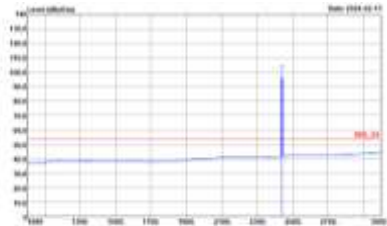

BLE	2.4GHz 2400~2483.5MHz Band Edge @ 3m	
ANT	BLE CH19 2440MHz - L	
7	Vertical	Fundamental
Peak	 <p>Site: 053024M Condition: 70dB, 70 dB FURT, 3200, 20000 VERTICAL, 800000000 VFA, 300000000 DWT, 400</p>	 <p>Site: 053024M Condition: 70dB, 70 dB FURT, 3200, 20000 VERTICAL, 800000000 VFA, 300000000 DWT, 400</p>
Avg.	 <p>Site: 053024M Condition: 70dB, 70 dB FURT, 3200, 20000 VERTICAL, 800000000 VFA, 300000000 DWT, 400</p>	 <p>Site: 053024M Condition: 70dB, 70 dB FURT, 3200, 20000 VERTICAL, 800000000 VFA, 300000000 DWT, 400</p>

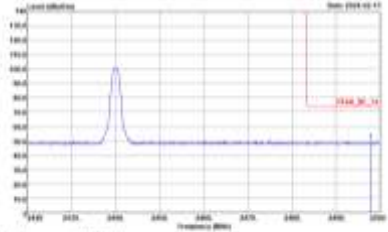
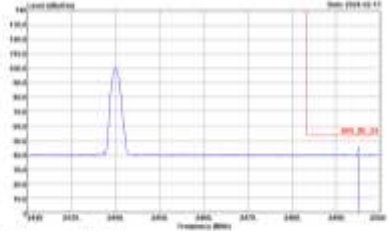

BLE	2.4GHz 2400~2483.5MHz Band Edge @ 3m	
ANT	BLE CH19 2440MHz - R	
7	Vertical	Fundamental
Peak	 <p>File: 05102419 Condition: PWR_36_74 90.0000, 0.0000, 0.0000 VERTICAL BW: 0.000000 to 0.000000 (MHz)</p>	Left blank
Avg.	 <p>File: 05102419 Condition: PWR_36_74 90.0000, 0.0000, 0.0000 VERTICAL BW: 0.000000 to 0.000000 (MHz)</p>	Left blank

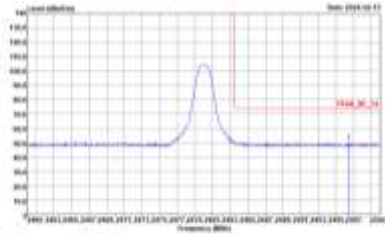
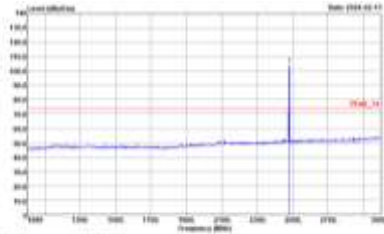
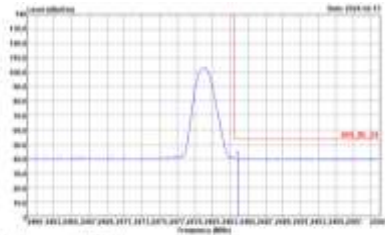
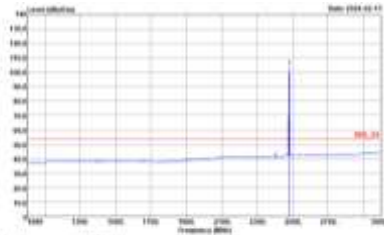

BLE	2.4GHz 2400~2483.5MHz Band Edge @ 3m	
ANT	BLE CH39 2480MHz	
7	Horizontal	Fundamental
Peak	 <p>Site: 053024M Condition: 704E_78 50 0000_0000_0000 HORIZONTAL BW: 3000000 VFA: 3000000 I: 0MT:Auto</p>	 <p>Site: 053024M Condition: 704E_78 50 0000_0000_0000 HORIZONTAL BW: 3000000 VFA: 3000000 I: 0MT:Auto</p>
Avg.	 <p>Site: 053024M Condition: 704E_78 50 0000_0000_0000 HORIZONTAL BW: 3000000 VFA: 3000000 I: 0MT:Auto</p>	 <p>Site: 053024M Condition: 704E_78 50 0000_0000_0000 HORIZONTAL BW: 3000000 VFA: 3000000 I: 0MT:Auto</p>

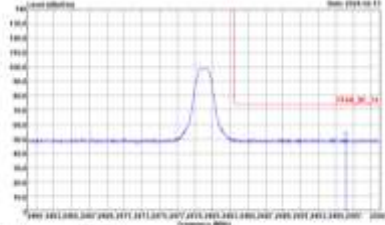
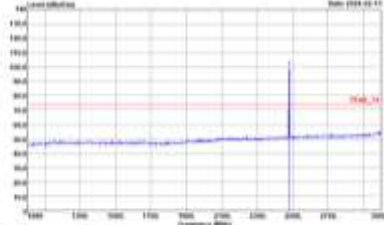
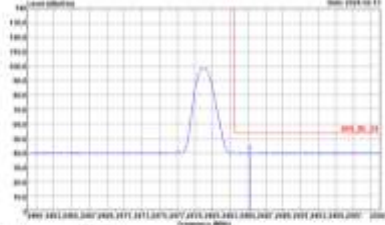
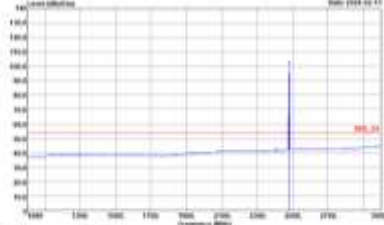

BLE	2.4GHz 2400~2483.5MHz Band Edge @ 3m	
ANT	BLE CH39 2480MHz	
7	Vertical	Fundamental
Peak	 <p>Site: 053024M Condition: PEAK_39_74 80 2480_320M_23000 VERTICAL BW: 3000000 VFA: 3000000 U: 0MT:Auto</p>	 <p>Site: 053024M Condition: PEAK_74 80 2480_320M_23000 VERTICAL BW: 3000000 VFA: 3000000 U: 0MT:Auto</p>
Avg.	 <p>Site: 053024M Condition: Avg_39_74 80 2480_320M_23000 VERTICAL BW: 3000000 VFA: 3000000 U: 0MT:Auto</p>	 <p>Site: 053024M Condition: Avg_74 80 2480_320M_23000 VERTICAL BW: 3000000 VFA: 3000000 U: 0MT:Auto</p>



2.4GHz 2400~2483.5MHz

BLE (Harmonic @ 3m)

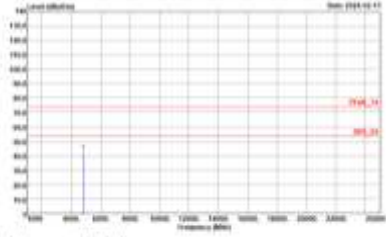
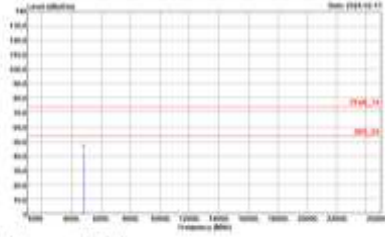
BLE	2.4GHz 2400~2483.5MHz Harmonic @ 3m	
ANT	BLE CH00 2402MHz	
7	Horizontal	Vertical
Peak Avg.	 <p>Site: BLE CH00 2402MHz Condition: PEAK_74 No PEAK_10/001_2402 HORIZONTAL</p>	 <p>Site: BLE CH00 2402MHz Condition: PEAK_74 No PEAK_10/001_2402 VERTICAL</p>



BLE	2.4GHz 2400~2483.5MHz Harmonic @ 3m	
ANT	BLE CH19 2440MHz	
7	Horizontal	Vertical
Peak Avg.		



BLE	2.4GHz 2400~2483.5MHz Harmonic @ 3m	
ANT	BLE CH39 2480MHz	
7	Horizontal	Vertical
Peak		



<2Mbps>

2.4GHz 2400~2483.5MHz

BLE (Band Edge @ 3m)

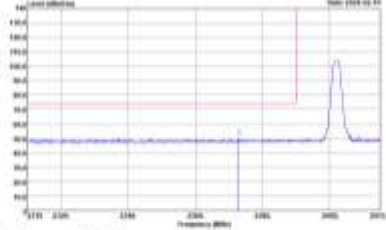
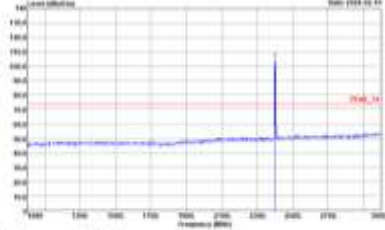
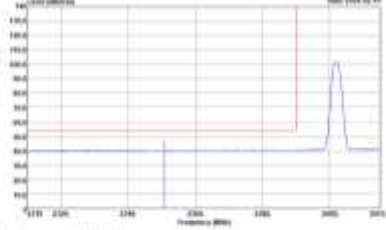
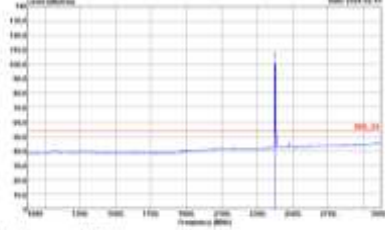
BLE	2.4GHz 2400~2483.5MHz Band Edge @ 3m	
ANT	BLE CH00 2402MHz	
6	Horizontal	Fundamental
Peak	 <p>Site: 05303149 Condition: 2402.36_24_8u_PWRD_2400_2483.5 HORIZONTAL BW:3000000 VFA:3000000 DNT:Auto</p>	 <p>Site: 05303149 Condition: 2402.36_24_8u_PWRD_2400_2483.5 HORIZONTAL BW:3000000 VFA:3000000 DNT:Auto</p>
Avg.	 <p>Site: 05303149 Condition: 2402.36_24_8u_PWRD_2400_2483.5 HORIZONTAL BW:3000000 VFA:3000000 DNT:Auto</p>	 <p>Site: 05303149 Condition: 2402.36_24_8u_PWRD_2400_2483.5 HORIZONTAL BW:3000000 VFA:3000000 DNT:Auto</p>

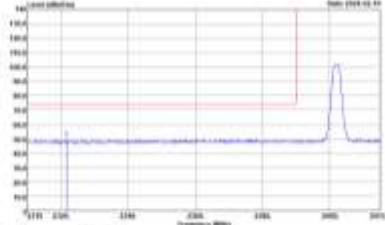
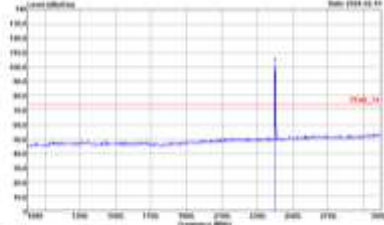
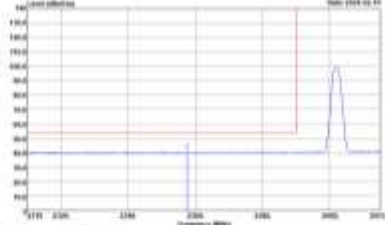
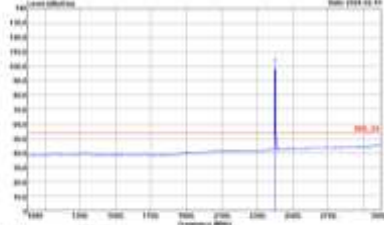

BLE	2.4GHz 2400~2483.5MHz Band Edge @ 3m	
ANT	BLE CH00 2402MHz	
6	Vertical	Fundamental
Peak	 <p>Site: 050004M Condition: 76dB, 78 dB EIRP, 32dB, 2300 VERTICAL, BW:3000000 VFA:3000000 U: DNT-Arc</p>	 <p>Site: 050004M Condition: 76dB, 78 dB EIRP, 32dB, 2300 VERTICAL, BW:3000000 VFA:3000000 U: DNT-Arc</p>
Avg	 <p>Site: 050004M Condition: 76dB, 78 dB EIRP, 32dB, 2300 VERTICAL, BW:3000000 VFA:3000000 U: DNT-Arc</p>	 <p>Site: 050004M Condition: 76dB, 78 dB EIRP, 32dB, 2300 VERTICAL, BW:3000000 VFA:3000000 U: DNT-Arc</p>

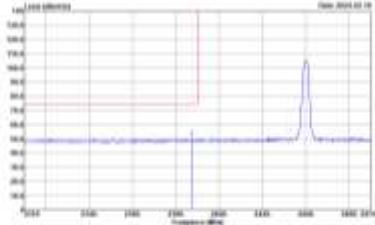
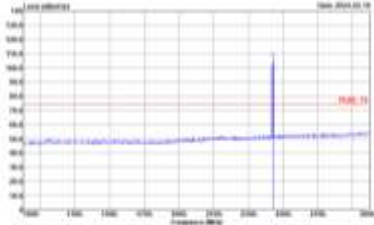
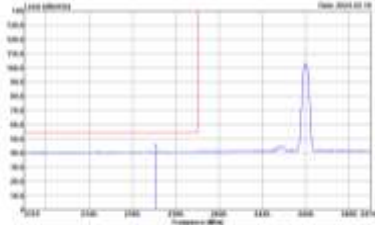
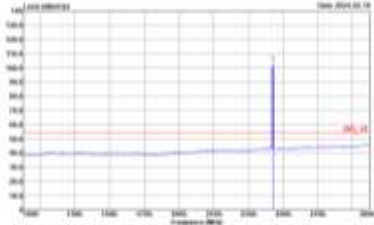

BLE	2.4GHz 2400~2483.5MHz Band Edge @ 3m	
ANT	BLE CH19 2440MHz - L	
6	Horizontal	Fundamental
Peak	 <p>Site: -031111-111 Coord Name: -1E, 41, 74 to 1E, 41, 74 (2440.000000) (2440.000000) (HORIZONTAL) -MAX (2440.000000) to 2440.000000 (MHz) to 2440.000000 (MHz)</p>	 <p>Site: -031111-111 Coord Name: -1E, 41, 74 to 1E, 41, 74 (2440.000000) (2440.000000) (HORIZONTAL) -MAX (2440.000000) to 2440.000000 (MHz) to 2440.000000 (MHz)</p>
Avg.	 <p>Site: -031111-111 Coord Name: -1E, 41, 74 to 1E, 41, 74 (2440.000000) (2440.000000) (HORIZONTAL) -MAX (2440.000000) to 2440.000000 (MHz) to 2440.000000 (MHz)</p>	 <p>Site: -031111-111 Coord Name: -1E, 41, 74 to 1E, 41, 74 (2440.000000) (2440.000000) (HORIZONTAL) -MAX (2440.000000) to 2440.000000 (MHz) to 2440.000000 (MHz)</p>

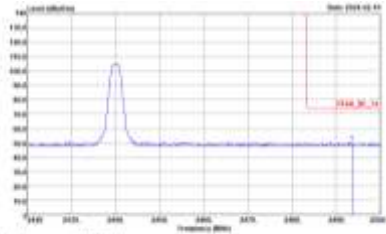
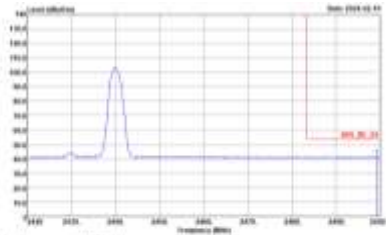

BLE	2.4GHz 2400~2483.5MHz Band Edge @ 3m	
ANT	BLE CH19 2440MHz - R	
6	Horizontal	Fundamental
Peak	 <p>File: 05102414M Condition: FREQ_06_24 In USE, CHAN_2400 HORIZONTAL REF:XXXXXXXXXX VFA:XXXXXXXXXX INT:Auto</p>	Left blank
Avg.	 <p>File: 05102414M Condition: FREQ_06_24 In USE, CHAN_2400 HORIZONTAL REF:XXXXXXXXXX VFA:XXXXXXXXXX INT:Auto</p>	Left blank

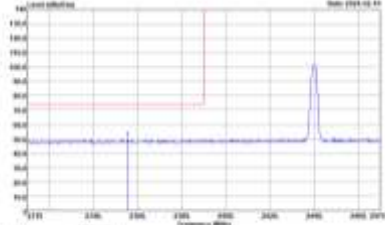
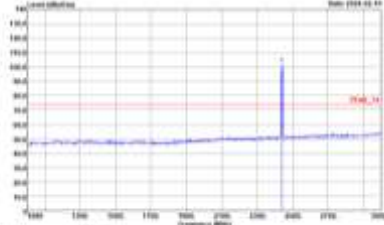
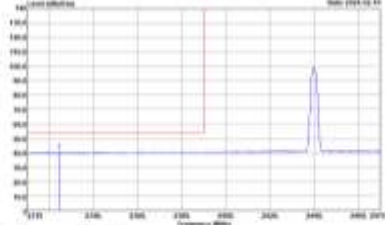
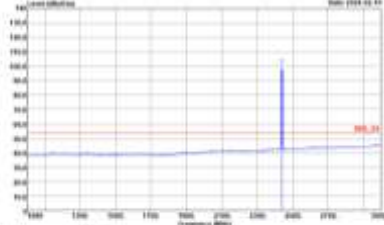

BLE	2.4GHz 2400~2483.5MHz Band Edge @ 3m	
ANT	BLE CH19 2440MHz - L	
6	Vertical	Fundamental
Peak	 <p>Site: 053024M Condition: 2440_36_74 80 2400_2483.5 2440 VERTICAL BW: 3000000 VFA: 3000000 U: 0MT:Auto</p>	 <p>Site: 053024M Condition: 2440_36_74 80 2400_2483.5 2440 VERTICAL BW: 3000000 VFA: 3000000 U: 0MT:Auto</p>
Avg.	 <p>Site: 053024M Condition: Avg_36_74 80 2400_2483.5 2440 VERTICAL BW: 3000000 VFA: 3000000 U: 0MT:Auto</p>	 <p>Site: 053024M Condition: Avg_36_74 80 2400_2483.5 2440 VERTICAL BW: 3000000 VFA: 3000000 U: 0MT:Auto</p>

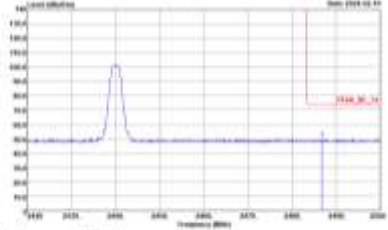
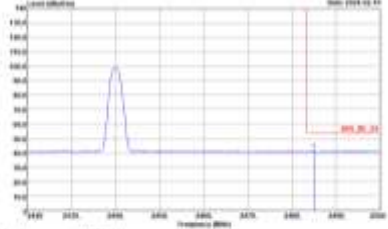

BLE	2.4GHz 2400~2483.5MHz Band Edge @ 3m	
ANT	BLE CH19 2440MHz - R	
6	Vertical	Fundamental
Peak	 <p>File: 05102419 Condition: PEAK_06_19 2440.000000 2440.000000 VERTICAL REF:XXXXXXXXXX VFA:XXXXXXXXXX DWT:Auto</p>	Left blank
Avg.	 <p>File: 05102419 Condition: Avg_06_19 2440.000000 2440.000000 VERTICAL REF:XXXXXXXXXX VFA:XXXXXXXXXX DWT:Auto</p>	Left blank

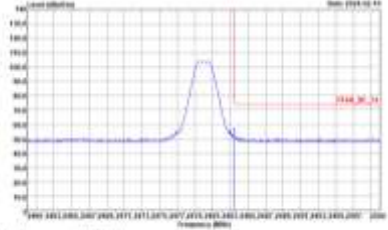
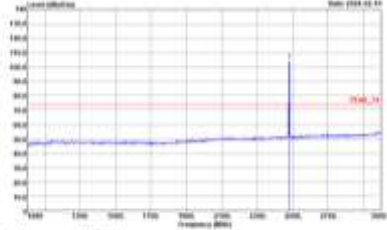
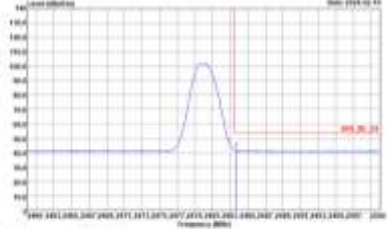
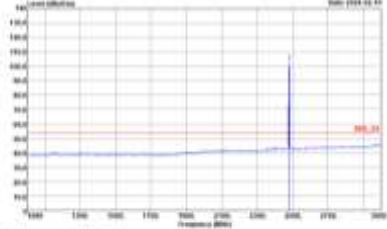

BLE	2.4GHz 2400~2483.5MHz Band Edge @ 3m	
ANT	BLE CH39 2480MHz	
6	Horizontal	Fundamental
Peak	 <p>Site: 0530241M Condition: PEAK_39_74 8u 8U30_323M_23230 HORIZONTAL BW:3000000 VFA:3000000 IWT:Auto</p>	 <p>Site: 0530241M Condition: PEAK_74 8u 8U30_323M_23230 HORIZONTAL BW:3000000 VFA:3000000 IWT:Auto</p>
Avg.	 <p>Site: 0530241M Condition: Avg_39_74 8u 8U30_323M_23230 HORIZONTAL BW:3000000 VFA:3000000 IWT:Auto</p>	 <p>Site: 0530241M Condition: Avg_74 8u 8U30_323M_23230 HORIZONTAL BW:3000000 VFA:3000000 IWT:Auto</p>

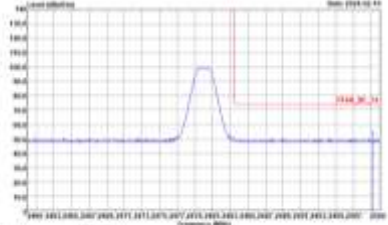
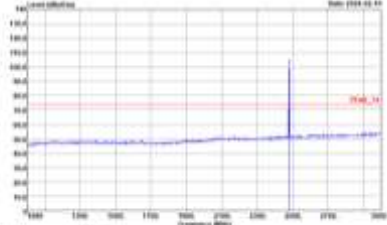
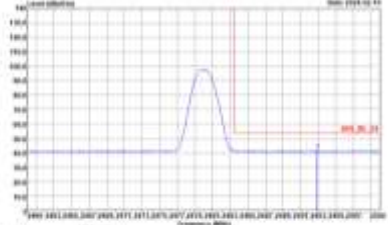
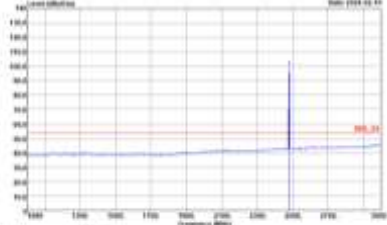

BLE	2.4GHz 2400~2483.5MHz Band Edge @ 3m	
ANT	BLE CH39 2480MHz	
6	Vertical	Fundamental
Peak	 <p>Site: 053024M Condition: PEAK_39_74 80 0.000_0.0000_0.0000 VERTICAL BW: 300.000000 VFA: 300.000000 U: 0MT-Auto</p>	 <p>Site: 053024M Condition: PEAK_74 80 0.000_0.0000_0.0000 VERTICAL BW: 300.000000 VFA: 300.000000 U: 0MT-Auto</p>
Avg.	 <p>Site: 053024M Condition: Avg_39_74 80 0.000_0.0000_0.0000 VERTICAL BW: 300.000000 VFA: 300.000000 U: 0MT-Auto</p>	 <p>Site: 053024M Condition: Avg_74 80 0.000_0.0000_0.0000 VERTICAL BW: 300.000000 VFA: 300.000000 U: 0MT-Auto</p>



2.4GHz 2400~2483.5MHz

BLE (Harmonic @ 3m)

BLE	2.4GHz 2400~2483.5MHz Harmonic @ 3m	
ANT	BLE CH00 2402MHz	
6	Horizontal	Vertical
Peak Avg.	<p>Site: 053004M Condition: PEAK_74 No PEAK_100M_100M_100M HORIZONTAL</p>	<p>Site: 053004M Condition: PEAK_74 No PEAK_100M_100M_100M VERTICAL</p>

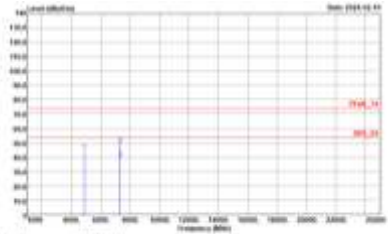
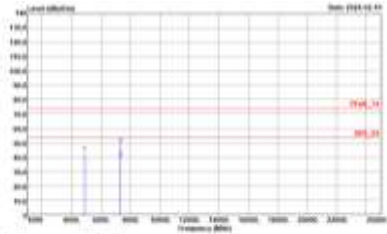

BLE	2.4GHz 2400~2483.5MHz Harmonic @ 3m	
ANT	BLE CH19 2440MHz	
6	Horizontal	Vertical
Peak Avg.	 <p>Site: 053103414 Condition: PEAK_74 No. 16400_16784_16830 HORIZONTAL</p>	 <p>Site: 053103414 Condition: PEAK_74 No. 16400_16784_16830 VERTICAL</p>



BLE	2.4GHz 2400~2483.5MHz Harmonic @ 3m	
ANT	BLE CH39 2480MHz	
6	Horizontal	Vertical
Peak	<p>File: 05210244.M Condition: PEAK_74 No. 0000_0000_0000 HORIZONTAL</p>	<p>File: 05210244.M Condition: PEAK_74 No. 0000_0000_0000 VERTICAL</p>



Emission above 18GHz

2.4GHz BLE (SHF @ 1m)

BLE	2.4GHz 2400~2483.5MHz	
ANT	BLE SHF	
6	Horizontal	Vertical
Peak Avg.	<p>Site: 050300419 Condition: PEAK_74 to 100F_2400_2483.5MHz HORIZONTAL</p>	<p>Site: 050300419 Condition: PEAK_74 to 100F_2400_2483.5MHz VERTICAL</p>



Emission below 1GHz

2.4GHz BLE (LF)

BLE	2.4GHz 2400~2483.5MHz	
ANT	BLE LF	
6	Horizontal	Vertical
QP / Peak	<p>Site: 010300419 Condition: QP 24 LF_Stack_#11001_0010002100101</p>	<p>Site: 010300419 Condition: QP 24 LF_Stack_#11001_0010002100101</p>



2.4GHz 2400~2483.5MHz

BLE (Band Edge @ 3m)

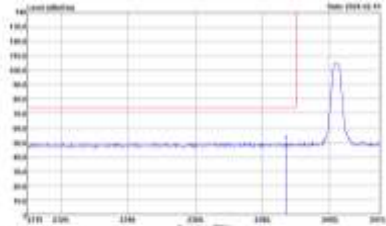
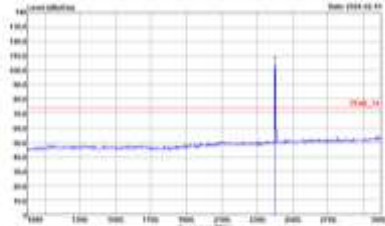
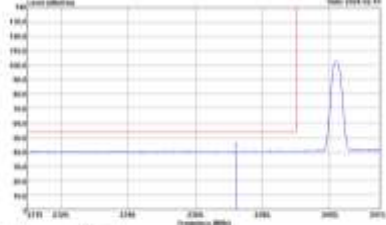
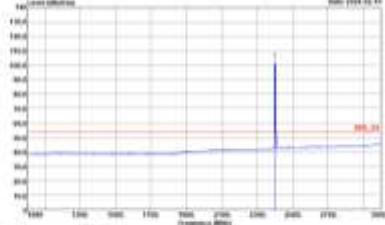
BLE	2.4GHz 2400~2483.5MHz Band Edge @ 3m	
ANT	BLE CH00 2402MHz	
7	Horizontal	Fundamental
Peak	 <p>Site: 05302419 Coord: 36.34 146.8100, 33.01, 33.00 HORIZONTAL BW: 3000000 VFA: 3000000 U: DNT-Arch</p>	 <p>Site: 05302419 Coord: 36.34 146.8100, 33.01, 33.00 HORIZONTAL BW: 3000000 VFA: 3000000 U: DNT-Arch</p>
Avg.	 <p>Site: 05302419 Coord: 36.34 146.8100, 33.01, 33.00 HORIZONTAL BW: 3000000 VFA: 3000000 U: DNT-Arch</p>	 <p>Site: 05302419 Coord: 36.34 146.8100, 33.01, 33.00 HORIZONTAL BW: 3000000 VFA: 3000000 U: DNT-Arch</p>

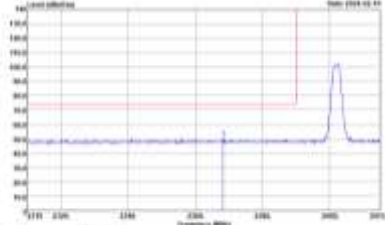
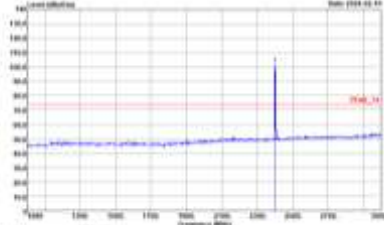
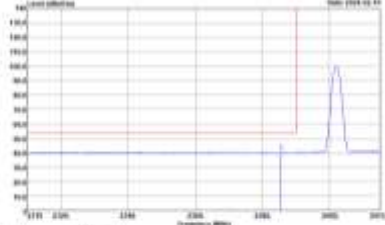
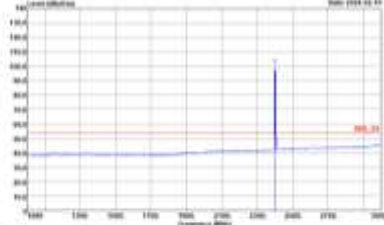

BLE	2.4GHz 2400~2483.5MHz Band Edge @ 3m	
ANT	BLE CH00 2402MHz	
7	Vertical	Fundamental
Peak	 <p>Site: 050004M Condition: 704L_70_70_0000_0000_0000 VERTICAL BW: 3000000 Hz VFA: 3000000 Hz DUT: Ant</p>	 <p>Site: 050004M Condition: 704L_70_70_0000_0000_0000 VERTICAL BW: 3000000 Hz VFA: 3000000 Hz DUT: Ant</p>
Avg	 <p>Site: 050004M Condition: 704L_70_70_0000_0000_0000 VERTICAL BW: 3000000 Hz VFA: 3000000 Hz DUT: Ant</p>	 <p>Site: 050004M Condition: 704L_70_70_0000_0000_0000 VERTICAL BW: 3000000 Hz VFA: 3000000 Hz DUT: Ant</p>

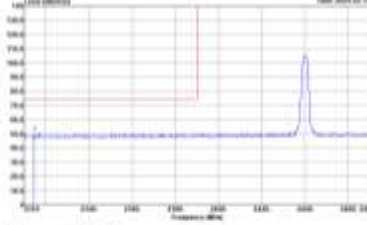
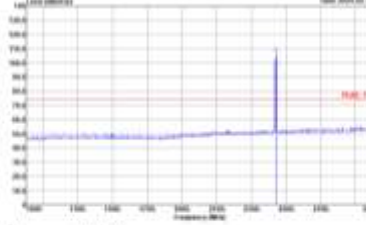
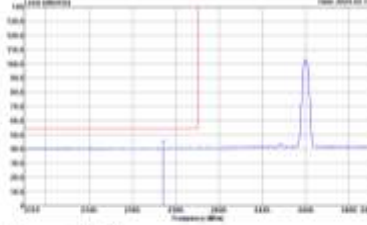
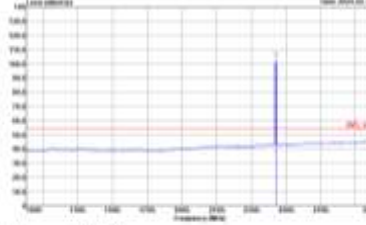

BLE	2.4GHz 2400~2483.5MHz Band Edge @ 3m	
ANT	BLE CH19 2440MHz - L	
7	Horizontal	Fundamental
Peak	 <p>Site: -031111-111 Coord Name: -18.41, 101.74 to 18.41000, 101.74000 (HORIZONTAL) -MMW-1000.000MHz to 1000.000000MHz to 1001.400000MHz</p>	 <p>Site: -031111-111 Coord Name: -18.41, 101.74 to 18.41000, 101.74000 (FUNDAMENTAL) -MMW-1000.000MHz to 1000.000000MHz to 1001.400000MHz</p>
Avg.	 <p>Site: -031111-111 Coord Name: -18.41, 101.74 to 18.41000, 101.74000 (HORIZONTAL) -MMW-1000.000MHz to 1000.000000MHz to 1001.400000MHz</p>	 <p>Site: -031111-111 Coord Name: -18.41, 101.74 to 18.41000, 101.74000 (FUNDAMENTAL) -MMW-1000.000MHz to 1000.000000MHz to 1001.400000MHz</p>



BLE	2.4GHz 2400~2483.5MHz Band Edge @ 3m	
ANT	BLE CH19 2440MHz - R	
7	Horizontal	Fundamental
Peak	<p>File: 05102419 Condition: PEAK_04_19_0400_0200_0200_HORIZONTAL BIN:XXXXXXXXXX VFA:XXXXXXXXXX INT:Auto</p>	Left blank
Avg.	<p>File: 05102419 Condition: Avg_04_19_0400_0200_0200_HORIZONTAL BIN:XXXXXXXXXX VFA:XXXXXXXXXX INT:Auto</p>	Left blank

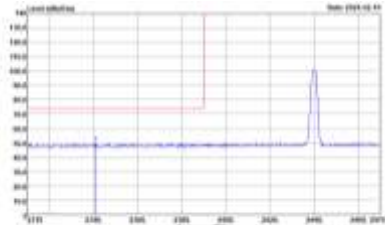
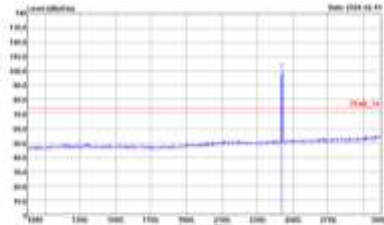
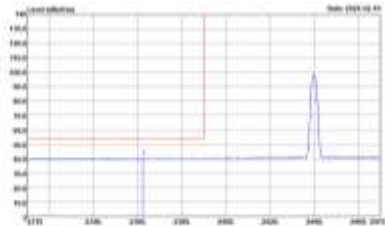
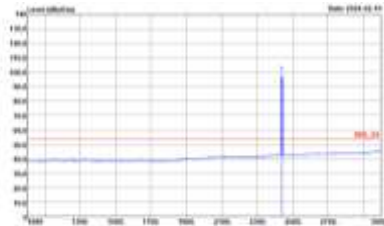

BLE	2.4GHz 2400~2483.5MHz Band Edge @ 3m	
ANT	BLE CH19 2440MHz - L	
7	Vertical	Fundamental
Peak	 <p>Site: 050004M Condition: 70dB, 70 dB BW, 3000, 3000 VERTICAL, BW:3000000 VFA:3000000 U: DNT:Auto</p>	 <p>Site: 050004M Condition: 70dB, 70 dB BW, 3000, 3000 VERTICAL, BW:3000000 VFA:3000000 U: DNT:Auto</p>
Avg.	 <p>Site: 050004M Condition: 70dB, 70 dB BW, 3000, 3000 VERTICAL, BW:3000000 VFA:3000000 U: DNT:Auto</p>	 <p>Site: 050004M Condition: 70dB, 70 dB BW, 3000, 3000 VERTICAL, BW:3000000 VFA:3000000 U: DNT:Auto</p>



BLE	2.4GHz 2400~2483.5MHz Band Edge @ 3m	
ANT	BLE CH19 2440MHz - R	
7	Vertical	Fundamental
Peak	<p>File: 05102414M Condition: 114.36 dBm @ 2440.000000 MHz, 2.4GHz VERTICAL BW: 3000000 Hz VFA: 3000000 Hz SMT: Auto</p>	Left blank
Avg.	<p>File: 05102414M Condition: 105.26 dBm @ 2440.000000 MHz, 2.4GHz VERTICAL BW: 3000000 Hz VFA: 3000000 Hz SMT: Auto</p>	Left blank



BLE	2.4GHz 2400~2483.5MHz Band Edge @ 3m	
ANT	BLE CH39 2480MHz	
7	Horizontal	Fundamental
Peak	<p>Site: 0530241M Condition: 704E_78 80 2480.0000 2480.0000 HORIZONTAL BW: 3000000 VFA: 3000000 U: 0MT:Auto</p>	<p>Site: 0530241M Condition: 704E_78 80 2480.0000 2480.0000 HORIZONTAL BW: 3000000 VFA: 3000000 U: 0MT:Auto</p>
Avg.	<p>Site: 0530241M Condition: 704E_78 80 2480.0000 2480.0000 HORIZONTAL BW: 3000000 VFA: 3000000 U: 0MT:Auto</p>	<p>Site: 0530241M Condition: 704E_78 80 2480.0000 2480.0000 HORIZONTAL BW: 3000000 VFA: 3000000 U: 0MT:Auto</p>

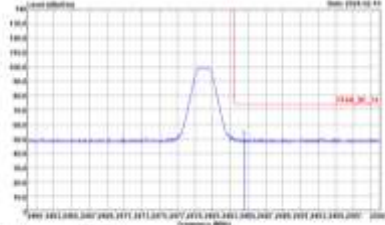
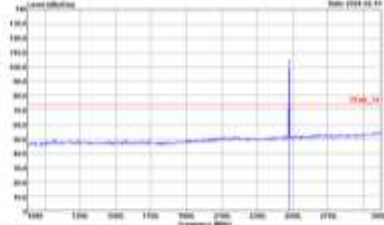
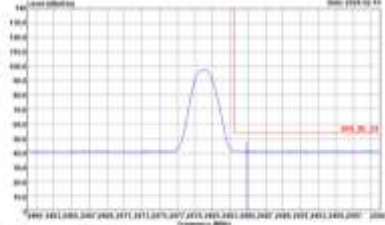
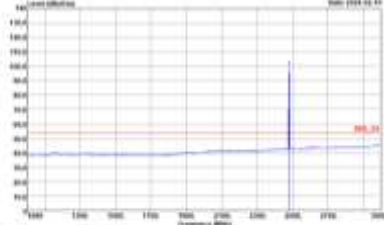

BLE	2.4GHz 2400~2483.5MHz Band Edge @ 3m	
ANT	BLE CH39 2480MHz	
7	Vertical	Fundamental
Peak	 <p>Site: 053024M Condition: PEAK_39_74 80 0.000 0.0000 0.0000 VERTICAL BW: 30000000 VFA: 30000000 DNT:Auto</p>	 <p>Site: 053024M Condition: PEAK_74 80 0.000 0.0000 0.0000 VERTICAL BW: 30000000 VFA: 30000000 DNT:Auto</p>
Avg.	 <p>Site: 053024M Condition: Avg_39_74 80 0.000 0.0000 0.0000 VERTICAL BW: 30000000 VFA: 30000000 DNT:Auto</p>	 <p>Site: 053024M Condition: Avg_74 80 0.000 0.0000 0.0000 VERTICAL BW: 30000000 VFA: 30000000 DNT:Auto</p>



2.4GHz 2400~2483.5MHz

BLE (Harmonic @ 3m)

BLE	2.4GHz 2400~2483.5MHz Harmonic @ 3m	
ANT	BLE CH00 2402MHz	
7	Horizontal	Vertical
Peak Avg.	<p>Site: 053004M Condition: PEAK_74 No PEAK_100M_2402 HORIZONTAL</p>	<p>Site: 053004M Condition: PEAK_74 No PEAK_100M_2402 VERTICAL</p>

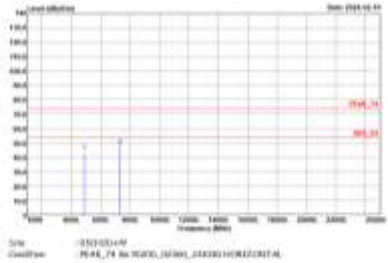
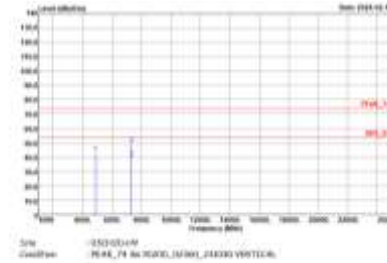

BLE	2.4GHz 2400~2483.5MHz Harmonic @ 3m	
ANT	BLE CH19 2440MHz	
7	Horizontal	Vertical
Peak Avg.		



BLE	2.4GHz 2400~2483.5MHz Harmonic @ 3m	
ANT	BLE CH39 2480MHz	
7	Horizontal	Vertical
Peak	<p>File: 0521024.M Condition: PEAK_74 No: 0000_0000_0000 HORIZONTAL</p>	<p>File: 0521024.M Condition: PEAK_74 No: 0000_0000_0000 VERTICAL</p>



Appendix E. Duty Cycle Plots

Antenna	Band	Duty Cycle(%)	T(us)	1/T(kHz)	VBW Setting
6	Bluetooth - LE for 1Mbps	61.72	387	2.58	2.7kHz
6	Bluetooth - LE for 2Mbps	32.69	204	4.90	5.1kHz
7	Bluetooth - LE for 1Mbps	62.02	387	2.58	2.7kHz
7	Bluetooth - LE for 2Mbps	32.69	204	4.90	5.1kHz

<Ant. 6>

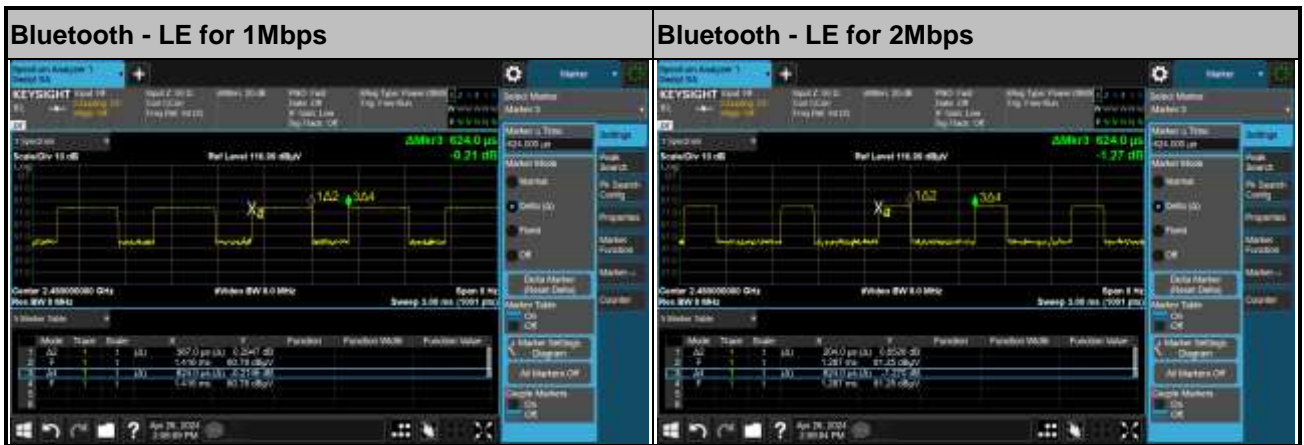

<Ant. 7>

