



FCC RADIO TEST REPORT

FCC ID : UZ7TC58AE
Equipment : Touch Computer
Brand Name : Zebra
Model Name : TC58AE
Applicant : Zebra Technologies Corporation
1 Zebra Plaza, Holtsville, NY 11742
Manufacturer : Zebra Technologies Corporation
1 Zebra Plaza, Holtsville, NY 11742
Standard : FCC Part 15 Subpart C §15.225

The product was received on Jan. 10, 2024 and testing was performed from Feb. 02, 2024 to Feb. 23, 2024. We, Sporton International Inc. EMC & Wireless Communications Laboratory, would like to declare that the tested sample has been evaluated in accordance with the test procedures and has been in compliance with the applicable technical standards.

The test results in this report apply exclusively to the tested model / sample. Without written approval from Sporton International Inc. EMC & Wireless Communications Laboratory, the test report shall not be reproduced except in full.

Louis Wu

Approved by: Louis Wu

Sporton International Inc. EMC & Wireless Communications Laboratory
No. 52, Huaya 1st Rd., Guishan Dist., Taoyuan City 333, Taiwan (R.O.C.)



Table of Contents

History of this test report.....	3
Summary of Test Result.....	4
1. General Description	5
1.1 Product Feature of Equipment Under Test	5
1.2 Product Specification of Equipment Under Test	6
1.3 Modification of EUT	6
1.4 Testing Location	6
1.5 Applicable Standards.....	7
2. Test Configuration of Equipment Under Test.....	8
2.1 Descriptions of Test Mode	8
2.2 Connection Diagram of Test System	9
2.3 Table for Supporting Units	10
2.4 EUT Operation Test Setup	10
3. Test Results	11
3.1 AC Power Line Conducted Emissions Measurement	11
3.2 20dB and 99% OBW Spectrum Bandwidth Measurement.....	13
3.3 Frequency Stability Measurement	14
3.4 Field Strength of Fundamental Emissions and Mask Measurement.....	15
3.5 Radiated Emissions Measurement	17
3.6 Antenna Requirements.....	20
4. List of Measuring Equipment	21
5. Measurement Uncertainty.....	22
Appendix A. Test Results of Conducted Emission Test	
Appendix B. Test Results of Near Field Test Items	
B1. Test Result of 20dB Spectrum Bandwidth	
B2. Test Result of Frequency Stability	
Appendix C. Test Results of Radiated Test Items	
C1. Test Result of Field Strength of Fundamental Emissions	
C2. Results of Radiated Emissions (9 kHz~30MHz)	
C3. Results of Radiated Emissions (30MHz~1GHz)	
Appendix D. Setup Photographs	



Summary of Test Result

Report Clause	Ref Std. Clause	Test Items	Result (PASS/FAIL)	Remark
3.1	15.207	AC Power Line Conducted Emissions	Pass	18.55 dB under the limit at 0.19 MHz
3.2	15.215(c)	20dB Spectrum Bandwidth	Pass	-
	2.1049	99% OBW Spectrum Bandwidth	Reporting only	-
3.3	15.225(e)	Frequency Stability	Pass	-
3.4	15.225(a)(b)(c)	Field Strength of Fundamental Emissions	Pass	Max level 16.56 dB μ V/m at 13.56 MHz
3.5	15.225(d) 15.209	Radiated Spurious Emissions	Pass	8.04 dB under the limit at 30.00 MHz
3.6	15.203	Antenna Requirements	Pass	-

Conformity Assessment Condition:

1. The test results (PASS/FAIL) with all measurement uncertainty excluded are presented against the regulation limits or in accordance with the requirements stipulated by the applicant/manufacturer who shall bear all the risks of non-compliance that may potentially occur if measurement uncertainty is taken into account.
2. The measurement uncertainty please refer to each test result in the section "Measurement Uncertainty".

Disclaimer:

The product specifications of the EUT presented in the test report that may affect the test assessments are declared by the manufacturer who shall take full responsibility for the authenticity.

Reviewed by: Wei Chen**Report Producer: Michelle Chen**



1. General Description

1.1 Product Feature of Equipment Under Test

Product Feature	
Equipment	Touch Computer
Brand Name	Zebra
Model Name	TC58AE
FCC ID	UZ7TC58AE
Sample 1	SE55 + 8GB 128G (Samsung/SK Hynix)
Sample 2	SE4720 + 6GB 64G (SK Hynix/WD)
Sample 3	SE4770 + 6GB 64G (SK Hynix/WD)
EUT supports Radios application	WCDMA/HSPA/LTE/5G NR/NFC/GNSS WLAN 11a/b/g/n HT20/HT40 WLAN 11ac VHT20/VHT40/VHT80/VHT160 WLAN 11ax HE20/HE40/HE80/HE160 Bluetooth BR/EDR/LE
HW Version	DV1-2
SW Version	nemesis_A13_userdebug_GMS_RelKey_2023-12-12-0451_main_SE
FW Version	FUSION_QA_6_1.1.0.004_T
MFD	06DEC23
EUT Stage	Identical Prototype

Remark: The EUT's information above is declared by manufacturer.

Specification of Accessories				
Adapter	Brand Name	Zebra	Part Number	PWR-WUA5V12W0US
Battery 1 (1x)	Brand Name	Zebra	Part Number	BT-000442-0020
Battery 2 (1.5x)	Brand Name	Zebra	Part Number	BT-000442-0820
Battery 3 (BLE battery)	Brand Name	Zebra	Part Number	BT-000442-002B
Battery 4 (Wireless Battery)	Brand Name	Zebra	Part Number	BT-000442-002A
Battery 5 (1x)	Brand Name	Zebra	Part Number	BT-000442-1020
USB TYPE A to TYPE C cable	Brand Name	Zebra	Part Number	CBL-TC5X-USBC2A-01
USB TYPE C to 3.5mm audio connector	Brand Name	Zebra	Part Number	ADP-USBC-35MM1-01
3.5mm Earphone	Brand Name	Zebra	Part Number	HDST-35MM-PTT1-01
Rugged Headset	Brand Name	Zebra	Part Number	HS2100-OTH
USB TYPE C Earphone	Brand Name	Zebra	Part Number	HPST-USBC-PTT1-01
Trigger Handle	Brand Name	Zebra	Part Number	TRG-NGTC5-ELEC-01
Soft Holster	Brand Name	Zebra	Part Number	SG-NGTC5TC7-HLSTR-01
TC53/TC58 RUGGED BOOT	Brand Name	Zebra	Part Number	SG-NGTC5EXO1-01
3.5mm to 3.5mm audio connector	Brand Name	Zebra	Part Number	CBL-HS2100-3MS1-01



1.2 Product Specification of Equipment Under Test

Product Specification is subject to this standard	
Tx/Rx Frequency Range	13.553 ~ 13.567MHz
Channel Number	1
20dBW	2.64 KHz
99%OBW	2.24 KHz
Antenna Type	Loop Antenna
Type of Modulation	ASK

Remark: The EUT's information above is declared by manufacturer. Please refer to Disclaimer in report summary.

1.3 Modification of EUT

No modifications made to the EUT during the testing.

1.4 Testing Location

Test Site	Sporton International Inc. EMC & Wireless Communications Laboratory		
Test Site Location	No.52, Huaya 1st Rd., Guishan Dist., Taoyuan City 333, Taiwan (R.O.C.) TEL: +886-3-327-3456 FAX: +886-3-328-4978		
Test Site No.	Sporton Site No.		
	TH03-HY	CO05-HY	03CH07-HY
Test Engineer	Eric Wu	Calvin Wang	Jesse Wang
Temperature	20.4~22.4°C	23~26°C	22.4~23.8°C
Relative Humidity	35.6~37.6%	45~55%	56.6~60.6%

Note: The test site complies with ANSI C63.4 2014 requirement.

FCC designation No.: TW1190



1.5 Applicable Standards

According to the specifications declared by the manufacturer, the EUT must comply with the requirements of the following standards:

- ♦ FCC Part 15 Subpart C §15.225
- ♦ FCC KDB 414788 D01 Radiated Test Site v01r01
- ♦ ANSI C63.10-2013

Remark:

1. All the test items were validated and recorded in accordance with the standards without any modification during the testing.
2. The TAF code is not including all the FCC KDB listed without accreditation.
3. This EUT has also been tested and complied with the requirements of FCC Part 15, Subpart B, recorded in a separate test report.



2. Test Configuration of Equipment Under Test

2.1 Descriptions of Test Mode

Investigation has been done on all the possible configurations.

The following table is a list of the test modes shown in this test report.

Test Items	
AC Power Line Conducted Emissions	Field Strength of Fundamental Emissions
20dB Spectrum Bandwidth	Frequency Stability
Radiated Emissions 9kHz~30MHz	Radiated Emissions 30MHz~1GHz

The EUT pre-scanned in reader mode with NFC tag (four NFC type A, B, F, V) and without reading tag. Based on the highest field strength of fundamental and spurious emissions, the worst case type (type F) was recorded in this report.

The measured emission level of the EUT was maximized by rotating the EUT on a turntable, adjusting the orientation of the EUT and EUT antenna in three orthogonal axis (X: flat, Y: portrait, Z: landscape) and three receiving antenna orientations (parallel, perpendicular, and ground-parallel) for Loop Antenna, and adjusting the measurement antenna orientation, following C63.10 exploratory test procedures and only the worst case emissions were reported in this report.

Test Cases	
AC Conducted Emission	Mode 1 : WLAN (5GHz) Idle + Bluetooth Idle + NFC Read + USB TYPE-A to TYPE-C cable (Charging with Adapter) + Battery 2 (1.5x) for Sample 1
Remark: For Radiated Test Cases, the tests were performed with Battery 1 (1x) and Sample 1.	

2.2 Connection Diagram of Test System

<AC Conducted Emission Mode>

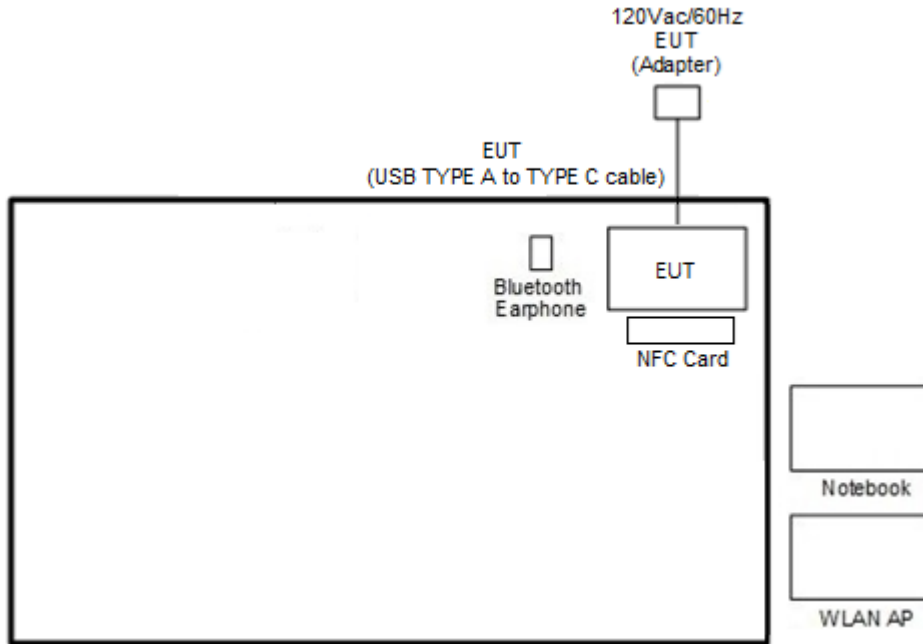

<NFC Tx Mode>

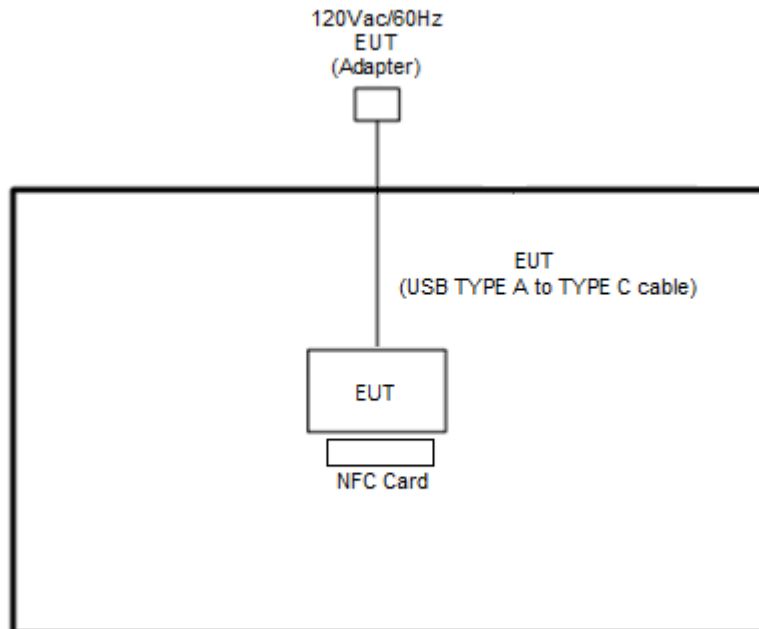



2.3 Table for Supporting Units

Item	Equipment	Brand Name	Model Name	FCC ID	Data Cable	Power Cord
1.	Bluetooth Earphone	Sony Ericsson	MW600	PY7-RD0010	N/A	N/A
2.	WLAN AP	ASUS	RT-AC66U	MSQ-RTAC66U	N/A	Unshielded, 1.8 m
3.	Notebook	Dell	Latitude 3420	FCC DoC	N/A	AC I/P: Unshielded, 1.2 m DC O/P: Shielded, 1.8 m
4.	SD Card	SanDisk	MicroSD HC	FCC DoC	N/A	N/A
5.	NFC Card	Winso	N/A	N/A	N/A	N/A

2.4 EUT Operation Test Setup

The EUT is programmed to be in continuously transmitting mode.

The ancillary equipment, NFC card, is used to make the EUT (NFC) continuously transmitting signal (Power Level: Default) at 13.56MHz.



3. Test Results

3.1 AC Power Line Conducted Emissions Measurement

3.1.1 Limit of AC Conducted Emission

For equipment that is designed to be connected to the public utility (AC) power line, the radio frequency voltage that is conducted back onto the AC power line on any frequency or frequencies within the band 150 kHz to 30 MHz shall not exceed the limits in the following table.

Frequency of Emission (MHz)	Conducted Limit (dBμV)	
	Quasi-Peak	Average
0.15-0.5	66 to 56*	56 to 46*
0.5-5	56	46
5-30	60	50

*Decreases with the logarithm of the frequency.

For terminal test result, the testing follows FCC KDB 174176.

3.1.2 Measuring Instruments

Please refer to the measuring equipment list in this test report.

3.1.3 Test Procedures

1. The EUT is placed 0.4 meter away from the conducting wall of the shielding room, and is kept at least 80 centimeters from any other grounded conducting surface.
2. Connect EUT to the power mains through a line impedance stabilization network (LISN).
3. All the support units are connecting to the other LISN.
4. The LISN provides 50 ohm coupling impedance for the measuring instrument.
5. The FCC states that a 50 ohm, 50 microhenry LISN shall be used.
6. Both Line and Neutral shall be tested in order to find out the maximum conducted emission.
7. The frequency range from 150 kHz to 30 MHz is scanned.
8. Set the test-receiver system to Peak Detect Function and specified bandwidth (IF Bandwidth = 9 kHz) with Maximum Hold Mode. Then measurement is also conducted by Average Detector and Quasi-Peak Detector Function respectively.

3.1.4 Test setup

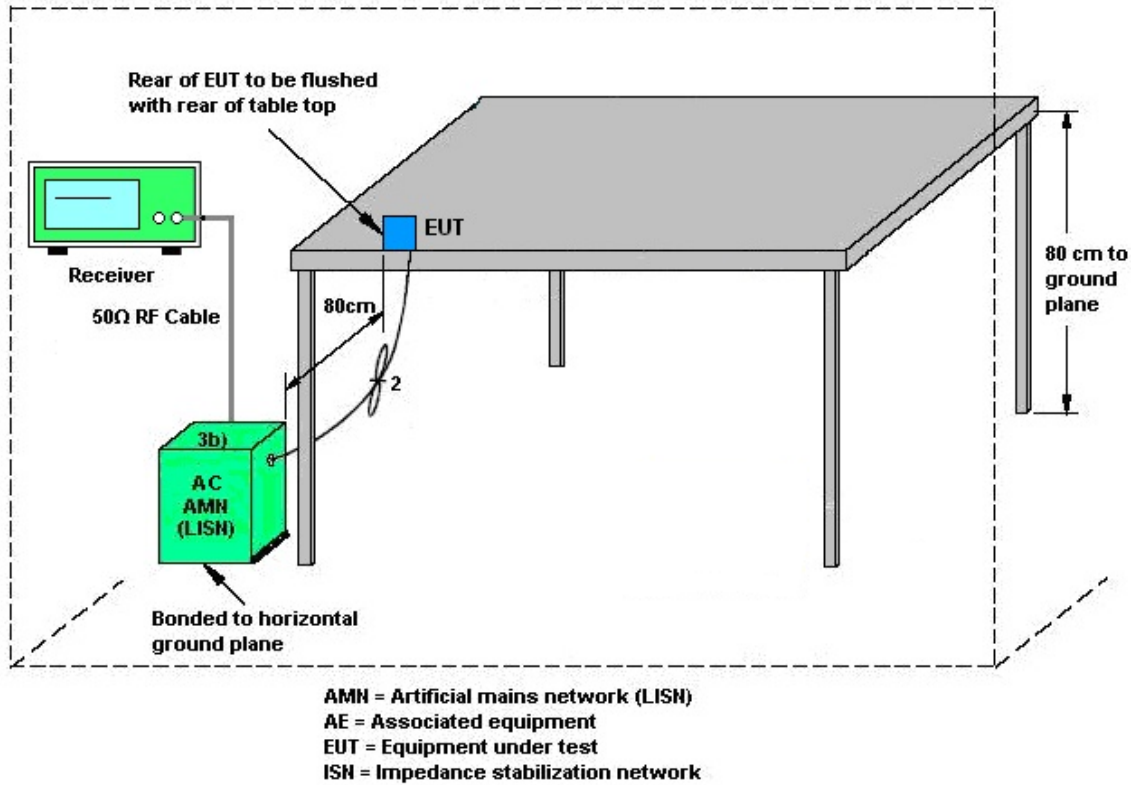

3.1.5 Test Result of AC Conducted Emission

Please refer to Appendix A.

3.2 20dB and 99% OBW Spectrum Bandwidth Measurement

3.2.1 Limit

Intentional radiators must be designed to ensure that the 20 dB and 99% emission bandwidth in the specific band 13.553~13.567 MHz.

3.2.2 Measuring Instruments

Please refer to the measuring equipment list in this test report.

3.2.3 Test Procedures

1. The spectrum analyzer connected via a receive antenna placed near the EUT in peak Max Hold Mode.
2. The resolution bandwidth of 1 kHz and the video bandwidth of 3 kHz were used.
3. Measured the spectrum width with power higher than 20 dB below carrier.
4. Measured the 99% OBW.

3.2.4 Test Setup

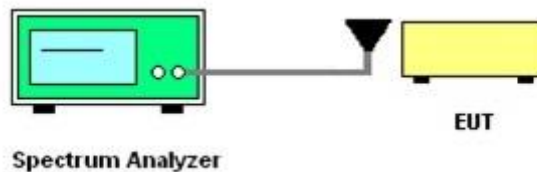

3.2.5 Test Result of Near Field Test Items

Please refer to Appendix B.

3.3 Frequency Stability Measurement

3.3.1 Limit

The frequency tolerance of the carrier signal shall be maintained within +/- 0.01% (100ppm) of the operating frequency over a temperature variation of -20 degrees to +50 degrees C at normal supply voltage, and for a variation in the primary supply voltage from 85% to 115% of the rated supply voltage at a temperature of 20 degrees C. For battery operated equipment, the equipment tests shall be performed by using a new battery.

3.3.2 Measuring Instruments

Please refer to the measuring equipment list in this test report.

3.3.3 Test Procedures

1. The spectrum analyzer connected via a receive antenna placed near the EUT.
2. EUT has transmitted signal and fixed channelize.
3. Set the spectrum analyzer span to view the entire emissions bandwidth.
4. Set RBW = 1 kHz, VBW = 3 kHz with peak detector and maxhold settings.
5. The f_c is declaring of channel frequency. Then the frequency error formula is $(f_c - f) / f_c \times 10^6$ ppm and the limit is less than ± 100 ppm.
6. Extreme temperature rule is -20°C~50°C.

3.3.4 Test Setup

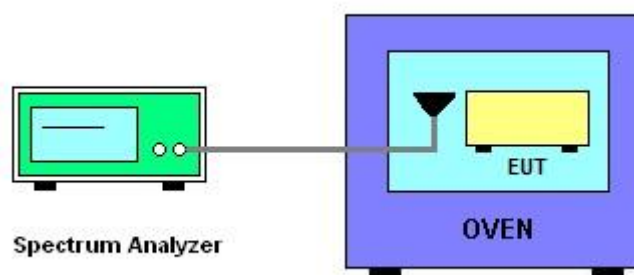

3.3.5 Test Result of Near Field Test Items

Please refer to Appendix B.



3.4 Field Strength of Fundamental Emissions and Mask Measurement

3.4.1 Limit

Rules and specifications	FCC CFR 47 Part 15 section 15.225			
Description	Compliance with the spectrum mask is tested with RBW set to 9kHz.			
Freq. of Emission (MHz)	Field Strength (μV/m) at 30m	Field Strength (dBμV/m) at 30m	Field Strength (dBμV/m) at 10m	Field Strength (dBμV/m) at 3m
1.705~13.110	30	29.5	48.58	69.5
13.110~13.410	106	40.5	59.58	80.5
13.410~13.553	334	50.5	69.58	90.5
13.553~13.567	15848	84.0	103.08	124.0
13.567~13.710	334	50.5	69.58	90.5
13.710~14.010	106	40.5	59.58	80.5
14.010~30.000	30	29.5	48.58	69.5

Remark:

- 1. The field strength test result is in 3m test distance, follow test rules the test data use distance extrapolation factor and reported in this report at 30m test result.
- 2. Distance extrapolation factor = $40 \log(\text{specific distance} / \text{test distance})$ (dB)

3.4.2 Measuring Instruments

Please refer to the measuring equipment list in this test report.

3.4.3 Test Procedures

1. Configure the EUT according to ANSI C63.10. The EUT is placed on the top of the turntable 0.8 meter above ground. The phase center of the loop receiving antenna mounted antenna tower is placed 3 meters far away from the turntable.
2. Power on the EUT and all the supporting units. The turntable is rotated by 360 degrees to determine the position of the highest radiation.
3. The height of the receiving antenna is fixed at one meter above ground to find the maximum emissions field strength.
4. For Fundamental emissions, use the receiver to measure QP reading.
5. When the radiated emissions limits are expressed in terms of the average value of the emissions, and pulsed operation is employed, the measurement field strength shall be determined by averaging over one complete pulse train, including blanking intervals, as long as the pulse train does not exceed 0.1 seconds. As an alternative (provided the transmitter operates for longer than 0.1 seconds) or in cases where the pulse train exceeds 0.1 seconds, the measured field strength shall be determined from the average absolute voltage during a 0.1 second interval during which the field strength is at its maximum value.
6. Compliance with the spectrum mask is tested with RBW set to 9 kHz.
Note: Emission level (dB μ V/m) = 20 log Emission level (μ V/m).

3.4.4 Test Setup

For radiated test below 30MHz

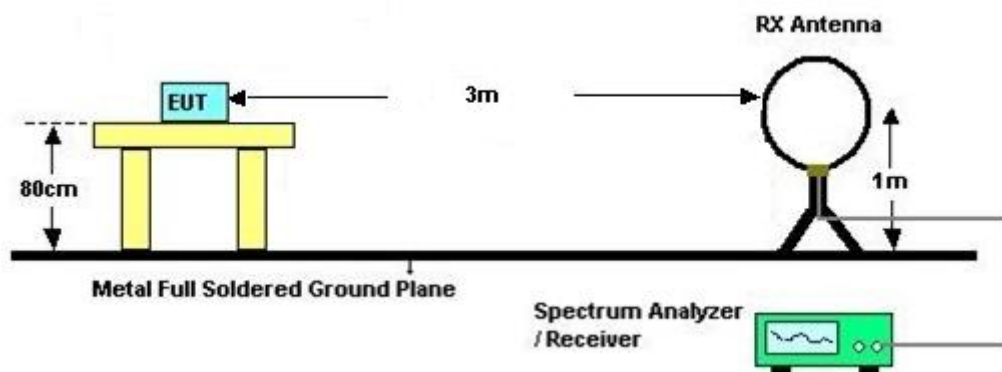

3.4.5 Test Result of Field Strength of Fundamental Emissions and Mask

Please refer to Appendix C.



3.5 Radiated Emissions Measurement

3.5.1 Limit

The field strength of any emissions which appear outside of 13.110 ~14.010MHz band shall not exceed the general radiated emissions limits.

Frequencies (MHz)	Field Strength (μV/m)	Measurement Distance (meters)
0.009~0.490	2400/F(kHz)	300
0.490~1.705	24000/F(kHz)	30
1.705~30.0	30	30
30~88	100	3
88~216	150	3
216~960	200	3
Above 960	500	3

3.5.2 Measuring Instruments

Please refer to the measuring equipment list in this test report.

3.5.3 Measuring Instrument Setting

The following table is the setting of receiver:

Receiver Parameter	Setting
Attenuation	Auto
Frequency Range: 9kHz~150kHz	RBW 200Hz for QP
Frequency Range: 150kHz~30MHz	RBW 9kHz for QP
Frequency Range: 30MHz~1000MHz	RBW 120kHz for Peak

Note: The emission limits shown in the above table are based on measurements employing a CISPR quasi-peak detector except for the frequency bands 9-90 kHz and 110-490 kHz. Radiated emission limits in these two bands are based on measurements employing an average detector.



3.5.4 Test Procedures

1. Configure the EUT according to ANSI C63.10. The EUT is placed on the top of the turntable 0.8 meter above ground. The phase center of the receiving antenna mounted on the top of a height-variable antenna tower is placed 3 meters far away from the turntable.
2. Power on the EUT and all the supporting units. The turntable is rotated by 360 degrees to determine the position of the highest radiation.
3. The height of the broadband receiving antenna is varied between one meter and four meters above ground to find the maximum emissions field strength of both horizontal and vertical polarization.
4. For each suspected emissions, the antenna tower is scanned (from 1 M to 4 M) and then the turntable is rotated (from 0 degree to 360 degrees) to find the maximum reading.
5. Set the test-receiver system to Peak or CISPR quasi-peak Detect Function with specified bandwidth under Maximum Hold Mode.
6. When the radiated emissions limits are expressed in terms of the average value of the emissions, and pulsed operation is employed, the measurement field strength shall be determined by averaging over one complete pulse train, including blanking intervals, as long as the pulse train does not exceed 0.1 seconds. As an alternative (provided the transmitter operates for longer than 0.1 seconds) or in cases where the pulse train exceeds 0.1 seconds, the measured field strength shall be determined from the average absolute voltage during a 0.1 second interval during which the field strength is at its maximum value.
7. In case the emission is lower than 30 MHz, loop antenna has to be used for measurement and the recorded data shall be QP measured by receiver.
8. Radiated testing below 1 GHz is performed by adjusting the antenna tower from 1 m to 4 m and by rotating the turn table from 0 degree to 360 degrees to find the peak maximum hold reading. When there is no suspected emission found and the emission level is with at least 6 dB margin against QP limit line, the position is marked as “-“.

3.5.5 Test Setup

For radiated test below 30MHz

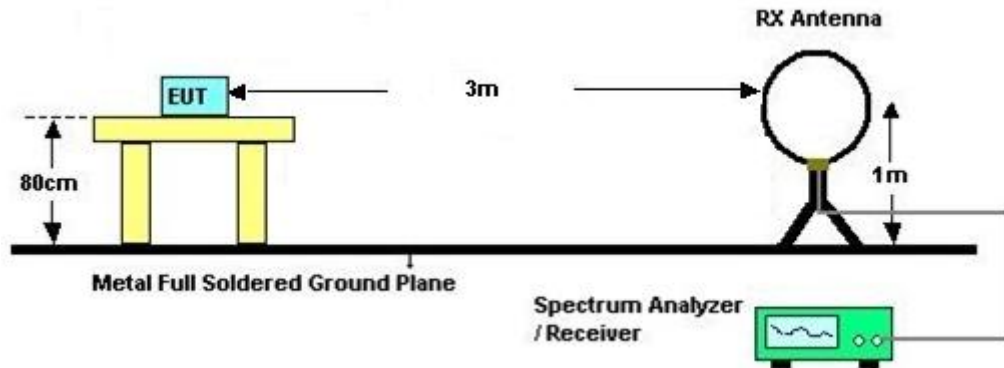

For radiated test above 30MHz

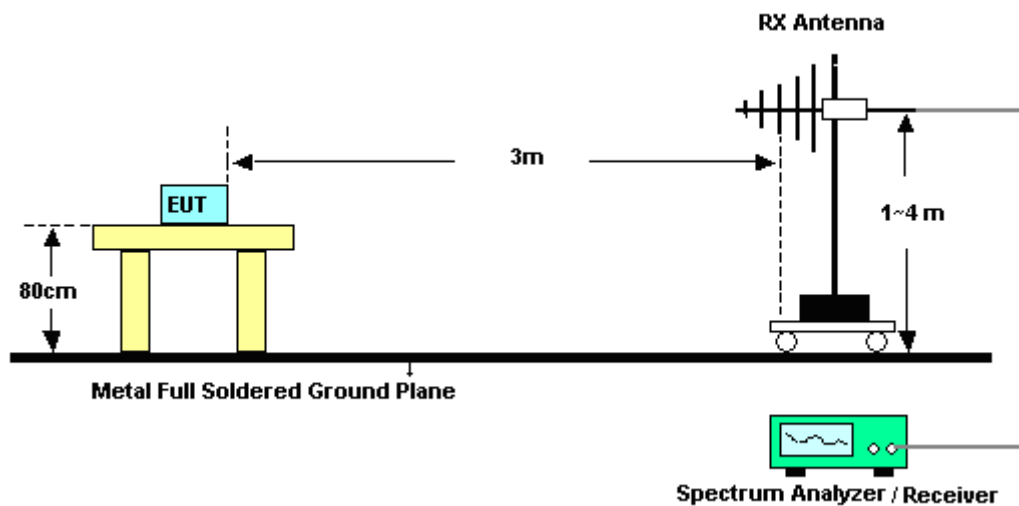

3.5.6 Test Result of Radiated Emissions Measurement

Please refer to Appendix C.

Remark: There is adequate comparison measurement of both open-field test site and alternative test site - semi-Anechoic chamber according to 414788 D01 Radiated Test Site v01r01, and the result came out very similar.



3.6 Antenna Requirements

3.6.1 Standard Applicable

Except for special regulations, the Low-power Radio-frequency Devices must not be equipped with any jacket for installing an antenna with extension cable. An intentional radiator shall be designed to ensure that no antenna other than that furnished by the responsible party shall be used with the device. The use of a permanently attached antenna or of an antenna that uses a unique coupling to the intentional radiator shall be considered sufficient to comply with the provisions of this Section. The manufacturer may design the unit so that the user can replace a broken antenna, but the use of a standard antenna jack or electrical connector is prohibited.

The use of a permanently attached antenna or of an antenna that uses a unique coupling to the intentional radiator shall be considered sufficient to comply with the rule.

3.6.2 Antenna Anti-Replacement Construction

An embedded-in antenna design is used.



4. List of Measuring Equipment

Instrument	Brand Name	Model No.	Serial No.	Characteristics	Calibration Date	Test Date	Due Date	Remark
Hygrometer	TECEPEL	DTM-303A	TP201996	N/A	Nov. 07, 2023	Feb. 23, 2024	Nov. 06, 2024	Near Field (TH03-HY)
Spectrum Analyzer	Rohde & Schwarz	FSP30	101329	9kHz~30GHz	Sep. 20, 2023	Feb. 23, 2024	Sep. 19, 2024	Near Field (TH03-HY)
Thermal Chamber	ESPEC	SU-241	92003713	-30°C ~95°C	May 17, 2023	Feb. 23, 2024	May 16, 2024	Near Field (TH03-HY)
Programmable Power Supply	GW Instek	PSS-2005	EL890001	1V~20V 0.5A~4A	Sep. 12, 2023	Feb. 23, 2024	Sep 11, 2024	Near Field (TH03-HY)
AC Power Source	ChainTek	APC-1000W	N/A	N/A	N/A	Feb. 02, 2024	N/A	Conduction (CO05-HY)
EMI Test Receiver	Rohde & Schwarz	ESR3	102388	9kHz~3.6GHz	Dec. 06, 2023	Feb. 02, 2024	Dec. 05, 2024	Conduction (CO05-HY)
Hygrometer	Testo	608-H1	34913912	N/A	Oct. 26, 2023	Feb. 02, 2024	Oct. 25, 2024	Conduction (CO05-HY)
LISN	Rohde & Schwarz	ENV216	100081	9kHz~30MHz	Nov. 22, 2023	Feb. 02, 2024	Nov. 21, 2024	Conduction (CO05-HY)
Software	Rohde & Schwarz	EMC32	N/A	N/A	N/A	Feb. 02, 2024	N/A	Conduction (CO05-HY)
ISN Cable	MVE	RG-400	200260	N/A	Dec. 28, 2023	Feb. 02, 2024	Dec. 27, 2024	Conduction (CO05-HY)
Pulse Limiter	SCHWARZBECK	VTSD 9561-F N	00691	9kHz-200MHz	Jul. 28, 2023	Feb. 02, 2024	Jul. 27, 2024	Conduction (CO05-HY)
LISN Cable	MVE	RG-400	260260	N/A	Dec. 28, 2023	Feb. 02, 2024	Dec. 27, 2024	Conduction (CO05-HY)
EMI Test Receiver	Rohde & Schwarz	ESU26	100472	20Hz~26.5GHz	Feb. 01, 2024	Feb. 19, 2024	Jan. 31, 2025	Radiation (03CH07-HY)
Bilog Antenna	TESEQ	CBL 6111D & 00800N1D01N-06	35419 & 03	30MHz~1GHz	Apr. 23, 2023	Feb. 19, 2024	Apr. 22, 2024	Radiation (03CH07-HY)
Loop Antenna	Rohde & Schwarz	HFH2-Z2	100315	9 kHz~30 MHz	Feb. 28, 2023	Feb. 19, 2024	Feb. 27, 2024	Radiation (03CH07-HY)
Preamplifier	COM-POWER	PA-103A	161241	10MHz~1GHz	Oct. 02, 2023	Feb. 19, 2024	Oct. 01, 2024	Radiation (03CH07-HY)
RF Cable	HUBER + SUHNER	SUCOFLEX 104	MY15682/4	30MHz to 18GHz	Feb. 22, 2023	Feb. 19, 2024	Feb. 21, 2024	Radiation (03CH07-HY)
RF Cable	HUBER + SUHNER	SUCOFLEX 104	MY24971/4	9kHz to 18GHz	Feb. 22, 2023	Feb. 19, 2024	Feb. 21, 2024	Radiation (03CH07-HY)
RF Cable	HUBER + SUHNER	SUCOFLEX 104	MY28655/4	9kHz to 18GHz	Feb. 22, 2023	Feb. 19, 2024	Feb. 21, 2024	Radiation (03CH07-HY)
Controller	EMEC	EM1000	N/A	Control Ant Mast	N/A	Feb. 19, 2024	N/A	Radiation (03CH07-HY)
Controller	MF	MF-7802	N/A	Control Turn table	N/A	Feb. 19, 2024	N/A	Radiation (03CH07-HY)
Antenna Mast	EMEC	AM-BS-4500E	N/A	Boresight mast 1M~4M	N/A	Feb. 19, 2024	N/A	Radiation (03CH07-HY)
Turn Table	ChainTek	Chaintek 3000	N/A	0~360 Degree	N/A	Feb. 19, 2024	N/A	Radiation (03CH07-HY)
Software	Audix	E3	N/A	N/A	N/A	Feb. 19, 2024	N/A	Radiation (03CH07-HY)
USB Data Logger	TECEPEL	TR-32	HE17XB2495	N/A	Mar. 14, 2023	Feb. 19, 2024	Mar. 13, 2024	Radiation (03CH07-HY)



5. Measurement Uncertainty

Uncertainty of Conducted Emission Measurement (150 kHz ~ 30 MHz)

Measuring Uncertainty for a Level of Confidence of 95% ($U = 2Uc(y)$)	3.5 dB
---	--------

Uncertainty of Radiated Emission Measurement (9 kHz ~ 30 MHz)

Measuring Uncertainty for a Level of Confidence of 95% ($U = 2Uc(y)$)	3.8 dB
---	--------

Uncertainty of Radiated Emission Measurement (30 MHz ~ 1000 MHz)

Measuring Uncertainty for a Level of Confidence of 95% ($U = 2Uc(y)$)	6.3 dB
---	--------



Appendix A. Test Results of Conducted Emission Test

EUT Information

Report NO : 411111
 Test Mode : Mode 1
 Test Voltage : 120Vac/60Hz
 Phase : Line

Full Spectrum

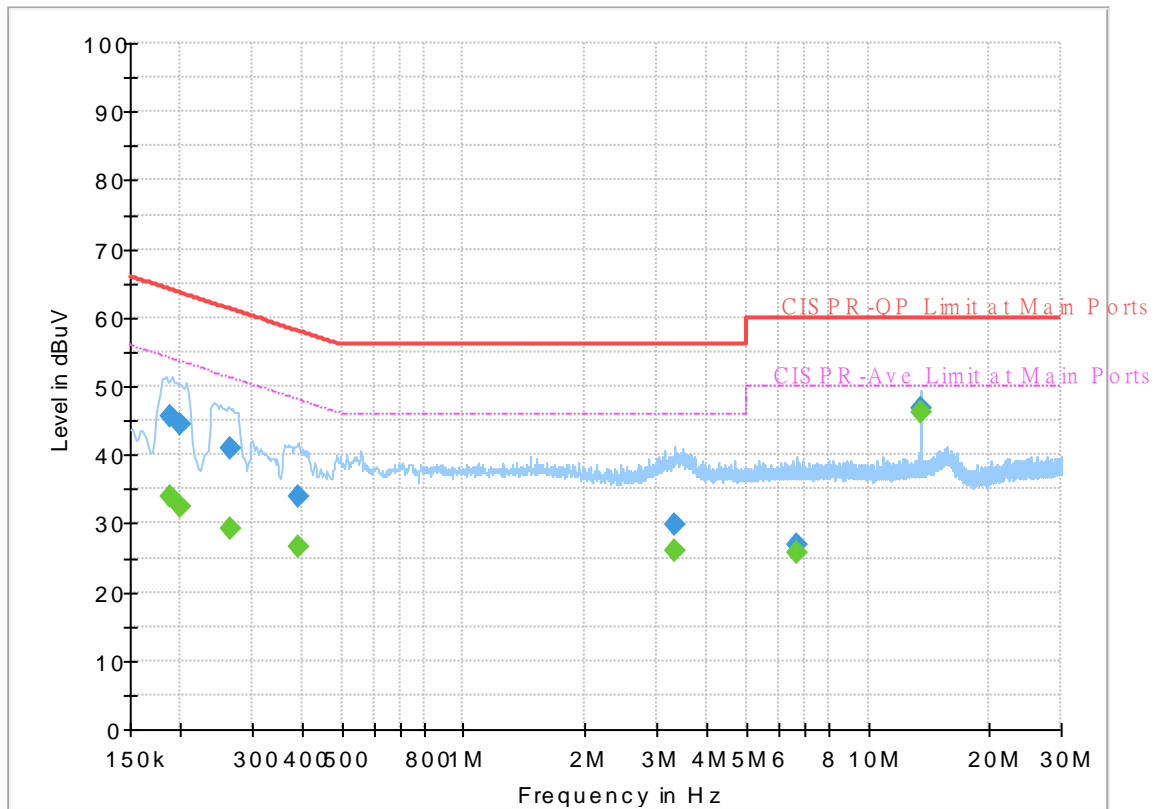

Final_Result

Frequency (MHz)	QuasiPeak (dBuV)	CAverage (dBuV)	Limit (dBuV)	Margin (dB)	Line	Filter	Corr. (dB)
0.188250	---	33.95	54.11	20.16	L1	OFF	19.8
0.188250	45.56	---	64.11	18.55	L1	OFF	19.8
0.199500	---	32.34	53.63	21.29	L1	OFF	19.8
0.199500	44.47	---	63.63	19.16	L1	OFF	19.8
0.264750	---	29.33	51.28	21.95	L1	OFF	19.8
0.264750	41.01	---	61.28	20.27	L1	OFF	19.8
0.388500	---	26.67	48.10	21.43	L1	OFF	19.8
0.388500	33.85	---	58.10	24.25	L1	OFF	19.8
3.342750	---	26.09	46.00	19.91	L1	OFF	19.9
3.342750	29.75	---	56.00	26.25	L1	OFF	19.9
6.699750	---	25.75	50.00	24.25	L1	OFF	20.0
6.699750	27.03	---	60.00	32.97	L1	OFF	20.0
13.560000	---	46.17	50.00	3.83	L1	OFF	20.2
13.560000	46.75	---	60.00	13.25	L1	OFF	20.2

EUT Information

Report NO : 411111
 Test Mode : Mode 1
 Test Voltage : 120Vac/60Hz
 Phase : Neutral

Full Spectrum

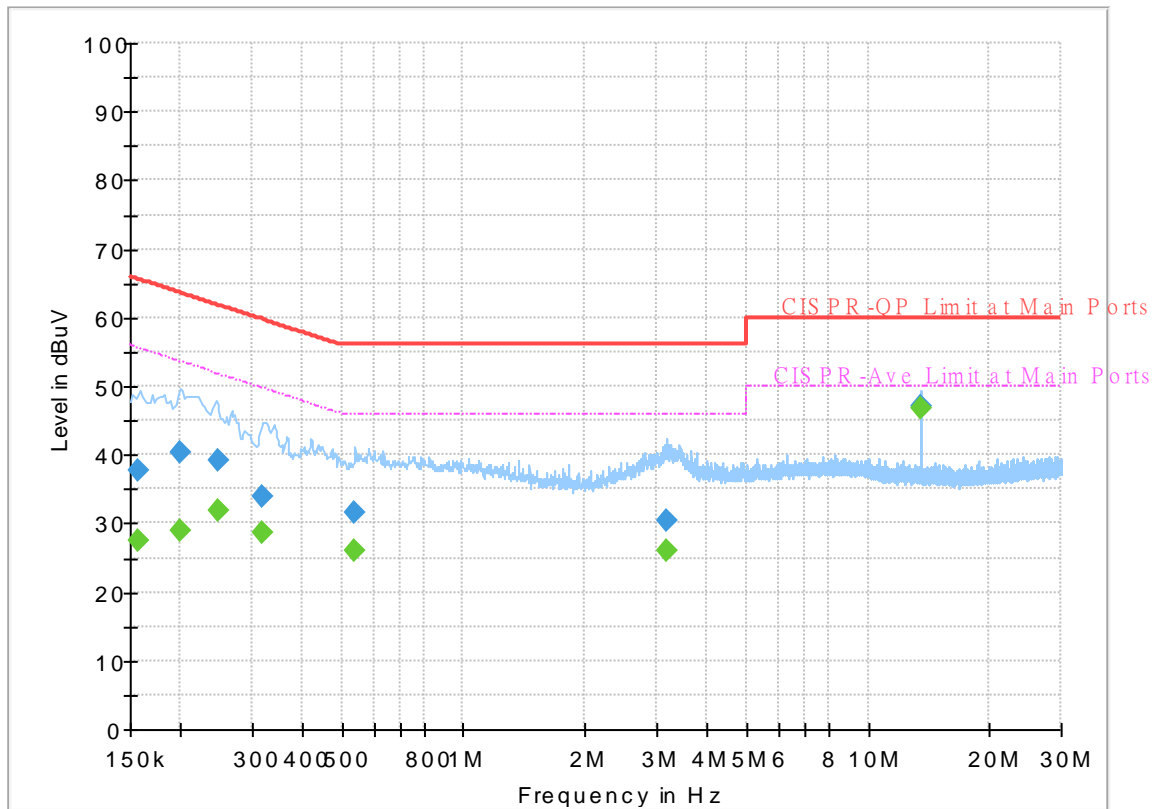

Final_Result

Frequency (MHz)	QuasiPeak (dBuV)	CAverage (dBuV)	Limit (dBuV)	Margin (dB)	Line	Filter	Corr. (dB)
0.156750	---	27.37	55.63	28.26	N	OFF	19.8
0.156750	37.77	---	65.63	27.86	N	OFF	19.8
0.199500	---	28.99	53.63	24.64	N	OFF	19.8
0.199500	40.36	---	63.63	23.27	N	OFF	19.8
0.246750	---	31.75	51.87	20.12	N	OFF	19.8
0.246750	39.15	---	61.87	22.72	N	OFF	19.8
0.316500	---	28.51	49.80	21.29	N	OFF	19.8
0.316500	33.96	---	59.80	25.84	N	OFF	19.8
0.539250	---	25.96	46.00	20.04	N	OFF	19.8
0.539250	31.66	---	56.00	24.34	N	OFF	19.8
3.194250	---	25.97	46.00	20.03	N	OFF	19.9
3.194250	30.50	---	56.00	25.50	N	OFF	19.9
13.560000	---	46.67	50.00	3.33	N	OFF	20.3
13.560000	47.08	---	60.00	12.92	N	OFF	20.3



Appendix B. Test Results of Near Field Test Items

B1. Test Result of 20dB Spectrum Bandwidth

Test mode	NFC Tx	Test Frequency (MHz)	13.56
Date: 23.FEB.2024 10:33:53		Date: 23.FEB.2024 10:33:19	
20dB Bandwidth (kHz)	2.640	99% OccupiedBW(kHz)	2.240
Frequency range (MHz)	$f_L > 13.553$	13.55878	Test Result
	$f_H < 13.567$	13.56142	Complies

Remark: Because the measured signal is CW adjusting the RBW per C63.10 would not be practical since measured bandwidth will always follow the RBW and the result will be approximately twice the RBW.



B2. Test Result of Frequency Stability

Voltage vs. Frequency Stability		Temperature vs. Frequency Stability		
Voltage (Vdc)	Measurement Frequency (MHz)	Temperature (°C)	Time	Measurement Frequency (MHz)
3.8	13.560100	-20	0	13.560180
3.6	13.560100		2	13.560180
4.2	13.560100		5	13.560190
			10	13.560180
		-10	0	13.560190
			2	13.560200
			5	13.560200
			10	13.560190
		0	0	13.560200
			2	13.560200
			5	13.560200
			10	13.560200
		10	0	13.560180
			2	13.560180
			5	13.560180
			10	13.560180
		20	0	13.560130
			2	13.560120
			5	13.560120
			10	13.560120
		30	0	13.560090
			2	13.560090
			5	13.560090
			10	13.560080
		40	0	13.560060
			2	13.560060
			5	13.560060
			10	13.560060



Voltage vs. Frequency Stability		Temperature vs. Frequency Stability		
Voltage (Vdc)	Measurement Frequency (MHz)	Temperature (°C)	Time	Measurement Frequency (MHz)
		50	0	13.560060
			2	13.560050
			5	13.560040
			10	13.560040
Max.Deviation (MHz)	0.000100	Max.Deviation (MHz)		0.000200
Max.Deviation (ppm)	7.3746	Max.Deviation (ppm)		14.7493
Limit	FS < ±100 ppm	Limit		FS < ±100 ppm
Test Result	PASS	Test Result		PASS



Appendix C. Test Results of Radiated Test Items

C1. Test Result of Field Strength of Fundamental Emissions

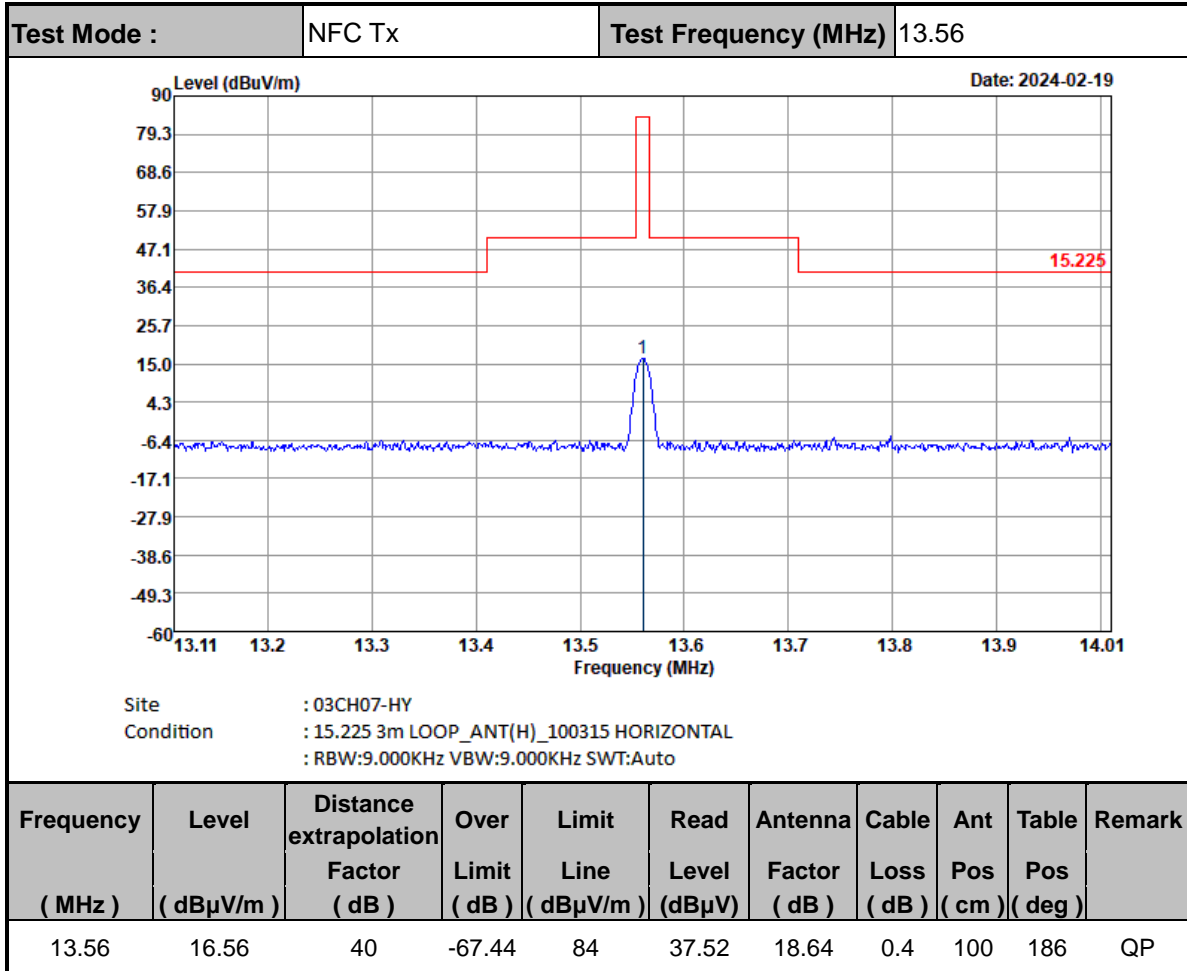

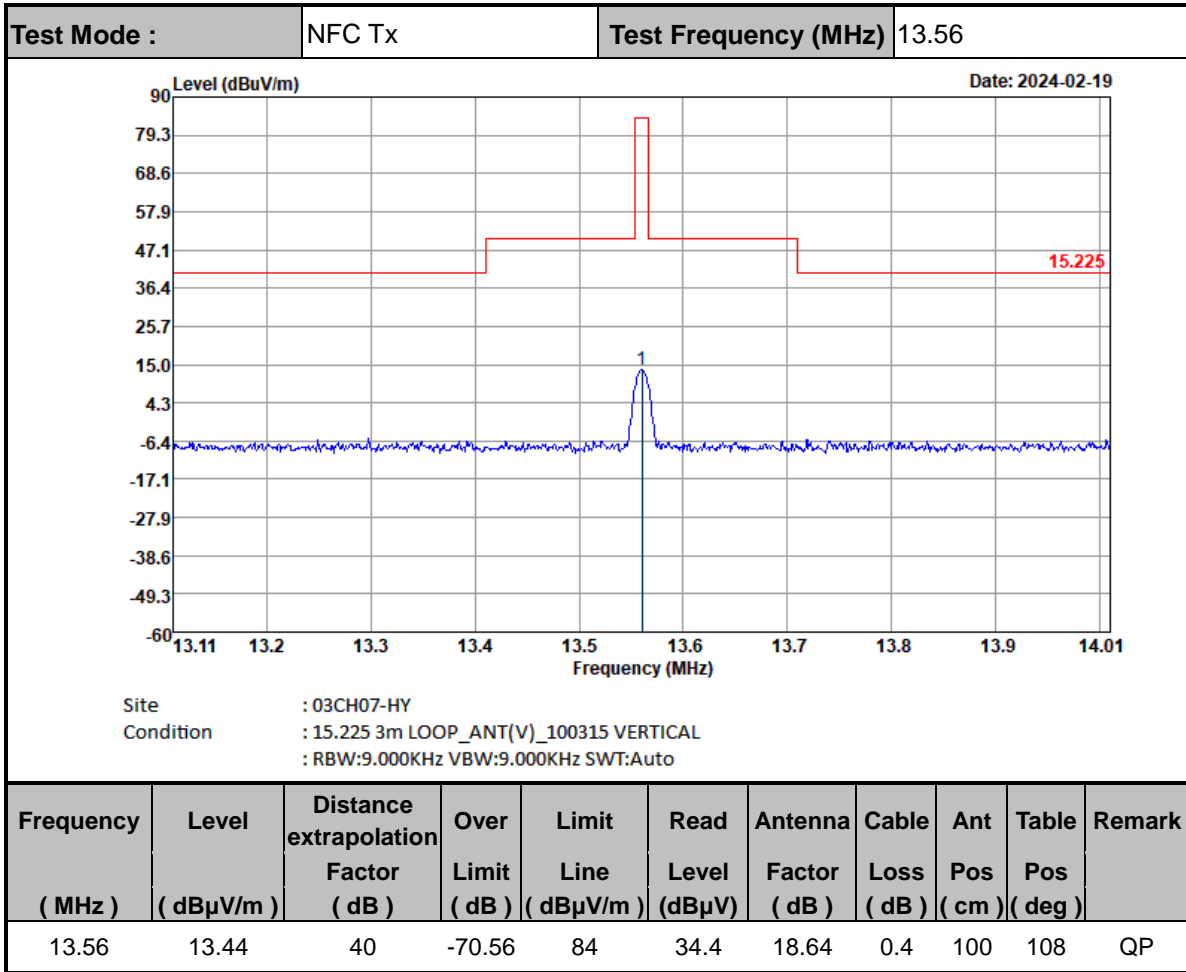

Note :

1. Distance extrapolation factor = 40 log (specific distance / test distance) (dB)
2. Level = Antenna Factor + Cable Loss + Read Level - Distance extrapolation factor.



C2. Results of Radiated Spurious Emissions (9 kHz~30MHz)

Test Mode :	NFC Tx	Polarization :	Horizontal
-------------	--------	----------------	------------

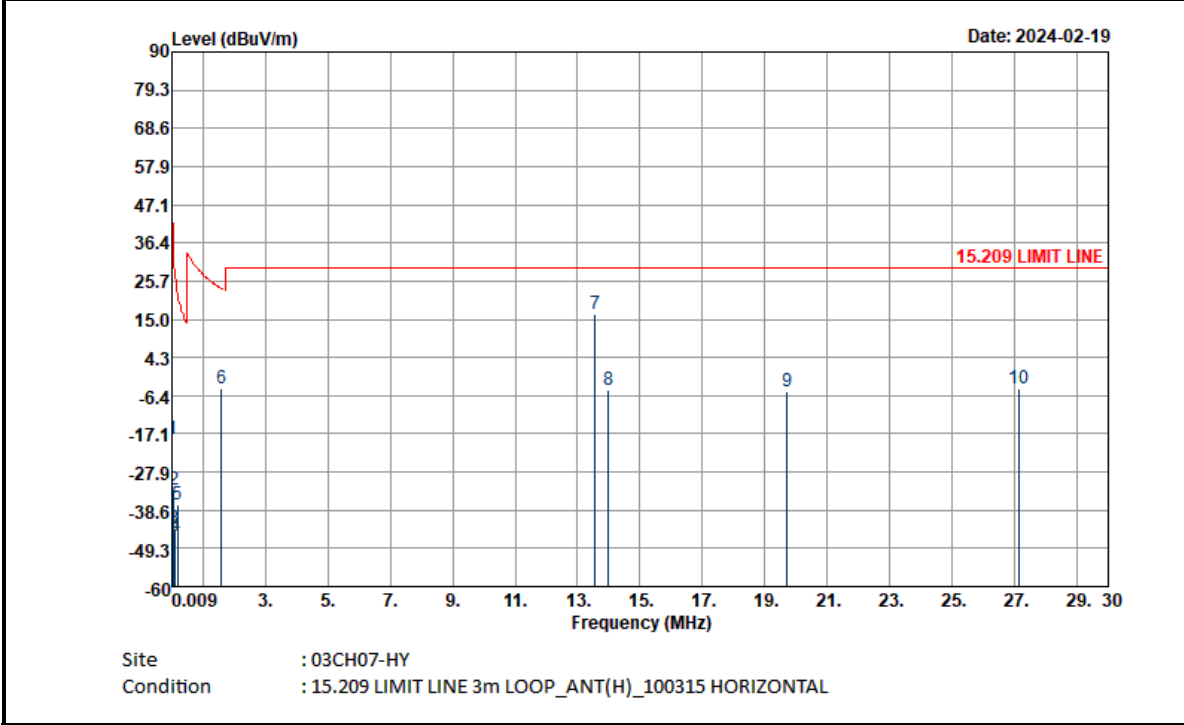

Frequency (MHz)	Level (dBμV/m)	Distance extrapolation Factor (dB)	Over Limit (dB)	Limit Line (dBμV/m)	Read Level (dBμV)	Antenna Factor (dB)	Cable Loss (dB)	Ant Pos (cm)	Table Pos (deg)	Remark
0.02048	-18.79	80	-60.17	41.38	42.26	18.93	0.02	-	-	Average
0.06723	-32.93	80	-63.98	31.05	28.36	18.68	0.03	-	-	Average
0.0949	-43.59	80	-71.65	28.06	17.75	18.62	0.04	-	-	QP
0.11044	-45.65	80	-72.39	26.74	15.71	18.6	0.04	-	-	Average
0.18468	-37.18	80	-59.46	22.28	24.21	18.55	0.06	-	-	Average
1.586	-4.63	40	-28.23	23.6	16.76	18.46	0.15	-	-	QP
13.56	16.56	40	-12.94	29.5	37.52	18.64	0.4	-	-	QP
13.984	-4.87	40	-34.37	29.5	16.06	18.66	0.41	-	-	QP
19.717	-5.33	40	-34.83	29.5	15.04	19.12	0.51	-	-	QP
27.125	-4.43	40	-33.93	29.5	15.02	19.78	0.77	-	-	QP



Test Mode :	NFC Tx	Polarization :	Vertical
-------------	--------	----------------	----------

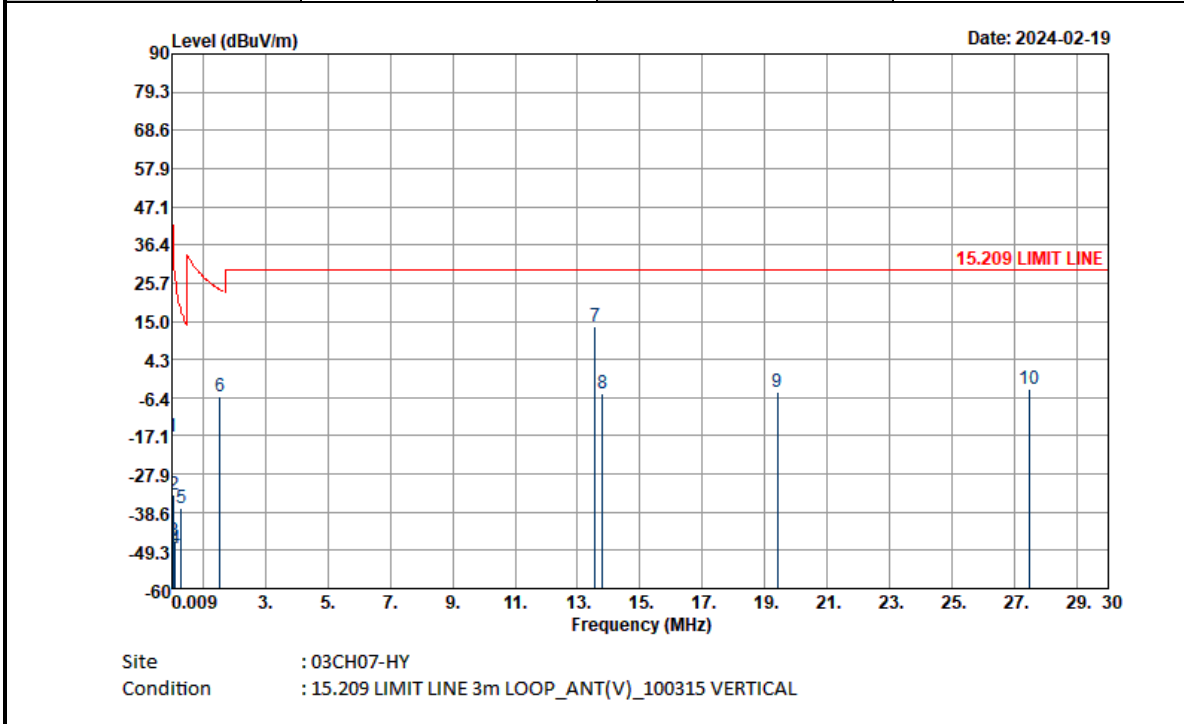

Frequency (MHz)	Level (dBμV/m)	Distance extrapolation Factor (dB)	Over Limit (dB)	Limit Line (dBμV/m)	Read Level (dBμV)	Antenna Factor (dB)	Cable Loss (dB)	Ant Pos (cm)	Table Pos (deg)	Remark
0.02048	-17.51	80	-58.89	41.38	43.54	18.93	0.02	-	-	Average
0.06723	-33.71	80	-64.76	31.05	27.58	18.68	0.03	-	-	Average
0.10004	-46.77	80	-74.37	27.6	14.58	18.61	0.04	-	-	QP
0.11248	-48.76	80	-75.34	26.58	12.6	18.6	0.04	-	-	Average
0.31762	-37.48	80	-55.05	17.57	23.96	18.51	0.05	-	-	Average
1.541	-6.16	40	-30.01	23.85	15.23	18.46	0.15	-	-	QP
13.56	13.44	40	-16.06	29.5	34.4	18.64	0.4	-	-	QP
13.8	-5.43	40	-34.93	29.5	15.51	18.65	0.41	-	-	QP
19.393	-5.05	40	-34.55	29.5	15.37	19.08	0.5	-	-	QP
27.47	-4.17	40	-33.67	29.5	15.26	19.77	0.8	-	-	QP

Note :

1. The amplitude of spurious emissions which are attenuated by more than 20dB below the permissible value has no need to be reported.
2. Distance extrapolation factor = 40 log (specific distance / test distance) (dB)
3. Level = Antenna Factor + Cable Loss + Read Level - Distance extrapolation factor.
4. 13.56 MHz is fundamental signal which can be ignored



C3. Results of Radiated Spurious Emissions (30MHz~1GHz)

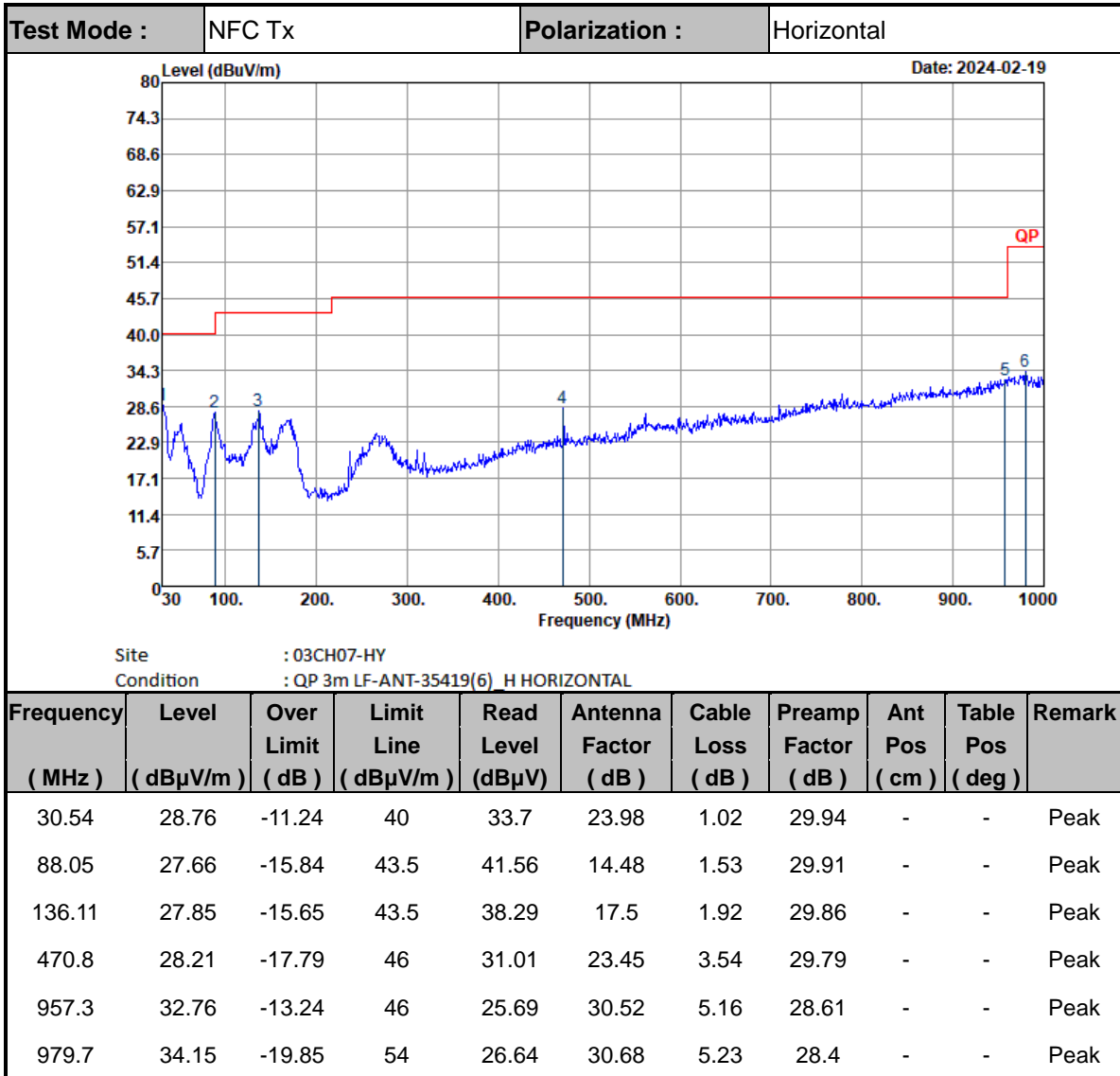

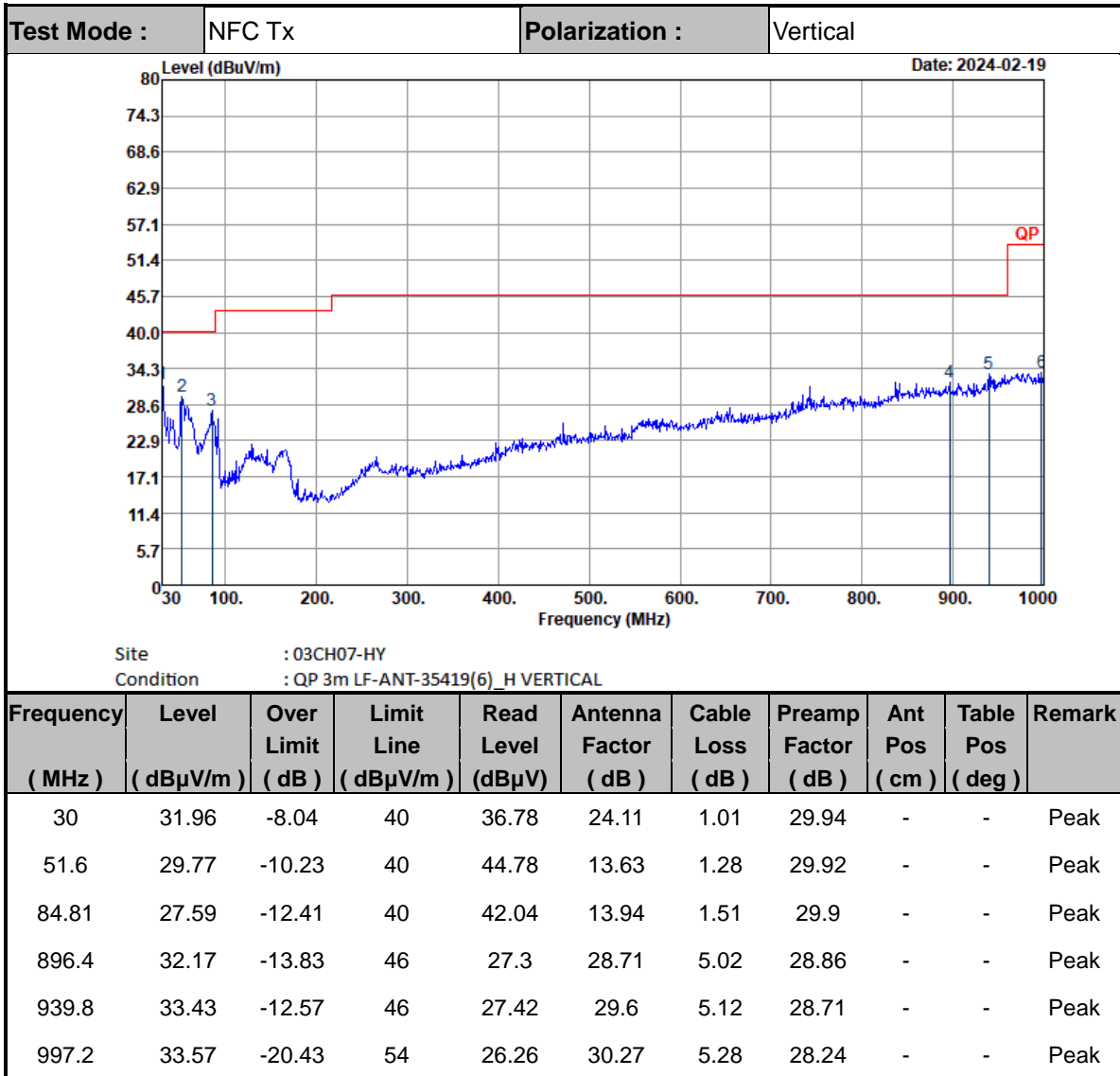

Note:

1. The amplitude of spurious emissions which are attenuated by more than 20dB below the permissible value has no need to be reported.
2. Emission level (dBμV/m) = 20 log Emission level (μV/m).
3. Corrected Reading: Antenna Factor + Cable Loss + Read Level - Preamp Factor= Level.
4. The emission position marked as "-" means no suspected emission found with sufficient margin against limit line or noise floor only.