

Ericsson AB
Anders Karlsson
BURA DURA RP QRM
Torshamnsgatan 21
164 80 Stockholm

Radio measurements on Radio 4415 B2 B25 equipment with FCC ID TA8AKRC161636 and IC: 287AB-AS161636

Product name: Radio 4415 B2 B25
Product number: KRC 161 636/1

RISE Research Institutes of Sweden AB Electronics - EMC

Performed by

Examined by

Tomas Lennhager

Monika Fuller

RISE Research Institutes of Sweden AB

Postal address	Office location	Phone / Fax / E-mail
Box 857	Brinellgatan 4	+46 10 516 50 00
SE-501 15 BORÅS	SE-504 62 BORÅS	+46 33 13 55 02
Sweden		info@ri.se

This report may not be reproduced other than in full, except
with the prior written approval of the issuing laboratory.

Summary	3
Description of the test object	4
Purpose of test.....	5
Operation modes during measurements	5
Conducted measurements	5
Radiated measurements.....	5
References.....	5
Measurement equipment	6
Uncertainties	6
Reservation	6
Delivery of test object.....	6
Manufacturer’s representative.....	6
Test engineers	6
Test participant(-s).....	6
Test frequencies used for radiated and conducted measurements.....	7
Test setup: conducted measurements	8
Test setup: radiated measurements.....	9
RF power output measurements according to CFR 47 §24.232 / IC RSS-133 6.4, conducted	11
Test set-up and procedure	11
Results.....	11
Remark	11
Limits	12
Conducted spurious emission measurements according to CFR 47 §24.238 / IC RSS-133 6.2	13
Test set-up and procedure	13
Results.....	13
Remark	13
Limits	13
Field strength of spurious radiation measurements according to CFR 47 §2.1053 / IC RSS-133	20
6.5.....	20
Measurement equipment.....	22
Results.....	22
Limits	22
Photos of test object	25

Summary

Standard Listed part of	Compliant
FCC CFR 47 part 24/ RSS 133, RSS-Gen	
2.1046/ 6.4 RF power output, conducted	Yes
2.1051/ 6.2 Spurious emission at antenna terminals	Yes
2.1053/ 6.5 Field strength of spurious radiation	Yes

Description of the test object

Equipment:	Radio equipment Radio 4415 B2 B25 Product number KRC 161 636/1 FCC ID: TA8AKRC161636 IC: 287AB-AS161636
HVIN:	AS161636
Hardware revision state:	R1B
Tested configuration:	Multi RAT WCDMA + GSM
Frequency range:	TX: 1930 – 1990 MHz RX: 1850 – 1910 MHz
IBW:	40 MHz
Output power:	Max 40 W/ antenna port
Antenna ports:	4 TX / 4 RX ports
Antenna:	No dedicated antenna, handled during licensing
RF configurations:	WCDMA: 1-5 carriers/ port (max 11 carriers/ unit) GSM: 1-4 carriers/ port (max 10 carriers/ unit) Max 6 carriers/ port WCDMA: TX Diversity, 2x(2x2) MIMO GSM: Single antenna, dual TX Contiguous Spectrum (CS), Non-Contiguous Spectrum (NCS)
Channel bandwidths:	WCDMA: 4.2 MHz and 5 MHz GSM: 200 kHz
Modulations:	WCDMA: QPSK, 16QAM and 64QAM GSM: GMSK, AQPSK and 8PSK
RF power Tolerance:	+0.6/ -2.5 dB
CPRI Speed	Up to 10.1 Gbit/s
Nominal supply voltage:	-48VDC

The information above is supplied by the manufacturer.

Purpose of test

The purpose of the tests is to verify compliance to the performance characteristics specified in applicable items of FCC CFR 47 Industry Canada RSS-133 and RSS-Gen.

Operation modes during measurements

WCDMA measurements were performed with the test object transmitting the Test model 1 which are defined in 3GPP TS 25.141. Test model 1 (TM1) represent QPSK modulation. Test model 5 (TM5) includes the 16QAM modulation and Test model 6 (TM6) includes the 64QAM modulation.

GSM measurements were performed with the test object transmitting following modulations: GMSK, AQPSK, 8-PSK.

Unless otherwise stated, all measurements were performed with the test object transmitting pseudorandom data in all timeslots and settings for maximum transmitter output power applicable for each configuration.

The measured configurations covers worst case settings.

Conducted measurements

The test object was supplied with -48 VDC by an external power supply. Additional connections are documented in the set-up drawings for conducted measurements.

Radiated measurements

The test object was powered with -48 VDC by an external power supply. Additional connections are documented in the set-up drawings for radiated measurements.

References

Measurements were done according to relevant parts of the following standards:

ANSI C63.4-2014

CFR 47 part 2, April 2017

CFR 47 part 24, April 2017

ANSI C63.26-2015

KDB 662911 D01 Multiple Transmitter Output v02r02

KDB 971168 D01 Power Meas License Digital Systems v02r02

KDB 971168 D03 IM Emission Repeater Amp v01

3GPP TS 25 141 version 13.6.0

3GPP TS 37.141, version 13.5.0

RSS-Gen Issue 4

RSS-133 Issue 6

Measurement equipment

	Calibration Due	RISE number
Test site Tesla	2019-12	503 881
R&S ESU 40	2018-07	901 385
R&S FSQ 40	2018-07	504 143
R&S FSW 43	2018-08	902 073
Control computer with R&S software EMC32 version 10.20.01	-	BX62351
High pass filter 3-26.5 GHz	2017-12	BX40074
High pass filter 3-26.5 GHz	2018-06	901 502
RF attenuator Weinschel WA73-20-11	2018-05	900 691
Coaxial cable Sucoflex 102EA	2018-05	BX50191
Coaxial cable Sucoflex 102EA	2018-05	BX50236
ETS Lindgren BiConiLog Antenna 3142E	2019-03	BX61914
EMCO Horn Antenna 3115	2019-12	502 175
µComp Nordic, Low Noise Amplifier	2017-12	901 545
Temperature and humidity meter, Testo 635	2018-06	504 203
Temperature and humidity meter, Testo 625	2018-06	504 188

Uncertainties

Measurement and test instrument uncertainties are described in the quality assurance documentation "SP-QD 10885". The uncertainties are calculated with a coverage factor $k=2$ (95% level of confidence).

Compliance evaluation is based on a shared risk principle with respect to the measurement uncertainty.

Reservation

The test results in this report apply only to the particular test object as declared in the report.

Delivery of test object

The test object was delivered: 2017-09-07.

Manufacturer's representative

Mikael Jansson, Ericsson AB.

Test engineers

Tomas Isbring for radiated tests, RISE

Tomas Lennhager and Andreas Johnson for conducted tests, RISE.

Test participant(-s)

None.

Test frequencies used for radiated and conducted measurements

TX test frequencies, conducted measurements:

Symbolic name: 2G1W

	Frequency [MHz]	Bandwidth [MHz]	Test model
GSM	1930.4	0.2	GMSK
GSM	1931.0	0.2	GMSK
WCDMA	1967.4	5.0	TM5

Symbolic name: 3G3W-L

	Frequency [MHz]	Bandwidth [MHz]	Test model
GSM	1930.4	0.2	GMSK
WCDMA	1932.8	5.0	TM5
GSM	1947.8	0.2	GMSK
WCDMA	1950.2	5.0	TM5
GSM	1965.0	0.2	GMSK
WCDMA	1967.4	5.0	TM5

Symbolic name: 3G3W-H

	Frequency [MHz]	Bandwidth [MHz]	Test model
GSM	1950.6	0.2	GMSK
WCDMA	1953.0	5.0	TM5
GSM	1968.0	0.2	GMSK
WCDMA	1970.4	5.0	TM5
GSM	1985.2	0.2	GMSK
WCDMA	1987.6	5.0	TM5

TX test frequencies, radiated measurements:

Symbolic name: 1W2G:

	Frequency [MHz]	Bandwidth [MHz]	Test model
WCDMA	1972.4	5	TM5
GSM	1989.4	0.2	GMSK
GSM	1989.6	0.2	GMSK

According to FCC KDB 971168 D03

All RX frequencies were configured 80 MHz below the corresponding TX frequency according the applicable duplex offset for the operating band.

Test setup: conducted measurements

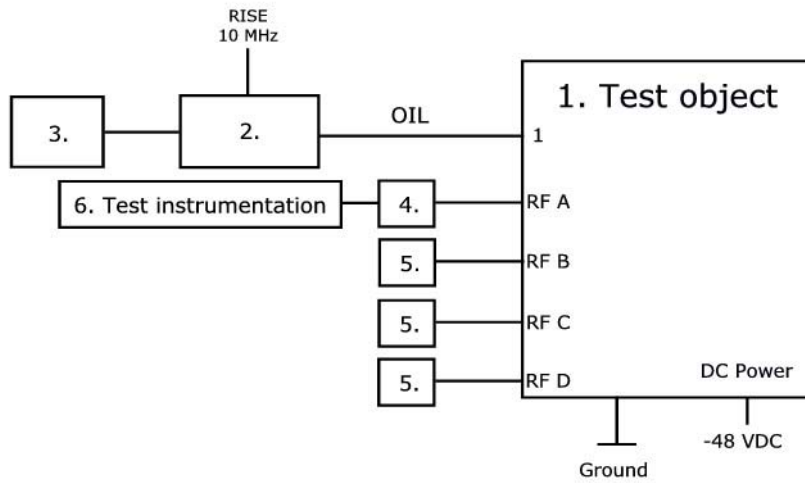

Test object:

1.	Radio 4415 B2 B25, KRC 161 636/1, rev. R1B, s/n: D16W963153 With Radio Software: CXP 901 7316/7, rev. R67HA. FCC ID: TA8AKRC161636 and IC: 287AB-AS161636
----	--

Associated equipment:

2.	Testing Equipment: CT10, LPC 102 467/1, rev. R1C, s/n: T01F375047, BAMS – 1001466801 with software CXA 104 446/1, rev. R8AA
----	---

Functional test equipment:

3.	Computer, HP EliteBook 8560w, BAMS - 1001236851
4.	RF Attenuator: RISE number: 900 691
5.	Terminator, 50 ohm
6.	RISE Test Instrumentation according to measurement equipment list for each test. The signal analyzer was connected to the RISE 10 MHz reference standard during all measurements.

Test setup: radiated measurements

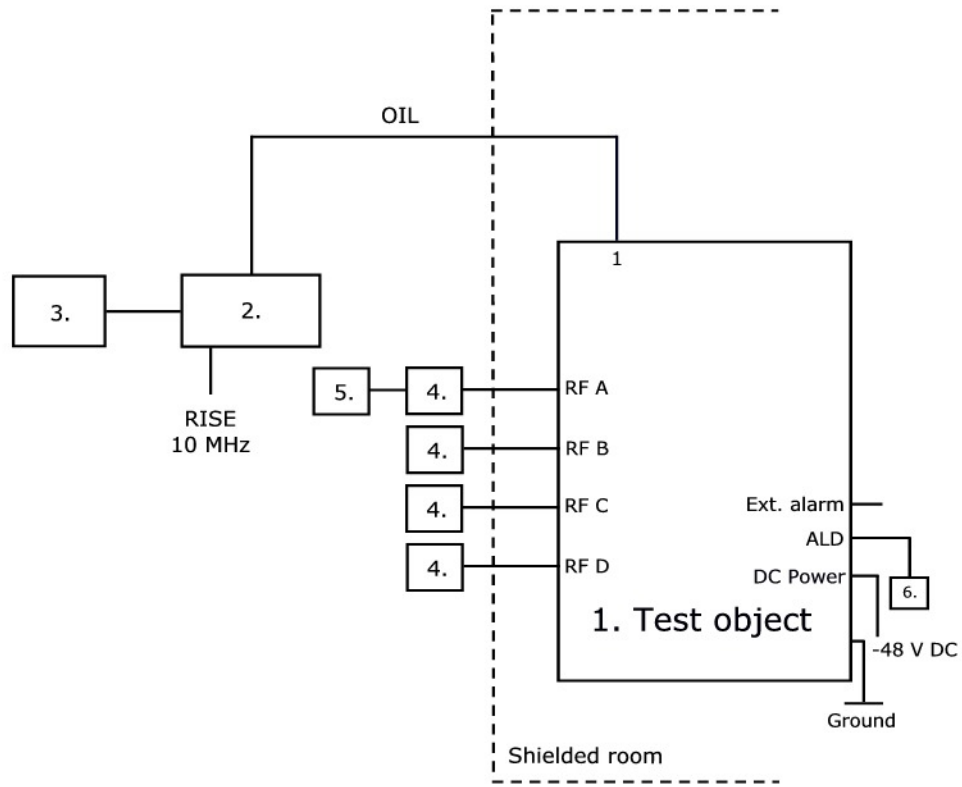

1.	Radio 4415 B2 B25, KRC 161 636/1, rev. R1B, s/n: D16W963156 With Radio Software: CXP 901 7316/7, rev. R67HA. FCC ID: TA8AKRC161636 and IC: 287AB-AS161636
----	--

Associated equipment:

2.	Testing Equipment: CT10, LPC 102 467/1, rev. R1C, s/n: T01F375046, BAMS – 1001466800 with software CXA 104 446/1, rev. R8AA
----	---

Functional test equipment:

3.	Computer, HP EliteBook 8560w, BAMS - 1001236854
4.	Attenuator
5.	R&S ESIB 26, RISE no: 503 292, for supervision purpose only
6.	ALD Control, Andrew, model: ATM200-A20, s/n: DESA101412073

Interfaces:

Power input configuration DC: -48 VDC	Power
RF A, 4.3-10 connector, combined TX/RX	Antenna
RF B, 4.3-10 connector, combined TX/RX	Antenna
RF C, 4.3-10 connector, combined TX/RX	Antenna
RF D, 4.3-10 connector, combined TX/RX	Antenna
1, Optical Interface Link, single mode opto fibre	Signal
2, Optical Interface Link, not used in this configuration	Signal
EXT Alarm, shielded multi-wire	Signal
ALD, shielded multi-wire	Signal
Ground wire	Ground

RF power output measurements according to CFR 47 §24.232 / IC RSS-133 6.4, conducted

Date 2017-10-15	Temperature 23 °C ± 3 °C	Humidity 36 % ± 5 %
--------------------	-----------------------------	------------------------

Test set-up and procedure

The test object was connected to a signal analyser measuring peak and RMS output power in CDF mode. A resolution bandwidth of 80 MHz was used.

Measurement equipment	RISE number
R&S FSW 43	902 073
RF attenuator	900 691
Testo 635, temperature and humidity meter	504 203

Measurement uncertainty: 1.1 dB

Results

Rated output power at RF connector 46 dBm/ port.

Symbolic name	Output power CCDF [RMS dBm/ PAR dB]				
	Port RF A	Port RF B	Port RF C	Port RF D	Total power ¹⁾
2G1W	44.80/ 6.60	44.96/ 6.58	44.93/ 6.58	44.92/ 6.58	50.92
3G3W-L	45.52/ 7.54	45.64/ 7.54	45.50/ 7.54	45.49/ 7.56	51.56

¹⁾: summed output power according to FCC KDB662911 Multiple transmitter output.
Note: The PAR value is the 0.1 % Peak to Average Ratio.

Remark

ERP/EIRP compliance is addressed at the time of licensing, as required by the responsible FCC/IC Bureau(s). Licensee's are required to take into account maximum antenna gain used in combination with above power settings to prevent the radiated output power to exceed the limits.

Limits

§24.232 The maximum output power may not exceed 3280 W/MHz (EIRP).
The Peak to Average Ratio (PAR) may not exceed 13 dB.

RSS-133 Base station transmitters operating in the band 1930-1990 MHz shall not have output power exceeding 100 watts. When the transmitter power is measured in terms of average value, the peak-to-average ratio(PAR) of the power shall not exceed 13 dB

There is no EIRP limit specified for base station equipment in the RSS-133.

EIRP compliance is addressed at the time of licensing, as required by the responsible IC Bureau. Licensee's are required to take into account the antenna gain to get the maximum usable power settings to prevent the radiated output power to exceed the EIRP limits specified in SRSP-510

Complies?	Yes
-----------	-----

Conducted spurious emission measurements according to CFR 47 §24.238 / IC RSS-133 6.2

Date 2017-10-15	Temperature 23 °C ± 3 °C	Humidity 36 % ± 5 %
--------------------	-----------------------------	------------------------

Test set-up and procedure

The measurements were made per definition in §24.238. The output was connected to a spectrum analyzer with a RBW setting of 1 MHz and RMS detector activated. The spectrum analyzer was connected to an external 10 MHz reference standard during the measurements.

Before comparing the results to the limit, 6 dB [10 log (4)] to cover 2x(2x2) MIMO, should be added according to method c “measure and add 10 log(N_{ANT})” of FCC KDB662911 D01 Multiple Transmitter Output.

Measurement equipment	RISE number
R&S FSW 43	902 073
RF attenuator	900 691
HP filter	BX40074
Testo 635, temperature and humidity meter	504 203

Measurement uncertainty: 3.7 dB

Results

Diagram	Symbolic name	Tested Port
1 a-b-c	2G1W	RF B
2 a-b-c	3G3W-L	RF B
3 a-b-c	3G3W-H	RF B

Note: Measurements were mainly limited to port RF B due to electrical identical ports as declared by the client.

Remark

The emission at 9 kHz on the plots was not generated by the test object. A complementary measurement with a smaller RBW showed that it was related to the LO feed-through.

The highest fundamental frequency is 1990 MHz. The measurements were made up to 20 GHz (10x1990 MHz = 19900 MHz).

Limits

CFR 47 §24.238 and RSS-133 6.5

Outside a licensee's frequency band(s) of operation the power of any emission shall be attenuated below the transmitter power (P) by at least 43 + 10 log (P) dB, resulting in a limit of -13 dBm per 1 MHz RBW.

Complies?	Yes
-----------	-----

Diagram 1a:

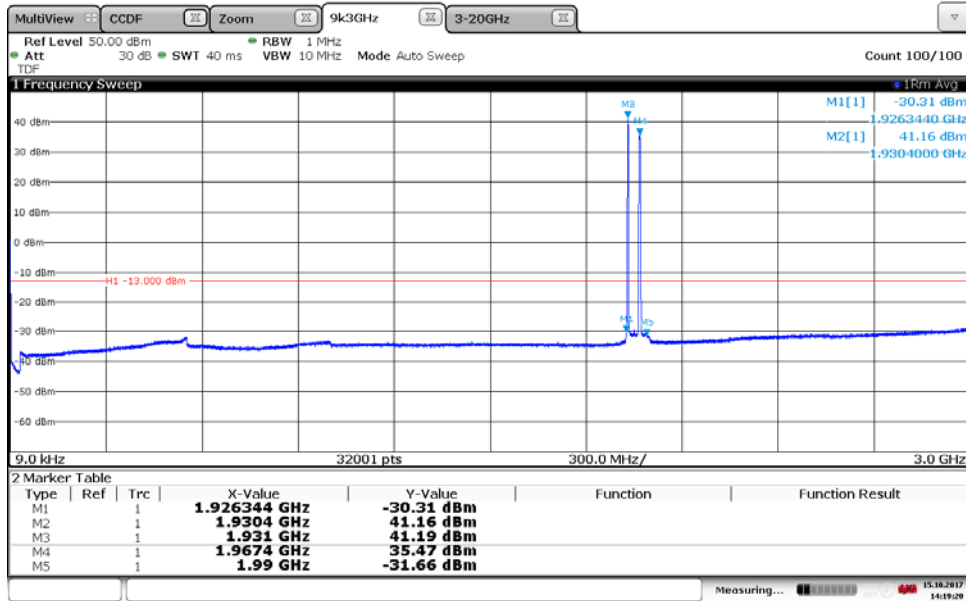

14:19:20 15.10.2017

Diagram 1b:

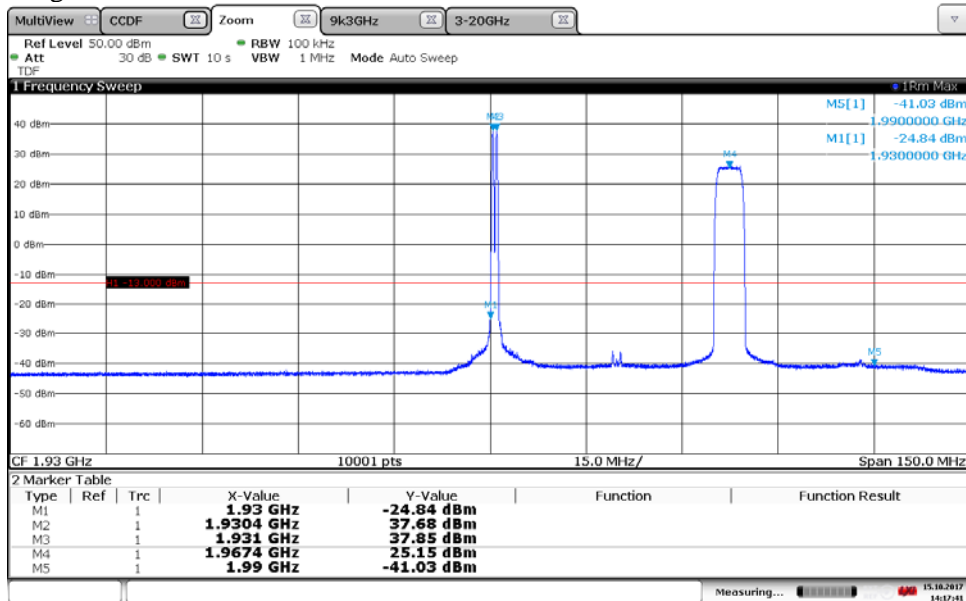

14:17:41 15.10.2017

Note: Due to the use of reduced measurement bandwidth the limit should be adjusted by 10 dB to -23 dBm.

Diagram 1 c:

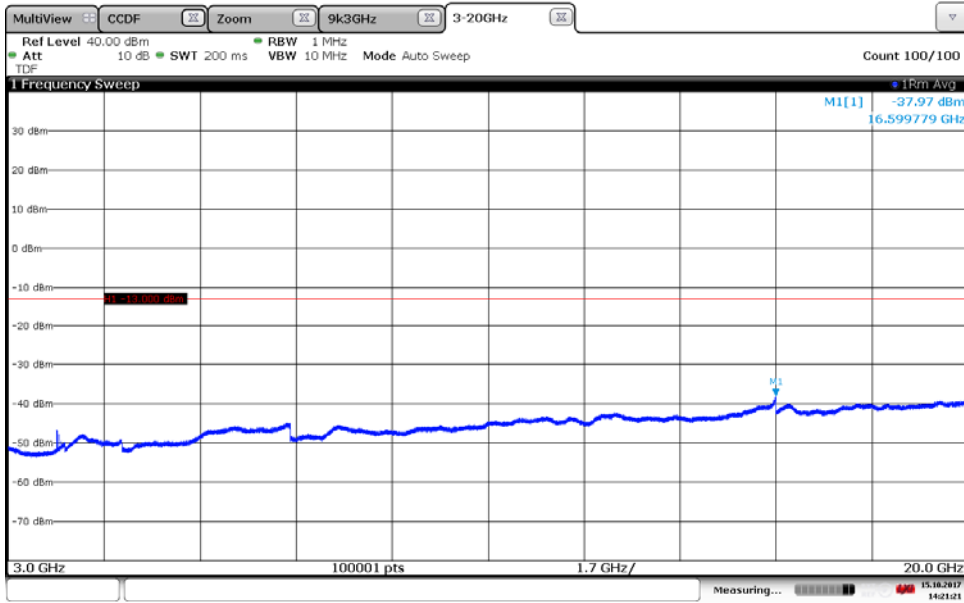

14:21:21 15.10.2017

Diagram 2a:

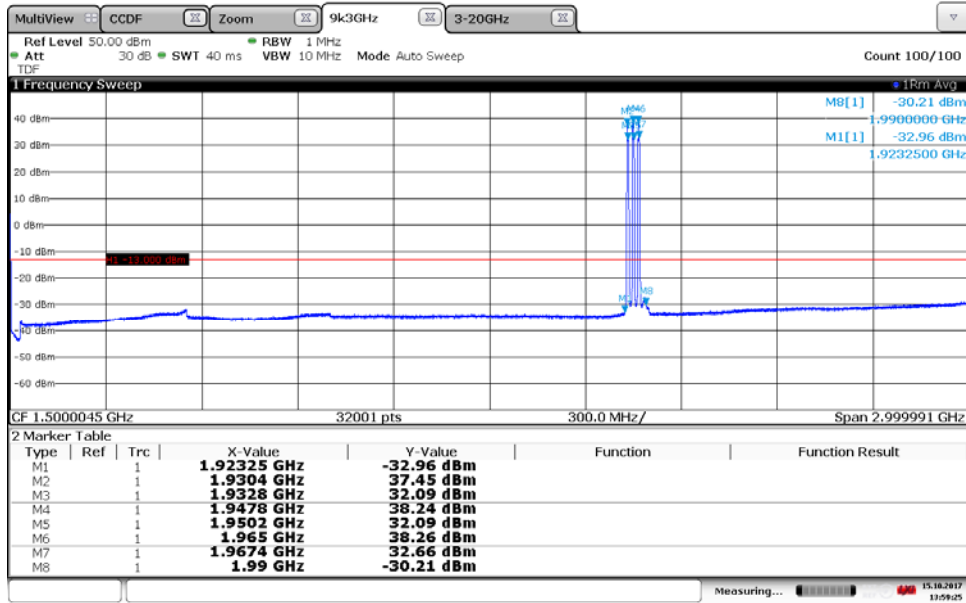

13:59:25 15.10.2017

Diagram 2b:

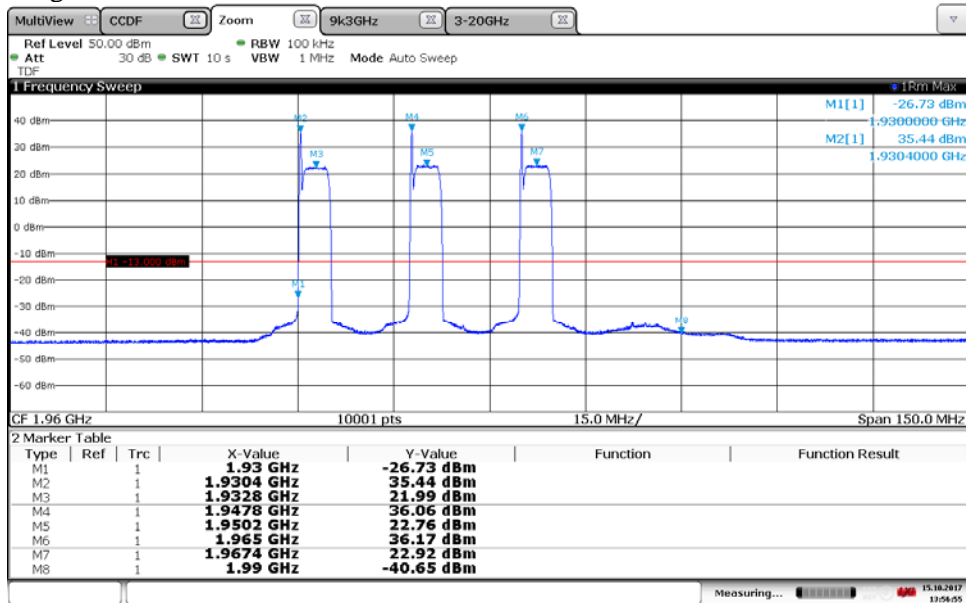

13:56:56 15.10.2017

Note: Due to the use of reduced measurement bandwidth the limit should be adjusted by 10 dB to -23 dBm.

Diagram 2 c:

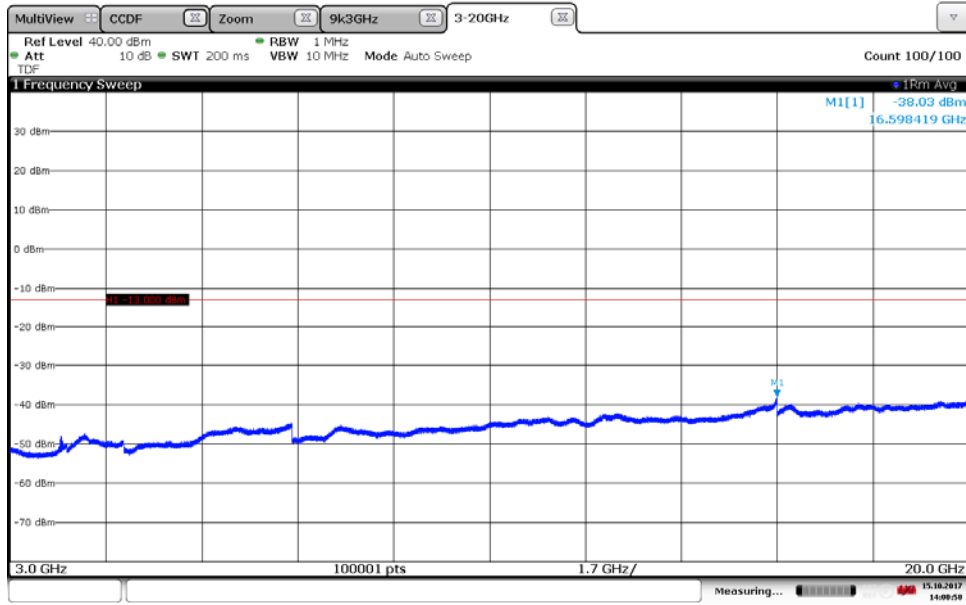

14:00:59 15.10.2017

Diagram 3a:

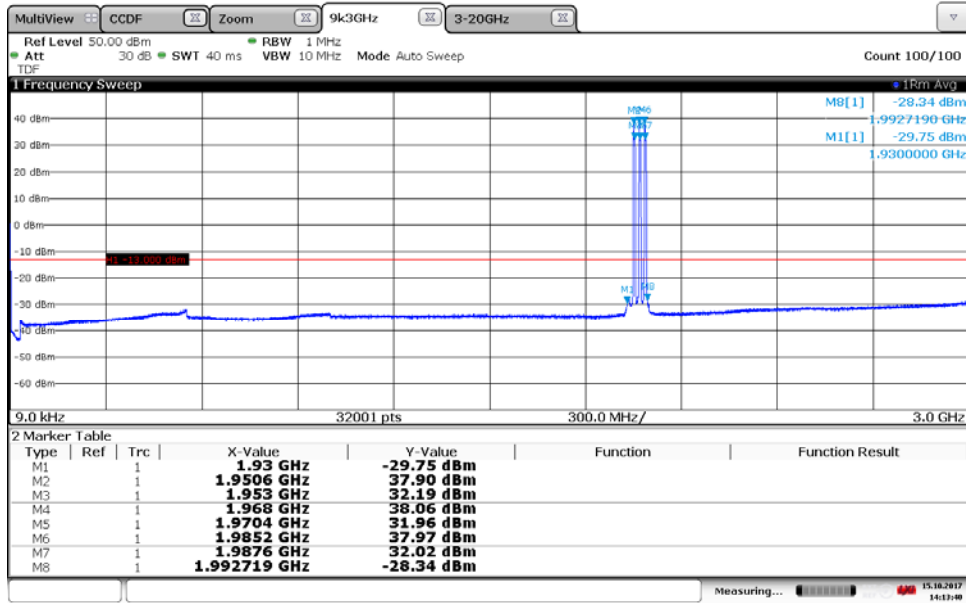

14:13:41 15.10.2017

Diagram 3b:

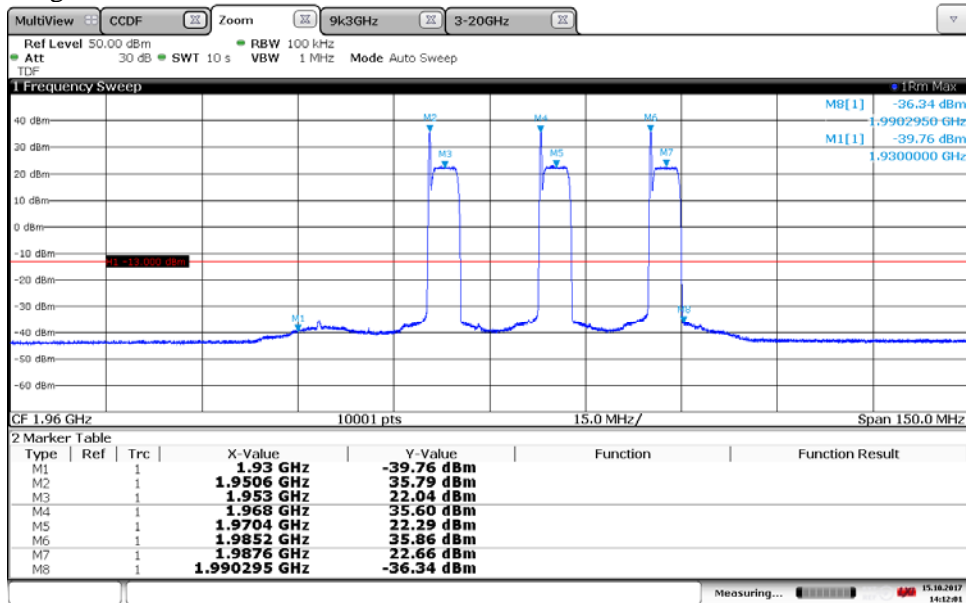

14:12:02 15.10.2017

Note: Due to the use of reduced measurement bandwidth the limit should be adjusted by 10 dB to -23 dBm.

Diagram 3 c:

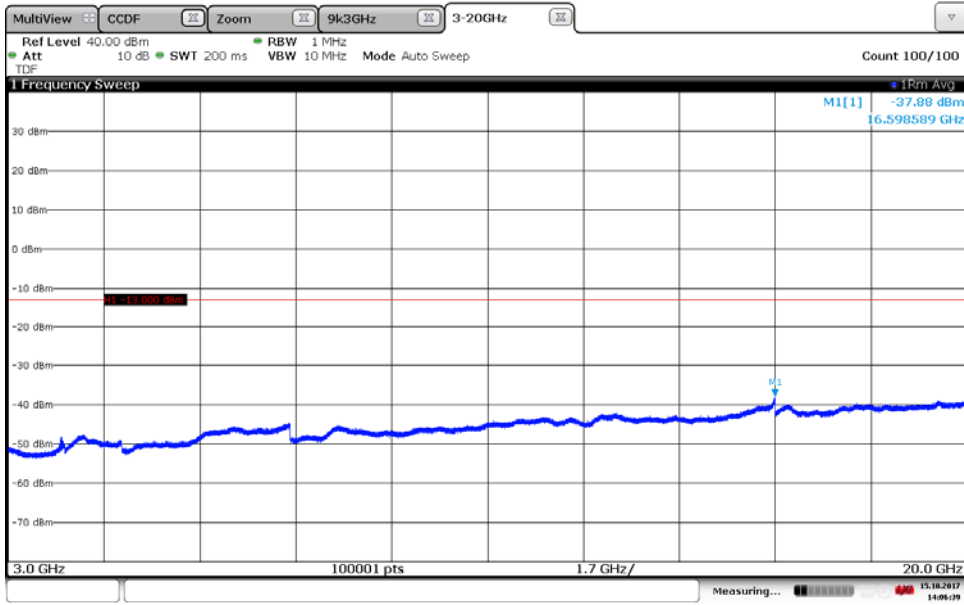

14:06:39 15.10.2017

Field strength of spurious radiation measurements according to CFR 47 §2.1053 / IC RSS-133 6.5

Date	Temperature	Humidity
2017-09-14	22 °C ± 3 °C	45 % ± 5 %
2017-10-04	23 °C ± 3 °C	38 % ± 5 %
2017-10-05	22 °C ± 3 °C	34 % ± 5 %

The test site conform to the site validation criterion specified in ANSI C63.4 2014. The test site complies with RSS-Gen, Industry Canada file no. 3482A-1.

The measurements were performed with both horizontal and vertical polarization of the antenna. The antenna distance was 3 m in the frequency range 30 MHz – 18 GHz and 1 m in the frequency range 18 GHz – 20 GHz.

RF absorbers were covering a floor area in the frequency range 1 GHz – 18 GHz to comply with site validation requirements according to ANSI C63.4-2014.

The EUT was placed 0.8 m above reference ground plane in frequency range 30 MHz – 1 GHz and 1.5 m above reference ground plane in frequency range 1 GHz – 20 GHz.

The measurement was performed with a RBW of 1 MHz.

A propagation loss in free space was calculated. The used formula was

$$\gamma = 20 \log \left(\frac{4\pi D}{\lambda} \right), \gamma \text{ is the propagation loss and } D \text{ is the antenna distance.}$$

The measurement procedure was as the following:

1. A pre-measurement is performed with peak detector. For measurement < 1 GHz the test object was measured in eight directions with the antenna at three heights, 1.0 m, 1.5 m and 2.0 m. For measurements > 1 GHz the test object was measured in seventeen directions with the antenna height 1.0 m, 1.5 m and 2m.
2. Spurious radiation on frequencies closer than 20 dB to the limit in the pre-measurement is scanned 0-360 degrees and the antenna is scanned 1- 4 m for maximum response. The emission is then measured with the RMS detector and the RMS value is reported. Frequencies closer than 10 dB to the limit when measured with the RMS detector were measured with the substitution method according to ANSI 63.26.

The test set-up during the spurious radiation measurements is shown in the picture below:
30-1000 MHz

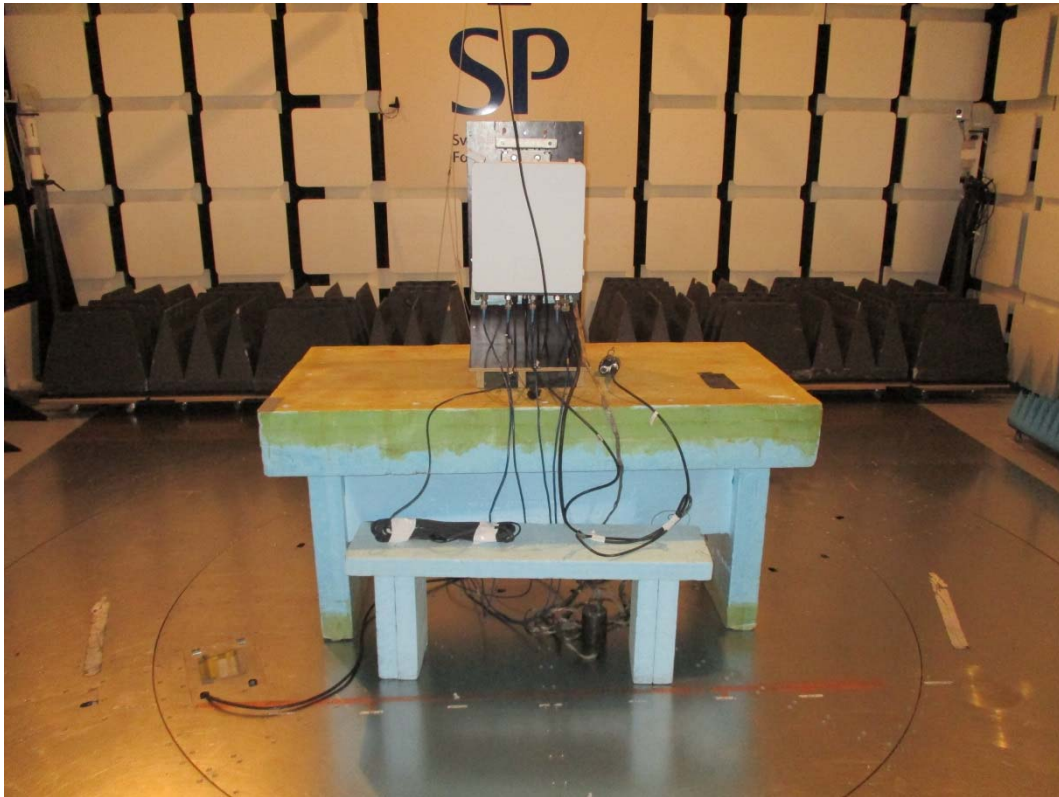

1-18GHz

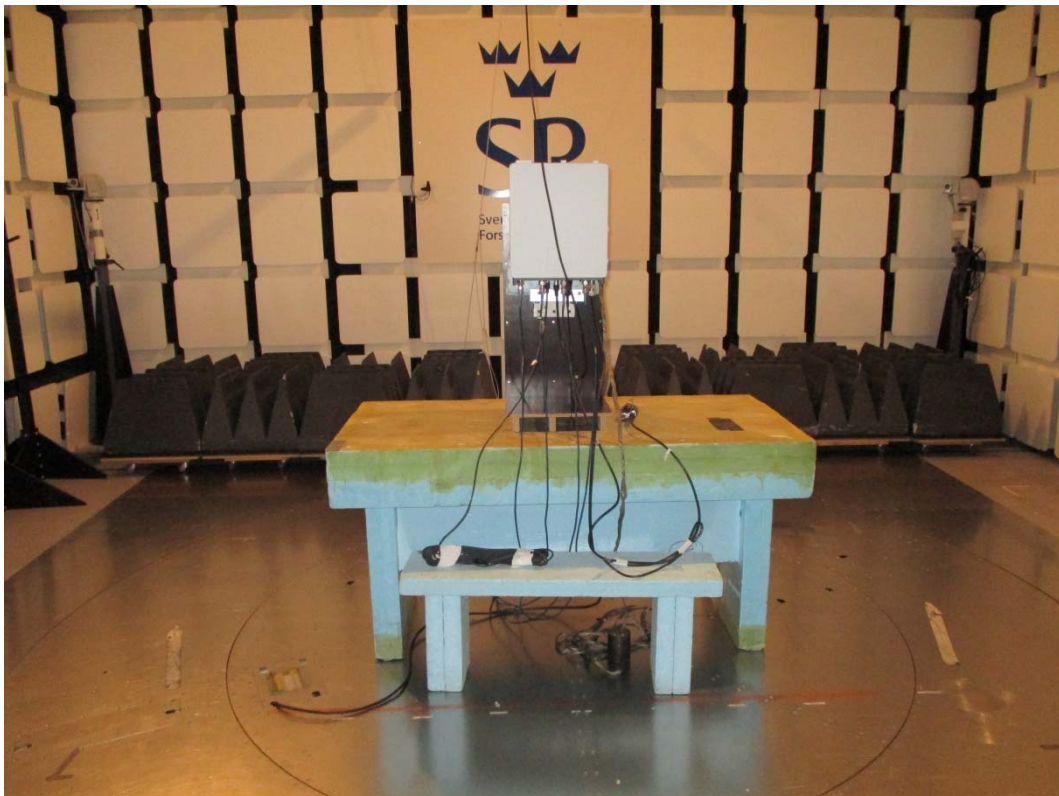

Measurement equipment

Measurement equipment	RISE number
Semi anechoic chamber Tesla	503 881
R&S ESU 40	901 385
EMC 32 ver. 10.20.01	BX62351
ETS Lindgren BiConiLog 3142E	BX61914
ETS Lindgren Horn Antenna 3115	502 175
Flann STD Gain Horn Antenna 20240-20	503 674
µComp Nordic, Low Noise Amplifier	901 545
Miteq, Low Noise Amplifier	503 278
HP Filter 3-26.5 GHz	901 502
Temperature and humidity meter, Testo 625	504 188

Results

Tested configurations: 1W2G

representing worst case: Symbolic name 1W2G, Diagram 1 a-d

Frequency (MHz)	Spurious emission level (dBm)	
	Vertical	Horizontal
30-20000	All emission > 20 dB below limit	All emission > 20 dB below limit

Measurement uncertainty: 3.1 dB

Limits

CFR 47 §24.238 and IC RSS-133 6.5

(g) Outside a licensee's frequency band(s) of operation the power of any emission shall be attenuated below the transmitter power (P) by at least $43 + 10 \log (P)$ dB, resulting in a limit of -13 dBm.

Complies?	Yes
-----------	-----

Diagram 1a:

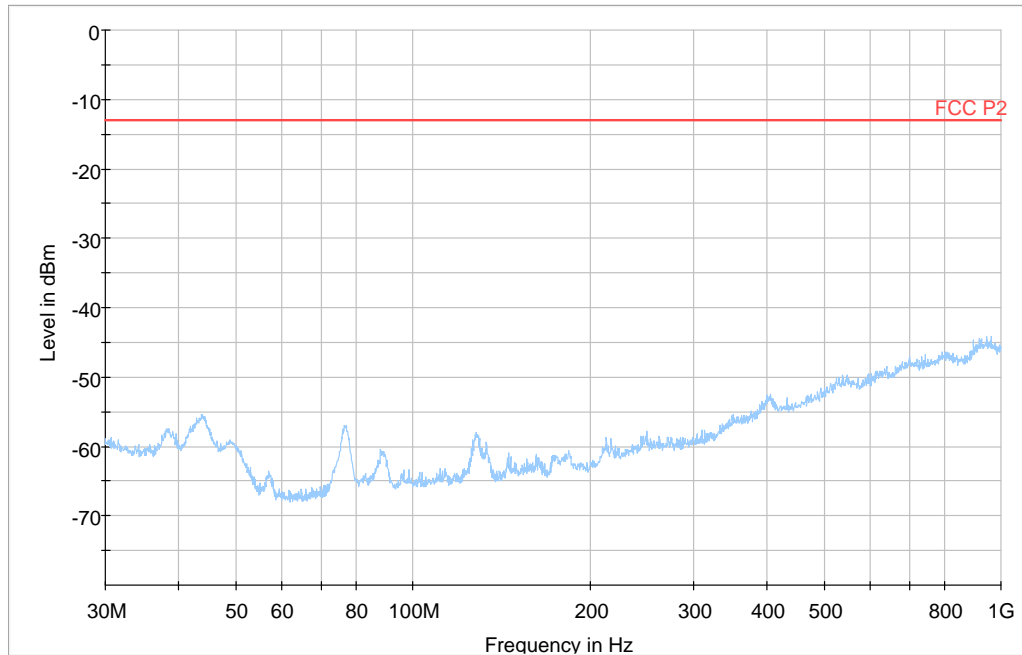
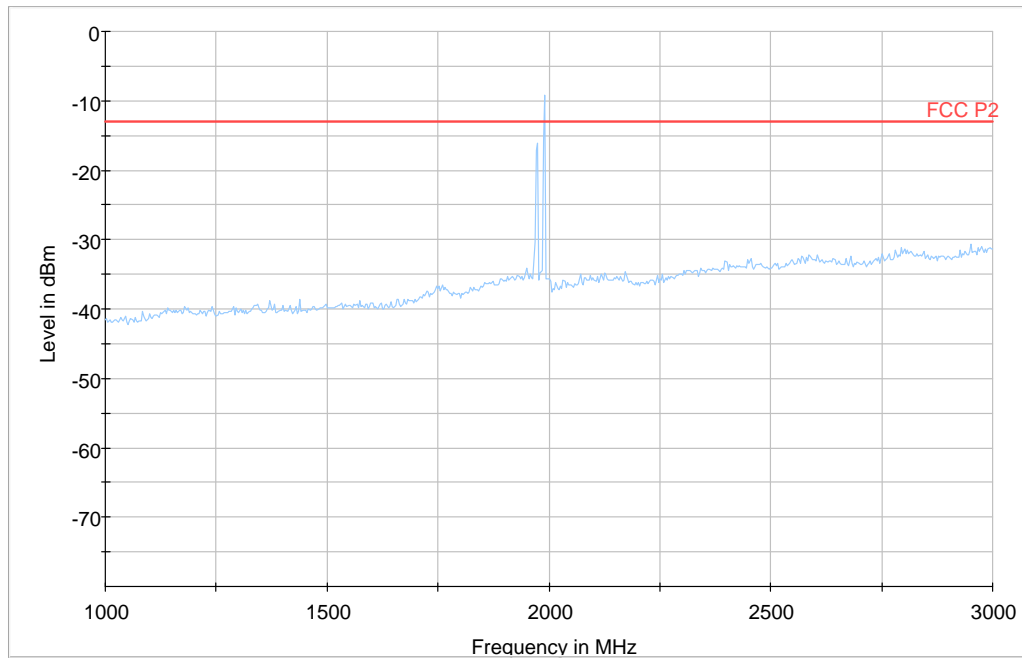

Diagram 1b:



Note: The emission between 1970 - 1990 MHz are the carrier frequencies and shall be ignored in the context.

Diagram 1c:

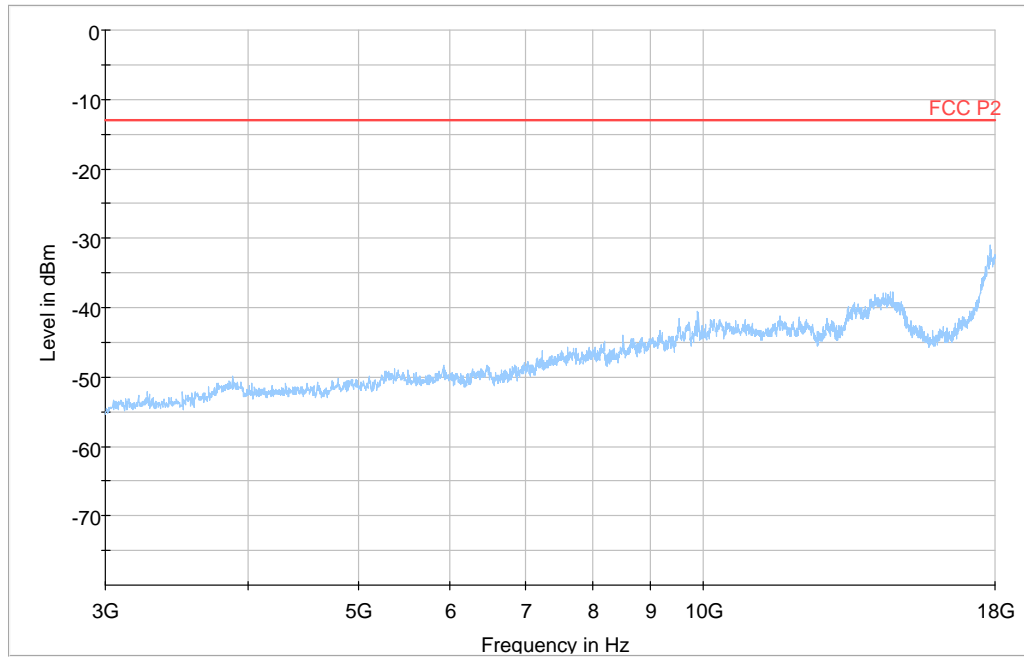
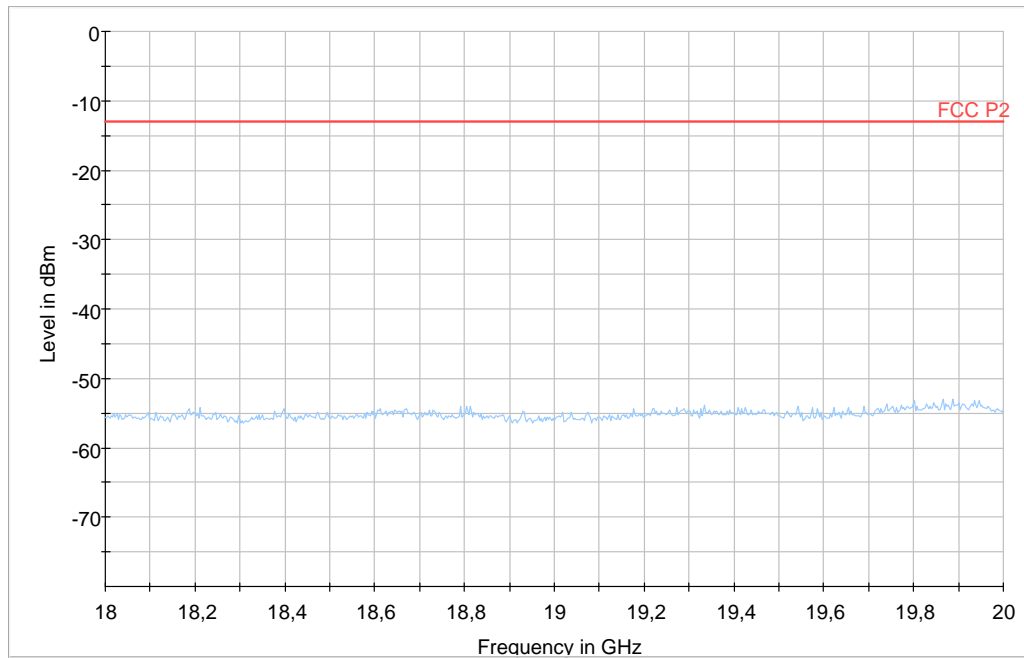

Diagram 1d:



Photos of test object

Front side



Rear side



Left side



Right side

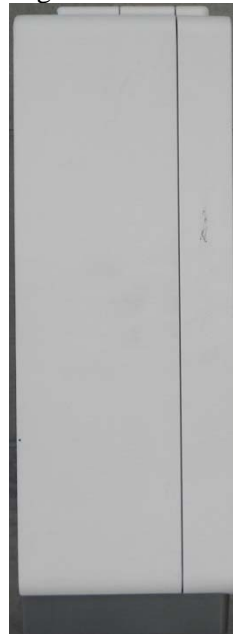

Bottom side



Top side



