

Ericsson AB
Anders Karlsson
BURA DURA RP QRM
Torshamnsgatan 21
164 80 Stockholm

Radio measurements on Radio 4415 B2 B25 equipment with FCC ID TA8AKRC161636 and IC: 287AB-AS161636

Product name: Radio 4415 B2 B25
Product number: KRC 161 636/1 and KRC 161 636/3

RISE Research Institutes of Sweden AB Electronics - EMC

Performed by

Examined by

Tomas Lennhager

Monika Fuller

RISE Research Institutes of Sweden AB

Postal address	Office location	Phone / Fax / E-mail
Box 857	Brinellgatan 4	+46 10 516 50 00
SE-501 15 BORÅS	SE-504 62 BORÅS	+46 33 13 55 02
Sweden		info@ri.se

This report may not be reproduced other than in full, except
with the prior written approval of the issuing laboratory.

Summary	4
Description of the test object	5
Purpose of test.....	6
Operation modes during measurements	6
Conducted measurements	6
Radiated measurements.....	6
References.....	6
Measurement equipment	7
Uncertainties	7
Reservation	7
Delivery of test object.....	7
Manufacturer’s representative.....	7
Test engineers	7
Test participant(-s).....	7
Test frequencies used for radiated and conducted measurements.....	8
Test setup: conducted measurements.....	9
Test setup: radiated measurements.....	10
RF power output measurements according to CFR 47 §24.232 / IC RSS-133 6.4, conducted	12
Results.....	12
Remark.....	14
Limits	14
Occupied bandwidth measurements according to CFR47 2.1049 / RSS-Gen 4.6.1	15
Test set-up and procedure	15
Results.....	15
Band edge measurements according to CFR 47 §2.4.238 / IC RSS-133 6.6	20
Test set-up and procedure	20
Results.....	21
Limits	21
Conducted spurious emission measurements according to CFR 47 §24.238 / IC RSS-133 6.2	36
Test set-up and procedure	36
Results.....	36
Remark.....	37
Limits	37
Field strength of spurious radiation measurements according to CFR 47 §2.1053 / IC RSS-133	54
6.5.....	54
Measurement equipment.....	56
Results.....	56
Limits	56

Frequency stability measurements according to CFR 47 § 24.235 / IC RSS 133 6.3.....	60
Test set-up and procedure	60
Results	61
Remark	62
Limits	62
Photos of test object	63

Summary

Standard Listed part of	Compliant
FCC CFR 47 part 24/ RSS 133, RSS-Gen	
2.1046/ 6.4 RF power output, conducted	Yes
2.1049/ 4.6.1 Occupied bandwidth	Yes
2.1051/ 6.6 Band edge	Yes
2.1051/ 6.2 Spurious emission at antenna terminals	Yes
2.1053/ 6.5 Field strength of spurious radiation	Yes
2.1055/ 6.3 Frequency stability	Yes

Description of the test object

Equipment:	Radio equipment Radio 4415 B2 B25 Product number KRC 161 636/1 and KRC 161 636/3 FCC ID: TA8AKRC161636 IC: 287AB-AS161636
HVIN:	AS161636
Hardware revision state:	R1B
Tested configuration:	WCDMA single RAT
Frequency range:	TX: 1930 – 1995 MHz RX: 1850 – 1915 MHz
IBW:	65 MHz
Output power:	Max 40 W/ antenna port
Antenna ports:	4 TX/RX ports
Antenna:	No dedicated antenna, handled during licensing
RF configuration:	Single and multi-carrier, 1-6 carriers/ port TX Diversity, 2x(2x2) MIMO, , Contiguous Spectrum (CS), Non- Contiguous Spectrum (NCS)
Modulations:	QPSK, 16QAM and 64QAM
Channel bandwidths:	4.2 to 5 MHz (configurable in steps of 100/200 kHz)
Channel spacing:	4.4 to 5 MHz (configurable in steps of 100/200 kHz)
RF power Tolerance:	+0.6/ -2.5 dB
CPRI Speed	Up to 10.1 Gbit/s
Nominal supply voltage:	-48VDC

The information above is supplied by the manufacturer.

Note: KRC 161 636/1 and KRC 161 636/3 are electrically identical according to the manufacturer.

Purpose of test

The purpose of the tests is to verify compliance to the performance characteristics specified in applicable items of FCC CFR 47 part 24 Industry Canada RSS-133 and RSS-Gen.

Operation modes during measurements

Measurements were performed with the test object transmitting the Test model 1 which are defined in 3GPP TS 25.141. Test model 1 (TM1) represent QPSK modulation. Test model 5 (TM5) includes the 16QAM modulation and Test model 6 (TM6) includes the 64QAM modulation.

All measurements were performed with the test object configured for maximum transmit power. The measured configurations covers worst case settings.

Conducted measurements

The test object was supplied with -48 VDC by an external power supply. Additional connections are documented in the set-up drawings for conducted measurements.

Radiated measurements

The test object was powered with -48 VDC by an external power supply. Additional connections are documented in the set-up drawings for radiated measurements.

References

Measurements were done according to relevant parts of the following standards:

ANSI C63.4-2014

CFR 47 part 2, April 2017

CFR 47 part 24, April 2017

ANSI C63.26-2015

KDB 662911 D01 Multiple Transmitter Output v02r02

KDB 971168 D01 Power Meas License Digital Systems v02r02

KDB 971168 D03 IM Emission Repeater Amp v01

3GPP TS 37.141, version 13.5.0

3GPP TS 25.141, version 13.4.0

RSS-Gen Issue 4

RSS-133 Issue 6

Measurement equipment

	Calibration Due	RISE number
Test site Tesla	2019-12	503 881
R&S ESU 40	2018-07	901 385
R&S FSQ 40	2018-07	504 143
R&S FSW 43	2018-08	902 073
Control computer with R&S software EMC32 version 10.20.01	-	BX62351
High pass filter 3-26.5 GHz	2017-12	BX40074
High pass filter 3-26.5 GHz	2018-06	901 502
RF attenuator Weinschel WA73-20-11	2018-05	900 691
Coaxial cable Sucoflex 102EA	2018-05	BX50191
Coaxial cable Sucoflex 102EA	2018-05	BX50236
ETS Lindgren BiConiLog Antenna 3142E	2019-03	BX61914
EMCO Horn Antenna 3115	2019-12	502 175
µComp Nordic, Low Noise Amplifier	2017-12	901 545
Temperature and humidity meter, Testo 635	2018-06	504 203
Temperature and humidity meter, Testo 625	2018-06	504 188

Uncertainties

Measurement and test instrument uncertainties are described in the quality assurance documentation "SP-QD 10885". The uncertainties are calculated with a coverage factor $k=2$ (95% level of confidence).

Compliance evaluation is based on a shared risk principle with respect to the measurement uncertainty.

Reservation

The test results in this report apply only to the particular test object as declared in the report.

Delivery of test object

The test object was delivered: 2017-09-07.

Manufacturer's representative

Mikael Jansson, Ericsson AB.

Test engineers

Tomas Isbring for radiated tests, RISE

Tomas Lennhager and Andreas Johnson for conducted tests, RISE.

Test participant(-s)

None.

Test frequencies used for radiated and conducted measurements

UARFCN Downlink B25	Frequency [MHz]	Symbolic name	Comment
5112	1932.4	B	Single carrier TX bottom frequency
5263	1962.6	M	Single carrier TX band mid frequency
5250 5275	1960.0 1965.0	M2	2-carriers TX band mid constellation
5200 5225 5250 5275 5300 5325	1950.0 1955.0 1960.0 1965.0 1970.0 1975.0	M6	6-carriers TX band mid constellation
5413	1992.6	T	Single carrier TX band top frequency
5112 5137 5413	1932.4 1937.4 1992.6	Bim	3-carriers TX constellation
5112 5388 5413	1932.4 1987.6 1992.6	Tim	3-carriers TX constellation

All RX frequencies were configured 80 MHz below the corresponding TX frequency according to the applicable duplex offset for the operating band.

Test setup: conducted measurements

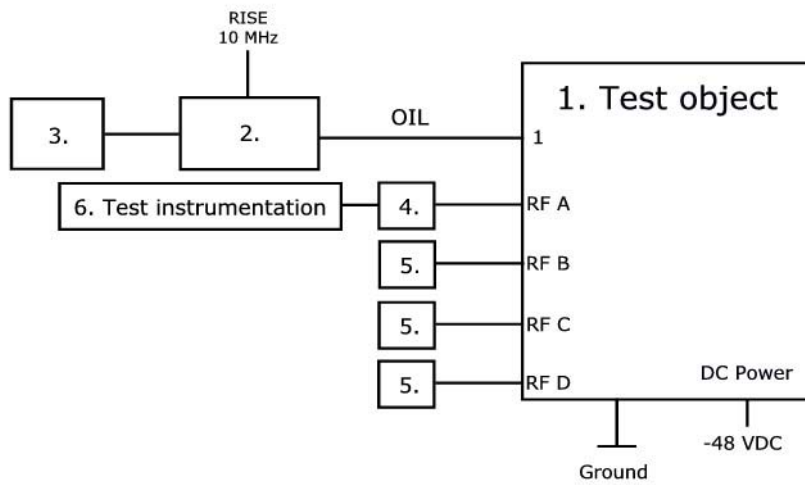

Test object:

1.	Radio 4415 B2 B25, KRC 161 636/1, rev. R1B, s/n: D16W963153 With Radio Software: CXP 901 7316/7, rev. R67HA. FCC ID: TA8AKRC161636 and IC: 287AB-AS161636
----	--

Associated equipment:

2.	Testing Equipment: CT10, LPC 102 467/1, rev. R1C, s/n: T01F375047, BAMS – 1001466801 with software CXA 104 446/1, rev. R8AA
----	---

Functional test equipment:

3.	Computer, HP EliteBook 8560w, BAMS - 1001236851
4.	RF Attenuator: RISE number: 900 691
5.	Terminator, 50 ohm
6.	RISE Test Instrumentation according to measurement equipment list for each test. The signal analyzer was connected to the RISE 10 MHz reference standard during all measurements.

Test setup: radiated measurements

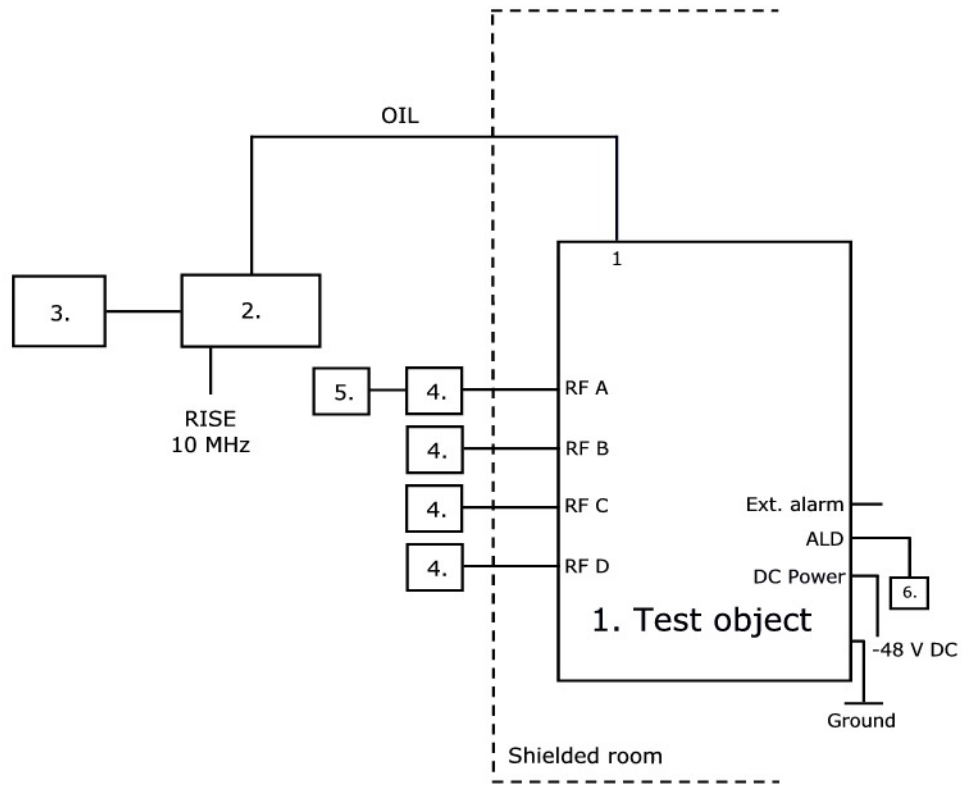

1.	Radio 4415 B2 B25, KRC 161 636/1, rev. R1B, s/n: D16W963156 With Radio Software: CXP 901 7316/7, rev. R67HA. FCC ID: TA8AKRC161636 and IC: 287AB-AS161636
----	--

Associated equipment:

2.	Testing Equipment: CT10, LPC 102 467/1, rev. R1C, s/n: T01F375046, BAMS – 1001466800 with software CXA 104 446/1, rev. R8AA
----	---

Functional test equipment:

3.	Computer, HP EliteBook 8560w, BAMS - 1001236854
4.	Attenuator
5.	R&S ESIB 26, RISE no: 503 292, for supervision purpose only
6.	ALD Control, Andrew, model: ATM200-A20, s/n: DESA101412073

Interfaces:

Power input configuration DC: -48 VDC	Power
RF A, 4.3-10 connector, combined TX/RX	Antenna
RF B, 4.3-10 connector, combined TX/RX	Antenna
RF C, 4.3-10 connector, combined TX/RX	Antenna
RF D, 4.3-10 connector, combined TX/RX	Antenna
1, Optical Interface Link, single mode opto fibre	Signal
2, Optical Interface Link, not used in this configuration	Signal
EXT Alarm, shielded multi-wire	Signal
ALD, shielded multi-wire	Signal
Ground wire	Ground

RF power output measurements according to CFR 47 §24.232 / IC RSS-133 6.4, conducted

Date	Temperature	Humidity
2017-09-15	22 °C ± 3 °C	41 % ± 5 %
2017-09-18	22 °C ± 3 °C	37 % ± 5 %
2017-10-16	22 °C ± 3 °C	40 % ± 5 %

Test set-up and procedure

The test object was connected to a signal analyser measuring peak and RMS output power in CDF mode. A resolution bandwidth of 80 MHz was used.

Measurement equipment	RISE number
R&S FSW 43	902 073
RF attenuator	900 691
Testo 635, temperature and humidity meter	504 203

Measurement uncertainty: 1.1 dB

Results

Single carrier TM 1

Rated output power 1 x 46 dBm per RF port.

Symbolic name	Output power CCDF [RMS dBm/ PAR dB]				
	Port RF A	Port RF B	Port RF C	Port RF D	Total power ¹⁾
B	45.20/ 7.38	45.21/ 7.38	45.27/ 7.38	45.16/ 7.38	51.23
M	45.72/ 7.36	45.78/ 7.36	45.73/ 7.34	45.72/ 7.34	51.76
T	45.62/ 7.38	45.64/ 7.38	45.67/ 7.38	45.57/ 7.38	51.65

¹⁾: summed output power according to FCC KDB662911 Multiple transmitter output.

Note: The PAR value is the 0.1 % Peak to Average Ratio.

Single carrier TM 5

Rated output power level at each RF port 1x 46 dBm/ port.

	Output power CCDF [RMS dBm/ PAR dB]				
symbolic name	Port RF A	Port RF B	Port RF C	Port RF D	Total power ¹⁾
M ₅	45.71/ 7.32	45.81/ 7.32	45.77/ 7.32	45.73/ 7.32	51.78

Single carrier TM 6

Rated output power level at each RF port 1x 46 dBm/ port.

	Output power CCDF [RMS dBm/ PAR dB]				
symbolic name	Port RF A	Port RF B	Port RF C	Port RF D	Total power ¹⁾
M ₅	45.68/ 7.32	45.81/ 7.32	45.76/ 7.30	45.69/ 7.32	51.76

Multi carrier TM 5

Rated output power level at each RF port 2x 43 dBm/ port.

	Output power CCDF [RMS dBm/ PAR dB]				
Symbolic name	Port RF A	Port RF B	Port RF C	Port RF D	Total power ¹⁾
M ₂	45.68/ 7.18	45.72/ 7.16	45.70/ 7.16	45.69/ 7.16	51.72

Multi carrier TM 5

Rated output power level at each RF port 6x 38.2 dBm/ port.

	Output power CCDF [RMS dBm/ PAR dB]				
Symbolic name	Port RF A	Port RF B	Port RF C	Port RF D	Total power ¹⁾
M ₆	45.94/ 7.16	45.89/ 7.16	45.78/ 7.16	45.76/ 7.16	51.86

¹⁾: summed output power according to FCC KDB662911 Multiple transmitter output

Note: The PAR value is the 0.1 % Peak to Average Ratio.

Single carrier TM 5

Rated output power level at RF connector 1x 46 dBm/ port.

Symbolic name	Output power per 1 MHz [RMS dBm]				
	Port RF A	Port RF B	Port RF C	Port RF D	Total power ¹⁾
M	40.25	40.29	40.20	40.10	46.23

¹⁾: summed output power according to FCC KDB662911 Multiple transmitter output.

Remark

ERP/EIRP compliance is addressed at the time of licensing, as required by the responsible FCC/IC Bureau(s). Licensee’s are required to take into account maximum antenna gain used in combination with above power settings to prevent the radiated output power to exceed the limits.

Limits

CFR 47 §24.232

The maximum output power may not exceed 3280 W/MHz (EIRP).
The Peak to Average Ratio (PAR) may not exceed 13 dB.

RSS-133

Base station transmitters operating in the band 1930-1995 MHz shall not have output power exceeding 100 watts. When the transmitter power is measured in terms of average value, the peak-to-average ratio(PAR) of the power shall not exceed 13 dB

There is no EIRP limit specified for base station equipment in the RSS-133.

EIRP compliance is addressed at the time of licensing, as required by the responsible IC Bureau. Licensee’s are required to take into account the antenna gain to get the maximum usable power settings to prevent the radiated output power to exceed the EIRP limits specified in SRSP-510

Complies?	Yes
-----------	-----

Occupied bandwidth measurements according to CFR47 2.1049 / RSS-Gen 4.6.1

Date 2017-09-18	Temperature 22 °C ± 3 °C	Humidity 37 % ± 5 %
--------------------	-----------------------------	------------------------

Test set-up and procedure

The measurements were made per definition in § 2.1049. The output was connected to a signal analyzer with the Peak detector activated in max hold.

Measurement equipment	RISE number
R&S FSW 43	902 073
RF attenuator	900 691
Testo 635, temperature and humidity meter	504 203

Measurement uncertainty: 3.7 dB

Results

Single carrier TM 1

Diagram	Symbolic name	Tested Port	Occupied BW (99%) [MHz]
1	T	RF A	4.166
2	B	RF B	4.164
3	M	RF B	4.164
4	T	RF B	4.166
5	T	RF C	4.162
6	T	RF D	4.164

Single carrier TM 5

Diagram	Symbolic name	Tested Port	Occupied BW (99%) [MHz]
7	T	RF B	4.177

Single carrier TM 6

Diagram	Symbolic name	Tested Port	Occupied BW (99%) [MHz]
8	T	RF B	4.153

Diagram 1:

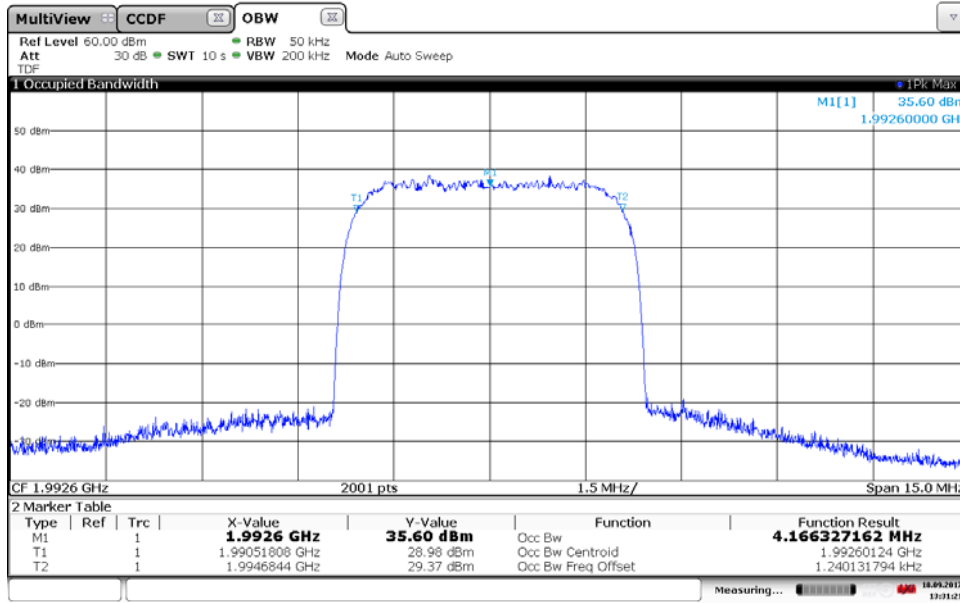

13:31:22 18.09.2017

Diagram 2:

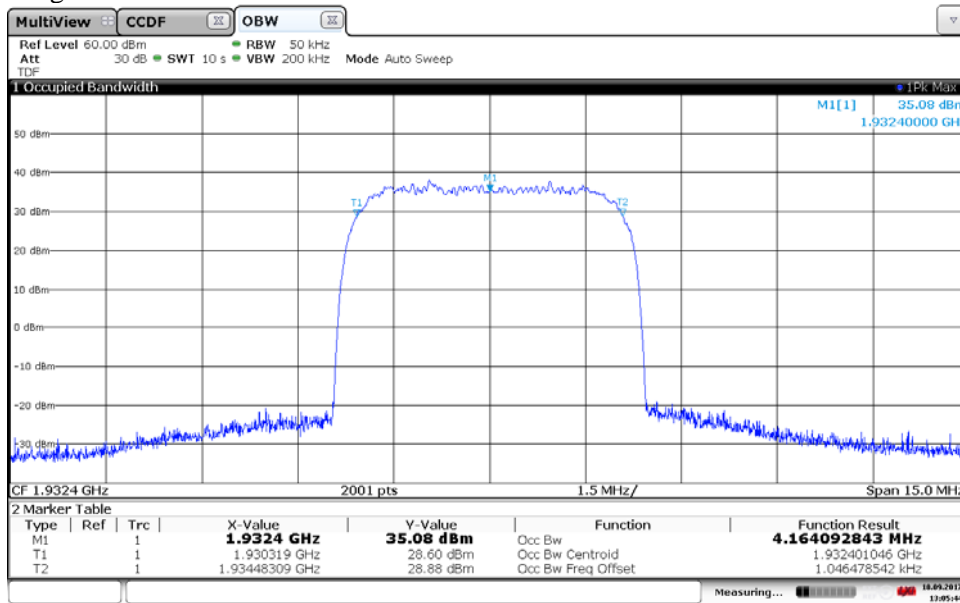

13:05:45 18.09.2017

Diagram 3:

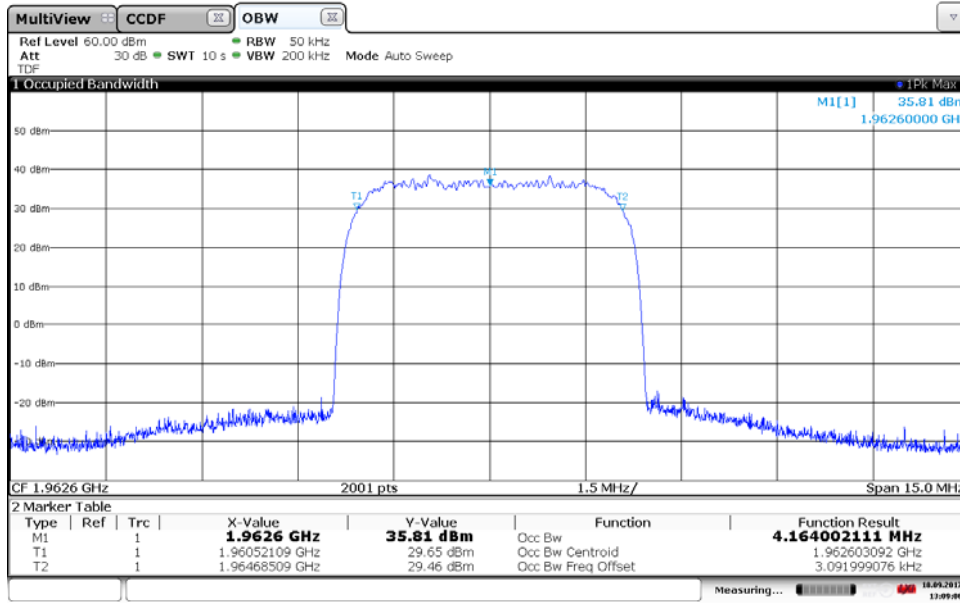

13:09:06 18.09.2017

Diagram 4:

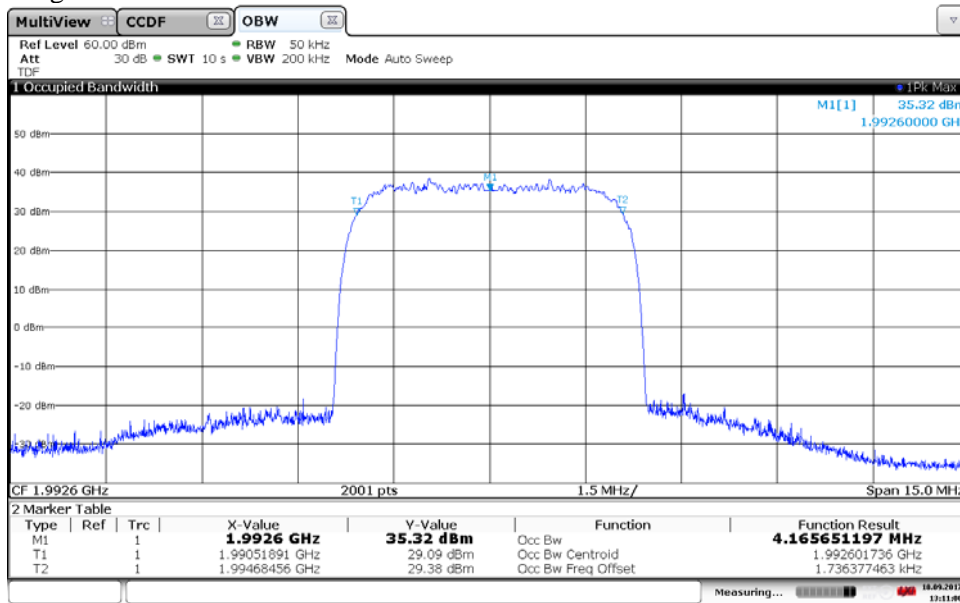

13:11:09 18.09.2017

Diagram 5:

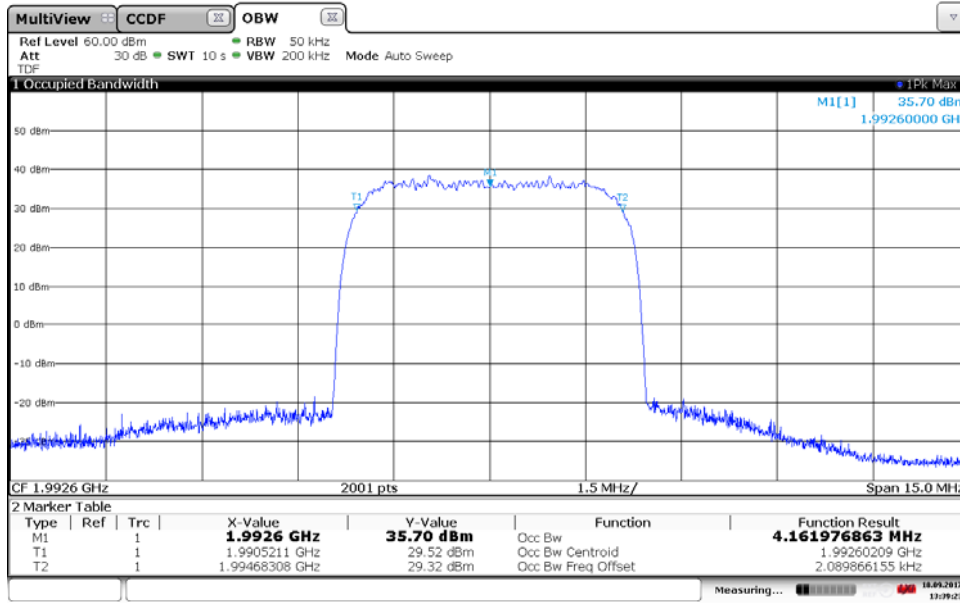

13:39:24 18.09.2017

Diagram 6:

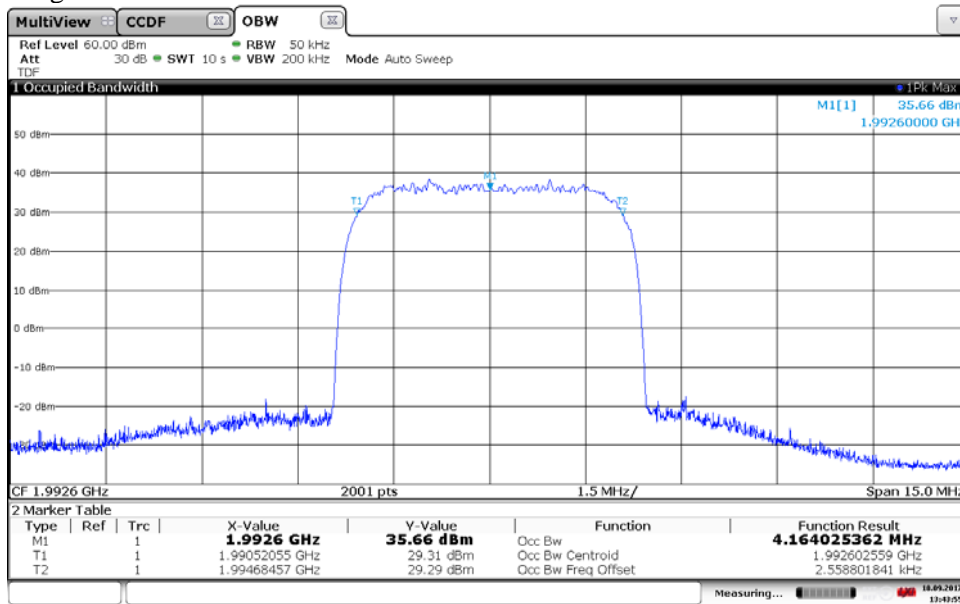

13:43:55 18.09.2017

Diagram 7:

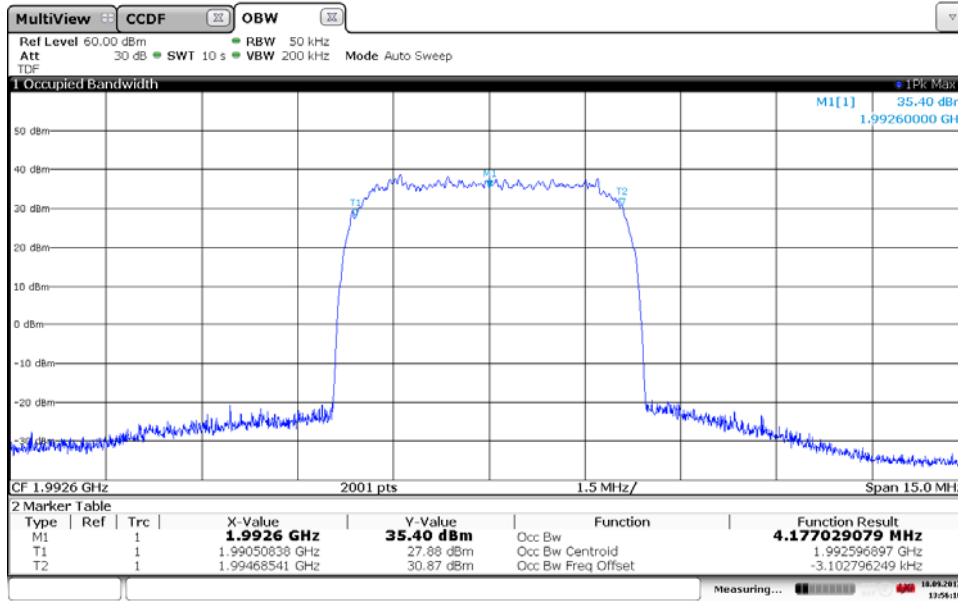

13:56:19 18.09.2017

Diagram 8:

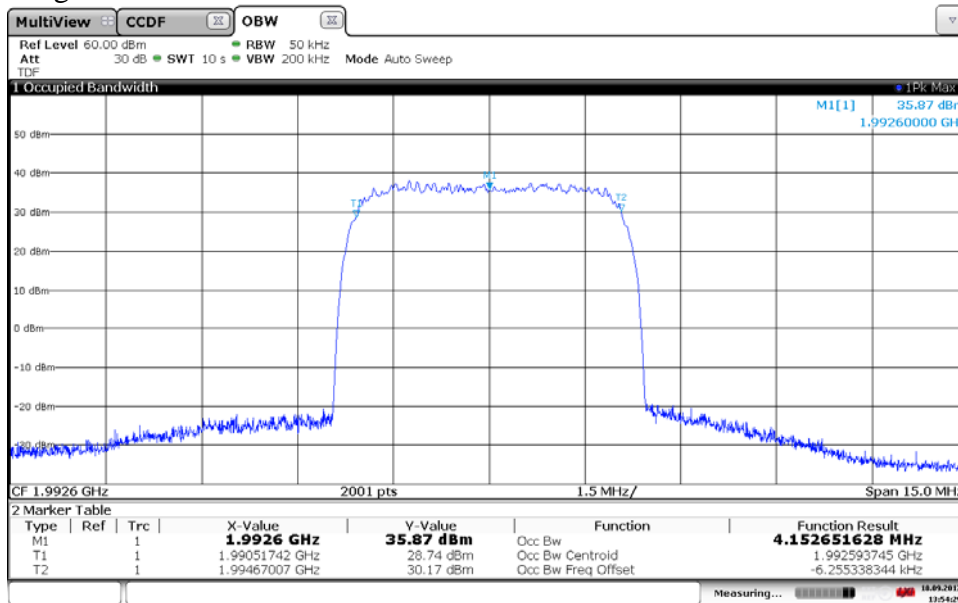

13:54:29 18.09.2017

Band edge measurements according to CFR 47 §2.4.238 / IC RSS-133 6.6

Date 2017-09-12	Temperature 21 °C ± 3 °C	Humidity 49 % ± 5 %
--------------------	-----------------------------	------------------------

Test set-up and procedure

The measurements were made per definition in CFR 47 §24.238. The test object was connected to a spectrum analyzer with the RMS detector activated. The spectrum analyzer was connected to an external 10 MHz reference standard during the measurements.

A RBW 1% of EBW was used up to 1 MHz away from the band edges. A smaller resolution bandwidth is permitted provided that the measured power is integrated over the full required measurement bandwidth. Where a smaller RBW was used the limit in the plot is adjusted by $10 \log (RBW_{used}/RBW_{specified})$ [dB] according to the following table:

Carrier BW:	RBW _{used}	RBW _{specified} (1% of EBW)	Limit correction	Adjusted limit
5 MHz	10 kHz	46.9 kHz	-6.7 dBm	-19.7 dBm

From 1 MHz to 30 MHz away from the band edges a RBW of 100 kHz was used. To compensate for the reduced RBW the limit was adjusted by 10 dB to -23 dBm in this frequency range.

Before comparing the results to the limit, 6 dB [$10 \log (4)$] to cover 2x(2x2) MIMO, should be added according to method c “measure and add $10 \log(N_{ANT})$ ” of FCC KDB662911 D01 Multiple Transmitter Output.

Measurement equipment	RISE number
R&S FSW 43	902 073
RF attenuator	900 691
Testo 635, temperature and humidity meter	504 203

Measurement uncertainty: 3.7 dB

Results

Single carrier TM 1

Diagram	Symbolic name	Tested Port
1 a-b	B	RF B
2 a-b	T	RF B

Single carrier TM 5

Diagram	Symbolic name	Tested Port
3 a-b	B	RF A
4 a-b	T	RF A
5 a-b	B	RF B
6 a-b	T	RF B
7 a-b	B	RF C
8 a-b	T	RF C
9 a-b	B	RF D
10 a-b	T	RF D

Single carrier TM 6

Diagram	Symbolic name	Tested Port
11 a-b	B	RF B
12 a-b	T	RF B

Multi carrier TM 5

Diagram	Symbolic name	Tested Port
13 a-b	Bim	RF B
14 a-b	Tim	RF B

Limits

CFR 47 §24.238 and RSS-133 6.5

Outside a licensee's frequency band(s) of operation the power of any emission shall be attenuated below the transmitter power (P) by at least $43 + 10 \log (P)$ dB, resulting in a limit of -13 dBm.

Complies?	Yes
-----------	-----

Diagram 1 a:

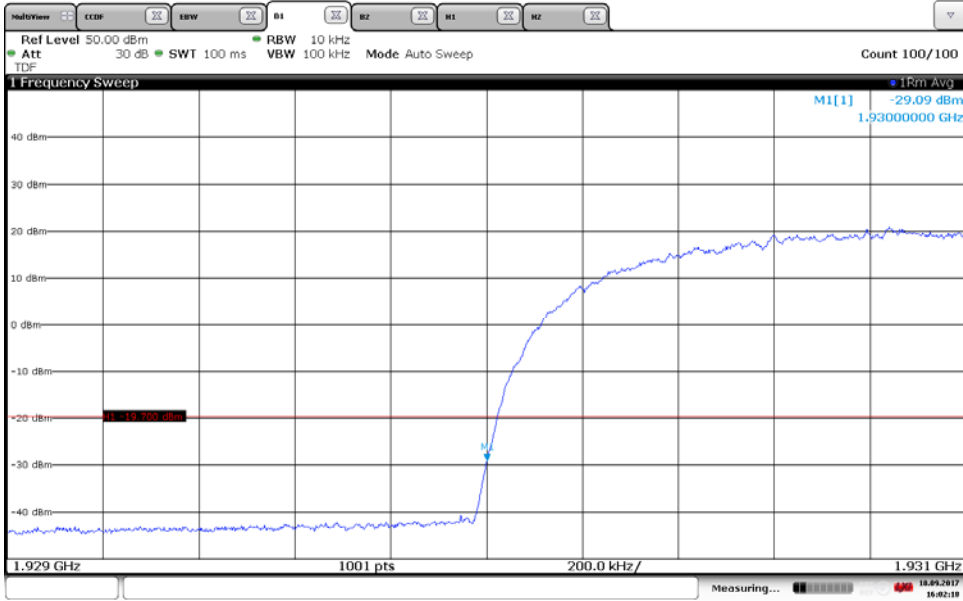

16:02:18 18.09.2017

Diagram 1 b:

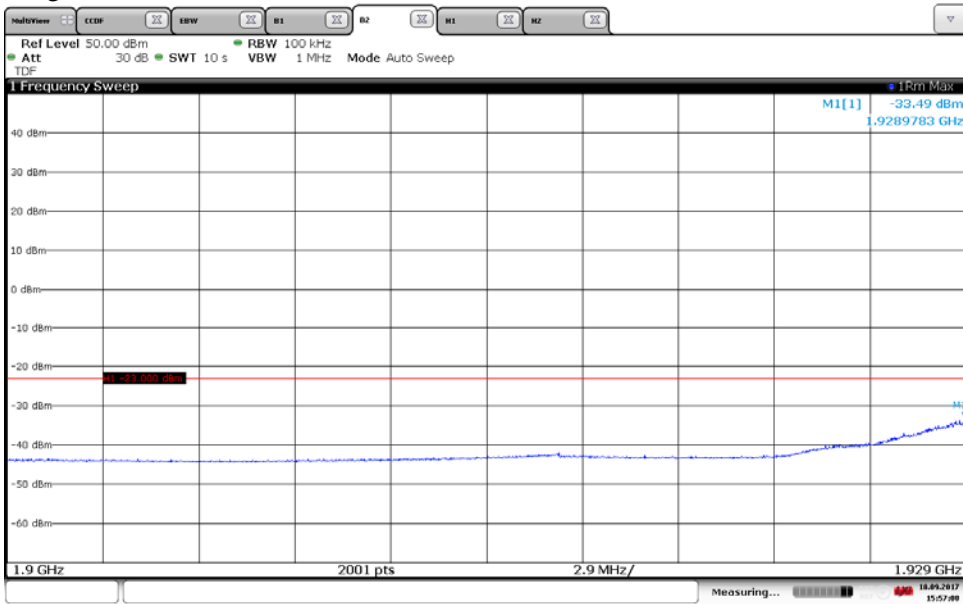

15:57:09 18.09.2017

Diagram 2 a:

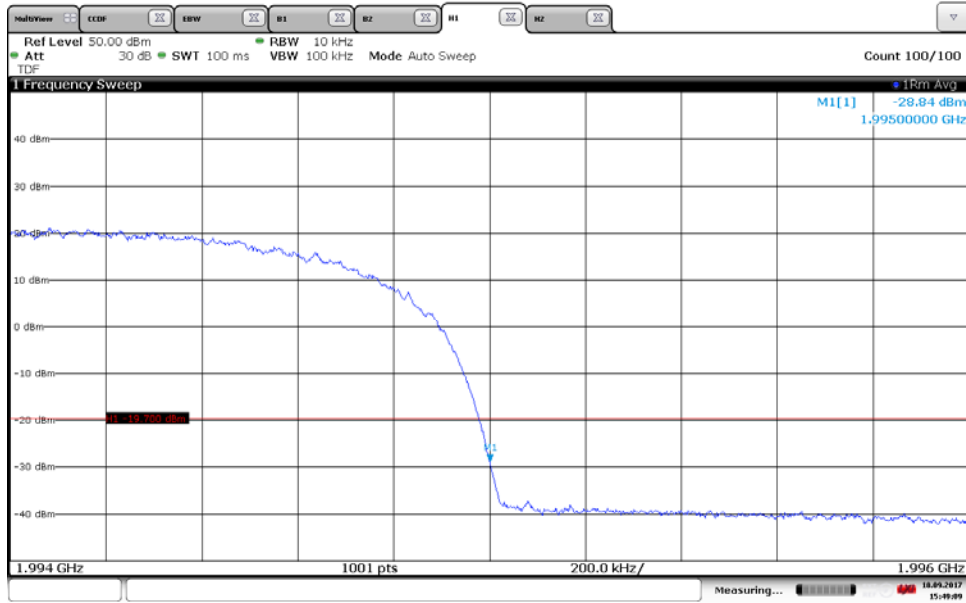

15:49:09 18.09.2017

Diagram 2 b:

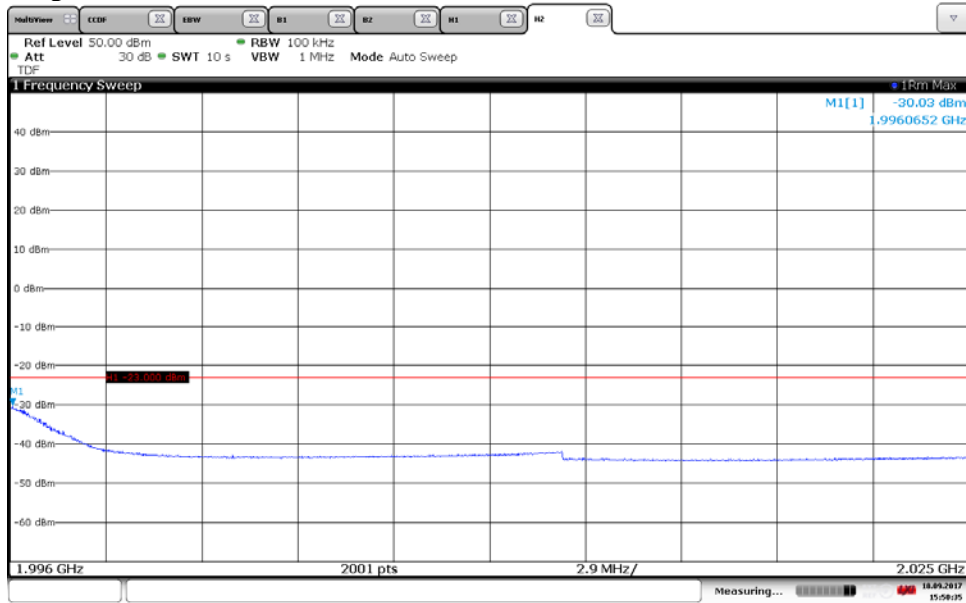

15:50:36 18.09.2017

Diagram 3 a:

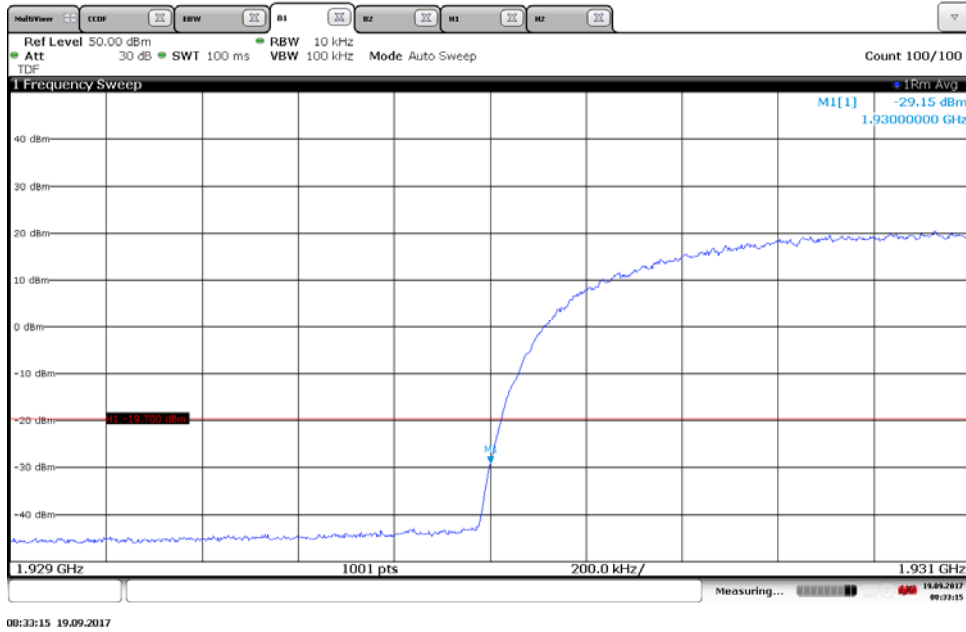

Diagram 3 b:

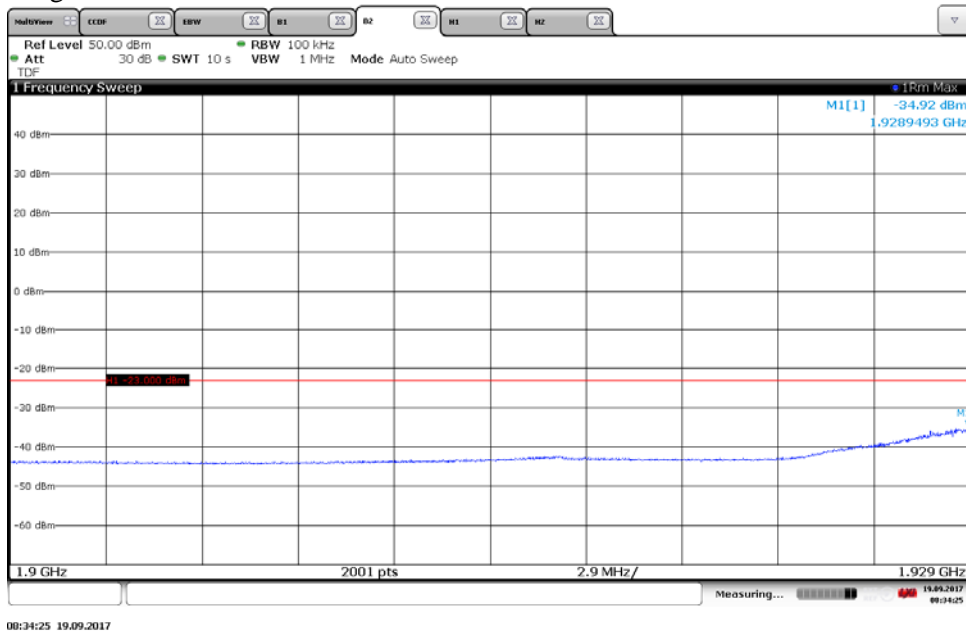
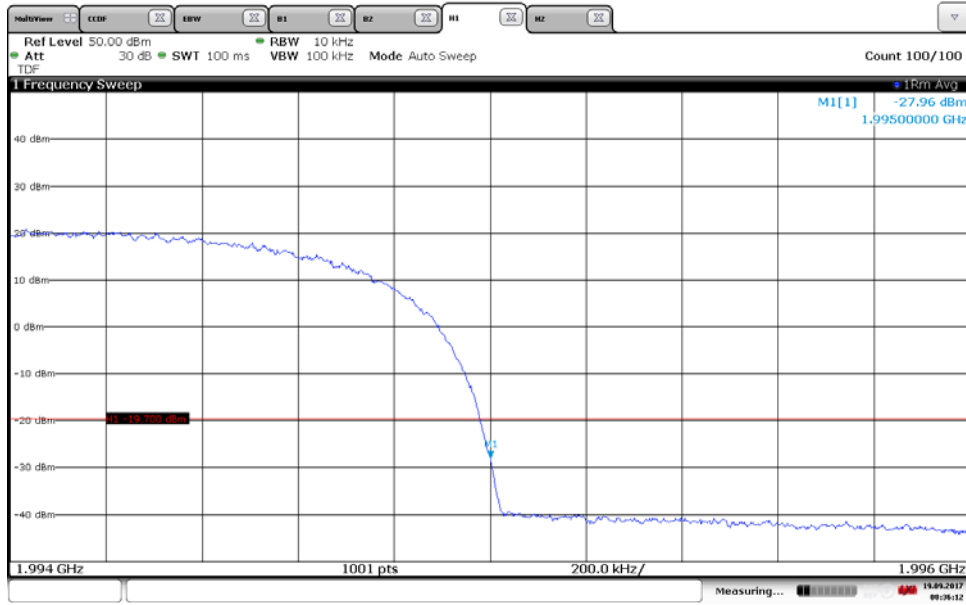
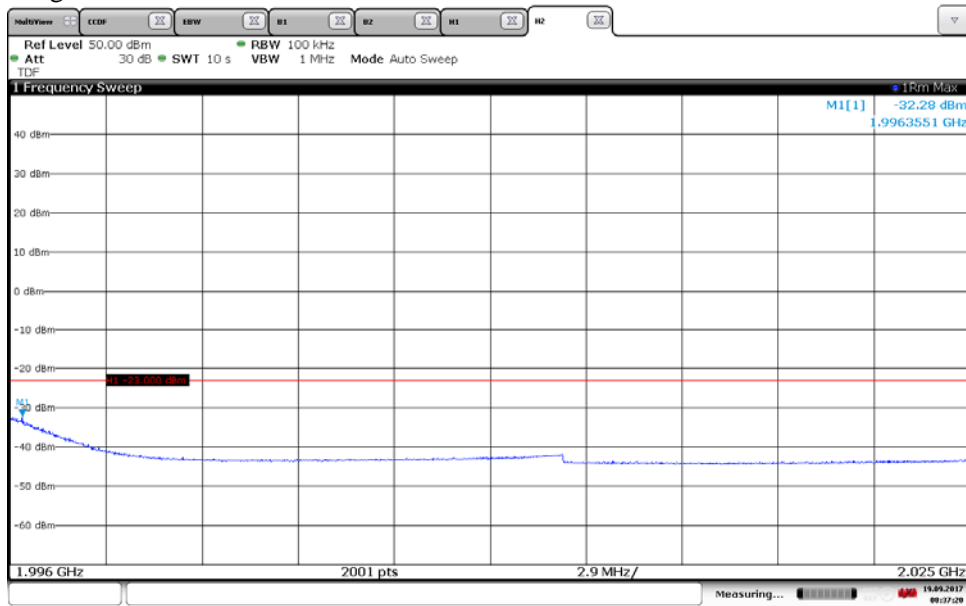

Diagram 4 a:



08:36:13 19.09.2017

Diagram 4 b:



08:37:21 19.09.2017

Diagram 5 a:

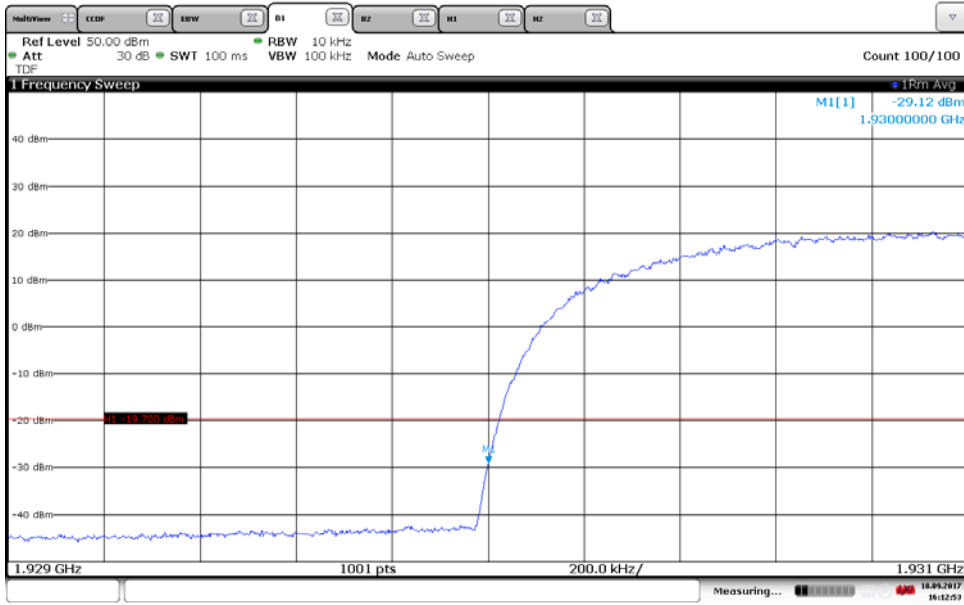

16:12:53 18.09.2017

Diagram 5 b:

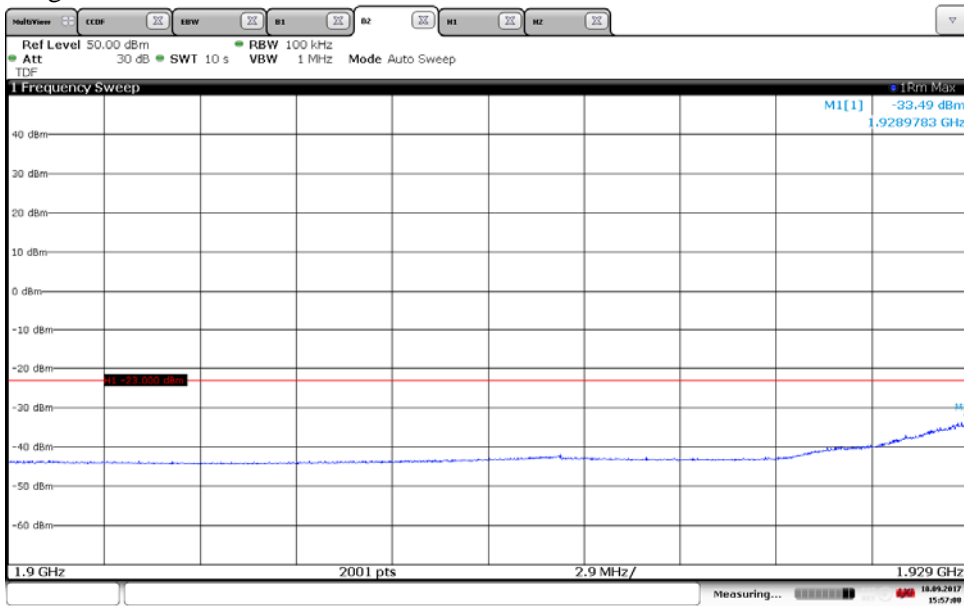

15:57:09 18.09.2017

Diagram 6 a:

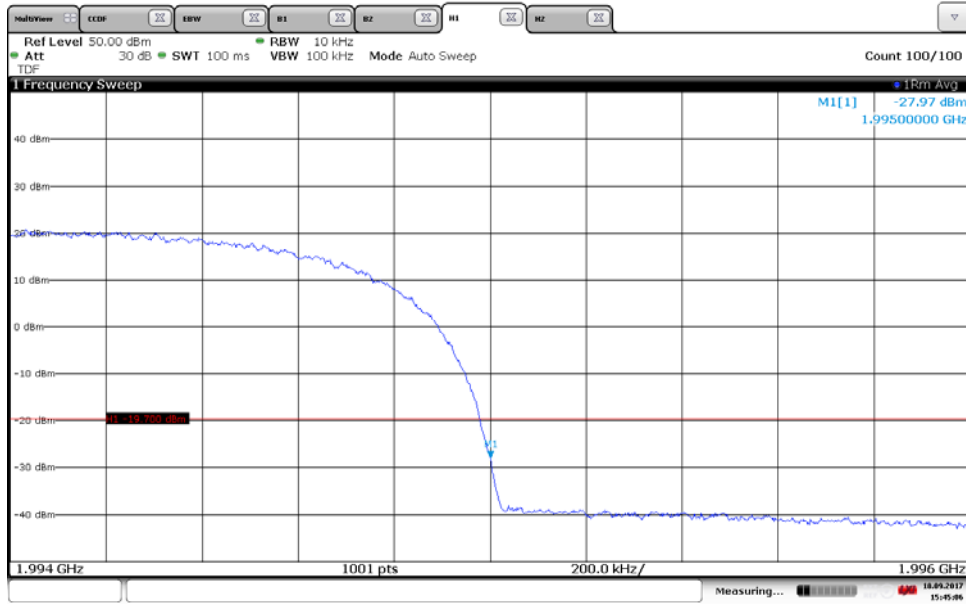

Diagram 6 b:

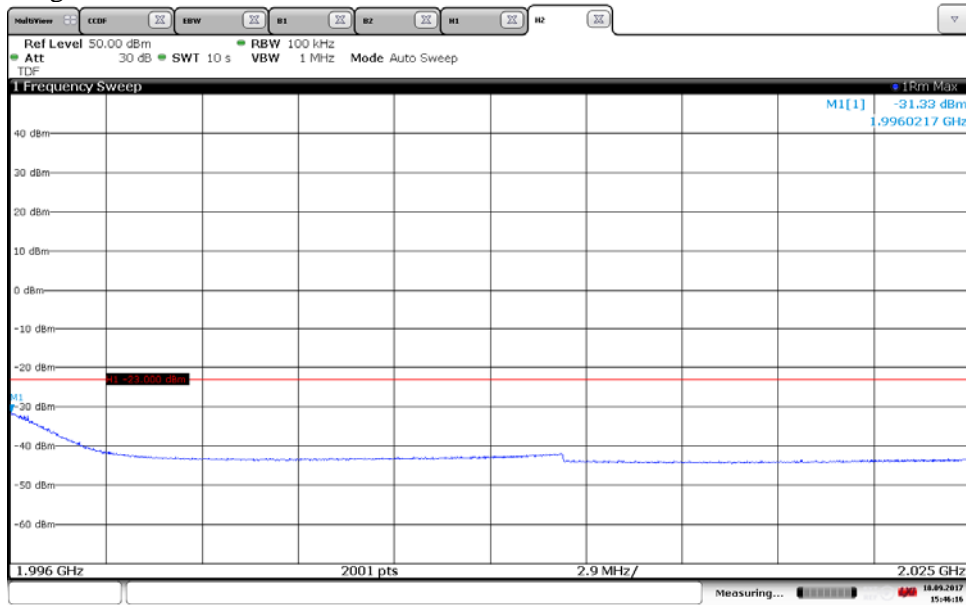

Diagram 7 a:

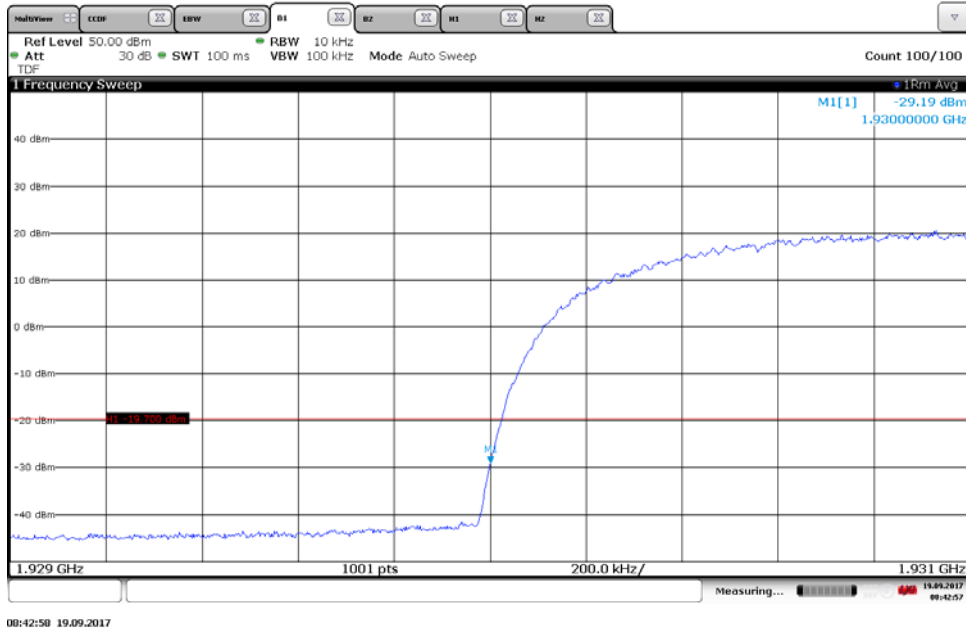

Diagram 7 b:

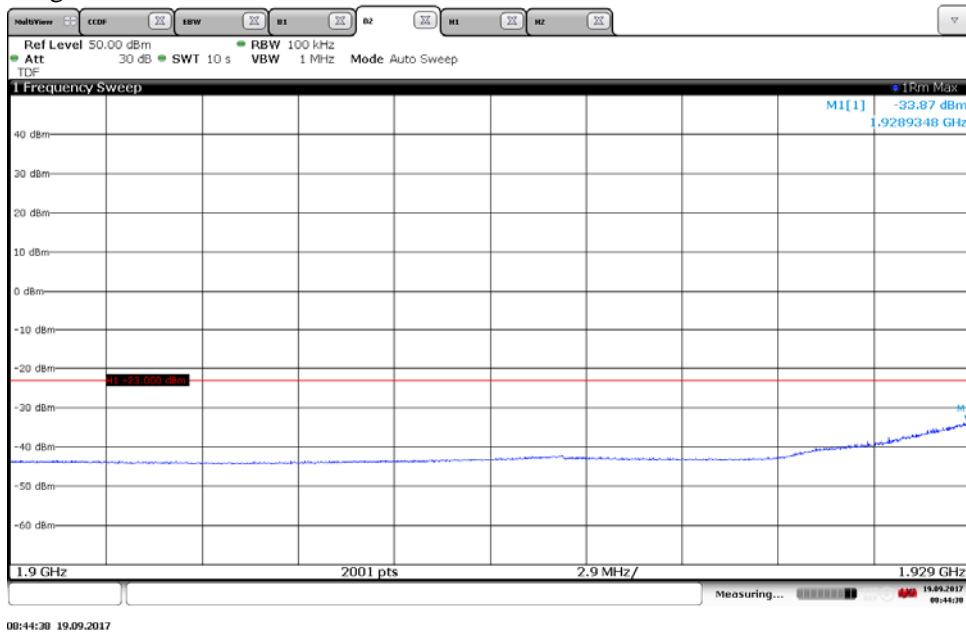
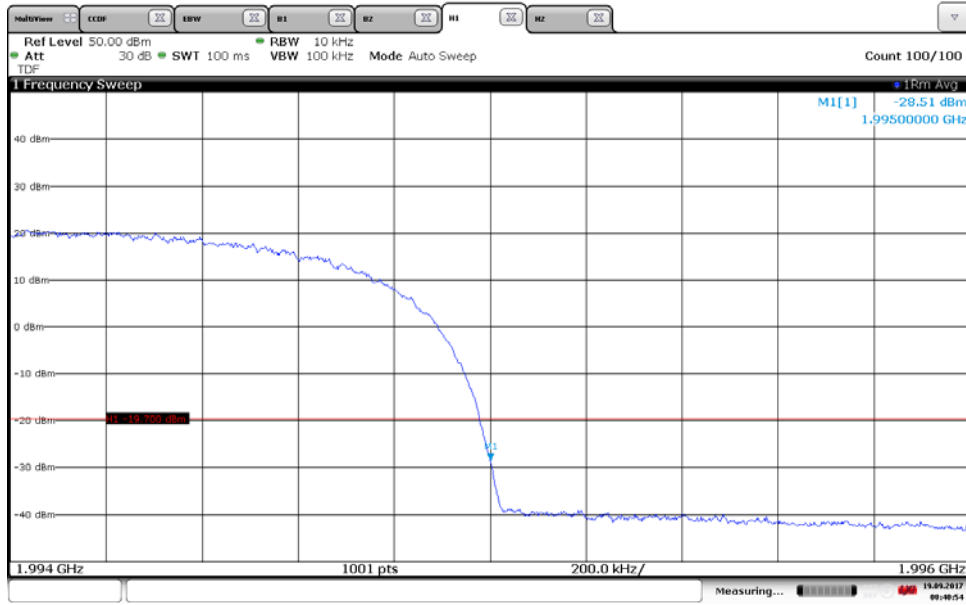
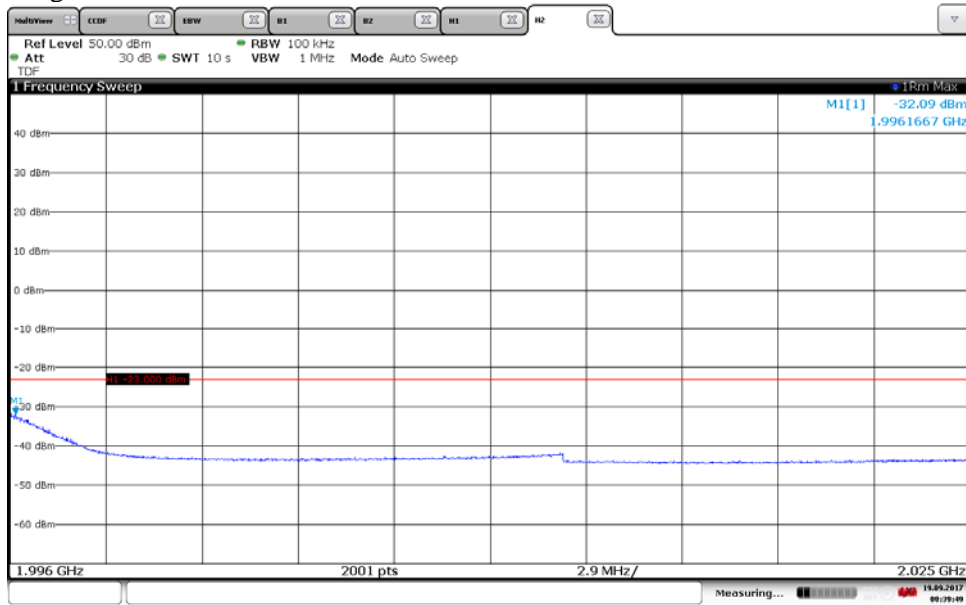

Diagram 8 a:



08:40:55 19.09.2017

Diagram 8 b:



08:39:49 19.09.2017

Diagram 9 a:

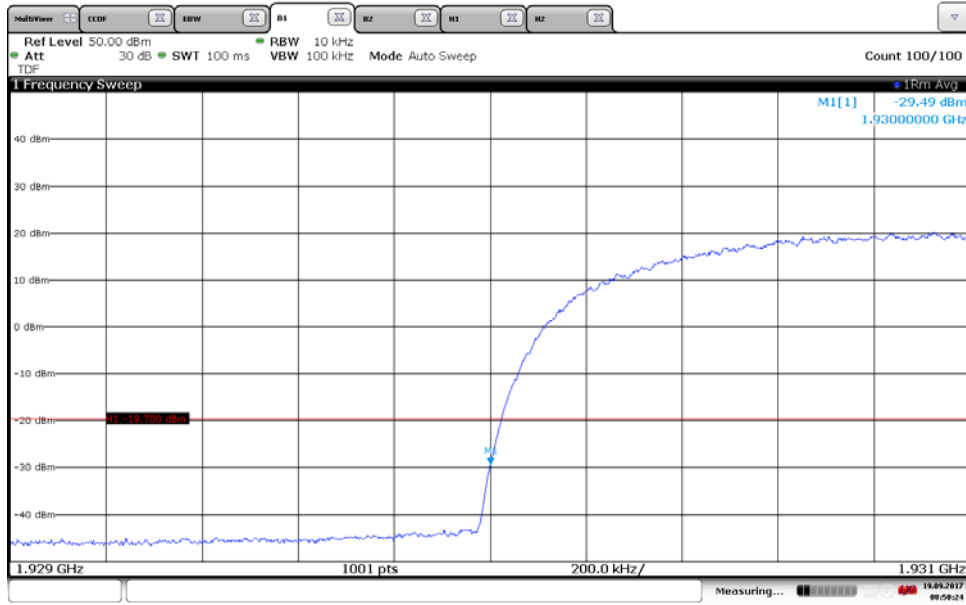

08:50:24 19.09.2017

Diagram 9 b:

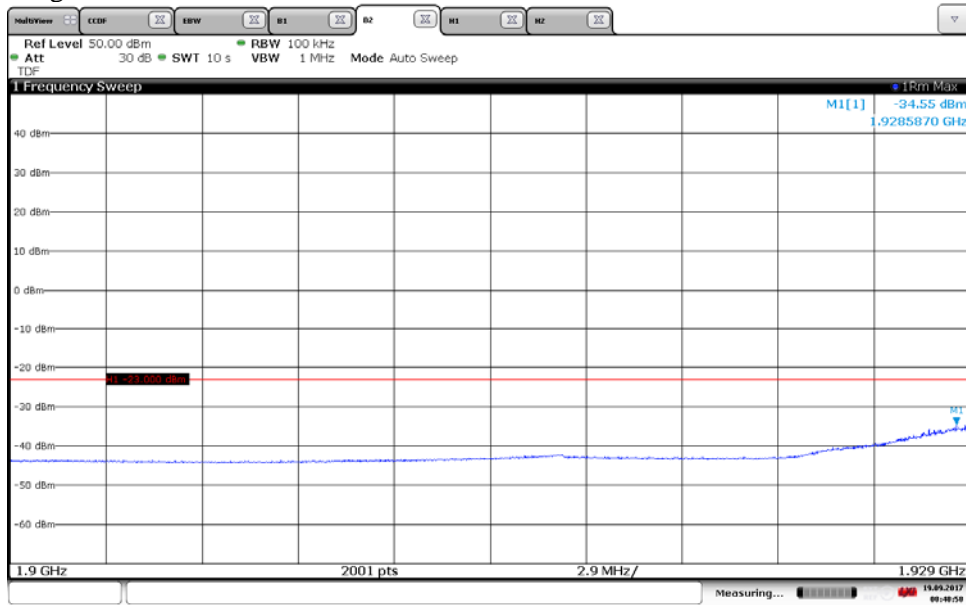

08:40:50 19.09.2017

Diagram 10 a:

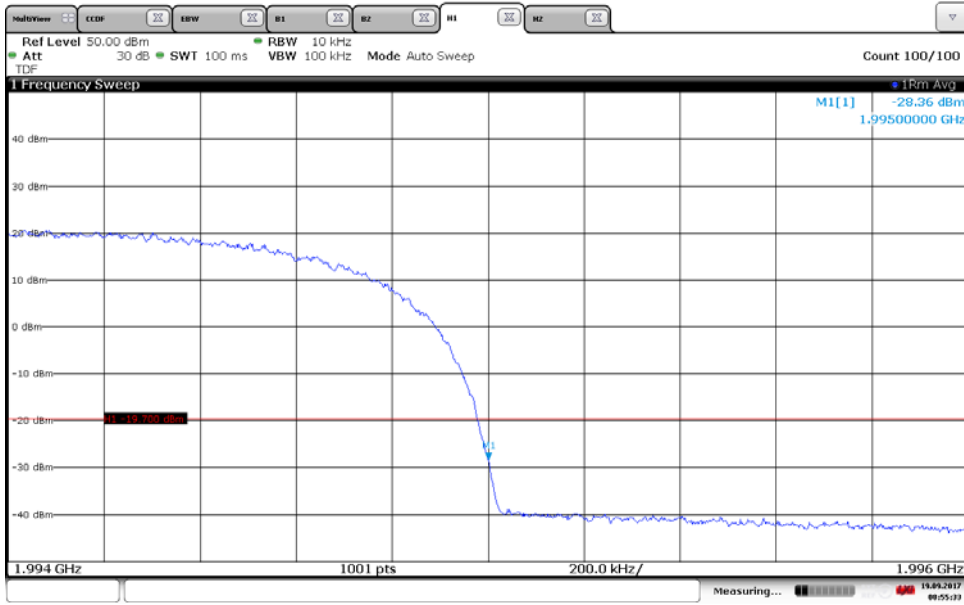

08:55:34 19.09.2017

Diagram 10 b:

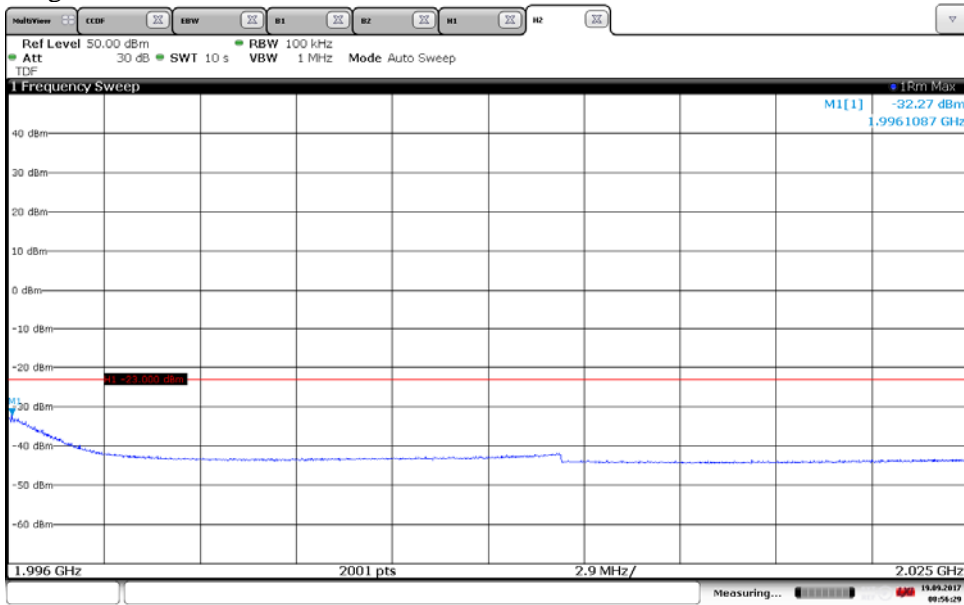

08:56:30 19.09.2017

Diagram 11 a:

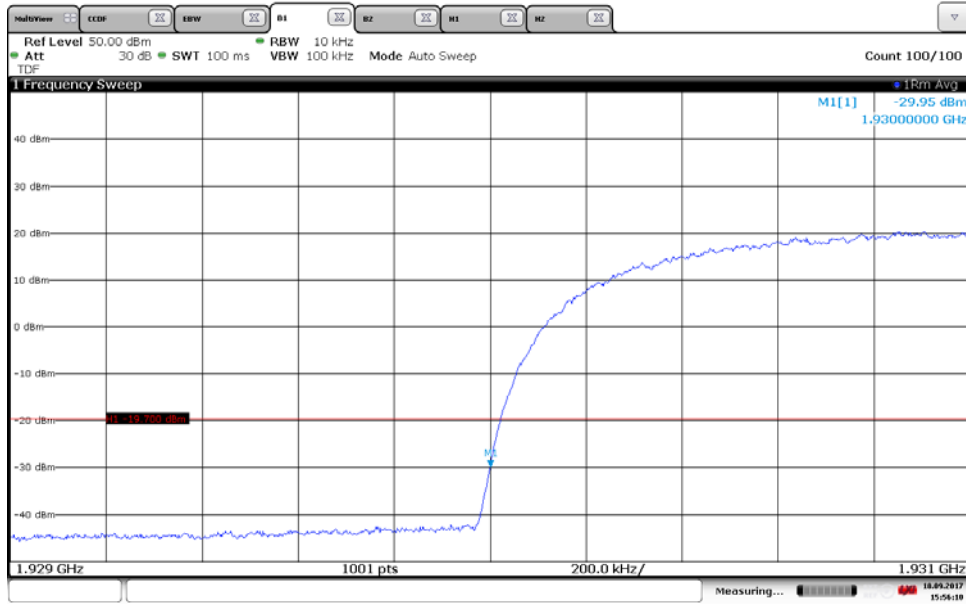

15:56:11 18.09.2017

Diagram 11 b:

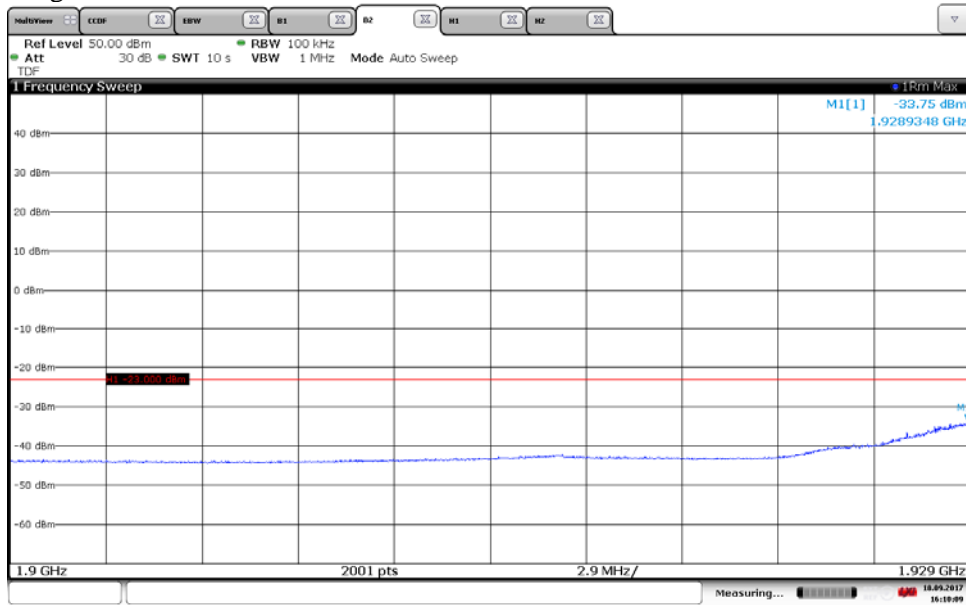

16:10:09 18.09.2017

Diagram 12 a:

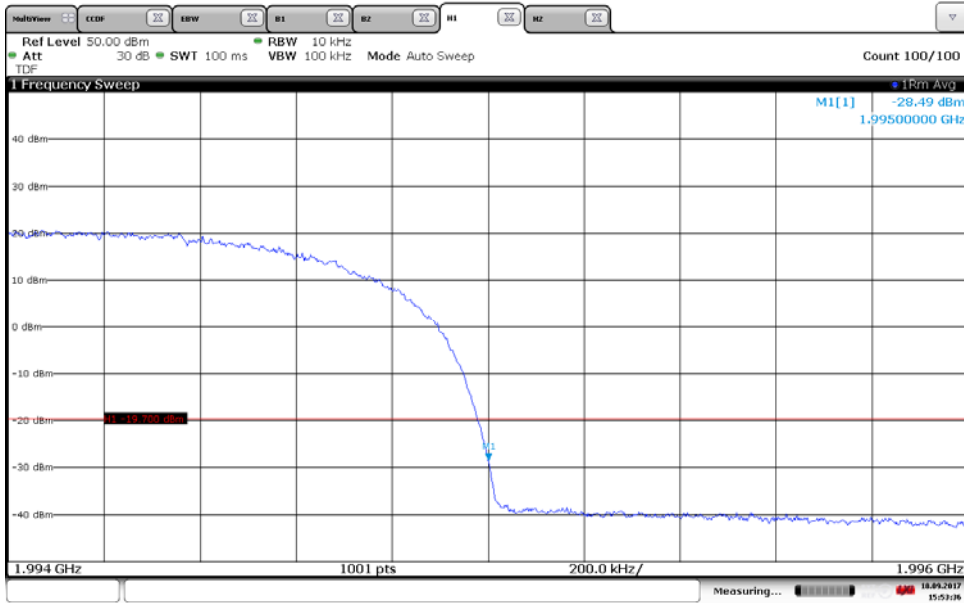

15:53:37 18.09.2017

Diagram 12 b:

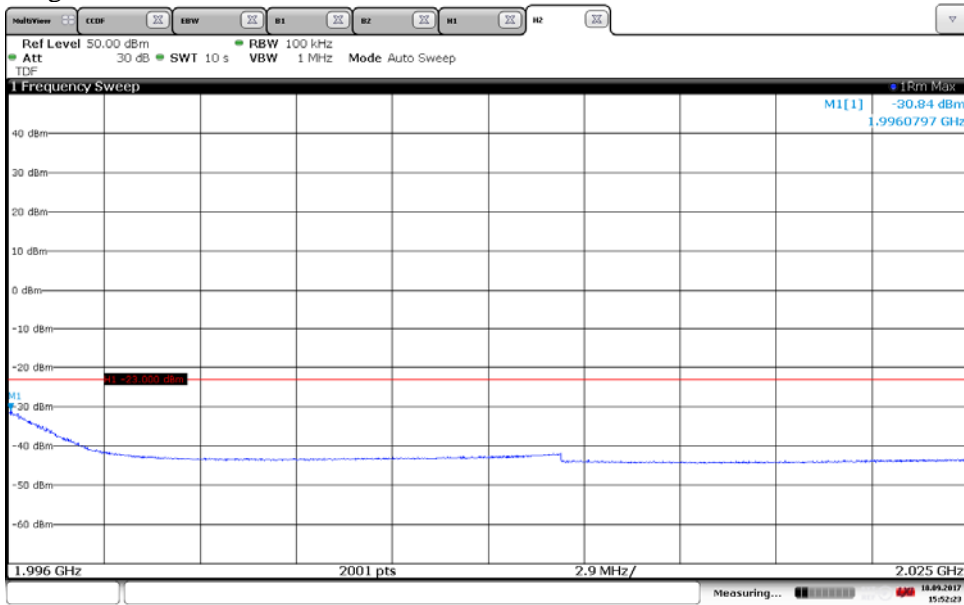

15:52:24 18.09.2017

Diagram 13 a:

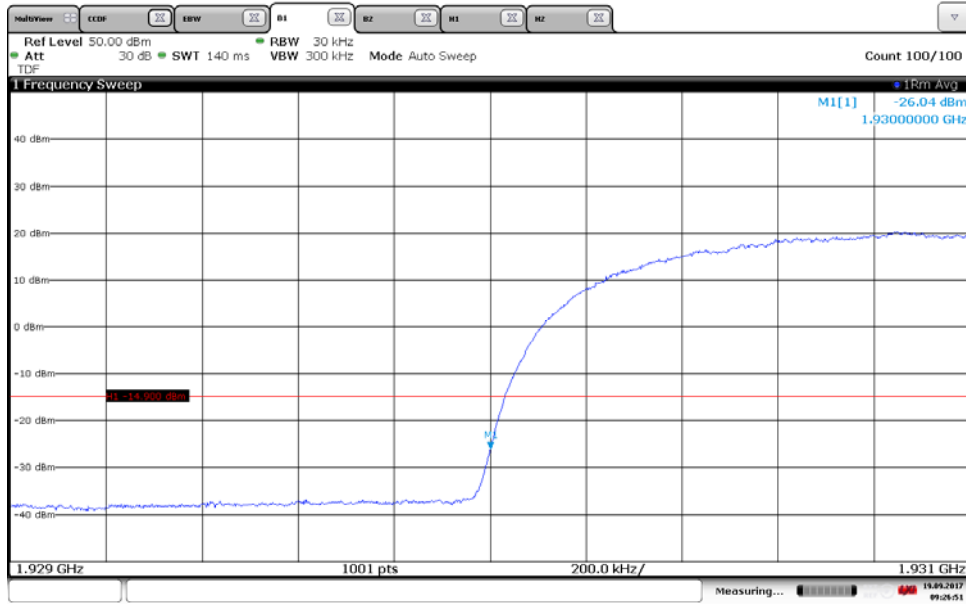

09:26:52 19.09.2017

Diagram 13 b:

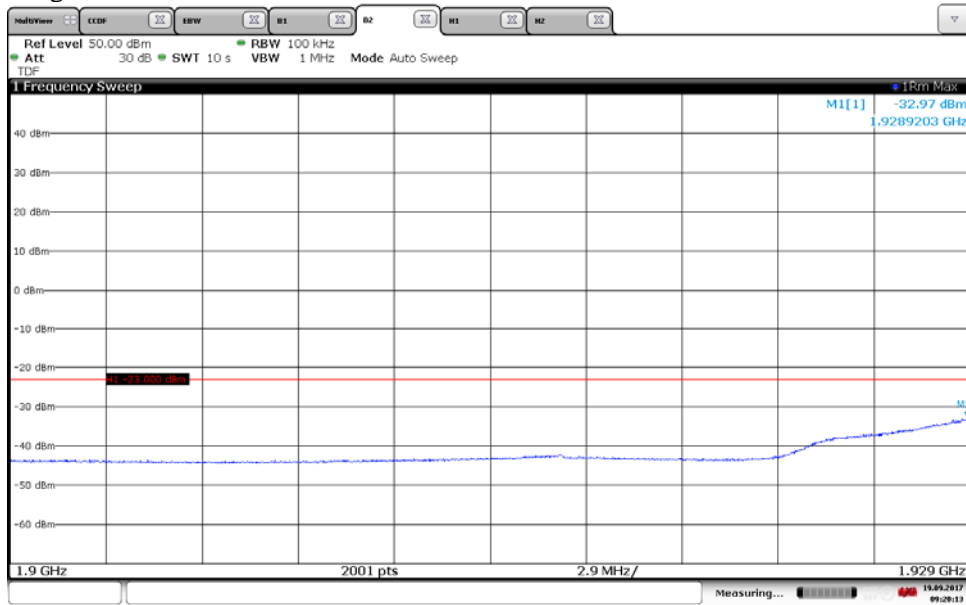

09:20:13 19.09.2017

Diagram 14 a:

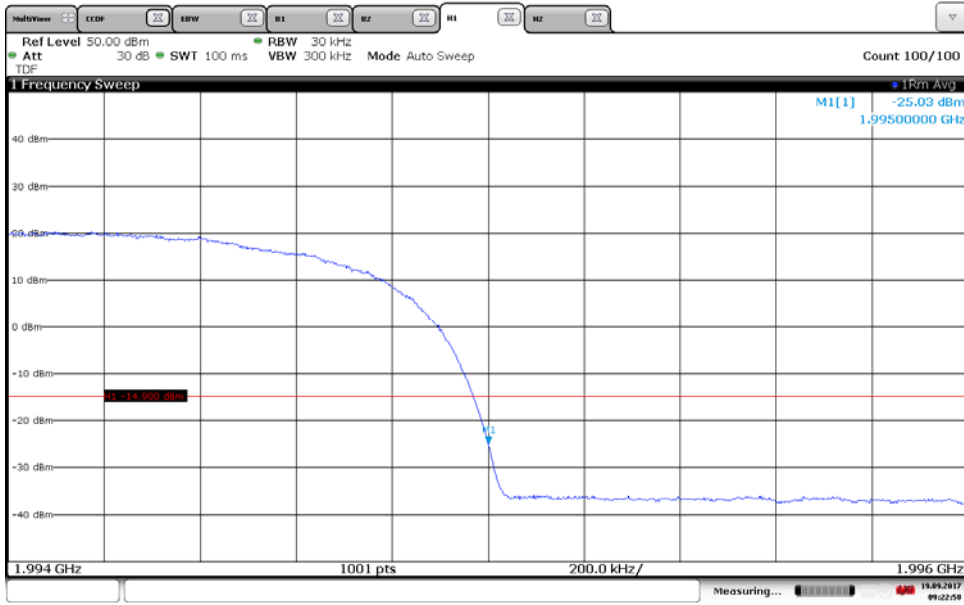
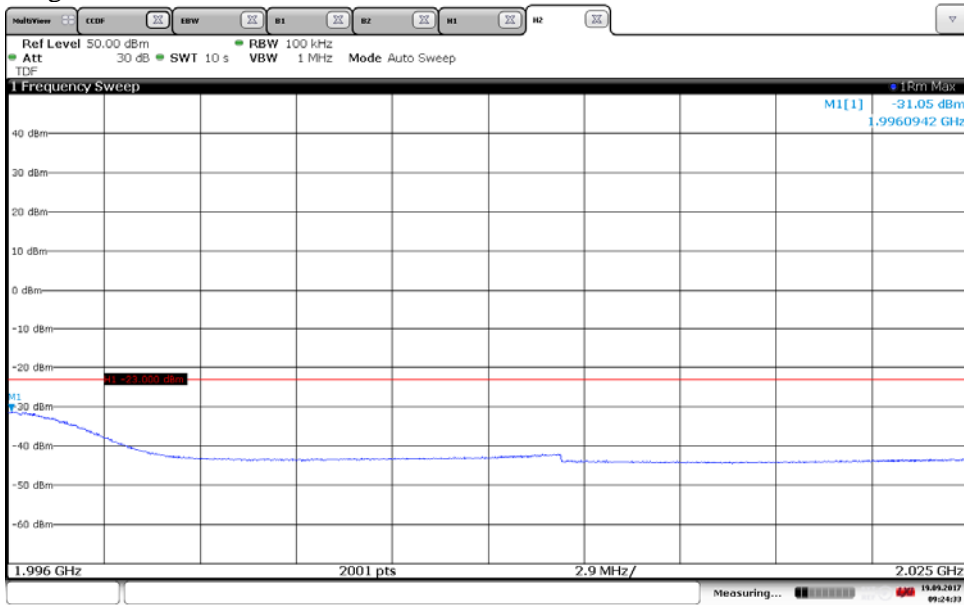

Diagram 14 b:



Conducted spurious emission measurements according to CFR 47 §24.238 / IC RSS-133 6.2

Date	Temperature	Humidity
2017-09-19	22 °C ± 3 °C	39 % ± 5 %
2017-09-21	23 °C ± 3 °C	41 % ± 5 %

Test set-up and procedure

The measurements were made per definition in §24.238. The output was connected to a spectrum analyzer with a RBW setting of 1 MHz and RMS detector activated. The spectrum analyzer was connected to an external 10 MHz reference standard during the measurements.

Before comparing the results to the limit, 6 dB [10 log (4)] to cover 2x(2x2) MIMO, should be added according to method c “measure and add 10 log(N_{ANT})” of FCC KDB662911 D01 Multiple Transmitter Output.

Measurement equipment	RISE number
R&S FSW 43	902 073
RF attenuator	900 691
HP filter	BX40074
Testo 635, temperature and humidity meter	504 203

Measurement uncertainty: 3.7 dB

Results

Single carrier TM 1

Diagram	Symbolic name	Tested Port
1 a-b	M	RF B

Single carrier TM 5

Diagram	Symbolic name	Tested Port
2 a-b	M	RF A
3 a-b	B	RF B
4 a-b	M	RF B
5 a-b	T	RF B
6 a-b	M	RF C
7 a-b	M	RF D

Single carrier TM 6

Diagram	Symbolic name	Tested Port
8 a-b	M	RF B

Multi carrier TM 5

Diagram	Symbolic name	Tested Port
9 a-c	M2	RF B
10 a-c	M6	RF B
11 a-c	Bim	RF B
12 a-c	Tim	RF B

Note: Measurements were mainly limited to port RF B due to the measurement result in single carrier mode that shows that the ports are electrical identical as declared by the client.

Remark

The emission at 9 kHz on the plots was not generated by the test object. A complementary measurement with a smaller RBW showed that it was related to the LO feed-through.

The highest fundamental frequency is 1995 MHz. The measurements were made up to 20 GHz (10x1995 MHz = 19950 MHz).

Limits

CFR 47 §24.238 and RSS-133 6.5

Outside a licensee's frequency band(s) of operation the power of any emission shall be attenuated below the transmitter power (P) by at least $43 + 10 \log (P)$ dB, resulting in a limit of -13 dBm per 1 MHz RBW.

Complies?	Yes
-----------	-----

Diagram 1a:

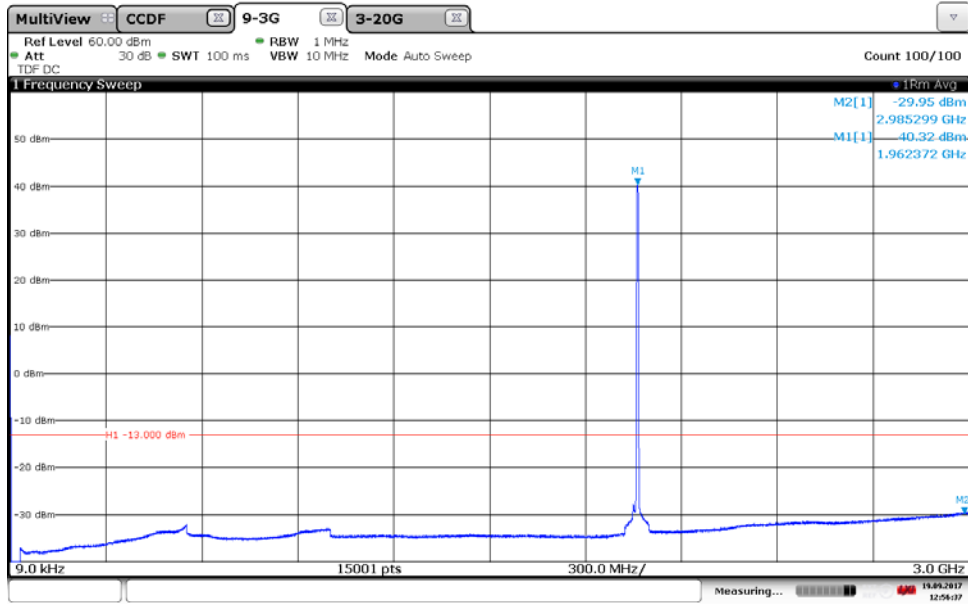

12:56:37 19.09.2017

Diagram 1b:

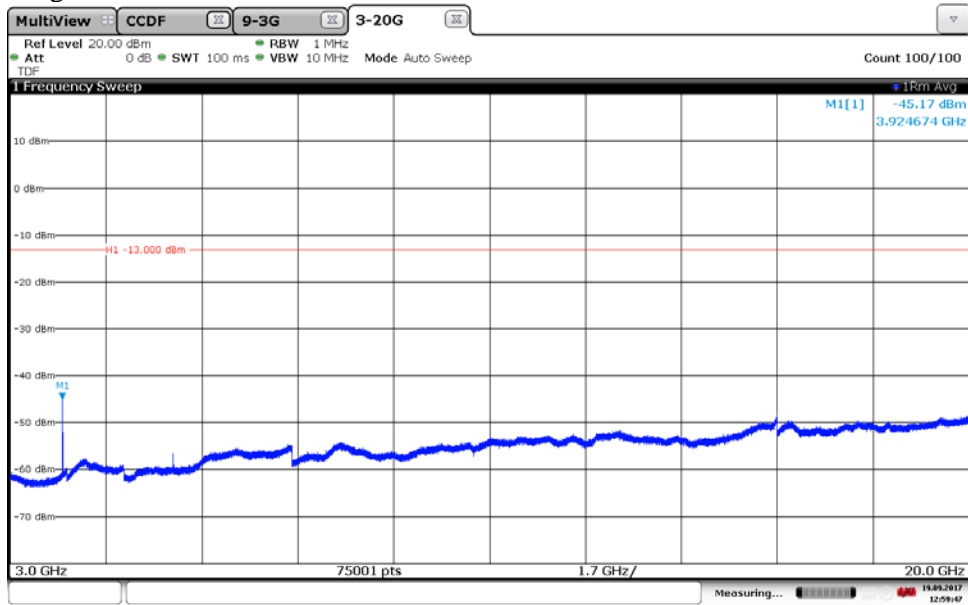

12:59:47 19.09.2017

Diagram 2a:

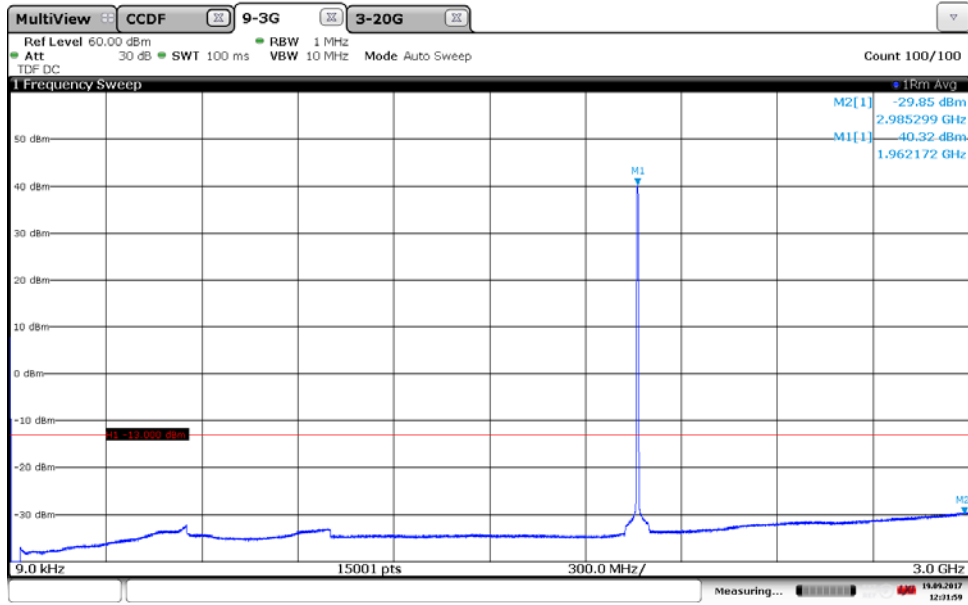

12:31:59 19.09.2017

Diagram 2b:

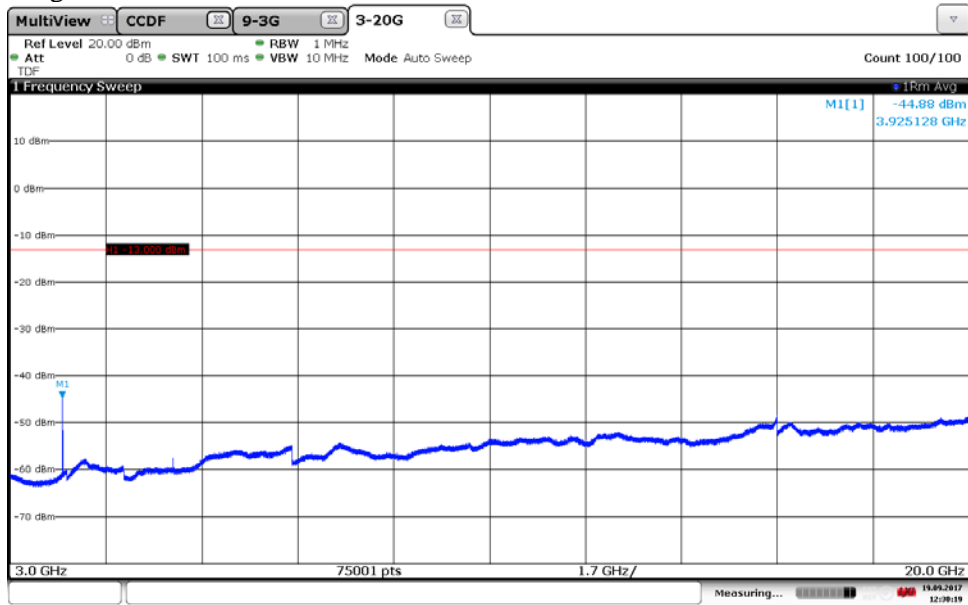

12:30:20 19.09.2017

Diagram 3a:

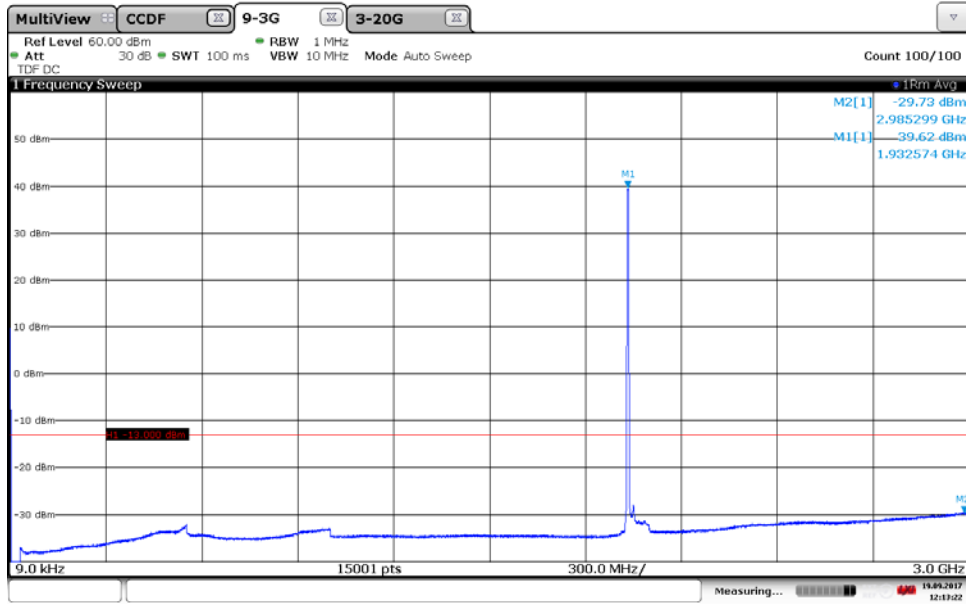

12:13:23 19.09.2017

Diagram 3b:

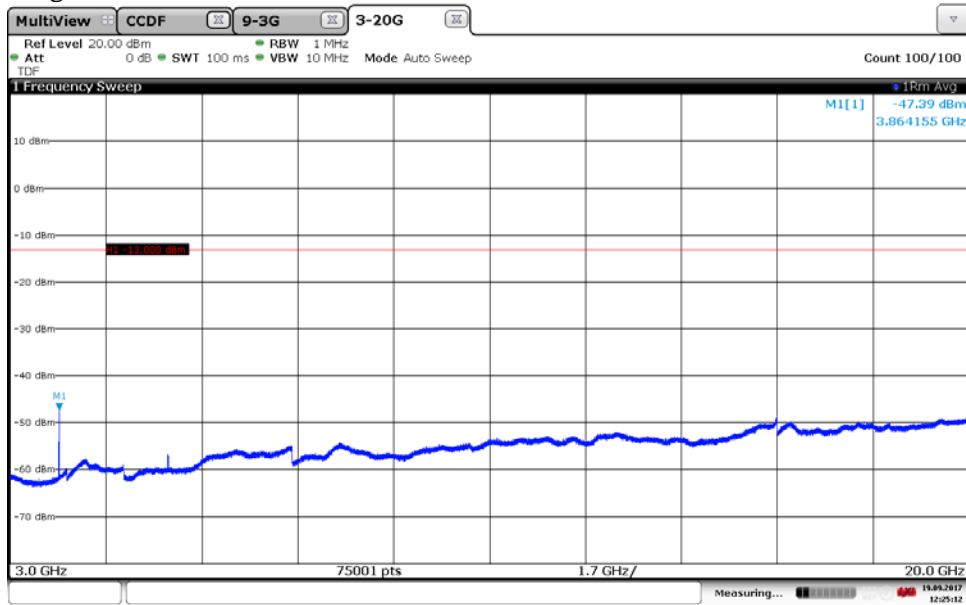

12:25:13 19.09.2017

Diagram 4a:

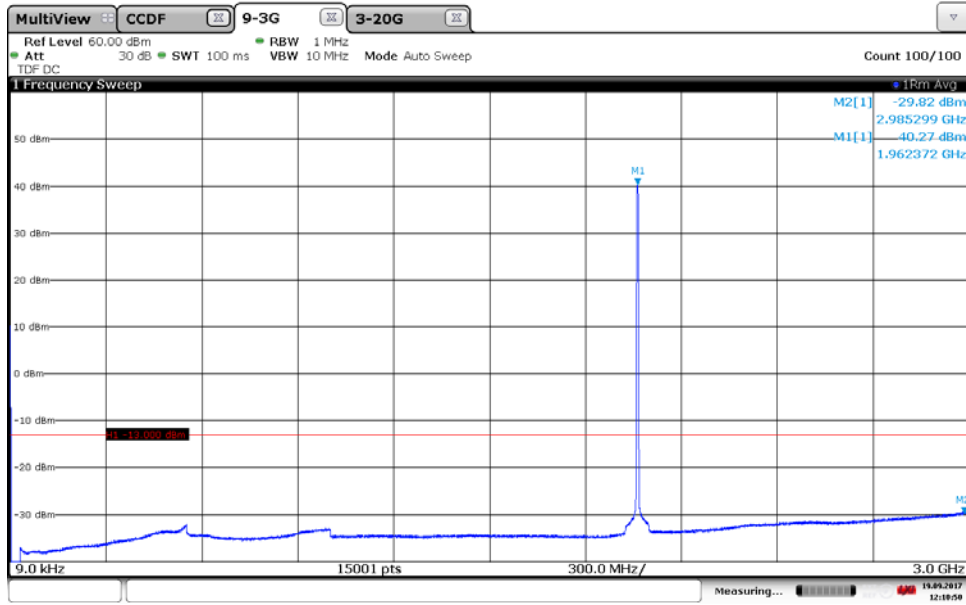

12:10:51 19.09.2017

Diagram 4b:

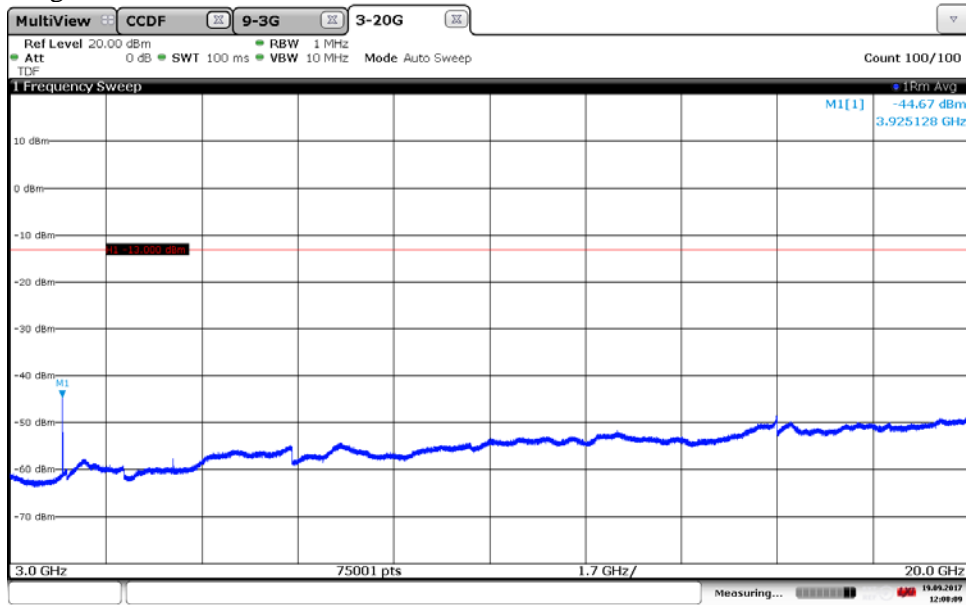

12:08:09 19.09.2017

Diagram 5a:

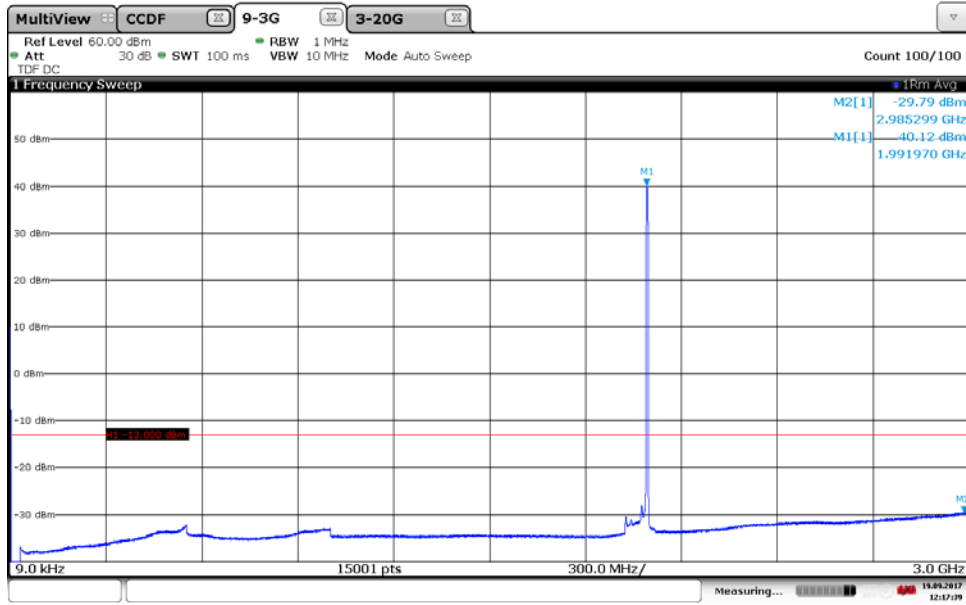

12:17:40 19.09.2017

Diagram 5b:

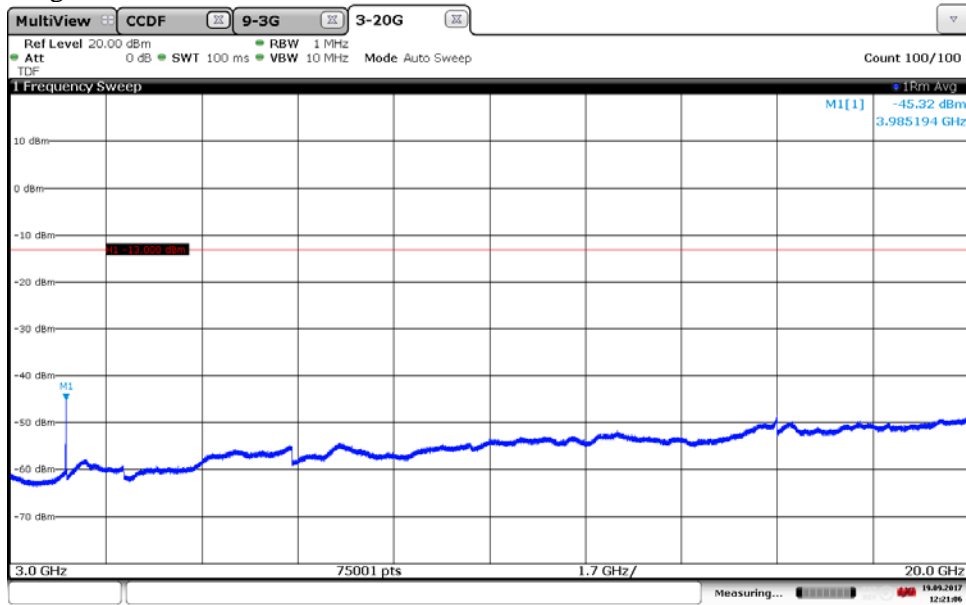

12:21:07 19.09.2017

Diagram 6a:

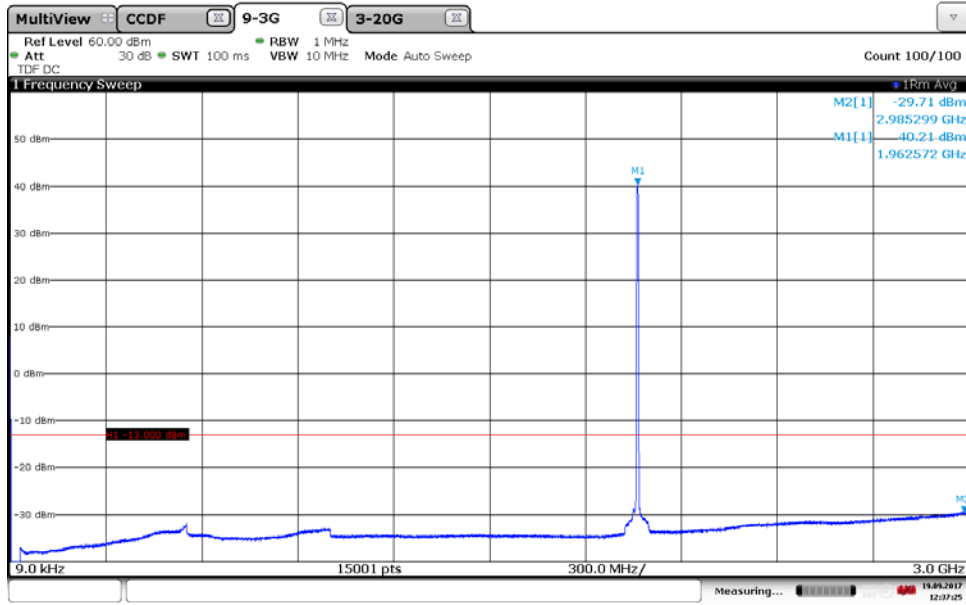

12:37:26 19.09.2017

Diagram 6b:

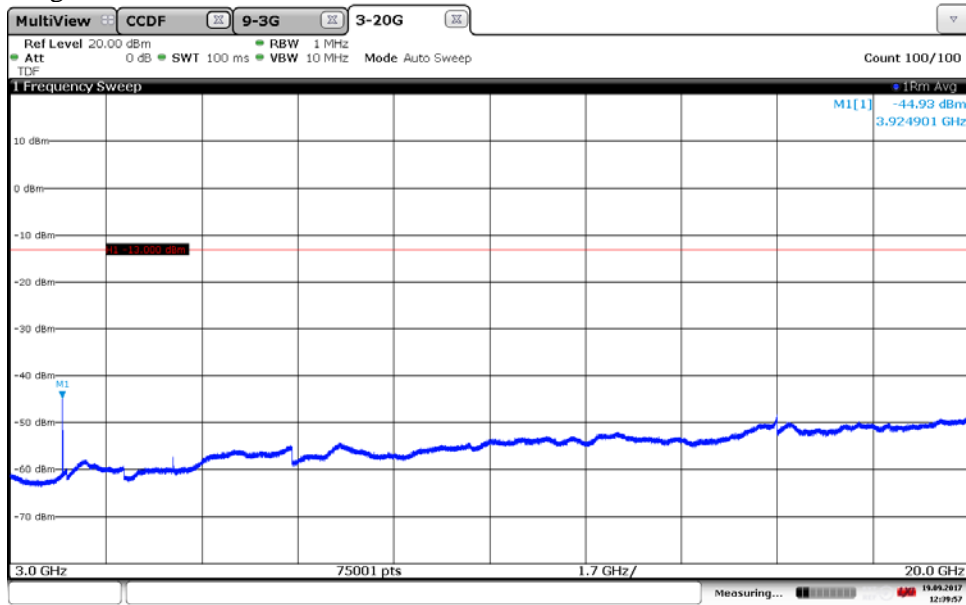

12:39:57 19.09.2017

Diagram 7a:

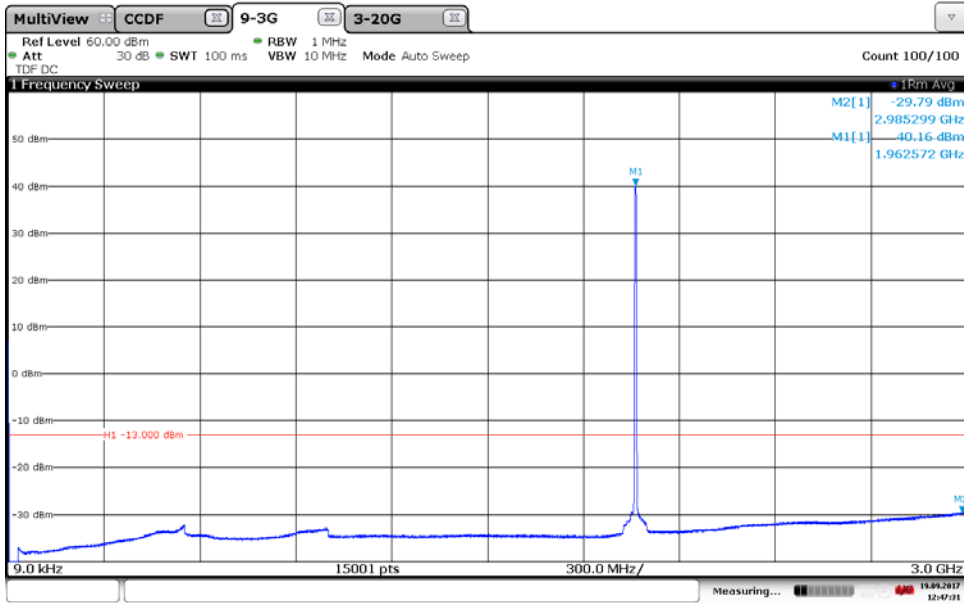

12:47:31 19.09.2017

Diagram 7b:

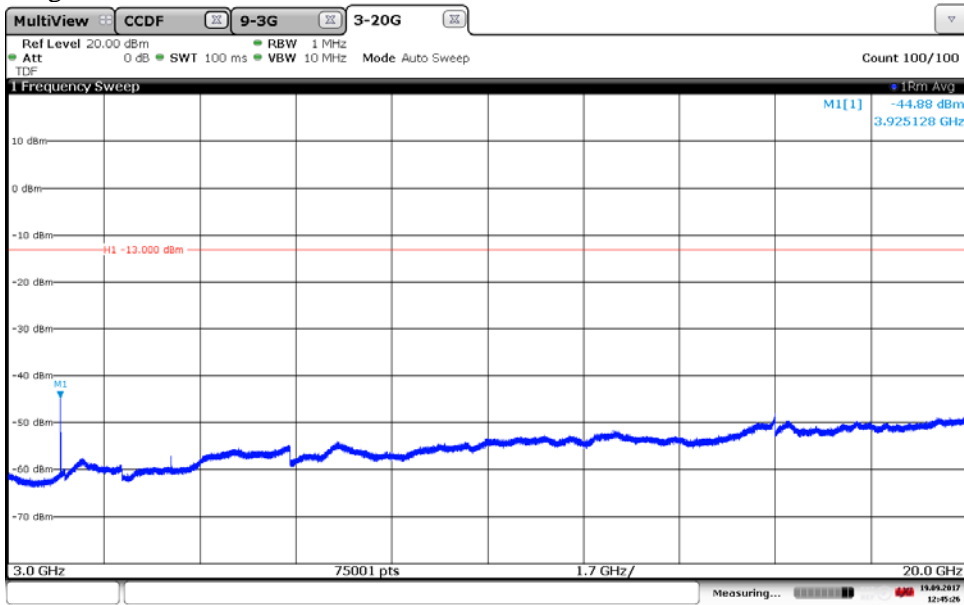

12:45:26 19.09.2017

Diagram 8a:

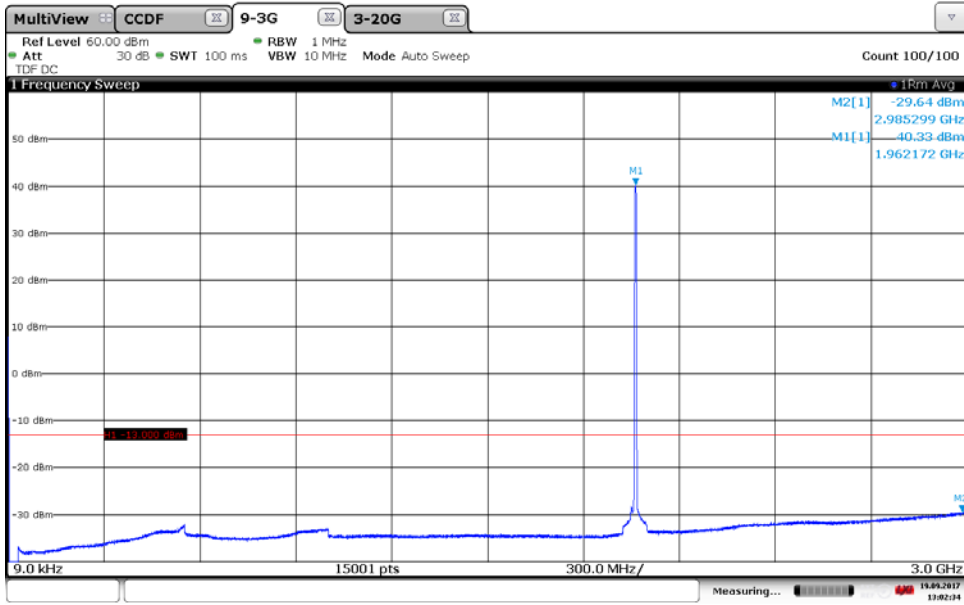

13:02:34 19.09.2017

Diagram 8b:

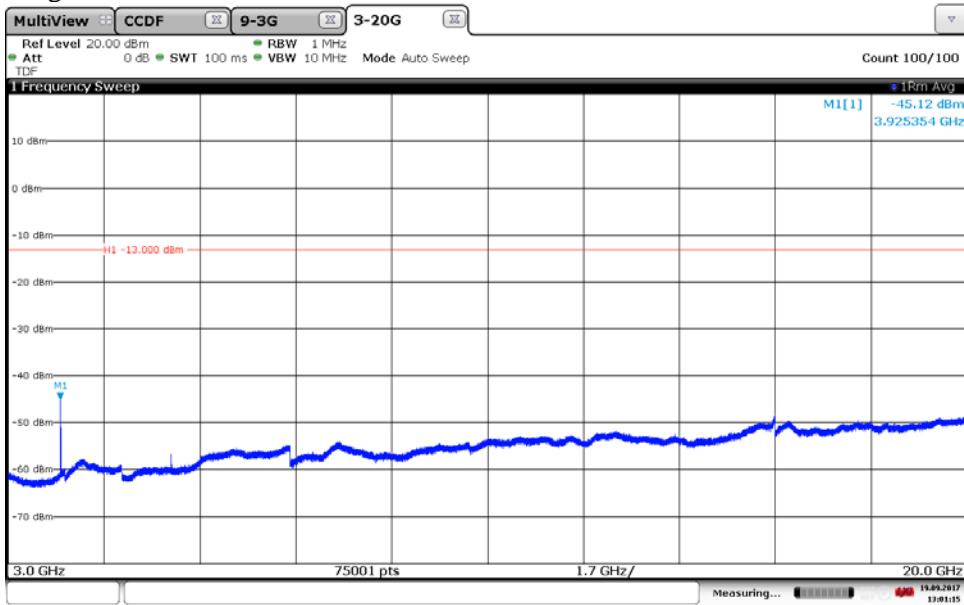

13:01:15 19.09.2017

Diagram 9a:

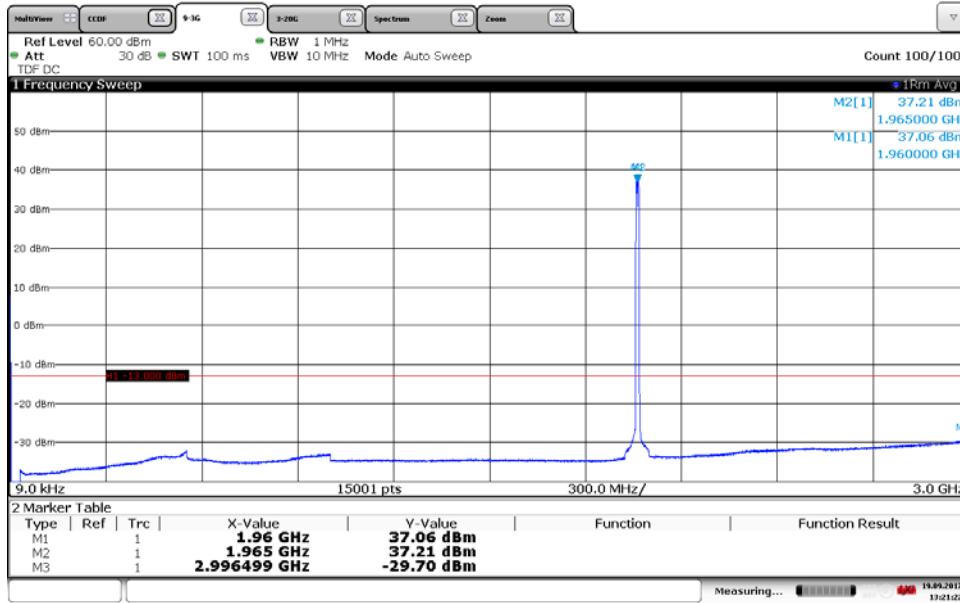

13:21:22 19.09.2017

Diagram 9b:

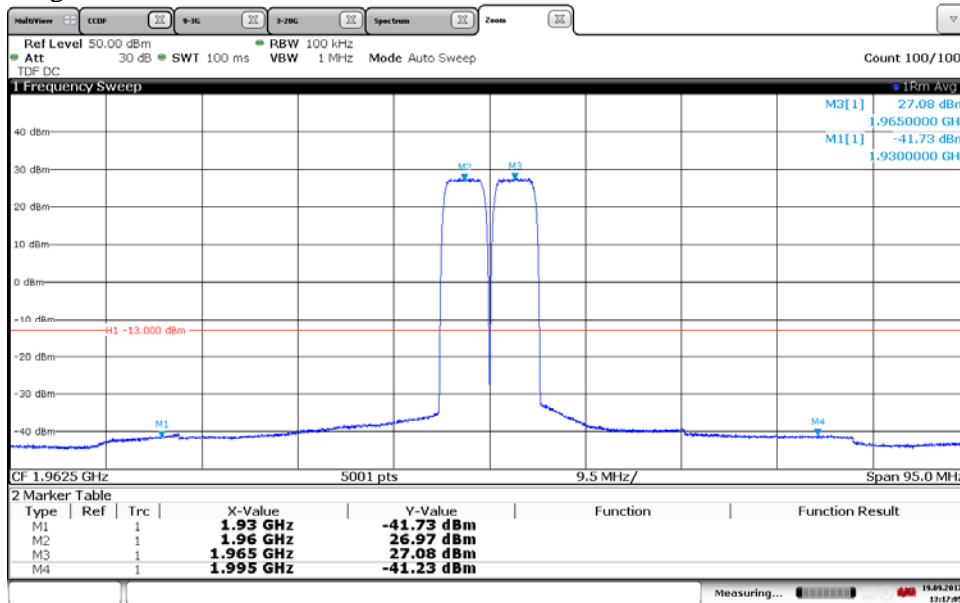

13:17:06 19.09.2017

Note: Due to the use of reduced measurement bandwidth the limit should be adjusted by 10 dB to -23 dBm.

Diagram 9c:

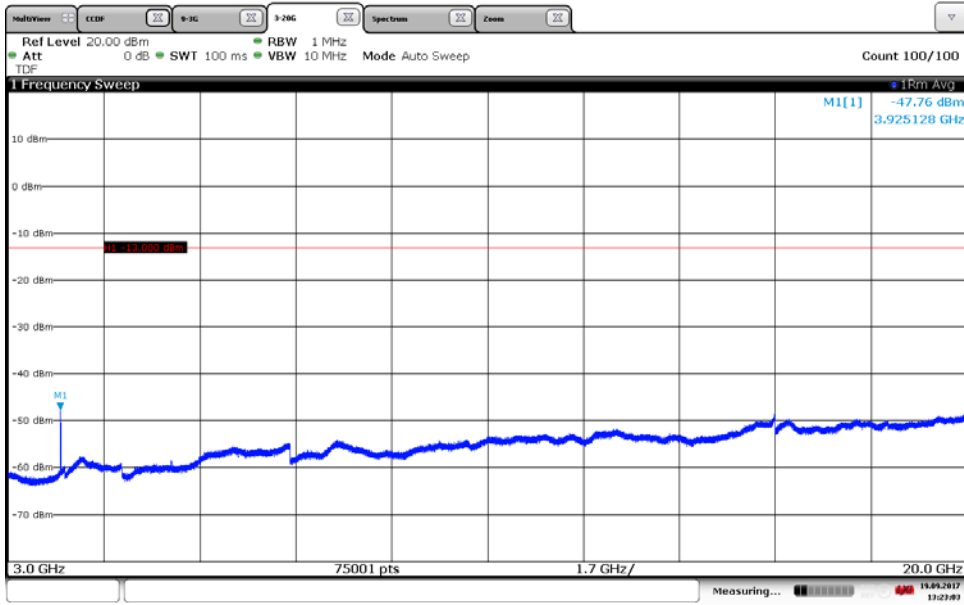

13:23:03 19.09.2017

Diagram 10a:

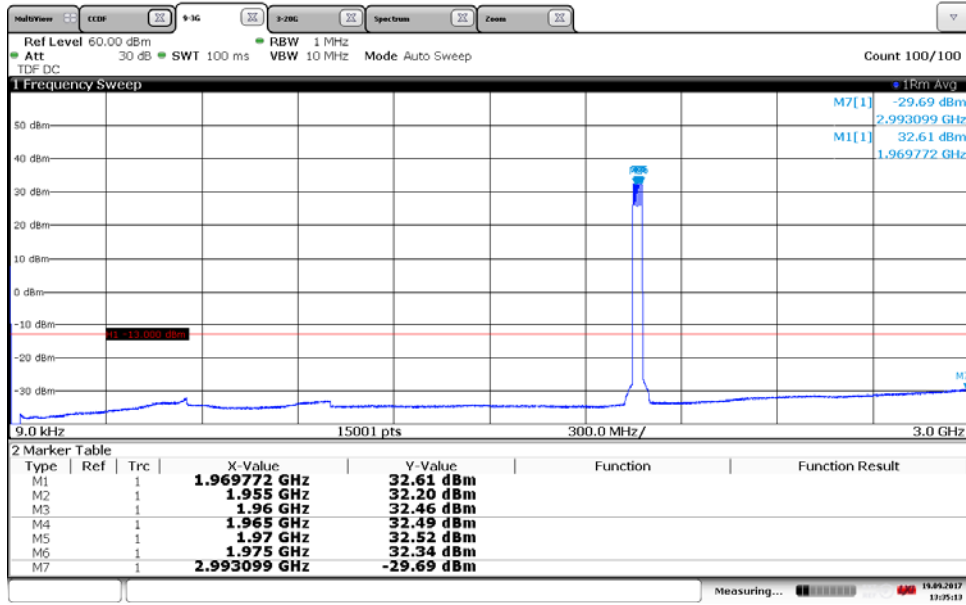

13:35:14 19.09.2017

Diagram 10b:

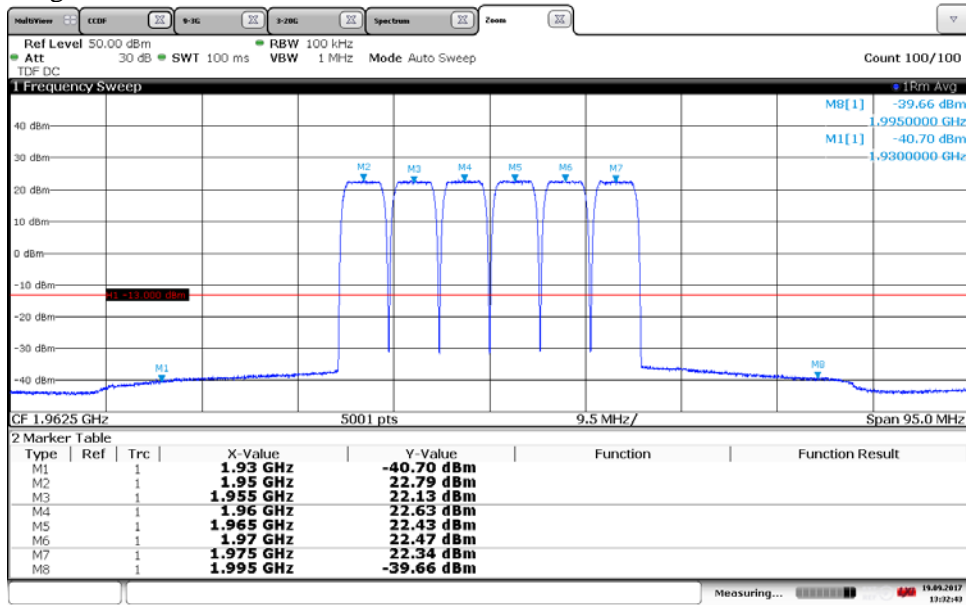

13:32:44 19.09.2017

Note: Due to the use of reduced measurement bandwidth the limit should be adjusted by 10 dB to -23 dBm.

Diagram 10c:

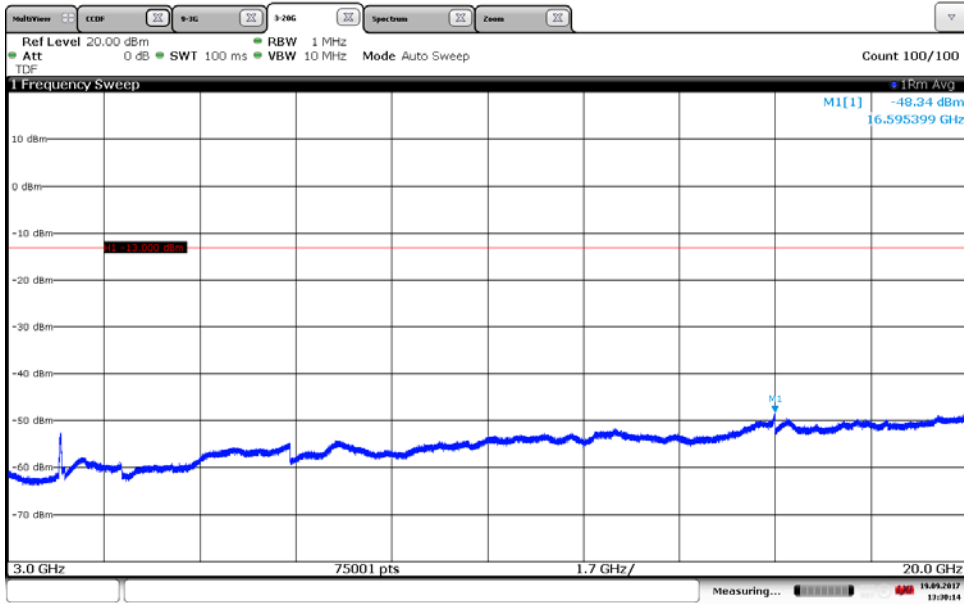

13:30:15 19.09.2017

Diagram 11a:

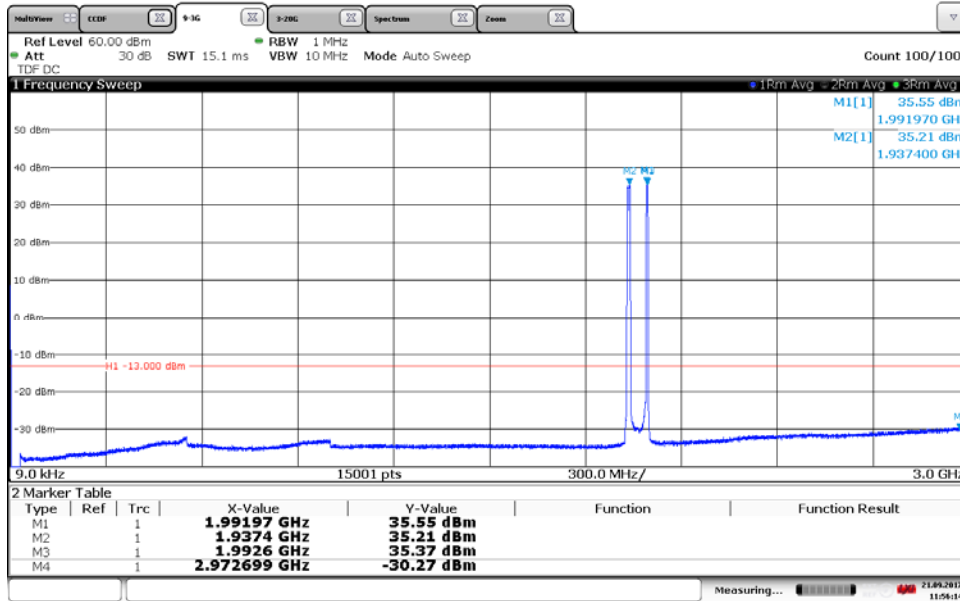

11:56:14 21.09.2017

Diagram 11b:

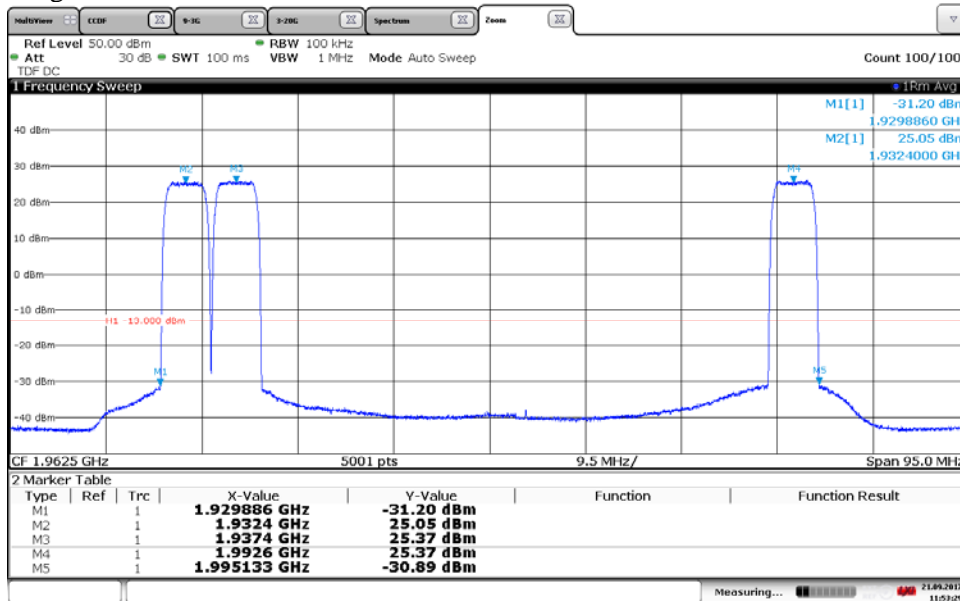

11:53:29 21.09.2017

Note: Due to the use of reduced measurement bandwidth the limit should be adjusted by 10 dB to -23 dBm.

Diagram 11c:

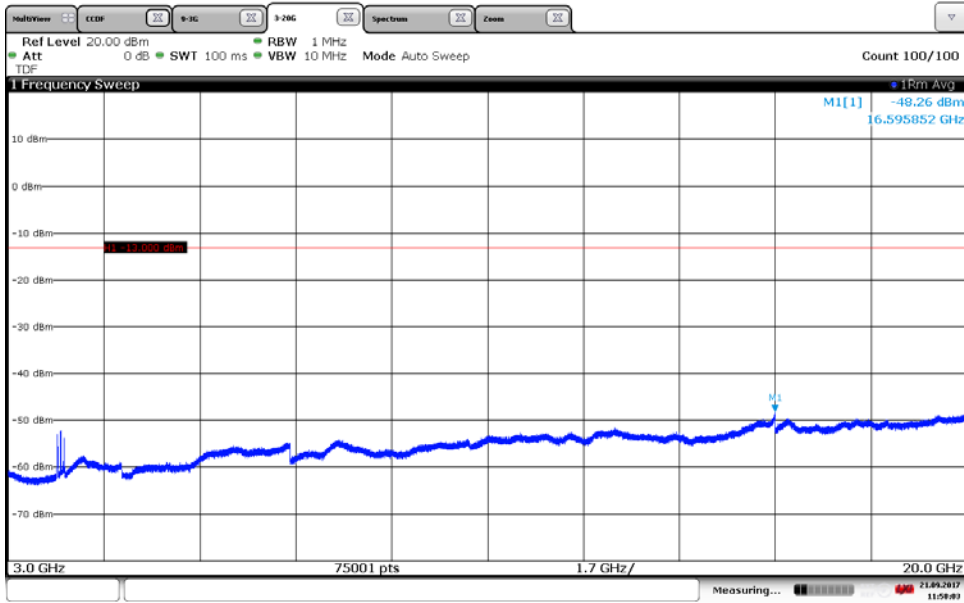

11:58:03 21.09.2017

Diagram 12a:

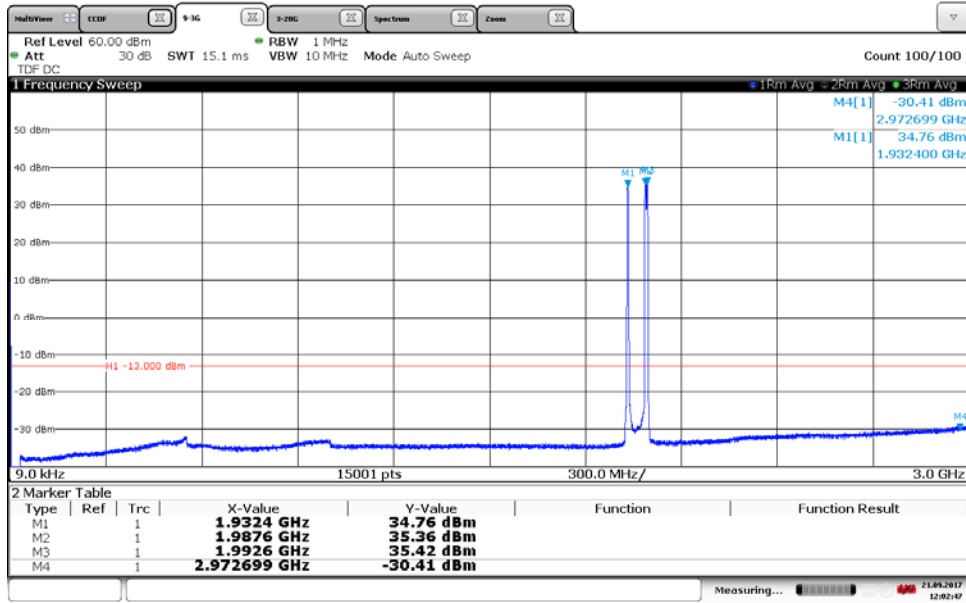

12:02:40 21.09.2017

Diagram 12b:

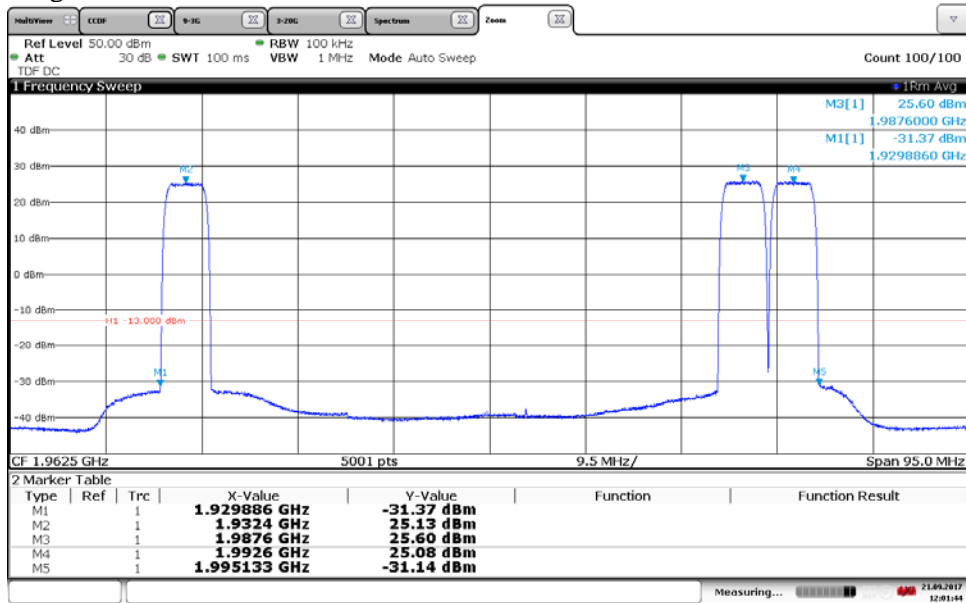

12:01:44 21.09.2017

Note: Due to the use of reduced measurement bandwidth the limit should be adjusted by 10 dB to -23 dBm.

Diagram 12c:

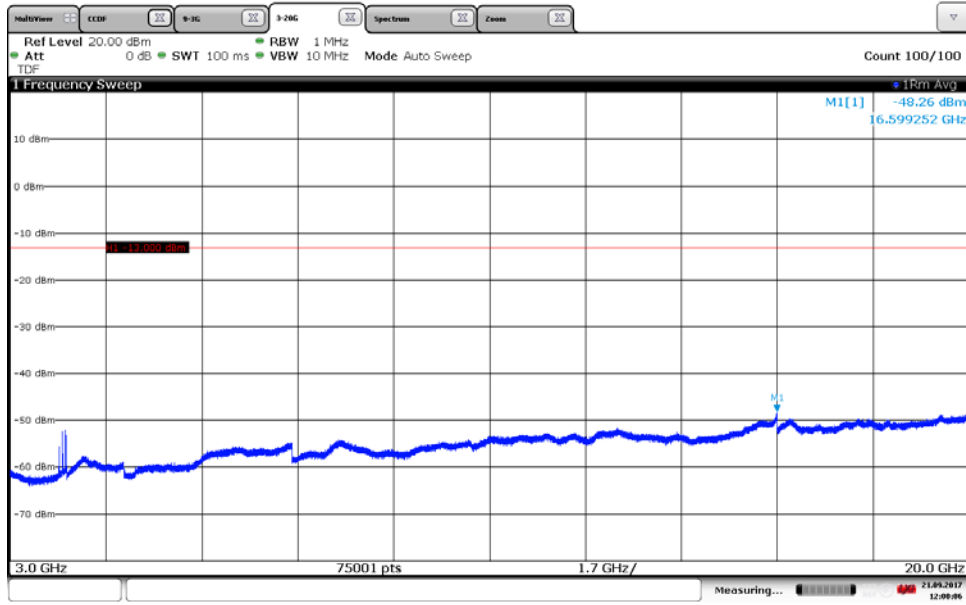

12:00:06 21.09.2017

Field strength of spurious radiation measurements according to CFR 47 §2.1053 / IC RSS-133 6.5

Date	Temperature	Humidity
2017-09-14	22 °C ± 3 °C	45 % ± 5 %
2017-10-03	22 °C ± 3 °C	47 % ± 5 %
2017-10-04	23 °C ± 3 °C	38 % ± 5 %
2017-10-05	22 °C ± 3 °C	34 % ± 5 %

The test site conform to the site validation criterion specified in ANSI C63.4 2014. The test site complies with RSS-Gen, Industry Canada file no. 3482A-1.

The measurements were performed with both horizontal and vertical polarization of the antenna. The antenna distance was 3 m in the frequency range 30 MHz – 18 GHz and 1 m in the frequency range 18 GHz – 20 GHz.

RF absorbers were covering a floor area in the frequency range 1 GHz – 18 GHz to comply with site validation requirements according to ANSI C63.4-2014.

The EUT was placed 0.8 m above reference ground plane in frequency range 30 MHz – 1 GHz and 1.5 m above reference ground plane in frequency range 1 GHz – 20 GHz.

The measurement was performed with a RBW of 1 MHz.

A propagation loss in free space was calculated. The used formula was

$$\gamma = 20 \log \left(\frac{4\pi D}{\lambda} \right), \gamma \text{ is the propagation loss and } D \text{ is the antenna distance.}$$

The measurement procedure was as the following:

1. A pre-measurement is performed with peak detector. For measurement < 1 GHz the test object was measured in eight directions with the antenna at three heights, 1.0 m, 1.5 m and 2.0 m. For measurements > 1 GHz the test object was measured in seventeen directions with the antenna height 1.0 m, 1.5 m and 2m.
2. Spurious radiation on frequencies closer than 20 dB to the limit in the pre-measurement is scanned 0-360 degrees and the antenna is scanned 1- 4 m for maximum response. The emission is then measured with the RMS detector and the RMS value is reported. Frequencies closer than 10 dB to the limit when measured with the RMS detector were measured with the substitution method according to ANSI 63.26.

The test set-up during the spurious radiation measurements is shown in the picture below:
30-1000 MHz



1-18GHz

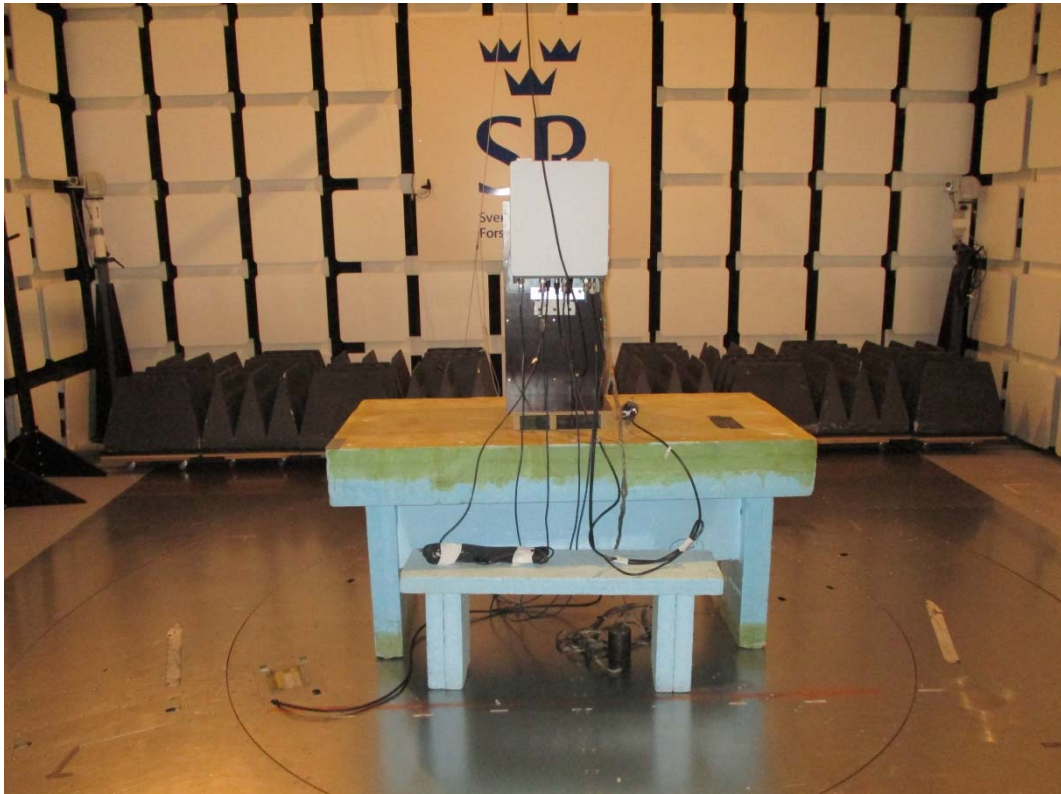

Measurement equipment

Measurement equipment	RISE number
Semi anechoic chamber Tesla	503 881
R&S ESU 40	901 385
EMC 32 ver. 9.15.0	BX62351
ETS Lindgren BiConiLog 3142E	BX61914
ETS Lindgren Horn Antenna 3115	502 175
Flann STD Gain Horn Antenna 20240-20	503 674
µComp Nordic, Low Noise Amplifier	901 545
Miteq, Low Noise Amplifier	503 278
HP Filter 3-26.5 GHz	901 502
Temperature and humidity meter, Testo 625	504 188

Results

Tested configurations: B, M, T, M2, Bim and Tim
representing worst case: Symbolic name M,TM 5, Diagram 1 a-d

Frequency (MHz)	Spurious emission level (dBm)	
	Vertical	Horizontal
30-20000	All emission > 20 dB below limit	All emission > 20 dB below limit

Measurement uncertainty: 3.1 dB

Limits

CFR 47 §24.238 and IC RSS-133 6.5

(g) Outside a licensee's frequency band(s) of operation the power of any emission shall be attenuated below the transmitter power (P) by at least $43 + 10 \log (P)$ dB, resulting in a limit of -13 dBm.

Complies?	Yes
-----------	-----

Diagram 1a:

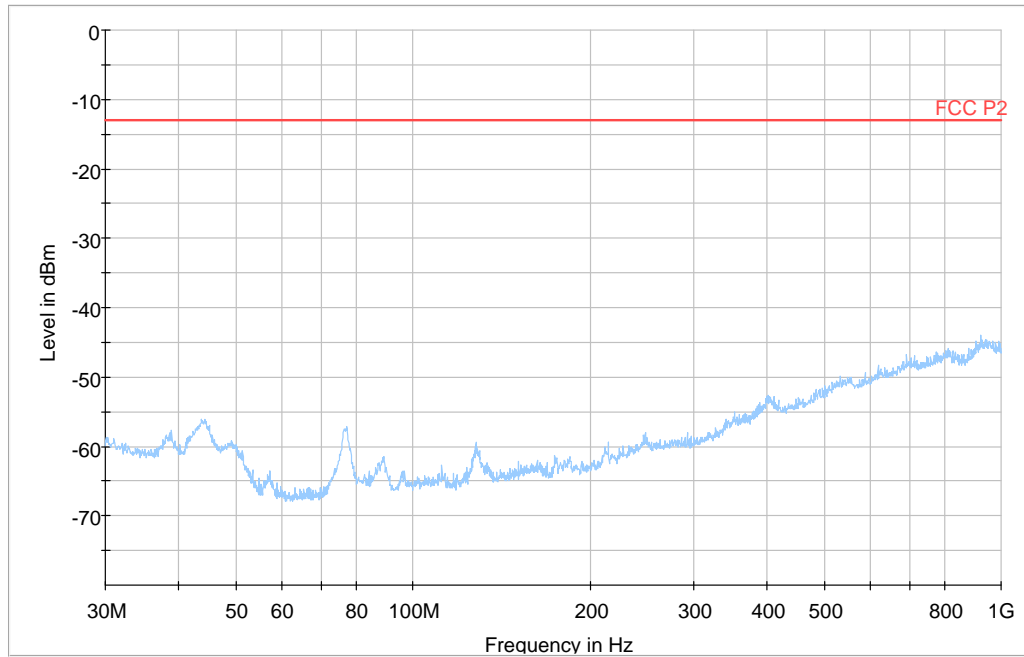
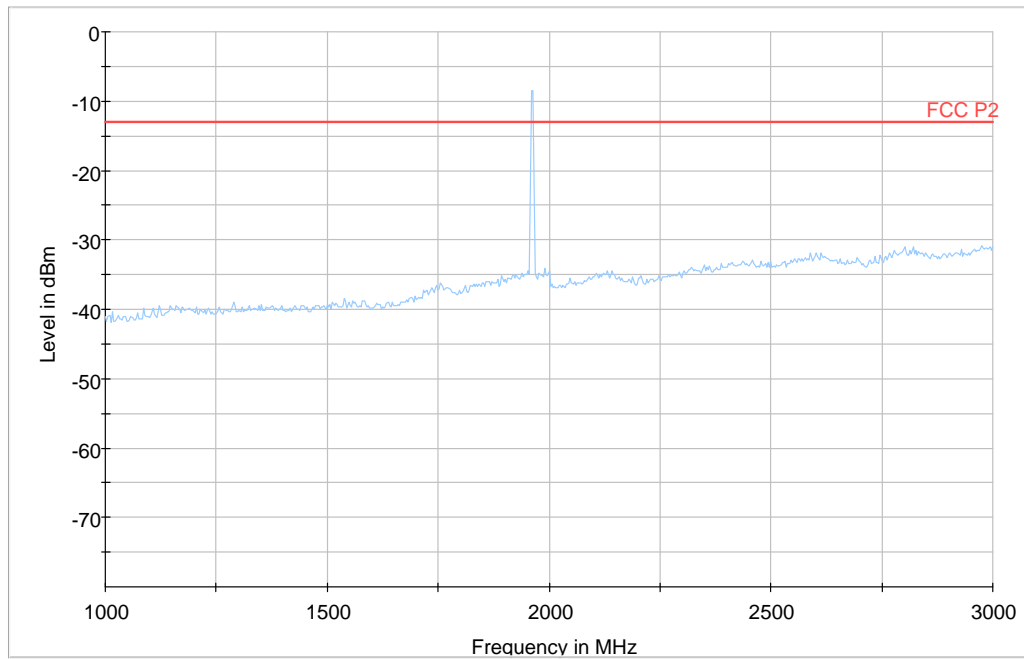
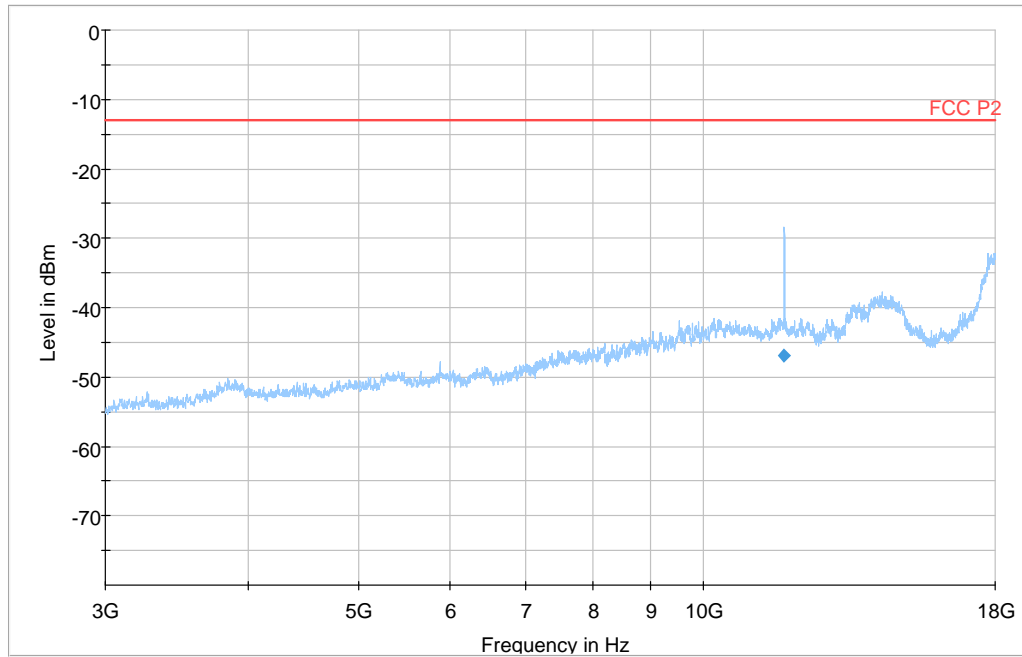

Diagram 1b:



Note: The emission at 1962.5 MHz is the carrier frequency and shall be ignored in the context.

Diagram 1c:



Final Result

Frequency (MHz)	RMS (dBm)	MaxPeak (dBm)	Limit (dBm)	Margin (dB)	Meas. Time (ms)	Bandwidth (kHz)	Height (cm)	Pol	Azimuth (deg)
11773.365384	-47.00	---	-13.00	34.00	5000.0	1000.000	326.0	H	301.0
11773.365384	---	-31.70	---	---	5000.0	1000.000	326.0	H	301.0

Diagram 1d:

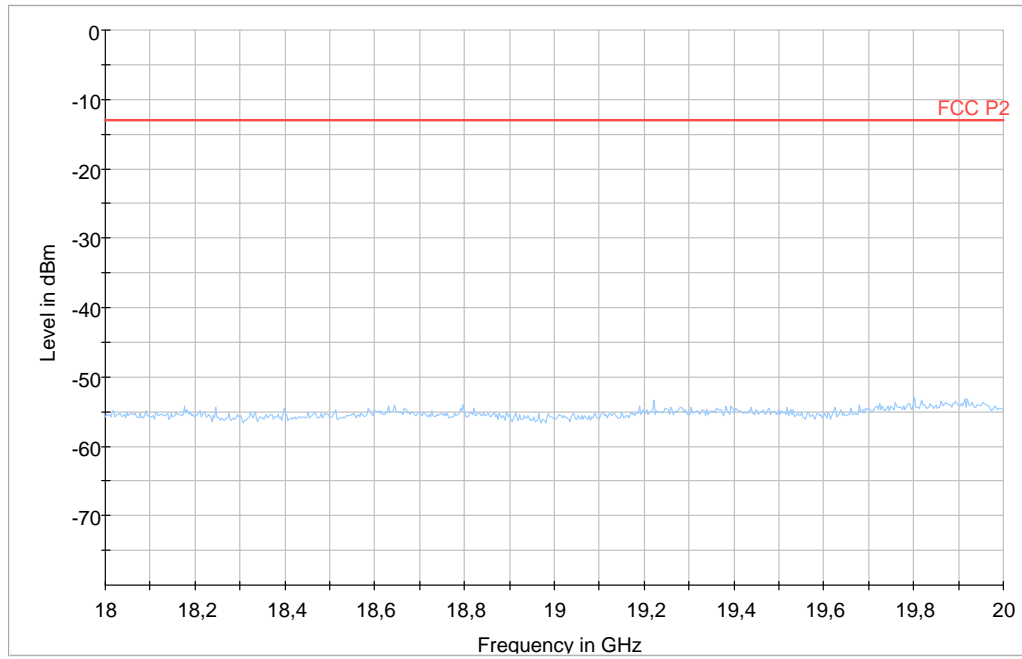

Frequency stability measurements according to CFR 47 § 24.235 / IC RSS 133 6.3

Date	Temperature (test equipment)	Humidity (test equipment)
2017-10-12	23 °C ± 3 °C	35% ± 5 %
2017-10-13	22 °C ± 3 °C	20% ± 5 %
2017-10-15	23 °C ± 3 °C	36% ± 5 %

Test set-up and procedure

The measurement was made per 3GPP TS 25.141. The output was connected to a spectrum analyser. The spectrum analyser was connected to an external 10 MHz reference standard during the measurements.

The measurement was also made per IC RSS 199 Issue 3, 4.3. Using a resolution bandwidth of 1% of the emission bandwidth, a reference point at the unwanted emission level which complies with the attenuation of $43 + 10 \log_{10} p$ (watts) (i.e. -13 dBm) (for 2x(2x 2) MIMO -19 dBm) at the band edge of the lowest and highest channel was selected, and the frequency at these points was recorded as fL and fH respectively.

Measurement equipment	RISE number
R&S FSQ 40	504 143
Rohde & Schwarz signal analyzer FSW 43	902 073
RF attenuator	900 691
Temperature Chamber	503 360
Testo 635, temperature and humidity meter	504 203
Multimeter Fluke 87	502 190

Results

Nominal transmitter frequency was 1960 MHz (M) with a TM 1. Rated output power level at connector RF A (maximum): 46 dBm.

Test conditions		Frequency error (Hz)
Supply voltage DC (V)	Temp. (°C)	
40.8	+20	8
55.2	+20	7
48	+20	8
48	+30	8
48	+40	7
48	+50	8
48	+10	9
48	0	7
48	-10	-8
48	-20	11
48	-30	7
Maximum freq. error (Hz)		11
Measurement uncertainty		$< \pm 1 \times 10^{-7}$

Rated output power level at connector RF B (maximum): 46 dBm

Test conditions			Frequency margin to band edge at -19dBm			
Supply voltage DC [V]	Temp [°C].	Carrier Bandwidth [MHz]	Test frequency Symbolic name Bottom		Test frequency Symbolic name Top	
			fL [MHz]	Offset to lower band edge (1930 MHz) [kHz]	fH [MHz]	Offset to upper band edge (1995 MHz) [kHz]
-48.0	+20	5	1930.007	7	1994.993	7

The frequency error results clearly shows that the frequency stability is good enough to ensure that the transmitted carrier stay within the operating band.

Remark

It was deemed sufficient to test one combination of TX frequency, channel bandwidth configuration and test model (modulation), as all combinations share a common internal reference to derive the TX frequency from.

Limits

CFR 47 §24.235

The frequency stability shall be sufficient to ensure that the fundamental emission stays within the authorized frequency block.

RSS-133 6.3 Frequency stability:

The carrier frequency shall not depart from the reference frequency in excess of ± 1.0 ppm (± 1930 Hz) for base stations when tested to the temperature and supply voltage variations specified in RSS-Gen.

Complies?	Yes
-----------	-----

Photos of test object

Front side



Rear side



Left side



Right side

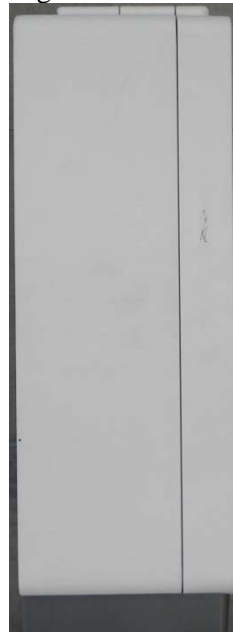

Bottom side



Top side



