



www.boschsecurity.com

**en**

For the RADION PIR ZB text-based installation guide and other documentation, go to: [www.boschsecurity.com](http://www.boschsecurity.com)

**cs**

Chcete-li získat textovou instalační příručku a další dokumentaci k produktu RADION PIR ZB, navštivte stránky: [www.boschsecuritysystems.cz](http://www.boschsecuritysystems.cz)

**da**

Hvis du ønsker tekstbaseret installationsvejledning og anden dokumentation til RADION PIR ZB, skal du gå til: [www.boschsecurity.com](http://www.boschsecurity.com)

**de**

Eine textbasierte Installationsanleitung und weitere Dokumentationen zu RADION PIR ZB finden Sie unter [www.boschsecurity.com](http://www.boschsecurity.com)

**el**

Για τον οδηγό εγκατάστασης βάσει κειμένου RADION PIR ZB και άλλο υλικό τεκμηρίωσης, μεταβείτε στη διεύθυνση: [www.boschsecurity.com](http://www.boschsecurity.com)

**es**

Para consultar la guía de instalación de RADION PIR ZB en texto y otra documentación, vaya a: [www.boschsecurity.com](http://www.boschsecurity.com)

**fi**

Tekstipohjaisen asennusoppaan RADION PIR ZB ja muun dokumentaation saat osoitteesta: [www.boschsecurity.com](http://www.boschsecurity.com)

**fr**

Pour accéder au guide d'installation au format texte RADION PIR ZB et à d'autres documentations, connectez-vous à l'adresse : [www.boschsecurity.com](http://www.boschsecurity.com)

**hu**

Az RADION PIR ZB szöveges telepítési útmutatója és a további dokumentáció a következő címen érhető el: [www.boschsecurity.com](http://www.boschsecurity.com)

**it**

Per la guida all'installazione basata su testo di RADION PIR ZB e altra documentazione, visitare il sito: [www.boschsecurity.com](http://www.boschsecurity.com)

**no**

Hvis du vil ha den tekstbaserte installasjonsveiledningen for RADION PIR ZB og annen dokumentasjon, gå til: [www.boschsecurity.com](http://www.boschsecurity.com)

**nl**

Voor de installatiehandleiding en andere documentatie van RADION PIR ZB gaat u naar: [www.boschsecurity.com](http://www.boschsecurity.com)

**pl**

Przewodnik po instalacji urządzenia RADION PIR ZB i inne dokumenty dostępne są w witrynie: [www.boschsecurity.pl](http://www.boschsecurity.pl)

**pt-br**

Para consultar o guia de instalação baseado em texto RADION PIR ZB e outras documentações, visite: [www.boschsecurity.com](http://www.boschsecurity.com)

**pt**

Para obter o guia de instalação baseado em texto e outra documentação do RADION PIR ZB, consulte: [www.boschsecurity.com](http://www.boschsecurity.com)

**ru**

Руководство по установке RADION PIR ZB и другую документацию см. на сайте [www.boschsecurity.com](http://www.boschsecurity.com)

**sv**

För RADION PIR ZB textbaserad installationsguide och annan dokumentation, gå till: [www.boschsecurity.com](http://www.boschsecurity.com)

**tr**

RADION PIR ZB metin tabanlı kurulum kılavuzu ve diğer belgeler için şu adresi ziyaret edin: : [www.boschsecurity.com](http://www.boschsecurity.com)

**zh-CHS**

有关基于RADION PIR ZB文本的安装指南和其他文档，请转到：[www.boschsecurity.com](http://www.boschsecurity.com)

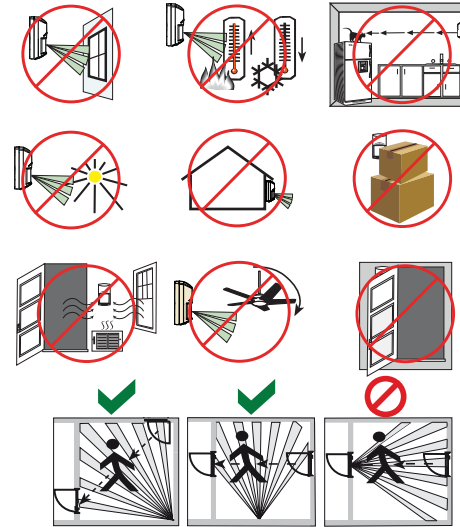

≤ 20 kg (45 lb)

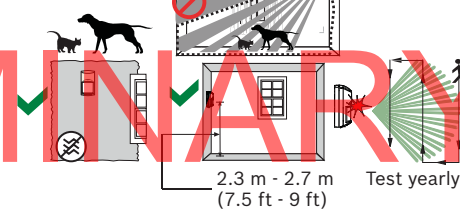

#### Copyright

This document is the intellectual property of Bosch Security Systems, Inc. and is protected by copyright. All rights reserved.

#### Trademarks

All hardware and software product names used in this document are likely to be registered trademarks and must be treated accordingly.

#### Bosch Security Systems, Inc. product manufacturing dates

Use the serial number located on the product label and refer to the Bosch Security Systems, Inc. website at <http://www.boschsecurity.com/datecodes/>



#### RADION PIR ZB

Wireless Motion Detector  
RFPR-ZB/RFPR-ZB-EU/RFPR-ZB-CHI  
RFPR-ZB-ES/RFPR-ZB-MS



**cz** Instalační příručka  
**da** Installationsanvisning  
**de** Installationshandbuch  
**el** Οδηγός εγκατάστασης  
**en** Installation Guide  
**es** Manual de instalación  
**fi** Asennusopas  
**fr** Guide de l'installateur  
**hu** Telepítési útmutató  
**it** Manuale di installazione  
**nl** Installatiehandleiding  
**no** Installasjonsveiledning  
**pt** Guia de Instalação  
**pt-BR** Guia de Instalação  
**pl** Przewodnik instalacji  
**ru** Руководство по установке  
**sv** Installationsguide  
**tr** Montaj Kılavuzu  
**zh-CHS** 安装指南

Bosch Security Systems, Inc.  
130 Perinton Parkway  
Fairport, NY 14450  
USA

[www.boschsecurity.com](http://www.boschsecurity.com)

Bosch Sicherheitssysteme GmbH  
Robert-Bosch-Ring 5  
85630 Grasbrunn  
Germany

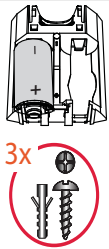

1 |

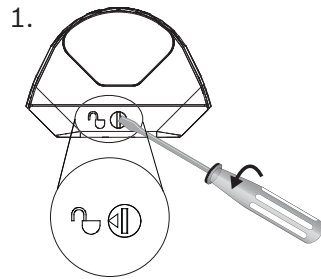

2.

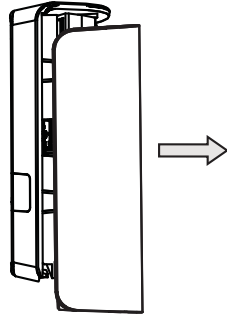

2 |

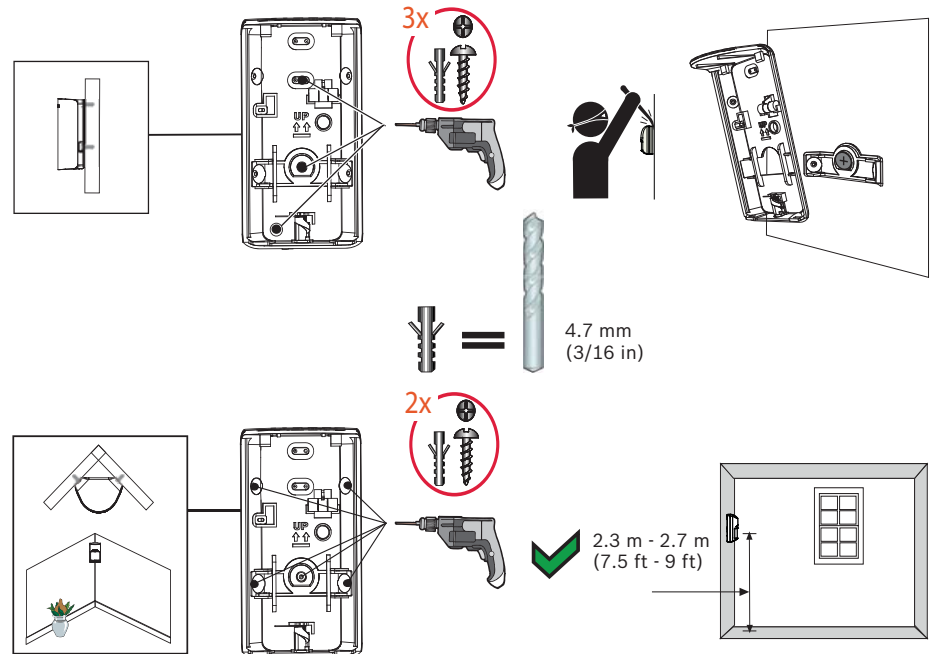

3 |

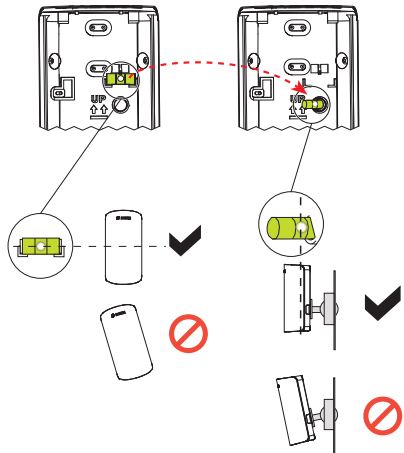

4 |

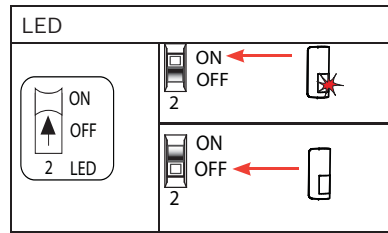

5 |

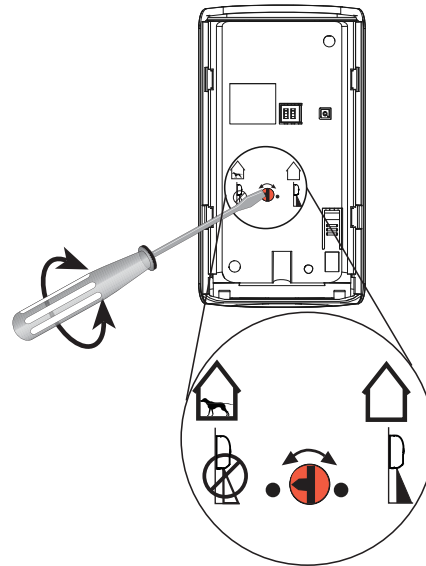

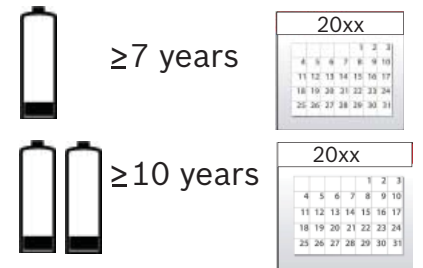
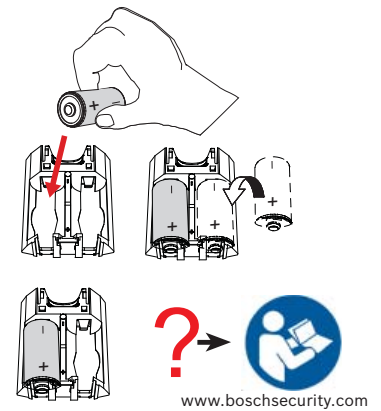

6 |



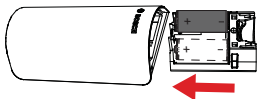
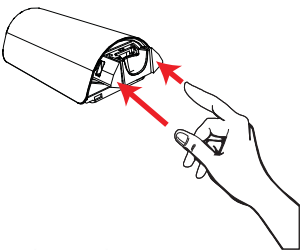

PRELIMINARY

7 |

1. 
2. 

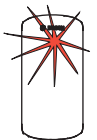
3.  = "Click"

4.  =  2 sec

8 |

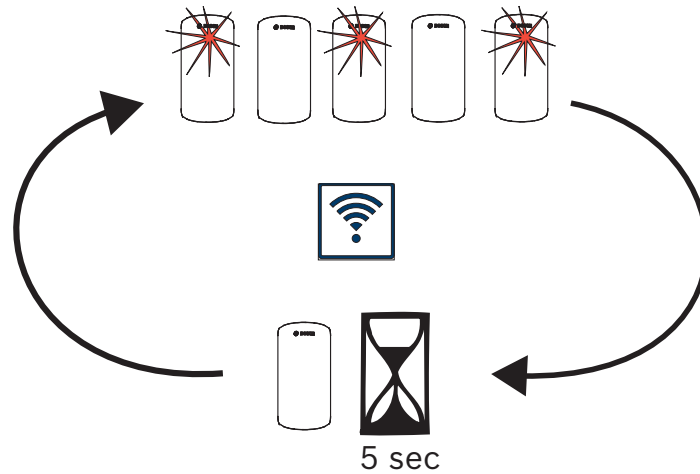

PRELIMINARY

9 |

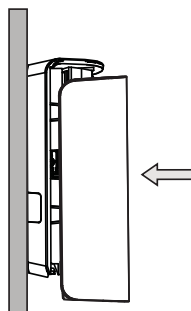
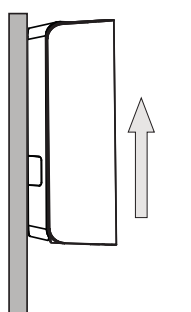

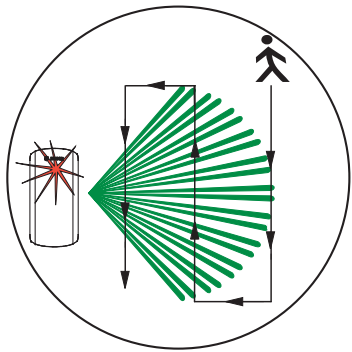

1. 
2. 

10 |

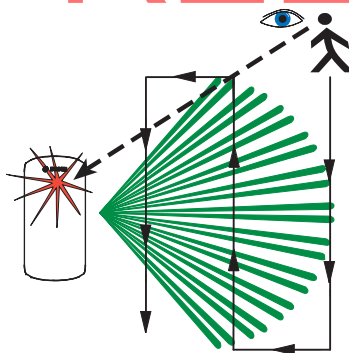

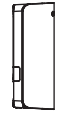
11 |

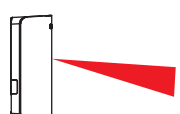



	=		
	=		

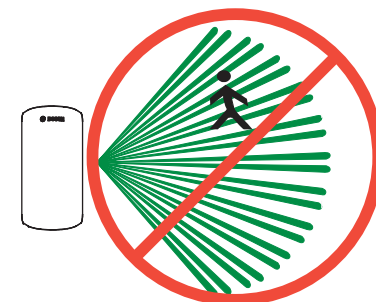

12 |



 90 sec

Region	Agency	Certification
US and Canada		Control No.3170792 Conforms to ANSI/UL Std. 639 Conforms to ULC Std. S306-03
	FCC	FCC Part 15 Class B
	IC	1249A-PRZB
		This ZigBee® Certified product works in global 2.4 GHz networks supporting ZigBee HA 1.2. ZigBee® Certified is a registered trademark of the ZigBee Alliance. ZigBee Cert No.xxxx

Changes or modifications not expressly approved by Bosch Security Systems, Inc. can void the user's authority to operate the equipment.

#### FCC/IC

This device complies with part 15 of the FCC Rules and Industry Canada licence-exempt RSS standard(s). Operation is subject to the following two conditions:

- (1) this device may not cause interference, and
- (2) this device must accept any interference, including interference that may cause undesired operation of the device.

Le présent appareil est conforme aux CNR d'Industrie Canada applicables aux appareils radio exempts de licence. L'exploitation est autorisée aux deux conditions suivantes :

- (1) l'appareil ne doit pas produire de brouillage, et
- (2) l'utilisateur de l'appareil doit accepter tout brouillage radioélectrique subi, même si le brouillage est susceptible d'en compromettre le fonctionnement.

Under Industry Canada regulations, this radio transmitter may only operate using an antenna of a type and maximum (or lesser) gain approved for the transmitter by Industry Canada. To reduce potential radio interference to other users, the antenna type and its gain should be so chosen that the equivalent isotropically radiated power (e.i.r.p.) is not more than that necessary for successful communication.

Conformément à la réglementation d'Industrie Canada, le présent émetteur radio peut fonctionner avec une antenne d'un type et d'un gain maximal (ou inférieur) approuvé pour l'émetteur par Industrie Canada.

Dans le but de réduire les risques de brouillage radioélectrique à l'intention des autres utilisateurs, il faut choisir le type d'antenne et son gain de sorte que la puissance isotrope rayonnée équivalente (p.i.r.e.) ne dépasse pas l'intensité nécessaire à l'établissement d'une communication satisfaisante.

#### Optional Brackets: B338, B335

A mounting bracket can reduce the detector's range and create dead zones.

Not investigated by ETL.

Not EN50131 compliant.

La certificazione IMQ decade nel caso di installazione del rilevatore con gli snodi opzionali.

#### Small animal immunity

The small animal immunity feature was not investigated by ETL.

Nicht für VdS Anlagen.

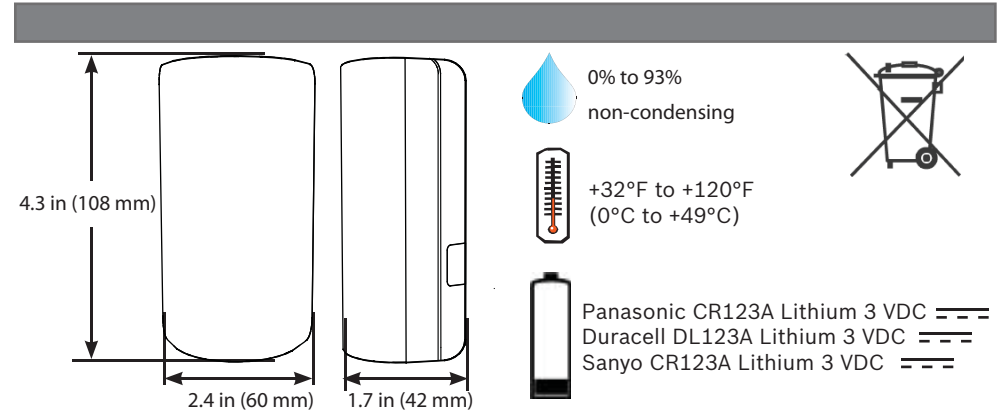

4.3 in (108 mm)

2.4 in (60 mm)    1.7 in (42 mm)

0% to 93% non-condensing

+32°F to +120°F (0°C to +49°C)

Panasonic CR123A Lithium 3 VDC  
Duracell DL123A Lithium 3 VDC  
Sanyo CR123A Lithium 3 VDC

PRELIMINARY

