



FCC Test Report

APPLICANT : ZTE CORPORATION
EQUIPMENT : WCDMA/LTE Multi-mode Digital
Mobile Phone
BRAND NAME : ZTE
MODEL NAME : Z798BL
FCC ID : SRQ-Z798BL
STANDARD : FCC 47 CFR FCC Part 15 Subpart B
CLASSIFICATION : Certification

The product was received on Sep. 26, 2016 and testing was completed on Nov. 30, 2016. We, SPORTON INTERNATIONAL (KUNSHAN) INC., would like to declare that the tested sample has been evaluated in accordance with the test procedures given in ANSI C63.4-2014 and has been in compliance with the applicable technical standards.

The test results in this report apply exclusively to the tested model / sample. Without written approval of SPORTON INTERNATIONAL (KUNSHAN) INC., the test report shall not be reproduced except in full.

Prepared by: James Huang / Manager

Approved by: Jones Tsai / Manager



SPORTON INTERNATIONAL (KUNSHAN) INC.
No. 3-2, PingXiang Road, Kunshan, Jiangsu Province, P. R. China



TABLE OF CONTENTS

REVISION HISTORY.....3

SUMMARY OF TEST RESULT4

1. GENERAL DESCRIPTION5

 1.1. Applicant.....5

 1.2. Manufacturer5

 1.3. Product Feature of Equipment Under Test5

 1.4. Product Specification of Equipment Under Test6

 1.5. Modification of EUT7

 1.6. Test Location7

 1.7. Applicable Standards7

2. TEST CONFIGURATION OF EQUIPMENT UNDER TEST.....8

 2.1. Test Mode8

 2.2. Connection Diagram of Test System 10

 2.3. Support Unit used in test configuration and system..... 12

 2.4. EUT Operation Test Setup 13

3. TEST RESULT..... 14

 3.1. Test of AC Conducted Emission Measurement 14

 3.2. Test of Radiated Emission Measurement 22

4. LIST OF MEASURING EQUIPMENT26

5. UNCERTAINTY OF EVALUATION27

APPENDIX A. SETUP PHOTOGRAPHS



SUMMARY OF TEST RESULT

Report Section	FCC Rule	Description	Limit	Result	Remark
3.1	15.107	AC Conducted Emission	< 15.107 limits	PASS	Under limit 6.02 dB at 2.567 MHz
0	15.109	Radiated Emission	< 15.109 limits	PASS	Under limit 0.88 dB at 959.900 MHz for Quasi-Peak



1. General Description

1.1. Applicant

ZTE CORPORATION

ZTE Plaza, Keji Road South, Hi-Tech, Industrial Park, Nanshan District, Shenzhen, Guangdong, 518057, P.R.China

1.2. Manufacturer

ZTE CORPORATION

ZTE Plaza, Keji Road South, Hi-Tech, Industrial Park, Nanshan District, Shenzhen, Guangdong, 518057, P.R.China

1.3. Product Feature of Equipment Under Test

Product Feature	
Equipment	WCDMA/LTE Multi-mode Digital Mobile Phone
Brand Name	ZTE
Model Name	Z798BL
FCC ID	SRQ-Z798BL
EUT supports Radios application	GSM/GPRS/EGPRS/WCDMA/HSPA/ HSPA+ (16QAM uplink is not supported)/LTE WLAN 2.4GHz 802.11b/g/n HT20 Bluetooth v3.0 + EDR Bluetooth v4.0 LE/Bluetooth 4.2 LE
IMEI Code	Conduction/Radiation: 862574030006598/862574030006501
HW Version	Z798BLHWV1.0
SW Version	Z798BLV1.0.0B05
EUT Stage	Identical Prototype

Remark: The above EUT's information was declared by manufacturer. Please refer to the specifications or user's manual for more detailed description.



1.4. Product Specification of Equipment Under Test

Standards-related Product Specification	
Tx Frequency	GSM850: 824.2 MHz ~ 848.8 MHz GSM1900: 1850.2 MHz ~ 1909.8MHz WCDMA Band V: 826.4 MHz ~ 846.6 MHz WCDMA Band IV : 1712.4 MHz ~ 1752.6 MHz WCDMA Band II: 1852.4 MHz ~ 1907.6 MHz LTE Band 2 : 1850.7 MHz ~ 1909.3 MHz LTE Band 4 : 1710.7 MHz ~ 1754.3 MHz LTE Band 5 : 824.7 MHz ~ 848.3 MHz LTE Band 12: 699.7 MHz ~ 715.3 MHz 802.11b/g/n: 2412 MHz ~ 2462 MHz Bluetooth: 2402 MHz ~ 2480 MHz
Rx Frequency	GSM850: 869.2 MHz ~ 893.8 MHz GSM1900: 1930.2 MHz ~ 1989.8 MHz WCDMA Band V: 871.4 MHz ~ 891.6 MHz WCDMA Band IV : 2112.4 MHz ~ 2152.6 MHz WCDMA Band II: 1932.4 MHz ~ 1987.6 MHz LTE Band 2 : 1930.7 MHz ~ 1989.3 MHz LTE Band 4 : 2110.7 MHz ~ 2154.3 MHz LTE Band 5 : 869.7 MHz ~ 893.3 MHz LTE Band 12 : 729.7 MHz ~ 745.3 MHz 802.11b/g/n: 2412 MHz ~ 2462 MHz Bluetooth: 2402 MHz ~ 2480 MHz GPS : 1.57542 GHz Glonass: 1602 MHz + n × 0.5625MHz (n=-7,-6,-5,...,0,...,6)
Antenna Type	WWAN : IFA Antenna WLAN : IFA Antenna Bluetooth : IFA Antenna GPS/Glonass : IFA Antenna
Type of Modulation	GSM: GMSK GPRS: GMSK EDGE(MCS 0-4): GMSK / (MCS 5-9): 8PSK WCDMA : BPSK (Uplink) HSDPA : QPSK (Uplink) HSUPA : QPSK (Uplink) HSPA+ (16QAM uplink is not supported) LTE: QPSK / 16QAM 802.11b : DSSS (DBPSK / DQPSK / CCK) 802.11g/n : OFDM (BPSK / QPSK / 16QAM / 64QAM) Bluetooth LE : GFSK Bluetooth (1Mbps) : GFSK Bluetooth (2Mbps) : $\pi/4$ -DQPSK Bluetooth (3Mbps) : 8-DPSK GPS/Glonass : BPSK



1.5. Modification of EUT

No modifications are made to the EUT during all test items.

1.6. Test Location

Test Site	SPORTON INTERNATIONAL (KUNSHAN) INC.		
Test Site Location	No. 3-2, PingXiang Road, Kunshan, Jiangsu Province, P. R. China TEL: +86-0512-5790-0158 FAX: +86-0512-5790-0958		
Test Site No.	Sporton Site No.		FCC Registration No.
	CO01-KS	03CH02-KS	418269

Note: The test site complies with ANSI C63.4 2014 requirement.

1.7. Applicable Standards

According to the specifications of the manufacturer, the EUT must comply with the requirements of the following standards:

- ♦ FCC 47 CFR FCC Part 15 Subpart B
- ♦ ANSI C63.4-2014

Remark:

1. All test items were verified and recorded according to the standards and without any deviation during the test.



2. Test Configuration of Equipment Under Test

2.1. Test Mode

The EUT has been associated with peripherals pursuant to ANSI C63.4-2014 and configuration operated in a manner tended to maximize its emission characteristics in a typical application.

Frequency range investigated: conduction (150 kHz to 30 MHz), radiation (30MHz to the 5th harmonic of the highest fundamental frequency or to 40 GHz, whichever is lower).

The following tables are showing the test modes as the worst cases and recorded in this report.

Item	EUT Configuration	Test Condition		
		EMI AC	EMI RE<1G	EMI RE≥1G
1.	Charging Mode (EUT with adapter)	☒	☒	Note 1
2.	Data application transferred mode (EUT with notebook)	☒	☒	☒

Abbreviations:

- EMI AC: AC conducted emissions
- EMI RE ≥ 1G: EUT radiated emissions ≥ 1GHz
- EMI RE < 1G: EUT radiated emissions < 1GHz

Note 1: Testing for this mode is not required or not the worst case.

Remark: For signal above 1GHz, the worst case was test item 2.



Test Items	EUT Configure Mode	Function Type
AC Conducted Emission	1/2	<p>Mode 1: GSM850 Idle + Bluetooth Idle + WLAN Idle + USB Cable (Charging from Adapter 1) + Battery 1 + Earphone + Camera (Rear)<Fig.1></p> <p>Mode 2: GSM1900 Idle + Bluetooth Idle + WLAN Idle + USB Cable (Charging from Adapter 2) + Battery 2 + Earphone + Camera (Front)<Fig.1></p> <p>Mode 3: WCDMA Band V Idle + Bluetooth Idle + WLAN Idle + USB Cable (Charging from Adapter 2) + Battery 2 + Earphone + MPEG4<Fig.1></p> <p>Mode 4: LTE Band 4 Idle + Bluetooth Idle + WLAN Idle + USB Cable (Charging from Adapter 2) + Battery 2 + Earphone + GPS Rx<Fig.2></p> <p>Mode 5: LTE Band 12 Idle + Bluetooth Idle + WLAN Idle + USB Cable (Data Link with Notebook) + Battery 2 + Earphone + Glonass Rx<Fig.3></p>
Radiated Emissions < 1GHz	1/2	<p>Mode 1: GSM850 Idle + Bluetooth Idle + WLAN Idle + USB Cable (Charging from Adapter 1) + Battery 1 + Earphone + Camera (Rear)<Fig.1></p> <p>Mode 2: GSM1900 Idle + Bluetooth Idle + WLAN Idle + USB Cable (Charging from Adapter 2) + Battery 2 + Earphone + Camera (Front)<Fig.1></p> <p>Mode 3: WCDMA Band V Idle + Bluetooth Idle + WLAN Idle + USB Cable (Charging from Adapter 2) + Battery 2 + Earphone + MPEG4<Fig.1></p> <p>Mode 4: LTE Band 4 Idle + Bluetooth Idle + WLAN Idle + USB Cable (Charging from Adapter 2) + Battery 2 + Earphone + GPS Rx<Fig.2></p> <p>Mode 5: LTE Band 12 Idle + Bluetooth Idle + WLAN Idle + USB Cable (Data Link with Notebook) + Battery 2 + Earphone + Glonass Rx<Fig.3></p>
Radiated Emissions ≥ 1GHz	2	<p>Mode 1: LTE Band 12 Idle + Bluetooth Idle + WLAN Idle + USB Cable (Data Link with Notebook) + Battery 2 + Earphone + Glonass Rx<Fig.3></p>

Remark:

1. The worst case of AC is mode 4; and the USB Link mode of AC is mode 5, only the test data of these modes were reported.
2. The worst case of RE < 1G is mode 5, only the test data of these modes were reported.
3. Data Link with Notebook means data application transferred mode between EUT and Notebook.

2.2. Connection Diagram of Test System

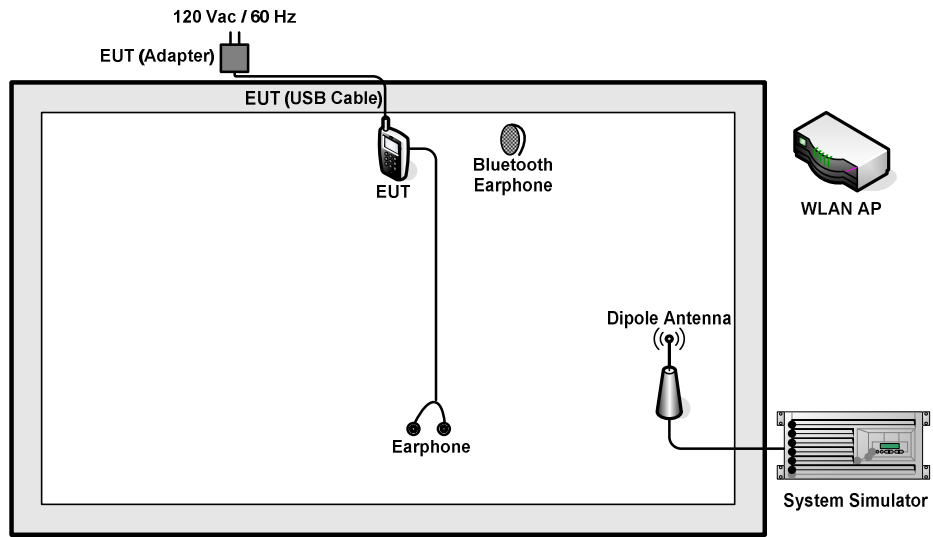

<Fig.1>

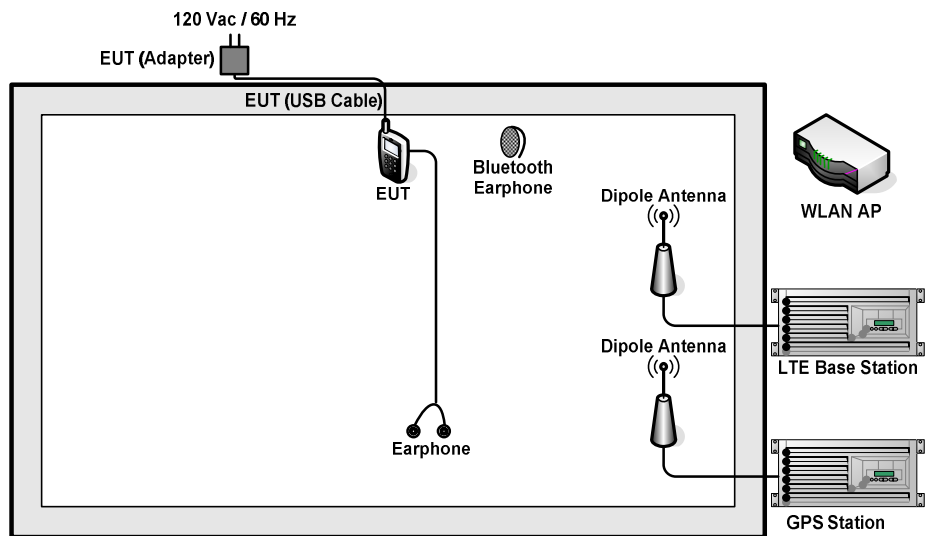

<Fig.2>

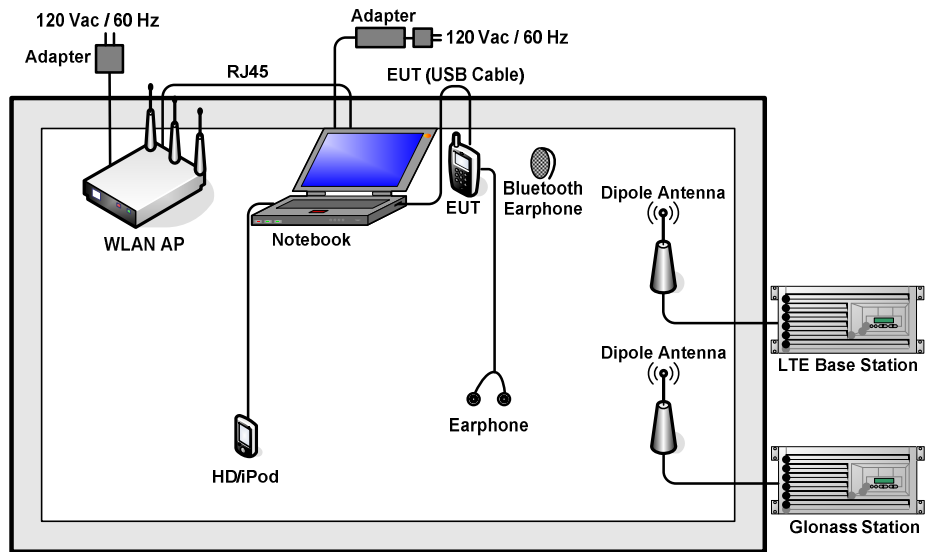

<Fig.3>



2.3. Support Unit used in test configuration and system

Item	Equipment	Trade Name	Model Name	FCC ID	Data Cable	Power Cord
1.	LTE Base Station	Anritus	MT8820C	N/A	N/A	Unshielded, 1.8 m
2.	GPS Station	ADIVIC	MP9000	N/A	N/A	Unshielded, 1.8 m
3.	Glonass Station	RACELOGIC	RLLS03-2RP	N/A	N/A	Unshielded, 1.8 m
4.	WLAN AP	LINKSYS	WRT600N	Q87-WRT600NV11	N/A	Unshielded, 1.8 m
5.	WLAN AP	TP-LINK	TL-WDR5600	N/A	N/A	Unshielded, 1.8 m
6.	Bluetooth Earphone	Lenovo	LBH308	2010DP1340	N/A	N/A
7.	Notebook	Lenovo	G480	N/A	N/A	AC I/P: Unshielded, 1.8 m DC O/P: Shielded, 1.8 m
8.	SD Card	Kingston	4GB	N/A	N/A	N/A
9.	Hard Disk	Lenovo	F310	FCC DoC	Shielded, 0.5m	N/A
10.	iPod	Apple	A1199	FCC DoC	Shielded, 1.2 m	N/A
11.	Earphone	Lenovo	LH102	N/A	N/A	Unshielded, 1.2 m



2.4. EUT Operation Test Setup

The EUT was in GSM or WCDMA or LTE idle mode during the testing. The EUT was synchronized to the BCCH, and is in continuous receiving mode by setting system simulator's paging reorganization.

At the same time, the EUT was attached to the Bluetooth earphone or WLAN AP, and the following programs installed in the EUT were programmed during the test.

1. Data application is transferred between Notebook and EUT via USB cable.
2. Turn on GPS/Glonass function to make the EUT receive continuous signals from GPS/Glonass station.
3. Execute "Video player" to play MPEG4 files.
4. Turn on camera to capture images.



3. Test Result

3.1. Test of AC Conducted Emission Measurement

3.1.1 Limits of AC Conducted Emission

For equipment that is designed to be connected to the public utility (AC) power line, the radio frequency voltage that is conducted back onto the AC power line on any frequency or frequencies within the band 150 kHz to 30 MHz shall not exceed the limits in the following table.

Frequency of emission (MHz)	Conducted limit (dBuV)	
	Quasi-peak	Average
0.15-0.5	66 to 56*	56 to 46*
0.5-5	56	46
5-30	60	50

*Decreases with the logarithm of the frequency.

3.1.2 Measuring Instruments

The measuring equipment is listed in the section 4 of this test report.

3.1.3 Test Procedure

1. The EUT was placed 0.4 meter from the conducting wall of the shielding room was kept at least 80 centimeters from any other grounded conducting surface.
2. Connect EUT to the power mains through a line impedance stabilization network (LISN).
3. All the support units are connecting to the other LISN.
4. The LISN provides 50 ohm coupling impedance for the measuring instrument.
5. The FCC states that a 50 ohm, 50 microhenry LISN should be used.
6. Both sides of AC line were checked for maximum conducted interference.
7. The frequency range from 150 kHz to 30 MHz was searched.
8. Set the test-receiver system to Peak Detect Function and specified bandwidth (IF Bandwidth = 9kHz) with Maximum Hold Mode. Then measurement is also conducted by Average Detector and Quasi-Peak Detector Function respectively.

3.1.4 Test Setup

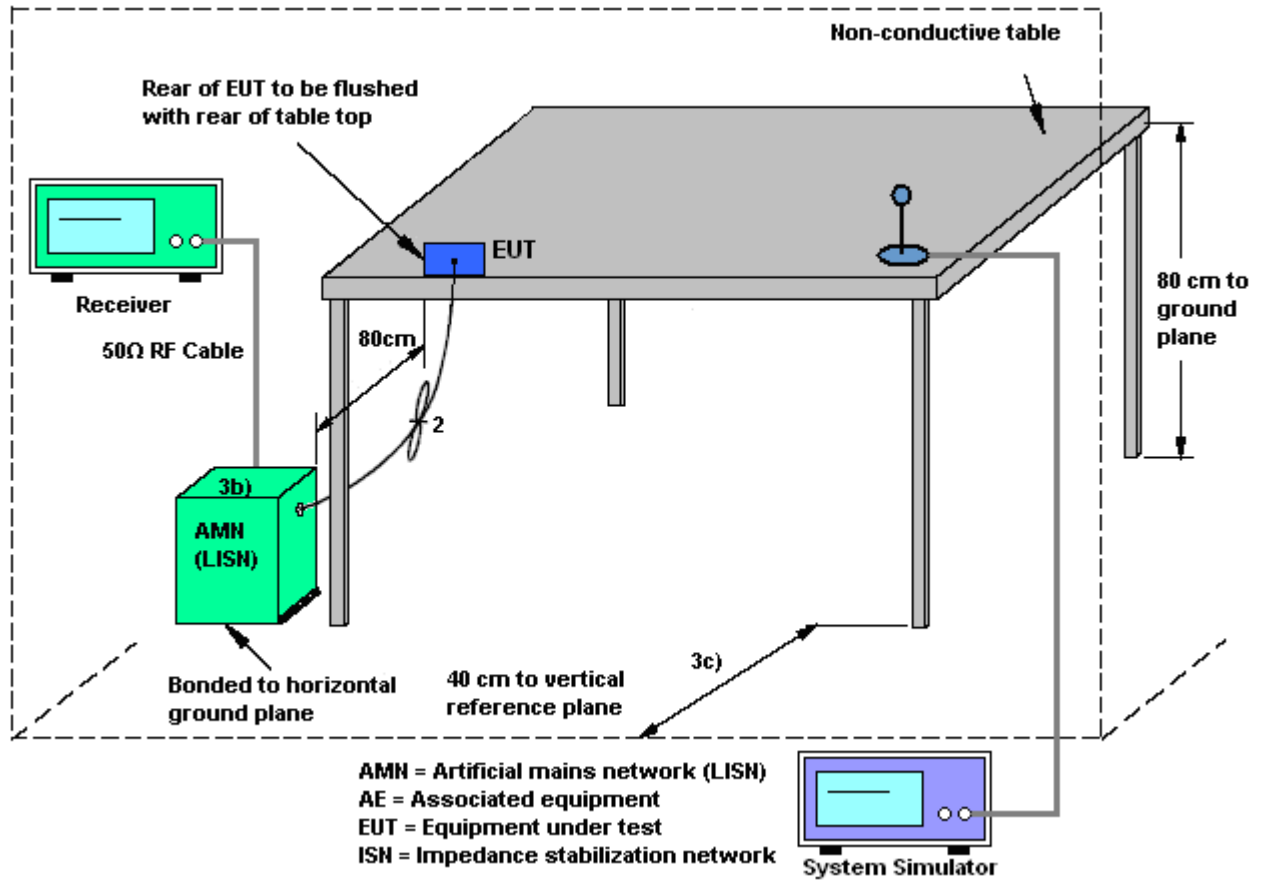



3.1.5 Test Result of AC Conducted Emission

Test Mode :	Mode 4	Temperature :	20~22°C
Test Engineer :	Morris Li	Relative Humidity :	42~44%
Test Voltage :	120Vac / 60Hz	Phase :	Line
Function Type :	LTE Band 4 Idle + Bluetooth Idle + WLAN Idle + USB Cable (Charging from Adapter 2) + Battery 2 + Earphone + GPS Rx		

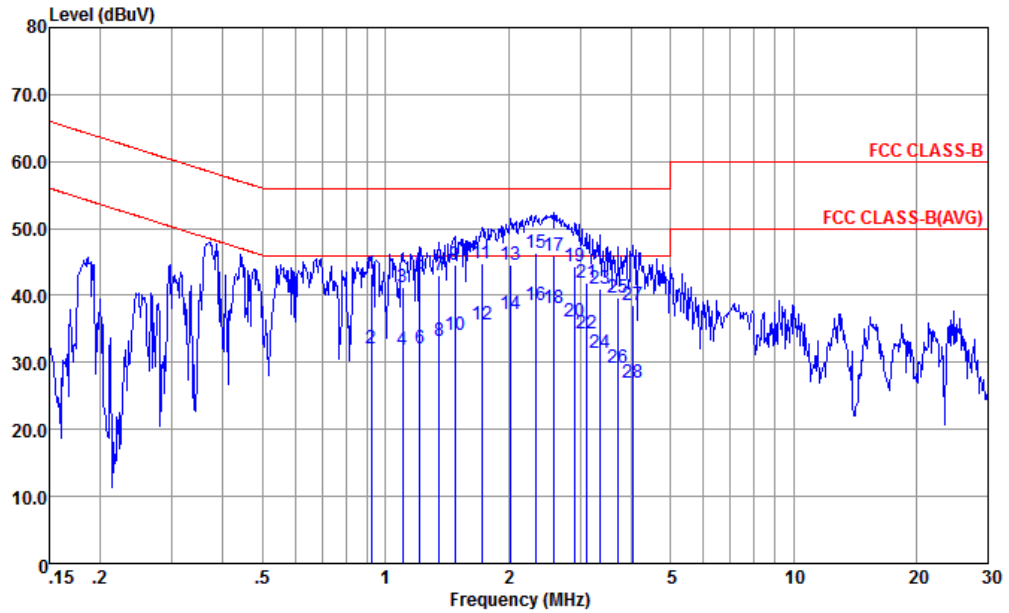

Site : CO01-KS
 Condition : FCC CLASS-B LISN-L-20151024 LINE
 Project : (FC) 692602
 mode : Mode 4
 IMEI : 862574030006598/01
 : #16

	Freq	Level	Over Limit	Limit Line	Read Level	LISN Factor	Cable Loss	Remark
	MHz	dBuV	dB	dBuV	dBuV	dB	dB	
1	0.923	43.33	-12.67	56.00	32.90	0.25	10.18	QP
2	0.923	32.13	-13.87	46.00	21.70	0.25	10.18	Average
3	1.100	41.23	-14.77	56.00	30.80	0.24	10.19	QP
4	1.100	31.83	-14.17	46.00	21.40	0.24	10.19	Average
5	1.216	43.32	-12.68	56.00	32.90	0.23	10.19	QP
6	1.216	32.12	-13.88	46.00	21.70	0.23	10.19	Average
7	1.352	42.91	-13.09	56.00	32.50	0.22	10.19	QP
8	1.352	33.11	-12.89	46.00	22.70	0.22	10.19	Average
9	1.480	44.60	-11.40	56.00	34.20	0.21	10.19	QP
10	1.480	34.20	-11.80	46.00	23.80	0.21	10.19	Average
11	1.725	44.88	-11.12	56.00	34.50	0.19	10.19	QP
12	1.725	35.58	-10.42	46.00	25.20	0.19	10.19	Average
13	2.033	44.57	-11.43	56.00	34.20	0.18	10.19	QP
14	2.033	37.27	-8.73	46.00	26.90	0.18	10.19	Average
15	2.334	46.28	-9.72	56.00	35.90	0.18	10.20	QP
16 *	2.334	38.58	-7.42	46.00	28.20	0.18	10.20	Average



Test Mode :	Mode 4	Temperature :	20~22°C
Test Engineer :	Morris Li	Relative Humidity :	42~44%
Test Voltage :	120Vac / 60Hz	Phase :	Line
Function Type :	LTE Band 4 Idle + Bluetooth Idle + WLAN Idle + USB Cable (Charging from Adapter 2) + Battery 2 + Earphone + GPS Rx		

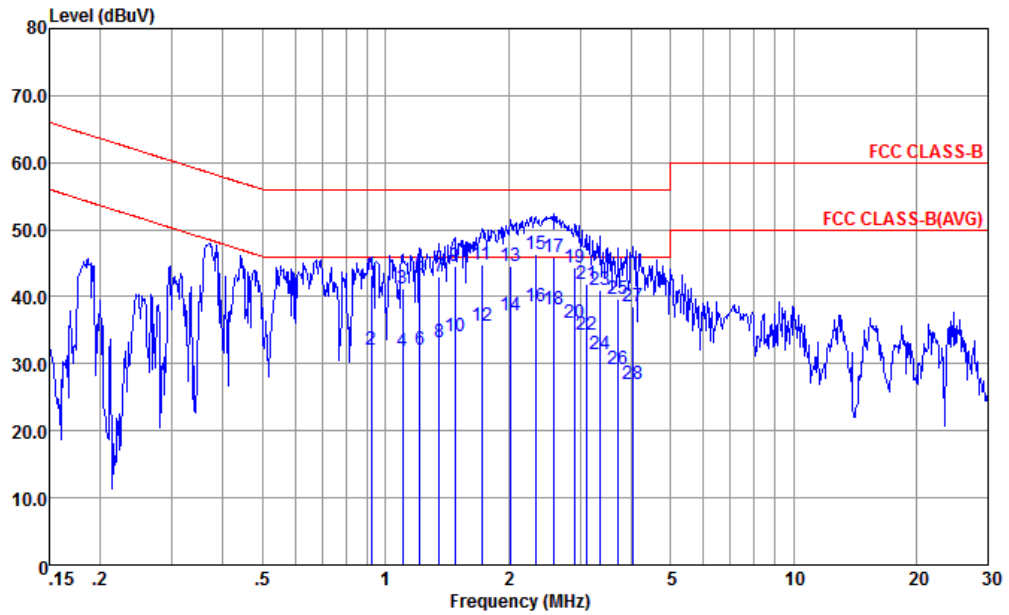

Site : CO01-KS
 Condition : FCC CLASS-B LISN-L-20151024 LINE
 Project : (FC) 692602
 mode : Mode 4
 IMEI : 862574030006598/01
 : #16

	Freq	Level	Over Limit	Limit Line	Read Level	LISN Factor	Cable Loss	Remark
	MHz	dBuV	dB	dBuV	dBuV	dB	dB	
17	2.581	45.99	-10.01	56.00	35.60	0.18	10.21	QP
18	2.581	38.19	-7.81	46.00	27.80	0.18	10.21	Average
19	2.915	44.30	-11.70	56.00	33.90	0.18	10.22	QP
20	2.915	36.10	-9.90	46.00	25.70	0.18	10.22	Average
21	3.107	41.91	-14.09	56.00	31.51	0.18	10.22	QP
22	3.107	34.31	-11.69	46.00	23.91	0.18	10.22	Average
23	3.346	40.91	-15.09	56.00	30.49	0.19	10.23	QP
24	3.346	31.51	-14.49	46.00	21.09	0.19	10.23	Average
25	3.720	39.62	-16.38	56.00	29.20	0.19	10.23	QP
26	3.720	29.12	-16.88	46.00	18.70	0.19	10.23	Average
27	4.049	38.63	-17.37	56.00	28.20	0.19	10.24	QP
28	4.049	26.93	-19.07	46.00	16.50	0.19	10.24	Average



Test Mode :	Mode 4	Temperature :	20~22°C
Test Engineer :	Morris Li	Relative Humidity :	42~44%
Test Voltage :	120Vac / 60Hz	Phase :	Neutral
Function Type :	LTE Band 4 Idle + Bluetooth Idle + WLAN Idle + USB Cable (Charging from Adapter 2) + Battery 2 + Earphone + GPS Rx		

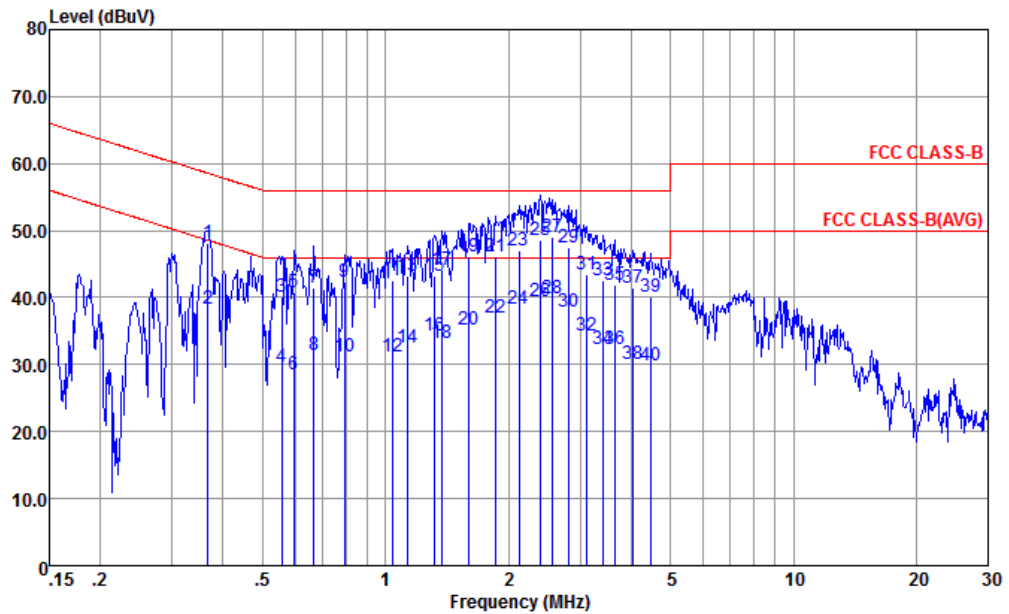

Site : CO01-KS
 Condition : FCC CLASS-B LISN-N-20151024 NEUTRAL
 Project : (FC) 692602
 mode : Mode 4
 IMEI : 862574030006598/01
 : #16

	Freq	Level	Over	Limit	Read	LISN	Cable	Remark
	MHz	dBuV	Limit	Line	Level	Factor	Loss	
			dB	dBuV	dBuV	dB	dB	
1	0.367	48.03	-10.53	58.56	37.49	0.32	10.22	QP
2	0.367	38.33	-10.23	48.56	27.79	0.32	10.22	Average
3	0.558	40.01	-15.99	56.00	29.50	0.33	10.18	QP
4	0.558	29.71	-16.29	46.00	19.20	0.33	10.18	Average
5	0.595	40.71	-15.29	56.00	30.20	0.33	10.18	QP
6	0.595	28.41	-17.59	46.00	17.90	0.33	10.18	Average
7	0.668	41.42	-14.58	56.00	30.90	0.34	10.18	QP
8	0.668	31.42	-14.58	46.00	20.90	0.34	10.18	Average
9	0.792	42.32	-13.68	56.00	31.80	0.35	10.17	QP
10	0.792	31.12	-14.88	46.00	20.60	0.35	10.17	Average
11	1.037	42.46	-13.54	56.00	31.90	0.37	10.19	QP
12	1.037	31.26	-14.74	46.00	20.70	0.37	10.19	Average
13	1.135	43.26	-12.74	56.00	32.70	0.37	10.19	QP
14	1.135	32.46	-13.54	46.00	21.90	0.37	10.19	Average
15	1.317	43.26	-12.74	56.00	32.70	0.37	10.19	QP
16	1.317	34.36	-11.64	46.00	23.80	0.37	10.19	Average



Test Mode :	Mode 4	Temperature :	20~22°C
Test Engineer :	Morris Li	Relative Humidity :	42~44%
Test Voltage :	120Vac / 60Hz	Phase :	Neutral
Function Type :	LTE Band 4 Idle + Bluetooth Idle + WLAN Idle + USB Cable (Charging from Adapter 2) + Battery 2 + Earphone + GPS Rx		

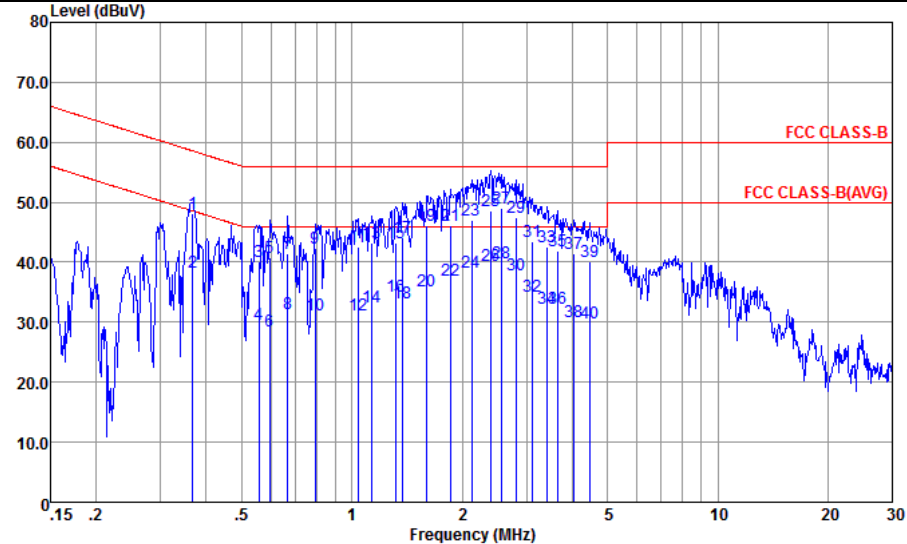

Site : CO01-KS
 Condition : FCC CLASS-B LISN-N-20151024 NEUTRAL
 Project : (FC) 692602
 mode : Mode 4
 IMEI : 862574030006598/01
 : #16

	Freq	Level	Over Limit	Limit Line	Read Level	LISN Factor	Cable Loss	Remark
	MHz	dBuV	dB	dBuV	dBuV	dB	dB	
17	1.374	44.06	-11.94	56.00	33.50	0.37	10.19	QP
18	1.374	33.26	-12.74	46.00	22.70	0.37	10.19	Average
19	1.602	46.06	-9.94	56.00	35.49	0.38	10.19	QP
20	1.602	35.16	-10.84	46.00	24.59	0.38	10.19	Average
21	1.858	46.17	-9.83	56.00	35.60	0.38	10.19	QP
22	1.858	37.07	-8.93	46.00	26.50	0.38	10.19	Average
23	2.121	47.07	-8.93	56.00	36.50	0.38	10.19	QP
24	2.121	38.37	-7.63	46.00	27.80	0.38	10.19	Average
25	2.396	48.48	-7.52	56.00	37.90	0.38	10.20	QP
26	2.396	39.48	-6.52	46.00	28.90	0.38	10.20	Average
27	2.567	49.08	-6.92	56.00	38.50	0.37	10.21	QP
28 *	2.567	39.98	-6.02	46.00	29.40	0.37	10.21	Average
29	2.809	47.49	-8.51	56.00	36.91	0.37	10.21	QP
30	2.809	37.79	-8.21	46.00	27.21	0.37	10.21	Average
31	3.123	43.49	-12.51	56.00	32.90	0.37	10.22	QP
32	3.123	34.39	-11.61	46.00	23.80	0.37	10.22	Average
33	3.417	42.50	-13.50	56.00	31.90	0.37	10.23	QP
34	3.417	32.40	-13.60	46.00	21.80	0.37	10.23	Average
35	3.642	41.80	-14.20	56.00	31.20	0.37	10.23	QP
36	3.642	32.30	-13.70	46.00	21.70	0.37	10.23	Average
37	4.049	41.40	-14.60	56.00	30.80	0.36	10.24	QP
38	4.049	30.10	-15.90	46.00	19.50	0.36	10.24	Average
39	4.454	40.10	-15.90	56.00	29.50	0.36	10.24	QP
40	4.454	29.80	-16.20	46.00	19.20	0.36	10.24	Average



Test Mode :	Mode 5	Temperature :	20~22°C
Test Engineer :	Morris Li	Relative Humidity :	42~44%
Test Voltage :	120Vac / 60Hz	Phase :	Line
Function Type :	LTE Band 12 Idle + Bluetooth Idle + WLAN Idle + USB Cable (Data Link with Notebook) + Battery 2 + Earphone + Glonass Rx		

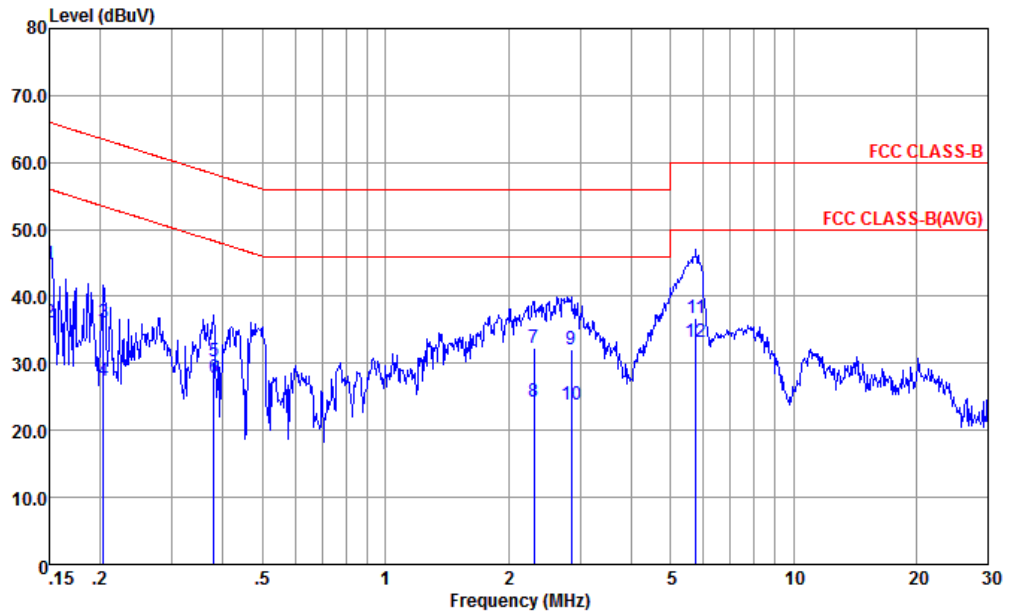

Site : CO01-KS
 Condition : FCC CLASS-B LISN-L-20151024 LINE
 Project : (FC) 692602
 mode : Mode 5
 IMEI : 862574030006598/01
 : #16

	Freq	Level	Over Limit	Limit Line	Read Level	LISN Factor	Cable Loss	Remark
	MHz	dBuV	dB	dBuV	dBuV	dB	dB	
1	0.150	44.82	-21.18	66.00	33.90	0.53	10.39	QP
2	0.150	36.12	-19.88	56.00	25.20	0.53	10.39	Average
3	0.204	36.05	-27.40	63.45	25.50	0.22	10.33	QP
4	0.204	27.45	-26.00	53.45	16.90	0.22	10.33	Average
5	0.379	30.24	-28.06	58.30	19.80	0.23	10.21	QP
6	0.379	27.84	-20.46	48.30	17.40	0.23	10.21	Average
7	2.309	32.28	-23.72	56.00	21.90	0.18	10.20	QP
8	2.309	24.28	-21.72	46.00	13.90	0.18	10.20	Average
9	2.854	32.10	-23.90	56.00	21.71	0.18	10.21	QP
10	2.854	23.90	-22.10	46.00	13.51	0.18	10.21	Average
11	5.774	36.66	-23.34	60.00	26.19	0.21	10.26	QP
12 *	5.774	33.16	-16.84	50.00	22.69	0.21	10.26	Average



Test Mode :	Mode 5	Temperature :	20~22°C
Test Engineer :	Morris Li	Relative Humidity :	42~44%
Test Voltage :	120Vac / 60Hz	Phase :	Neutral
Function Type :	LTE Band 12 Idle + Bluetooth Idle + WLAN Idle + USB Cable (Data Link with Notebook) + Battery 2 + Earphone + Glonass Rx		

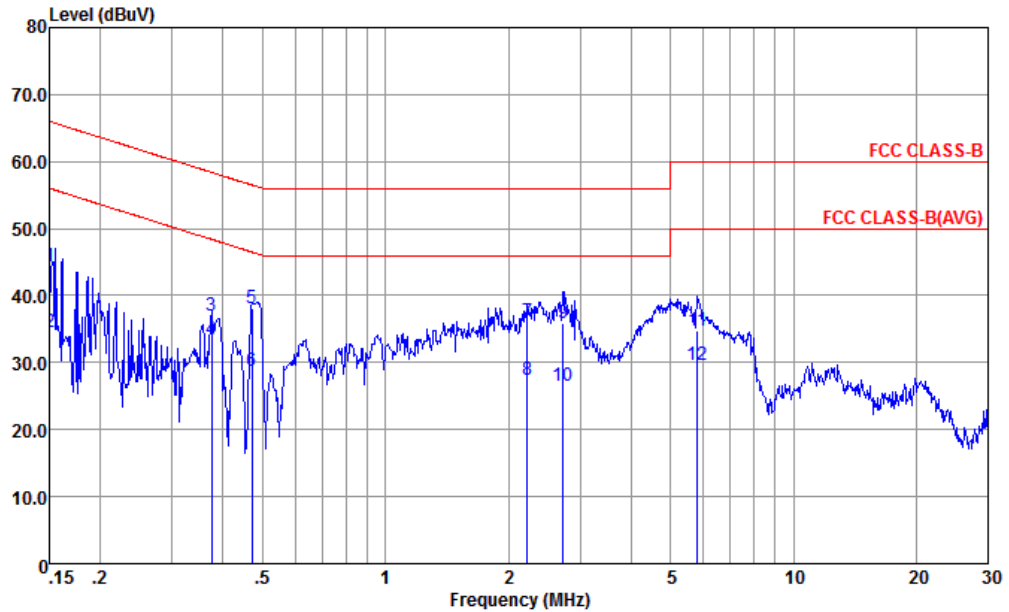

Site : CO01-KS
 Condition : FCC CLASS-B LISN-N-20151024 NEUTRAL
 Project : (FC) 692602
 mode : Mode 5
 IMEI : 862574030006598/01
 : #16

	Freq	Level	Over Limit	Limit Line	Read Level	LISN Factor	Cable Loss	Remark
	MHz	dBuV	dB	dBuV	dBuV	dB	dB	
1	0.150	44.39	-21.61	66.00	33.70	0.30	10.39	QP
2	0.150	34.49	-21.51	56.00	23.80	0.30	10.39	Average
3	0.375	36.93	-21.46	58.39	26.40	0.32	10.21	QP
4 *	0.375	33.43	-14.96	48.39	22.90	0.32	10.21	Average
5	0.471	38.01	-18.48	56.49	27.50	0.32	10.19	QP
6	0.471	28.71	-17.78	46.49	18.20	0.32	10.19	Average
7	2.225	36.07	-19.93	56.00	25.49	0.38	10.20	QP
8	2.225	27.47	-18.53	46.00	16.89	0.38	10.20	Average
9	2.721	35.78	-20.22	56.00	25.20	0.37	10.21	QP
10	2.721	26.48	-19.52	46.00	15.90	0.37	10.21	Average
11	5.805	34.68	-25.32	60.00	24.09	0.33	10.26	QP
12	5.805	29.68	-20.32	50.00	19.09	0.33	10.26	Average

3.2. Test of Radiated Emission Measurement

3.2.1. Limit of Radiated Emission

The emissions from an unintentional radiator shall not exceed the field strength levels specified in the following table:

Frequency (MHz)	Field Strength (microvolts/meter)	Measurement Distance (meters)
30 – 88	100	3
88 – 216	150	3
216 - 960	200	3
Above 960	500	3

3.2.2. Measuring Instruments

The measuring equipment is listed in the section 4 of this test report.

3.2.3. Test Procedures

1. The EUT was placed on a turntable with 0.8 meter above ground.
2. The EUT was set 3 meters from the interference receiving antenna, which was mounted on the top of a variable height antenna tower.
3. The table was rotated 360 degrees to determine the position of the highest radiation.
4. The antenna is a Bi-Log antenna and its height is adjusted between one to four meters above ground to find the maximum value of the field strength for both horizontal polarization and vertical polarization of the antenna.
5. For each suspected emission, the EUT was arranged to its worst case and then tune the antenna tower (from 1 m to 4 m) and turntable (from 0 degree to 360 degrees) to find the maximum reading.
6. Set the test-receiver system to Peak Detect Function and specified bandwidth with Maximum Hold Mode (RBW=120kHz/VBW=300kHz for frequency below 1GHz; RBW=1MHz VBW=3MHz (Peak), RBW=1MHz/VBW=10Hz (Average) for frequency above 1GHz).
7. If the emission level of the EUT in peak mode was 3 dB lower than the limit specified, peak values of EUT will be reported. Otherwise, the emission will be repeated by using the quasi-peak method and reported.
8. Emission level (dB μ V/m) = 20 log Emission level (μ V/m)
9. Corrected Reading: Antenna Factor + Cable Loss + Read Level - Preamp Factor = Level

3.2.4. Test Setup of Radiated Emission

For radiated emissions from 30MHz to 1GHz

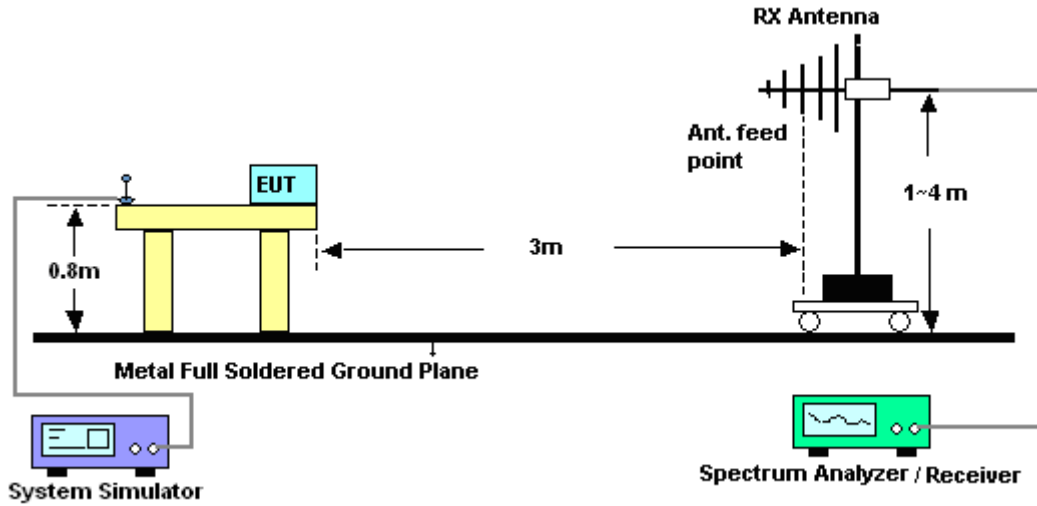

For radiated emissions above 1GHz

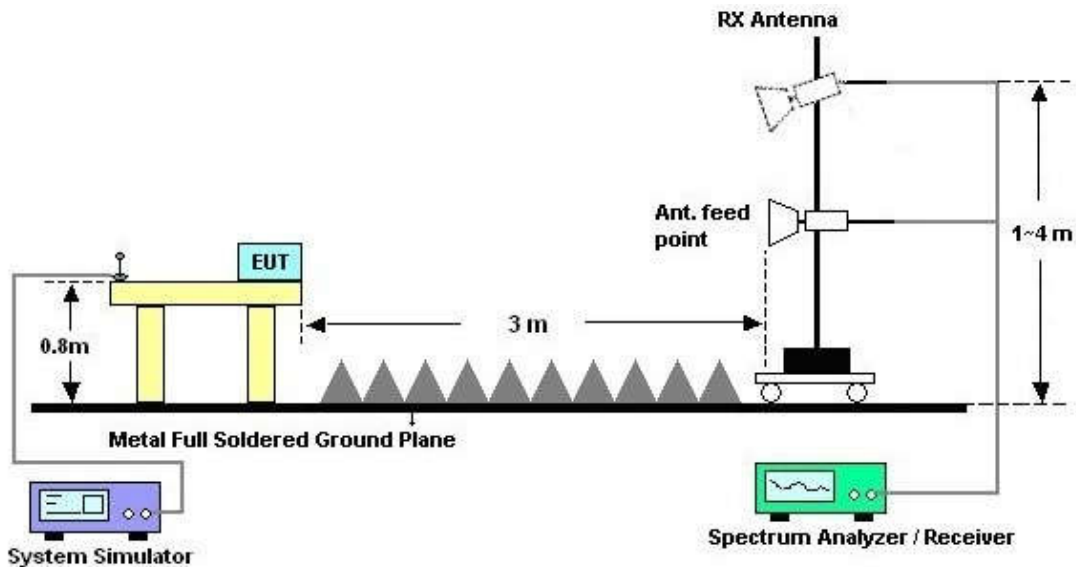



3.2.5. Test Result of Radiated Emission

Test Mode :	Mode 5	Temperature :	21~22°C
Test Engineer :	Leo Liao	Relative Humidity :	41~42%
Test Distance :	3m	Polarization :	Horizontal
Function Type :	LTE Band 12 Idle + Bluetooth Idle + WLAN Idle + USB Cable (Data Link with Notebook) + Battery 2 + Earphone + Glonass Rx		
Remark :	#6 is system simulator signal which can be ignored.		

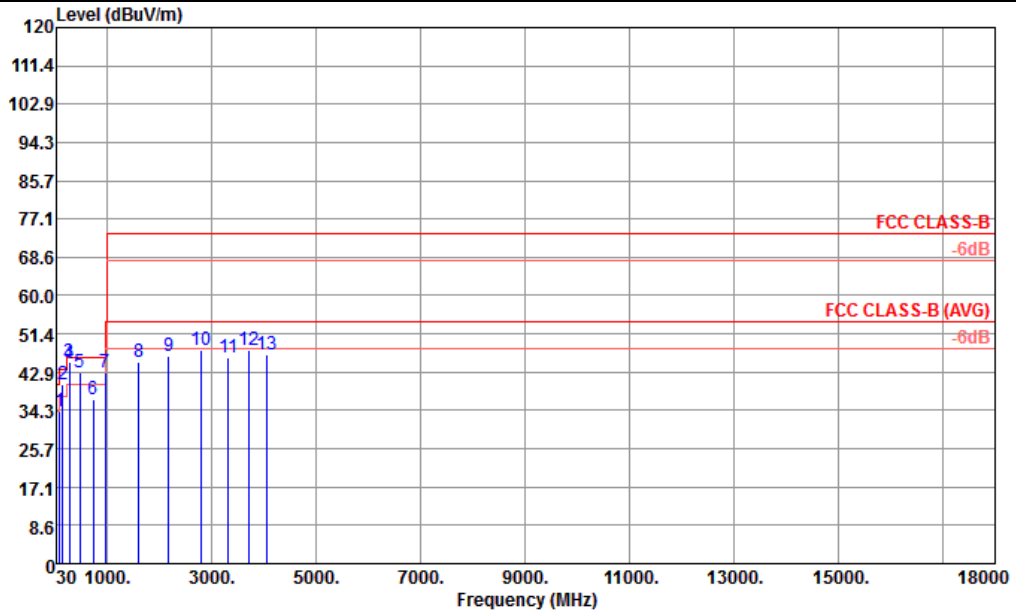

Site : 03CH02-KS
 Condition : FCC CLASS-B 3m 966-02 LF ANT HORIZONTAL
 Project : (FC) 692602
 Mode : 5
 IMEI : 862574030006598/01 #16

	Freq	Level	Over Limit	Limit Line	ReadAntenna Level	Antenna Factor	Cable Loss	Preamp Factor	A/Pos	T/Pos	Remark
	MHz	dBuV/m	dB	dBuV/m	dBuV	dB/m	dB	dB	cm	deg	
1	99.93	34.05	-9.45	43.50	47.12	18.17	0.23	31.47	---	---	Peak
2 !	144.48	39.97	-3.53	43.50	53.51	17.67	0.31	31.52	---	---	Peak
3 !	284.07	44.97	-1.03	46.00	57.70	17.67	0.56	30.96	100	142	QP
4 !	285.69	44.72	-1.28	46.00	57.40	17.68	0.56	30.92	100	124	QP
5 !	479.90	42.86	-3.14	46.00	48.27	23.37	0.92	29.70	---	---	Peak
6	738.90	36.72			37.13	26.33	1.32	28.06	---	---	Peak
7 !	959.90	42.82	-3.18	46.00	38.80	28.66	1.75	26.39	100	78	QP
8	1606.00	45.03	-28.97	74.00	48.17	28.98	4.13	36.25	---	---	Peak
9	2178.00	46.37	-27.63	74.00	44.00	31.08	5.65	34.36	---	---	Peak
10	2802.00	47.88	-26.12	74.00	40.69	32.10	2.71	27.62	---	---	Peak
11	3318.00	46.01	-27.99	74.00	37.44	33.56	5.97	30.96	---	---	Peak
12	3702.00	47.76	-26.24	74.00	38.51	34.30	6.29	31.34	---	---	Peak
13	4044.00	46.83	-27.17	74.00	37.51	34.91	6.17	31.76	---	---	Peak



Test Mode :	Mode 5	Temperature :	21~22°C
Test Engineer :	Leo Liao	Relative Humidity :	41~42%
Test Distance :	3m	Polarization :	Vertical
Function Type :	LTE Band 12 Idle + Bluetooth Idle + WLAN Idle + USB Cable (Data Link with Notebook) + Battery 2 + Earphone + Glonass Rx		
Remark :	#6 is system simulator signal which can be ignored.		

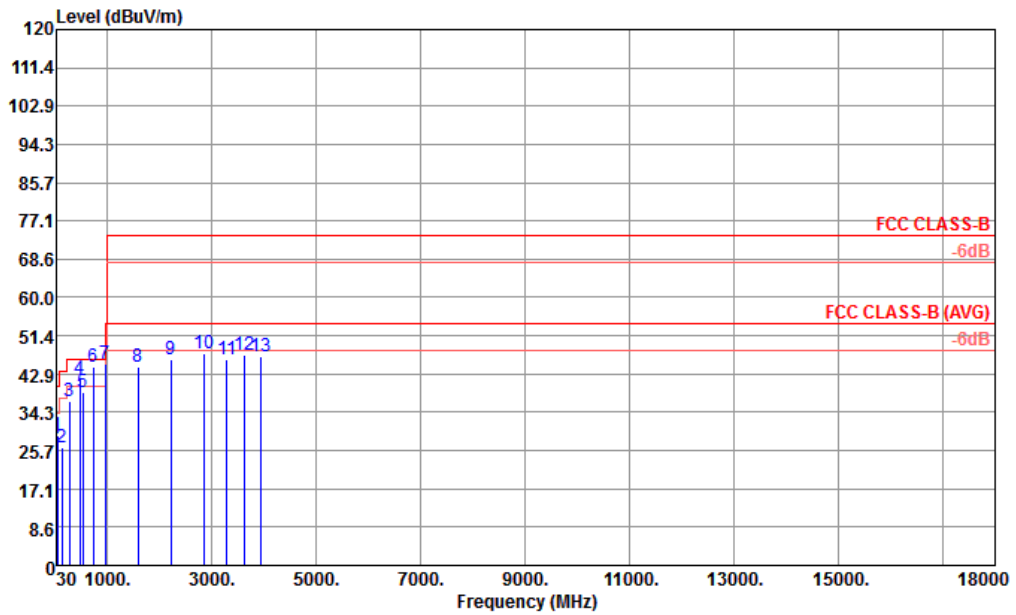

Site : 03CH02-KS
 Condition : FCC CLASS-B 3m 966-02 LF ANT VERTICAL
 Project : (FC) 692602
 Mode : 5

: from mode 2

	Freq	Level	Over Limit	Limit Line	ReadAntenna Level	Antenna Factor	Cable Loss	Preamp Factor	A/Pos	T/Pos	Remark
	MHz	dBuV/m	dB	dBuV/m	dBuV	dB/m	dB	dB	cm	deg	
1	44.85	29.17	-10.83	40.00	41.03	19.90	0.13	31.89	---	---	Peak
2	135.30	26.26	-17.24	43.50	39.63	17.81	0.30	31.48	---	---	Peak
3	285.42	36.62	-9.38	46.00	49.30	17.68	0.56	30.92	---	---	Peak
4 !	479.90	41.91	-4.09	46.00	47.32	23.37	0.92	29.70	---	---	Peak
5	531.70	38.71	-7.29	46.00	43.30	24.01	0.90	29.50	200	211	QP
6 !	736.80	44.45			44.86	26.35	1.31	28.07	---	---	Peak
7 !	959.90	45.12	-0.88	46.00	41.10	28.66	1.75	26.39	100	25	QP
8	1594.00	44.58	-29.42	74.00	47.74	28.94	4.13	36.23	---	---	Peak
9	2216.00	46.04	-27.96	74.00	43.21	31.22	5.78	34.17	---	---	Peak
10	2856.00	47.54	-26.46	74.00	40.42	32.22	2.85	27.95	---	---	Peak
11	3294.00	46.07	-27.93	74.00	37.56	33.53	5.99	31.01	---	---	Peak
12	3633.00	47.17	-26.83	74.00	38.12	34.03	6.14	31.12	---	---	Peak
13	3942.00	46.70	-27.30	74.00	37.35	34.76	6.25	31.66	---	---	Peak



4. List of Measuring Equipment

Instrument	Manufacturer	Model No.	Serial No.	Characteristics	Calibration Date	Test Date	Due Date	Remark
EMI Receiver	R&S	ESCI7	100768	9kHz~7GHz;	Apr. 29, 2016	Nov. 15, 2016	Apr. 28, 2017	Conduction (CO01-KS)
AC LISN	MessTec	AN3016	060103	9kHz~30MHz	Oct. 13, 2016	Nov. 15, 2016	Oct. 12, 2017	Conduction (CO01-KS)
AC LISN (for auxiliary equipment)	MessTec	AN3016	060105	9kHz~30MHz	Oct. 13, 2016	Nov. 15, 2016	Oct. 12, 2017	Conduction (CO01-KS)
AC Power Source	Chroma	61602	ABP0000008 11	AC 0V~300V, 45Hz~1000Hz	Oct. 13, 2016	Nov. 15, 2016	Oct. 12, 2017	Conduction (CO01-KS)
EMI Test Receiver	R&S	ESR7	101403	9kHz~7GHz; Max 30dBm	Aug. 09, 2016	Nov. 30, 2016	Aug. 08, 2017	Radiation (03CH02-KS)
EXA Spectrum Analyzer	Keysight	N9010A	MY55150208	10Hz~44GHz, MAX 30dB	Apr. 22, 2016	Nov. 30, 2016	Apr. 21, 2017	Radiation (03CH02-KS)
Bilog Antenna	TeseQ	CBL6112D	37879	30MHz~2GHz	Aug. 20, 2016	Nov. 30, 2016	Aug. 19, 2017	Radiation (03CH02-KS)
Double Ridge Horn Antenna	ETS-Lindgren	3117	75957	1GHz~18GHz	Oct. 22, 2016	Nov. 30, 2016	Oct. 21, 2017	Radiation (03CH02-KS)
Amplifier	com-power	PA-103A	161069	1kHz~1000MHz / 32 dB	Apr. 22, 2016	Nov. 30, 2016	Apr. 21, 2017	Radiation (03CH02-KS)
Amplifier	Agilent	8449B	3008A02384	1-26.5GHz Gain 30dB	Oct. 13, 2016	Nov. 30, 2016	Oct. 12, 2017	Radiation (03CH02-KS)
AC Power Source	Chroma	61601	61601000247 3	N/A	NCR	Nov. 30, 2016	NCR	Radiation (03CH02-KS)
Turn Table	MF	MF7802	N/A	0~360 degree	NCR	Nov. 30, 2016	NCR	Radiation (03CH02-KS)
Antenna Mast	MF	MF7802	N/A	1 m~4 m	NCR	Nov. 30, 2016	NCR	Radiation (03CH02-KS)

NCR: No Calibration Required



5. Uncertainty of Evaluation

Uncertainty of Conducted Emission Measurement (150 kHz ~ 30 MHz)

Measuring Uncertainty for a Level of Confidence of 95% ($U = 2Uc(y)$)	2.3dB
---	-------

Uncertainty of Radiated Emission Measurement (30 MHz ~ 1000 MHz)

Measuring Uncertainty for a Level of Confidence of 95% ($U = 2Uc(y)$)	5.1dB
---	-------

Uncertainty of Radiated Emission Measurement (1GHz ~ 18GHz)

Measuring Uncertainty for a Level of Confidence of 95% ($U = 2Uc(y)$)	4.5dB
---	-------