

Annex Z. Calibration Certificate for Probe and Dipole

The SPEAG calibration certificates are shown as follows.



Accredited by the Swiss Accreditation Service (SAS)
The Swiss Accreditation Service is one of the signatories to the EA
Multilateral Agreement for the recognition of calibration certificates

Accreditation No.: **SCS 0108**

Client **B.V. ADT (Auden)**

Certificate No: **D5GHzV2-1019_Mar21**

CALIBRATION CERTIFICATE

Object **D5GHzV2 - SN:1019**

Calibration procedure(s) **QA CAL-22.v6
Calibration Procedure for SAR Validation Sources between 3-10 GHz**

Calibration date: **March 19, 2021**

This calibration certificate documents the traceability to national standards, which realize the physical units of measurements (SI).
The measurements and the uncertainties with confidence probability are given on the following pages and are part of the certificate.

All calibrations have been conducted in the closed laboratory facility: environment temperature $(22 \pm 3)^\circ\text{C}$ and humidity $< 70\%$.

Calibration Equipment used (M&TE critical for calibration)

Primary Standards	ID #	Cal Date (Certificate No.)	Scheduled Calibration
Power meter NRP	SN: 104778	01-Apr-20 (No. 217-03100/03101)	Apr-21
Power sensor NRP-Z91	SN: 103244	01-Apr-20 (No. 217-03100)	Apr-21
Power sensor NRP-Z91	SN: 103245	01-Apr-20 (No. 217-03101)	Apr-21
Reference 20 dB Attenuator	SN: BH9394 (20k)	31-Mar-20 (No. 217-03106)	Apr-21
Type-N mismatch combination	SN: 310982 / 06327	31-Mar-20 (No. 217-03104)	Apr-21
Reference Probe EX3DV4	SN: 3503	30-Dec-20 (No. EX3-3503_Dec20)	Dec-21
DAE4	SN: 601	02-Nov-20 (No. DAE4-601_Nov20)	Nov-21
Secondary Standards	ID #	Check Date (in house)	Scheduled Check
Power meter E4419B	SN: GB39512475	30-Oct-14 (in house check Oct-20)	In house check: Oct-22
Power sensor HP 8481A	SN: US37292783	07-Oct-15 (in house check Oct-20)	In house check: Oct-22
Power sensor HP 8481A	SN: MY41092317	07-Oct-15 (in house check Oct-20)	In house check: Oct-22
RF generator R&S SMT-06	SN: 100972	15-Jun-15 (in house check Oct-20)	In house check: Oct-22
Network Analyzer Agilent E8358A	SN: US41080477	31-Mar-14 (in house check Oct-20)	In house check: Oct-21

Calibrated by: **Claudio Leubler** **Laboratory Technician**

Signature

Approved by: **Katja Pokovic** **Technical Manager**

Issued: March 19, 2021

This calibration certificate shall not be reproduced except in full without written approval of the laboratory.



Accredited by the Swiss Accreditation Service (SAS)

Accreditation No.: **SCS 0108**

The Swiss Accreditation Service is one of the signatories to the EA
Multilateral Agreement for the recognition of calibration certificates

Glossary:

TSL	tissue simulating liquid
ConvF	sensitivity in TSL / NORM x,y,z
N/A	not applicable or not measured

Calibration is Performed According to the Following Standards:

- IEEE Std 1528-2013, "IEEE Recommended Practice for Determining the Peak Spatial-Averaged Specific Absorption Rate (SAR) in the Human Head from Wireless Communications Devices: Measurement Techniques", June 2013
- IEC 62209-1, "Measurement procedure for the assessment of Specific Absorption Rate (SAR) from hand-held and body-mounted devices used next to the ear (frequency range of 300 MHz to 6 GHz)", July 2016
- IEC 62209-2, "Procedure to determine the Specific Absorption Rate (SAR) for wireless communication devices used in close proximity to the human body (frequency range of 30 MHz to 6 GHz)", March 2010
- KDB 865664, "SAR Measurement Requirements for 100 MHz to 6 GHz"

Additional Documentation:

- DASY4/5 System Handbook

Methods Applied and Interpretation of Parameters:

- Measurement Conditions:** Further details are available from the Validation Report at the end of the certificate. All figures stated in the certificate are valid at the frequency indicated.
- Antenna Parameters with TSL:** The dipole is mounted with the spacer to position its feed point exactly below the center marking of the flat phantom section, with the arms oriented parallel to the body axis.
- Feed Point Impedance and Return Loss:** These parameters are measured with the dipole positioned under the liquid filled phantom. The impedance stated is transformed from the measurement at the SMA connector to the feed point. The Return Loss ensures low reflected power. No uncertainty required.
- Electrical Delay:** One-way delay between the SMA connector and the antenna feed point. No uncertainty required.
- SAR measured:** SAR measured at the stated antenna input power.
- SAR normalized:** SAR as measured, normalized to an input power of 1 W at the antenna connector.
- SAR for nominal TSL parameters:** The measured TSL parameters are used to calculate the nominal SAR result.

The reported uncertainty of measurement is stated as the standard uncertainty of measurement multiplied by the coverage factor $k=2$, which for a normal distribution corresponds to a coverage probability of approximately 95%.

Measurement Conditions

DASY system configuration, as far as not given on page 1.

DASY Version	DASY5	V52.10.4
Extrapolation	Advanced Extrapolation	
Phantom	Modular Flat Phantom V5.0	
Distance Dipole Center - TSL	10 mm	with Spacer
Zoom Scan Resolution	dx, dy = 4.0 mm, dz = 1.4 mm	Graded Ratio = 1.4 (Z direction)
Frequency	5250 MHz ± 1 MHz 5600 MHz ± 1 MHz 5750 MHz ± 1 MHz	

Head TSL parameters at 5250 MHz

The following parameters and calculations were applied.

	Temperature	Permittivity	Conductivity
Nominal Head TSL parameters	22.0 °C	35.9	4.71 mho/m
Measured Head TSL parameters	(22.0 ± 0.2) °C	34.7 ± 6 %	4.51 mho/m ± 6 %
Head TSL temperature change during test	< 0.5 °C	----	----

SAR result with Head TSL at 5250 MHz

SAR averaged over 1 cm³ (1 g) of Head TSL	Condition	
SAR measured	100 mW input power	8.13 W/kg
SAR for nominal Head TSL parameters	normalized to 1W	80.6 W/kg ± 19.9 % (k=2)

SAR averaged over 10 cm³ (10 g) of Head TSL	condition	
SAR measured	100 mW input power	2.32 W/kg
SAR for nominal Head TSL parameters	normalized to 1W	23.0 W/kg ± 19.5 % (k=2)

Head TSL parameters at 5600 MHz

The following parameters and calculations were applied.

	Temperature	Permittivity	Conductivity
Nominal Head TSL parameters	22.0 °C	35.5	5.07 mho/m
Measured Head TSL parameters	(22.0 ± 0.2) °C	34.2 ± 6 %	4.86 mho/m ± 6 %
Head TSL temperature change during test	< 0.5 °C	----	----

SAR result with Head TSL at 5600 MHz

SAR averaged over 1 cm³ (1 g) of Head TSL	Condition	
SAR measured	100 mW input power	8.32 W/kg
SAR for nominal Head TSL parameters	normalized to 1W	82.4 W/kg ± 19.9 % (k=2)

SAR averaged over 10 cm³ (10 g) of Head TSL	condition	
SAR measured	100 mW input power	2.36 W/kg
SAR for nominal Head TSL parameters	normalized to 1W	23.3 W/kg ± 19.5 % (k=2)

Head TSL parameters at 5750 MHz

The following parameters and calculations were applied.

	Temperature	Permittivity	Conductivity
Nominal Head TSL parameters	22.0 °C	35.4	5.22 mho/m
Measured Head TSL parameters	(22.0 ± 0.2) °C	34.0 ± 6 %	5.01 mho/m ± 6 %
Head TSL temperature change during test	< 0.5 °C	----	----

SAR result with Head TSL at 5750 MHz

SAR averaged over 1 cm ³ (1 g) of Head TSL	Condition	
SAR measured	100 mW input power	8.02 W/kg
SAR for nominal Head TSL parameters	normalized to 1W	79.4 W/kg ± 19.9 % (k=2)

SAR averaged over 10 cm ³ (10 g) of Head TSL	condition	
SAR measured	100 mW input power	2.27 W/kg
SAR for nominal Head TSL parameters	normalized to 1W	22.4 W/kg ± 19.5 % (k=2)

Appendix (Additional assessments outside the scope of SCS 0108)

Antenna Parameters with Head TSL at 5250 MHz

Impedance, transformed to feed point	54.1 Ω - 6.4 j Ω
Return Loss	- 22.7 dB

Antenna Parameters with Head TSL at 5600 MHz

Impedance, transformed to feed point	57.6 Ω - 2.5 j Ω
Return Loss	- 22.6 dB

Antenna Parameters with Head TSL at 5750 MHz

Impedance, transformed to feed point	57.9 Ω + 3.1 j Ω
Return Loss	- 22.1 dB

General Antenna Parameters and Design

Electrical Delay (one direction)	1.203 ns
----------------------------------	----------

After long term use with 100W radiated power, only a slight warming of the dipole near the feedpoint can be measured.

The dipole is made of standard semirigid coaxial cable. The center conductor of the feeding line is directly connected to the second arm of the dipole. The antenna is therefore short-circuited for DC-signals. On some of the dipoles, small end caps are added to the dipole arms in order to improve matching when loaded according to the position as explained in the "Measurement Conditions" paragraph. The SAR data are not affected by this change. The overall dipole length is still according to the Standard.

No excessive force must be applied to the dipole arms, because they might bend or the soldered connections near the feedpoint may be damaged.

Additional EUT Data

Manufactured by	SPEAG
-----------------	-------

DASY5 Validation Report for Head TSL

Date: 19.03.2021

Test Laboratory: SPEAG, Zurich, Switzerland

DUT: Dipole D5GHzV2; Type: D5GHzV2; Serial: D5GHzV2 - SN:1019

Communication System: UID 0 - CW; Frequency: 5250 MHz, Frequency: 5600 MHz, Frequency: 5750 MHz

Medium parameters used: $f = 5250$ MHz; $\sigma = 4.51$ S/m; $\epsilon_r = 34.7$; $\rho = 1000$ kg/m³

Medium parameters used: $f = 5600$ MHz; $\sigma = 4.86$ S/m; $\epsilon_r = 34.2$; $\rho = 1000$ kg/m³

Medium parameters used: $f = 5750$ MHz; $\sigma = 5.01$ S/m; $\epsilon_r = 34$; $\rho = 1000$ kg/m³

Phantom section: Flat Section

Measurement Standard: DASY5 (IEEE/IEC/ANSI C63.19-2011)

DASY52 Configuration:

- Probe: EX3DV4 - SN3503; ConvF(5.5, 5.5, 5.5) @ 5250 MHz, ConvF(5.1, 5.1, 5.1) @ 5600 MHz, ConvF(5.08, 5.08, 5.08) @ 5750 MHz; Calibrated: 30.12.2020
- Sensor-Surface: 1.4mm (Mechanical Surface Detection)
- Electronics: DAE4 Sn601; Calibrated: 02.11.2020
- Phantom: Flat Phantom 5.0 (front); Type: QD 000 P50 AA; Serial: 1001
- DASY52 52.10.4(1527); SEMCAD X 14.6.14(7483)

Dipole Calibration for Head Tissue/Pin=100mW, dist=10mm, f=5250 MHz/Zoom Scan,

dist=1.4mm (8x8x7)/Cube 0: Measurement grid: dx=4mm, dy=4mm, dz=1.4mm

Reference Value = 79.20 V/m; Power Drift = -0.00 dB

Peak SAR (extrapolated) = 27.6 W/kg

SAR(1 g) = 8.13 W/kg; SAR(10 g) = 2.32 W/kg

Smallest distance from peaks to all points 3 dB below = 7.2 mm

Ratio of SAR at M2 to SAR at M1 = 70.7%

Maximum value of SAR (measured) = 18.1 W/kg

Dipole Calibration for Head Tissue/Pin=100mW, dist=10mm, f=5600 MHz/Zoom Scan,

dist=1.4mm (8x8x7)/Cube 0: Measurement grid: dx=4mm, dy=4mm, dz=1.4mm

Reference Value = 77.00 V/m; Power Drift = -0.05 dB

Peak SAR (extrapolated) = 31.0 W/kg

SAR(1 g) = 8.32 W/kg; SAR(10 g) = 2.36 W/kg

Smallest distance from peaks to all points 3 dB below = 7.2 mm

Ratio of SAR at M2 to SAR at M1 = 66.9%

Maximum value of SAR (measured) = 19.6 W/kg

Dipole Calibration for Head Tissue/Pin=100mW, dist=10mm, f=5750 MHz/Zoom Scan, dist=1.4mm (8x8x7)/Cube 0: Measurement grid: dx=4mm, dy=4mm, dz=1.4mm

Reference Value = 74.22 V/m; Power Drift = -0.08 dB

Peak SAR (extrapolated) = 31.6 W/kg

SAR(1 g) = 8.02 W/kg; SAR(10 g) = 2.27 W/kg

Smallest distance from peaks to all points 3 dB below = 7.2 mm

Ratio of SAR at M2 to SAR at M1 = 65%

Maximum value of SAR (measured) = 19.2 W/kg

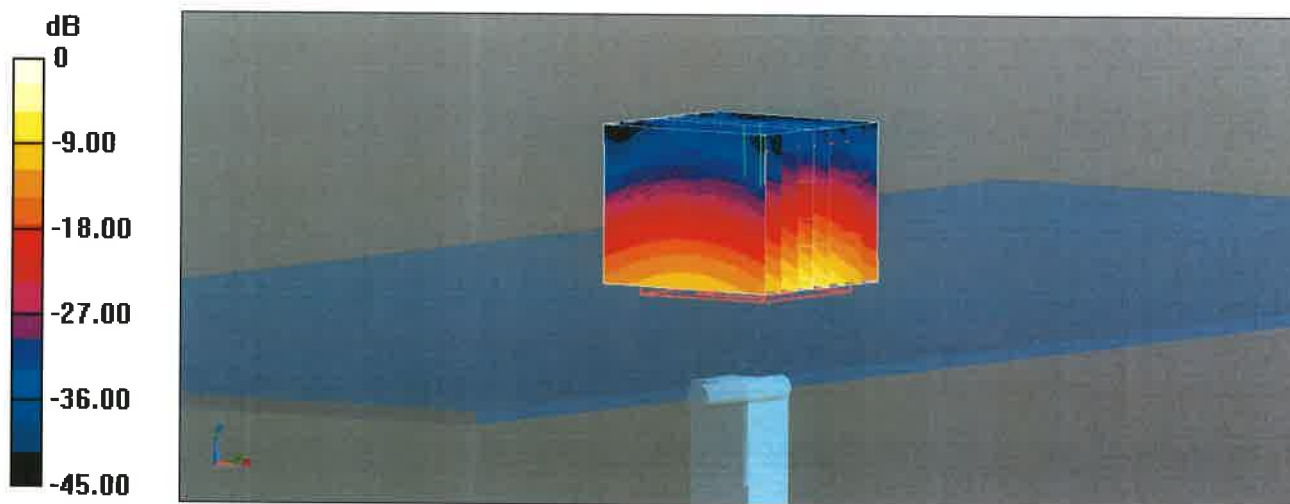

0 dB = 19.6 W/kg = 12.92 dBW/kg

Impedance Measurement Plot for Head TSL

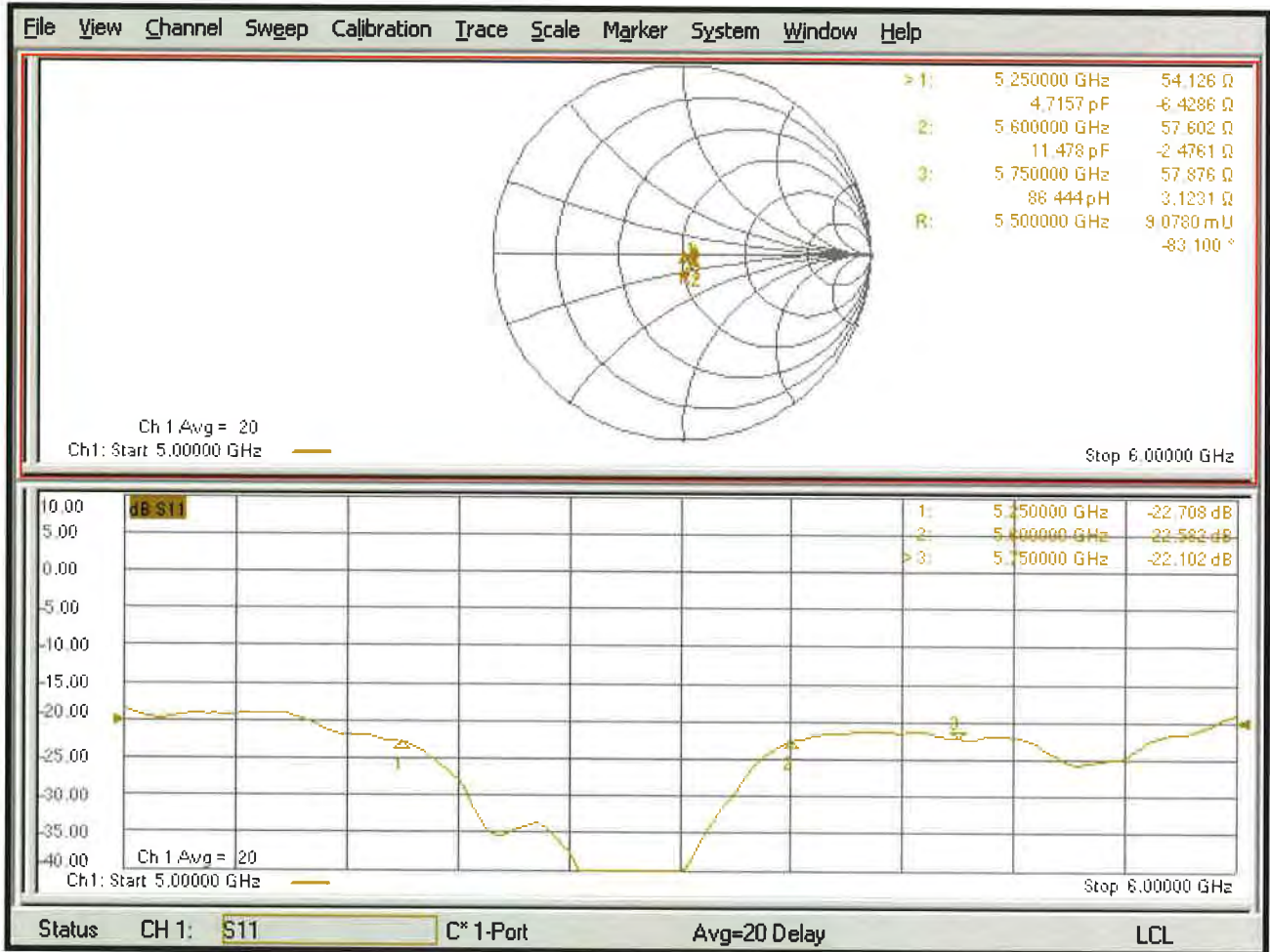



Annual Confirmation of SAR Reference Dipole

Model : D5000V2

S/N : 1019

Measurement Date : 2022/3/18

Frequency (MHz)	Type	Item	Previous Measurement	Annual Check	Deviation	Accepted Tolerance	Result
5250	Free Space	Real Impedance	54.126	50.625	-3.501	$\pm 5\Omega$	PASS
		Imaginary Impedance	-6.4286	-1.5238	4.905	$\pm 5\Omega$	PASS
		Return Loss	-22.708	-21.152	-6.85%	$\pm 20\%$	PASS
Frequency (MHz)	Type	Item	Previous Measurement	Annual Check	Deviation	Accepted Tolerance	Result
5600	Free Space	Real Impedance	57.602	53.069	-4.533	$\pm 5\Omega$	PASS
		Imaginary Impedance	-2.4761	1.1936	3.670	$\pm 5\Omega$	PASS
		Return Loss	-22.582	-22.463	-0.53%	$\pm 20\%$	PASS
Frequency (MHz)	Type	Item	Previous Measurement	Annual Check	Deviation	Accepted Tolerance	Result
5750	Free Space	Real Impedance	57.876	53.895	-3.981	$\pm 5\Omega$	PASS
		Imaginary Impedance	3.1231	0.0377	-3.085	$\pm 5\Omega$	PASS
		Return Loss	-22.102	-21.278	-3.73%	$\pm 20\%$	PASS

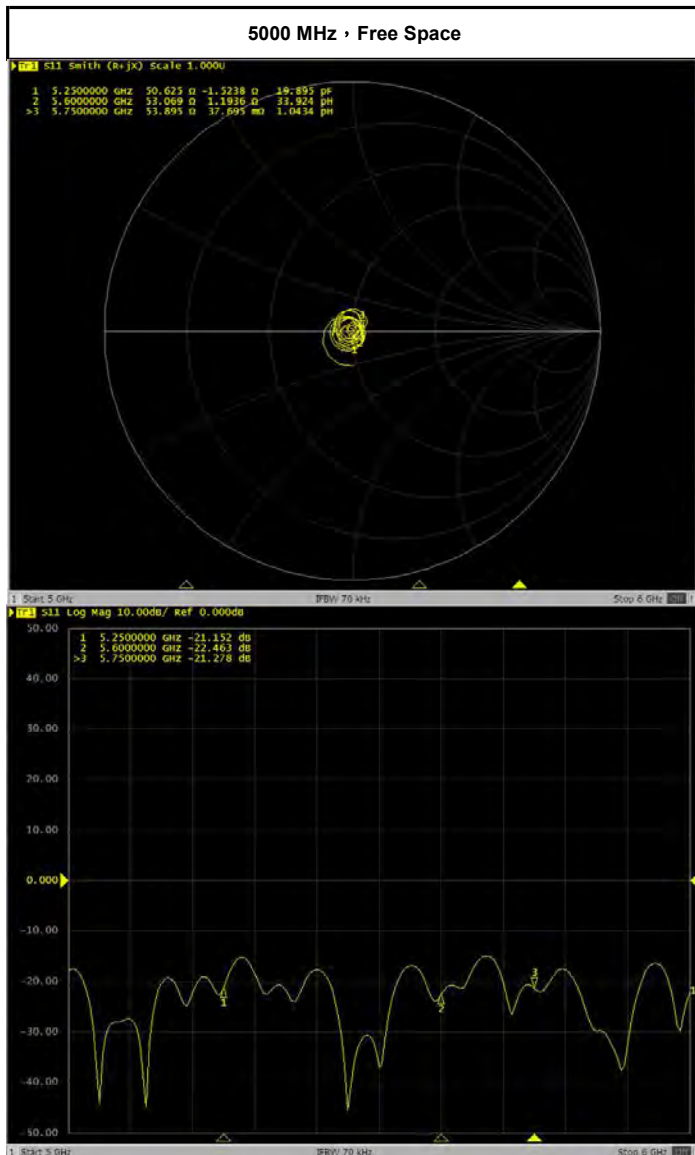



Accredited by the Swiss Accreditation Service (SAS)
The Swiss Accreditation Service is one of the signatories to the EA
Multilateral Agreement for the recognition of calibration certificates

Accreditation No.: **SCS 0108**

Client **B.V. ADT (Auden)**

Certificate No: **D6.5GHzV2-1008_Sep21**

CALIBRATION CERTIFICATE

Object **D6.5GHzV2 - SN:1008**

Calibration procedure(s) **QA CAL-22.v6
Calibration Procedure for SAR Validation Sources between 3-10 GHz**

Calibration date: **September 24, 2021**

This calibration certificate documents the traceability to national standards, which realize the physical units of measurements (SI).
The measurements and the uncertainties with confidence probability are given on the following pages and are part of the certificate.

All calibrations have been conducted in the closed laboratory facility: environment temperature (22 ± 3)°C and humidity < 70%.

Calibration Equipment used (M&TE critical for calibration)

Primary Standards	ID #	Cal Date (Certificate No.)	Scheduled Calibration
Power meter NRP	SN: 104778	09-Apr-21 (No. 217-03291/03292)	Apr-22
Power sensor NRP-Z91	SN: 103244	09-Apr-21 (No. 217-03291)	Apr-22
Power sensor NRP-Z91	SN: 103245	09-Apr-21 (No. 217-03292)	Apr-22
Power sensor R&S NRP33T	SN: 100967	08-Apr-21 (No. 217-03293)	Apr-22
Reference 20 dB Attenuator	SN: BH9394 (20k)	09-Apr-21 (No. 217-03343)	Apr-22
Type-N mismatch combination	SN: 310982 / 06327	09-Apr-21 (No. 217-03344)	Apr-22
Reference Probe EX3DV4	SN: 7405	30-Dec-20 (No. EX3-7405_Dec20)	Dec-21
DAE4	SN: 908	24-Jun-21 (No. DAE4-908_Jun21)	Jun-22
Secondary Standards	ID #	Check Date (in house)	Scheduled Check
RF generator Anapico APSIN20G	SN: 669	28-Mar-17 (in house check Dec-18)	In house check: Dec-21
Network Analyzer Keysight E5063A	SN:MY54504221	31-Oct-19 (in house check Oct-19)	In house check: Oct-22

Calibrated by: **Jeton Kastrati** (Name) **Laboratory Technician** (Function)  (Signature)

Approved by: **Katja Pokovic** (Name) **Technical Manager** (Function)  (Signature)

Issued: September 27, 2021

This calibration certificate shall not be reproduced except in full without written approval of the laboratory.



Accredited by the Swiss Accreditation Service (SAS)

The Swiss Accreditation Service is one of the signatories to the EA
Multilateral Agreement for the recognition of calibration certificates

Accreditation No.: **SCS 0108**

Glossary:

TSL	tissue simulating liquid
ConvF	sensitivity in TSL / NORM x,y,z
N/A	not applicable or not measured

Calibration is Performed According to the Following Standards:

- IEC/IEEE 62209-1528, "Measurement Procedure For The Assessment Of Specific Absorption Rate Of Human Exposure To Radio Frequency Fields From Hand-Held And Body-Worn Wireless Communication Devices - Part 1528: Human Models, Instrumentation And Procedures (Frequency Range of 4 MHz to 10 GHz)", October 2020.

Additional Documentation:

- DASY System Handbook

Methods Applied and Interpretation of Parameters:

- Measurement Conditions:** Further details are available from the Validation Report at the end of the certificate. All figures stated in the certificate are valid at the frequency indicated.
- Antenna Parameters with TSL:** The dipole is mounted with the spacer to position its feed point exactly below the center marking of the flat phantom section, with the arms oriented parallel to the body axis.
- Feed Point Impedance and Return Loss:** These parameters are measured with the dipole positioned under the liquid filled phantom. The impedance stated is transformed from the measurement at the SMA connector to the feed point. The Return Loss ensures low reflected power. No uncertainty required.
- SAR measured:** SAR measured at the stated antenna input power.
- SAR normalized:** SAR as measured, normalized to an input power of 1 W at the antenna connector.
- SAR for nominal TSL parameters:** The measured TSL parameters are used to calculate the nominal SAR result.
- The absorbed power density (APD):** The absorbed power density is evaluated according to Samaras T, Christ A, Kuster N, "Compliance assessment of the epithelial or absorbed power density above 6 GHz using SAR measurement systems", Bioelectromagnetics, 2021 (submitted). The additional evaluation uncertainty of 0.55 dB (rectangular distribution) is considered.

The reported uncertainty of measurement is stated as the standard uncertainty of measurement multiplied by the coverage factor $k=2$, which for a normal distribution corresponds to a coverage probability of approximately 95%.

Measurement Conditions

DASY system configuration, as far as not given on page 1.

DASY Version	DASY6	V16.0
Extrapolation	Advanced Extrapolation	
Phantom	Modular Flat Phantom	
Distance Dipole Center - TSL	5 mm	with Spacer
Zoom Scan Resolution	dx, dy = 3.4 mm, dz = 1.4 mm	Graded Ratio = 1.4 (Z direction)
Frequency	6500 MHz \pm 1 MHz	

Head TSL parameters

The following parameters and calculations were applied.

	Temperature	Permittivity	Conductivity
Nominal Head TSL parameters	22.0 °C	34.5	6.07 mho/m
Measured Head TSL parameters	(22.0 \pm 0.2) °C	33.6 \pm 6 %	6.11 mho/m \pm 6 %
Head TSL temperature change during test	< 0.5 °C	----	----

SAR result with Head TSL

SAR averaged over 1 cm³ (1 g) of Head TSL	Condition	
SAR measured	100 mW input power	29.1 W/kg
SAR for nominal Head TSL parameters	normalized to 1W	289 W/kg \pm 24.7 % (k=2)

SAR averaged over 10 cm³ (10 g) of Head TSL	condition	
SAR measured	100 mW input power	5.39 W/kg
SAR for nominal Head TSL parameters	normalized to 1W	53.5 W/kg \pm 24.4 % (k=2)

Appendix

Antenna Parameters with Head TSL

Impedance, transformed to feed point	51.9 Ω - 7.6 j Ω
Return Loss	- 22.3 dB

APD (Absorbed Power Density)

APD averaged over 1 cm ²	Condition	
APD measured	100 mW input power	289 W/m ²
APD measured	normalized to 1W	2890 W/m² \pm 29.2 % (k=2)

APD averaged over 4 cm ²	condition	
APD measured	100 mW input power	132 W/m ²
APD measured	normalized to 1W	1320 W/m² \pm 28.9 % (k=2)

General Antenna Parameters and Design

After long term use with 100W radiated power, only a slight warming of the dipole near the feedpoint can be measured.

The dipole is made of standard semirigid coaxial cable. The center conductor of the feeding line is directly connected to the second arm of the dipole. The antenna is therefore short-circuited for DC-signals. On some of the dipoles, small end caps are added to the dipole arms in order to improve matching when loaded according to the position as explained in the "Measurement Conditions" paragraph. The SAR data are not affected by this change. The overall dipole length is still according to the Standard.

No excessive force must be applied to the dipole arms, because they might bend or the soldered connections near the feedpoint may be damaged.

Additional EUT Data

Manufactured by	SPEAG
-----------------	-------

DASY6 Validation Report for Head TSL

Measurement Report for D6.5GHz-1008, UID 0 -, Channel 6500 (6500.0MHz)

Device under Test Properties

Name, Manufacturer	Dimensions [mm]	IMEI	DUT Type
D6.5GHz	16.0 x 6.0 x 300.0	SN: 1008	-

Exposure Conditions

Phantom Section, TSL	Position, Test Distance [mm]	Band	Group, UID	Frequency [MHz]	Conversion Factor	TSL Cond. [S/m]	TSL Permittivity
Flat, HSL	5.00	Band	CW,	6500	5.75	6.11	33.6

Hardware Setup

Phantom	TSL	Probe, Calibration Date	DAE, Calibration Date
MFP V8.0 Center - 1182	HBBL600-10000V6	EX3DV4 - SN7405, 2020-12-30	DAE4 Sn908, 2021-06-24

Scan Setup

	Zoom Scan
Grid Extents [mm]	22.0 x 22.0 x 22.0
Grid Steps [mm]	3.4 x 3.4 x 1.4
Sensor Surface [mm]	1.4
Graded Grid	Yes
Grading Ratio	1.4
MAIA	N/A
Surface Detection	VMS + 6p
Scan Method	Measured

Measurement Results

	Zoom Scan
Date	2021-09-24, 11:35
psSAR1g [W/Kg]	29.1
psSAR10g [W/Kg]	5.39
Power Drift [dB]	0.02
Power Scaling	Disabled
Scaling Factor [dB]	
TSL Correction	No correction
M2/M1 [%]	50.1
Dist 3dB Peak [mm]	4.8

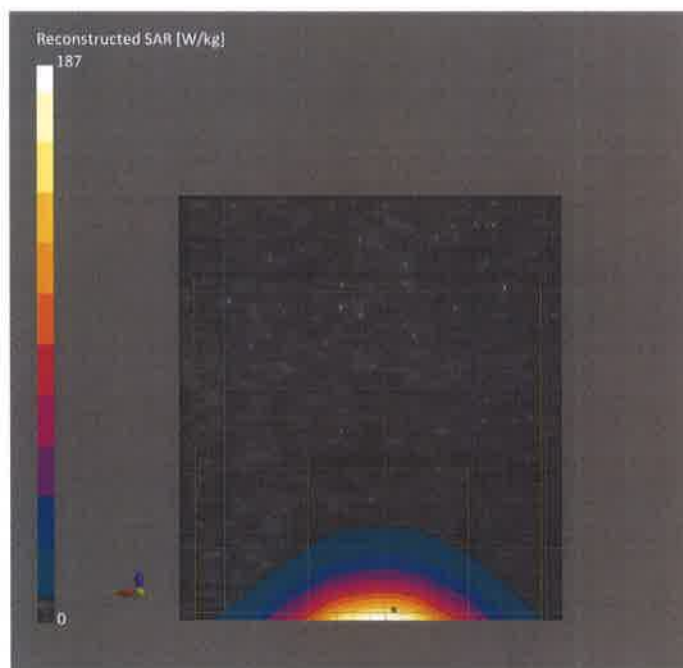

Impedance Measurement Plot for Head TSL

▶ Tr1 S11 Smith (R+jX) Scale 1.000 u [F1]

>1 6.5000000 GHz 51.894 Ω -7.5795 Ω 3.2305 pF

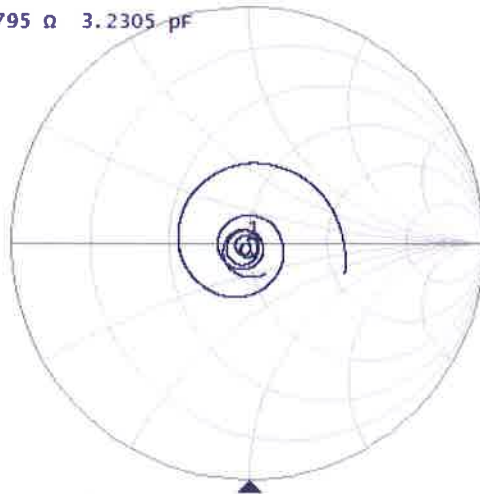

Tr2 S11 Log Mag 5.000 dB/ Ref -20.00 dB [F1]

>1 6.5000000 GHz -22.331 dB

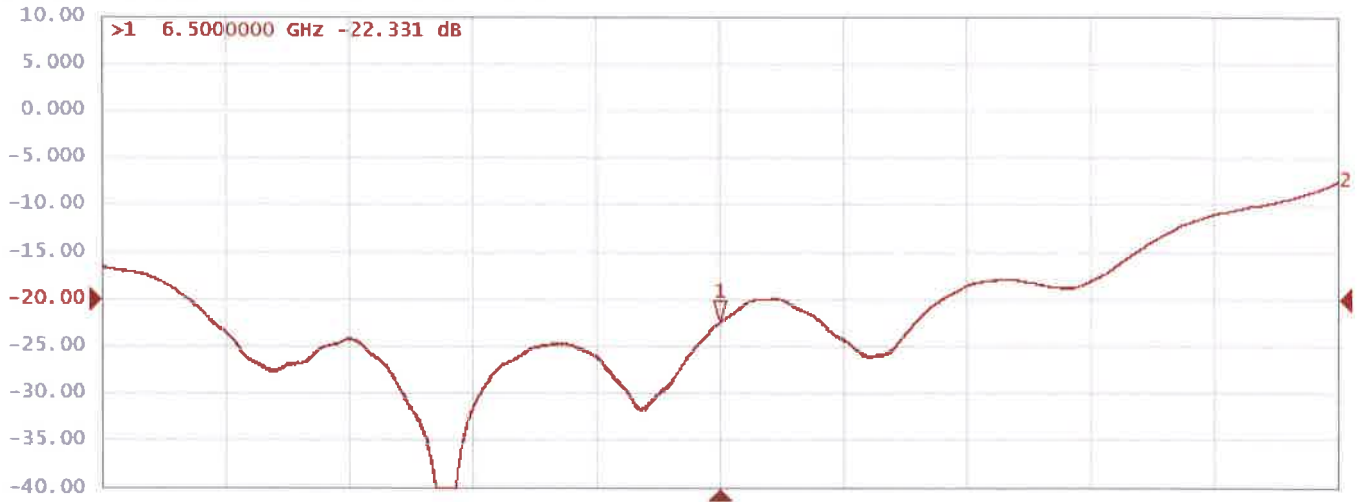



In Collaboration with
s p e a g
 CALIBRATION LABORATORY



中国认可
 国际互认
 校准
 CALIBRATION
 CNAS L0570

Add: No.52 HuaYuanBei Road, Haidian District, Beijing, 100191, Chi
 Tel: +86-10-62304633-2079 Fax: +86-10-62304633-2504
 E-mail: cttl@chinattl.com http://www.chinattl.cn

Client

B.V.ADT

Certificate No:

Z21-60284

CALIBRATION CERTIFICATE

Object

D2450V2 - SN: 737

Calibration Procedure(s)

FF-Z11-003-01

Calibration Procedures for dipole validation kits

Calibration date:

August 26, 2021

This calibration Certificate documents the traceability to national standards, which realize the physical units of measurements (SI). The measurements and the uncertainties with confidence probability are given on the following pages and are part of the certificate.

All calibrations have been conducted in the closed laboratory facility: environment temperature (22±3)°C and humidity<70%.

Calibration Equipment used (M&TE critical for calibration)

Primary Standards	ID #	Cal Date (Calibrated by, Certificate No.)	Scheduled Calibration
Power Meter NRP2	106277	23-Sep-20 (CTTL, No.J20X08336)	Sep-21
Power sensor NRP8S	104291	23-Sep-20 (CTTL, No.J20X08336)	Sep-21
Reference Probe EX3DV4	SN 7517	03-Feb-21(CTTL-SPEAG,No.Z21-60001)	Feb-22
DAE3	SN 536	06-Nov-20(CTTL-SPEAG,No.Z20-60452)	Nov-21
Secondary Standards	ID #	Cal Date (Calibrated by, Certificate No.)	Scheduled Calibration
Signal Generator E4438C	MY49071430	01-Feb-21 (CTTL, No.J21X00593)	Jan-22
NetworkAnalyzer E5071C	MY46110673	14-Jan-21 (CTTL, No.J21X00232)	Jan-22

	Name	Function	Signature
Calibrated by:	Zhao Jing	SAR Test Engineer	
Reviewed by:	Lin Hao	SAR Test Engineer	
Approved by:	Qi Dianyuan	SAR Project Leader	

Issued: August 31, 2021

This calibration certificate shall not be reproduced except in full without written approval of the laboratory.



In Collaboration with

s p e a g
CALIBRATION LABORATORY

Add: No.52 HuaYuanBei Road, Haidian District, Beijing, 100191, China
Tel: +86-10-62304633-2079 Fax: +86-10-62304633-2504
E-mail: cttl@chinattl.com http://www.chinattl.cn

Glossary:

TSL	tissue simulating liquid
ConvF	sensitivity in TSL / NORM _{x,y,z}
N/A	not applicable or not measured

Calibration is Performed According to the Following Standards:

- IEEE Std 1528-2013, "IEEE Recommended Practice for Determining the Peak Spatial-Averaged Specific Absorption Rate (SAR) in the Human Head from Wireless Communications Devices: Measurement Techniques", June 2013
- IEC 62209-1, "Measurement procedure for assessment of specific absorption rate of human exposure to radio frequency fields from hand-held and body-mounted wireless communication devices- Part 1: Device used next to the ear (Frequency range of 300MHz to 6GHz)", July 2016
- IEC 62209-2, "Procedure to measure the Specific Absorption Rate (SAR) For wireless communication devices used in close proximity to the human body (frequency range of 30MHz to 6GHz)", March 2010
- KDB865664, SAR Measurement Requirements for 100 MHz to 6 GHz

Additional Documentation:

- DASY4/5 System Handbook

Methods Applied and Interpretation of Parameters:

- Measurement Conditions:** Further details are available from the Validation Report at the end of the certificate. All figures stated in the certificate are valid at the frequency indicated.
- Antenna Parameters with TSL:** The dipole is mounted with the spacer to position its feed point exactly below the center marking of the flat phantom section, with the arms oriented parallel to the body axis.
- Feed Point Impedance and Return Loss:** These parameters are measured with the dipole positioned under the liquid filled phantom. The impedance stated is transformed from the measurement at the SMA connector to the feed point. The Return Loss ensures low reflected power. No uncertainty required.
- Electrical Delay:** One-way delay between the SMA connector and the antenna feed point. No uncertainty required.
- SAR measured:** SAR measured at the stated antenna input power.
- SAR normalized:** SAR as measured, normalized to an input power of 1 W at the antenna connector.
- SAR for nominal TSL parameters:** The measured TSL parameters are used to calculate the nominal SAR result.

The reported uncertainty of measurement is stated as the standard uncertainty of Measurement multiplied by the coverage factor $k=2$, which for a normal distribution Corresponds to a coverage probability of approximately 95%.



Add: No.52 HuaYuanBei Road, Haidian District, Beijing, 100191, China
Tel: +86-10-62304633-2079 Fax: +86-10-62304633-2504
E-mail: cttl@chinattl.com http://www.chinattl.cn

Measurement Conditions

DASY system configuration, as far as not given on page 1.

DASY Version	DASY52	V52.10.4
Extrapolation	Advanced Extrapolation	
Phantom	Triple Flat Phantom 5.1C	
Distance Dipole Center - TSL	10 mm	with Spacer
Zoom Scan Resolution	dx, dy, dz = 5 mm	
Frequency	2450 MHz ± 1 MHz	

Head TSL parameters

The following parameters and calculations were applied.

	Temperature	Permittivity	Conductivity
Nominal Head TSL parameters	22.0 °C	39.2	1.80 mho/m
Measured Head TSL parameters	(22.0 ± 0.2) °C	40.0 ± 6 %	1.77 mho/m ± 6 %
Head TSL temperature change during test	<1.0 °C	----	----

SAR result with Head TSL

SAR averaged over 1 cm³ (1 g) of Head TSL	Condition	
SAR measured	250 mW input power	13.0 W/kg
SAR for nominal Head TSL parameters	normalized to 1W	52.6 W/kg ± 18.8 % (k=2)
SAR averaged over 10 cm³ (10 g) of Head TSL	Condition	
SAR measured	250 mW input power	5.92 W/kg
SAR for nominal Head TSL parameters	normalized to 1W	23.9 W/kg ± 18.7 % (k=2)



Add: No.52 HuaYuanBei Road, Haidian District, Beijing, 100191, China
Tel: +86-10-62304633-2079 Fax: +86-10-62304633-2504
E-mail: cttl@chinattl.com http://www.chinattl.cn

Appendix (Additional assessments outside the scope of CNAS L0570)

Antenna Parameters with Head TSL

Impedance, transformed to feed point	54.0Ω+ 4.29jΩ
Return Loss	- 25.0dB

General Antenna Parameters and Design

Electrical Delay (one direction)	1.067 ns
----------------------------------	----------

After long term use with 100W radiated power, only a slight warming of the dipole near the feedpoint can be measured.

The dipole is made of standard semirigid coaxial cable. The center conductor of the feeding line is directly connected to the second arm of the dipole. The antenna is therefore short-circuited for DC-signals. On some of the dipoles, small end caps are added to the dipole arms in order to improve matching when loaded according to the position as explained in the "Measurement Conditions" paragraph. The SAR data are not affected by this change. The overall dipole length is still according to the Standard.

No excessive force must be applied to the dipole arms, because they might bend or the soldered connections near the feedpoint may be damaged.

Additional EUT Data

Manufactured by	SPEAG
-----------------	-------



Add: No.52 HuaYuanBei Road, Haidian District, Beijing, 100191, China
Tel: +86-10-62304633-2079 Fax: +86-10-62304633-2504
E-mail: cttl@chinattl.com http://www.chinattl.cn

DASY5 Validation Report for Head TSL

Date: 08.26.2021

Test Laboratory: CTTL, Beijing, China

DUT: Dipole 2450 MHz; Type: D2450V2; Serial: D2450V2 - SN: 737

Communication System: UID 0, CW; Frequency: 2450 MHz; Duty Cycle: 1:1

Medium parameters used: $f = 2450$ MHz; $\sigma = 1.772$ S/m; $\epsilon_r = 40.04$; $\rho = 1000$ kg/m³

Phantom section: Right Section

DASY5 Configuration:

- Probe: EX3DV4 - SN7517; ConvF(7.34, 7.34, 7.34) @ 2450 MHz; Calibrated: 2021-02-03
- Sensor-Surface: 1.4mm|(Mechanical Surface Detection)
- Electronics: DAE3 Sn536; Calibrated: 2020-11-06
- Phantom: MFP_V5.1C (20deg probe tilt); Type: QD 000 P51 Cx; Serial: 1062
- Measurement SW: DASY52, Version 52.10 (4); SEMCAD X Version 14.6.14 (7483)

Dipole Calibration/Zoom Scan (7x7x7) (7x7x7)/Cube 0: Measurement grid: dx=5mm, dy=5mm, dz=5mm

Reference Value = 108.5 V/m; Power Drift = -0.01 dB

Peak SAR (extrapolated) = 27.8 W/kg

SAR(1 g) = 13 W/kg; SAR(10 g) = 5.92 W/kg

Smallest distance from peaks to all points 3 dB below = 9 mm

Ratio of SAR at M2 to SAR at M1 = 46.7%

Maximum value of SAR (measured) = 22.3 W/kg

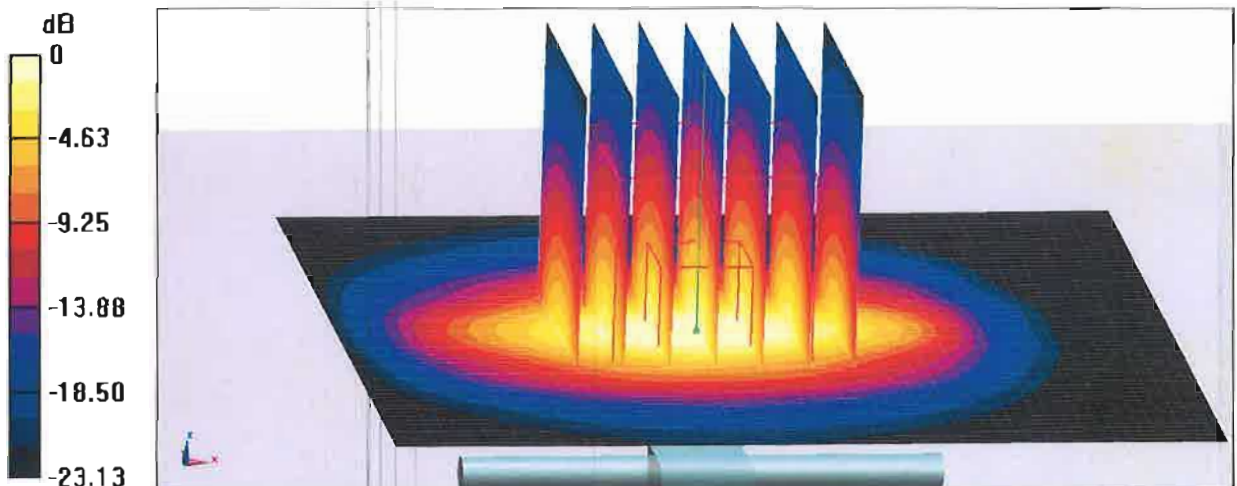

0 dB = 22.3 W/kg = 13.48 dBW/kg



Add: No.52 HuaYuanBei Road, Haidian District, Beijing, 100191, China
Tel: +86-10-62304633-2079 Fax: +86-10-62304633-2504
E-mail: cttl@chinattl.com http://www.chinattl.cn

Impedance Measurement Plot for Head TSL

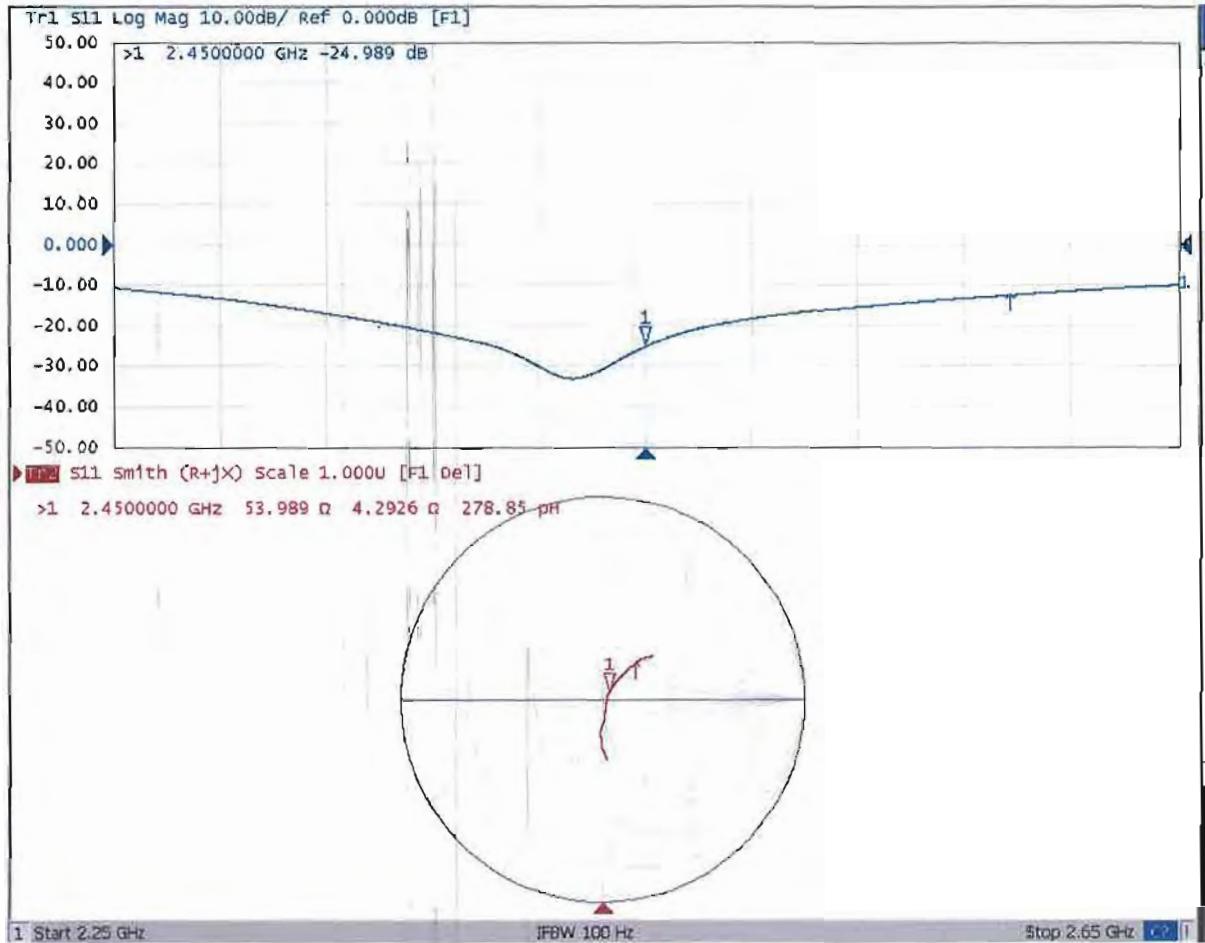

**Calibration Laboratory of
Schmid & Partner
Engineering AG**
Zeughausstrasse 43, 8004 Zurich, Switzerland



S Schweizerischer Kalibrierdienst
C Service suisse d'étalonnage
S Servizio svizzero di taratura
Swiss Calibration Service

Accredited by the Swiss Accreditation Service (SAS)
The Swiss Accreditation Service is one of the signatories to the EA
Multilateral Agreement for the recognition of calibration certificates

Accreditation No.: **SCS 0108**

Client **B.V. ADT (Auden)**

Certificate No: **EUmmWV3-9361_Aug21**

CALIBRATION CERTIFICATE

Object **EUmmWV3 - SN:9361**

Calibration procedure(s) **QA CAL-02.v9, QA CAL-25.v7, QA CAL-42.v2**
Calibration procedure for E-field probes optimized for close near field evaluations in air

Calibration date: **August 25, 2021**

This calibration certificate documents the traceability to national standards, which realize the physical units of measurements (SI).
The measurements and the uncertainties with confidence probability are given on the following pages and are part of the certificate.

All calibrations have been conducted in the closed laboratory facility: environment temperature (22 ± 3)°C and humidity < 70%.

Calibration Equipment used (M&TE critical for calibration)

Primary Standards	ID	Cal Date (Certificate No.)	Scheduled Calibration
Power meter NRP	SN: 104778	09-Apr-21 (No. 217-03291/0292)	Apr-22
Power sensor NRP-Z91	SN: 103244	09-Apr-21 (No. 217-03291)	Apr-22
Power sensor NRP-Z91	SN: 103245	09-Apr-21 (No. 217-03292)	Apr-22
Reference 20 dB Attenuator	SN: CC2552 (20x)	09-Apr-21 (No. 217-03343)	Apr-22
Reference Probe ER3DV6	SN: 2328	05-Oct-20 (No. ER3-2328_Oct20)	Oct-21
DAE4	SN: 789	23-Dec-20 (No. DAE4-789_Dec20)	Dec-21
Secondary Standards	ID	Check Date (in house)	Scheduled Check
Power meter E4419B	SN: GB41293874	06-Apr-16 (in house check Jun-20)	In house check: Jun-22
Power sensor E4412A	SN: MY41498087	06-Apr-16 (in house check Jun-20)	In house check: Jun-22
Power sensor E4412A	SN: 000110210	06-Apr-16 (in house check Jun-20)	In house check: Jun-22
RF generator HP 8648C	SN: US3642U01700	04-Aug-99 (in house check Jun-20)	In house check: Jun-22
Network Analyzer E8358A	SN: US41080477	31-Mar-14 (in house check Oct-20)	In house check: Oct-21

	Name	Function	Signature
Calibrated by:	Leif Klysner	Laboratory Technician	
Approved by:	Niels Kuster	Quality Manager	

Issued: September 7, 2021

This calibration certificate shall not be reproduced except in full without written approval of the laboratory.



Accredited by the Swiss Accreditation Service (SAS)
The Swiss Accreditation Service is one of the signatories to the EA
Multilateral Agreement for the recognition of calibration certificates

Accreditation No.: **SCS 0108**

Glossary:

NORM _{x,y,z}	sensitivity in free space
DCP	diode compression point
CF	crest factor (1/duty_cycle) of the RF signal
A, B, C, D	modulation dependent linearization parameters
Polarization φ	φ rotation around probe axis
Polarization ϑ	ϑ rotation around an axis that is in the plane normal to probe axis (at measurement center), i.e., $\vartheta = 0$ is normal to probe axis
Connector Angle	information used in DASY system to align probe sensor X to the robot coordinate system
Sensor Angles	sensor deviation from the probe axis, used to calculate the field orientation and polarization
k	is the wave propagation direction

Calibration is Performed According to the Following Standards:

- IEEE Std 1309-2005, "IEEE Standard for calibration of electromagnetic field sensors and probes, excluding antennas, from 9 kHz to 40 GHz", December 2005

Methods Applied and Interpretation of Parameters:

- NORM_{x,y,z}**: Assessed for E-field polarization $\vartheta = 0$ for XY sensors and $\vartheta = 90$ for Z sensor ($f \leq 900$ MHz in TEM-cell; $f > 1800$ MHz: R22 waveguide). For frequencies > 6 GHz, the far field in front of waveguide horn antennas is measured for a set of frequencies in various waveguide bands up to 110 GHz.
- DCP_{x,y,z}**: DCP are numerical linearization parameters assessed based on the data of power sweep with CW signal (no uncertainty required). DCP does not depend on frequency nor media.
- PAR**: PAR is the Peak to Average Ratio that is not calibrated but determined based on the signal characteristics
- The frequency sensor model parameters are determined prior to calibration based on a frequency sweep (sensor model involving resistors R , R_p , inductance L and capacitors C , C_p).
- A_{x,y,z}; B_{x,y,z}; C_{x,y,z}; D_{x,y,z}; VR_{x,y,z}**: A, B, C, D are numerical linearization parameters assessed based on the data of power sweep for specific modulation signal. The parameters do not depend on frequency nor media. VR is the maximum calibration range expressed in RMS voltage across the diode.
- Sensor Offset**: The sensor offset corresponds to the mechanical from the probe tip (on probe axis). No tolerance required.
- Connector Angle**: The angle is assessed using the information gained by determining the NORM_x (no uncertainty required).
- Equivalent Sensor Angle**: The two probe sensors are mounted in the same plane at different angles. The angles are assessed using the information gained by determining the NORM_x (no uncertainty required).
- Spherical isotropy (3D deviation from isotropy)**: in a locally homogeneous field realized using an open waveguide / horn setup.

DASY - Parameters of Probe: EUmmWV3 - SN:9361

Basic Calibration Parameters

	Sensor X	Sensor Y	Unc (k=2)
Norm ($\mu V/(V/m)^2$)	0.02126	0.02373	$\pm 10.1\%$
DCP (mV) ^B	107.0	105.0	
Equivalent Sensor Angle	-57.0	31.2	

Calibration results for Frequency Response (750 MHz – 110 GHz)

Frequency GHz	Target E-Field V/m	Deviation Sensor X dB	Deviation Sensor Y dB	Unc (k=2) dB
0.75	77.2	-0.21	0.32	± 0.43 dB
1.8	140.4	0.11	0.21	± 0.43 dB
2	133.0	0.07	0.12	± 0.43 dB
2.2	124.8	0.07	0.04	± 0.43 dB
2.5	123.0	-0.04	-0.14	± 0.43 dB
3.5	256.2	0.06	-0.22	± 0.43 dB
3.7	249.8	0.03	-0.27	± 0.43 dB
6.6	41.8	0.39	0.48	± 0.98 dB
8	48.4	0.04	-0.16	± 0.98 dB
10	54.4	-0.04	0.01	± 0.98 dB
15	71.5	-0.05	-0.44	± 0.98 dB
18	85.3	-0.11	0.17	± 0.98 dB
26.6	96.9	-0.02	0.00	± 0.98 dB
30	92.6	0.05	0.03	± 0.98 dB
35	93.7	-0.10	0.04	± 0.98 dB
40	91.5	-0.06	-0.19	± 0.98 dB
50	19.6	-0.09	0.03	± 0.98 dB
55	22.4	0.77	0.51	± 0.98 dB
60	23.0	-0.08	-0.07	± 0.98 dB
65	27.4	-0.04	-0.10	± 0.98 dB
70	23.9	0.26	-0.13	± 0.98 dB
75	20.0	-0.24	-0.12	± 0.98 dB
75	14.8	-0.32	-0.18	± 0.98 dB
80	22.5	0.32	0.36	± 0.98 dB
85	22.8	0.34	0.15	± 0.98 dB
90	23.8	0.03	0.09	± 0.98 dB
92	23.9	-0.07	-0.24	± 0.98 dB
95	20.5	-0.18	-0.27	± 0.98 dB
97	24.4	-0.11	-0.23	± 0.98 dB
100	22.6	-0.09	-0.16	± 0.98 dB
105	22.7	0.00	0.07	± 0.98 dB
110	19.7	0.23	0.29	± 0.98 dB

The reported uncertainty of measurement is stated as the standard uncertainty of measurement multiplied by the coverage factor k=2, which for a normal distribution corresponds to a coverage probability of approximately 95%.

^B Numerical linearization parameter: uncertainty not required.

^E Uncertainty is determined using the max. deviation from linear response applying rectangular distribution and is expressed for the square of the field value.

DASY - Parameters of Probe: EUmmWV3 - SN:9361

Calibration Results for Modulation Response

UID	Communication System Name		A dB	B dB $\sqrt{\mu}$ V	C	D dB	VR mV	Max dev.	Max Unc ^E (k=2)
0	CW	X	0.00	0.00	1.00	0.00	124.4	± 3.5 %	± 4.7 %
		Y	0.00	0.00	1.00		99.6		
10352-AAA	Pulse Waveform (200Hz, 10%)	X	1.08	60.00	13.30	10.00	6.0	± 1.1 %	± 9.6 %
		Y	1.17	60.00	13.47		6.0		
10353-AAA	Pulse Waveform (200Hz, 20%)	X	0.71	60.00	12.39	6.99	12.0	± 0.6 %	± 9.6 %
		Y	0.75	60.00	12.68		12.0		
10354-AAA	Pulse Waveform (200Hz, 40%)	X	0.42	60.00	11.37	3.98	23.0	± 0.6 %	± 9.6 %
		Y	0.44	60.00	11.80		23.0		
10355-AAA	Pulse Waveform (200Hz, 60%)	X	0.28	60.00	10.69	2.22	27.0	± 0.7 %	± 9.6 %
		Y	0.31	60.00	11.09		27.0		
10387-AAA	QPSK Waveform, 1 MHz	X	0.72	60.00	10.83	1.00	22.0	± 0.6 %	± 9.6 %
		Y	0.74	60.00	11.10		22.0		
10388-AAA	QPSK Waveform, 10 MHz	X	1.13	60.00	11.54	0.00	22.0	± 0.7 %	± 9.6 %
		Y	1.15	60.00	11.76		22.0		
10396-AAA	64-QAM Waveform, 100 kHz	X	1.48	60.00	13.71	3.01	17.0	± 0.8 %	± 9.6 %
		Y	1.60	60.00	13.44		17.0		
10399-AAA	64-QAM Waveform, 40 MHz	X	1.99	60.00	12.19	0.00	19.0	± 0.5 %	± 9.6 %
		Y	1.97	60.00	12.39		19.0		
10414-AAA	WLAN CCDF, 64-QAM, 40MHz	X	2.86	60.00	12.62	0.00	12.0	± 0.5 %	± 9.6 %
		Y	2.83	60.00	12.80		12.0		

Note: For details on all calibrated UID parameters see Appendix

Calibration Results for Linearity Response

Frequency GHz	Target E-Field V/m	Deviation Sensor X dB	Deviation Sensor Y dB	Unc (k=2) dB
0.9	50.0	-0.14	0.00	± 0.2 dB
0.9	100.0	-0.13	0.13	± 0.2 dB
0.9	500.0	0.01	0.07	± 0.2 dB
0.9	1000.0	0.03	0.09	± 0.2 dB
0.9	1500.0	0.03	0.11	± 0.2 dB
0.9	2000.0	0.00	0.07	± 0.2 dB

Sensor Frequency Model Parameters (750 MHz – 55 GHz)

	Sensor X	Sensor Y
R (Ω)	81.67	79.54
R _p (Ω)	88.53	90.42
L (nH)	0.10591	0.10330
C (pF)	0.3366	0.3298
C _p (pF)	0.0765	0.0713

Sensor Frequency Model Parameters (55 GHz – 110 GHz)

	Sensor X	Sensor Y
R (Ω)	40.08	44.41
R _p (Ω)	92.93	91.76
L (nH)	0.02791	0.02638
C (pF)	0.3100	0.4590
C _p (pF)	0.1314	0.1255

DASY - Parameters of Probe: EUmmWV3 - SN:9361

Sensor Model Parameters

	C1 fF	C2 fF	α V^{-1}	T1 $ms.V^{-2}$	T2 $ms.V^{-1}$	T3 ms	T4 V^{-2}	T5 V^{-1}	T6
X	17.8	127.97	32.91	0.92	1.38	4.99	0.00	0.16	1.01
Y	18.1	130.64	33.29	0.92	1.59	4.99	0.00	0.33	1.00

Other Probe Parameters

Sensor Arrangement	Rectangular
Connector Angle (°)	-5.0
Mechanical Surface Detection Mode	enabled
Optical Surface Detection Mode	disabled
Probe Overall Length	320 mm
Probe Body Diameter	8 mm
Tip Length	23 mm
Tip Diameter	8.0 mm
Probe Tip to Sensor X Calibration Point	1.5 mm
Probe Tip to Sensor Y Calibration Point	1.5 mm

Deviation from Isotropy in Air

$f = 30, 90 \text{ GHz}$

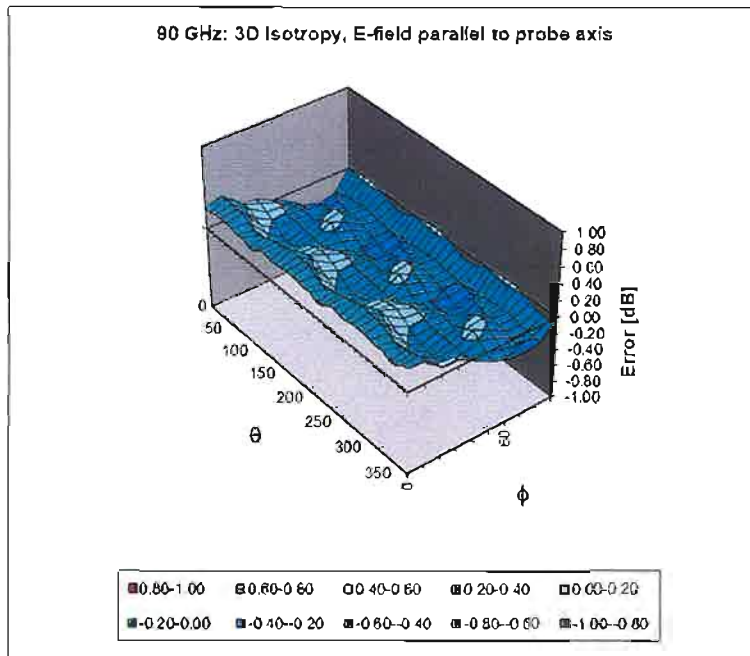
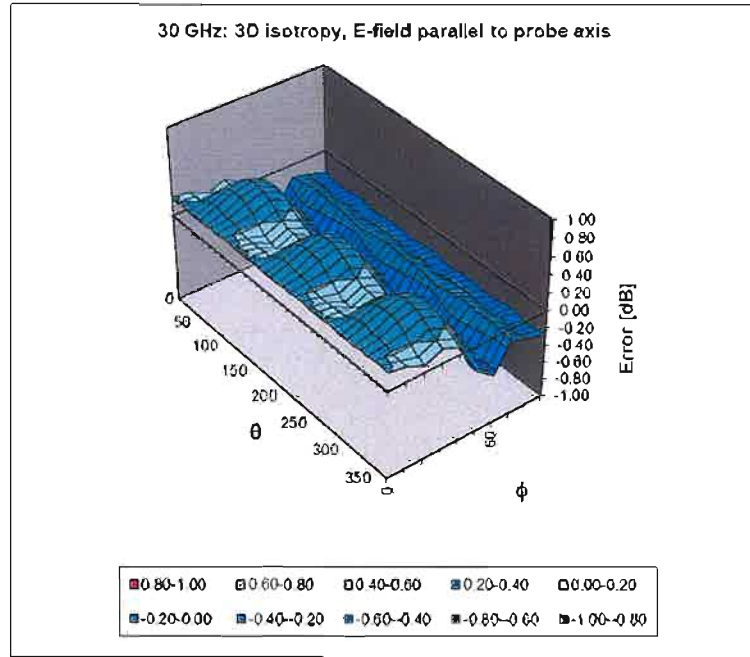

Probe isotropy for E_{tot} : probe rotated $\varphi = 0^\circ$ to 360° , tilted from field propagation direction \vec{k}
 Parallel to the field propagation ($\psi = 0^\circ - 90^\circ$) at 30 GHz: deviation within $\pm 0.43 \text{ dB}$
 Parallel to the field propagation ($\psi = 0^\circ - 90^\circ$) at 90 GHz: deviation within $\pm 0.32 \text{ dB}$

Appendix: Modulation Calibration Parameters

UID	Rev	Communication System Name	Group	PAR (dB)	Unc ^E (k=2)
0		CW	CW	0.00	± 4.7 %
10010	CAA	SAR Validation (Square, 100ms, 10ms)	Test	10.00	± 9.6 %
10011	CAB	UMTS-FDD (WCDMA)	WCDMA	2.91	± 9.6 %
10012	CAB	IEEE 802.11b WiFi 2.4 GHz (DSSS, 1 Mbps)	WLAN	1.87	± 9.6 %
10013	CAB	IEEE 802.11g WiFi 2.4 GHz (DSSS-OFDM, 6 Mbps)	WLAN	9.46	± 9.6 %
10021	DAC	GSM-FDD (TDMA, GMSK)	GSM	9.39	± 9.6 %
10023	DAC	GPRS-FDD (TDMA, GMSK, TN 0)	GSM	9.57	± 9.6 %
10024	DAC	GPRS-FDD (TDMA, GMSK, TN 0-1)	GSM	6.56	± 9.6 %
10025	DAC	EDGE-FDD (TDMA, 8PSK, TN 0)	GSM	12.62	± 9.6 %
10026	DAC	EDGE-FDD (TDMA, 8PSK, TN 0-1)	GSM	9.55	± 9.6 %
10027	DAC	GPRS-FDD (TDMA, GMSK, TN 0-1-2)	GSM	4.80	± 9.6 %
10028	DAC	GPRS-FDD (TDMA, GMSK, TN 0-1-2-3)	GSM	3.55	± 9.6 %
10029	DAC	EDGE-FDD (TDMA, 8PSK, TN 0-1-2)	GSM	7.78	± 9.6 %
10030	CAA	IEEE 802.15.1 Bluetooth (GFSK, DH1)	Bluetooth	5.30	± 9.6 %
10031	CAA	IEEE 802.15.1 Bluetooth (GFSK, DH3)	Bluetooth	1.87	± 9.6 %
10032	CAA	IEEE 802.15.1 Bluetooth (GFSK, DH5)	Bluetooth	1.16	± 9.6 %
10033	CAA	IEEE 802.15.1 Bluetooth (PI/4-DQPSK, DH1)	Bluetooth	7.74	± 9.6 %
10034	CAA	IEEE 802.15.1 Bluetooth (PI/4-DQPSK, DH3)	Bluetooth	4.53	± 9.6 %
10035	CAA	IEEE 802.15.1 Bluetooth (PI/4-DQPSK, DH5)	Bluetooth	3.83	± 9.6 %
10036	CAA	IEEE 802.15.1 Bluetooth (8-DPSK, DH1)	Bluetooth	8.01	± 9.6 %
10037	CAA	IEEE 802.15.1 Bluetooth (8-DPSK, DH3)	Bluetooth	4.77	± 9.6 %
10038	CAA	IEEE 802.15.1 Bluetooth (8-DPSK, DH5)	Bluetooth	4.10	± 9.6 %
10039	CAB	CDMA2000 (1xRTT, RC1)	CDMA2000	4.57	± 9.6 %
10042	CAB	IS-54 / IS-136 FDD (TDMA/FDM, PI/4-DQPSK, Halfrate)	AMPS	7.78	± 9.6 %
10044	CAA	IS-91/EIA/TIA-553 FDD (FDMA, FM)	AMPS	0.00	± 9.6 %
10048	CAA	DECT (TDD, TDMA/FDM, GFSK, Full Slot, 24)	DECT	13.80	± 9.6 %
10049	CAA	DECT (TDD, TDMA/FDM, GFSK, Double Slot, 12)	DECT	10.79	± 9.6 %
10056	CAA	UMTS-TDD (TD-SCDMA, 1.28 Mcps)	TD-SCDMA	11.01	± 9.6 %
10058	DAC	EDGE-FDD (TDMA, 8PSK, TN 0-1-2-3)	GSM	6.52	± 9.6 %
10059	CAB	IEEE 802.11b WiFi 2.4 GHz (DSSS, 2 Mbps)	WLAN	2.12	± 9.6 %
10060	CAB	IEEE 802.11b WiFi 2.4 GHz (DSSS, 5.5 Mbps)	WLAN	2.83	± 9.6 %
10061	CAB	IEEE 802.11b WiFi 2.4 GHz (DSSS, 11 Mbps)	WLAN	3.60	± 9.6 %
10062	CAD	IEEE 802.11a/h WiFi 5 GHz (OFDM, 6 Mbps)	WLAN	8.68	± 9.6 %
10063	CAD	IEEE 802.11a/h WiFi 5 GHz (OFDM, 9 Mbps)	WLAN	8.63	± 9.6 %
10064	CAD	IEEE 802.11a/h WiFi 5 GHz (OFDM, 12 Mbps)	WLAN	9.09	± 9.6 %
10065	CAD	IEEE 802.11a/h WiFi 5 GHz (OFDM, 18 Mbps)	WLAN	9.00	± 9.6 %
10066	CAD	IEEE 802.11a/h WiFi 5 GHz (OFDM, 24 Mbps)	WLAN	9.38	± 9.6 %
10067	CAD	IEEE 802.11a/h WiFi 5 GHz (OFDM, 36 Mbps)	WLAN	10.12	± 9.6 %
10068	CAD	IEEE 802.11a/h WiFi 5 GHz (OFDM, 48 Mbps)	WLAN	10.24	± 9.6 %
10069	CAD	IEEE 802.11a/h WiFi 5 GHz (OFDM, 54 Mbps)	WLAN	10.56	± 9.6 %
10071	CAB	IEEE 802.11g WiFi 2.4 GHz (DSSS/OFDM, 9 Mbps)	WLAN	9.83	± 9.6 %
10072	CAB	IEEE 802.11g WiFi 2.4 GHz (DSSS/OFDM, 12 Mbps)	WLAN	9.62	± 9.6 %
10073	CAB	IEEE 802.11g WiFi 2.4 GHz (DSSS/OFDM, 18 Mbps)	WLAN	9.94	± 9.6 %
10074	CAB	IEEE 802.11g WiFi 2.4 GHz (DSSS/OFDM, 24 Mbps)	WLAN	10.30	± 9.6 %
10075	CAB	IEEE 802.11g WiFi 2.4 GHz (DSSS/OFDM, 36 Mbps)	WLAN	10.77	± 9.6 %
10076	CAB	IEEE 802.11g WiFi 2.4 GHz (DSSS/OFDM, 48 Mbps)	WLAN	10.94	± 9.6 %
10077	CAB	IEEE 802.11g WiFi 2.4 GHz (DSSS/OFDM, 54 Mbps)	WLAN	11.00	± 9.6 %
10081	CAB	CDMA2000 (1xRTT, RC3)	CDMA2000	3.97	± 9.6 %
10082	CAB	IS-54 / IS-136 FDD (TDMA/FDM, PI/4-DQPSK, Fullrate)	AMPS	4.77	± 9.6 %
10090	DAC	GPRS-FDD (TDMA, GMSK, TN 0-4)	GSM	6.56	± 9.6 %
10097	CAC	UMTS-FDD (HSDPA)	WCDMA	3.98	± 9.6 %
10098	DAC	UMTS-FDD (HSUPA, Subtest 2)	WCDMA	3.98	± 9.6 %

10099	CAC	EDGE-FDD (TDMA, 8PSK, TN 0-4)	GSM	9.55	± 9.6 %
10100	CAC	LTE-FDD (SC-FDMA, 100% RB, 20 MHz, QPSK)	LTE-FDD	5.67	± 9.6 %
10101	CAB	LTE-FDD (SC-FDMA, 100% RB, 20 MHz, 16-QAM)	LTE-FDD	6.42	± 9.6 %
10102	CAB	LTE-FDD (SC-FDMA, 100% RB, 20 MHz, 64-QAM)	LTE-FDD	6.60	± 9.6 %
10103	DAC	LTE-TDD (SC-FDMA, 100% RB, 20 MHz, QPSK)	LTE-TDD	9.29	± 9.6 %
10104	CAE	LTE-TDD (SC-FDMA, 100% RB, 20 MHz, 16-QAM)	LTE-TDD	9.97	± 9.6 %
10105	CAE	LTE-TDD (SC-FDMA, 100% RB, 20 MHz, 64-QAM)	LTE-TDD	10.01	± 9.6 %
10108	CAE	LTE-FDD (SC-FDMA, 100% RB, 10 MHz, QPSK)	LTE-FDD	5.80	± 9.6 %
10109	CAG	LTE-FDD (SC-FDMA, 100% RB, 10 MHz, 16-QAM)	LTE-FDD	6.43	± 9.6 %
10110	CAG	LTE-FDD (SC-FDMA, 100% RB, 5 MHz, QPSK)	LTE-FDD	5.75	± 9.6 %
10111	CAG	LTE-FDD (SC-FDMA, 100% RB, 5 MHz, 16-QAM)	LTE-FDD	6.44	± 9.6 %
10112	CAG	LTE-FDD (SC-FDMA, 100% RB, 10 MHz, 64-QAM)	LTE-FDD	6.59	± 9.6 %
10113	CAG	LTE-FDD (SC-FDMA, 100% RB, 5 MHz, 64-QAM)	LTE-FDD	6.62	± 9.6 %
10114	CAG	IEEE 802.11n (HT Greenfield, 13.5 Mbps, BPSK)	WLAN	8.10	± 9.6 %
10115	CAG	IEEE 802.11n (HT Greenfield, 81 Mbps, 16-QAM)	WLAN	8.46	± 9.6 %
10116	CAG	IEEE 802.11n (HT Greenfield, 135 Mbps, 64-QAM)	WLAN	8.15	± 9.6 %
10117	CAG	IEEE 802.11n (HT Mixed, 13.5 Mbps, BPSK)	WLAN	8.07	± 9.6 %
10118	CAD	IEEE 802.11n (HT Mixed, 81 Mbps, 16-QAM)	WLAN	8.59	± 9.6 %
10119	CAD	IEEE 802.11n (HT Mixed, 135 Mbps, 64-QAM)	WLAN	8.13	± 9.6 %
10140	CAD	LTE-FDD (SC-FDMA, 100% RB, 15 MHz, 16-QAM)	LTE-FDD	6.49	± 9.6 %
10141	CAD	LTE-FDD (SC-FDMA, 100% RB, 15 MHz, 64-QAM)	LTE-FDD	6.53	± 9.6 %
10142	CAD	LTE-FDD (SC-FDMA, 100% RB, 3 MHz, QPSK)	LTE-FDD	5.73	± 9.6 %
10143	CAD	LTE-FDD (SC-FDMA, 100% RB, 3 MHz, 16-QAM)	LTE-FDD	6.35	± 9.6 %
10144	CAC	LTE-FDD (SC-FDMA, 100% RB, 3 MHz, 64-QAM)	LTE-FDD	6.65	± 9.6 %
10145	CAC	LTE-FDD (SC-FDMA, 100% RB, 1.4 MHz, QPSK)	LTE-FDD	5.76	± 9.6 %
10146	CAC	LTE-FDD (SC-FDMA, 100% RB, 1.4 MHz, 16-QAM)	LTE-FDD	6.41	± 9.6 %
10147	CAC	LTE-FDD (SC-FDMA, 100% RB, 1.4 MHz, 64-QAM)	LTE-FDD	6.72	± 9.6 %
10149	CAE	LTE-FDD (SC-FDMA, 50% RB, 20 MHz, 16-QAM)	LTE-FDD	6.42	± 9.6 %
10150	CAE	LTE-FDD (SC-FDMA, 50% RB, 20 MHz, 64-QAM)	LTE-FDD	6.60	± 9.6 %
10151	CAE	LTE-TDD (SC-FDMA, 50% RB, 20 MHz, QPSK)	LTE-TDD	9.28	± 9.6 %
10152	CAE	LTE-TDD (SC-FDMA, 50% RB, 20 MHz, 16-QAM)	LTE-TDD	9.92	± 9.6 %
10153	CAE	LTE-TDD (SC-FDMA, 50% RB, 20 MHz, 64-QAM)	LTE-TDD	10.05	± 9.6 %
10154	CAF	LTE-FDD (SC-FDMA, 50% RB, 10 MHz, QPSK)	LTE-FDD	5.75	± 9.6 %
10155	CAF	LTE-FDD (SC-FDMA, 50% RB, 10 MHz, 16-QAM)	LTE-FDD	6.43	± 9.6 %
10156	CAF	LTE-FDD (SC-FDMA, 50% RB, 5 MHz, QPSK)	LTE-FDD	5.79	± 9.6 %
10157	CAE	LTE-FDD (SC-FDMA, 50% RB, 5 MHz, 16-QAM)	LTE-FDD	6.49	± 9.6 %
10158	CAE	LTE-FDD (SC-FDMA, 50% RB, 10 MHz, 64-QAM)	LTE-FDD	6.62	± 9.6 %
10159	CAG	LTE-FDD (SC-FDMA, 50% RB, 5 MHz, 64-QAM)	LTE-FDD	6.56	± 9.6 %
10160	CAG	LTE-FDD (SC-FDMA, 50% RB, 15 MHz, QPSK)	LTE-FDD	5.82	± 9.6 %
10161	CAG	LTE-FDD (SC-FDMA, 50% RB, 15 MHz, 16-QAM)	LTE-FDD	6.43	± 9.6 %
10162	CAG	LTE-FDD (SC-FDMA, 50% RB, 15 MHz, 64-QAM)	LTE-FDD	6.58	± 9.6 %
10166	CAG	LTE-FDD (SC-FDMA, 50% RB, 1.4 MHz, QPSK)	LTE-FDD	5.46	± 9.6 %
10167	CAG	LTE-FDD (SC-FDMA, 50% RB, 1.4 MHz, 16-QAM)	LTE-FDD	6.21	± 9.6 %
10168	CAG	LTE-FDD (SC-FDMA, 50% RB, 1.4 MHz, 64-QAM)	LTE-FDD	6.79	± 9.6 %
10169	CAG	LTE-FDD (SC-FDMA, 1 RB, 20 MHz, QPSK)	LTE-FDD	5.73	± 9.6 %
10170	CAG	LTE-FDD (SC-FDMA, 1 RB, 20 MHz, 16-QAM)	LTE-FDD	6.52	± 9.6 %
10171	CAE	LTE-FDD (SC-FDMA, 1 RB, 20 MHz, 64-QAM)	LTE-FDD	6.49	± 9.6 %
10172	CAE	LTE-TDD (SC-FDMA, 1 RB, 20 MHz, QPSK)	LTE-TDD	9.21	± 9.6 %
10173	CAE	LTE-TDD (SC-FDMA, 1 RB, 20 MHz, 16-QAM)	LTE-TDD	9.48	± 9.6 %
10174	CAF	LTE-TDD (SC-FDMA, 1 RB, 20 MHz, 64-QAM)	LTE-TDD	10.25	± 9.6 %
10175	CAF	LTE-FDD (SC-FDMA, 1 RB, 10 MHz, QPSK)	LTE-FDD	5.72	± 9.6 %
10176	CAF	LTE-FDD (SC-FDMA, 1 RB, 10 MHz, 16-QAM)	LTE-FDD	6.52	± 9.6 %
10177	CAE	LTE-FDD (SC-FDMA, 1 RB, 5 MHz, QPSK)	LTE-FDD	5.73	± 9.6 %
10178	CAE	LTE-FDD (SC-FDMA, 1 RB, 5 MHz, 16-QAM)	LTE-FDD	6.52	± 9.6 %
10179	AAE	LTE-FDD (SC-FDMA, 1 RB, 10 MHz, 64-QAM)	LTE-FDD	6.50	± 9.6 %
10180	CAG	LTE-FDD (SC-FDMA, 1 RB, 5 MHz, 64-QAM)	LTE-FDD	6.50	± 9.6 %

10181	CAG	LTE-FDD (SC-FDMA, 1 RB, 15 MHz, QPSK)	LTE-FDD	5.72	± 9.6 %
10182	CAG	LTE-FDD (SC-FDMA, 1 RB, 15 MHz, 16-QAM)	LTE-FDD	6.52	± 9.6 %
10183	CAG	LTE-FDD (SC-FDMA, 1 RB, 15 MHz, 64-QAM)	LTE-FDD	6.50	± 9.6 %
10184	CAG	LTE-FDD (SC-FDMA, 1 RB, 3 MHz, QPSK)	LTE-FDD	5.73	± 9.6 %
10185	CAI	LTE-FDD (SC-FDMA, 1 RB, 3 MHz, 16-QAM)	LTE-FDD	6.51	± 9.6 %
10186	CAG	LTE-FDD (SC-FDMA, 1 RB, 3 MHz, 64-QAM)	LTE-FDD	6.50	± 9.6 %
10187	CAG	LTE-FDD (SC-FDMA, 1 RB, 1.4 MHz, QPSK)	LTE-FDD	5.73	± 9.6 %
10188	CAG	LTE-FDD (SC-FDMA, 1 RB, 1.4 MHz, 16-QAM)	LTE-FDD	6.52	± 9.6 %
10189	CAE	LTE-FDD (SC-FDMA, 1 RB, 1.4 MHz, 64-QAM)	LTE-FDD	6.50	± 9.6 %
10193	CAE	IEEE 802.11n (HT Greenfield, 6.5 Mbps, BPSK)	WLAN	8.09	± 9.6 %
10194	AAD	IEEE 802.11n (HT Greenfield, 39 Mbps, 16-QAM)	WLAN	8.12	± 9.6 %
10195	CAE	IEEE 802.11n (HT Greenfield, 65 Mbps, 64-QAM)	WLAN	8.21	± 9.6 %
10196	CAE	IEEE 802.11n (HT Mixed, 6.5 Mbps, BPSK)	WLAN	8.10	± 9.6 %
10197	AAE	IEEE 802.11n (HT Mixed, 39 Mbps, 16-QAM)	WLAN	8.13	± 9.6 %
10198	CAF	IEEE 802.11n (HT Mixed, 65 Mbps, 64-QAM)	WLAN	8.27	± 9.6 %
10219	CAF	IEEE 802.11n (HT Mixed, 7.2 Mbps, BPSK)	WLAN	8.03	± 9.6 %
10220	AAF	IEEE 802.11n (HT Mixed, 43.3 Mbps, 16-QAM)	WLAN	8.13	± 9.6 %
10221	CAC	IEEE 802.11n (HT Mixed, 72.2 Mbps, 64-QAM)	WLAN	8.27	± 9.6 %
10222	CAC	IEEE 802.11n (HT Mixed, 15 Mbps, BPSK)	WLAN	8.06	± 9.6 %
10223	CAD	IEEE 802.11n (HT Mixed, 90 Mbps, 16-QAM)	WLAN	8.48	± 9.6 %
10224	CAD	IEEE 802.11n (HT Mixed, 150 Mbps, 64-QAM)	WLAN	8.08	± 9.6 %
10225	CAD	UMTS-FDD (HSPA+)	WCDMA	5.97	± 9.6 %
10226	CAD	LTE-TDD (SC-FDMA, 1 RB, 1.4 MHz, 16-QAM)	LTE-TDD	9.49	± 9.6 %
10227	CAD	LTE-TDD (SC-FDMA, 1 RB, 1.4 MHz, 64-QAM)	LTE-TDD	10.26	± 9.6 %
10228	CAD	LTE-TDD (SC-FDMA, 1 RB, 1.4 MHz, QPSK)	LTE-TDD	9.22	± 9.6 %
10229	DAC	LTE-TDD (SC-FDMA, 1 RB, 3 MHz, 16-QAM)	LTE-TDD	9.48	± 9.6 %
10230	CAC	LTE-TDD (SC-FDMA, 1 RB, 3 MHz, 64-QAM)	LTE-TDD	10.25	± 9.6 %
10231	CAC	LTE-TDD (SC-FDMA, 1 RB, 3 MHz, QPSK)	LTE-TDD	9.19	± 9.6 %
10232	CAD	LTE-TDD (SC-FDMA, 1 RB, 5 MHz, 16-QAM)	LTE-TDD	9.48	± 9.6 %
10233	CAD	LTE-TDD (SC-FDMA, 1 RB, 5 MHz, 64-QAM)	LTE-TDD	10.25	± 9.6 %
10234	CAD	LTE-TDD (SC-FDMA, 1 RB, 5 MHz, QPSK)	LTE-TDD	9.21	± 9.6 %
10235	CAD	LTE-TDD (SC-FDMA, 1 RB, 10 MHz, 16-QAM)	LTE-TDD	9.48	± 9.6 %
10236	CAD	LTE-TDD (SC-FDMA, 1 RB, 10 MHz, 64-QAM)	LTE-TDD	10.25	± 9.6 %
10237	CAD	LTE-TDD (SC-FDMA, 1 RB, 10 MHz, QPSK)	LTE-TDD	9.21	± 9.6 %
10238	CAB	LTE-TDD (SC-FDMA, 1 RB, 15 MHz, 16-QAM)	LTE-TDD	9.48	± 9.6 %
10239	CAB	LTE-TDD (SC-FDMA, 1 RB, 15 MHz, 64-QAM)	LTE-TDD	10.25	± 9.6 %
10240	CAB	LTE-TDD (SC-FDMA, 1 RB, 15 MHz, QPSK)	LTE-TDD	9.21	± 9.6 %
10241	CAB	LTE-TDD (SC-FDMA, 50% RB, 1.4 MHz, 16-QAM)	LTE-TDD	9.82	± 9.6 %
10242	CAD	LTE-TDD (SC-FDMA, 50% RB, 1.4 MHz, 64-QAM)	LTE-TDD	9.86	± 9.6 %
10243	CAD	LTE-TDD (SC-FDMA, 50% RB, 1.4 MHz, QPSK)	LTE-TDD	9.46	± 9.6 %
10244	CAD	LTE-TDD (SC-FDMA, 50% RB, 3 MHz, 16-QAM)	LTE-TDD	10.06	± 9.6 %
10245	CAG	LTE-TDD (SC-FDMA, 50% RB, 3 MHz, 64-QAM)	LTE-TDD	10.06	± 9.6 %
10246	CAG	LTE-TDD (SC-FDMA, 50% RB, 3 MHz, QPSK)	LTE-TDD	9.30	± 9.6 %
10247	CAG	LTE-TDD (SC-FDMA, 50% RB, 5 MHz, 16-QAM)	LTE-TDD	9.91	± 9.6 %
10248	CAG	LTE-TDD (SC-FDMA, 50% RB, 5 MHz, 64-QAM)	LTE-TDD	10.09	± 9.6 %
10249	CAG	LTE-TDD (SC-FDMA, 50% RB, 5 MHz, QPSK)	LTE-TDD	9.29	± 9.6 %
10250	CAG	LTE-TDD (SC-FDMA, 50% RB, 10 MHz, 16-QAM)	LTE-TDD	9.81	± 9.6 %
10251	CAF	LTE-TDD (SC-FDMA, 50% RB, 10 MHz, 64-QAM)	LTE-TDD	10.17	± 9.6 %
10252	CAF	LTE-TDD (SC-FDMA, 50% RB, 10 MHz, QPSK)	LTE-TDD	9.24	± 9.6 %
10253	CAF	LTE-TDD (SC-FDMA, 50% RB, 15 MHz, 16-QAM)	LTE-TDD	9.90	± 9.6 %
10254	CAB	LTE-TDD (SC-FDMA, 50% RB, 15 MHz, 64-QAM)	LTE-TDD	10.14	± 9.6 %
10255	CAB	LTE-TDD (SC-FDMA, 50% RB, 15 MHz, QPSK)	LTE-TDD	9.20	± 9.6 %
10256	CAB	LTE-TDD (SC-FDMA, 100% RB, 1.4 MHz, 16-QAM)	LTE-TDD	9.96	± 9.6 %
10257	CAD	LTE-TDD (SC-FDMA, 100% RB, 1.4 MHz, 64-QAM)	LTE-TDD	10.08	± 9.6 %
10258	CAD	LTE-TDD (SC-FDMA, 100% RB, 1.4 MHz, QPSK)	LTE-TDD	9.34	± 9.6 %
10259	CAD	LTE-TDD (SC-FDMA, 100% RB, 3 MHz, 16-QAM)	LTE-TDD	9.98	± 9.6 %

10260	CAG	LTE-TDD (SC-FDMA, 100% RB, 3 MHz, 64-QAM)	LTE-TDD	9.97	± 9.6 %
10261	CAG	LTE-TDD (SC-FDMA, 100% RB, 3 MHz, QPSK)	LTE-TDD	9.24	± 9.6 %
10262	CAG	LTE-TDD (SC-FDMA, 100% RB, 5 MHz, 16-QAM)	LTE-TDD	9.83	± 9.6 %
10263	CAG	LTE-TDD (SC-FDMA, 100% RB, 5 MHz, 64-QAM)	LTE-TDD	10.16	± 9.6 %
10264	CAG	LTE-TDD (SC-FDMA, 100% RB, 5 MHz, QPSK)	LTE-TDD	9.23	± 9.6 %
10265	CAG	LTE-TDD (SC-FDMA, 100% RB, 10 MHz, 16-QAM)	LTE-TDD	9.92	± 9.6 %
10266	CAF	LTE-TDD (SC-FDMA, 100% RB, 10 MHz, 64-QAM)	LTE-TDD	10.07	± 9.6 %
10267	CAF	LTE-TDD (SC-FDMA, 100% RB, 10 MHz, QPSK)	LTE-TDD	9.30	± 9.6 %
10268	CAF	LTE-TDD (SC-FDMA, 100% RB, 15 MHz, 16-QAM)	LTE-TDD	10.06	± 9.6 %
10269	CAB	LTE-TDD (SC-FDMA, 100% RB, 15 MHz, 64-QAM)	LTE-TDD	10.13	± 9.6 %
10270	CAB	LTE-TDD (SC-FDMA, 100% RB, 15 MHz, QPSK)	LTE-TDD	9.58	± 9.6 %
10274	CAB	UMTS-FDD (HSUPA, Subtest 5, 3GPP Rel8.10)	WCDMA	4.87	± 9.6 %
10275	CAD	UMTS-FDD (HSUPA, Subtest 5, 3GPP Rel8.4)	WCDMA	3.96	± 9.6 %
10277	CAD	PHS (QPSK)	PHS	11.81	± 9.6 %
10278	CAD	PHS (QPSK, BW 884MHz, Rolloff 0.5)	PHS	11.81	± 9.6 %
10279	CAG	PHS (QPSK, BW 884MHz, Rolloff 0.38)	PHS	12.18	± 9.6 %
10290	CAG	CDMA2000, RC1, SO55, Full Rate	CDMA2000	3.91	± 9.6 %
10291	CAG	CDMA2000, RC3, SO55, Full Rate	CDMA2000	3.46	± 9.6 %
10292	CAG	CDMA2000, RC3, SO32, Full Rate	CDMA2000	3.39	± 9.6 %
10293	CAG	CDMA2000, RC3, SO3, Full Rate	CDMA2000	3.50	± 9.6 %
10295	CAG	CDMA2000, RC1, SO3, 1/8th Rate 25 fr.	CDMA2000	12.49	± 9.6 %
10297	CAF	LTE-FDD (SC-FDMA, 50% RB, 20 MHz, QPSK)	LTE-FDD	5.81	± 9.6 %
10298	CAF	LTE-FDD (SC-FDMA, 50% RB, 3 MHz, QPSK)	LTE-FDD	5.72	± 9.6 %
10299	CAF	LTE-FDD (SC-FDMA, 50% RB, 3 MHz, 16-QAM)	LTE-FDD	6.39	± 9.6 %
10300	CAC	LTE-FDD (SC-FDMA, 50% RB, 3 MHz, 64-QAM)	LTE-FDD	6.60	± 9.6 %
10301	CAC	IEEE 802.16e WiMAX (29:18, 5ms, 10MHz, QPSK, PUSC)	WiMAX	12.03	± 9.6 %
10302	CAB	IEEE 802.16e WiMAX (29:18, 5ms, 10MHz, QPSK, PUSC, 3CTRL)	WiMAX	12.57	± 9.6 %
10303	CAB	IEEE 802.16e WiMAX (31:15, 5ms, 10MHz, 64QAM, PUSC)	WiMAX	12.52	± 9.6 %
10304	CAA	IEEE 802.16e WiMAX (29:18, 5ms, 10MHz, 64QAM, PUSC)	WiMAX	11.86	± 9.6 %
10305	CAA	IEEE 802.16e WiMAX (31:15, 10ms, 10MHz, 64QAM, PUSC)	WiMAX	15.24	± 9.6 %
10306	CAA	IEEE 802.16e WiMAX (29:18, 10ms, 10MHz, 64QAM, PUSC)	WiMAX	14.67	± 9.6 %
10307	AAB	IEEE 802.16e WiMAX (29:18, 10ms, 10MHz, QPSK, PUSC)	WiMAX	14.49	± 9.6 %
10308	AAB	IEEE 802.16e WiMAX (29:18, 10ms, 10MHz, 16QAM, PUSC)	WiMAX	14.46	± 9.6 %
10309	AAB	IEEE 802.16e WiMAX (29:18, 10ms, 10MHz, 16QAM, AMC 2x3)	WiMAX	14.58	± 9.6 %
10310	AAB	IEEE 802.16e WiMAX (29:18, 10ms, 10MHz, QPSK, AMC 2x3)	WiMAX	14.57	± 9.6 %
10311	AAB	LTE-FDD (SC-FDMA, 100% RB, 15 MHz, QPSK)	LTE-FDD	6.06	± 9.6 %
10313	AAD	iDEN 1:3	iDEN	10.51	± 9.6 %
10314	AAD	iDEN 1:6	iDEN	13.48	± 9.6 %
10315	AAD	IEEE 802.11b WiFi 2.4 GHz (DSSS, 1 Mbps, 96pc dc)	WLAN	1.71	± 9.6 %
10316	AAD	IEEE 802.11g WiFi 2.4 GHz (ERP-OFDM, 6 Mbps, 96pc dc)	WLAN	8.36	± 9.6 %
10317	AAA	IEEE 802.11a WiFi 5 GHz (OFDM, 6 Mbps, 96pc dc)	WLAN	8.36	± 9.6 %
10352	AAA	Pulse Waveform (200Hz, 10%)	Generic	10.00	± 9.6 %
10353	AAA	Pulse Waveform (200Hz, 20%)	Generic	6.99	± 9.6 %
10354	AAA	Pulse Waveform (200Hz, 40%)	Generic	3.98	± 9.6 %
10355	AAA	Pulse Waveform (200Hz, 60%)	Generic	2.22	± 9.6 %
10356	AAA	Pulse Waveform (200Hz, 80%)	Generic	0.97	± 9.6 %
10387	AAA	QPSK Waveform, 1 MHz	Generic	5.10	± 9.6 %
10388	AAA	QPSK Waveform, 10 MHz	Generic	5.22	± 9.6 %
10396	AAA	64-QAM Waveform, 100 kHz	Generic	6.27	± 9.6 %
10399	AAA	64-QAM Waveform, 40 MHz	Generic	6.27	± 9.6 %
10400	AAD	IEEE 802.11ac WiFi (20MHz, 64-QAM, 99pc dc)	WLAN	8.37	± 9.6 %
10401	AAA	IEEE 802.11ac WiFi (40MHz, 64-QAM, 99pc dc)	WLAN	8.60	± 9.6 %
10402	AAA	IEEE 802.11ac WiFi (80MHz, 64-QAM, 99pc dc)	WLAN	8.53	± 9.6 %
10403	AAB	CDMA2000 (1xEV-DO, Rev. 0)	CDMA2000	3.76	± 9.6 %
10404	AAB	CDMA2000 (1xEV-DO, Rev. A)	CDMA2000	3.77	± 9.6 %
10406	AAD	CDMA2000, RC3, SO32, SCH0, Full Rate	CDMA2000	5.22	± 9.6 %

10410	AAA	LTE-TDD (SC-FDMA, 1 RB, 10 MHz, QPSK, UL Sub=2,3,4,7,8,9)	LTE-TDD	7.82	± 9.6 %
10414	AAA	WLAN CCDF, 64-QAM, 40MHz	Generic	8.54	± 9.6 %
10415	AAA	IEEE 802.11b WiFi 2.4 GHz (DSSS, 1 Mbps, 99pc dc)	WLAN	1.54	± 9.6 %
10416	AAA	IEEE 802.11g WiFi 2.4 GHz (ERP-OFDM, 6 Mbps, 99pc dc)	WLAN	8.23	± 9.6 %
10417	AAA	IEEE 802.11a/h WiFi 5 GHz (OFDM, 6 Mbps, 99pc dc)	WLAN	8.23	± 9.6 %
10418	AAA	IEEE 802.11g WiFi 2.4 GHz (DSSS-OFDM, 6 Mbps, 99pc, Long)	WLAN	8.14	± 9.6 %
10419	AAA	IEEE 802.11g WiFi 2.4 GHz (DSSS-OFDM, 6 Mbps, 99pc, Short)	WLAN	8.19	± 9.6 %
10422	AAA	IEEE 802.11n (HT Greenfield, 7.2 Mbps, BPSK)	WLAN	8.32	± 9.6 %
10423	AAA	IEEE 802.11n (HT Greenfield, 43.3 Mbps, 16-QAM)	WLAN	8.47	± 9.6 %
10424	AAE	IEEE 802.11n (HT Greenfield, 72.2 Mbps, 64-QAM)	WLAN	8.40	± 9.6 %
10425	AAE	IEEE 802.11n (HT Greenfield, 15 Mbps, BPSK)	WLAN	8.41	± 9.6 %
10426	AAE	IEEE 802.11n (HT Greenfield, 90 Mbps, 16-QAM)	WLAN	8.45	± 9.6 %
10427	AAB	IEEE 802.11n (HT Greenfield, 150 Mbps, 64-QAM)	WLAN	8.41	± 9.6 %
10430	AAB	LTE-FDD (OFDMA, 5 MHz, E-TM 3.1)	LTE-FDD	8.28	± 9.6 %
10431	AAC	LTE-FDD (OFDMA, 10 MHz, E-TM 3.1)	LTE-FDD	8.38	± 9.6 %
10432	AAB	LTE-FDD (OFDMA, 15 MHz, E-TM 3.1)	LTE-FDD	8.34	± 9.6 %
10433	AAC	LTE-FDD (OFDMA, 20 MHz, E-TM 3.1)	LTE-FDD	8.34	± 9.6 %
10434	AAG	W-CDMA (BS Test Model 1, 64 DPCH)	WCDMA	8.60	± 9.6 %
10435	AAA	LTE-TDD (SC-FDMA, 1 RB, 20 MHz, QPSK, UL Sub)	LTE-TDD	7.82	± 9.6 %
10447	AAA	LTE-FDD (OFDMA, 5 MHz, E-TM 3.1, Clipping 44%)	LTE-FDD	7.56	± 9.6 %
10448	AAA	LTE-FDD (OFDMA, 10 MHz, E-TM 3.1, Clipping 44%)	LTE-FDD	7.53	± 9.6 %
10449	AAC	LTE-FDD (OFDMA, 15 MHz, E-TM 3.1, Clipping 44%)	LTE-FDD	7.51	± 9.6 %
10450	AAA	LTE-FDD (OFDMA, 20 MHz, E-TM 3.1, Clipping 44%)	LTE-FDD	7.48	± 9.6 %
10451	AAA	W-CDMA (BS Test Model 1, 64 DPCH, Clipping 44%)	WCDMA	7.59	± 9.6 %
10453	AAC	Validation (Square, 10ms, 1ms)	Test	10.00	± 9.6 %
10456	AAC	IEEE 802.11ac WiFi (160MHz, 64-QAM, 99pc dc)	WLAN	8.63	± 9.6 %
10457	AAC	UMTS-FDD (DC-HSDPA)	WCDMA	6.62	± 9.6 %
10458	AAC	CDMA2000 (1xEV-DO, Rev. B, 2 carriers)	CDMA2000	6.55	± 9.6 %
10459	AAC	CDMA2000 (1xEV-DO, Rev. B, 3 carriers)	CDMA2000	8.25	± 9.6 %
10460	AAC	UMTS-FDD (WCDMA, AMR)	WCDMA	2.39	± 9.6 %
10461	AAC	LTE-TDD (SC-FDMA, 1 RB, 1.4 MHz, QPSK, UL Sub)	LTE-TDD	7.82	± 9.6 %
10462	AAC	LTE-TDD (SC-FDMA, 1 RB, 1.4 MHz, 16-QAM, UL Sub)	LTE-TDD	8.30	± 9.6 %
10463	AAD	LTE-TDD (SC-FDMA, 1 RB, 1.4 MHz, 64-QAM, UL Sub)	LTE-TDD	8.56	± 9.6 %
10464	AAD	LTE-TDD (SC-FDMA, 1 RB, 3 MHz, QPSK, UL Sub)	LTE-TDD	7.82	± 9.6 %
10465	AAC	LTE-TDD (SC-FDMA, 1 RB, 3 MHz, 16-QAM, UL Sub)	LTE-TDD	8.32	± 9.6 %
10466	AAC	LTE-TDD (SC-FDMA, 1 RB, 3 MHz, 64-QAM, UL Sub)	LTE-TDD	8.57	± 9.6 %
10467	AAA	LTE-TDD (SC-FDMA, 1 RB, 5 MHz, QPSK, UL Sub)	LTE-TDD	7.82	± 9.6 %
10468	AAF	LTE-TDD (SC-FDMA, 1 RB, 5 MHz, 16-QAM, UL Sub)	LTE-TDD	8.32	± 9.6 %
10469	AAD	LTE-TDD (SC-FDMA, 1 RB, 5 MHz, 64-QAM, UL Sub)	LTE-TDD	8.56	± 9.6 %
10470	AAD	LTE-TDD (SC-FDMA, 1 RB, 10 MHz, QPSK, UL Sub)	LTE-TDD	7.82	± 9.6 %
10471	AAC	LTE-TDD (SC-FDMA, 1 RB, 10 MHz, 16-QAM, UL Sub)	LTE-TDD	8.32	± 9.6 %
10472	AAC	LTE-TDD (SC-FDMA, 1 RB, 10 MHz, 64-QAM, UL Sub)	LTE-TDD	8.57	± 9.6 %
10473	AAA	LTE-TDD (SC-FDMA, 1 RB, 15 MHz, QPSK, UL Sub)	LTE-TDD	7.82	± 9.6 %
10474	AAC	LTE-TDD (SC-FDMA, 1 RB, 15 MHz, 16-QAM, UL Sub)	LTE-TDD	8.32	± 9.6 %
10475	AAD	LTE-TDD (SC-FDMA, 1 RB, 15 MHz, 64-QAM, UL Sub)	LTE-TDD	8.57	± 9.6 %
10477	AAC	LTE-TDD (SC-FDMA, 1 RB, 20 MHz, 16-QAM, UL Sub)	LTE-TDD	8.32	± 9.6 %
10478	AAC	LTE-TDD (SC-FDMA, 1 RB, 20 MHz, 64-QAM, UL Sub)	LTE-TDD	8.57	± 9.6 %
10479	AAC	LTE-TDD (SC-FDMA, 50% RB, 1.4 MHz, QPSK, UL Sub)	LTE-TDD	7.74	± 9.6 %
10480	AAA	LTE-TDD (SC-FDMA, 50% RB, 1.4 MHz, 16-QAM, UL Sub)	LTE-TDD	8.18	± 9.6 %
10481	AAA	LTE-TDD (SC-FDMA, 50% RB, 1.4 MHz, 64-QAM, UL Sub)	LTE-TDD	8.45	± 9.6 %
10482	AAA	LTE-TDD (SC-FDMA, 50% RB, 3 MHz, QPSK, UL Sub)	LTE-TDD	7.71	± 9.6 %
10483	AAA	LTE-TDD (SC-FDMA, 50% RB, 3 MHz, 16-QAM, Sub)	LTE-TDD	8.39	± 9.6 %
10484	AAB	LTE-TDD (SC-FDMA, 50% RB, 3 MHz, 64-QAM, UL Sub)	LTE-TDD	8.47	± 9.6 %
10485	AAB	LTE-TDD (SC-FDMA, 50% RB, 5 MHz, QPSK, UL Sub)	LTE-TDD	7.59	± 9.6 %
10486	AAB	LTE-TDD (SC-FDMA, 50% RB, 5 MHz, 16-QAM, UL Sub)	LTE-TDD	8.38	± 9.6 %
10487	AAC	LTE-TDD (SC-FDMA, 50% RB, 5 MHz, 64-QAM, UL Sub)	LTE-TDD	8.60	± 9.6 %

10488	AAC	LTE-TDD (SC-FDMA, 50% RB, 10 MHz, QPSK, UL Sub)	LTE-TDD	7.70	± 9.6 %
10489	AAC	LTE-TDD (SC-FDMA, 50% RB, 10 MHz, 16-QAM, UL Sub)	LTE-TDD	8.31	± 9.6 %
10490	AAF	LTE-TDD (SC-FDMA, 50% RB, 10 MHz, 64-QAM, UL Sub)	LTE-TDD	8.54	± 9.6 %
10491	AAF	LTE-TDD (SC-FDMA, 50% RB, 15 MHz, QPSK, UL Sub)	LTE-TDD	7.74	± 9.6 %
10492	AAF	LTE-TDD (SC-FDMA, 50% RB, 15 MHz, 16-QAM, UL Sub)	LTE-TDD	8.41	± 9.6 %
10493	AAF	LTE-TDD (SC-FDMA, 50% RB, 15 MHz, 64-QAM, UL Sub)	LTE-TDD	8.55	± 9.6 %
10494	AAF	LTE-TDD (SC-FDMA, 50% RB, 20 MHz, QPSK, UL Sub)	LTE-TDD	7.74	± 9.6 %
10495	AAF	LTE-TDD (SC-FDMA, 50% RB, 20 MHz, 16-QAM, UL Sub)	LTE-TDD	8.37	± 9.6 %
10496	AAE	LTE-TDD (SC-FDMA, 50% RB, 20 MHz, 64-QAM, UL Sub)	LTE-TDD	8.54	± 9.6 %
10497	AAE	LTE-TDD (SC-FDMA, 100% RB, 1.4 MHz, QPSK, UL Sub)	LTE-TDD	7.67	± 9.6 %
10498	AAE	LTE-TDD (SC-FDMA, 100% RB, 1.4 MHz, 16-QAM, UL Sub)	LTE-TDD	8.40	± 9.6 %
10499	AAC	LTE-TDD (SC-FDMA, 100% RB, 1.4 MHz, 64-QAM, UL Sub)	LTE-TDD	8.68	± 9.6 %
10500	AAF	LTE-TDD (SC-FDMA, 100% RB, 3 MHz, QPSK, UL Sub)	LTE-TDD	7.67	± 9.6 %
10501	AAF	LTE-TDD (SC-FDMA, 100% RB, 3 MHz, 16-QAM, UL Sub)	LTE-TDD	8.44	± 9.6 %
10502	AAB	LTE-TDD (SC-FDMA, 100% RB, 3 MHz, 64-QAM, UL Sub)	LTE-TDD	8.52	± 9.6 %
10503	AAB	LTE-TDD (SC-FDMA, 100% RB, 5 MHz, QPSK, UL Sub)	LTE-TDD	7.72	± 9.6 %
10504	AAB	LTE-TDD (SC-FDMA, 100% RB, 5 MHz, 16-QAM, UL Sub)	LTE-TDD	8.31	± 9.6 %
10505	AAC	LTE-TDD (SC-FDMA, 100% RB, 5 MHz, 64-QAM, UL Sub)	LTE-TDD	8.54	± 9.6 %
10506	AAC	LTE-TDD (SC-FDMA, 100% RB, 10 MHz, QPSK, UL Sub)	LTE-TDD	7.74	± 9.6 %
10507	AAC	LTE-TDD (SC-FDMA, 100% RB, 10 MHz, 16-QAM, UL Sub)	LTE-TDD	8.36	± 9.6 %
10508	AAF	LTE-TDD (SC-FDMA, 100% RB, 10 MHz, 64-QAM, UL Sub)	LTE-TDD	8.55	± 9.6 %
10509	AAF	LTE-TDD (SC-FDMA, 100% RB, 15 MHz, QPSK, UL Sub)	LTE-TDD	7.99	± 9.6 %
10510	AAF	LTE-TDD (SC-FDMA, 100% RB, 15 MHz, 16-QAM, UL Sub)	LTE-TDD	8.49	± 9.6 %
10511	AAF	LTE-TDD (SC-FDMA, 100% RB, 15 MHz, 64-QAM, UL Sub)	LTE-TDD	8.51	± 9.6 %
10512	AAF	LTE-TDD (SC-FDMA, 100% RB, 20 MHz, QPSK, UL Sub)	LTE-TDD	7.74	± 9.6 %
10513	AAF	LTE-TDD (SC-FDMA, 100% RB, 20 MHz, 16-QAM, UL Sub)	LTE-TDD	8.42	± 9.6 %
10514	AAE	LTE-TDD (SC-FDMA, 100% RB, 20 MHz, 64-QAM, UL Sub)	LTE-TDD	8.45	± 9.6 %
10515	AAE	IEEE 802.11b WiFi 2.4 GHz (DSSS, 2 Mbps, 99pc dc)	WLAN	1.58	± 9.6 %
10516	AAE	IEEE 802.11b WiFi 2.4 GHz (DSSS, 5.5 Mbps, 99pc dc)	WLAN	1.57	± 9.6 %
10517	AAF	IEEE 802.11b WiFi 2.4 GHz (DSSS, 11 Mbps, 99pc dc)	WLAN	1.58	± 9.6 %
10518	AAF	IEEE 802.11a/h WiFi 5 GHz (OFDM, 9 Mbps, 99pc dc)	WLAN	8.23	± 9.6 %
10519	AAF	IEEE 802.11a/h WiFi 5 GHz (OFDM, 12 Mbps, 99pc dc)	WLAN	8.39	± 9.6 %
10520	AAB	IEEE 802.11a/h WiFi 5 GHz (OFDM, 18 Mbps, 99pc dc)	WLAN	8.12	± 9.6 %
10521	AAB	IEEE 802.11a/h WiFi 5 GHz (OFDM, 24 Mbps, 99pc dc)	WLAN	7.97	± 9.6 %
10522	AAB	IEEE 802.11a/h WiFi 5 GHz (OFDM, 36 Mbps, 99pc dc)	WLAN	8.45	± 9.6 %
10523	AAC	IEEE 802.11a/h WiFi 5 GHz (OFDM, 48 Mbps, 99pc dc)	WLAN	8.08	± 9.6 %
10524	AAC	IEEE 802.11a/h WiFi 5 GHz (OFDM, 54 Mbps, 99pc dc)	WLAN	8.27	± 9.6 %
10525	AAC	IEEE 802.11ac WiFi (20MHz, MCS0, 99pc dc)	WLAN	8.36	± 9.6 %
10526	AAF	IEEE 802.11ac WiFi (20MHz, MCS1, 99pc dc)	WLAN	8.42	± 9.6 %
10527	AAF	IEEE 802.11ac WiFi (20MHz, MCS2, 99pc dc)	WLAN	8.21	± 9.6 %
10528	AAF	IEEE 802.11ac WiFi (20MHz, MCS3, 99pc dc)	WLAN	8.36	± 9.6 %
10529	AAF	IEEE 802.11ac WiFi (20MHz, MCS4, 99pc dc)	WLAN	8.36	± 9.6 %
10531	AAF	IEEE 802.11ac WiFi (20MHz, MCS6, 99pc dc)	WLAN	8.43	± 9.6 %
10532	AAF	IEEE 802.11ac WiFi (20MHz, MCS7, 99pc dc)	WLAN	8.29	± 9.6 %
10533	AAE	IEEE 802.11ac WiFi (20MHz, MCS8, 99pc dc)	WLAN	8.38	± 9.6 %
10534	AAE	IEEE 802.11ac WiFi (40MHz, MCS0, 99pc dc)	WLAN	8.45	± 9.6 %
10535	AAE	IEEE 802.11ac WiFi (40MHz, MCS1, 99pc dc)	WLAN	8.45	± 9.6 %
10536	AAF	IEEE 802.11ac WiFi (40MHz, MCS2, 99pc dc)	WLAN	8.32	± 9.6 %
10537	AAF	IEEE 802.11ac WiFi (40MHz, MCS3, 99pc dc)	WLAN	8.44	± 9.6 %
10538	AAF	IEEE 802.11ac WiFi (40MHz, MCS4, 99pc dc)	WLAN	8.54	± 9.6 %
10540	AAA	IEEE 802.11ac WiFi (40MHz, MCS6, 99pc dc)	WLAN	8.39	± 9.6 %
10541	AAA	IEEE 802.11ac WiFi (40MHz, MCS7, 99pc dc)	WLAN	8.46	± 9.6 %
10542	AAA	IEEE 802.11ac WiFi (40MHz, MCS8, 99pc dc)	WLAN	8.65	± 9.6 %
10543	AAC	IEEE 802.11ac WiFi (40MHz, MCS9, 99pc dc)	WLAN	8.65	± 9.6 %
10544	AAC	IEEE 802.11ac WiFi (80MHz, MCS0, 99pc dc)	WLAN	8.47	± 9.6 %
10545	AAC	IEEE 802.11ac WiFi (80MHz, MCS1, 99pc dc)	WLAN	8.55	± 9.6 %

10546	AAC	IEEE 802.11ac WiFi (80MHz, MCS2, 99pc dc)	WLAN	8.35	± 9.6 %
10547	AAC	IEEE 802.11ac WiFi (80MHz, MCS3, 99pc dc)	WLAN	8.49	± 9.6 %
10548	AAC	IEEE 802.11ac WiFi (80MHz, MCS4, 99pc dc)	WLAN	8.37	± 9.6 %
10550	AAC	IEEE 802.11ac WiFi (80MHz, MCS6, 99pc dc)	WLAN	8.38	± 9.6 %
10551	AAC	IEEE 802.11ac WiFi (80MHz, MCS7, 99pc dc)	WLAN	8.50	± 9.6 %
10552	AAC	IEEE 802.11ac WiFi (80MHz, MCS8, 99pc dc)	WLAN	8.42	± 9.6 %
10553	AAC	IEEE 802.11ac WiFi (80MHz, MCS9, 99pc dc)	WLAN	8.45	± 9.6 %
10554	AAC	IEEE 802.11ac WiFi (160MHz, MCS0, 99pc dc)	WLAN	8.48	± 9.6 %
10555	AAC	IEEE 802.11ac WiFi (160MHz, MCS1, 99pc dc)	WLAN	8.47	± 9.6 %
10556	AAC	IEEE 802.11ac WiFi (160MHz, MCS2, 99pc dc)	WLAN	8.50	± 9.6 %
10557	AAC	IEEE 802.11ac WiFi (160MHz, MCS3, 99pc dc)	WLAN	8.52	± 9.6 %
10558	AAC	IEEE 802.11ac WiFi (160MHz, MCS4, 99pc dc)	WLAN	8.61	± 9.6 %
10560	AAC	IEEE 802.11ac WiFi (160MHz, MCS6, 99pc dc)	WLAN	8.73	± 9.6 %
10561	AAC	IEEE 802.11ac WiFi (160MHz, MCS7, 99pc dc)	WLAN	8.58	± 9.6 %
10562	AAC	IEEE 802.11ac WiFi (160MHz, MCS8, 99pc dc)	WLAN	8.69	± 9.6 %
10563	AAC	IEEE 802.11ac WiFi (160MHz, MCS9, 99pc dc)	WLAN	8.77	± 9.6 %
10564	AAC	IEEE 802.11g WiFi 2.4 GHz (DSSS-OFDM, 9 Mbps, 99pc dc)	WLAN	8.25	± 9.6 %
10565	AAC	IEEE 802.11g WiFi 2.4 GHz (DSSS-OFDM, 12 Mbps, 99pc dc)	WLAN	8.45	± 9.6 %
10566	AAC	IEEE 802.11g WiFi 2.4 GHz (DSSS-OFDM, 18 Mbps, 99pc dc)	WLAN	8.13	± 9.6 %
10567	AAC	IEEE 802.11g WiFi 2.4 GHz (DSSS-OFDM, 24 Mbps, 99pc dc)	WLAN	8.00	± 9.6 %
10568	AAC	IEEE 802.11g WiFi 2.4 GHz (DSSS-OFDM, 36 Mbps, 99pc dc)	WLAN	8.37	± 9.6 %
10569	AAC	IEEE 802.11g WiFi 2.4 GHz (DSSS-OFDM, 48 Mbps, 99pc dc)	WLAN	8.10	± 9.6 %
10570	AAC	IEEE 802.11g WiFi 2.4 GHz (DSSS-OFDM, 54 Mbps, 99pc dc)	WLAN	8.30	± 9.6 %
10571	AAC	IEEE 802.11b WiFi 2.4 GHz (DSSS, 1 Mbps, 90pc dc)	WLAN	1.99	± 9.6 %
10572	AAC	IEEE 802.11b WiFi 2.4 GHz (DSSS, 2 Mbps, 90pc dc)	WLAN	1.99	± 9.6 %
10573	AAC	IEEE 802.11b WiFi 2.4 GHz (DSSS, 5.5 Mbps, 90pc dc)	WLAN	1.98	± 9.6 %
10574	AAC	IEEE 802.11b WiFi 2.4 GHz (DSSS, 11 Mbps, 90pc dc)	WLAN	1.98	± 9.6 %
10575	AAC	IEEE 802.11g WiFi 2.4 GHz (DSSS-OFDM, 6 Mbps, 90pc dc)	WLAN	8.59	± 9.6 %
10576	AAC	IEEE 802.11g WiFi 2.4 GHz (DSSS-OFDM, 9 Mbps, 90pc dc)	WLAN	8.60	± 9.6 %
10577	AAC	IEEE 802.11g WiFi 2.4 GHz (DSSS-OFDM, 12 Mbps, 90pc dc)	WLAN	8.70	± 9.6 %
10578	AAD	IEEE 802.11g WiFi 2.4 GHz (DSSS-OFDM, 18 Mbps, 90pc dc)	WLAN	8.49	± 9.6 %
10579	AAD	IEEE 802.11g WiFi 2.4 GHz (DSSS-OFDM, 24 Mbps, 90pc dc)	WLAN	8.36	± 9.6 %
10580	AAD	IEEE 802.11g WiFi 2.4 GHz (DSSS-OFDM, 36 Mbps, 90pc dc)	WLAN	8.76	± 9.6 %
10581	AAD	IEEE 802.11g WiFi 2.4 GHz (DSSS-OFDM, 48 Mbps, 90pc dc)	WLAN	8.35	± 9.6 %
10582	AAD	IEEE 802.11g WiFi 2.4 GHz (DSSS-OFDM, 54 Mbps, 90pc dc)	WLAN	8.67	± 9.6 %
10583	AAD	IEEE 802.11a/h WiFi 5 GHz (OFDM, 6 Mbps, 90pc dc)	WLAN	8.59	± 9.6 %
10584	AAD	IEEE 802.11a/h WiFi 5 GHz (OFDM, 9 Mbps, 90pc dc)	WLAN	8.60	± 9.6 %
10585	AAD	IEEE 802.11a/h WiFi 5 GHz (OFDM, 12 Mbps, 90pc dc)	WLAN	8.70	± 9.6 %
10586	AAD	IEEE 802.11a/h WiFi 5 GHz (OFDM, 18 Mbps, 90pc dc)	WLAN	8.49	± 9.6 %
10587	AAA	IEEE 802.11a/h WiFi 5 GHz (OFDM, 24 Mbps, 90pc dc)	WLAN	8.36	± 9.6 %
10588	AAA	IEEE 802.11a/h WiFi 5 GHz (OFDM, 36 Mbps, 90pc dc)	WLAN	8.76	± 9.6 %
10589	AAA	IEEE 802.11a/h WiFi 5 GHz (OFDM, 48 Mbps, 90pc dc)	WLAN	8.35	± 9.6 %
10590	AAA	IEEE 802.11a/h WiFi 5 GHz (OFDM, 54 Mbps, 90pc dc)	WLAN	8.67	± 9.6 %
10591	AAA	IEEE 802.11n (HT Mixed, 20MHz, MCS0, 90pc dc)	WLAN	8.63	± 9.6 %
10592	AAA	IEEE 802.11n (HT Mixed, 20MHz, MCS1, 90pc dc)	WLAN	8.79	± 9.6 %
10593	AAA	IEEE 802.11n (HT Mixed, 20MHz, MCS2, 90pc dc)	WLAN	8.64	± 9.6 %
10594	AAA	IEEE 802.11n (HT Mixed, 20MHz, MCS3, 90pc dc)	WLAN	8.74	± 9.6 %
10595	AAA	IEEE 802.11n (HT Mixed, 20MHz, MCS4, 90pc dc)	WLAN	8.74	± 9.6 %
10596	AAA	IEEE 802.11n (HT Mixed, 20MHz, MCS5, 90pc dc)	WLAN	8.71	± 9.6 %
10597	AAA	IEEE 802.11n (HT Mixed, 20MHz, MCS6, 90pc dc)	WLAN	8.72	± 9.6 %
10598	AAA	IEEE 802.11n (HT Mixed, 20MHz, MCS7, 90pc dc)	WLAN	8.50	± 9.6 %
10599	AAA	IEEE 802.11n (HT Mixed, 40MHz, MCS0, 90pc dc)	WLAN	8.79	± 9.6 %
10600	AAA	IEEE 802.11n (HT Mixed, 40MHz, MCS1, 90pc dc)	WLAN	8.88	± 9.6 %
10601	AAA	IEEE 802.11n (HT Mixed, 40MHz, MCS2, 90pc dc)	WLAN	8.82	± 9.6 %
10602	AAA	IEEE 802.11n (HT Mixed, 40MHz, MCS3, 90pc dc)	WLAN	8.94	± 9.6 %
10603	AAA	IEEE 802.11n (HT Mixed, 40MHz, MCS4, 90pc dc)	WLAN	9.03	± 9.6 %

10604	AAA	IEEE 802.11n (HT Mixed, 40MHz, MCS5, 90pc dc)	WLAN	8.76	± 9.6 %
10605	AAA	IEEE 802.11n (HT Mixed, 40MHz, MCS6, 90pc dc)	WLAN	8.97	± 9.6 %
10606	AAC	IEEE 802.11n (HT Mixed, 40MHz, MCS7, 90pc dc)	WLAN	8.82	± 9.6 %
10607	AAC	IEEE 802.11ac WiFi (20MHz, MCS0, 90pc dc)	WLAN	8.64	± 9.6 %
10608	AAC	IEEE 802.11ac WiFi (20MHz, MCS1, 90pc dc)	WLAN	8.77	± 9.6 %
10609	AAC	IEEE 802.11ac WiFi (20MHz, MCS2, 90pc dc)	WLAN	8.57	± 9.6 %
10610	AAC	IEEE 802.11ac WiFi (20MHz, MCS3, 90pc dc)	WLAN	8.78	± 9.6 %
10611	AAC	IEEE 802.11ac WiFi (20MHz, MCS4, 90pc dc)	WLAN	8.70	± 9.6 %
10612	AAC	IEEE 802.11ac WiFi (20MHz, MCS5, 90pc dc)	WLAN	8.77	± 9.6 %
10613	AAC	IEEE 802.11ac WiFi (20MHz, MCS6, 90pc dc)	WLAN	8.94	± 9.6 %
10614	AAC	IEEE 802.11ac WiFi (20MHz, MCS7, 90pc dc)	WLAN	8.59	± 9.6 %
10615	AAC	IEEE 802.11ac WiFi (20MHz, MCS8, 90pc dc)	WLAN	8.82	± 9.6 %
10616	AAC	IEEE 802.11ac WiFi (40MHz, MCS0, 90pc dc)	WLAN	8.82	± 9.6 %
10617	AAC	IEEE 802.11ac WiFi (40MHz, MCS1, 90pc dc)	WLAN	8.81	± 9.6 %
10618	AAC	IEEE 802.11ac WiFi (40MHz, MCS2, 90pc dc)	WLAN	8.58	± 9.6 %
10619	AAC	IEEE 802.11ac WiFi (40MHz, MCS3, 90pc dc)	WLAN	8.86	± 9.6 %
10620	AAC	IEEE 802.11ac WiFi (40MHz, MCS4, 90pc dc)	WLAN	8.87	± 9.6 %
10621	AAC	IEEE 802.11ac WiFi (40MHz, MCS5, 90pc dc)	WLAN	8.77	± 9.6 %
10622	AAC	IEEE 802.11ac WiFi (40MHz, MCS6, 90pc dc)	WLAN	8.68	± 9.6 %
10623	AAC	IEEE 802.11ac WiFi (40MHz, MCS7, 90pc dc)	WLAN	8.82	± 9.6 %
10624	AAC	IEEE 802.11ac WiFi (40MHz, MCS8, 90pc dc)	WLAN	8.96	± 9.6 %
10625	AAC	IEEE 802.11ac WiFi (40MHz, MCS9, 90pc dc)	WLAN	8.96	± 9.6 %
10626	AAC	IEEE 802.11ac WiFi (80MHz, MCS0, 90pc dc)	WLAN	8.83	± 9.6 %
10627	AAC	IEEE 802.11ac WiFi (80MHz, MCS1, 90pc dc)	WLAN	8.88	± 9.6 %
10628	AAC	IEEE 802.11ac WiFi (80MHz, MCS2, 90pc dc)	WLAN	8.71	± 9.6 %
10629	AAC	IEEE 802.11ac WiFi (80MHz, MCS3, 90pc dc)	WLAN	8.85	± 9.6 %
10630	AAC	IEEE 802.11ac WiFi (80MHz, MCS4, 90pc dc)	WLAN	8.72	± 9.6 %
10631	AAC	IEEE 802.11ac WiFi (80MHz, MCS5, 90pc dc)	WLAN	8.81	± 9.6 %
10632	AAC	IEEE 802.11ac WiFi (80MHz, MCS6, 90pc dc)	WLAN	8.74	± 9.6 %
10633	AAC	IEEE 802.11ac WiFi (80MHz, MCS7, 90pc dc)	WLAN	8.83	± 9.6 %
10634	AAC	IEEE 802.11ac WiFi (80MHz, MCS8, 90pc dc)	WLAN	8.80	± 9.6 %
10635	AAC	IEEE 802.11ac WiFi (80MHz, MCS9, 90pc dc)	WLAN	8.81	± 9.6 %
10636	AAC	IEEE 802.11ac WiFi (160MHz, MCS0, 90pc dc)	WLAN	8.83	± 9.6 %
10637	AAC	IEEE 802.11ac WiFi (160MHz, MCS1, 90pc dc)	WLAN	8.79	± 9.6 %
10638	AAC	IEEE 802.11ac WiFi (160MHz, MCS2, 90pc dc)	WLAN	8.86	± 9.6 %
10639	AAC	IEEE 802.11ac WiFi (160MHz, MCS3, 90pc dc)	WLAN	8.85	± 9.6 %
10640	AAC	IEEE 802.11ac WiFi (160MHz, MCS4, 90pc dc)	WLAN	8.98	± 9.6 %
10641	AAC	IEEE 802.11ac WiFi (160MHz, MCS5, 90pc dc)	WLAN	9.06	± 9.6 %
10642	AAC	IEEE 802.11ac WiFi (160MHz, MCS6, 90pc dc)	WLAN	9.06	± 9.6 %
10643	AAC	IEEE 802.11ac WiFi (160MHz, MCS7, 90pc dc)	WLAN	8.89	± 9.6 %
10644	AAC	IEEE 802.11ac WiFi (160MHz, MCS8, 90pc dc)	WLAN	9.05	± 9.6 %
10645	AAC	IEEE 802.11ac WiFi (160MHz, MCS9, 90pc dc)	WLAN	9.11	± 9.6 %
10646	AAC	LTE-TDD (SC-FDMA, 1 RB, 5 MHz, QPSK, UL Sub=2,7)	LTE-TDD	11.96	± 9.6 %
10647	AAC	LTE-TDD (SC-FDMA, 1 RB, 20 MHz, QPSK, UL Sub=2,7)	LTE-TDD	11.98	± 9.6 %
10648	AAC	CDMA2000 (1x Advanced)	CDMA2000	3.45	± 9.6 %
10652	AAC	LTE-TDD (OFDMA, 5 MHz, E-TM 3.1, Clipping 44%)	LTE-TDD	6.91	± 9.6 %
10653	AAC	LTE-TDD (OFDMA, 10 MHz, E-TM 3.1, Clipping 44%)	LTE-TDD	7.42	± 9.6 %
10654	AAC	LTE-TDD (OFDMA, 15 MHz, E-TM 3.1, Clipping 44%)	LTE-TDD	6.96	± 9.6 %
10655	AAC	LTE-TDD (OFDMA, 20 MHz, E-TM 3.1, Clipping 44%)	LTE-TDD	7.21	± 9.6 %
10658	AAC	Pulse Waveform (200Hz, 10%)	Test	10.00	± 9.6 %
10659	AAC	Pulse Waveform (200Hz, 20%)	Test	6.99	± 9.6 %
10660	AAC	Pulse Waveform (200Hz, 40%)	Test	3.98	± 9.6 %
10661	AAC	Pulse Waveform (200Hz, 60%)	Test	2.22	± 9.6 %
10662	AAC	Pulse Waveform (200Hz, 80%)	Test	0.97	± 9.6 %
10670	AAC	Bluetooth Low Energy	Bluetooth	2.19	± 9.6 %
10671	AAD	IEEE 802.11ax (20MHz, MCS0, 90pc dc)	WLAN	9.09	± 9.6 %

10672	AAD	IEEE 802.11ax (20MHz, MCS1, 90pc dc)	WLAN	8.57	± 9.6 %
10673	AAD	IEEE 802.11ax (20MHz, MCS2, 90pc dc)	WLAN	8.78	± 9.6 %
10674	AAD	IEEE 802.11ax (20MHz, MCS3, 90pc dc)	WLAN	8.74	± 9.6 %
10675	AAD	IEEE 802.11ax (20MHz, MCS4, 90pc dc)	WLAN	8.90	± 9.6 %
10676	AAD	IEEE 802.11ax (20MHz, MCS5, 90pc dc)	WLAN	8.77	± 9.6 %
10677	AAD	IEEE 802.11ax (20MHz, MCS6, 90pc dc)	WLAN	8.73	± 9.6 %
10678	AAD	IEEE 802.11ax (20MHz, MCS7, 90pc dc)	WLAN	8.78	± 9.6 %
10679	AAD	IEEE 802.11ax (20MHz, MCS8, 90pc dc)	WLAN	8.89	± 9.6 %
10680	AAD	IEEE 802.11ax (20MHz, MCS9, 90pc dc)	WLAN	8.80	± 9.6 %
10681	AAG	IEEE 802.11ax (20MHz, MCS10, 90pc dc)	WLAN	8.62	± 9.6 %
10682	AAF	IEEE 802.11ax (20MHz, MCS11, 90pc dc)	WLAN	8.83	± 9.6 %
10683	AAA	IEEE 802.11ax (20MHz, MCS0, 99pc dc)	WLAN	8.42	± 9.6 %
10684	AAC	IEEE 802.11ax (20MHz, MCS1, 99pc dc)	WLAN	8.26	± 9.6 %
10685	AAC	IEEE 802.11ax (20MHz, MCS2, 99pc dc)	WLAN	8.33	± 9.6 %
10686	AAC	IEEE 802.11ax (20MHz, MCS3, 99pc dc)	WLAN	8.28	± 9.6 %
10687	AAE	IEEE 802.11ax (20MHz, MCS4, 99pc dc)	WLAN	8.45	± 9.6 %
10688	AAE	IEEE 802.11ax (20MHz, MCS5, 99pc dc)	WLAN	8.29	± 9.6 %
10689	AAD	IEEE 802.11ax (20MHz, MCS6, 99pc dc)	WLAN	8.55	± 9.6 %
10690	AAE	IEEE 802.11ax (20MHz, MCS7, 99pc dc)	WLAN	8.29	± 9.6 %
10691	AAB	IEEE 802.11ax (20MHz, MCS8, 99pc dc)	WLAN	8.25	± 9.6 %
10692	AAA	IEEE 802.11ax (20MHz, MCS9, 99pc dc)	WLAN	8.29	± 9.6 %
10693	AAA	IEEE 802.11ax (20MHz, MCS10, 99pc dc)	WLAN	8.25	± 9.6 %
10694	AAA	IEEE 802.11ax (20MHz, MCS11, 99pc dc)	WLAN	8.57	± 9.6 %
10695	AAA	IEEE 802.11ax (40MHz, MCS0, 90pc dc)	WLAN	8.78	± 9.6 %
10696	AAA	IEEE 802.11ax (40MHz, MCS1, 90pc dc)	WLAN	8.91	± 9.6 %
10697	AAA	IEEE 802.11ax (40MHz, MCS2, 90pc dc)	WLAN	8.61	± 9.6 %
10698	AAA	IEEE 802.11ax (40MHz, MCS3, 90pc dc)	WLAN	8.89	± 9.6 %
10699	AAA	IEEE 802.11ax (40MHz, MCS4, 90pc dc)	WLAN	8.82	± 9.6 %
10700	AAA	IEEE 802.11ax (40MHz, MCS5, 90pc dc)	WLAN	8.73	± 9.6 %
10701	AAA	IEEE 802.11ax (40MHz, MCS6, 90pc dc)	WLAN	8.86	± 9.6 %
10702	AAA	IEEE 802.11ax (40MHz, MCS7, 90pc dc)	WLAN	8.70	± 9.6 %
10703	AAA	IEEE 802.11ax (40MHz, MCS8, 90pc dc)	WLAN	8.82	± 9.6 %
10704	AAA	IEEE 802.11ax (40MHz, MCS9, 90pc dc)	WLAN	8.56	± 9.6 %
10705	AAA	IEEE 802.11ax (40MHz, MCS10, 90pc dc)	WLAN	8.69	± 9.6 %
10706	AAC	IEEE 802.11ax (40MHz, MCS11, 90pc dc)	WLAN	8.66	± 9.6 %
10707	AAC	IEEE 802.11ax (40MHz, MCS0, 99pc dc)	WLAN	8.32	± 9.6 %
10708	AAC	IEEE 802.11ax (40MHz, MCS1, 99pc dc)	WLAN	8.55	± 9.6 %
10709	AAC	IEEE 802.11ax (40MHz, MCS2, 99pc dc)	WLAN	8.33	± 9.6 %
10710	AAC	IEEE 802.11ax (40MHz, MCS3, 99pc dc)	WLAN	8.29	± 9.6 %
10711	AAC	IEEE 802.11ax (40MHz, MCS4, 99pc dc)	WLAN	8.39	± 9.6 %
10712	AAC	IEEE 802.11ax (40MHz, MCS5, 99pc dc)	WLAN	8.67	± 9.6 %
10713	AAC	IEEE 802.11ax (40MHz, MCS6, 99pc dc)	WLAN	8.33	± 9.6 %
10714	AAC	IEEE 802.11ax (40MHz, MCS7, 99pc dc)	WLAN	8.26	± 9.6 %
10715	AAC	IEEE 802.11ax (40MHz, MCS8, 99pc dc)	WLAN	8.45	± 9.6 %
10716	AAC	IEEE 802.11ax (40MHz, MCS9, 99pc dc)	WLAN	8.30	± 9.6 %
10717	AAC	IEEE 802.11ax (40MHz, MCS10, 99pc dc)	WLAN	8.48	± 9.6 %
10718	AAC	IEEE 802.11ax (40MHz, MCS11, 99pc dc)	WLAN	8.24	± 9.6 %
10719	AAC	IEEE 802.11ax (80MHz, MCS0, 90pc dc)	WLAN	8.81	± 9.6 %
10720	AAC	IEEE 802.11ax (80MHz, MCS1, 90pc dc)	WLAN	8.87	± 9.6 %
10721	AAC	IEEE 802.11ax (80MHz, MCS2, 90pc dc)	WLAN	8.76	± 9.6 %
10722	AAC	IEEE 802.11ax (80MHz, MCS3, 90pc dc)	WLAN	8.55	± 9.6 %
10723	AAC	IEEE 802.11ax (80MHz, MCS4, 90pc dc)	WLAN	8.70	± 9.6 %
10724	AAC	IEEE 802.11ax (80MHz, MCS5, 90pc dc)	WLAN	8.90	± 9.6 %
10725	AAC	IEEE 802.11ax (80MHz, MCS6, 90pc dc)	WLAN	8.74	± 9.6 %
10726	AAC	IEEE 802.11ax (80MHz, MCS7, 90pc dc)	WLAN	8.72	± 9.6 %
10727	AAC	IEEE 802.11ax (80MHz, MCS8, 90pc dc)	WLAN	8.66	± 9.6 %

10728	AAC	IEEE 802.11ax (80MHz, MCS9, 90pc dc)	WLAN	8.65	± 9.6 %
10729	AAC	IEEE 802.11ax (80MHz, MCS10, 90pc dc)	WLAN	8.64	± 9.6 %
10730	AAC	IEEE 802.11ax (80MHz, MCS11, 90pc dc)	WLAN	8.67	± 9.6 %
10731	AAC	IEEE 802.11ax (80MHz, MCS0, 99pc dc)	WLAN	8.42	± 9.6 %
10732	AAC	IEEE 802.11ax (80MHz, MCS1, 99pc dc)	WLAN	8.46	± 9.6 %
10733	AAC	IEEE 802.11ax (80MHz, MCS2, 99pc dc)	WLAN	8.40	± 9.6 %
10734	AAC	IEEE 802.11ax (80MHz, MCS3, 99pc dc)	WLAN	8.25	± 9.6 %
10735	AAC	IEEE 802.11ax (80MHz, MCS4, 99pc dc)	WLAN	8.33	± 9.6 %
10736	AAC	IEEE 802.11ax (80MHz, MCS5, 99pc dc)	WLAN	8.27	± 9.6 %
10737	AAC	IEEE 802.11ax (80MHz, MCS6, 99pc dc)	WLAN	8.36	± 9.6 %
10738	AAC	IEEE 802.11ax (80MHz, MCS7, 99pc dc)	WLAN	8.42	± 9.6 %
10739	AAC	IEEE 802.11ax (80MHz, MCS8, 99pc dc)	WLAN	8.29	± 9.6 %
10740	AAC	IEEE 802.11ax (80MHz, MCS9, 99pc dc)	WLAN	8.48	± 9.6 %
10741	AAC	IEEE 802.11ax (80MHz, MCS10, 99pc dc)	WLAN	8.40	± 9.6 %
10742	AAC	IEEE 802.11ax (80MHz, MCS11, 99pc dc)	WLAN	8.43	± 9.6 %
10743	AAC	IEEE 802.11ax (160MHz, MCS0, 90pc dc)	WLAN	8.94	± 9.6 %
10744	AAC	IEEE 802.11ax (160MHz, MCS1, 90pc dc)	WLAN	9.16	± 9.6 %
10745	AAC	IEEE 802.11ax (160MHz, MCS2, 90pc dc)	WLAN	8.93	± 9.6 %
10746	AAC	IEEE 802.11ax (160MHz, MCS3, 90pc dc)	WLAN	9.11	± 9.6 %
10747	AAC	IEEE 802.11ax (160MHz, MCS4, 90pc dc)	WLAN	9.04	± 9.6 %
10748	AAC	IEEE 802.11ax (160MHz, MCS5, 90pc dc)	WLAN	8.93	± 9.6 %
10749	AAC	IEEE 802.11ax (160MHz, MCS6, 90pc dc)	WLAN	8.90	± 9.6 %
10750	AAC	IEEE 802.11ax (160MHz, MCS7, 90pc dc)	WLAN	8.79	± 9.6 %
10751	AAC	IEEE 802.11ax (160MHz, MCS8, 90pc dc)	WLAN	8.82	± 9.6 %
10752	AAC	IEEE 802.11ax (160MHz, MCS9, 90pc dc)	WLAN	8.81	± 9.6 %
10753	AAC	IEEE 802.11ax (160MHz, MCS10, 90pc dc)	WLAN	9.00	± 9.6 %
10754	AAC	IEEE 802.11ax (160MHz, MCS11, 90pc dc)	WLAN	8.94	± 9.6 %
10755	AAC	IEEE 802.11ax (160MHz, MCS0, 99pc dc)	WLAN	8.64	± 9.6 %
10756	AAC	IEEE 802.11ax (160MHz, MCS1, 99pc dc)	WLAN	8.77	± 9.6 %
10757	AAC	IEEE 802.11ax (160MHz, MCS2, 99pc dc)	WLAN	8.77	± 9.6 %
10758	AAC	IEEE 802.11ax (160MHz, MCS3, 99pc dc)	WLAN	8.69	± 9.6 %
10759	AAC	IEEE 802.11ax (160MHz, MCS4, 99pc dc)	WLAN	8.58	± 9.6 %
10760	AAC	IEEE 802.11ax (160MHz, MCS5, 99pc dc)	WLAN	8.49	± 9.6 %
10761	AAC	IEEE 802.11ax (160MHz, MCS6, 99pc dc)	WLAN	8.58	± 9.6 %
10762	AAC	IEEE 802.11ax (160MHz, MCS7, 99pc dc)	WLAN	8.49	± 9.6 %
10763	AAC	IEEE 802.11ax (160MHz, MCS8, 99pc dc)	WLAN	8.53	± 9.6 %
10764	AAC	IEEE 802.11ax (160MHz, MCS9, 99pc dc)	WLAN	8.54	± 9.6 %
10765	AAC	IEEE 802.11ax (160MHz, MCS10, 99pc dc)	WLAN	8.54	± 9.6 %
10766	AAC	IEEE 802.11ax (160MHz, MCS11, 99pc dc)	WLAN	8.51	± 9.6 %
10767	AAC	5G NR (CP-OFDM, 1 RB, 5 MHz, QPSK, 15 kHz)	5G NR FR1 TDD	7.99	± 9.6 %
10768	AAC	5G NR (CP-OFDM, 1 RB, 10 MHz, QPSK, 15 kHz)	5G NR FR1 TDD	8.01	± 9.6 %
10769	AAC	5G NR (CP-OFDM, 1 RB, 15 MHz, QPSK, 15 kHz)	5G NR FR1 TDD	8.01	± 9.6 %
10770	AAC	5G NR (CP-OFDM, 1 RB, 20 MHz, QPSK, 15 kHz)	5G NR FR1 TDD	8.02	± 9.6 %
10771	AAC	5G NR (CP-OFDM, 1 RB, 25 MHz, QPSK, 15 kHz)	5G NR FR1 TDD	8.02	± 9.6 %
10772	AAC	5G NR (CP-OFDM, 1 RB, 30 MHz, QPSK, 15 kHz)	5G NR FR1 TDD	8.23	± 9.6 %
10773	AAC	5G NR (CP-OFDM, 1 RB, 40 MHz, QPSK, 15 kHz)	5G NR FR1 TDD	8.03	± 9.6 %
10774	AAC	5G NR (CP-OFDM, 1 RB, 50 MHz, QPSK, 15 kHz)	5G NR FR1 TDD	8.02	± 9.6 %
10775	AAC	5G NR (CP-OFDM, 50% RB, 5 MHz, QPSK, 15 kHz)	5G NR FR1 TDD	8.31	± 9.6 %
10776	AAC	5G NR (CP-OFDM, 50% RB, 10 MHz, QPSK, 15 kHz)	5G NR FR1 TDD	8.30	± 9.6 %
10777	AAC	5G NR (CP-OFDM, 50% RB, 15 MHz, QPSK, 15 kHz)	5G NR FR1 TDD	8.30	± 9.6 %
10778	AAC	5G NR (CP-OFDM, 50% RB, 20 MHz, QPSK, 15 kHz)	5G NR FR1 TDD	8.34	± 9.6 %
10779	AAC	5G NR (CP-OFDM, 50% RB, 25 MHz, QPSK, 15 kHz)	5G NR FR1 TDD	8.42	± 9.6 %
10780	AAC	5G NR (CP-OFDM, 50% RB, 30 MHz, QPSK, 15 kHz)	5G NR FR1 TDD	8.38	± 9.6 %
10781	AAC	5G NR (CP-OFDM, 50% RB, 40 MHz, QPSK, 15 kHz)	5G NR FR1 TDD	8.38	± 9.6 %
10782	AAC	5G NR (CP-OFDM, 50% RB, 50 MHz, QPSK, 15 kHz)	5G NR FR1 TDD	8.43	± 9.6 %
10783	AAC	5G NR (CP-OFDM, 100% RB, 5 MHz, QPSK, 15 kHz)	5G NR FR1 TDD	8.31	± 9.6 %

10784	AAC	5G NR (CP-OFDM, 100% RB, 10 MHz, QPSK, 15 kHz)	5G NR FR1 TDD	8.29	± 9.6 %
10785	AAC	5G NR (CP-OFDM, 100% RB, 15 MHz, QPSK, 15 kHz)	5G NR FR1 TDD	8.40	± 9.6 %
10786	AAC	5G NR (CP-OFDM, 100% RB, 20 MHz, QPSK, 15 kHz)	5G NR FR1 TDD	8.35	± 9.6 %
10787	AAC	5G NR (CP-OFDM, 100% RB, 25 MHz, QPSK, 15 kHz)	5G NR FR1 TDD	8.44	± 9.6 %
10788	AAC	5G NR (CP-OFDM, 100% RB, 30 MHz, QPSK, 15 kHz)	5G NR FR1 TDD	8.39	± 9.6 %
10789	AAC	5G NR (CP-OFDM, 100% RB, 40 MHz, QPSK, 15 kHz)	5G NR FR1 TDD	8.37	± 9.6 %
10790	AAC	5G NR (CP-OFDM, 100% RB, 50 MHz, QPSK, 15 kHz)	5G NR FR1 TDD	8.39	± 9.6 %
10791	AAC	5G NR (CP-OFDM, 1 RB, 5 MHz, QPSK, 30 kHz)	5G NR FR1 TDD	7.83	± 9.6 %
10792	AAC	5G NR (CP-OFDM, 1 RB, 10 MHz, QPSK, 30 kHz)	5G NR FR1 TDD	7.92	± 9.6 %
10793	AAC	5G NR (CP-OFDM, 1 RB, 15 MHz, QPSK, 30 kHz)	5G NR FR1 TDD	7.95	± 9.6 %
10794	AAC	5G NR (CP-OFDM, 1 RB, 20 MHz, QPSK, 30 kHz)	5G NR FR1 TDD	7.82	± 9.6 %
10795	AAC	5G NR (CP-OFDM, 1 RB, 25 MHz, QPSK, 30 kHz)	5G NR FR1 TDD	7.84	± 9.6 %
10796	AAC	5G NR (CP-OFDM, 1 RB, 30 MHz, QPSK, 30 kHz)	5G NR FR1 TDD	7.82	± 9.6 %
10797	AAC	5G NR (CP-OFDM, 1 RB, 40 MHz, QPSK, 30 kHz)	5G NR FR1 TDD	8.01	± 9.6 %
10798	AAC	5G NR (CP-OFDM, 1 RB, 50 MHz, QPSK, 30 kHz)	5G NR FR1 TDD	7.89	± 9.6 %
10799	AAC	5G NR (CP-OFDM, 1 RB, 60 MHz, QPSK, 30 kHz)	5G NR FR1 TDD	7.93	± 9.6 %
10801	AAC	5G NR (CP-OFDM, 1 RB, 80 MHz, QPSK, 30 kHz)	5G NR FR1 TDD	7.89	± 9.6 %
10802	AAC	5G NR (CP-OFDM, 1 RB, 90 MHz, QPSK, 30 kHz)	5G NR FR1 TDD	7.87	± 9.6 %
10803	AAE	5G NR (CP-OFDM, 1 RB, 100 MHz, QPSK, 30 kHz)	5G NR FR1 TDD	7.93	± 9.6 %
10805	AAD	5G NR (CP-OFDM, 50% RB, 10 MHz, QPSK, 30 kHz)	5G NR FR1 TDD	8.34	± 9.6 %
10806	AAD	5G NR (CP-OFDM, 50% RB, 15 MHz, QPSK, 30 kHz)	5G NR FR1 TDD	8.37	± 9.6 %
10809	AAD	5G NR (CP-OFDM, 50% RB, 30 MHz, QPSK, 30 kHz)	5G NR FR1 TDD	8.34	± 9.6 %
10810	AAD	5G NR (CP-OFDM, 50% RB, 40 MHz, QPSK, 30 kHz)	5G NR FR1 TDD	8.34	± 9.6 %
10812	AAD	5G NR (CP-OFDM, 50% RB, 60 MHz, QPSK, 30 kHz)	5G NR FR1 TDD	8.35	± 9.6 %
10817	AAD	5G NR (CP-OFDM, 100% RB, 5 MHz, QPSK, 30 kHz)	5G NR FR1 TDD	8.35	± 9.6 %
10818	AAD	5G NR (CP-OFDM, 100% RB, 10 MHz, QPSK, 30 kHz)	5G NR FR1 TDD	8.34	± 9.6 %
10819	AAD	5G NR (CP-OFDM, 100% RB, 15 MHz, QPSK, 30 kHz)	5G NR FR1 TDD	8.33	± 9.6 %
10820	AAD	5G NR (CP-OFDM, 100% RB, 20 MHz, QPSK, 30 kHz)	5G NR FR1 TDD	8.30	± 9.6 %
10821	AAC	5G NR (CP-OFDM, 100% RB, 25 MHz, QPSK, 30 kHz)	5G NR FR1 TDD	8.41	± 9.6 %
10822	AAD	5G NR (CP-OFDM, 100% RB, 30 MHz, QPSK, 30 kHz)	5G NR FR1 TDD	8.41	± 9.6 %
10823	AAC	5G NR (CP-OFDM, 100% RB, 40 MHz, QPSK, 30 kHz)	5G NR FR1 TDD	8.36	± 9.6 %
10824	AAD	5G NR (CP-OFDM, 100% RB, 50 MHz, QPSK, 30 kHz)	5G NR FR1 TDD	8.39	± 9.6 %
10825	AAD	5G NR (CP-OFDM, 100% RB, 60 MHz, QPSK, 30 kHz)	5G NR FR1 TDD	8.41	± 9.6 %
10827	AAD	5G NR (CP-OFDM, 100% RB, 80 MHz, QPSK, 30 kHz)	5G NR FR1 TDD	8.42	± 9.6 %
10828	AAE	5G NR (CP-OFDM, 100% RB, 90 MHz, QPSK, 30 kHz)	5G NR FR1 TDD	8.43	± 9.6 %
10829	AAD	5G NR (CP-OFDM, 100% RB, 100 MHz, QPSK, 30 kHz)	5G NR FR1 TDD	8.40	± 9.6 %
10830	AAD	5G NR (CP-OFDM, 1 RB, 10 MHz, QPSK, 60 kHz)	5G NR FR1 TDD	7.63	± 9.6 %
10831	AAD	5G NR (CP-OFDM, 1 RB, 15 MHz, QPSK, 60 kHz)	5G NR FR1 TDD	7.73	± 9.6 %
10832	AAD	5G NR (CP-OFDM, 1 RB, 20 MHz, QPSK, 60 kHz)	5G NR FR1 TDD	7.74	± 9.6 %
10833	AAD	5G NR (CP-OFDM, 1 RB, 25 MHz, QPSK, 60 kHz)	5G NR FR1 TDD	7.70	± 9.6 %
10834	AAD	5G NR (CP-OFDM, 1 RB, 30 MHz, QPSK, 60 kHz)	5G NR FR1 TDD	7.75	± 9.6 %
10835	AAD	5G NR (CP-OFDM, 1 RB, 40 MHz, QPSK, 60 kHz)	5G NR FR1 TDD	7.70	± 9.6 %
10836	AAE	5G NR (CP-OFDM, 1 RB, 50 MHz, QPSK, 60 kHz)	5G NR FR1 TDD	7.66	± 9.6 %
10837	AAD	5G NR (CP-OFDM, 1 RB, 60 MHz, QPSK, 60 kHz)	5G NR FR1 TDD	7.68	± 9.6 %
10839	AAD	5G NR (CP-OFDM, 1 RB, 80 MHz, QPSK, 60 kHz)	5G NR FR1 TDD	7.70	± 9.6 %
10840	AAD	5G NR (CP-OFDM, 1 RB, 90 MHz, QPSK, 60 kHz)	5G NR FR1 TDD	7.67	± 9.6 %
10841	AAD	5G NR (CP-OFDM, 1 RB, 100 MHz, QPSK, 60 kHz)	5G NR FR1 TDD	7.71	± 9.6 %
10843	AAD	5G NR (CP-OFDM, 50% RB, 15 MHz, QPSK, 60 kHz)	5G NR FR1 TDD	8.49	± 9.6 %
10844	AAD	5G NR (CP-OFDM, 50% RB, 20 MHz, QPSK, 60 kHz)	5G NR FR1 TDD	8.34	± 9.6 %
10846	AAD	5G NR (CP-OFDM, 50% RB, 30 MHz, QPSK, 60 kHz)	5G NR FR1 TDD	8.41	± 9.6 %
10854	AAD	5G NR (CP-OFDM, 100% RB, 10 MHz, QPSK, 60 kHz)	5G NR FR1 TDD	8.34	± 9.6 %
10855	AAD	5G NR (CP-OFDM, 100% RB, 15 MHz, QPSK, 60 kHz)	5G NR FR1 TDD	8.36	± 9.6 %
10856	AAD	5G NR (CP-OFDM, 100% RB, 20 MHz, QPSK, 60 kHz)	5G NR FR1 TDD	8.37	± 9.6 %
10857	AAD	5G NR (CP-OFDM, 100% RB, 25 MHz, QPSK, 60 kHz)	5G NR FR1 TDD	8.35	± 9.6 %
10858	AAD	5G NR (CP-OFDM, 100% RB, 30 MHz, QPSK, 60 kHz)	5G NR FR1 TDD	8.36	± 9.6 %
10859	AAD	5G NR (CP-OFDM, 100% RB, 40 MHz, QPSK, 60 kHz)	5G NR FR1 TDD	8.34	± 9.6 %

10860	AAD	5G NR (CP-OFDM, 100% RB, 50 MHz, QPSK, 60 kHz)	5G NR FR1 TDD	8.41	± 9.6 %
10861	AAD	5G NR (CP-OFDM, 100% RB, 60 MHz, QPSK, 60 kHz)	5G NR FR1 TDD	8.40	± 9.6 %
10863	AAD	5G NR (CP-OFDM, 100% RB, 80 MHz, QPSK, 60 kHz)	5G NR FR1 TDD	8.41	± 9.6 %
10864	AAE	5G NR (CP-OFDM, 100% RB, 90 MHz, QPSK, 60 kHz)	5G NR FR1 TDD	8.37	± 9.6 %
10865	AAD	5G NR (CP-OFDM, 100% RB, 100 MHz, QPSK, 60 kHz)	5G NR FR1 TDD	8.41	± 9.6 %
10866	AAD	5G NR (DFT-s-OFDM, 1 RB, 100 MHz, QPSK, 30 kHz)	5G NR FR1 TDD	5.68	± 9.6 %
10868	AAD	5G NR (DFT-s-OFDM, 100% RB, 100 MHz, QPSK, 30 kHz)	5G NR FR1 TDD	5.89	± 9.6 %
10869	AAD	5G NR (DFT-s-OFDM, 1 RB, 100 MHz, QPSK, 120 kHz)	5G NR FR2 TDD	5.75	± 9.6 %
10870	AAD	5G NR (DFT-s-OFDM, 100% RB, 100 MHz, QPSK, 120 kHz)	5G NR FR2 TDD	5.86	± 9.6 %
10871	AAD	5G NR (DFT-s-OFDM, 1 RB, 100 MHz, 16QAM, 120 kHz)	5G NR FR2 TDD	5.75	± 9.6 %
10872	AAD	5G NR (DFT-s-OFDM, 100% RB, 100 MHz, 16QAM, 120 kHz)	5G NR FR2 TDD	6.52	± 9.6 %
10873	AAD	5G NR (DFT-s-OFDM, 1 RB, 100 MHz, 64QAM, 120 kHz)	5G NR FR2 TDD	6.61	± 9.6 %
10874	AAD	5G NR (DFT-s-OFDM, 100% RB, 100 MHz, 64QAM, 120 kHz)	5G NR FR2 TDD	6.65	± 9.6 %
10875	AAD	5G NR (CP-OFDM, 1 RB, 100 MHz, QPSK, 120 kHz)	5G NR FR2 TDD	7.78	± 9.6 %
10876	AAD	5G NR (CP-OFDM, 100% RB, 100 MHz, QPSK, 120 kHz)	5G NR FR2 TDD	8.39	± 9.6 %
10877	AAD	5G NR (CP-OFDM, 1 RB, 100 MHz, 16QAM, 120 kHz)	5G NR FR2 TDD	7.95	± 9.6 %
10878	AAD	5G NR (CP-OFDM, 100% RB, 100 MHz, 16QAM, 120 kHz)	5G NR FR2 TDD	8.41	± 9.6 %
10879	AAD	5G NR (CP-OFDM, 1 RB, 100 MHz, 64QAM, 120 kHz)	5G NR FR2 TDD	8.12	± 9.6 %
10880	AAD	5G NR (CP-OFDM, 100% RB, 100 MHz, 64QAM, 120 kHz)	5G NR FR2 TDD	8.38	± 9.6 %
10881	AAD	5G NR (DFT-s-OFDM, 1 RB, 50 MHz, QPSK, 120 kHz)	5G NR FR2 TDD	5.75	± 9.6 %
10882	AAD	5G NR (DFT-s-OFDM, 100% RB, 50 MHz, QPSK, 120 kHz)	5G NR FR2 TDD	5.96	± 9.6 %
10883	AAD	5G NR (DFT-s-OFDM, 1 RB, 50 MHz, 16QAM, 120 kHz)	5G NR FR2 TDD	6.57	± 9.6 %
10884	AAD	5G NR (DFT-s-OFDM, 100% RB, 50 MHz, 16QAM, 120 kHz)	5G NR FR2 TDD	6.53	± 9.6 %
10885	AAD	5G NR (DFT-s-OFDM, 1 RB, 50 MHz, 64QAM, 120 kHz)	5G NR FR2 TDD	6.61	± 9.6 %
10886	AAD	5G NR (DFT-s-OFDM, 100% RB, 50 MHz, 64QAM, 120 kHz)	5G NR FR2 TDD	6.65	± 9.6 %
10887	AAD	5G NR (CP-OFDM, 1 RB, 50 MHz, QPSK, 120 kHz)	5G NR FR2 TDD	7.78	± 9.6 %
10888	AAD	5G NR (CP-OFDM, 100% RB, 50 MHz, QPSK, 120 kHz)	5G NR FR2 TDD	8.35	± 9.6 %
10889	AAD	5G NR (CP-OFDM, 1 RB, 50 MHz, 16QAM, 120 kHz)	5G NR FR2 TDD	8.02	± 9.6 %
10890	AAD	5G NR (CP-OFDM, 100% RB, 50 MHz, 16QAM, 120 kHz)	5G NR FR2 TDD	8.40	± 9.6 %
10891	AAD	5G NR (CP-OFDM, 1 RB, 50 MHz, 64QAM, 120 kHz)	5G NR FR2 TDD	8.13	± 9.6 %
10892	AAD	5G NR (CP-OFDM, 100% RB, 50 MHz, 64QAM, 120 kHz)	5G NR FR2 TDD	8.41	± 9.6 %
10897	AAD	5G NR (DFT-s-OFDM, 1 RB, 5 MHz, QPSK, 30 kHz)	5G NR FR1 TDD	5.66	± 9.6 %
10898	AAD	5G NR (DFT-s-OFDM, 1 RB, 10 MHz, QPSK, 30 kHz)	5G NR FR1 TDD	5.67	± 9.6 %
10899	AAD	5G NR (DFT-s-OFDM, 1 RB, 15 MHz, QPSK, 30 kHz)	5G NR FR1 TDD	5.67	± 9.6 %
10900	AAD	5G NR (DFT-s-OFDM, 1 RB, 20 MHz, QPSK, 30 kHz)	5G NR FR1 TDD	5.68	± 9.6 %
10901	AAD	5G NR (DFT-s-OFDM, 1 RB, 25 MHz, QPSK, 30 kHz)	5G NR FR1 TDD	5.68	± 9.6 %
10902	AAD	5G NR (DFT-s-OFDM, 1 RB, 30 MHz, QPSK, 30 kHz)	5G NR FR1 TDD	5.68	± 9.6 %
10903	AAD	5G NR (DFT-s-OFDM, 1 RB, 40 MHz, QPSK, 30 kHz)	5G NR FR1 TDD	5.68	± 9.6 %
10904	AAD	5G NR (DFT-s-OFDM, 1 RB, 50 MHz, QPSK, 30 kHz)	5G NR FR1 TDD	5.68	± 9.6 %
10905	AAD	5G NR (DFT-s-OFDM, 1 RB, 60 MHz, QPSK, 30 kHz)	5G NR FR1 TDD	5.68	± 9.6 %
10906	AAD	5G NR (DFT-s-OFDM, 1 RB, 80 MHz, QPSK, 30 kHz)	5G NR FR1 TDD	5.68	± 9.6 %
10907	AAD	5G NR (DFT-s-OFDM, 50% RB, 5 MHz, QPSK, 30 kHz)	5G NR FR1 TDD	5.78	± 9.6 %
10908	AAD	5G NR (DFT-s-OFDM, 50% RB, 10 MHz, QPSK, 30 kHz)	5G NR FR1 TDD	5.93	± 9.6 %
10909	AAD	5G NR (DFT-s-OFDM, 50% RB, 15 MHz, QPSK, 30 kHz)	5G NR FR1 TDD	5.96	± 9.6 %
10910	AAD	5G NR (DFT-s-OFDM, 50% RB, 20 MHz, QPSK, 30 kHz)	5G NR FR1 TDD	5.83	± 9.6 %
10911	AAD	5G NR (DFT-s-OFDM, 50% RB, 25 MHz, QPSK, 30 kHz)	5G NR FR1 TDD	5.93	± 9.6 %
10912	AAD	5G NR (DFT-s-OFDM, 50% RB, 30 MHz, QPSK, 30 kHz)	5G NR FR1 TDD	5.84	± 9.6 %
10913	AAD	5G NR (DFT-s-OFDM, 50% RB, 40 MHz, QPSK, 30 kHz)	5G NR FR1 TDD	5.84	± 9.6 %
10914	AAD	5G NR (DFT-s-OFDM, 50% RB, 50 MHz, QPSK, 30 kHz)	5G NR FR1 TDD	5.85	± 9.6 %
10915	AAD	5G NR (DFT-s-OFDM, 50% RB, 60 MHz, QPSK, 30 kHz)	5G NR FR1 TDD	5.83	± 9.6 %
10916	AAD	5G NR (DFT-s-OFDM, 50% RB, 80 MHz, QPSK, 30 kHz)	5G NR FR1 TDD	5.87	± 9.6 %
10917	AAD	5G NR (DFT-s-OFDM, 50% RB, 100 MHz, QPSK, 30 kHz)	5G NR FR1 TDD	5.94	± 9.6 %
10918	AAD	5G NR (DFT-s-OFDM, 100% RB, 5 MHz, QPSK, 30 kHz)	5G NR FR1 TDD	5.86	± 9.6 %
10919	AAD	5G NR (DFT-s-OFDM, 100% RB, 10 MHz, QPSK, 30 kHz)	5G NR FR1 TDD	5.86	± 9.6 %
10920	AAD	5G NR (DFT-s-OFDM, 100% RB, 15 MHz, QPSK, 30 kHz)	5G NR FR1 TDD	5.87	± 9.6 %
10921	AAD	5G NR (DFT-s-OFDM, 100% RB, 20 MHz, QPSK, 30 kHz)	5G NR FR1 TDD	5.84	± 9.6 %

10922	AAD	5G NR (DFT-s-OFDM, 100% RB, 25 MHz, QPSK, 30 kHz)	5G NR FR1 TDD	5.82	± 9.6 %
10923	AAD	5G NR (DFT-s-OFDM, 100% RB, 30 MHz, QPSK, 30 kHz)	5G NR FR1 TDD	5.84	± 9.6 %
10924	AAD	5G NR (DFT-s-OFDM, 100% RB, 40 MHz, QPSK, 30 kHz)	5G NR FR1 TDD	5.84	± 9.6 %
10925	AAD	5G NR (DFT-s-OFDM, 100% RB, 50 MHz, QPSK, 30 kHz)	5G NR FR1 TDD	5.95	± 9.6 %
10926	AAD	5G NR (DFT-s-OFDM, 100% RB, 60 MHz, QPSK, 30 kHz)	5G NR FR1 TDD	5.84	± 9.6 %
10927	AAD	5G NR (DFT-s-OFDM, 100% RB, 80 MHz, QPSK, 30 kHz)	5G NR FR1 TDD	5.94	± 9.6 %
10928	AAD	5G NR (DFT-s-OFDM, 1 RB, 5 MHz, QPSK, 15 kHz)	5G NR FR1 FDD	5.52	± 9.6 %
10929	AAD	5G NR (DFT-s-OFDM, 1 RB, 10 MHz, QPSK, 15 kHz)	5G NR FR1 FDD	5.52	± 9.6 %
10930	AAD	5G NR (DFT-s-OFDM, 1 RB, 15 MHz, QPSK, 15 kHz)	5G NR FR1 FDD	5.52	± 9.6 %
10931	AAD	5G NR (DFT-s-OFDM, 1 RB, 20 MHz, QPSK, 15 kHz)	5G NR FR1 FDD	5.51	± 9.6 %
10932	AAB	5G NR (DFT-s-OFDM, 1 RB, 25 MHz, QPSK, 15 kHz)	5G NR FR1 FDD	5.51	± 9.6 %
10933	AAA	5G NR (DFT-s-OFDM, 1 RB, 30 MHz, QPSK, 15 kHz)	5G NR FR1 FDD	5.51	± 9.6 %
10934	AAA	5G NR (DFT-s-OFDM, 1 RB, 40 MHz, QPSK, 15 kHz)	5G NR FR1 FDD	5.51	± 9.6 %
10935	AAA	5G NR (DFT-s-OFDM, 1 RB, 50 MHz, QPSK, 15 kHz)	5G NR FR1 FDD	5.51	± 9.6 %
10936	AAC	5G NR (DFT-s-OFDM, 50% RB, 5 MHz, QPSK, 15 kHz)	5G NR FR1 FDD	5.90	± 9.6 %
10937	AAB	5G NR (DFT-s-OFDM, 50% RB, 10 MHz, QPSK, 15 kHz)	5G NR FR1 FDD	5.77	± 9.6 %
10938	AAB	5G NR (DFT-s-OFDM, 50% RB, 15 MHz, QPSK, 15 kHz)	5G NR FR1 FDD	5.90	± 9.6 %
10939	AAB	5G NR (DFT-s-OFDM, 50% RB, 20 MHz, QPSK, 15 kHz)	5G NR FR1 FDD	5.82	± 9.6 %
10940	AAB	5G NR (DFT-s-OFDM, 50% RB, 25 MHz, QPSK, 15 kHz)	5G NR FR1 FDD	5.89	± 9.6 %
10941	AAB	5G NR (DFT-s-OFDM, 50% RB, 30 MHz, QPSK, 15 kHz)	5G NR FR1 FDD	5.83	± 9.6 %
10942	AAB	5G NR (DFT-s-OFDM, 50% RB, 40 MHz, QPSK, 15 kHz)	5G NR FR1 FDD	5.85	± 9.6 %
10943	AAB	5G NR (DFT-s-OFDM, 50% RB, 50 MHz, QPSK, 15 kHz)	5G NR FR1 FDD	5.95	± 9.6 %
10944	AAB	5G NR (DFT-s-OFDM, 100% RB, 5 MHz, QPSK, 15 kHz)	5G NR FR1 FDD	5.81	± 9.6 %
10945	AAB	5G NR (DFT-s-OFDM, 100% RB, 10 MHz, QPSK, 15 kHz)	5G NR FR1 FDD	5.85	± 9.6 %
10946	AAC	5G NR (DFT-s-OFDM, 100% RB, 15 MHz, QPSK, 15 kHz)	5G NR FR1 FDD	5.83	± 9.6 %
10947	AAB	5G NR (DFT-s-OFDM, 100% RB, 20 MHz, QPSK, 15 kHz)	5G NR FR1 FDD	5.87	± 9.6 %
10948	AAB	5G NR (DFT-s-OFDM, 100% RB, 25 MHz, QPSK, 15 kHz)	5G NR FR1 FDD	5.94	± 9.6 %
10949	AAB	5G NR (DFT-s-OFDM, 100% RB, 30 MHz, QPSK, 15 kHz)	5G NR FR1 FDD	5.87	± 9.6 %
10950	AAB	5G NR (DFT-s-OFDM, 100% RB, 40 MHz, QPSK, 15 kHz)	5G NR FR1 FDD	5.94	± 9.6 %
10951	AAB	5G NR (DFT-s-OFDM, 100% RB, 50 MHz, QPSK, 15 kHz)	5G NR FR1 FDD	5.92	± 9.6 %
10952	AAB	5G NR DL (CP-OFDM, TM 3.1, 5 MHz, 64-QAM, 15 kHz)	5G NR FR1 FDD	8.25	± 9.6 %
10953	AAB	5G NR DL (CP-OFDM, TM 3.1, 10 MHz, 64-QAM, 15 kHz)	5G NR FR1 FDD	8.15	± 9.6 %
10954	AAB	5G NR DL (CP-OFDM, TM 3.1, 15 MHz, 64-QAM, 15 kHz)	5G NR FR1 FDD	8.23	± 9.6 %
10955	AAB	5G NR DL (CP-OFDM, TM 3.1, 20 MHz, 64-QAM, 15 kHz)	5G NR FR1 FDD	8.42	± 9.6 %
10956	AAB	5G NR DL (CP-OFDM, TM 3.1, 5 MHz, 64-QAM, 30 kHz)	5G NR FR1 FDD	8.14	± 9.6 %
10957	AAC	5G NR DL (CP-OFDM, TM 3.1, 10 MHz, 64-QAM, 30 kHz)	5G NR FR1 FDD	8.31	± 9.6 %
10958	AAB	5G NR DL (CP-OFDM, TM 3.1, 15 MHz, 64-QAM, 30 kHz)	5G NR FR1 FDD	8.61	± 9.6 %
10959	AAB	5G NR DL (CP-OFDM, TM 3.1, 20 MHz, 64-QAM, 30 kHz)	5G NR FR1 FDD	8.33	± 9.6 %
10960	AAB	5G NR DL (CP-OFDM, TM 3.1, 5 MHz, 64-QAM, 15 kHz)	5G NR FR1 TDD	9.32	± 9.6 %
10961	AAB	5G NR DL (CP-OFDM, TM 3.1, 10 MHz, 64-QAM, 15 kHz)	5G NR FR1 TDD	9.36	± 9.6 %
10962	AAB	5G NR DL (CP-OFDM, TM 3.1, 15 MHz, 64-QAM, 15 kHz)	5G NR FR1 TDD	9.40	± 9.6 %
10963	AAB	5G NR DL (CP-OFDM, TM 3.1, 20 MHz, 64-QAM, 15 kHz)	5G NR FR1 TDD	9.55	± 9.6 %
10964	AAB	5G NR DL (CP-OFDM, TM 3.1, 5 MHz, 64-QAM, 30 kHz)	5G NR FR1 TDD	9.29	± 9.6 %
10965	AAB	5G NR DL (CP-OFDM, TM 3.1, 10 MHz, 64-QAM, 30 kHz)	5G NR FR1 TDD	9.37	± 9.6 %
10966	AAB	5G NR DL (CP-OFDM, TM 3.1, 15 MHz, 64-QAM, 30 kHz)	5G NR FR1 TDD	9.55	± 9.6 %
10967	AAB	5G NR DL (CP-OFDM, TM 3.1, 20 MHz, 64-QAM, 30 kHz)	5G NR FR1 TDD	9.42	± 9.6 %
10968	AAB	5G NR DL (CP-OFDM, TM 3.1, 100 MHz, 64-QAM, 30 kHz)	5G NR FR1 TDD	9.49	± 9.6 %
10972	AAB	5G NR (CP-OFDM, 1 RB, 20 MHz, QPSK, 15 kHz)	5G NR FR1 TDD	11.59	± 9.6 %
10973	AAB	5G NR (DFT-s-OFDM, 1 RB, 100 MHz, QPSK, 30 kHz)	5G NR FR1 TDD	9.06	± 9.6 %
10974	AAB	5G NR (CP-OFDM, 100% RB, 100 MHz, 256-QAM, 30 kHz)	5G NR FR1 TDD	10.28	± 9.6 %

^E Uncertainty is determined using the max. deviation from linear response applying rectangular distribution and is expressed for the square of the field value.

**Calibration Laboratory of
Schmid & Partner
Engineering AG**
Zeughausstrasse 43, 8004 Zurich, Switzerland



S Schweizerischer Kalibrierdienst
C Service suisse d'étalonnage
S Servizio svizzero di taratura
S Swiss Calibration Service

Accredited by the Swiss Accreditation Service (SAS)
The Swiss Accreditation Service is one of the signatories to the EA
Multilateral Agreement for the recognition of calibration certificates

Accreditation No.: **SCS 0108**

Client **B.V. ADT (Auden)**

Certificate No: **EUmmWV4-9438_Jul21**

CALIBRATION CERTIFICATE

Object **EUmmWV4 - SN:9438**

Calibration procedure(s) **QA CAL-02.v9, QA CAL-25.v7, QA CAL-42.v2
Calibration procedure for E-field probes optimized for close near field
evaluations in air**

Calibration date: **July 26, 2021**

This calibration certificate documents the traceability to national standards, which realize the physical units of measurements (SI).
The measurements and the uncertainties with confidence probability are given on the following pages and are part of the certificate.

All calibrations have been conducted in the closed laboratory facility: environment temperature (22 ± 3)°C and humidity < 70%.

Calibration Equipment used (M&TE critical for calibration)

Primary Standards	ID	Cal Date (Certificate No.)	Scheduled Calibration
Power meter NRP	SN: 104778	09-Apr-21 (No. 217-03291/0292)	Apr-22
Power sensor NRP-Z91	SN: 103244	09-Apr-21 (No. 217-03291)	Apr-22
Power sensor NRP-Z91	SN: 103245	09-Apr-21 (No. 217-03292)	Apr-22
Reference 20 dB Attenuator	SN: CC2552 (20x)	09-Apr-21 (No. 217-03343)	Apr-22
Reference Probe ER3DV6	SN: 2328	05-Oct-20 (No. ER3-2328_Oct20)	Oct-21
DAE4	SN: 789	23-Dec-20 (No. DAE4-789_Dec20)	Dec-21
Secondary Standards	ID	Check Date (in house)	Scheduled Check
Power meter E4419B	SN: GB41293874	06-Apr-16 (in house check Jun-20)	In house check: Jun-22
Power sensor E4412A	SN: MY41498087	06-Apr-16 (in house check Jun-20)	In house check: Jun-22
Power sensor E4412A	SN: 000110210	06-Apr-16 (in house check Jun-20)	In house check: Jun-22
RF generator HP 8648C	SN: US3642U01700	04-Aug-99 (in house check Jun-20)	In house check: Jun-22
Network Analyzer E8358A	SN: US41080477	31-Mar-14 (in house check Oct-20)	In house check: Oct-21

	Name	Function	Signature
Calibrated by:	Leif Klynsner	Laboratory Technician	
Approved by:	Katja Pokovic	Technical Manager	

Issued: July 31, 2021

This calibration certificate shall not be reproduced except in full without written approval of the laboratory.



Accredited by the Swiss Accreditation Service (SAS)
The Swiss Accreditation Service is one of the signatories to the EA
Multilateral Agreement for the recognition of calibration certificates

Accreditation No.: **SCS 0108**

Glossary:

NORM _{x,y,z}	sensitivity in free space
DCP	diode compression point
CF	crest factor (1/duty_cycle) of the RF signal
A, B, C, D	modulation dependent linearization parameters
Polarization φ	φ rotation around probe axis
Polarization ϑ	ϑ rotation around an axis that is in the plane normal to probe axis (at measurement center), i.e., $\vartheta = 0$ is normal to probe axis
Connector Angle	information used in DASY system to align probe sensor X to the robot coordinate system
Sensor Angles	sensor deviation from the probe axis, used to calculate the field orientation and polarization
k	is the wave propagation direction

Calibration is Performed According to the Following Standards:

- a) IEEE Std 1309-2005, "IEEE Standard for calibration of electromagnetic field sensors and probes, excluding antennas, from 9 kHz to 40 GHz", December 2005

Methods Applied and Interpretation of Parameters:

- *NORM_{x,y,z}*: Assessed for E-field polarization $\vartheta = 0$ for XY sensors and $\vartheta = 90$ for Z sensor ($f \leq 900$ MHz in TEM-cell; $f > 1800$ MHz: R22 waveguide). For frequencies > 6 GHz, the far field in front of waveguide horn antennas is measured for a set of frequencies in various waveguide bands up to 110 GHz.
- *DCP_{x,y,z}*: DCP are numerical linearization parameters assessed based on the data of power sweep with CW signal (no uncertainty required). DCP does not depend on frequency nor media.
- *PAR*: PAR is the Peak to Average Ratio that is not calibrated but determined based on the signal characteristics
- The frequency sensor model parameters are determined prior to calibration based on a frequency sweep (sensor model involving resistors R, R_p , inductance L and capacitors C, C_p).
- *A_{x,y,z}; B_{x,y,z}; C_{x,y,z}; D_{x,y,z}; VR_{x,y,z}*: *A, B, C, D* are numerical linearization parameters assessed based on the data of power sweep for specific modulation signal. The parameters do not depend on frequency nor media. *VR* is the maximum calibration range expressed in RMS voltage across the diode.
- *Sensor Offset*: The sensor offset corresponds to the mechanical from the probe tip (on probe axis). No tolerance required.
- *Connector Angle*: The angle is assessed using the information gained by determining the *NORM_x* (no uncertainty required).
- *Equivalent Sensor Angle*: The two probe sensors are mounted in the same plane at different angles. The angles are assessed using the information gained by determining the *NORM_x* (no uncertainty required).
- *Spherical isotropy (3D deviation from isotropy)*: in a locally homogeneous field realized using an open waveguide / horn setup.

DASY - Parameters of Probe: EUmmWV4 - SN:9438

Basic Calibration Parameters

	Sensor X	Sensor Y	Unc (k=2)
Norm ($\mu V/(V/m)^2$)	0.02005	0.02059	$\pm 10.1 \%$
DCP (mV) ^b	108.0	106.0	
Equivalent Sensor Angle	-61.5	33.5	

Calibration results for Frequency Response (750 MHz – 110 GHz)

Frequency GHz	Target E-Field V/m	Deviation Sensor X dB	Deviation Sensor Y dB	Unc (k=2) dB
0.75	77.2	-0.25	-0.12	± 0.43 dB
1.8	140.4	0.07	0.07	± 0.43 dB
2	133.0	0.00	0.07	± 0.43 dB
2.2	124.8	0.07	0.07	± 0.43 dB
2.5	123.0	-0.03	-0.03	± 0.43 dB
3.5	256.2	0.17	0.11	± 0.43 dB
3.7	249.8	0.17	0.04	± 0.43 dB
6.6	41.8	0.51	0.17	± 0.98 dB
8	48.4	0.08	-0.25	± 0.98 dB
10	54.4	-0.05	0.03	± 0.98 dB
15	71.5	0.02	-0.30	± 0.98 dB
18	85.3	0.05	0.18	± 0.98 dB
26.6	96.9	-0.05	-0.05	± 0.98 dB
30	92.6	0.01	0.01	± 0.98 dB
35	93.7	0.02	0.06	± 0.98 dB
40	91.5	-0.01	-0.05	± 0.98 dB
50	19.6	-0.05	-0.03	± 0.98 dB
55	22.4	0.64	0.43	± 0.98 dB
60	23.0	-0.02	-0.01	± 0.98 dB
65	27.4	-0.29	-0.15	± 0.98 dB
70	23.9	-0.08	-0.30	± 0.98 dB
75	20.0	-0.24	-0.05	± 0.98 dB
75	14.8	-0.09	-0.09	± 0.98 dB
80	22.5	0.15	0.24	± 0.98 dB
85	22.8	0.15	0.01	± 0.98 dB
90	23.8	0.08	0.07	± 0.98 dB
92	23.9	-0.10	-0.19	± 0.98 dB
95	20.5	-0.36	-0.25	± 0.98 dB
97	24.4	-0.18	-0.19	± 0.98 dB
100	22.6	-0.19	-0.12	± 0.98 dB
105	22.7	0.06	0.10	± 0.98 dB
110	19.7	0.38	0.22	± 0.98 dB

The reported uncertainty of measurement is stated as the standard uncertainty of measurement multiplied by the coverage factor k=2, which for a normal distribution corresponds to a coverage probability of approximately 95%.

^b Numerical linearization parameter: uncertainty not required.

^c Uncertainty is determined using the max. deviation from linear response applying rectangular distribution and is expressed for the square of the field value.

DASY - Parameters of Probe: EUmmWV4 - SN:9438

Calibration Results for Modulation Response

UID	Communication System Name		A dB	B dB $\sqrt{\mu\text{V}}$	C	D dB	VR mV	Max dev.	Max Unc ^E (k=2)
0	CW	X	0.00	0.00	1.00	0.00	145.3	± 3.5 %	± 4.7 %
		Y	0.00	0.00	1.00		66.3		
10352-AAA	Pulse Waveform (200Hz, 10%)	X	3.45	60.00	14.63	10.00	6.0	± 1.4 %	± 9.6 %
		Y	2.95	60.00	14.91		6.0		
10353-AAA	Pulse Waveform (200Hz, 20%)	X	2.39	60.00	13.45	6.99	12.0	± 0.9 %	± 9.6 %
		Y	2.02	60.00	13.82		12.0		
10354-AAA	Pulse Waveform (200Hz, 40%)	X	1.42	60.00	12.19	3.98	23.0	± 1.5 %	± 9.6 %
		Y	1.19	60.00	12.66		23.0		
10355-AAA	Pulse Waveform (200Hz, 60%)	X	0.83	60.00	11.55	2.22	27.0	± 0.9 %	± 9.6 %
		Y	0.71	60.00	12.02		27.0		
10387-AAA	QPSK Waveform, 1 MHz	X	1.29	60.00	12.60	1.00	22.0	± 1.1 %	± 9.6 %
		Y	1.22	60.00	12.53		22.0		
10388-AAA	QPSK Waveform, 10 MHz	X	1.26	60.00	12.18	0.00	22.0	± 0.7 %	± 9.6 %
		Y	1.25	60.00	12.25		22.0		
10396-AAA	64-QAM Waveform, 100 kHz	X	4.35	68.45	17.20	3.01	17.0	± 0.6 %	± 9.6 %
		Y	3.11	64.06	15.37		17.0		
10399-AAA	64-QAM Waveform, 40 MHz	X	2.05	60.00	12.61	0.00	19.0	± 0.8 %	± 9.6 %
		Y	2.03	60.00	12.69		19.0		
10414-AAA	WLAN CCDF, 64-QAM, 40MHz	X	3.21	60.00	13.00	0.00	12.0	± 1.0 %	± 9.6 %
		Y	3.13	60.00	13.09		12.0		

Note: For details on all calibrated UID parameters see Appendix

Calibration Results for Linearity Response

Frequency GHz	Target E-Field V/m	Deviation Sensor X dB	Deviation Sensor Y dB	Unc (k=2) dB
0.9	50.0	-0.14	-0.13	± 0.2 dB
0.9	100.0	-0.11	-0.03	± 0.2 dB
0.9	500.0	0.04	-0.01	± 0.2 dB
0.9	1000.0	0.06	0.02	± 0.2 dB
0.9	1500.0	0.03	0.01	± 0.2 dB
0.9	2000.0	0.01	-0.01	± 0.2 dB

Sensor Frequency Model Parameters (750 MHz – 55 GHz)

	Sensor X	Sensor Y
R (Ω)	72.34	74.58
R _p (Ω)	96.70	94.91
L (nH)	0.10898	0.10011
C (pF)	0.2116	0.2774
C _p (pF)	0.0575	0.0740

Sensor Frequency Model Parameters (55 GHz – 110 GHz)

	Sensor X	Sensor Y
R (Ω)	27.79	33.18
R _p (Ω)	97.44	95.50
L (nH)	0.04344	0.03637
C (pF)	0.1240	0.1919
C _p (pF)	0.1154	0.1209

DASY - Parameters of Probe: EUmmWV4 - SN:9438

Sensor Model Parameters

	C1 fF	C2 fF	α V ⁻¹	T1 ms.V ⁻²	T2 ms.V ⁻¹	T3 ms	T4 V ⁻²	T5 V ⁻¹	T6
X	71.1	513.63	33.50	0.92	9.59	4.96	0.00	2.00	1.01
Y	58.5	422.19	33.44	0.92	7.98	4.99	0.00	2.00	1.01

Other Probe Parameters

Sensor Arrangement	Rectangular
Connector Angle (°)	-134.2
Mechanical Surface Detection Mode	enabled
Optical Surface Detection Mode	disabled
Probe Overall Length	320 mm
Probe Body Diameter	8 mm
Tip Length	23 mm
Tip Diameter	8.0 mm
Probe Tip to Sensor X Calibration Point	1.5 mm
Probe Tip to Sensor Y Calibration Point	1.5 mm

Deviation from Isotropy in Air f = 30, 60 GHz

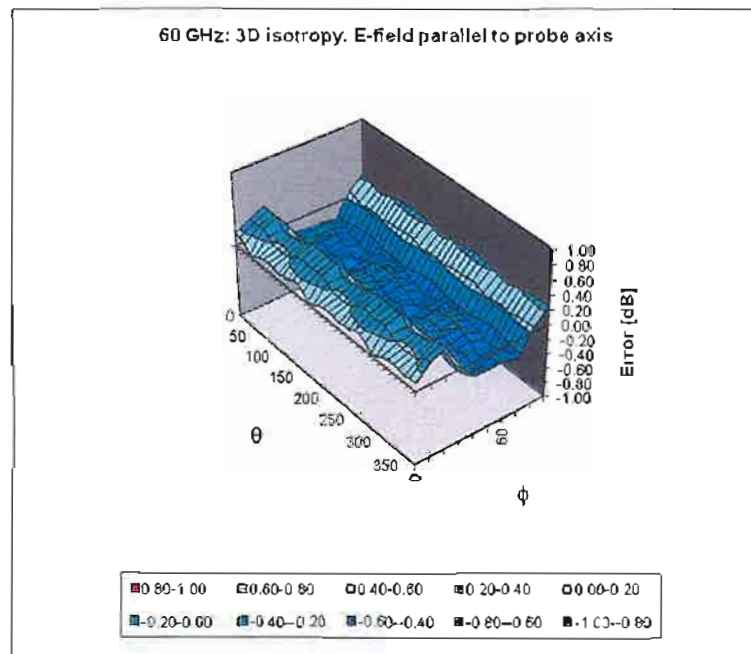
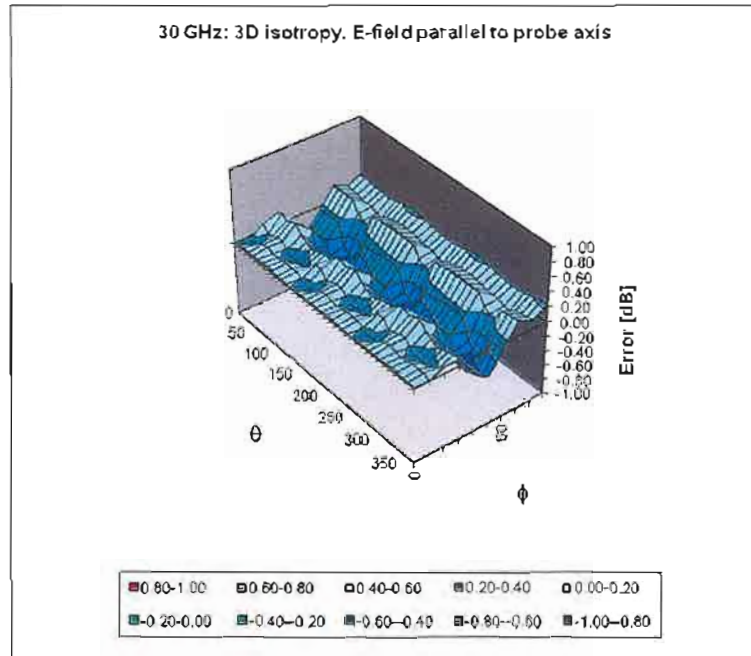

Probe isotropy for E_{tot} : probe rotated $\phi = 0^\circ$ to 360° , tilted from field propagation direction \vec{k}
 Parallel to the field propagation ($\psi = 0^\circ - 90^\circ$) at 30 GHz: deviation within ± 0.38 dB
 Parallel to the field propagation ($\psi = 0^\circ - 90^\circ$) at 60 GHz: deviation within ± 0.40 dB

Appendix: Modulation Calibration Parameters

UID	Rev	Communication System Name	Group	PAR (dB)	Unc ^E (k=2)
0		CW	CW	0.00	± 4.7 %
10010	CAA	SAR Validation (Square, 100ms, 10ms)	Test	10.00	± 9.6 %
10011	CAB	UMTS-FDD (WCDMA)	WCDMA	2.91	± 9.6 %
10012	CAB	IEEE 802.11b WiFi 2.4 GHz (DSSS, 1 Mbps)	WLAN	1.87	± 9.6 %
10013	CAB	IEEE 802.11g WiFi 2.4 GHz (DSSS-OFDM, 6 Mbps)	WLAN	9.46	± 9.6 %
10021	DAC	GSM-FDD (TDMA, GMSK)	GSM	9.39	± 9.6 %
10023	DAC	GPRS-FDD (TDMA, GMSK, TN 0)	GSM	9.57	± 9.6 %
10024	DAC	GPRS-FDD (TDMA, GMSK, TN 0-1)	GSM	6.56	± 9.6 %
10025	DAC	EDGE-FDD (TDMA, 8PSK, TN 0)	GSM	12.62	± 9.6 %
10026	DAC	EDGE-FDD (TDMA, 8PSK, TN 0-1)	GSM	9.55	± 9.6 %
10027	DAC	GPRS-FDD (TDMA, GMSK, TN 0-1-2)	GSM	4.80	± 9.6 %
10028	DAC	GPRS-FDD (TDMA, GMSK, TN 0-1-2-3)	GSM	3.55	± 9.6 %
10029	DAC	EDGE-FDD (TDMA, 8PSK, TN 0-1-2)	GSM	7.78	± 9.6 %
10030	CAA	IEEE 802.15.1 Bluetooth (GFSK, DH1)	Bluetooth	5.30	± 9.6 %
10031	CAA	IEEE 802.15.1 Bluetooth (GFSK, DH3)	Bluetooth	1.87	± 9.6 %
10032	CAA	IEEE 802.15.1 Bluetooth (GFSK, DH5)	Bluetooth	1.16	± 9.6 %
10033	CAA	IEEE 802.15.1 Bluetooth (PI/4-DQPSK, DH1)	Bluetooth	7.74	± 9.6 %
10034	CAA	IEEE 802.15.1 Bluetooth (PI/4-DQPSK, DH3)	Bluetooth	4.53	± 9.6 %
10035	CAA	IEEE 802.15.1 Bluetooth (PI/4-DQPSK, DH5)	Bluetooth	3.83	± 9.6 %
10036	CAA	IEEE 802.15.1 Bluetooth (8-DPSK, DH1)	Bluetooth	8.01	± 9.6 %
10037	CAA	IEEE 802.15.1 Bluetooth (8-DPSK, DH3)	Bluetooth	4.77	± 9.6 %
10038	CAA	IEEE 802.15.1 Bluetooth (8-DPSK, DH5)	Bluetooth	4.10	± 9.6 %
10039	CAB	CDMA2000 (1xRTT, RC1)	CDMA2000	4.57	± 9.6 %
10042	CAB	IS-54 / IS-136 FDD (TDMA/FDM, PI/4-DQPSK, Halfrate)	AMPS	7.78	± 9.6 %
10044	CAA	IS-91/EIA/TIA-553 FDD (FDMA, FM)	AMPS	0.00	± 9.6 %
10048	CAA	DECT (TDD, TDMA/FDM, GFSK, Full Slot, 24)	DECT	13.80	± 9.6 %
10049	CAA	DECT (TDD, TDMA/FDM, GFSK, Double Slot, 12)	DECT	10.79	± 9.6 %
10056	CAA	UMTS-TDD (TD-SCDMA, 1.28 Mcps)	TD-SCDMA	11.01	± 9.6 %
10058	DAC	EDGE-FDD (TDMA, 8PSK, TN 0-1-2-3)	GSM	6.52	± 9.6 %
10059	CAB	IEEE 802.11b WiFi 2.4 GHz (DSSS, 2 Mbps)	WLAN	2.12	± 9.6 %
10060	CAB	IEEE 802.11b WiFi 2.4 GHz (DSSS, 5.5 Mbps)	WLAN	2.83	± 9.6 %
10061	CAB	IEEE 802.11b WiFi 2.4 GHz (DSSS, 11 Mbps)	WLAN	3.60	± 9.6 %
10062	CAD	IEEE 802.11a/h WiFi 5 GHz (OFDM, 6 Mbps)	WLAN	8.68	± 9.6 %
10063	CAD	IEEE 802.11a/h WiFi 5 GHz (OFDM, 9 Mbps)	WLAN	8.63	± 9.6 %
10064	CAD	IEEE 802.11a/h WiFi 5 GHz (OFDM, 12 Mbps)	WLAN	9.09	± 9.6 %
10065	CAD	IEEE 802.11a/h WiFi 5 GHz (OFDM, 18 Mbps)	WLAN	9.00	± 9.6 %
10066	CAD	IEEE 802.11a/h WiFi 5 GHz (OFDM, 24 Mbps)	WLAN	9.38	± 9.6 %
10067	CAD	IEEE 802.11a/h WiFi 5 GHz (OFDM, 36 Mbps)	WLAN	10.12	± 9.6 %
10068	CAD	IEEE 802.11a/h WiFi 5 GHz (OFDM, 48 Mbps)	WLAN	10.24	± 9.6 %
10069	CAD	IEEE 802.11a/h WiFi 5 GHz (OFDM, 54 Mbps)	WLAN	10.56	± 9.6 %
10071	CAB	IEEE 802.11g WiFi 2.4 GHz (DSSS/OFDM, 9 Mbps)	WLAN	9.83	± 9.6 %
10072	CAB	IEEE 802.11g WiFi 2.4 GHz (DSSS/OFDM, 12 Mbps)	WLAN	9.62	± 9.6 %
10073	CAB	IEEE 802.11g WiFi 2.4 GHz (DSSS/OFDM, 18 Mbps)	WLAN	9.94	± 9.6 %
10074	CAB	IEEE 802.11g WiFi 2.4 GHz (DSSS/OFDM, 24 Mbps)	WLAN	10.30	± 9.6 %
10075	CAB	IEEE 802.11g WiFi 2.4 GHz (DSSS/OFDM, 36 Mbps)	WLAN	10.77	± 9.6 %
10076	CAB	IEEE 802.11g WiFi 2.4 GHz (DSSS/OFDM, 48 Mbps)	WLAN	10.94	± 9.6 %
10077	CAB	IEEE 802.11g WiFi 2.4 GHz (DSSS/OFDM, 54 Mbps)	WLAN	11.00	± 9.6 %
10081	CAB	CDMA2000 (1xRTT, RC3)	CDMA2000	3.97	± 9.6 %
10082	CAB	IS-54 / IS-136 FDD (TDMA/FDM, PI/4-DQPSK, Fullrate)	AMPS	4.77	± 9.6 %
10090	DAC	GPRS-FDD (TDMA, GMSK, TN 0-4)	GSM	6.56	± 9.6 %
10097	CAC	UMTS-FDD (HSDPA)	WCDMA	3.98	± 9.6 %
10098	DAC	UMTS-FDD (HSUPA, Subtest 2)	WCDMA	3.98	± 9.6 %

10099	CAC	EDGE-FDD (TDMA, 8PSK, TN 0-4)	GSM	9.55	± 9.6 %
10100	CAC	LTE-FDD (SC-FDMA, 100% RB, 20 MHz, QPSK)	LTE-FDD	5.67	± 9.6 %
10101	CAB	LTE-FDD (SC-FDMA, 100% RB, 20 MHz, 16-QAM)	LTE-FDD	6.42	± 9.6 %
10102	CAB	LTE-FDD (SC-FDMA, 100% RB, 20 MHz, 64-QAM)	LTE-FDD	6.60	± 9.6 %
10103	DAC	LTE-TDD (SC-FDMA, 100% RB, 20 MHz, QPSK)	LTE-TDD	9.29	± 9.6 %
10104	CAE	LTE-TDD (SC-FDMA, 100% RB, 20 MHz, 16-QAM)	LTE-TDD	9.97	± 9.6 %
10105	CAE	LTE-TDD (SC-FDMA, 100% RB, 20 MHz, 64-QAM)	LTE-TDD	10.01	± 9.6 %
10108	CAE	LTE-FDD (SC-FDMA, 100% RB, 10 MHz, QPSK)	LTE-FDD	5.80	± 9.6 %
10109	CAG	LTE-FDD (SC-FDMA, 100% RB, 10 MHz, 16-QAM)	LTE-FDD	6.43	± 9.6 %
10110	CAG	LTE-FDD (SC-FDMA, 100% RB, 5 MHz, QPSK)	LTE-FDD	5.75	± 9.6 %
10111	CAG	LTE-FDD (SC-FDMA, 100% RB, 5 MHz, 16-QAM)	LTE-FDD	6.44	± 9.6 %
10112	CAG	LTE-FDD (SC-FDMA, 100% RB, 10 MHz, 64-QAM)	LTE-FDD	6.59	± 9.6 %
10113	CAG	LTE-FDD (SC-FDMA, 100% RB, 5 MHz, 64-QAM)	LTE-FDD	6.62	± 9.6 %
10114	CAG	IEEE 802.11n (HT Greenfield, 13.5 Mbps, BPSK)	WLAN	8.10	± 9.6 %
10115	CAG	IEEE 802.11n (HT Greenfield, 81 Mbps, 16-QAM)	WLAN	8.46	± 9.6 %
10116	CAG	IEEE 802.11n (HT Greenfield, 135 Mbps, 64-QAM)	WLAN	8.15	± 9.6 %
10117	CAG	IEEE 802.11n (HT Mixed, 13.5 Mbps, BPSK)	WLAN	8.07	± 9.6 %
10118	CAD	IEEE 802.11n (HT Mixed, 81 Mbps, 16-QAM)	WLAN	8.59	± 9.6 %
10119	CAD	IEEE 802.11n (HT Mixed, 135 Mbps, 64-QAM)	WLAN	8.13	± 9.6 %
10140	CAD	LTE-FDD (SC-FDMA, 100% RB, 15 MHz, 16-QAM)	LTE-FDD	6.49	± 9.6 %
10141	CAD	LTE-FDD (SC-FDMA, 100% RB, 15 MHz, 64-QAM)	LTE-FDD	6.53	± 9.6 %
10142	CAD	LTE-FDD (SC-FDMA, 100% RB, 3 MHz, QPSK)	LTE-FDD	5.73	± 9.6 %
10143	CAD	LTE-FDD (SC-FDMA, 100% RB, 3 MHz, 16-QAM)	LTE-FDD	6.35	± 9.6 %
10144	CAC	LTE-FDD (SC-FDMA, 100% RB, 3 MHz, 64-QAM)	LTE-FDD	6.65	± 9.6 %
10145	CAC	LTE-FDD (SC-FDMA, 100% RB, 1.4 MHz, QPSK)	LTE-FDD	5.76	± 9.6 %
10146	CAC	LTE-FDD (SC-FDMA, 100% RB, 1.4 MHz, 16-QAM)	LTE-FDD	6.41	± 9.6 %
10147	CAC	LTE-FDD (SC-FDMA, 100% RB, 1.4 MHz, 64-QAM)	LTE-FDD	6.72	± 9.6 %
10149	CAE	LTE-FDD (SC-FDMA, 50% RB, 20 MHz, 16-QAM)	LTE-FDD	6.42	± 9.6 %
10150	CAE	LTE-FDD (SC-FDMA, 50% RB, 20 MHz, 64-QAM)	LTE-FDD	6.60	± 9.6 %
10151	CAE	LTE-TDD (SC-FDMA, 50% RB, 20 MHz, QPSK)	LTE-TDD	9.28	± 9.6 %
10152	CAE	LTE-TDD (SC-FDMA, 50% RB, 20 MHz, 16-QAM)	LTE-TDD	9.92	± 9.6 %
10153	CAE	LTE-TDD (SC-FDMA, 50% RB, 20 MHz, 64-QAM)	LTE-TDD	10.05	± 9.6 %
10154	CAF	LTE-FDD (SC-FDMA, 50% RB, 10 MHz, QPSK)	LTE-FDD	5.75	± 9.6 %
10155	CAF	LTE-FDD (SC-FDMA, 50% RB, 10 MHz, 16-QAM)	LTE-FDD	6.43	± 9.6 %
10156	CAF	LTE-FDD (SC-FDMA, 50% RB, 5 MHz, QPSK)	LTE-FDD	5.79	± 9.6 %
10157	CAE	LTE-FDD (SC-FDMA, 50% RB, 5 MHz, 16-QAM)	LTE-FDD	6.49	± 9.6 %
10158	CAE	LTE-FDD (SC-FDMA, 50% RB, 10 MHz, 64-QAM)	LTE-FDD	6.62	± 9.6 %
10159	CAG	LTE-FDD (SC-FDMA, 50% RB, 5 MHz, 64-QAM)	LTE-FDD	6.56	± 9.6 %
10160	CAG	LTE-FDD (SC-FDMA, 50% RB, 15 MHz, QPSK)	LTE-FDD	5.82	± 9.6 %
10161	CAG	LTE-FDD (SC-FDMA, 50% RB, 15 MHz, 16-QAM)	LTE-FDD	6.43	± 9.6 %
10162	CAG	LTE-FDD (SC-FDMA, 50% RB, 15 MHz, 64-QAM)	LTE-FDD	6.58	± 9.6 %
10166	CAG	LTE-FDD (SC-FDMA, 50% RB, 1.4 MHz, QPSK)	LTE-FDD	5.46	± 9.6 %
10167	CAG	LTE-FDD (SC-FDMA, 50% RB, 1.4 MHz, 16-QAM)	LTE-FDD	6.21	± 9.6 %
10168	CAG	LTE-FDD (SC-FDMA, 50% RB, 1.4 MHz, 64-QAM)	LTE-FDD	6.79	± 9.6 %
10169	CAG	LTE-FDD (SC-FDMA, 1 RB, 20 MHz, QPSK)	LTE-FDD	5.73	± 9.6 %
10170	CAG	LTE-FDD (SC-FDMA, 1 RB, 20 MHz, 16-QAM)	LTE-FDD	6.52	± 9.6 %
10171	CAE	LTE-FDD (SC-FDMA, 1 RB, 20 MHz, 64-QAM)	LTE-FDD	6.49	± 9.6 %
10172	CAE	LTE-TDD (SC-FDMA, 1 RB, 20 MHz, QPSK)	LTE-TDD	9.21	± 9.6 %
10173	CAE	LTE-TDD (SC-FDMA, 1 RB, 20 MHz, 16-QAM)	LTE-TDD	9.48	± 9.6 %
10174	CAF	LTE-TDD (SC-FDMA, 1 RB, 20 MHz, 64-QAM)	LTE-TDD	10.25	± 9.6 %
10175	CAF	LTE-FDD (SC-FDMA, 1 RB, 10 MHz, QPSK)	LTE-FDD	5.72	± 9.6 %
10176	CAF	LTE-FDD (SC-FDMA, 1 RB, 10 MHz, 16-QAM)	LTE-FDD	6.52	± 9.6 %
10177	CAE	LTE-FDD (SC-FDMA, 1 RB, 5 MHz, QPSK)	LTE-FDD	5.73	± 9.6 %
10178	CAE	LTE-FDD (SC-FDMA, 1 RB, 5 MHz, 16-QAM)	LTE-FDD	6.52	± 9.6 %
10179	AAE	LTE-FDD (SC-FDMA, 1 RB, 10 MHz, 64-QAM)	LTE-FDD	6.50	± 9.6 %
10180	CAG	LTE-FDD (SC-FDMA, 1 RB, 5 MHz, 64-QAM)	LTE-FDD	6.50	± 9.6 %

10181	CAG	LTE-FDD (SC-FDMA, 1 RB, 15 MHz, QPSK)	LTE-FDD	5.72	± 9.6 %
10182	CAG	LTE-FDD (SC-FDMA, 1 RB, 15 MHz, 16-QAM)	LTE-FDD	6.52	± 9.6 %
10183	CAG	LTE-FDD (SC-FDMA, 1 RB, 15 MHz, 64-QAM)	LTE-FDD	6.50	± 9.6 %
10184	CAG	LTE-FDD (SC-FDMA, 1 RB, 3 MHz, QPSK)	LTE-FDD	5.73	± 9.6 %
10185	CAI	LTE-FDD (SC-FDMA, 1 RB, 3 MHz, 16-QAM)	LTE-FDD	6.51	± 9.6 %
10186	CAG	LTE-FDD (SC-FDMA, 1 RB, 3 MHz, 64-QAM)	LTE-FDD	6.50	± 9.6 %
10187	CAG	LTE-FDD (SC-FDMA, 1 RB, 1.4 MHz, QPSK)	LTE-FDD	5.73	± 9.6 %
10188	CAG	LTE-FDD (SC-FDMA, 1 RB, 1.4 MHz, 16-QAM)	LTE-FDD	6.52	± 9.6 %
10189	CAE	LTE-FDD (SC-FDMA, 1 RB, 1.4 MHz, 64-QAM)	LTE-FDD	6.50	± 9.6 %
10193	CAE	IEEE 802.11n (HT Greenfield, 6.5 Mbps, BPSK)	WLAN	8.09	± 9.6 %
10194	AAD	IEEE 802.11n (HT Greenfield, 39 Mbps, 16-QAM)	WLAN	8.12	± 9.6 %
10195	CAE	IEEE 802.11n (HT Greenfield, 65 Mbps, 64-QAM)	WLAN	8.21	± 9.6 %
10196	CAE	IEEE 802.11n (HT Mixed, 6.5 Mbps, BPSK)	WLAN	8.10	± 9.6 %
10197	AAE	IEEE 802.11n (HT Mixed, 39 Mbps, 16-QAM)	WLAN	8.13	± 9.6 %
10198	CAF	IEEE 802.11n (HT Mixed, 65 Mbps, 64-QAM)	WLAN	8.27	± 9.6 %
10219	CAF	IEEE 802.11n (HT Mixed, 7.2 Mbps, BPSK)	WLAN	8.03	± 9.6 %
10220	AAF	IEEE 802.11n (HT Mixed, 43.3 Mbps, 16-QAM)	WLAN	8.13	± 9.6 %
10221	CAC	IEEE 802.11n (HT Mixed, 72.2 Mbps, 64-QAM)	WLAN	8.27	± 9.6 %
10222	CAC	IEEE 802.11n (HT Mixed, 15 Mbps, BPSK)	WLAN	8.06	± 9.6 %
10223	CAD	IEEE 802.11n (HT Mixed, 90 Mbps, 16-QAM)	WLAN	8.48	± 9.6 %
10224	CAD	IEEE 802.11n (HT Mixed, 150 Mbps, 64-QAM)	WLAN	8.08	± 9.6 %
10225	CAD	UMTS-FDD (HSPA+)	WCDMA	5.97	± 9.6 %
10226	CAD	LTE-TDD (SC-FDMA, 1 RB, 1.4 MHz, 16-QAM)	LTE-TDD	9.49	± 9.6 %
10227	CAD	LTE-TDD (SC-FDMA, 1 RB, 1.4 MHz, 64-QAM)	LTE-TDD	10.26	± 9.6 %
10228	CAD	LTE-TDD (SC-FDMA, 1 RB, 1.4 MHz, QPSK)	LTE-TDD	9.22	± 9.6 %
10229	DAC	LTE-TDD (SC-FDMA, 1 RB, 3 MHz, 16-QAM)	LTE-TDD	9.48	± 9.6 %
10230	CAC	LTE-TDD (SC-FDMA, 1 RB, 3 MHz, 64-QAM)	LTE-TDD	10.25	± 9.6 %
10231	CAC	LTE-TDD (SC-FDMA, 1 RB, 3 MHz, QPSK)	LTE-TDD	9.19	± 9.6 %
10232	CAD	LTE-TDD (SC-FDMA, 1 RB, 5 MHz, 16-QAM)	LTE-TDD	9.48	± 9.6 %
10233	CAD	LTE-TDD (SC-FDMA, 1 RB, 5 MHz, 64-QAM)	LTE-TDD	10.25	± 9.6 %
10234	CAD	LTE-TDD (SC-FDMA, 1 RB, 5 MHz, QPSK)	LTE-TDD	9.21	± 9.6 %
10235	CAD	LTE-TDD (SC-FDMA, 1 RB, 10 MHz, 16-QAM)	LTE-TDD	9.48	± 9.6 %
10236	CAD	LTE-TDD (SC-FDMA, 1 RB, 10 MHz, 64-QAM)	LTE-TDD	10.25	± 9.6 %
10237	CAD	LTE-TDD (SC-FDMA, 1 RB, 10 MHz, QPSK)	LTE-TDD	9.21	± 9.6 %
10238	CAB	LTE-TDD (SC-FDMA, 1 RB, 15 MHz, 16-QAM)	LTE-TDD	9.48	± 9.6 %
10239	CAB	LTE-TDD (SC-FDMA, 1 RB, 15 MHz, 64-QAM)	LTE-TDD	10.25	± 9.6 %
10240	CAB	LTE-TDD (SC-FDMA, 1 RB, 15 MHz, QPSK)	LTE-TDD	9.21	± 9.6 %
10241	CAB	LTE-TDD (SC-FDMA, 50% RB, 1.4 MHz, 16-QAM)	LTE-TDD	9.82	± 9.6 %
10242	CAD	LTE-TDD (SC-FDMA, 50% RB, 1.4 MHz, 64-QAM)	LTE-TDD	9.86	± 9.6 %
10243	CAD	LTE-TDD (SC-FDMA, 50% RB, 1.4 MHz, QPSK)	LTE-TDD	9.46	± 9.6 %
10244	CAD	LTE-TDD (SC-FDMA, 50% RB, 3 MHz, 16-QAM)	LTE-TDD	10.06	± 9.6 %
10245	CAG	LTE-TDD (SC-FDMA, 50% RB, 3 MHz, 64-QAM)	LTE-TDD	10.06	± 9.6 %
10246	CAG	LTE-TDD (SC-FDMA, 50% RB, 3 MHz, QPSK)	LTE-TDD	9.30	± 9.6 %
10247	CAG	LTE-TDD (SC-FDMA, 50% RB, 5 MHz, 16-QAM)	LTE-TDD	9.91	± 9.6 %
10248	CAG	LTE-TDD (SC-FDMA, 50% RB, 5 MHz, 64-QAM)	LTE-TDD	10.09	± 9.6 %
10249	CAG	LTE-TDD (SC-FDMA, 50% RB, 5 MHz, QPSK)	LTE-TDD	9.29	± 9.6 %
10250	CAG	LTE-TDD (SC-FDMA, 50% RB, 10 MHz, 16-QAM)	LTE-TDD	9.81	± 9.6 %
10251	CAF	LTE-TDD (SC-FDMA, 50% RB, 10 MHz, 64-QAM)	LTE-TDD	10.17	± 9.6 %
10252	CAF	LTE-TDD (SC-FDMA, 50% RB, 10 MHz, QPSK)	LTE-TDD	9.24	± 9.6 %
10253	CAF	LTE-TDD (SC-FDMA, 50% RB, 15 MHz, 16-QAM)	LTE-TDD	9.90	± 9.6 %
10254	CAB	LTE-TDD (SC-FDMA, 50% RB, 15 MHz, 64-QAM)	LTE-TDD	10.14	± 9.6 %
10255	CAB	LTE-TDD (SC-FDMA, 50% RB, 15 MHz, QPSK)	LTE-TDD	9.20	± 9.6 %
10256	CAB	LTE-TDD (SC-FDMA, 100% RB, 1.4 MHz, 16-QAM)	LTE-TDD	9.96	± 9.6 %
10257	CAD	LTE-TDD (SC-FDMA, 100% RB, 1.4 MHz, 64-QAM)	LTE-TDD	10.08	± 9.6 %
10258	CAD	LTE-TDD (SC-FDMA, 100% RB, 1.4 MHz, QPSK)	LTE-TDD	9.34	± 9.6 %
10259	CAD	LTE-TDD (SC-FDMA, 100% RB, 3 MHz, 16-QAM)	LTE-TDD	9.98	± 9.6 %

10260	CAG	LTE-TDD (SC-FDMA, 100% RB, 3 MHz, 64-QAM)	LTE-TDD	9.97	± 9.6 %
10261	CAG	LTE-TDD (SC-FDMA, 100% RB, 3 MHz, QPSK)	LTE-TDD	9.24	± 9.6 %
10262	CAG	LTE-TDD (SC-FDMA, 100% RB, 5 MHz, 16-QAM)	LTE-TDD	9.83	± 9.6 %
10263	CAG	LTE-TDD (SC-FDMA, 100% RB, 5 MHz, 64-QAM)	LTE-TDD	10.16	± 9.6 %
10264	CAG	LTE-TDD (SC-FDMA, 100% RB, 5 MHz, QPSK)	LTE-TDD	9.23	± 9.6 %
10265	CAG	LTE-TDD (SC-FDMA, 100% RB, 10 MHz, 16-QAM)	LTE-TDD	9.92	± 9.6 %
10266	CAF	LTE-TDD (SC-FDMA, 100% RB, 10 MHz, 64-QAM)	LTE-TDD	10.07	± 9.6 %
10267	CAF	LTE-TDD (SC-FDMA, 100% RB, 10 MHz, QPSK)	LTE-TDD	9.30	± 9.6 %
10268	CAF	LTE-TDD (SC-FDMA, 100% RB, 15 MHz, 16-QAM)	LTE-TDD	10.06	± 9.6 %
10269	CAB	LTE-TDD (SC-FDMA, 100% RB, 15 MHz, 64-QAM)	LTE-TDD	10.13	± 9.6 %
10270	CAB	LTE-TDD (SC-FDMA, 100% RB, 15 MHz, QPSK)	LTE-TDD	9.58	± 9.6 %
10274	CAB	UMTS-FDD (HSUPA, Subtest 5, 3GPP Rel8.10)	WCDMA	4.87	± 9.6 %
10275	CAD	UMTS-FDD (HSUPA, Subtest 5, 3GPP Rel8.4)	WCDMA	3.96	± 9.6 %
10277	CAD	PHS (QPSK)	PHS	11.81	± 9.6 %
10278	CAD	PHS (QPSK, BW 884MHz, Rolloff 0.5)	PHS	11.81	± 9.6 %
10279	CAG	PHS (QPSK, BW 884MHz, Rolloff 0.38)	PHS	12.18	± 9.6 %
10290	CAG	CDMA2000, RC1, SO55, Full Rate	CDMA2000	3.91	± 9.6 %
10291	CAG	CDMA2000, RC3, SO55, Full Rate	CDMA2000	3.46	± 9.6 %
10292	CAG	CDMA2000, RC3, SO32, Full Rate	CDMA2000	3.39	± 9.6 %
10293	CAG	CDMA2000, RC3, SO3, Full Rate	CDMA2000	3.50	± 9.6 %
10295	CAG	CDMA2000, RC1, SO3, 1/8th Rate 25 fr.	CDMA2000	12.49	± 9.6 %
10297	CAF	LTE-FDD (SC-FDMA, 50% RB, 20 MHz, QPSK)	LTE-FDD	5.81	± 9.6 %
10298	CAF	LTE-FDD (SC-FDMA, 50% RB, 3 MHz, QPSK)	LTE-FDD	5.72	± 9.6 %
10299	CAF	LTE-FDD (SC-FDMA, 50% RB, 3 MHz, 16-QAM)	LTE-FDD	6.39	± 9.6 %
10300	CAC	LTE-FDD (SC-FDMA, 50% RB, 3 MHz, 64-QAM)	LTE-FDD	6.60	± 9.6 %
10301	CAC	IEEE 802.16e WiMAX (29:18, 5ms, 10MHz, QPSK, PUSC)	WiMAX	12.03	± 9.6 %
10302	CAB	IEEE 802.16e WiMAX (29:18, 5ms, 10MHz, QPSK, PUSC, 3CTRL)	WiMAX	12.57	± 9.6 %
10303	CAB	IEEE 802.16e WiMAX (31:15, 5ms, 10MHz, 64QAM, PUSC)	WiMAX	12.52	± 9.6 %
10304	CAA	IEEE 802.16e WiMAX (29:18, 5ms, 10MHz, 64QAM, PUSC)	WiMAX	11.86	± 9.6 %
10305	CAA	IEEE 802.16e WiMAX (31:15, 10ms, 10MHz, 64QAM, PUSC)	WiMAX	15.24	± 9.6 %
10306	CAA	IEEE 802.16e WiMAX (29:18, 10ms, 10MHz, 64QAM, PUSC)	WiMAX	14.67	± 9.6 %
10307	AAB	IEEE 802.16e WiMAX (29:18, 10ms, 10MHz, QPSK, PUSC)	WiMAX	14.49	± 9.6 %
10308	AAB	IEEE 802.16e WiMAX (29:18, 10ms, 10MHz, 16QAM, PUSC)	WiMAX	14.46	± 9.6 %
10309	AAB	IEEE 802.16e WiMAX (29:18, 10ms, 10MHz, 16QAM, AMC 2x3)	WiMAX	14.58	± 9.6 %
10310	AAB	IEEE 802.16e WiMAX (29:18, 10ms, 10MHz, QPSK, AMC 2x3)	WiMAX	14.57	± 9.6 %
10311	AAB	LTE-FDD (SC-FDMA, 100% RB, 15 MHz, QPSK)	LTE-FDD	6.06	± 9.6 %
10313	AAD	iDEN 1:3	iDEN	10.51	± 9.6 %
10314	AAD	iDEN 1:6	iDEN	13.48	± 9.6 %
10315	AAD	IEEE 802.11b WiFi 2.4 GHz (DSSS, 1 Mbps, 96pc dc)	WLAN	1.71	± 9.6 %
10316	AAD	IEEE 802.11g WiFi 2.4 GHz (ERP-OFDM, 6 Mbps, 96pc dc)	WLAN	8.36	± 9.6 %
10317	AAA	IEEE 802.11a WiFi 5 GHz (OFDM, 6 Mbps, 96pc dc)	WLAN	8.36	± 9.6 %
10352	AAA	Pulse Waveform (200Hz, 10%)	Generic	10.00	± 9.6 %
10353	AAA	Pulse Waveform (200Hz, 20%)	Generic	6.99	± 9.6 %
10354	AAA	Pulse Waveform (200Hz, 40%)	Generic	3.98	± 9.6 %
10355	AAA	Pulse Waveform (200Hz, 60%)	Generic	2.22	± 9.6 %
10356	AAA	Pulse Waveform (200Hz, 80%)	Generic	0.97	± 9.6 %
10387	AAA	QPSK Waveform, 1 MHz	Generic	5.10	± 9.6 %
10388	AAA	QPSK Waveform, 10 MHz	Generic	5.22	± 9.6 %
10396	AAA	64-QAM Waveform, 100 kHz	Generic	6.27	± 9.6 %
10399	AAA	64-QAM Waveform, 40 MHz	Generic	6.27	± 9.6 %
10400	AAD	IEEE 802.11ac WiFi (20MHz, 64-QAM, 99pc dc)	WLAN	8.37	± 9.6 %
10401	AAA	IEEE 802.11ac WiFi (40MHz, 64-QAM, 99pc dc)	WLAN	8.60	± 9.6 %
10402	AAA	IEEE 802.11ac WiFi (80MHz, 64-QAM, 99pc dc)	WLAN	8.53	± 9.6 %
10403	AAB	CDMA2000 (1xEV-DO, Rev. 0)	CDMA2000	3.76	± 9.6 %
10404	AAB	CDMA2000 (1xEV-DO, Rev. A)	CDMA2000	3.77	± 9.6 %
10406	AAD	CDMA2000, RC3, SO32, SCH0, Full Rate	CDMA2000	5.22	± 9.6 %

10410	AAA	LTE-TDD (SC-FDMA, 1 RB, 10 MHz, QPSK, UL Sub=2,3,4,7,8,9)	LTE-TDD	7.82	± 9.6 %
10414	AAA	WLAN CCDF, 64-QAM, 40MHz	Generic	8.54	± 9.6 %
10415	AAA	IEEE 802.11b WiFi 2.4 GHz (DSSS, 1 Mbps, 99pc dc)	WLAN	1.54	± 9.6 %
10416	AAA	IEEE 802.11g WiFi 2.4 GHz (ERP-OFDM, 6 Mbps, 99pc dc)	WLAN	8.23	± 9.6 %
10417	AAA	IEEE 802.11a/h WiFi 5 GHz (OFDM, 6 Mbps, 99pc dc)	WLAN	8.23	± 9.6 %
10418	AAA	IEEE 802.11g WiFi 2.4 GHz (DSSS-OFDM, 6 Mbps, 99pc, Long)	WLAN	8.14	± 9.6 %
10419	AAA	IEEE 802.11g WiFi 2.4 GHz (DSSS-OFDM, 6 Mbps, 99pc, Short)	WLAN	8.19	± 9.6 %
10422	AAA	IEEE 802.11n (HT Greenfield, 7.2 Mbps, BPSK)	WLAN	8.32	± 9.6 %
10423	AAA	IEEE 802.11n (HT Greenfield, 43.3 Mbps, 16-QAM)	WLAN	8.47	± 9.6 %
10424	AAE	IEEE 802.11n (HT Greenfield, 72.2 Mbps, 64-QAM)	WLAN	8.40	± 9.6 %
10425	AAE	IEEE 802.11n (HT Greenfield, 15 Mbps, BPSK)	WLAN	8.41	± 9.6 %
10426	AAE	IEEE 802.11n (HT Greenfield, 90 Mbps, 16-QAM)	WLAN	8.45	± 9.6 %
10427	AAB	IEEE 802.11n (HT Greenfield, 150 Mbps, 64-QAM)	WLAN	8.41	± 9.6 %
10430	AAB	LTE-FDD (OFDMA, 5 MHz, E-TM 3.1)	LTE-FDD	8.28	± 9.6 %
10431	AAC	LTE-FDD (OFDMA, 10 MHz, E-TM 3.1)	LTE-FDD	8.38	± 9.6 %
10432	AAB	LTE-FDD (OFDMA, 15 MHz, E-TM 3.1)	LTE-FDD	8.34	± 9.6 %
10433	AAC	LTE-FDD (OFDMA, 20 MHz, E-TM 3.1)	LTE-FDD	8.34	± 9.6 %
10434	AAG	W-CDMA (BS Test Model 1, 64 DPCH)	WCDMA	8.60	± 9.6 %
10435	AAA	LTE-TDD (SC-FDMA, 1 RB, 20 MHz, QPSK, UL Sub)	LTE-TDD	7.82	± 9.6 %
10447	AAA	LTE-FDD (OFDMA, 5 MHz, E-TM 3.1, Clipping 44%)	LTE-FDD	7.56	± 9.6 %
10448	AAA	LTE-FDD (OFDMA, 10 MHz, E-TM 3.1, Clipping 44%)	LTE-FDD	7.53	± 9.6 %
10449	AAC	LTE-FDD (OFDMA, 15 MHz, E-TM 3.1, Clipping 44%)	LTE-FDD	7.51	± 9.6 %
10450	AAA	LTE-FDD (OFDMA, 20 MHz, E-TM 3.1, Clipping 44%)	LTE-FDD	7.48	± 9.6 %
10451	AAA	W-CDMA (BS Test Model 1, 64 DPCH, Clipping 44%)	WCDMA	7.59	± 9.6 %
10453	AAC	Validation (Square, 10ms, 1ms)	Test	10.00	± 9.6 %
10456	AAC	IEEE 802.11ac WiFi (160MHz, 64-QAM, 99pc dc)	WLAN	8.63	± 9.6 %
10457	AAC	UMTS-FDD (DC-HSDPA)	WCDMA	6.62	± 9.6 %
10458	AAC	CDMA2000 (1xEV-DO, Rev. B, 2 carriers)	CDMA2000	6.55	± 9.6 %
10459	AAC	CDMA2000 (1xEV-DO, Rev. B, 3 carriers)	CDMA2000	8.25	± 9.6 %
10460	AAC	UMTS-FDD (WCDMA, AMR)	WCDMA	2.39	± 9.6 %
10461	AAC	LTE-TDD (SC-FDMA, 1 RB, 1.4 MHz, QPSK, UL Sub)	LTE-TDD	7.82	± 9.6 %
10462	AAC	LTE-TDD (SC-FDMA, 1 RB, 1.4 MHz, 16-QAM, UL Sub)	LTE-TDD	8.30	± 9.6 %
10463	AAD	LTE-TDD (SC-FDMA, 1 RB, 1.4 MHz, 64-QAM, UL Sub)	LTE-TDD	8.56	± 9.6 %
10464	AAD	LTE-TDD (SC-FDMA, 1 RB, 3 MHz, QPSK, UL Sub)	LTE-TDD	7.82	± 9.6 %
10465	AAC	LTE-TDD (SC-FDMA, 1 RB, 3 MHz, 16-QAM, UL Sub)	LTE-TDD	8.32	± 9.6 %
10466	AAC	LTE-TDD (SC-FDMA, 1 RB, 3 MHz, 64-QAM, UL Sub)	LTE-TDD	8.57	± 9.6 %
10467	AAA	LTE-TDD (SC-FDMA, 1 RB, 5 MHz, QPSK, UL Sub)	LTE-TDD	7.82	± 9.6 %
10468	AAF	LTE-TDD (SC-FDMA, 1 RB, 5 MHz, 16-QAM, UL Sub)	LTE-TDD	8.32	± 9.6 %
10469	AAD	LTE-TDD (SC-FDMA, 1 RB, 5 MHz, 64-QAM, UL Sub)	LTE-TDD	8.56	± 9.6 %
10470	AAD	LTE-TDD (SC-FDMA, 1 RB, 10 MHz, QPSK, UL Sub)	LTE-TDD	7.82	± 9.6 %
10471	AAC	LTE-TDD (SC-FDMA, 1 RB, 10 MHz, 16-QAM, UL Sub)	LTE-TDD	8.32	± 9.6 %
10472	AAC	LTE-TDD (SC-FDMA, 1 RB, 10 MHz, 64-QAM, UL Sub)	LTE-TDD	8.57	± 9.6 %
10473	AAA	LTE-TDD (SC-FDMA, 1 RB, 15 MHz, QPSK, UL Sub)	LTE-TDD	7.82	± 9.6 %
10474	AAC	LTE-TDD (SC-FDMA, 1 RB, 15 MHz, 16-QAM, UL Sub)	LTE-TDD	8.32	± 9.6 %
10475	AAD	LTE-TDD (SC-FDMA, 1 RB, 15 MHz, 64-QAM, UL Sub)	LTE-TDD	8.57	± 9.6 %
10477	AAC	LTE-TDD (SC-FDMA, 1 RB, 20 MHz, 16-QAM, UL Sub)	LTE-TDD	8.32	± 9.6 %
10478	AAC	LTE-TDD (SC-FDMA, 1 RB, 20 MHz, 64-QAM, UL Sub)	LTE-TDD	8.57	± 9.6 %
10479	AAC	LTE-TDD (SC-FDMA, 50% RB, 1.4 MHz, QPSK, UL Sub)	LTE-TDD	7.74	± 9.6 %
10480	AAA	LTE-TDD (SC-FDMA, 50% RB, 1.4 MHz, 16-QAM, UL Sub)	LTE-TDD	8.18	± 9.6 %
10481	AAA	LTE-TDD (SC-FDMA, 50% RB, 1.4 MHz, 64-QAM, UL Sub)	LTE-TDD	8.45	± 9.6 %
10482	AAA	LTE-TDD (SC-FDMA, 50% RB, 3 MHz, QPSK, UL Sub)	LTE-TDD	7.71	± 9.6 %
10483	AAA	LTE-TDD (SC-FDMA, 50% RB, 3 MHz, 16-QAM, Sub)	LTE-TDD	8.39	± 9.6 %
10484	AAB	LTE-TDD (SC-FDMA, 50% RB, 3 MHz, 64-QAM, UL Sub)	LTE-TDD	8.47	± 9.6 %
10485	AAB	LTE-TDD (SC-FDMA, 50% RB, 5 MHz, QPSK, UL Sub)	LTE-TDD	7.59	± 9.6 %
10486	AAB	LTE-TDD (SC-FDMA, 50% RB, 5 MHz, 16-QAM, UL Sub)	LTE-TDD	8.38	± 9.6 %
10487	AAC	LTE-TDD (SC-FDMA, 50% RB, 5 MHz, 64-QAM, UL Sub)	LTE-TDD	8.60	± 9.6 %

10488	AAE	LTE-TDD (SC-FDMA, 50% RB, 10 MHz, QPSK, UL Sub)	LTE-TDD	7.70	± 9.6 %
10489	AAE	LTE-TDD (SC-FDMA, 50% RB, 10 MHz, 16-QAM, UL Sub)	LTE-TDD	8.31	± 9.6 %
10490	AAF	LTE-TDD (SC-FDMA, 50% RB, 10 MHz, 64-QAM, UL Sub)	LTE-TDD	8.54	± 9.6 %
10491	AAF	LTE-TDD (SC-FDMA, 50% RB, 15 MHz, QPSK, UL Sub)	LTE-TDD	7.74	± 9.6 %
10492	AAF	LTE-TDD (SC-FDMA, 50% RB, 15 MHz, 16-QAM, UL Sub)	LTE-TDD	8.41	± 9.6 %
10493	AAF	LTE-TDD (SC-FDMA, 50% RB, 15 MHz, 64-QAM, UL Sub)	LTE-TDD	8.55	± 9.6 %
10494	AAF	LTE-TDD (SC-FDMA, 50% RB, 20 MHz, QPSK, UL Sub)	LTE-TDD	7.74	± 9.6 %
10495	AAF	LTE-TDD (SC-FDMA, 50% RB, 20 MHz, 16-QAM, UL Sub)	LTE-TDD	8.37	± 9.6 %
10496	AAE	LTE-TDD (SC-FDMA, 50% RB, 20 MHz, 64-QAM, UL Sub)	LTE-TDD	8.54	± 9.6 %
10497	AAE	LTE-TDD (SC-FDMA, 100% RB, 1.4 MHz, QPSK, UL Sub)	LTE-TDD	7.67	± 9.6 %
10498	AAE	LTE-TDD (SC-FDMA, 100% RB, 1.4 MHz, 16-QAM, UL Sub)	LTE-TDD	8.40	± 9.6 %
10499	AAE	LTE-TDD (SC-FDMA, 100% RB, 1.4 MHz, 64-QAM, UL Sub)	LTE-TDD	8.68	± 9.6 %
10500	AAF	LTE-TDD (SC-FDMA, 100% RB, 3 MHz, QPSK, UL Sub)	LTE-TDD	7.67	± 9.6 %
10501	AAF	LTE-TDD (SC-FDMA, 100% RB, 3 MHz, 16-QAM, UL Sub)	LTE-TDD	8.44	± 9.6 %
10502	AAB	LTE-TDD (SC-FDMA, 100% RB, 3 MHz, 64-QAM, UL Sub)	LTE-TDD	8.52	± 9.6 %
10503	AAB	LTE-TDD (SC-FDMA, 100% RB, 5 MHz, QPSK, UL Sub)	LTE-TDD	7.72	± 9.6 %
10504	AAB	LTE-TDD (SC-FDMA, 100% RB, 5 MHz, 16-QAM, UL Sub)	LTE-TDD	8.31	± 9.6 %
10505	AAE	LTE-TDD (SC-FDMA, 100% RB, 5 MHz, 64-QAM, UL Sub)	LTE-TDD	8.54	± 9.6 %
10506	AAE	LTE-TDD (SC-FDMA, 100% RB, 10 MHz, QPSK, UL Sub)	LTE-TDD	7.74	± 9.6 %
10507	AAE	LTE-TDD (SC-FDMA, 100% RB, 10 MHz, 16-QAM, UL Sub)	LTE-TDD	8.36	± 9.6 %
10508	AAF	LTE-TDD (SC-FDMA, 100% RB, 10 MHz, 64-QAM, UL Sub)	LTE-TDD	8.55	± 9.6 %
10509	AAF	LTE-TDD (SC-FDMA, 100% RB, 15 MHz, QPSK, UL Sub)	LTE-TDD	7.99	± 9.6 %
10510	AAF	LTE-TDD (SC-FDMA, 100% RB, 15 MHz, 16-QAM, UL Sub)	LTE-TDD	8.49	± 9.6 %
10511	AAF	LTE-TDD (SC-FDMA, 100% RB, 15 MHz, 64-QAM, UL Sub)	LTE-TDD	8.51	± 9.6 %
10512	AAF	LTE-TDD (SC-FDMA, 100% RB, 20 MHz, QPSK, UL Sub)	LTE-TDD	7.74	± 9.6 %
10513	AAF	LTE-TDD (SC-FDMA, 100% RB, 20 MHz, 16-QAM, UL Sub)	LTE-TDD	8.42	± 9.6 %
10514	AAE	LTE-TDD (SC-FDMA, 100% RB, 20 MHz, 64-QAM, UL Sub)	LTE-TDD	8.45	± 9.6 %
10515	AAE	IEEE 802.11b WiFi 2.4 GHz (DSSS, 2 Mbps, 99pc dc)	WLAN	1.58	± 9.6 %
10516	AAE	IEEE 802.11b WiFi 2.4 GHz (DSSS, 5.5 Mbps, 99pc dc)	WLAN	1.57	± 9.6 %
10517	AAF	IEEE 802.11b WiFi 2.4 GHz (DSSS, 11 Mbps, 99pc dc)	WLAN	1.58	± 9.6 %
10518	AAF	IEEE 802.11a/h WiFi 5 GHz (OFDM, 9 Mbps, 99pc dc)	WLAN	8.23	± 9.6 %
10519	AAF	IEEE 802.11a/h WiFi 5 GHz (OFDM, 12 Mbps, 99pc dc)	WLAN	8.39	± 9.6 %
10520	AAB	IEEE 802.11a/h WiFi 5 GHz (OFDM, 18 Mbps, 99pc dc)	WLAN	8.12	± 9.6 %
10521	AAB	IEEE 802.11a/h WiFi 5 GHz (OFDM, 24 Mbps, 99pc dc)	WLAN	7.97	± 9.6 %
10522	AAB	IEEE 802.11a/h WiFi 5 GHz (OFDM, 36 Mbps, 99pc dc)	WLAN	8.45	± 9.6 %
10523	AAE	IEEE 802.11a/h WiFi 5 GHz (OFDM, 48 Mbps, 99pc dc)	WLAN	8.08	± 9.6 %
10524	AAE	IEEE 802.11a/h WiFi 5 GHz (OFDM, 54 Mbps, 99pc dc)	WLAN	8.27	± 9.6 %
10525	AAE	IEEE 802.11ac WiFi (20MHz, MCS0, 99pc dc)	WLAN	8.36	± 9.6 %
10526	AAF	IEEE 802.11ac WiFi (20MHz, MCS1, 99pc dc)	WLAN	8.42	± 9.6 %
10527	AAF	IEEE 802.11ac WiFi (20MHz, MCS2, 99pc dc)	WLAN	8.21	± 9.6 %
10528	AAF	IEEE 802.11ac WiFi (20MHz, MCS3, 99pc dc)	WLAN	8.36	± 9.6 %
10529	AAF	IEEE 802.11ac WiFi (20MHz, MCS4, 99pc dc)	WLAN	8.36	± 9.6 %
10531	AAF	IEEE 802.11ac WiFi (20MHz, MCS6, 99pc dc)	WLAN	8.43	± 9.6 %
10532	AAF	IEEE 802.11ac WiFi (20MHz, MCS7, 99pc dc)	WLAN	8.29	± 9.6 %
10533	AAE	IEEE 802.11ac WiFi (20MHz, MCS8, 99pc dc)	WLAN	8.38	± 9.6 %
10534	AAE	IEEE 802.11ac WiFi (40MHz, MCS0, 99pc dc)	WLAN	8.45	± 9.6 %
10535	AAE	IEEE 802.11ac WiFi (40MHz, MCS1, 99pc dc)	WLAN	8.45	± 9.6 %
10536	AAF	IEEE 802.11ac WiFi (40MHz, MCS2, 99pc dc)	WLAN	8.32	± 9.6 %
10537	AAF	IEEE 802.11ac WiFi (40MHz, MCS3, 99pc dc)	WLAN	8.44	± 9.6 %
10538	AAF	IEEE 802.11ac WiFi (40MHz, MCS4, 99pc dc)	WLAN	8.54	± 9.6 %
10540	AAA	IEEE 802.11ac WiFi (40MHz, MCS6, 99pc dc)	WLAN	8.39	± 9.6 %
10541	AAA	IEEE 802.11ac WiFi (40MHz, MCS7, 99pc dc)	WLAN	8.46	± 9.6 %
10542	AAA	IEEE 802.11ac WiFi (40MHz, MCS8, 99pc dc)	WLAN	8.65	± 9.6 %
10543	AAE	IEEE 802.11ac WiFi (40MHz, MCS9, 99pc dc)	WLAN	8.65	± 9.6 %
10544	AAE	IEEE 802.11ac WiFi (80MHz, MCS0, 99pc dc)	WLAN	8.47	± 9.6 %
10545	AAE	IEEE 802.11ac WiFi (80MHz, MCS1, 99pc dc)	WLAN	8.55	± 9.6 %

10546	AAC	IEEE 802.11ac WiFi (80MHz, MCS2, 99pc dc)	WLAN	8.35	± 9.6 %
10547	AAC	IEEE 802.11ac WiFi (80MHz, MCS3, 99pc dc)	WLAN	8.49	± 9.6 %
10548	AAC	IEEE 802.11ac WiFi (80MHz, MCS4, 99pc dc)	WLAN	8.37	± 9.6 %
10550	AAC	IEEE 802.11ac WiFi (80MHz, MCS6, 99pc dc)	WLAN	8.38	± 9.6 %
10551	AAC	IEEE 802.11ac WiFi (80MHz, MCS7, 99pc dc)	WLAN	8.50	± 9.6 %
10552	AAC	IEEE 802.11ac WiFi (80MHz, MCS8, 99pc dc)	WLAN	8.42	± 9.6 %
10553	AAC	IEEE 802.11ac WiFi (80MHz, MCS9, 99pc dc)	WLAN	8.45	± 9.6 %
10554	AAC	IEEE 802.11ac WiFi (160MHz, MCS0, 99pc dc)	WLAN	8.48	± 9.6 %
10555	AAC	IEEE 802.11ac WiFi (160MHz, MCS1, 99pc dc)	WLAN	8.47	± 9.6 %
10556	AAC	IEEE 802.11ac WiFi (160MHz, MCS2, 99pc dc)	WLAN	8.50	± 9.6 %
10557	AAC	IEEE 802.11ac WiFi (160MHz, MCS3, 99pc dc)	WLAN	8.52	± 9.6 %
10558	AAC	IEEE 802.11ac WiFi (160MHz, MCS4, 99pc dc)	WLAN	8.61	± 9.6 %
10560	AAC	IEEE 802.11ac WiFi (160MHz, MCS6, 99pc dc)	WLAN	8.73	± 9.6 %
10561	AAC	IEEE 802.11ac WiFi (160MHz, MCS7, 99pc dc)	WLAN	8.56	± 9.6 %
10562	AAC	IEEE 802.11ac WiFi (160MHz, MCS8, 99pc dc)	WLAN	8.69	± 9.6 %
10563	AAC	IEEE 802.11ac WiFi (160MHz, MCS9, 99pc dc)	WLAN	8.77	± 9.6 %
10564	AAC	IEEE 802.11g WiFi 2.4 GHz (DSSS-OFDM, 9 Mbps, 99pc dc)	WLAN	8.25	± 9.6 %
10565	AAC	IEEE 802.11g WiFi 2.4 GHz (DSSS-OFDM, 12 Mbps, 99pc dc)	WLAN	8.45	± 9.6 %
10566	AAC	IEEE 802.11g WiFi 2.4 GHz (DSSS-OFDM, 18 Mbps, 99pc dc)	WLAN	8.13	± 9.6 %
10567	AAC	IEEE 802.11g WiFi 2.4 GHz (DSSS-OFDM, 24 Mbps, 99pc dc)	WLAN	8.00	± 9.6 %
10568	AAC	IEEE 802.11g WiFi 2.4 GHz (DSSS-OFDM, 36 Mbps, 99pc dc)	WLAN	8.37	± 9.6 %
10569	AAC	IEEE 802.11g WiFi 2.4 GHz (DSSS-OFDM, 48 Mbps, 99pc dc)	WLAN	8.10	± 9.6 %
10570	AAC	IEEE 802.11g WiFi 2.4 GHz (DSSS-OFDM, 54 Mbps, 99pc dc)	WLAN	8.30	± 9.6 %
10571	AAC	IEEE 802.11b WiFi 2.4 GHz (DSSS, 1 Mbps, 90pc dc)	WLAN	1.99	± 9.6 %
10572	AAC	IEEE 802.11b WiFi 2.4 GHz (DSSS, 2 Mbps, 90pc dc)	WLAN	1.99	± 9.6 %
10573	AAC	IEEE 802.11b WiFi 2.4 GHz (DSSS, 5.5 Mbps, 90pc dc)	WLAN	1.98	± 9.6 %
10574	AAC	IEEE 802.11b WiFi 2.4 GHz (DSSS, 11 Mbps, 90pc dc)	WLAN	1.98	± 9.6 %
10575	AAC	IEEE 802.11g WiFi 2.4 GHz (DSSS-OFDM, 6 Mbps, 90pc dc)	WLAN	8.59	± 9.6 %
10576	AAC	IEEE 802.11g WiFi 2.4 GHz (DSSS-OFDM, 9 Mbps, 90pc dc)	WLAN	8.60	± 9.6 %
10577	AAC	IEEE 802.11g WiFi 2.4 GHz (DSSS-OFDM, 12 Mbps, 90pc dc)	WLAN	8.70	± 9.6 %
10578	AAD	IEEE 802.11g WiFi 2.4 GHz (DSSS-OFDM, 18 Mbps, 90pc dc)	WLAN	8.49	± 9.6 %
10579	AAD	IEEE 802.11g WiFi 2.4 GHz (DSSS-OFDM, 24 Mbps, 90pc dc)	WLAN	8.36	± 9.6 %
10580	AAD	IEEE 802.11g WiFi 2.4 GHz (DSSS-OFDM, 36 Mbps, 90pc dc)	WLAN	8.76	± 9.6 %
10581	AAD	IEEE 802.11g WiFi 2.4 GHz (DSSS-OFDM, 48 Mbps, 90pc dc)	WLAN	8.35	± 9.6 %
10582	AAD	IEEE 802.11g WiFi 2.4 GHz (DSSS-OFDM, 54 Mbps, 90pc dc)	WLAN	8.67	± 9.6 %
10583	AAD	IEEE 802.11a/h WiFi 5 GHz (OFDM, 6 Mbps, 90pc dc)	WLAN	8.59	± 9.6 %
10584	AAD	IEEE 802.11a/h WiFi 5 GHz (OFDM, 9 Mbps, 90pc dc)	WLAN	8.60	± 9.6 %
10585	AAD	IEEE 802.11a/h WiFi 5 GHz (OFDM, 12 Mbps, 90pc dc)	WLAN	8.70	± 9.6 %
10586	AAD	IEEE 802.11a/h WiFi 5 GHz (OFDM, 18 Mbps, 90pc dc)	WLAN	8.49	± 9.6 %
10587	AAA	IEEE 802.11a/h WiFi 5 GHz (OFDM, 24 Mbps, 90pc dc)	WLAN	8.36	± 9.6 %
10588	AAA	IEEE 802.11a/h WiFi 5 GHz (OFDM, 36 Mbps, 90pc dc)	WLAN	8.76	± 9.6 %
10589	AAA	IEEE 802.11a/h WiFi 5 GHz (OFDM, 48 Mbps, 90pc dc)	WLAN	8.35	± 9.6 %
10590	AAA	IEEE 802.11a/h WiFi 5 GHz (OFDM, 54 Mbps, 90pc dc)	WLAN	8.67	± 9.6 %
10591	AAA	IEEE 802.11n (HT Mixed, 20MHz, MCS0, 90pc dc)	WLAN	8.63	± 9.6 %
10592	AAA	IEEE 802.11n (HT Mixed, 20MHz, MCS1, 90pc dc)	WLAN	8.79	± 9.6 %
10593	AAA	IEEE 802.11n (HT Mixed, 20MHz, MCS2, 90pc dc)	WLAN	8.64	± 9.6 %
10594	AAA	IEEE 802.11n (HT Mixed, 20MHz, MCS3, 90pc dc)	WLAN	8.74	± 9.6 %
10595	AAA	IEEE 802.11n (HT Mixed, 20MHz, MCS4, 90pc dc)	WLAN	8.74	± 9.6 %
10596	AAA	IEEE 802.11n (HT Mixed, 20MHz, MCS5, 90pc dc)	WLAN	8.71	± 9.6 %
10597	AAA	IEEE 802.11n (HT Mixed, 20MHz, MCS6, 90pc dc)	WLAN	8.72	± 9.6 %
10598	AAA	IEEE 802.11n (HT Mixed, 20MHz, MCS7, 90pc dc)	WLAN	8.50	± 9.6 %
10599	AAA	IEEE 802.11n (HT Mixed, 40MHz, MCS0, 90pc dc)	WLAN	8.79	± 9.6 %
10600	AAA	IEEE 802.11n (HT Mixed, 40MHz, MCS1, 90pc dc)	WLAN	8.88	± 9.6 %
10601	AAA	IEEE 802.11n (HT Mixed, 40MHz, MCS2, 90pc dc)	WLAN	8.82	± 9.6 %
10602	AAA	IEEE 802.11n (HT Mixed, 40MHz, MCS3, 90pc dc)	WLAN	8.94	± 9.6 %
10603	AAA	IEEE 802.11n (HT Mixed, 40MHz, MCS4, 90pc dc)	WLAN	9.03	± 9.6 %

10604	AAA	IEEE 802.11n (HT Mixed, 40MHz, MCS5, 90pc dc)	WLAN	8.76	± 9.6 %
10605	AAA	IEEE 802.11n (HT Mixed, 40MHz, MCS6, 90pc dc)	WLAN	8.97	± 9.6 %
10606	AAC	IEEE 802.11n (HT Mixed, 40MHz, MCS7, 90pc dc)	WLAN	8.82	± 9.6 %
10607	AAC	IEEE 802.11ac WiFi (20MHz, MCS0, 90pc dc)	WLAN	8.64	± 9.6 %
10608	AAC	IEEE 802.11ac WiFi (20MHz, MCS1, 90pc dc)	WLAN	8.77	± 9.6 %
10609	AAC	IEEE 802.11ac WiFi (20MHz, MCS2, 90pc dc)	WLAN	8.57	± 9.6 %
10610	AAC	IEEE 802.11ac WiFi (20MHz, MCS3, 90pc dc)	WLAN	8.78	± 9.6 %
10611	AAC	IEEE 802.11ac WiFi (20MHz, MCS4, 90pc dc)	WLAN	8.70	± 9.6 %
10612	AAC	IEEE 802.11ac WiFi (20MHz, MCS5, 90pc dc)	WLAN	8.77	± 9.6 %
10613	AAC	IEEE 802.11ac WiFi (20MHz, MCS6, 90pc dc)	WLAN	8.94	± 9.6 %
10614	AAC	IEEE 802.11ac WiFi (20MHz, MCS7, 90pc dc)	WLAN	8.59	± 9.6 %
10615	AAC	IEEE 802.11ac WiFi (20MHz, MCS8, 90pc dc)	WLAN	8.82	± 9.6 %
10616	AAC	IEEE 802.11ac WiFi (40MHz, MCS0, 90pc dc)	WLAN	8.82	± 9.6 %
10617	AAC	IEEE 802.11ac WiFi (40MHz, MCS1, 90pc dc)	WLAN	8.81	± 9.6 %
10618	AAC	IEEE 802.11ac WiFi (40MHz, MCS2, 90pc dc)	WLAN	8.58	± 9.6 %
10619	AAC	IEEE 802.11ac WiFi (40MHz, MCS3, 90pc dc)	WLAN	8.86	± 9.6 %
10620	AAC	IEEE 802.11ac WiFi (40MHz, MCS4, 90pc dc)	WLAN	8.87	± 9.6 %
10621	AAC	IEEE 802.11ac WiFi (40MHz, MCS5, 90pc dc)	WLAN	8.77	± 9.6 %
10622	AAC	IEEE 802.11ac WiFi (40MHz, MCS6, 90pc dc)	WLAN	8.68	± 9.6 %
10623	AAC	IEEE 802.11ac WiFi (40MHz, MCS7, 90pc dc)	WLAN	8.82	± 9.6 %
10624	AAC	IEEE 802.11ac WiFi (40MHz, MCS8, 90pc dc)	WLAN	8.96	± 9.6 %
10625	AAC	IEEE 802.11ac WiFi (40MHz, MCS9, 90pc dc)	WLAN	8.96	± 9.6 %
10626	AAC	IEEE 802.11ac WiFi (80MHz, MCS0, 90pc dc)	WLAN	8.83	± 9.6 %
10627	AAC	IEEE 802.11ac WiFi (80MHz, MCS1, 90pc dc)	WLAN	8.88	± 9.6 %
10628	AAC	IEEE 802.11ac WiFi (80MHz, MCS2, 90pc dc)	WLAN	8.71	± 9.6 %
10629	AAC	IEEE 802.11ac WiFi (80MHz, MCS3, 90pc dc)	WLAN	8.85	± 9.6 %
10630	AAC	IEEE 802.11ac WiFi (80MHz, MCS4, 90pc dc)	WLAN	8.72	± 9.6 %
10631	AAC	IEEE 802.11ac WiFi (80MHz, MCS5, 90pc dc)	WLAN	8.81	± 9.6 %
10632	AAC	IEEE 802.11ac WiFi (80MHz, MCS6, 90pc dc)	WLAN	8.74	± 9.6 %
10633	AAC	IEEE 802.11ac WiFi (80MHz, MCS7, 90pc dc)	WLAN	8.83	± 9.6 %
10634	AAC	IEEE 802.11ac WiFi (80MHz, MCS8, 90pc dc)	WLAN	8.80	± 9.6 %
10635	AAC	IEEE 802.11ac WiFi (80MHz, MCS9, 90pc dc)	WLAN	8.81	± 9.6 %
10636	AAC	IEEE 802.11ac WiFi (160MHz, MCS0, 90pc dc)	WLAN	8.83	± 9.6 %
10637	AAC	IEEE 802.11ac WiFi (160MHz, MCS1, 90pc dc)	WLAN	8.79	± 9.6 %
10638	AAC	IEEE 802.11ac WiFi (160MHz, MCS2, 90pc dc)	WLAN	8.86	± 9.6 %
10639	AAC	IEEE 802.11ac WiFi (160MHz, MCS3, 90pc dc)	WLAN	8.85	± 9.6 %
10640	AAC	IEEE 802.11ac WiFi (160MHz, MCS4, 90pc dc)	WLAN	8.98	± 9.6 %
10641	AAC	IEEE 802.11ac WiFi (160MHz, MCS5, 90pc dc)	WLAN	9.06	± 9.6 %
10642	AAC	IEEE 802.11ac WiFi (160MHz, MCS6, 90pc dc)	WLAN	9.06	± 9.6 %
10643	AAC	IEEE 802.11ac WiFi (160MHz, MCS7, 90pc dc)	WLAN	8.89	± 9.6 %
10644	AAC	IEEE 802.11ac WiFi (160MHz, MCS8, 90pc dc)	WLAN	9.05	± 9.6 %
10645	AAC	IEEE 802.11ac WiFi (160MHz, MCS9, 90pc dc)	WLAN	9.11	± 9.6 %
10646	AAC	LTE-TDD (SC-FDMA, 1 RB, 5 MHz, QPSK, UL Sub=2,7)	LTE-TDD	11.96	± 9.6 %
10647	AAC	LTE-TDD (SC-FDMA, 1 RB, 20 MHz, QPSK, UL Sub=2,7)	LTE-TDD	11.96	± 9.6 %
10648	AAC	CDMA2000 (1x Advanced)	CDMA2000	3.45	± 9.6 %
10652	AAC	LTE-TDD (OFDMA, 5 MHz, E-TM 3.1, Clipping 44%)	LTE-TDD	6.91	± 9.6 %
10653	AAC	LTE-TDD (OFDMA, 10 MHz, E-TM 3.1, Clipping 44%)	LTE-TDD	7.42	± 9.6 %
10654	AAC	LTE-TDD (OFDMA, 15 MHz, E-TM 3.1, Clipping 44%)	LTE-TDD	6.96	± 9.6 %
10655	AAC	LTE-TDD (OFDMA, 20 MHz, E-TM 3.1, Clipping 44%)	LTE-TDD	7.21	± 9.6 %
10658	AAC	Pulse Waveform (200Hz, 10%)	Test	10.00	± 9.6 %
10659	AAC	Pulse Waveform (200Hz, 20%)	Test	6.99	± 9.6 %
10660	AAC	Pulse Waveform (200Hz, 40%)	Test	3.98	± 9.6 %
10661	AAC	Pulse Waveform (200Hz, 60%)	Test	2.22	± 9.6 %
10662	AAC	Pulse Waveform (200Hz, 80%)	Test	0.97	± 9.6 %
10670	AAC	Bluetooth Low Energy	Bluetooth	2.19	± 9.6 %
10671	AAD	IEEE 802.11ax (20MHz, MCS0, 90pc dc)	WLAN	9.09	± 9.6 %

10672	AAD	IEEE 802.11ax (20MHz, MCS1, 90pc dc)	WLAN	8.57	± 9.6 %
10673	AAD	IEEE 802.11ax (20MHz, MCS2, 90pc dc)	WLAN	8.78	± 9.6 %
10674	AAD	IEEE 802.11ax (20MHz, MCS3, 90pc dc)	WLAN	8.74	± 9.6 %
10675	AAD	IEEE 802.11ax (20MHz, MCS4, 90pc dc)	WLAN	8.90	± 9.6 %
10676	AAD	IEEE 802.11ax (20MHz, MCS5, 90pc dc)	WLAN	8.77	± 9.6 %
10677	AAD	IEEE 802.11ax (20MHz, MCS6, 90pc dc)	WLAN	8.73	± 9.6 %
10678	AAD	IEEE 802.11ax (20MHz, MCS7, 90pc dc)	WLAN	8.78	± 9.6 %
10679	AAD	IEEE 802.11ax (20MHz, MCS8, 90pc dc)	WLAN	8.89	± 9.6 %
10680	AAD	IEEE 802.11ax (20MHz, MCS9, 90pc dc)	WLAN	8.80	± 9.6 %
10681	AAG	IEEE 802.11ax (20MHz, MCS10, 90pc dc)	WLAN	8.62	± 9.6 %
10682	AAF	IEEE 802.11ax (20MHz, MCS11, 90pc dc)	WLAN	8.83	± 9.6 %
10683	AAA	IEEE 802.11ax (20MHz, MCS0, 99pc dc)	WLAN	8.42	± 9.6 %
10684	AAC	IEEE 802.11ax (20MHz, MCS1, 99pc dc)	WLAN	8.26	± 9.6 %
10685	AAC	IEEE 802.11ax (20MHz, MCS2, 99pc dc)	WLAN	8.33	± 9.6 %
10686	AAC	IEEE 802.11ax (20MHz, MCS3, 99pc dc)	WLAN	8.28	± 9.6 %
10687	AAE	IEEE 802.11ax (20MHz, MCS4, 99pc dc)	WLAN	8.45	± 9.6 %
10688	AAE	IEEE 802.11ax (20MHz, MCS5, 99pc dc)	WLAN	8.29	± 9.6 %
10689	AAD	IEEE 802.11ax (20MHz, MCS6, 99pc dc)	WLAN	8.55	± 9.6 %
10690	AAE	IEEE 802.11ax (20MHz, MCS7, 99pc dc)	WLAN	8.29	± 9.6 %
10691	AAB	IEEE 802.11ax (20MHz, MCS8, 99pc dc)	WLAN	8.25	± 9.6 %
10692	AAA	IEEE 802.11ax (20MHz, MCS9, 99pc dc)	WLAN	8.29	± 9.6 %
10693	AAA	IEEE 802.11ax (20MHz, MCS10, 99pc dc)	WLAN	8.25	± 9.6 %
10694	AAA	IEEE 802.11ax (20MHz, MCS11, 99pc dc)	WLAN	8.57	± 9.6 %
10695	AAA	IEEE 802.11ax (40MHz, MCS0, 90pc dc)	WLAN	8.78	± 9.6 %
10696	AAA	IEEE 802.11ax (40MHz, MCS1, 90pc dc)	WLAN	8.91	± 9.6 %
10697	AAA	IEEE 802.11ax (40MHz, MCS2, 90pc dc)	WLAN	8.61	± 9.6 %
10698	AAA	IEEE 802.11ax (40MHz, MCS3, 90pc dc)	WLAN	8.89	± 9.6 %
10699	AAA	IEEE 802.11ax (40MHz, MCS4, 90pc dc)	WLAN	8.82	± 9.6 %
10700	AAA	IEEE 802.11ax (40MHz, MCS5, 90pc dc)	WLAN	8.73	± 9.6 %
10701	AAA	IEEE 802.11ax (40MHz, MCS6, 90pc dc)	WLAN	8.86	± 9.6 %
10702	AAA	IEEE 802.11ax (40MHz, MCS7, 90pc dc)	WLAN	8.70	± 9.6 %
10703	AAA	IEEE 802.11ax (40MHz, MCS8, 90pc dc)	WLAN	8.82	± 9.6 %
10704	AAA	IEEE 802.11ax (40MHz, MCS9, 90pc dc)	WLAN	8.56	± 9.6 %
10705	AAA	IEEE 802.11ax (40MHz, MCS10, 90pc dc)	WLAN	8.69	± 9.6 %
10706	AAC	IEEE 802.11ax (40MHz, MCS11, 90pc dc)	WLAN	8.66	± 9.6 %
10707	AAC	IEEE 802.11ax (40MHz, MCS0, 99pc dc)	WLAN	8.32	± 9.6 %
10708	AAC	IEEE 802.11ax (40MHz, MCS1, 99pc dc)	WLAN	8.55	± 9.6 %
10709	AAC	IEEE 802.11ax (40MHz, MCS2, 99pc dc)	WLAN	8.33	± 9.6 %
10710	AAC	IEEE 802.11ax (40MHz, MCS3, 99pc dc)	WLAN	8.29	± 9.6 %
10711	AAC	IEEE 802.11ax (40MHz, MCS4, 99pc dc)	WLAN	8.39	± 9.6 %
10712	AAC	IEEE 802.11ax (40MHz, MCS5, 99pc dc)	WLAN	8.67	± 9.6 %
10713	AAC	IEEE 802.11ax (40MHz, MCS6, 99pc dc)	WLAN	8.33	± 9.6 %
10714	AAC	IEEE 802.11ax (40MHz, MCS7, 99pc dc)	WLAN	8.26	± 9.6 %
10715	AAC	IEEE 802.11ax (40MHz, MCS8, 99pc dc)	WLAN	8.45	± 9.6 %
10716	AAC	IEEE 802.11ax (40MHz, MCS9, 99pc dc)	WLAN	8.30	± 9.6 %
10717	AAC	IEEE 802.11ax (40MHz, MCS10, 99pc dc)	WLAN	8.48	± 9.6 %
10718	AAC	IEEE 802.11ax (40MHz, MCS11, 99pc dc)	WLAN	8.24	± 9.6 %
10719	AAC	IEEE 802.11ax (80MHz, MCS0, 90pc dc)	WLAN	8.81	± 9.6 %
10720	AAC	IEEE 802.11ax (80MHz, MCS1, 90pc dc)	WLAN	8.87	± 9.6 %
10721	AAC	IEEE 802.11ax (80MHz, MCS2, 90pc dc)	WLAN	8.76	± 9.6 %
10722	AAC	IEEE 802.11ax (80MHz, MCS3, 90pc dc)	WLAN	8.55	± 9.6 %
10723	AAC	IEEE 802.11ax (80MHz, MCS4, 90pc dc)	WLAN	8.70	± 9.6 %
10724	AAC	IEEE 802.11ax (80MHz, MCS5, 90pc dc)	WLAN	8.90	± 9.6 %
10725	AAC	IEEE 802.11ax (80MHz, MCS6, 90pc dc)	WLAN	8.74	± 9.6 %
10726	AAC	IEEE 802.11ax (80MHz, MCS7, 90pc dc)	WLAN	8.72	± 9.6 %
10727	AAC	IEEE 802.11ax (80MHz, MCS8, 90pc dc)	WLAN	8.86	± 9.6 %

10728	AAC	IEEE 802.11ax (80MHz, MCS9, 90pc dc)	WLAN	8.65	± 9.6 %
10729	AAC	IEEE 802.11ax (80MHz, MCS10, 90pc dc)	WLAN	8.64	± 9.6 %
10730	AAC	IEEE 802.11ax (80MHz, MCS11, 90pc dc)	WLAN	8.67	± 9.6 %
10731	AAC	IEEE 802.11ax (80MHz, MCS0, 99pc dc)	WLAN	8.42	± 9.6 %
10732	AAC	IEEE 802.11ax (80MHz, MCS1, 99pc dc)	WLAN	8.46	± 9.6 %
10733	AAC	IEEE 802.11ax (80MHz, MCS2, 99pc dc)	WLAN	8.40	± 9.6 %
10734	AAC	IEEE 802.11ax (80MHz, MCS3, 99pc dc)	WLAN	8.25	± 9.6 %
10735	AAC	IEEE 802.11ax (80MHz, MCS4, 99pc dc)	WLAN	8.33	± 9.6 %
10736	AAC	IEEE 802.11ax (80MHz, MCS5, 99pc dc)	WLAN	8.27	± 9.6 %
10737	AAC	IEEE 802.11ax (80MHz, MCS6, 99pc dc)	WLAN	8.36	± 9.6 %
10738	AAC	IEEE 802.11ax (80MHz, MCS7, 99pc dc)	WLAN	8.42	± 9.6 %
10739	AAC	IEEE 802.11ax (80MHz, MCS8, 99pc dc)	WLAN	8.29	± 9.6 %
10740	AAC	IEEE 802.11ax (80MHz, MCS9, 99pc dc)	WLAN	8.48	± 9.6 %
10741	AAC	IEEE 802.11ax (80MHz, MCS10, 99pc dc)	WLAN	8.40	± 9.6 %
10742	AAC	IEEE 802.11ax (80MHz, MCS11, 99pc dc)	WLAN	8.43	± 9.6 %
10743	AAC	IEEE 802.11ax (160MHz, MCS0, 90pc dc)	WLAN	8.94	± 9.6 %
10744	AAC	IEEE 802.11ax (160MHz, MCS1, 90pc dc)	WLAN	9.16	± 9.6 %
10745	AAC	IEEE 802.11ax (160MHz, MCS2, 90pc dc)	WLAN	8.93	± 9.6 %
10746	AAC	IEEE 802.11ax (160MHz, MCS3, 90pc dc)	WLAN	9.11	± 9.6 %
10747	AAC	IEEE 802.11ax (160MHz, MCS4, 90pc dc)	WLAN	9.04	± 9.6 %
10748	AAC	IEEE 802.11ax (160MHz, MCS5, 90pc dc)	WLAN	8.93	± 9.6 %
10749	AAC	IEEE 802.11ax (160MHz, MCS6, 90pc dc)	WLAN	8.90	± 9.6 %
10750	AAC	IEEE 802.11ax (160MHz, MCS7, 90pc dc)	WLAN	8.79	± 9.6 %
10751	AAC	IEEE 802.11ax (160MHz, MCS8, 90pc dc)	WLAN	8.82	± 9.6 %
10752	AAC	IEEE 802.11ax (160MHz, MCS9, 90pc dc)	WLAN	8.81	± 9.6 %
10753	AAC	IEEE 802.11ax (160MHz, MCS10, 90pc dc)	WLAN	9.00	± 9.6 %
10754	AAC	IEEE 802.11ax (160MHz, MCS11, 90pc dc)	WLAN	8.94	± 9.6 %
10755	AAC	IEEE 802.11ax (160MHz, MCS0, 99pc dc)	WLAN	8.64	± 9.6 %
10756	AAC	IEEE 802.11ax (160MHz, MCS1, 99pc dc)	WLAN	8.77	± 9.6 %
10757	AAC	IEEE 802.11ax (160MHz, MCS2, 99pc dc)	WLAN	8.77	± 9.6 %
10758	AAC	IEEE 802.11ax (160MHz, MCS3, 99pc dc)	WLAN	8.69	± 9.6 %
10759	AAC	IEEE 802.11ax (160MHz, MCS4, 99pc dc)	WLAN	8.58	± 9.6 %
10760	AAC	IEEE 802.11ax (160MHz, MCS5, 99pc dc)	WLAN	8.49	± 9.6 %
10761	AAC	IEEE 802.11ax (160MHz, MCS6, 99pc dc)	WLAN	8.58	± 9.6 %
10762	AAC	IEEE 802.11ax (160MHz, MCS7, 99pc dc)	WLAN	8.49	± 9.6 %
10763	AAC	IEEE 802.11ax (160MHz, MCS8, 99pc dc)	WLAN	8.53	± 9.6 %
10764	AAC	IEEE 802.11ax (160MHz, MCS9, 99pc dc)	WLAN	8.54	± 9.6 %
10765	AAC	IEEE 802.11ax (160MHz, MCS10, 99pc dc)	WLAN	8.54	± 9.6 %
10766	AAC	IEEE 802.11ax (160MHz, MCS11, 99pc dc)	WLAN	8.51	± 9.6 %
10767	AAC	5G NR (CP-OFDM, 1 RB, 5 MHz, QPSK, 15 kHz)	5G NR FR1 TDD	7.99	± 9.6 %
10768	AAC	5G NR (CP-OFDM, 1 RB, 10 MHz, QPSK, 15 kHz)	5G NR FR1 TDD	8.01	± 9.6 %
10769	AAC	5G NR (CP-OFDM, 1 RB, 15 MHz, QPSK, 15 kHz)	5G NR FR1 TDD	8.01	± 9.6 %
10770	AAC	5G NR (CP-OFDM, 1 RB, 20 MHz, QPSK, 15 kHz)	5G NR FR1 TDD	8.02	± 9.6 %
10771	AAC	5G NR (CP-OFDM, 1 RB, 25 MHz, QPSK, 15 kHz)	5G NR FR1 TDD	8.02	± 9.6 %
10772	AAC	5G NR (CP-OFDM, 1 RB, 30 MHz, QPSK, 15 kHz)	5G NR FR1 TDD	8.23	± 9.6 %
10773	AAC	5G NR (CP-OFDM, 1 RB, 40 MHz, QPSK, 15 kHz)	5G NR FR1 TDD	8.03	± 9.6 %
10774	AAC	5G NR (CP-OFDM, 1 RB, 50 MHz, QPSK, 15 kHz)	5G NR FR1 TDD	8.02	± 9.6 %
10775	AAC	5G NR (CP-OFDM, 50% RB, 5 MHz, QPSK, 15 kHz)	5G NR FR1 TDD	8.31	± 9.6 %
10776	AAC	5G NR (CP-OFDM, 50% RB, 10 MHz, QPSK, 15 kHz)	5G NR FR1 TDD	8.30	± 9.6 %
10777	AAC	5G NR (CP-OFDM, 50% RB, 15 MHz, QPSK, 15 kHz)	5G NR FR1 TDD	8.30	± 9.6 %
10778	AAC	5G NR (CP-OFDM, 50% RB, 20 MHz, QPSK, 15 kHz)	5G NR FR1 TDD	8.34	± 9.6 %
10779	AAC	5G NR (CP-OFDM, 50% RB, 25 MHz, QPSK, 15 kHz)	5G NR FR1 TDD	8.42	± 9.6 %
10780	AAC	5G NR (CP-OFDM, 50% RB, 30 MHz, QPSK, 15 kHz)	5G NR FR1 TDD	8.38	± 9.6 %
10781	AAC	5G NR (CP-OFDM, 50% RB, 40 MHz, QPSK, 15 kHz)	5G NR FR1 TDD	8.38	± 9.6 %
10782	AAC	5G NR (CP-OFDM, 50% RB, 50 MHz, QPSK, 15 kHz)	5G NR FR1 TDD	8.43	± 9.6 %
10783	AAC	5G NR (CP-OFDM, 100% RB, 5 MHz, QPSK, 15 kHz)	5G NR FR1 TDD	8.31	± 9.6 %

10784	AAC	5G NR (CP-OFDM, 100% RB, 10 MHz, QPSK, 15 kHz)	5G NR FR1 TDD	8.29	± 9.6 %
10785	AAC	5G NR (CP-OFDM, 100% RB, 15 MHz, QPSK, 15 kHz)	5G NR FR1 TDD	8.40	± 9.6 %
10786	AAC	5G NR (CP-OFDM, 100% RB, 20 MHz, QPSK, 15 kHz)	5G NR FR1 TDD	8.35	± 9.6 %
10787	AAC	5G NR (CP-OFDM, 100% RB, 25 MHz, QPSK, 15 kHz)	5G NR FR1 TDD	8.44	± 9.6 %
10788	AAC	5G NR (CP-OFDM, 100% RB, 30 MHz, QPSK, 15 kHz)	5G NR FR1 TDD	8.39	± 9.6 %
10789	AAC	5G NR (CP-OFDM, 100% RB, 40 MHz, QPSK, 15 kHz)	5G NR FR1 TDD	8.37	± 9.6 %
10790	AAC	5G NR (CP-OFDM, 100% RB, 50 MHz, QPSK, 15 kHz)	5G NR FR1 TDD	8.39	± 9.6 %
10791	AAC	5G NR (CP-OFDM, 1 RB, 5 MHz, QPSK, 30 kHz)	5G NR FR1 TDD	7.83	± 9.6 %
10792	AAC	5G NR (CP-OFDM, 1 RB, 10 MHz, QPSK, 30 kHz)	5G NR FR1 TDD	7.92	± 9.6 %
10793	AAC	5G NR (CP-OFDM, 1 RB, 15 MHz, QPSK, 30 kHz)	5G NR FR1 TDD	7.95	± 9.6 %
10794	AAC	5G NR (CP-OFDM, 1 RB, 20 MHz, QPSK, 30 kHz)	5G NR FR1 TDD	7.82	± 9.6 %
10795	AAC	5G NR (CP-OFDM, 1 RB, 25 MHz, QPSK, 30 kHz)	5G NR FR1 TDD	7.84	± 9.6 %
10796	AAC	5G NR (CP-OFDM, 1 RB, 30 MHz, QPSK, 30 kHz)	5G NR FR1 TDD	7.82	± 9.6 %
10797	AAC	5G NR (CP-OFDM, 1 RB, 40 MHz, QPSK, 30 kHz)	5G NR FR1 TDD	8.01	± 9.6 %
10798	AAC	5G NR (CP-OFDM, 1 RB, 50 MHz, QPSK, 30 kHz)	5G NR FR1 TDD	7.89	± 9.6 %
10799	AAC	5G NR (CP-OFDM, 1 RB, 60 MHz, QPSK, 30 kHz)	5G NR FR1 TDD	7.93	± 9.6 %
10801	AAC	5G NR (CP-OFDM, 1 RB, 80 MHz, QPSK, 30 kHz)	5G NR FR1 TDD	7.89	± 9.6 %
10802	AAC	5G NR (CP-OFDM, 1 RB, 90 MHz, QPSK, 30 kHz)	5G NR FR1 TDD	7.87	± 9.6 %
10803	AAE	5G NR (CP-OFDM, 1 RB, 100 MHz, QPSK, 30 kHz)	5G NR FR1 TDD	7.93	± 9.6 %
10805	AAD	5G NR (CP-OFDM, 50% RB, 10 MHz, QPSK, 30 kHz)	5G NR FR1 TDD	8.34	± 9.6 %
10806	AAD	5G NR (CP-OFDM, 50% RB, 15 MHz, QPSK, 30 kHz)	5G NR FR1 TDD	8.37	± 9.6 %
10809	AAD	5G NR (CP-OFDM, 50% RB, 30 MHz, QPSK, 30 kHz)	5G NR FR1 TDD	8.34	± 9.6 %
10810	AAD	5G NR (CP-OFDM, 50% RB, 40 MHz, QPSK, 30 kHz)	5G NR FR1 TDD	8.34	± 9.6 %
10812	AAD	5G NR (CP-OFDM, 50% RB, 60 MHz, QPSK, 30 kHz)	5G NR FR1 TDD	8.35	± 9.6 %
10817	AAD	5G NR (CP-OFDM, 100% RB, 5 MHz, QPSK, 30 kHz)	5G NR FR1 TDD	8.35	± 9.6 %
10818	AAD	5G NR (CP-OFDM, 100% RB, 10 MHz, QPSK, 30 kHz)	5G NR FR1 TDD	8.34	± 9.6 %
10819	AAD	5G NR (CP-OFDM, 100% RB, 15 MHz, QPSK, 30 kHz)	5G NR FR1 TDD	8.33	± 9.6 %
10820	AAD	5G NR (CP-OFDM, 100% RB, 20 MHz, QPSK, 30 kHz)	5G NR FR1 TDD	8.30	± 9.6 %
10821	AAC	5G NR (CP-OFDM, 100% RB, 25 MHz, QPSK, 30 kHz)	5G NR FR1 TDD	8.41	± 9.6 %
10822	AAD	5G NR (CP-OFDM, 100% RB, 30 MHz, QPSK, 30 kHz)	5G NR FR1 TDD	8.41	± 9.6 %
10823	AAC	5G NR (CP-OFDM, 100% RB, 40 MHz, QPSK, 30 kHz)	5G NR FR1 TDD	8.36	± 9.6 %
10824	AAD	5G NR (CP-OFDM, 100% RB, 50 MHz, QPSK, 30 kHz)	5G NR FR1 TDD	8.39	± 9.6 %
10825	AAD	5G NR (CP-OFDM, 100% RB, 60 MHz, QPSK, 30 kHz)	5G NR FR1 TDD	8.41	± 9.6 %
10827	AAD	5G NR (CP-OFDM, 100% RB, 80 MHz, QPSK, 30 kHz)	5G NR FR1 TDD	8.42	± 9.6 %
10828	AAE	5G NR (CP-OFDM, 100% RB, 90 MHz, QPSK, 30 kHz)	5G NR FR1 TDD	8.43	± 9.6 %
10829	AAD	5G NR (CP-OFDM, 100% RB, 100 MHz, QPSK, 30 kHz)	5G NR FR1 TDD	8.40	± 9.6 %
10830	AAD	5G NR (CP-OFDM, 1 RB, 10 MHz, QPSK, 60 kHz)	5G NR FR1 TDD	7.63	± 9.6 %
10831	AAD	5G NR (CP-OFDM, 1 RB, 15 MHz, QPSK, 60 kHz)	5G NR FR1 TDD	7.73	± 9.6 %
10832	AAD	5G NR (CP-OFDM, 1 RB, 20 MHz, QPSK, 60 kHz)	5G NR FR1 TDD	7.74	± 9.6 %
10833	AAD	5G NR (CP-OFDM, 1 RB, 25 MHz, QPSK, 60 kHz)	5G NR FR1 TDD	7.70	± 9.6 %
10834	AAD	5G NR (CP-OFDM, 1 RB, 30 MHz, QPSK, 60 kHz)	5G NR FR1 TDD	7.75	± 9.6 %
10835	AAD	5G NR (CP-OFDM, 1 RB, 40 MHz, QPSK, 60 kHz)	5G NR FR1 TDD	7.70	± 9.6 %
10836	AAE	5G NR (CP-OFDM, 1 RB, 50 MHz, QPSK, 60 kHz)	5G NR FR1 TDD	7.66	± 9.6 %
10837	AAD	5G NR (CP-OFDM, 1 RB, 60 MHz, QPSK, 60 kHz)	5G NR FR1 TDD	7.68	± 9.6 %
10839	AAD	5G NR (CP-OFDM, 1 RB, 80 MHz, QPSK, 60 kHz)	5G NR FR1 TDD	7.70	± 9.6 %
10840	AAD	5G NR (CP-OFDM, 1 RB, 90 MHz, QPSK, 60 kHz)	5G NR FR1 TDD	7.67	± 9.6 %
10841	AAD	5G NR (CP-OFDM, 1 RB, 100 MHz, QPSK, 60 kHz)	5G NR FR1 TDD	7.71	± 9.6 %
10843	AAD	5G NR (CP-OFDM, 50% RB, 15 MHz, QPSK, 60 kHz)	5G NR FR1 TDD	8.49	± 9.6 %
10844	AAD	5G NR (CP-OFDM, 50% RB, 20 MHz, QPSK, 60 kHz)	5G NR FR1 TDD	8.34	± 9.6 %
10846	AAD	5G NR (CP-OFDM, 50% RB, 30 MHz, QPSK, 60 kHz)	5G NR FR1 TDD	8.41	± 9.6 %
10854	AAD	5G NR (CP-OFDM, 100% RB, 10 MHz, QPSK, 60 kHz)	5G NR FR1 TDD	8.34	± 9.6 %
10855	AAD	5G NR (CP-OFDM, 100% RB, 15 MHz, QPSK, 60 kHz)	5G NR FR1 TDD	8.36	± 9.6 %
10856	AAD	5G NR (CP-OFDM, 100% RB, 20 MHz, QPSK, 60 kHz)	5G NR FR1 TDD	8.37	± 9.6 %
10857	AAD	5G NR (CP-OFDM, 100% RB, 25 MHz, QPSK, 60 kHz)	5G NR FR1 TDD	8.35	± 9.6 %
10858	AAD	5G NR (CP-OFDM, 100% RB, 30 MHz, QPSK, 60 kHz)	5G NR FR1 TDD	8.36	± 9.6 %
10859	AAD	5G NR (CP-OFDM, 100% RB, 40 MHz, QPSK, 60 kHz)	5G NR FR1 TDD	8.34	± 9.6 %

10860	AAD	5G NR (CP-OFDM, 100% RB, 50 MHz, QPSK, 60 kHz)	5G NR FR1 TDD	8.41	± 9.6 %
10861	AAD	5G NR (CP-OFDM, 100% RB, 60 MHz, QPSK, 60 kHz)	5G NR FR1 TDD	8.40	± 9.6 %
10863	AAD	5G NR (CP-OFDM, 100% RB, 80 MHz, QPSK, 60 kHz)	5G NR FR1 TDD	8.41	± 9.6 %
10864	AAE	5G NR (CP-OFDM, 100% RB, 90 MHz, QPSK, 60 kHz)	5G NR FR1 TDD	8.37	± 9.6 %
10865	AAD	5G NR (CP-OFDM, 100% RB, 100 MHz, QPSK, 60 kHz)	5G NR FR1 TDD	8.41	± 9.6 %
10866	AAD	5G NR (DFT-s-OFDM, 1 RB, 100 MHz, QPSK, 30 kHz)	5G NR FR1 TDD	5.68	± 9.6 %
10868	AAD	5G NR (DFT-s-OFDM, 100% RB, 100 MHz, QPSK, 30 kHz)	5G NR FR1 TDD	5.89	± 9.6 %
10869	AAD	5G NR (DFT-s-OFDM, 1 RB, 100 MHz, QPSK, 120 kHz)	5G NR FR2 TDD	5.75	± 9.6 %
10870	AAD	5G NR (DFT-s-OFDM, 100% RB, 100 MHz, QPSK, 120 kHz)	5G NR FR2 TDD	5.86	± 9.6 %
10871	AAD	5G NR (DFT-s-OFDM, 1 RB, 100 MHz, 16QAM, 120 kHz)	5G NR FR2 TDD	5.75	± 9.6 %
10872	AAD	5G NR (DFT-s-OFDM, 100% RB, 100 MHz, 16QAM, 120 kHz)	5G NR FR2 TDD	6.52	± 9.6 %
10873	AAD	5G NR (DFT-s-OFDM, 1 RB, 100 MHz, 64QAM, 120 kHz)	5G NR FR2 TDD	6.61	± 9.6 %
10874	AAD	5G NR (DFT-s-OFDM, 100% RB, 100 MHz, 64QAM, 120 kHz)	5G NR FR2 TDD	6.65	± 9.6 %
10875	AAD	5G NR (CP-OFDM, 1 RB, 100 MHz, QPSK, 120 kHz)	5G NR FR2 TDD	7.78	± 9.6 %
10876	AAD	5G NR (CP-OFDM, 100% RB, 100 MHz, QPSK, 120 kHz)	5G NR FR2 TDD	8.39	± 9.6 %
10877	AAD	5G NR (CP-OFDM, 1 RB, 100 MHz, 16QAM, 120 kHz)	5G NR FR2 TDD	7.95	± 9.6 %
10878	AAD	5G NR (CP-OFDM, 100% RB, 100 MHz, 16QAM, 120 kHz)	5G NR FR2 TDD	8.41	± 9.6 %
10879	AAD	5G NR (CP-OFDM, 1 RB, 100 MHz, 64QAM, 120 kHz)	5G NR FR2 TDD	8.12	± 9.6 %
10880	AAD	5G NR (CP-OFDM, 100% RB, 100 MHz, 64QAM, 120 kHz)	5G NR FR2 TDD	8.38	± 9.6 %
10881	AAD	5G NR (DFT-s-OFDM, 1 RB, 50 MHz, QPSK, 120 kHz)	5G NR FR2 TDD	5.75	± 9.6 %
10882	AAD	5G NR (DFT-s-OFDM, 100% RB, 50 MHz, QPSK, 120 kHz)	5G NR FR2 TDD	5.96	± 9.6 %
10883	AAD	5G NR (DFT-s-OFDM, 1 RB, 50 MHz, 16QAM, 120 kHz)	5G NR FR2 TDD	6.57	± 9.6 %
10884	AAD	5G NR (DFT-s-OFDM, 100% RB, 50 MHz, 16QAM, 120 kHz)	5G NR FR2 TDD	6.53	± 9.6 %
10885	AAD	5G NR (DFT-s-OFDM, 1 RB, 50 MHz, 64QAM, 120 kHz)	5G NR FR2 TDD	6.61	± 9.6 %
10886	AAD	5G NR (DFT-s-OFDM, 100% RB, 50 MHz, 64QAM, 120 kHz)	5G NR FR2 TDD	6.65	± 9.6 %
10887	AAD	5G NR (CP-OFDM, 1 RB, 50 MHz, QPSK, 120 kHz)	5G NR FR2 TDD	7.78	± 9.6 %
10888	AAD	5G NR (CP-OFDM, 100% RB, 50 MHz, QPSK, 120 kHz)	5G NR FR2 TDD	8.35	± 9.6 %
10889	AAD	5G NR (CP-OFDM, 1 RB, 50 MHz, 16QAM, 120 kHz)	5G NR FR2 TDD	8.02	± 9.6 %
10890	AAD	5G NR (CP-OFDM, 100% RB, 50 MHz, 16QAM, 120 kHz)	5G NR FR2 TDD	8.40	± 9.6 %
10891	AAD	5G NR (CP-OFDM, 1 RB, 50 MHz, 64QAM, 120 kHz)	5G NR FR2 TDD	8.13	± 9.6 %
10892	AAD	5G NR (CP-OFDM, 100% RB, 50 MHz, 64QAM, 120 kHz)	5G NR FR2 TDD	8.41	± 9.6 %
10897	AAD	5G NR (DFT-s-OFDM, 1 RB, 5 MHz, QPSK, 30 kHz)	5G NR FR1 TDD	5.66	± 9.6 %
10898	AAD	5G NR (DFT-s-OFDM, 1 RB, 10 MHz, QPSK, 30 kHz)	5G NR FR1 TDD	5.67	± 9.6 %
10899	AAD	5G NR (DFT-s-OFDM, 1 RB, 15 MHz, QPSK, 30 kHz)	5G NR FR1 TDD	5.67	± 9.6 %
10900	AAD	5G NR (DFT-s-OFDM, 1 RB, 20 MHz, QPSK, 30 kHz)	5G NR FR1 TDD	5.68	± 9.6 %
10901	AAD	5G NR (DFT-s-OFDM, 1 RB, 25 MHz, QPSK, 30 kHz)	5G NR FR1 TDD	5.68	± 9.6 %
10902	AAD	5G NR (DFT-s-OFDM, 1 RB, 30 MHz, QPSK, 30 kHz)	5G NR FR1 TDD	5.68	± 9.6 %
10903	AAD	5G NR (DFT-s-OFDM, 1 RB, 40 MHz, QPSK, 30 kHz)	5G NR FR1 TDD	5.68	± 9.6 %
10904	AAD	5G NR (DFT-s-OFDM, 1 RB, 50 MHz, QPSK, 30 kHz)	5G NR FR1 TDD	5.68	± 9.6 %
10905	AAD	5G NR (DFT-s-OFDM, 1 RB, 60 MHz, QPSK, 30 kHz)	5G NR FR1 TDD	5.68	± 9.6 %
10906	AAD	5G NR (DFT-s-OFDM, 1 RB, 80 MHz, QPSK, 30 kHz)	5G NR FR1 TDD	5.68	± 9.6 %
10907	AAD	5G NR (DFT-s-OFDM, 50% RB, 5 MHz, QPSK, 30 kHz)	5G NR FR1 TDD	5.78	± 9.6 %
10908	AAD	5G NR (DFT-s-OFDM, 50% RB, 10 MHz, QPSK, 30 kHz)	5G NR FR1 TDD	5.93	± 9.6 %
10909	AAD	5G NR (DFT-s-OFDM, 50% RB, 15 MHz, QPSK, 30 kHz)	5G NR FR1 TDD	5.96	± 9.6 %
10910	AAD	5G NR (DFT-s-OFDM, 50% RB, 20 MHz, QPSK, 30 kHz)	5G NR FR1 TDD	5.83	± 9.6 %
10911	AAD	5G NR (DFT-s-OFDM, 50% RB, 25 MHz, QPSK, 30 kHz)	5G NR FR1 TDD	5.93	± 9.6 %
10912	AAD	5G NR (DFT-s-OFDM, 50% RB, 30 MHz, QPSK, 30 kHz)	5G NR FR1 TDD	5.84	± 9.6 %
10913	AAD	5G NR (DFT-s-OFDM, 50% RB, 40 MHz, QPSK, 30 kHz)	5G NR FR1 TDD	5.84	± 9.6 %
10914	AAD	5G NR (DFT-s-OFDM, 50% RB, 50 MHz, QPSK, 30 kHz)	5G NR FR1 TDD	5.85	± 9.6 %
10915	AAD	5G NR (DFT-s-OFDM, 50% RB, 60 MHz, QPSK, 30 kHz)	5G NR FR1 TDD	5.83	± 9.6 %
10916	AAD	5G NR (DFT-s-OFDM, 50% RB, 80 MHz, QPSK, 30 kHz)	5G NR FR1 TDD	5.87	± 9.6 %
10917	AAD	5G NR (DFT-s-OFDM, 50% RB, 100 MHz, QPSK, 30 kHz)	5G NR FR1 TDD	5.94	± 9.6 %
10918	AAD	5G NR (DFT-s-OFDM, 100% RB, 5 MHz, QPSK, 30 kHz)	5G NR FR1 TDD	5.86	± 9.6 %
10919	AAD	5G NR (DFT-s-OFDM, 100% RB, 10 MHz, QPSK, 30 kHz)	5G NR FR1 TDD	5.86	± 9.6 %
10920	AAD	5G NR (DFT-s-OFDM, 100% RB, 15 MHz, QPSK, 30 kHz)	5G NR FR1 TDD	5.87	± 9.6 %
10921	AAD	5G NR (DFT-s-OFDM, 100% RB, 20 MHz, QPSK, 30 kHz)	5G NR FR1 TDD	5.84	± 9.6 %

10922	AAD	5G NR (DFT-s-OFDM, 100% RB, 25 MHz, QPSK, 30 kHz)	5G NR FR1 TDD	5.82	± 9.6 %
10923	AAD	5G NR (DFT-s-OFDM, 100% RB, 30 MHz, QPSK, 30 kHz)	5G NR FR1 TDD	5.84	± 9.6 %
10924	AAD	5G NR (DFT-s-OFDM, 100% RB, 40 MHz, QPSK, 30 kHz)	5G NR FR1 TDD	5.84	± 9.6 %
10925	AAD	5G NR (DFT-s-OFDM, 100% RB, 50 MHz, QPSK, 30 kHz)	5G NR FR1 TDD	5.95	± 9.6 %
10926	AAD	5G NR (DFT-s-OFDM, 100% RB, 60 MHz, QPSK, 30 kHz)	5G NR FR1 TDD	5.84	± 9.6 %
10927	AAD	5G NR (DFT-s-OFDM, 100% RB, 80 MHz, QPSK, 30 kHz)	5G NR FR1 TDD	5.94	± 9.6 %
10928	AAD	5G NR (DFT-s-OFDM, 1 RB, 5 MHz, QPSK, 15 kHz)	5G NR FR1 FDD	5.52	± 9.6 %
10929	AAD	5G NR (DFT-s-OFDM, 1 RB, 10 MHz, QPSK, 15 kHz)	5G NR FR1 FDD	5.52	± 9.6 %
10930	AAD	5G NR (DFT-s-OFDM, 1 RB, 15 MHz, QPSK, 15 kHz)	5G NR FR1 FDD	5.52	± 9.6 %
10931	AAD	5G NR (DFT-s-OFDM, 1 RB, 20 MHz, QPSK, 15 kHz)	5G NR FR1 FDD	5.51	± 9.6 %
10932	AAB	5G NR (DFT-s-OFDM, 1 RB, 25 MHz, QPSK, 15 kHz)	5G NR FR1 FDD	5.51	± 9.6 %
10933	AAA	5G NR (DFT-s-OFDM, 1 RB, 30 MHz, QPSK, 15 kHz)	5G NR FR1 FDD	5.51	± 9.6 %
10934	AAA	5G NR (DFT-s-OFDM, 1 RB, 40 MHz, QPSK, 15 kHz)	5G NR FR1 FDD	5.51	± 9.6 %
10935	AAA	5G NR (DFT-s-OFDM, 1 RB, 50 MHz, QPSK, 15 kHz)	5G NR FR1 FDD	5.51	± 9.6 %
10936	AAC	5G NR (DFT-s-OFDM, 50% RB, 5 MHz, QPSK, 15 kHz)	5G NR FR1 FDD	5.90	± 9.6 %
10937	AAB	5G NR (DFT-s-OFDM, 50% RB, 10 MHz, QPSK, 15 kHz)	5G NR FR1 FDD	5.77	± 9.6 %
10938	AAB	5G NR (DFT-s-OFDM, 50% RB, 15 MHz, QPSK, 15 kHz)	5G NR FR1 FDD	5.90	± 9.6 %
10939	AAB	5G NR (DFT-s-OFDM, 50% RB, 20 MHz, QPSK, 15 kHz)	5G NR FR1 FDD	5.82	± 9.6 %
10940	AAB	5G NR (DFT-s-OFDM, 50% RB, 25 MHz, QPSK, 15 kHz)	5G NR FR1 FDD	5.89	± 9.6 %
10941	AAB	5G NR (DFT-s-OFDM, 50% RB, 30 MHz, QPSK, 15 kHz)	5G NR FR1 FDD	5.83	± 9.6 %
10942	AAB	5G NR (DFT-s-OFDM, 50% RB, 40 MHz, QPSK, 15 kHz)	5G NR FR1 FDD	5.85	± 9.6 %
10943	AAB	5G NR (DFT-s-OFDM, 50% RB, 50 MHz, QPSK, 15 kHz)	5G NR FR1 FDD	5.95	± 9.6 %
10944	AAB	5G NR (DFT-s-OFDM, 100% RB, 5 MHz, QPSK, 15 kHz)	5G NR FR1 FDD	5.81	± 9.6 %
10945	AAB	5G NR (DFT-s-OFDM, 100% RB, 10 MHz, QPSK, 15 kHz)	5G NR FR1 FDD	5.85	± 9.6 %
10946	AAC	5G NR (DFT-s-OFDM, 100% RB, 15 MHz, QPSK, 15 kHz)	5G NR FR1 FDD	5.83	± 9.6 %
10947	AAB	5G NR (DFT-s-OFDM, 100% RB, 20 MHz, QPSK, 15 kHz)	5G NR FR1 FDD	5.87	± 9.6 %
10948	AAB	5G NR (DFT-s-OFDM, 100% RB, 25 MHz, QPSK, 15 kHz)	5G NR FR1 FDD	5.94	± 9.6 %
10949	AAB	5G NR (DFT-s-OFDM, 100% RB, 30 MHz, QPSK, 15 kHz)	5G NR FR1 FDD	5.87	± 9.6 %
10950	AAB	5G NR (DFT-s-OFDM, 100% RB, 40 MHz, QPSK, 15 kHz)	5G NR FR1 FDD	5.94	± 9.6 %
10951	AAB	5G NR (DFT-s-OFDM, 100% RB, 50 MHz, QPSK, 15 kHz)	5G NR FR1 FDD	5.92	± 9.6 %
10952	AAB	5G NR DL (CP-OFDM, TM 3.1, 5 MHz, 64-QAM, 15 kHz)	5G NR FR1 FDD	8.25	± 9.6 %
10953	AAB	5G NR DL (CP-OFDM, TM 3.1, 10 MHz, 64-QAM, 15 kHz)	5G NR FR1 FDD	8.15	± 9.6 %
10954	AAB	5G NR DL (CP-OFDM, TM 3.1, 15 MHz, 64-QAM, 15 kHz)	5G NR FR1 FDD	8.23	± 9.6 %
10955	AAB	5G NR DL (CP-OFDM, TM 3.1, 20 MHz, 64-QAM, 15 kHz)	5G NR FR1 FDD	8.42	± 9.6 %
10956	AAB	5G NR DL (CP-OFDM, TM 3.1, 5 MHz, 64-QAM, 30 kHz)	5G NR FR1 FDD	8.14	± 9.6 %
10957	AAC	5G NR DL (CP-OFDM, TM 3.1, 10 MHz, 64-QAM, 30 kHz)	5G NR FR1 FDD	8.31	± 9.6 %
10958	AAB	5G NR DL (CP-OFDM, TM 3.1, 15 MHz, 64-QAM, 30 kHz)	5G NR FR1 FDD	8.61	± 9.6 %
10959	AAB	5G NR DL (CP-OFDM, TM 3.1, 20 MHz, 64-QAM, 30 kHz)	5G NR FR1 FDD	8.33	± 9.6 %
10960	AAB	5G NR DL (CP-OFDM, TM 3.1, 5 MHz, 64-QAM, 15 kHz)	5G NR FR1 TDD	9.32	± 9.6 %
10961	AAB	5G NR DL (CP-OFDM, TM 3.1, 10 MHz, 64-QAM, 15 kHz)	5G NR FR1 TDD	9.36	± 9.6 %
10962	AAB	5G NR DL (CP-OFDM, TM 3.1, 15 MHz, 64-QAM, 15 kHz)	5G NR FR1 TDD	9.40	± 9.6 %
10963	AAB	5G NR DL (CP-OFDM, TM 3.1, 20 MHz, 64-QAM, 15 kHz)	5G NR FR1 TDD	9.55	± 9.6 %
10964	AAB	5G NR DL (CP-OFDM, TM 3.1, 5 MHz, 64-QAM, 30 kHz)	5G NR FR1 TDD	9.29	± 9.6 %
10965	AAB	5G NR DL (CP-OFDM, TM 3.1, 10 MHz, 64-QAM, 30 kHz)	5G NR FR1 TDD	9.37	± 9.6 %
10966	AAB	5G NR DL (CP-OFDM, TM 3.1, 15 MHz, 64-QAM, 30 kHz)	5G NR FR1 TDD	9.55	± 9.6 %
10967	AAB	5G NR DL (CP-OFDM, TM 3.1, 20 MHz, 64-QAM, 30 kHz)	5G NR FR1 TDD	9.42	± 9.6 %
10968	AAB	5G NR DL (CP-OFDM, TM 3.1, 100 MHz, 64-QAM, 30 kHz)	5G NR FR1 TDD	9.49	± 9.6 %
10972	AAB	5G NR (CP-OFDM, 1 RB, 20 MHz, QPSK, 15 kHz)	5G NR FR1 TDD	11.59	± 9.6 %
10973	AAB	5G NR (DFT-s-OFDM, 1 RB, 100 MHz, QPSK, 30 kHz)	5G NR FR1 TDD	9.06	± 9.6 %
10974	AAB	5G NR (CP-OFDM, 100% RB, 100 MHz, 256-QAM, 30 kHz)	5G NR FR1 TDD	10.28	± 9.6 %

^ε Uncertainty is determined using the max. deviation from linear response applying rectangular distribution and is expressed for the square of the field value.



Accredited by the Swiss Accreditation Service (SAS)
The Swiss Accreditation Service is one of the signatories to the EA
Multilateral Agreement for the recognition of calibration certificates

Accreditation No.: **SCS 0108**

Client **B.V. ADT (Auden)**

Certificate No: **EX3-3971_Jan22**

CALIBRATION CERTIFICATE

Object **EX3DV4 - SN:3971**

Calibration procedure(s) **QA CAL-01.v9, QA CAL-14.v6, QA CAL-23.v5, QA CAL-25.v7
Calibration procedure for dosimetric E-field probes**

Calibration date: **January 25, 2022**

This calibration certificate documents the traceability to national standards, which realize the physical units of measurements (SI).
The measurements and the uncertainties with confidence probability are given on the following pages and are part of the certificate.

All calibrations have been conducted in the closed laboratory facility: environment temperature (22 ± 3)°C and humidity < 70%.

Calibration Equipment used (M&TE critical for calibration)

Primary Standards	ID	Cal Date (Certificate No.)	Scheduled Calibration
Power meter NRP	SN: 104778	09-Apr-21 (No. 217-03291/03292)	Apr-22
Power sensor NRP-Z91	SN: 103244	09-Apr-21 (No. 217-03291)	Apr-22
Power sensor NRP-Z91	SN: 103245	09-Apr-21 (No. 217-03292)	Apr-22
Reference 20 dB Attenuator	SN: CC2552 (20x)	09-Apr-21 (No. 217-03343)	Apr-22
DAE4	SN: 660	13-Oct-21 (No. DAE4-660_Oct21)	Oct-22
Reference Probe ES3DV2	SN: 3013	27-Dec-21 (No. ES3-3013_Dec21)	Dec-22
Secondary Standards	ID	Check Date (in house)	Scheduled Check
Power meter E4419B	SN: GB41293874	06-Apr-16 (in house check Jun-20)	In house check: Jun-22
Power sensor E4412A	SN: MY41498087	06-Apr-16 (in house check Jun-20)	In house check: Jun-22
Power sensor E4412A	SN: 000110210	06-Apr-16 (in house check Jun-20)	In house check: Jun-22
RF generator HP 8648C	SN: US3642U01700	04-Aug-99 (in house check Jun-20)	In house check: Jun-22
Network Analyzer E8358A	SN: US41080477	31-Mar-14 (in house check Oct-20)	In house check: Oct-22

Calibrated by:	Name Leif Klysner	Function Laboratory Technician	Signature
Approved by:	Name Sven Kühn	Deputy Manager	
			Issued: February 1, 2022
This calibration certificate shall not be reproduced except in full without written approval of the laboratory.			



Accredited by the Swiss Accreditation Service (SAS)

Accreditation No.: **SCS 0108**

The Swiss Accreditation Service is one of the signatories to the EA
Multilateral Agreement for the recognition of calibration certificates

Glossary:

TSL	tissue simulating liquid
NORM _{x,y,z}	sensitivity in free space
ConvF	sensitivity in TSL / NORM _{x,y,z}
DCP	diode compression point
CF	crest factor (1/duty_cycle) of the RF signal
A, B, C, D	modulation dependent linearization parameters
Polarization φ	φ rotation around probe axis
Polarization ϑ	ϑ rotation around an axis that is in the plane normal to probe axis (at measurement center), i.e., $\vartheta = 0$ is normal to probe axis
Connector Angle	information used in DASY system to align probe sensor X to the robot coordinate system

Calibration is Performed According to the Following Standards:

- IEC/IEEE 62209-1528, "Measurement Procedure For The Assessment Of Specific Absorption Rate Of Human Exposure To Radio Frequency Fields From Hand-Held And Body-Worn Wireless Communication Devices - Part 1528: Human Models, Instrumentation And Procedures (Frequency Range of 4 MHz to 10 GHz)", October 2020.
- KDB 865664, "SAR Measurement Requirements for 100 MHz to 6 GHz"

Methods Applied and Interpretation of Parameters:

- NORM_{x,y,z}**: Assessed for E-field polarization $\vartheta = 0$ ($f \leq 900$ MHz in TEM-cell; $f > 1800$ MHz: R22 waveguide). NORM_{x,y,z} are only intermediate values, i.e., the uncertainties of NORM_{x,y,z} does not affect the E²-field uncertainty inside TSL (see below ConvF).
- NORM(f)_{x,y,z}** = NORM_{x,y,z} * frequency_response (see Frequency Response Chart). This linearization is implemented in DASY4 software versions later than 4.2. The uncertainty of the frequency response is included in the stated uncertainty of ConvF.
- DCP_{x,y,z}**: DCP are numerical linearization parameters assessed based on the data of power sweep with CW signal (no uncertainty required). DCP does not depend on frequency nor media.
- PAR**: PAR is the Peak to Average Ratio that is not calibrated but determined based on the signal characteristics
- A_{x,y,z}; B_{x,y,z}; C_{x,y,z}; D_{x,y,z}; VR_{x,y,z}**: A, B, C, D are numerical linearization parameters assessed based on the data of power sweep for specific modulation signal. The parameters do not depend on frequency nor media. VR is the maximum calibration range expressed in RMS voltage across the diode.
- ConvF and Boundary Effect Parameters**: Assessed in flat phantom using E-field (or Temperature Transfer Standard for $f \leq 800$ MHz) and inside waveguide using analytical field distributions based on power measurements for $f > 800$ MHz. The same setups are used for assessment of the parameters applied for boundary compensation (alpha, depth) of which typical uncertainty values are given. These parameters are used in DASY4 software to improve probe accuracy close to the boundary. The sensitivity in TSL corresponds to NORM_{x,y,z} * ConvF whereby the uncertainty corresponds to that given for ConvF. A frequency dependent ConvF is used in DASY version 4.4 and higher which allows extending the validity from ± 50 MHz to ± 100 MHz.
- Spherical isotropy (3D deviation from isotropy)**: in a field of low gradients realized using a flat phantom exposed by a patch antenna.
- Sensor Offset**: The sensor offset corresponds to the offset of virtual measurement center from the probe tip (on probe axis). No tolerance required.
- Connector Angle**: The angle is assessed using the information gained by determining the NORM_x (no uncertainty required).

DASY/EASY - Parameters of Probe: EX3DV4 - SN:3971

Basic Calibration Parameters

	Sensor X	Sensor Y	Sensor Z	Unc (k=2)
Norm ($\mu\text{V}/(\text{V}/\text{m})^2$) ^A	0.40	0.51	0.49	$\pm 10.1 \%$
DCP (mV) ^B	101.3	101.7	97.7	

Calibration Results for Modulation Response

UID	Communication System Name		A dB	B dB/ μV	C	D dB	VR mV	Max dev.	Max Unc ^E (k=2)
0	CW	X	0.00	0.00	1.00	0.00	132.6	$\pm 3.8 \%$	$\pm 4.7 \%$
		Y	0.00	0.00	1.00		139.6		
		Z	0.00	0.00	1.00		144.7		
10352-AAA	Pulse Waveform (200Hz, 10%)	X	6.47	76.37	15.24	10.00	60.0	$\pm 4.1 \%$	$\pm 9.6 \%$
		Y	84.00	108.00	25.00		60.0		
		Z	20.00	92.12	20.92		60.0		
10353-AAA	Pulse Waveform (200Hz, 20%)	X	20.00	88.61	17.68	6.99	80.0	$\pm 2.4 \%$	$\pm 9.6 \%$
		Y	20.00	93.20	20.53		80.0		
		Z	20.00	94.01	20.91		80.0		
10354-AAA	Pulse Waveform (200Hz, 40%)	X	20.00	90.87	17.27	3.98	95.0	$\pm 1.3 \%$	$\pm 9.6 \%$
		Y	20.00	96.62	20.67		95.0		
		Z	20.00	99.28	22.18		95.0		
10355-AAA	Pulse Waveform (200Hz, 60%)	X	20.00	96.70	18.63	2.22	120.0	$\pm 1.2 \%$	$\pm 9.6 \%$
		Y	20.00	99.05	20.38		120.0		
		Z	20.00	106.51	24.16		120.0		
10387-AAA	QPSK Waveform, 1 MHz	X	1.96	70.97	17.28	1.00	150.0	$\pm 2.7 \%$	$\pm 9.6 \%$
		Y	1.58	64.72	14.19		150.0		
		Z	1.73	66.54	15.35		150.0		
10388-AAA	QPSK Waveform, 10 MHz	X	2.43	70.64	17.44	0.00	150.0	$\pm 0.8 \%$	$\pm 9.6 \%$
		Y	2.08	66.70	14.90		150.0		
		Z	2.33	68.74	16.11		150.0		
10396-AAA	64-QAM Waveform, 100 kHz	X	2.78	71.56	19.69	3.01	150.0	$\pm 0.9 \%$	$\pm 9.6 \%$
		Y	3.10	71.27	19.02		150.0		
		Z	3.12	71.37	19.23		150.0		
10399-AAA	64-QAM Waveform, 40 MHz	X	3.58	67.93	16.50	0.00	150.0	$\pm 1.9 \%$	$\pm 9.6 \%$
		Y	3.41	66.49	15.35		150.0		
		Z	3.58	67.43	15.98		150.0		
10414-AAA	WLAN CCDF, 64-QAM, 40MHz	X	4.80	66.01	15.98	0.00	150.0	$\pm 3.8 \%$	$\pm 9.6 \%$
		Y	4.82	65.29	15.28		150.0		
		Z	4.94	65.80	15.67		150.0		

Note: For details on UID parameters see Appendix

The reported uncertainty of measurement is stated as the standard uncertainty of measurement multiplied by the coverage factor $k=2$, which for a normal distribution corresponds to a coverage probability of approximately 95%.

^A The uncertainties of Norm X,Y,Z do not affect the E^2 -field uncertainty inside TSL (see Pages 5 and 6).

^B Numerical linearization parameter: uncertainty not required.

^E Uncertainty is determined using the max. deviation from linear response applying rectangular distribution and is expressed for the square of the field value.

DASY/EASY - Parameters of Probe: EX3DV4 - SN:3971

Sensor Model Parameters

	C1 fF	C2 fF	α V^{-1}	T1 $ms.V^{-2}$	T2 $ms.V^{-1}$	T3 ms	T4 V^{-2}	T5 V^{-1}	T6
X	35.6	271.08	37.06	8.11	0.37	5.02	1.43	0.10	1.00
Y	50.2	375.80	35.63	11.73	0.26	5.08	1.59	0.23	1.01
Z	49.3	370.19	35.93	15.60	0.00	5.10	1.02	0.33	1.01

Other Probe Parameters

Sensor Arrangement	Triangular
Connector Angle (°)	-109
Mechanical Surface Detection Mode	enabled
Optical Surface Detection Mode	disabled
Probe Overall Length	337 mm
Probe Body Diameter	10 mm
Tip Length	9 mm
Tip Diameter	2.5 mm
Probe Tip to Sensor X Calibration Point	1 mm
Probe Tip to Sensor Y Calibration Point	1 mm
Probe Tip to Sensor Z Calibration Point	1 mm
Recommended Measurement Distance from Surface	1.4 mm

Note: Measurement distance from surface can be increased to 3-4 mm for an *Area Scan* job.

DASY/EASY - Parameters of Probe: EX3DV4 - SN:3971

Calibration Parameter Determined in Head Tissue Simulating Media

f (MHz) ^C	Relative Permittivity ^F	Conductivity (S/m) ^F	ConvF X	ConvF Y	ConvF Z	Alpha ^G	Depth ^G (mm)	Unc (k=2)
750	41.9	0.89	10.26	10.26	10.26	0.39	1.05	± 12.0 %
835	41.5	0.90	10.02	10.02	10.02	0.28	1.20	± 12.0 %
1450	40.5	1.20	8.89	8.89	8.89	0.42	0.80	± 12.0 %
1750	40.1	1.37	8.72	8.72	8.72	0.22	0.86	± 12.0 %
1900	40.0	1.40	8.33	8.33	8.33	0.27	0.86	± 12.0 %
2000	40.0	1.40	8.15	8.15	8.15	0.31	0.86	± 12.0 %
2300	39.5	1.67	8.13	8.13	8.13	0.27	0.90	± 12.0 %
2450	39.2	1.80	7.98	7.98	7.98	0.14	0.90	± 12.0 %
2600	39.0	1.96	7.73	7.73	7.73	0.12	0.90	± 12.0 %
3300	38.2	2.71	7.14	7.14	7.14	0.35	1.30	± 13.1 %
3500	37.9	2.91	6.80	6.80	6.80	0.35	1.30	± 13.1 %
3700	37.7	3.12	6.68	6.68	6.68	0.40	1.35	± 13.1 %
3900	37.5	3.32	6.61	6.61	6.61	0.40	1.60	± 13.1 %
4100	37.2	3.53	6.35	6.35	6.35	0.40	1.60	± 13.1 %
4200	37.1	3.63	6.34	6.34	6.34	0.40	1.70	± 13.1 %
4400	36.9	3.84	6.28	6.28	6.28	0.40	1.70	± 13.1 %
4600	36.7	4.04	6.21	6.21	6.21	0.40	1.70	± 13.1 %
4800	36.4	4.25	6.16	6.16	6.16	0.40	1.70	± 13.1 %
4950	36.3	4.40	5.85	5.85	5.85	0.40	1.80	± 13.1 %
5250	35.9	4.71	5.10	5.10	5.10	0.40	1.80	± 13.1 %
5600	35.5	5.07	4.80	4.80	4.80	0.40	1.80	± 13.1 %
5750	35.4	5.22	4.85	4.85	4.85	0.40	1.80	± 13.1 %

^C Frequency validity above 300 MHz of ± 100 MHz only applies for DASY v4.4 and higher (see Page 2), else it is restricted to ± 50 MHz. The uncertainty is the RSS of the ConvF uncertainty at calibration frequency and the uncertainty for the indicated frequency band. Frequency validity below 300 MHz is ± 10, 25, 40, 50 and 70 MHz for ConvF assessments at 30, 64, 128, 150 and 220 MHz respectively. Validity of ConvF assessed at 6 MHz is 4-9 MHz, and ConvF assessed at 13 MHz is 9-19 MHz. Above 5 GHz frequency validity can be extended to ± 110 MHz.

^F At frequencies below 3 GHz, the validity of tissue parameters (ϵ and σ) can be relaxed to ± 10% if liquid compensation formula is applied to measured SAR values. At frequencies above 3 GHz, the validity of tissue parameters (ϵ and σ) is restricted to ± 5%. The uncertainty is the RSS of the ConvF uncertainty for indicated target tissue parameters.

^G Alpha/Depth are determined during calibration. SPEAG warrants that the remaining deviation due to the boundary effect after compensation is always less than ± 1% for frequencies below 3 GHz and below ± 2% for frequencies between 3-6 GHz at any distance larger than half the probe tip diameter from the boundary.

DASY/EASY - Parameters of Probe: EX3DV4 - SN:3971

Calibration Parameter Determined in Head Tissue Simulating Media

f (MHz) ^C	Relative Permittivity ^F	Conductivity (S/m) ^F	ConvF X	ConvF Y	ConvF Z	Alpha ^G	Depth ^G (mm)	Unc (k=2)
6500	34.5	6.07	5.45	5.45	5.45	0.20	2.50	± 18.6 %

^C Frequency validity above 6GHz is ± 700 MHz. The uncertainty is the RSS of the ConvF uncertainty at calibration frequency and the uncertainty for the indicated frequency band.

^F At frequencies 6-10 GHz, the validity of tissue parameters (ϵ and σ) can be relaxed to ± 10% if liquid compensation formula is applied to measured SAR values. The uncertainty is the RSS of the ConvF uncertainty for indicated target tissue parameters.

^G Alpha/Depth are determined during calibration. SPEAG warrants that the remaining deviation due to the boundary effect after compensation is always less than ± 1% for frequencies below 3 GHz; below ± 2% for frequencies between 3-6 GHz; and below ± 4% for frequencies between 6-10 GHz at any distance larger than half the probe tip diameter from the boundary.

Frequency Response of E-Field (TEM-Cell:ifi110 EXX, Waveguide: R22)

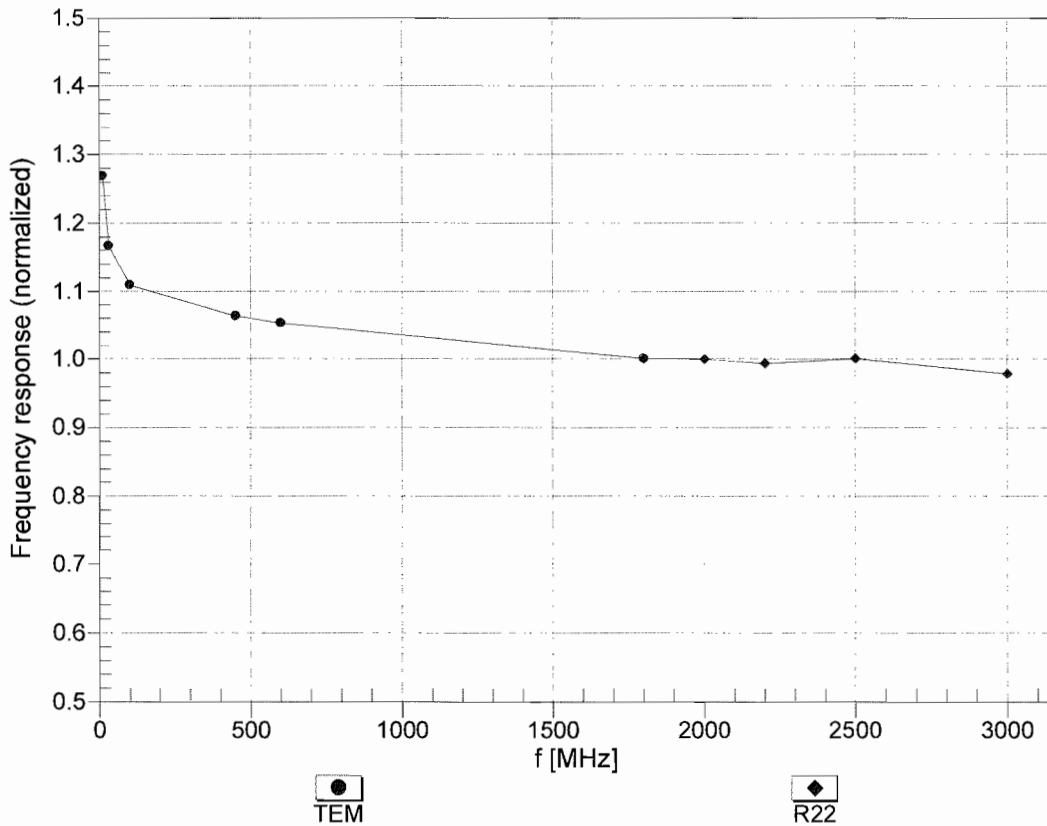

Uncertainty of Frequency Response of E-field: $\pm 6.3\%$ (k=2)

Receiving Pattern (ϕ), $\theta = 0^\circ$

f=600 MHz,TEM

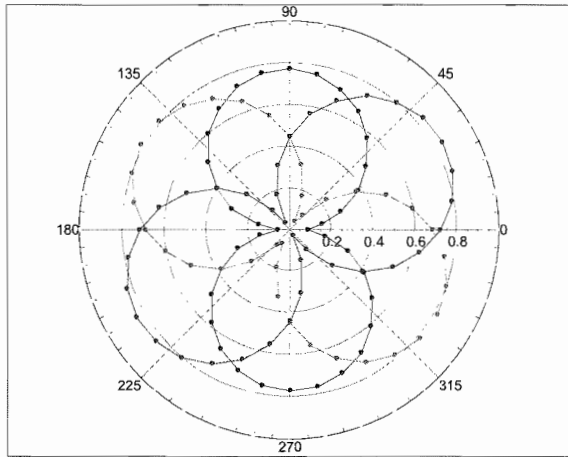

f=1800 MHz,R22

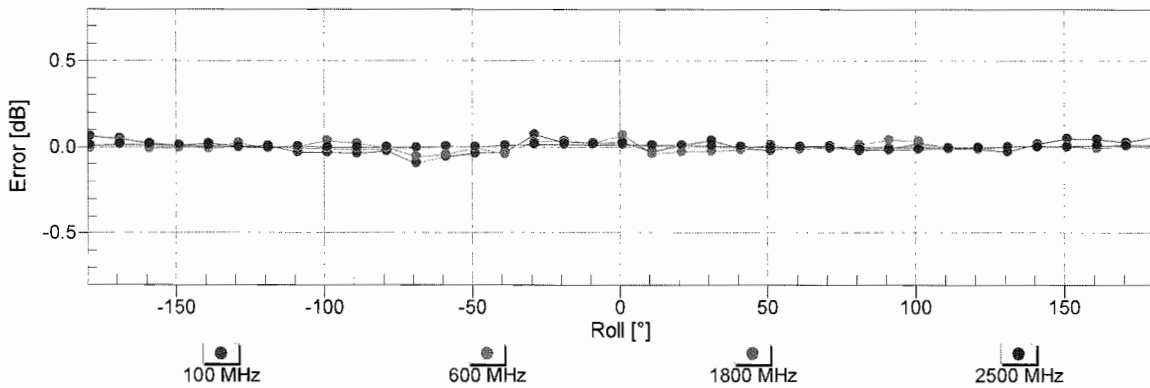
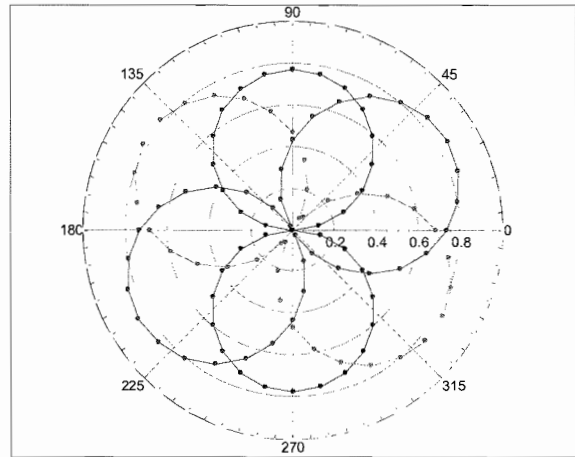

Uncertainty of Axial Isotropy Assessment: $\pm 0.5\%$ ($k=2$)

Dynamic Range $f(SAR_{head})$ (TEM cell , $f_{eval}= 1900$ MHz)

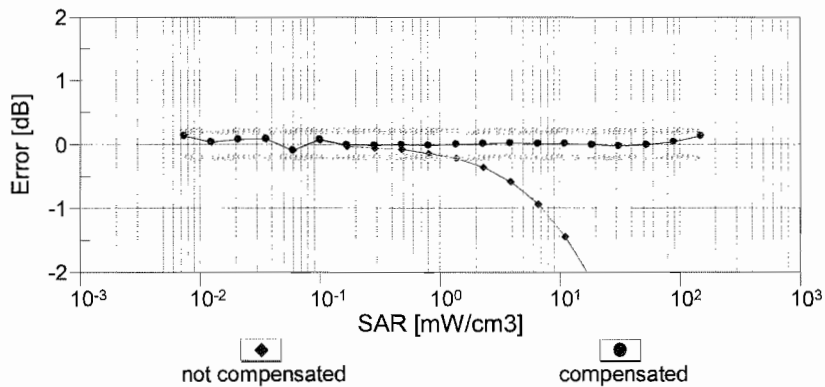
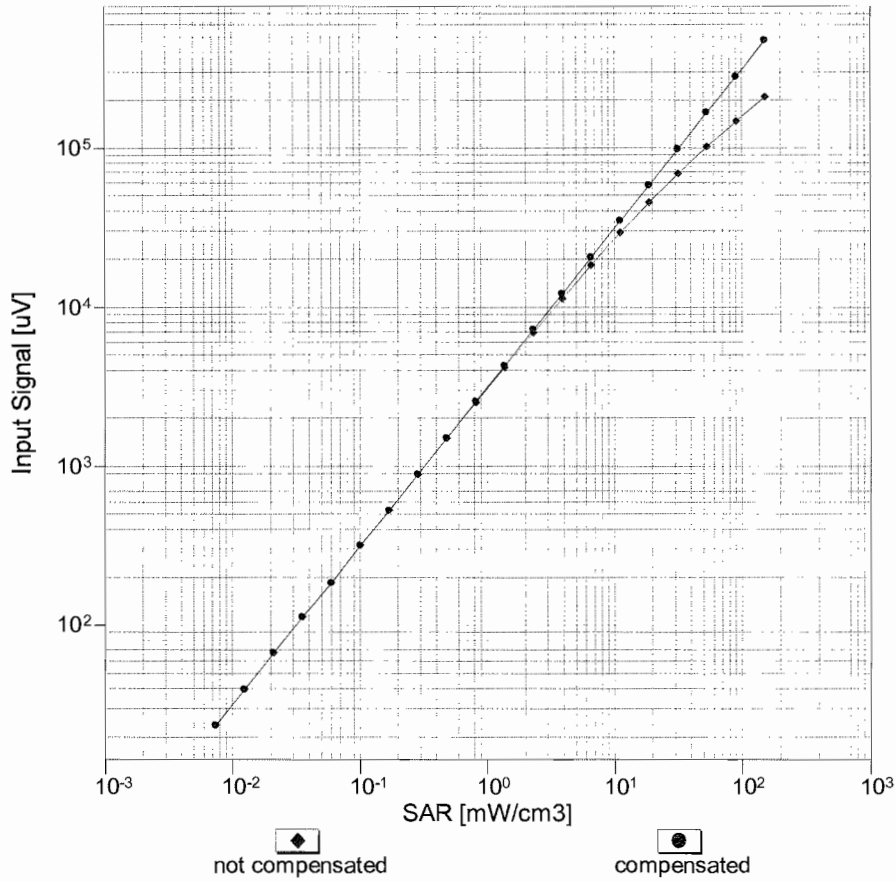

Uncertainty of Linearity Assessment: ± 0.6% (k=2)

Conversion Factor Assessment

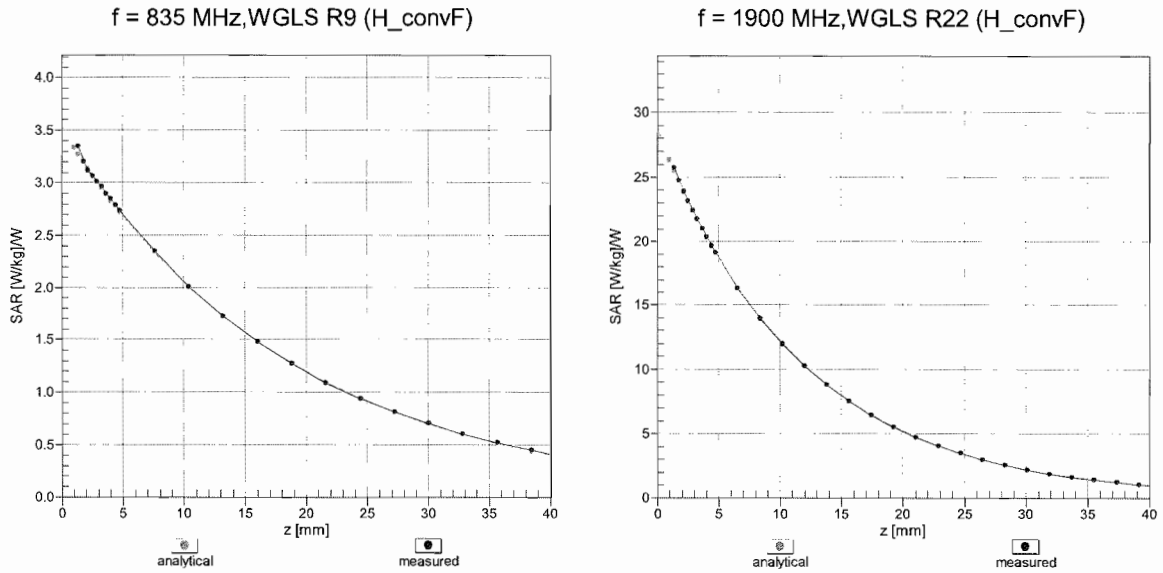

Deviation from Isotropy in Liquid Error (ϕ, ϑ), f = 900 MHz

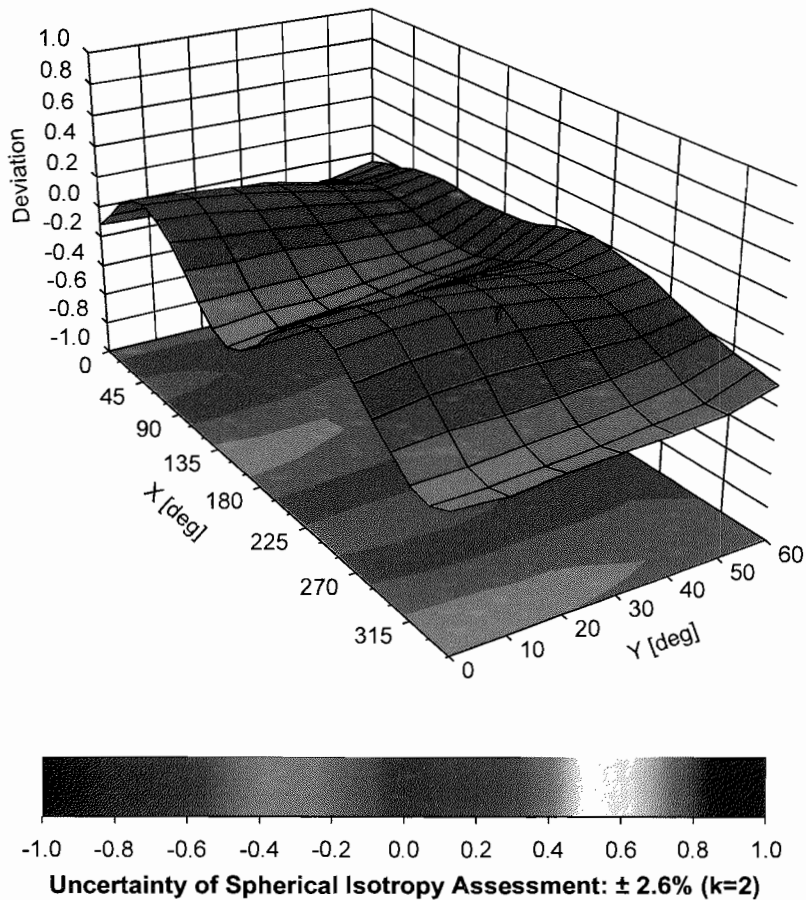

Appendix: Modulation Calibration Parameters

UID	Rev	Communication System Name	Group	PAR (dB)	Unc ^F (k=2)
0	-	CW	CW	0.00	± 4.7 %
10010	CAA	SAR Validation (Square, 100ms, 10ms)	Test	10.00	± 9.6 %
10011	CAB	UMTS-FDD (WCDMA)	WCDMA	2.91	± 9.6 %
10012	CAB	IEEE 802.11b WiFi 2.4 GHz (DSSS, 1 Mbps)	WLAN	1.87	± 9.6 %
10013	CAB	IEEE 802.11g WiFi 2.4 GHz (DSSS-OFDM, 6 Mbps)	WLAN	9.46	± 9.6 %
10021	DAC	GSM-FDD (TDMA, GMSK)	GSM	9.39	± 9.6 %
10023	DAC	GPRS-FDD (TDMA, GMSK, TN 0)	GSM	9.57	± 9.6 %
10024	DAC	GPRS-FDD (TDMA, GMSK, TN 0-1)	GSM	6.56	± 9.6 %
10025	DAC	EDGE-FDD (TDMA, 8PSK, TN 0)	GSM	12.62	± 9.6 %
10026	DAC	EDGE-FDD (TDMA, 8PSK, TN 0-1)	GSM	9.55	± 9.6 %
10027	DAC	GPRS-FDD (TDMA, GMSK, TN 0-1-2)	GSM	4.80	± 9.6 %
10028	DAC	GPRS-FDD (TDMA, GMSK, TN 0-1-2-3)	GSM	3.55	± 9.6 %
10029	DAC	EDGE-FDD (TDMA, 8PSK, TN 0-1-2)	GSM	7.78	± 9.6 %
10030	CAA	IEEE 802.15.1 Bluetooth (GFSK, DH1)	Bluetooth	5.30	± 9.6 %
10031	CAA	IEEE 802.15.1 Bluetooth (GFSK, DH3)	Bluetooth	1.87	± 9.6 %
10032	CAA	IEEE 802.15.1 Bluetooth (GFSK, DH5)	Bluetooth	1.16	± 9.6 %
10033	CAA	IEEE 802.15.1 Bluetooth (PI/4-DQPSK, DH1)	Bluetooth	7.74	± 9.6 %
10034	CAA	IEEE 802.15.1 Bluetooth (PI/4-DQPSK, DH3)	Bluetooth	4.53	± 9.6 %
10035	CAA	IEEE 802.15.1 Bluetooth (PI/4-DQPSK, DH5)	Bluetooth	3.83	± 9.6 %
10036	CAA	IEEE 802.15.1 Bluetooth (8-DPSK, DH1)	Bluetooth	8.01	± 9.6 %
10037	CAA	IEEE 802.15.1 Bluetooth (8-DPSK, DH3)	Bluetooth	4.77	± 9.6 %
10038	CAA	IEEE 802.15.1 Bluetooth (8-DPSK, DH5)	Bluetooth	4.10	± 9.6 %
10039	CAB	CDMA2000 (1xRTT, RC1)	CDMA2000	4.57	± 9.6 %
10042	CAB	IS-54 / IS-136 FDD (TDMA/FDM, PI/4-DQPSK, Halfrate)	AMPS	7.78	± 9.6 %
10044	CAA	IS-91/EIA/TIA-553 FDD (FDMA, FM)	AMPS	0.00	± 9.6 %
10048	CAA	DECT (TDD, TDMA/FDM, GFSK, Full Slot, 24)	DECT	13.80	± 9.6 %
10049	CAA	DECT (TDD, TDMA/FDM, GFSK, Double Slot, 12)	DECT	10.79	± 9.6 %
10056	CAA	UMTS-TDD (TD-SCDMA, 1.28 Mcps)	TD-SCDMA	11.01	± 9.6 %
10058	DAC	EDGE-FDD (TDMA, 8PSK, TN 0-1-2-3)	GSM	6.52	± 9.6 %
10059	CAB	IEEE 802.11b WiFi 2.4 GHz (DSSS, 2 Mbps)	WLAN	2.12	± 9.6 %
10060	CAB	IEEE 802.11b WiFi 2.4 GHz (DSSS, 5.5 Mbps)	WLAN	2.83	± 9.6 %
10061	CAB	IEEE 802.11b WiFi 2.4 GHz (DSSS, 11 Mbps)	WLAN	3.60	± 9.6 %
10062	CAD	IEEE 802.11a/h WiFi 5 GHz (OFDM, 6 Mbps)	WLAN	8.68	± 9.6 %
10063	CAD	IEEE 802.11a/h WiFi 5 GHz (OFDM, 9 Mbps)	WLAN	8.63	± 9.6 %
10064	CAD	IEEE 802.11a/h WiFi 5 GHz (OFDM, 12 Mbps)	WLAN	9.09	± 9.6 %
10065	CAD	IEEE 802.11a/h WiFi 5 GHz (OFDM, 18 Mbps)	WLAN	9.00	± 9.6 %
10066	CAD	IEEE 802.11a/h WiFi 5 GHz (OFDM, 24 Mbps)	WLAN	9.38	± 9.6 %
10067	CAD	IEEE 802.11a/h WiFi 5 GHz (OFDM, 36 Mbps)	WLAN	10.12	± 9.6 %
10068	CAD	IEEE 802.11a/h WiFi 5 GHz (OFDM, 48 Mbps)	WLAN	10.24	± 9.6 %
10069	CAD	IEEE 802.11a/h WiFi 5 GHz (OFDM, 54 Mbps)	WLAN	10.56	± 9.6 %
10071	CAB	IEEE 802.11g WiFi 2.4 GHz (DSSS/OFDM, 9 Mbps)	WLAN	9.83	± 9.6 %
10072	CAB	IEEE 802.11g WiFi 2.4 GHz (DSSS/OFDM, 12 Mbps)	WLAN	9.62	± 9.6 %
10073	CAB	IEEE 802.11g WiFi 2.4 GHz (DSSS/OFDM, 18 Mbps)	WLAN	9.94	± 9.6 %
10074	CAB	IEEE 802.11g WiFi 2.4 GHz (DSSS/OFDM, 24 Mbps)	WLAN	10.30	± 9.6 %
10075	CAB	IEEE 802.11g WiFi 2.4 GHz (DSSS/OFDM, 36 Mbps)	WLAN	10.77	± 9.6 %
10076	CAB	IEEE 802.11g WiFi 2.4 GHz (DSSS/OFDM, 48 Mbps)	WLAN	10.94	± 9.6 %
10077	CAB	IEEE 802.11g WiFi 2.4 GHz (DSSS/OFDM, 54 Mbps)	WLAN	11.00	± 9.6 %
10081	CAB	CDMA2000 (1xRTT, RC3)	CDMA2000	3.97	± 9.6 %
10082	CAB	IS-54 / IS-136 FDD (TDMA/FDM, PI/4-DQPSK, Fullrate)	AMPS	4.77	± 9.6 %
10090	DAC	GPRS-FDD (TDMA, GMSK, TN 0-4)	GSM	6.56	± 9.6 %
10097	CAB	UMTS-FDD (HSDPA)	WCDMA	3.98	± 9.6 %
10098	CAB	UMTS-FDD (HSUPA, Subtest 2)	WCDMA	3.98	± 9.6 %
10099	DAC	EDGE-FDD (TDMA, 8PSK, TN 0-4)	GSM	9.55	± 9.6 %

10100	CAE	LTE-FDD (SC-FDMA, 100% RB, 20 MHz, QPSK)	LTE-FDD	5.67	± 9.6 %
10101	CAE	LTE-FDD (SC-FDMA, 100% RB, 20 MHz, 16-QAM)	LTE-FDD	6.42	± 9.6 %
10102	CAE	LTE-FDD (SC-FDMA, 100% RB, 20 MHz, 64-QAM)	LTE-FDD	6.60	± 9.6 %
10103	CAG	LTE-TDD (SC-FDMA, 100% RB, 20 MHz, QPSK)	LTE-TDD	9.29	± 9.6 %
10104	CAG	LTE-TDD (SC-FDMA, 100% RB, 20 MHz, 16-QAM)	LTE-TDD	9.97	± 9.6 %
10105	CAG	LTE-TDD (SC-FDMA, 100% RB, 20 MHz, 64-QAM)	LTE-TDD	10.01	± 9.6 %
10108	CAG	LTE-FDD (SC-FDMA, 100% RB, 10 MHz, QPSK)	LTE-FDD	5.80	± 9.6 %
10109	CAG	LTE-FDD (SC-FDMA, 100% RB, 10 MHz, 16-QAM)	LTE-FDD	6.43	± 9.6 %
10110	CAG	LTE-FDD (SC-FDMA, 100% RB, 5 MHz, QPSK)	LTE-FDD	5.75	± 9.6 %
10111	CAG	LTE-FDD (SC-FDMA, 100% RB, 5 MHz, 16-QAM)	LTE-FDD	6.44	± 9.6 %
10112	CAG	LTE-FDD (SC-FDMA, 100% RB, 10 MHz, 64-QAM)	LTE-FDD	6.59	± 9.6 %
10113	CAG	LTE-FDD (SC-FDMA, 100% RB, 5 MHz, 64-QAM)	LTE-FDD	6.62	± 9.6 %
10114	CAD	IEEE 802.11n (HT Greenfield, 13.5 Mbps, BPSK)	WLAN	8.10	± 9.6 %
10115	CAD	IEEE 802.11n (HT Greenfield, 81 Mbps, 16-QAM)	WLAN	8.46	± 9.6 %
10116	CAD	IEEE 802.11n (HT Greenfield, 135 Mbps, 64-QAM)	WLAN	8.15	± 9.6 %
10117	CAD	IEEE 802.11n (HT Mixed, 13.5 Mbps, BPSK)	WLAN	8.07	± 9.6 %
10118	CAD	IEEE 802.11n (HT Mixed, 81 Mbps, 16-QAM)	WLAN	8.59	± 9.6 %
10119	CAD	IEEE 802.11n (HT Mixed, 135 Mbps, 64-QAM)	WLAN	8.13	± 9.6 %
10140	CAE	LTE-FDD (SC-FDMA, 100% RB, 15 MHz, 16-QAM)	LTE-FDD	6.49	± 9.6 %
10141	CAE	LTE-FDD (SC-FDMA, 100% RB, 15 MHz, 64-QAM)	LTE-FDD	6.53	± 9.6 %
10142	CAE	LTE-FDD (SC-FDMA, 100% RB, 3 MHz, QPSK)	LTE-FDD	5.73	± 9.6 %
10143	CAE	LTE-FDD (SC-FDMA, 100% RB, 3 MHz, 16-QAM)	LTE-FDD	6.35	± 9.6 %
10144	CAE	LTE-FDD (SC-FDMA, 100% RB, 3 MHz, 64-QAM)	LTE-FDD	6.65	± 9.6 %
10145	CAF	LTE-FDD (SC-FDMA, 100% RB, 1.4 MHz, QPSK)	LTE-FDD	5.76	± 9.6 %
10146	CAF	LTE-FDD (SC-FDMA, 100% RB, 1.4 MHz, 16-QAM)	LTE-FDD	6.41	± 9.6 %
10147	CAF	LTE-FDD (SC-FDMA, 100% RB, 1.4 MHz, 64-QAM)	LTE-FDD	6.72	± 9.6 %
10149	CAE	LTE-FDD (SC-FDMA, 50% RB, 20 MHz, 16-QAM)	LTE-FDD	6.42	± 9.6 %
10150	CAE	LTE-FDD (SC-FDMA, 50% RB, 20 MHz, 64-QAM)	LTE-FDD	6.60	± 9.6 %
10151	CAG	LTE-TDD (SC-FDMA, 50% RB, 20 MHz, QPSK)	LTE-TDD	9.28	± 9.6 %
10152	CAG	LTE-TDD (SC-FDMA, 50% RB, 20 MHz, 16-QAM)	LTE-TDD	9.92	± 9.6 %
10153	CAG	LTE-TDD (SC-FDMA, 50% RB, 20 MHz, 64-QAM)	LTE-TDD	10.05	± 9.6 %
10154	CAG	LTE-FDD (SC-FDMA, 50% RB, 10 MHz, QPSK)	LTE-FDD	5.75	± 9.6 %
10155	CAG	LTE-FDD (SC-FDMA, 50% RB, 10 MHz, 16-QAM)	LTE-FDD	6.43	± 9.6 %
10156	CAG	LTE-FDD (SC-FDMA, 50% RB, 5 MHz, QPSK)	LTE-FDD	5.79	± 9.6 %
10157	CAG	LTE-FDD (SC-FDMA, 50% RB, 5 MHz, 16-QAM)	LTE-FDD	6.49	± 9.6 %
10158	CAG	LTE-FDD (SC-FDMA, 50% RB, 10 MHz, 64-QAM)	LTE-FDD	6.62	± 9.6 %
10159	CAG	LTE-FDD (SC-FDMA, 50% RB, 5 MHz, 64-QAM)	LTE-FDD	6.56	± 9.6 %
10160	CAE	LTE-FDD (SC-FDMA, 50% RB, 15 MHz, QPSK)	LTE-FDD	5.82	± 9.6 %
10161	CAE	LTE-FDD (SC-FDMA, 50% RB, 15 MHz, 16-QAM)	LTE-FDD	6.43	± 9.6 %
10162	CAE	LTE-FDD (SC-FDMA, 50% RB, 15 MHz, 64-QAM)	LTE-FDD	6.58	± 9.6 %
10166	CAF	LTE-FDD (SC-FDMA, 50% RB, 1.4 MHz, QPSK)	LTE-FDD	5.46	± 9.6 %
10167	CAF	LTE-FDD (SC-FDMA, 50% RB, 1.4 MHz, 16-QAM)	LTE-FDD	6.21	± 9.6 %
10168	CAF	LTE-FDD (SC-FDMA, 50% RB, 1.4 MHz, 64-QAM)	LTE-FDD	6.79	± 9.6 %
10169	CAE	LTE-FDD (SC-FDMA, 1 RB, 20 MHz, QPSK)	LTE-FDD	5.73	± 9.6 %
10170	CAE	LTE-FDD (SC-FDMA, 1 RB, 20 MHz, 16-QAM)	LTE-FDD	6.52	± 9.6 %
10171	AAE	LTE-FDD (SC-FDMA, 1 RB, 20 MHz, 64-QAM)	LTE-FDD	6.49	± 9.6 %
10172	CAG	LTE-TDD (SC-FDMA, 1 RB, 20 MHz, QPSK)	LTE-TDD	9.21	± 9.6 %
10173	CAG	LTE-TDD (SC-FDMA, 1 RB, 20 MHz, 16-QAM)	LTE-TDD	9.48	± 9.6 %
10174	CAG	LTE-TDD (SC-FDMA, 1 RB, 20 MHz, 64-QAM)	LTE-TDD	10.25	± 9.6 %
10175	CAG	LTE-FDD (SC-FDMA, 1 RB, 10 MHz, QPSK)	LTE-FDD	5.72	± 9.6 %
10176	CAG	LTE-FDD (SC-FDMA, 1 RB, 10 MHz, 16-QAM)	LTE-FDD	6.52	± 9.6 %
10177	CAI	LTE-FDD (SC-FDMA, 1 RB, 5 MHz, QPSK)	LTE-FDD	5.73	± 9.6 %
10178	CAG	LTE-FDD (SC-FDMA, 1 RB, 5 MHz, 16-QAM)	LTE-FDD	6.52	± 9.6 %
10179	CAG	LTE-FDD (SC-FDMA, 1 RB, 10 MHz, 64-QAM)	LTE-FDD	6.50	± 9.6 %
10180	CAG	LTE-FDD (SC-FDMA, 1 RB, 5 MHz, 64-QAM)	LTE-FDD	6.50	± 9.6 %
10181	CAE	LTE-FDD (SC-FDMA, 1 RB, 15 MHz, QPSK)	LTE-FDD	5.73	± 9.6 %

10182	CAE	LTE-FDD (SC-FDMA, 1 RB, 15 MHz, 16-QAM)	LTE-FDD	6.52	± 9.6 %
10183	AAD	LTE-FDD (SC-FDMA, 1 RB, 15 MHz, 64-QAM)	LTE-FDD	6.50	± 9.6 %
10184	CAE	LTE-FDD (SC-FDMA, 1 RB, 3 MHz, QPSK)	LTE-FDD	5.73	± 9.6 %
10185	CAE	LTE-FDD (SC-FDMA, 1 RB, 3 MHz, 16-QAM)	LTE-FDD	6.51	± 9.6 %
10186	AAE	LTE-FDD (SC-FDMA, 1 RB, 3 MHz, 64-QAM)	LTE-FDD	6.50	± 9.6 %
10187	CAF	LTE-FDD (SC-FDMA, 1 RB, 1.4 MHz, QPSK)	LTE-FDD	5.73	± 9.6 %
10188	CAF	LTE-FDD (SC-FDMA, 1 RB, 1.4 MHz, 16-QAM)	LTE-FDD	6.52	± 9.6 %
10189	AAF	LTE-FDD (SC-FDMA, 1 RB, 1.4 MHz, 64-QAM)	LTE-FDD	6.50	± 9.6 %
10193	CAD	IEEE 802.11n (HT Greenfield, 6.5 Mbps, BPSK)	WLAN	8.09	± 9.6 %
10194	CAD	IEEE 802.11n (HT Greenfield, 39 Mbps, 16-QAM)	WLAN	8.12	± 9.6 %
10195	CAD	IEEE 802.11n (HT Greenfield, 65 Mbps, 64-QAM)	WLAN	8.21	± 9.6 %
10196	CAD	IEEE 802.11n (HT Mixed, 6.5 Mbps, BPSK)	WLAN	8.10	± 9.6 %
10197	CAD	IEEE 802.11n (HT Mixed, 39 Mbps, 16-QAM)	WLAN	8.13	± 9.6 %
10198	CAD	IEEE 802.11n (HT Mixed, 65 Mbps, 64-QAM)	WLAN	8.27	± 9.6 %
10219	CAD	IEEE 802.11n (HT Mixed, 7.2 Mbps, BPSK)	WLAN	8.03	± 9.6 %
10220	CAD	IEEE 802.11n (HT Mixed, 43.3 Mbps, 16-QAM)	WLAN	8.13	± 9.6 %
10221	CAD	IEEE 802.11n (HT Mixed, 72.2 Mbps, 64-QAM)	WLAN	8.27	± 9.6 %
10222	CAD	IEEE 802.11n (HT Mixed, 15 Mbps, BPSK)	WLAN	8.06	± 9.6 %
10223	CAD	IEEE 802.11n (HT Mixed, 90 Mbps, 16-QAM)	WLAN	8.48	± 9.6 %
10224	CAD	IEEE 802.11n (HT Mixed, 150 Mbps, 64-QAM)	WLAN	8.08	± 9.6 %
10225	CAB	UMTS-FDD (HSPA+)	WCDMA	5.97	± 9.6 %
10226	CAB	LTE-TDD (SC-FDMA, 1 RB, 1.4 MHz, 16-QAM)	LTE-TDD	9.49	± 9.6 %
10227	CAB	LTE-TDD (SC-FDMA, 1 RB, 1.4 MHz, 64-QAM)	LTE-TDD	10.26	± 9.6 %
10228	CAB	LTE-TDD (SC-FDMA, 1 RB, 1.4 MHz, QPSK)	LTE-TDD	9.22	± 9.6 %
10229	CAD	LTE-TDD (SC-FDMA, 1 RB, 3 MHz, 16-QAM)	LTE-TDD	9.48	± 9.6 %
10230	CAD	LTE-TDD (SC-FDMA, 1 RB, 3 MHz, 64-QAM)	LTE-TDD	10.25	± 9.6 %
10231	CAD	LTE-TDD (SC-FDMA, 1 RB, 3 MHz, QPSK)	LTE-TDD	9.19	± 9.6 %
10232	CAG	LTE-TDD (SC-FDMA, 1 RB, 5 MHz, 16-QAM)	LTE-TDD	9.48	± 9.6 %
10233	CAG	LTE-TDD (SC-FDMA, 1 RB, 5 MHz, 64-QAM)	LTE-TDD	10.25	± 9.6 %
10234	CAG	LTE-TDD (SC-FDMA, 1 RB, 5 MHz, QPSK)	LTE-TDD	9.21	± 9.6 %
10235	CAG	LTE-TDD (SC-FDMA, 1 RB, 10 MHz, 16-QAM)	LTE-TDD	9.48	± 9.6 %
10236	CAG	LTE-TDD (SC-FDMA, 1 RB, 10 MHz, 64-QAM)	LTE-TDD	10.25	± 9.6 %
10237	CAG	LTE-TDD (SC-FDMA, 1 RB, 10 MHz, QPSK)	LTE-TDD	9.21	± 9.6 %
10238	CAF	LTE-TDD (SC-FDMA, 1 RB, 15 MHz, 16-QAM)	LTE-TDD	9.48	± 9.6 %
10239	CAF	LTE-TDD (SC-FDMA, 1 RB, 15 MHz, 64-QAM)	LTE-TDD	10.25	± 9.6 %
10240	CAF	LTE-TDD (SC-FDMA, 1 RB, 15 MHz, QPSK)	LTE-TDD	9.21	± 9.6 %
10241	CAB	LTE-TDD (SC-FDMA, 50% RB, 1.4 MHz, 16-QAM)	LTE-TDD	9.82	± 9.6 %
10242	CAB	LTE-TDD (SC-FDMA, 50% RB, 1.4 MHz, 64-QAM)	LTE-TDD	9.86	± 9.6 %
10243	CAB	LTE-TDD (SC-FDMA, 50% RB, 1.4 MHz, QPSK)	LTE-TDD	9.46	± 9.6 %
10244	CAD	LTE-TDD (SC-FDMA, 50% RB, 3 MHz, 16-QAM)	LTE-TDD	10.06	± 9.6 %
10245	CAD	LTE-TDD (SC-FDMA, 50% RB, 3 MHz, 64-QAM)	LTE-TDD	10.06	± 9.6 %
10246	CAD	LTE-TDD (SC-FDMA, 50% RB, 3 MHz, QPSK)	LTE-TDD	9.30	± 9.6 %
10247	CAG	LTE-TDD (SC-FDMA, 50% RB, 5 MHz, 16-QAM)	LTE-TDD	9.91	± 9.6 %
10248	CAG	LTE-TDD (SC-FDMA, 50% RB, 5 MHz, 64-QAM)	LTE-TDD	10.09	± 9.6 %
10249	CAG	LTE-TDD (SC-FDMA, 50% RB, 5 MHz, QPSK)	LTE-TDD	9.29	± 9.6 %
10250	CAG	LTE-TDD (SC-FDMA, 50% RB, 10 MHz, 16-QAM)	LTE-TDD	9.81	± 9.6 %
10251	CAG	LTE-TDD (SC-FDMA, 50% RB, 10 MHz, 64-QAM)	LTE-TDD	10.17	± 9.6 %
10252	CAG	LTE-TDD (SC-FDMA, 50% RB, 10 MHz, QPSK)	LTE-TDD	9.24	± 9.6 %
10253	CAF	LTE-TDD (SC-FDMA, 50% RB, 15 MHz, 16-QAM)	LTE-TDD	9.90	± 9.6 %
10254	CAF	LTE-TDD (SC-FDMA, 50% RB, 15 MHz, 64-QAM)	LTE-TDD	10.14	± 9.6 %
10255	CAF	LTE-TDD (SC-FDMA, 50% RB, 15 MHz, QPSK)	LTE-TDD	9.20	± 9.6 %
10256	CAB	LTE-TDD (SC-FDMA, 100% RB, 1.4 MHz, 16-QAM)	LTE-TDD	9.96	± 9.6 %
10257	CAB	LTE-TDD (SC-FDMA, 100% RB, 1.4 MHz, 64-QAM)	LTE-TDD	10.08	± 9.6 %
10258	CAB	LTE-TDD (SC-FDMA, 100% RB, 1.4 MHz, QPSK)	LTE-TDD	9.34	± 9.6 %
10259	CAD	LTE-TDD (SC-FDMA, 100% RB, 3 MHz, 16-QAM)	LTE-TDD	9.98	± 9.6 %
10260	CAD	LTE-TDD (SC-FDMA, 100% RB, 3 MHz, 64-QAM)	LTE-TDD	9.97	± 9.6 %

10261	CAD	LTE-TDD (SC-FDMA, 100% RB, 3 MHz, QPSK)	LTE-TDD	9.24	± 9.6 %
10262	CAG	LTE-TDD (SC-FDMA, 100% RB, 5 MHz, 16-QAM)	LTE-TDD	9.83	± 9.6 %
10263	CAG	LTE-TDD (SC-FDMA, 100% RB, 5 MHz, 64-QAM)	LTE-TDD	10.16	± 9.6 %
10264	CAG	LTE-TDD (SC-FDMA, 100% RB, 5 MHz, QPSK)	LTE-TDD	9.23	± 9.6 %
10265	CAG	LTE-TDD (SC-FDMA, 100% RB, 10 MHz, 16-QAM)	LTE-TDD	9.92	± 9.6 %
10266	CAG	LTE-TDD (SC-FDMA, 100% RB, 10 MHz, 64-QAM)	LTE-TDD	10.07	± 9.6 %
10267	CAG	LTE-TDD (SC-FDMA, 100% RB, 10 MHz, QPSK)	LTE-TDD	9.30	± 9.6 %
10268	CAF	LTE-TDD (SC-FDMA, 100% RB, 15 MHz, 16-QAM)	LTE-TDD	10.06	± 9.6 %
10269	CAF	LTE-TDD (SC-FDMA, 100% RB, 15 MHz, 64-QAM)	LTE-TDD	10.13	± 9.6 %
10270	CAF	LTE-TDD (SC-FDMA, 100% RB, 15 MHz, QPSK)	LTE-TDD	9.58	± 9.6 %
10274	CAB	UMTS-FDD (HSUPA, Subtest 5, 3GPP Rel8.10)	WCDMA	4.87	± 9.6 %
10275	CAB	UMTS-FDD (HSUPA, Subtest 5, 3GPP Rel8.4)	WCDMA	3.96	± 9.6 %
10277	CAA	PHS (QPSK)	PHS	11.81	± 9.6 %
10278	CAA	PHS (QPSK, BW 884MHz, Rolloff 0.5)	PHS	11.81	± 9.6 %
10279	CAA	PHS (QPSK, BW 884MHz, Rolloff 0.38)	PHS	12.18	± 9.6 %
10290	AAB	CDMA2000, RC1, SO55, Full Rate	CDMA2000	3.91	± 9.6 %
10291	AAB	CDMA2000, RC3, SO55, Full Rate	CDMA2000	3.46	± 9.6 %
10292	AAB	CDMA2000, RC3, SO32, Full Rate	CDMA2000	3.39	± 9.6 %
10293	AAB	CDMA2000, RC3, SO3, Full Rate	CDMA2000	3.50	± 9.6 %
10295	AAB	CDMA2000, RC1, SO3, 1/8th Rate 25 fr.	CDMA2000	12.49	± 9.6 %
10297	AAD	LTE-FDD (SC-FDMA, 50% RB, 20 MHz, QPSK)	LTE-FDD	5.81	± 9.6 %
10298	AAD	LTE-FDD (SC-FDMA, 50% RB, 3 MHz, QPSK)	LTE-FDD	5.72	± 9.6 %
10299	AAD	LTE-FDD (SC-FDMA, 50% RB, 3 MHz, 16-QAM)	LTE-FDD	6.39	± 9.6 %
10300	AAD	LTE-FDD (SC-FDMA, 50% RB, 3 MHz, 64-QAM)	LTE-FDD	6.60	± 9.6 %
10301	AAA	IEEE 802.16e WiMAX (29:18, 5ms, 10MHz, QPSK, PUSC)	WiMAX	12.03	± 9.6 %
10302	AAA	IEEE 802.16e WiMAX (29:18, 5ms, 10MHz, QPSK, PUSC, 3CTRL)	WiMAX	12.57	± 9.6 %
10303	AAA	IEEE 802.16e WiMAX (31:15, 5ms, 10MHz, 64QAM, PUSC)	WiMAX	12.52	± 9.6 %
10304	AAA	IEEE 802.16e WiMAX (29:18, 5ms, 10MHz, 64QAM, PUSC)	WiMAX	11.86	± 9.6 %
10305	AAA	IEEE 802.16e WiMAX (31:15, 10ms, 10MHz, 64QAM, PUSC)	WiMAX	15.24	± 9.6 %
10306	AAA	IEEE 802.16e WiMAX (29:18, 10ms, 10MHz, 64QAM, PUSC)	WiMAX	14.67	± 9.6 %
10307	AAA	IEEE 802.16e WiMAX (29:18, 10ms, 10MHz, QPSK, PUSC)	WiMAX	14.49	± 9.6 %
10308	AAA	IEEE 802.16e WiMAX (29:18, 10ms, 10MHz, 16QAM, PUSC)	WiMAX	14.46	± 9.6 %
10309	AAA	IEEE 802.16e WiMAX (29:18, 10ms, 10MHz, 16QAM, AMC 2x3)	WiMAX	14.58	± 9.6 %
10310	AAA	IEEE 802.16e WiMAX (29:18, 10ms, 10MHz, QPSK, AMC 2x3)	WiMAX	14.57	± 9.6 %
10311	AAD	LTE-FDD (SC-FDMA, 100% RB, 15 MHz, QPSK)	LTE-FDD	6.06	± 9.6 %
10313	AAA	iDEN 1:3	iDEN	10.51	± 9.6 %
10314	AAA	iDEN 1:6	iDEN	13.48	± 9.6 %
10315	AAB	IEEE 802.11b WiFi 2.4 GHz (DSSS, 1 Mbps, 96pc dc)	WLAN	1.71	± 9.6 %
10316	AAB	IEEE 802.11g WiFi 2.4 GHz (ERP-OFDM, 6 Mbps, 96pc dc)	WLAN	8.36	± 9.6 %
10317	AAD	IEEE 802.11a WiFi 5 GHz (OFDM, 6 Mbps, 96pc dc)	WLAN	8.36	± 9.6 %
10352	AAA	Pulse Waveform (200Hz, 10%)	Generic	10.00	± 9.6 %
10353	AAA	Pulse Waveform (200Hz, 20%)	Generic	6.99	± 9.6 %
10354	AAA	Pulse Waveform (200Hz, 40%)	Generic	3.98	± 9.6 %
10355	AAA	Pulse Waveform (200Hz, 60%)	Generic	2.22	± 9.6 %
10356	AAA	Pulse Waveform (200Hz, 80%)	Generic	0.97	± 9.6 %
10387	AAA	QPSK Waveform, 1 MHz	Generic	5.10	± 9.6 %
10388	AAA	QPSK Waveform, 10 MHz	Generic	5.22	± 9.6 %
10396	AAA	64-QAM Waveform, 100 kHz	Generic	6.27	± 9.6 %
10399	AAA	64-QAM Waveform, 40 MHz	Generic	6.27	± 9.6 %
10400	AAE	IEEE 802.11ac WiFi (20MHz, 64-QAM, 99pc dc)	WLAN	8.37	± 9.6 %
10401	AAE	IEEE 802.11ac WiFi (40MHz, 64-QAM, 99pc dc)	WLAN	8.60	± 9.6 %
10402	AAE	IEEE 802.11ac WiFi (80MHz, 64-QAM, 99pc dc)	WLAN	8.53	± 9.6 %
10403	AAB	CDMA2000 (1xEV-DO, Rev. 0)	CDMA2000	3.76	± 9.6 %
10404	AAB	CDMA2000 (1xEV-DO, Rev. A)	CDMA2000	3.77	± 9.6 %
10406	AAB	CDMA2000, RC3, SO32, SCH0, Full Rate	CDMA2000	5.22	± 9.6 %
10410	AAG	LTE-TDD (SC-FDMA, 1 RB, 10 MHz, QPSK, UL Sub=2,3,4,7,8,9)	LTE-TDD	7.82	± 9.6 %

10414	AAA	WLAN CCDF, 64-QAM, 40MHz	Generic	8.54	± 9.6 %
10415	AAA	IEEE 802.11b WiFi 2.4 GHz (DSSS, 1 Mbps, 99pc dc)	WLAN	1.54	± 9.6 %
10416	AAA	IEEE 802.11g WiFi 2.4 GHz (ERP-OFDM, 6 Mbps, 99pc dc)	WLAN	8.23	± 9.6 %
10417	AAC	IEEE 802.11a/h WiFi 5 GHz (OFDM, 6 Mbps, 99pc dc)	WLAN	8.23	± 9.6 %
10418	AAA	IEEE 802.11g WiFi 2.4 GHz (DSSS-OFDM, 6 Mbps, 99pc, Long)	WLAN	8.14	± 9.6 %
10419	AAA	IEEE 802.11g WiFi 2.4 GHz (DSSS-OFDM, 6 Mbps, 99pc, Short)	WLAN	8.19	± 9.6 %
10422	AAC	IEEE 802.11n (HT Greenfield, 7.2 Mbps, BPSK)	WLAN	8.32	± 9.6 %
10423	AAC	IEEE 802.11n (HT Greenfield, 43.3 Mbps, 16-QAM)	WLAN	8.47	± 9.6 %
10424	AAC	IEEE 802.11n (HT Greenfield, 72.2 Mbps, 64-QAM)	WLAN	8.40	± 9.6 %
10425	AAC	IEEE 802.11n (HT Greenfield, 15 Mbps, BPSK)	WLAN	8.41	± 9.6 %
10426	AAC	IEEE 802.11n (HT Greenfield, 90 Mbps, 16-QAM)	WLAN	8.45	± 9.6 %
10427	AAC	IEEE 802.11n (HT Greenfield, 150 Mbps, 64-QAM)	WLAN	8.41	± 9.6 %
10430	AAD	LTE-FDD (OFDMA, 5 MHz, E-TM 3.1)	LTE-FDD	8.28	± 9.6 %
10431	AAD	LTE-FDD (OFDMA, 10 MHz, E-TM 3.1)	LTE-FDD	8.38	± 9.6 %
10432	AAC	LTE-FDD (OFDMA, 15 MHz, E-TM 3.1)	LTE-FDD	8.34	± 9.6 %
10433	AAC	LTE-FDD (OFDMA, 20 MHz, E-TM 3.1)	LTE-FDD	8.34	± 9.6 %
10434	AAA	W-CDMA (BS Test Model 1, 64 DPCH)	WCDMA	8.60	± 9.6 %
10435	AAF	LTE-TDD (SC-FDMA, 1 RB, 20 MHz, QPSK, UL Sub)	LTE-TDD	7.82	± 9.6 %
10447	AAD	LTE-FDD (OFDMA, 5 MHz, E-TM 3.1, Clipping 44%)	LTE-FDD	7.56	± 9.6 %
10448	AAD	LTE-FDD (OFDMA, 10 MHz, E-TM 3.1, Clipping 44%)	LTE-FDD	7.53	± 9.6 %
10449	AAC	LTE-FDD (OFDMA, 15 MHz, E-TM 3.1, Clipping 44%)	LTE-FDD	7.51	± 9.6 %
10450	AAC	LTE-FDD (OFDMA, 20 MHz, E-TM 3.1, Clipping 44%)	LTE-FDD	7.48	± 9.6 %
10451	AAA	W-CDMA (BS Test Model 1, 64 DPCH, Clipping 44%)	WCDMA	7.59	± 9.6 %
10453	AAD	Validation (Square, 10ms, 1ms)	Test	10.00	± 9.6 %
10456	AAC	IEEE 802.11ac WiFi (160MHz, 64-QAM, 99pc dc)	WLAN	8.63	± 9.6 %
10457	AAA	UMTS-FDD (DC-HSDPA)	WCDMA	6.62	± 9.6 %
10458	AAA	CDMA2000 (1xEV-DO, Rev. B, 2 carriers)	CDMA2000	6.55	± 9.6 %
10459	AAA	CDMA2000 (1xEV-DO, Rev. B, 3 carriers)	CDMA2000	8.25	± 9.6 %
10460	AAA	UMTS-FDD (WCDMA, AMR)	WCDMA	2.39	± 9.6 %
10461	AAB	LTE-TDD (SC-FDMA, 1 RB, 1.4 MHz, QPSK, UL Sub)	LTE-TDD	7.82	± 9.6 %
10462	AAB	LTE-TDD (SC-FDMA, 1 RB, 1.4 MHz, 16-QAM, UL Sub)	LTE-TDD	8.30	± 9.6 %
10463	AAB	LTE-TDD (SC-FDMA, 1 RB, 1.4 MHz, 64-QAM, UL Sub)	LTE-TDD	8.56	± 9.6 %
10464	AAC	LTE-TDD (SC-FDMA, 1 RB, 3 MHz, QPSK, UL Sub)	LTE-TDD	7.82	± 9.6 %
10465	AAC	LTE-TDD (SC-FDMA, 1 RB, 3 MHz, 16-QAM, UL Sub)	LTE-TDD	8.32	± 9.6 %
10466	AAC	LTE-TDD (SC-FDMA, 1 RB, 3 MHz, 64-QAM, UL Sub)	LTE-TDD	8.57	± 9.6 %
10467	AAF	LTE-TDD (SC-FDMA, 1 RB, 5 MHz, QPSK, UL Sub)	LTE-TDD	7.82	± 9.6 %
10468	AAF	LTE-TDD (SC-FDMA, 1 RB, 5 MHz, 16-QAM, UL Sub)	LTE-TDD	8.32	± 9.6 %
10469	AAF	LTE-TDD (SC-FDMA, 1 RB, 5 MHz, 64-QAM, UL Sub)	LTE-TDD	8.56	± 9.6 %
10470	AAF	LTE-TDD (SC-FDMA, 1 RB, 10 MHz, QPSK, UL Sub)	LTE-TDD	7.82	± 9.6 %
10471	AAF	LTE-TDD (SC-FDMA, 1 RB, 10 MHz, 16-QAM, UL Sub)	LTE-TDD	8.32	± 9.6 %
10472	AAF	LTE-TDD (SC-FDMA, 1 RB, 10 MHz, 64-QAM, UL Sub)	LTE-TDD	8.57	± 9.6 %
10473	AAE	LTE-TDD (SC-FDMA, 1 RB, 15 MHz, QPSK, UL Sub)	LTE-TDD	7.82	± 9.6 %
10474	AAE	LTE-TDD (SC-FDMA, 1 RB, 15 MHz, 16-QAM, UL Sub)	LTE-TDD	8.32	± 9.6 %
10475	AAE	LTE-TDD (SC-FDMA, 1 RB, 15 MHz, 64-QAM, UL Sub)	LTE-TDD	8.57	± 9.6 %
10477	AAF	LTE-TDD (SC-FDMA, 1 RB, 20 MHz, 16-QAM, UL Sub)	LTE-TDD	8.32	± 9.6 %
10478	AAF	LTE-TDD (SC-FDMA, 1 RB, 20 MHz, 64-QAM, UL Sub)	LTE-TDD	8.57	± 9.6 %
10479	AAB	LTE-TDD (SC-FDMA, 50% RB, 1.4 MHz, QPSK, UL Sub)	LTE-TDD	7.74	± 9.6 %
10480	AAB	LTE-TDD (SC-FDMA, 50% RB, 1.4 MHz, 16-QAM, UL Sub)	LTE-TDD	8.18	± 9.6 %
10481	AAB	LTE-TDD (SC-FDMA, 50% RB, 1.4 MHz, 64-QAM, UL Sub)	LTE-TDD	8.45	± 9.6 %
10482	AAC	LTE-TDD (SC-FDMA, 50% RB, 3 MHz, QPSK, UL Sub)	LTE-TDD	7.71	± 9.6 %
10483	AAC	LTE-TDD (SC-FDMA, 50% RB, 3 MHz, 16-QAM, Sub)	LTE-TDD	8.39	± 9.6 %
10484	AAC	LTE-TDD (SC-FDMA, 50% RB, 3 MHz, 64-QAM, UL Sub)	LTE-TDD	8.47	± 9.6 %
10485	AAF	LTE-TDD (SC-FDMA, 50% RB, 5 MHz, QPSK, UL Sub)	LTE-TDD	7.59	± 9.6 %
10486	AAF	LTE-TDD (SC-FDMA, 50% RB, 5 MHz, 16-QAM, UL Sub)	LTE-TDD	8.38	± 9.6 %
10487	AAF	LTE-TDD (SC-FDMA, 50% RB, 5 MHz, 64-QAM, UL Sub)	LTE-TDD	8.60	± 9.6 %
10488	AAF	LTE-TDD (SC-FDMA, 50% RB, 10 MHz, QPSK, UL Sub)	LTE-TDD	7.70	± 9.6 %

10489	AAF	LTE-TDD (SC-FDMA, 50% RB, 10 MHz, 16-QAM, UL Sub)	LTE-TDD	8.31	± 9.6 %
10490	AAF	LTE-TDD (SC-FDMA, 50% RB, 10 MHz, 64-QAM, UL Sub)	LTE-TDD	8.54	± 9.6 %
10491	AAE	LTE-TDD (SC-FDMA, 50% RB, 15 MHz, QPSK, UL Sub)	LTE-TDD	7.74	± 9.6 %
10492	AAE	LTE-TDD (SC-FDMA, 50% RB, 15 MHz, 16-QAM, UL Sub)	LTE-TDD	8.41	± 9.6 %
10493	AAE	LTE-TDD (SC-FDMA, 50% RB, 15 MHz, 64-QAM, UL Sub)	LTE-TDD	8.55	± 9.6 %
10494	AAF	LTE-TDD (SC-FDMA, 50% RB, 20 MHz, QPSK, UL Sub)	LTE-TDD	7.74	± 9.6 %
10495	AAF	LTE-TDD (SC-FDMA, 50% RB, 20 MHz, 16-QAM, UL Sub)	LTE-TDD	8.37	± 9.6 %
10496	AAF	LTE-TDD (SC-FDMA, 50% RB, 20 MHz, 64-QAM, UL Sub)	LTE-TDD	8.54	± 9.6 %
10497	AAB	LTE-TDD (SC-FDMA, 100% RB, 1.4 MHz, QPSK, UL Sub)	LTE-TDD	7.67	± 9.6 %
10498	AAB	LTE-TDD (SC-FDMA, 100% RB, 1.4 MHz, 16-QAM, UL Sub)	LTE-TDD	8.40	± 9.6 %
10499	AAB	LTE-TDD (SC-FDMA, 100% RB, 1.4 MHz, 64-QAM, UL Sub)	LTE-TDD	8.68	± 9.6 %
10500	AAC	LTE-TDD (SC-FDMA, 100% RB, 3 MHz, QPSK, UL Sub)	LTE-TDD	7.67	± 9.6 %
10501	AAC	LTE-TDD (SC-FDMA, 100% RB, 3 MHz, 16-QAM, UL Sub)	LTE-TDD	8.44	± 9.6 %
10502	AAC	LTE-TDD (SC-FDMA, 100% RB, 3 MHz, 64-QAM, UL Sub)	LTE-TDD	8.52	± 9.6 %
10503	AAF	LTE-TDD (SC-FDMA, 100% RB, 5 MHz, QPSK, UL Sub)	LTE-TDD	7.72	± 9.6 %
10504	AAF	LTE-TDD (SC-FDMA, 100% RB, 5 MHz, 16-QAM, UL Sub)	LTE-TDD	8.31	± 9.6 %
10505	AAF	LTE-TDD (SC-FDMA, 100% RB, 5 MHz, 64-QAM, UL Sub)	LTE-TDD	8.54	± 9.6 %
10506	AAF	LTE-TDD (SC-FDMA, 100% RB, 10 MHz, QPSK, UL Sub)	LTE-TDD	7.74	± 9.6 %
10507	AAF	LTE-TDD (SC-FDMA, 100% RB, 10 MHz, 16-QAM, UL Sub)	LTE-TDD	8.36	± 9.6 %
10508	AAF	LTE-TDD (SC-FDMA, 100% RB, 10 MHz, 64-QAM, UL Sub)	LTE-TDD	8.55	± 9.6 %
10509	AAE	LTE-TDD (SC-FDMA, 100% RB, 15 MHz, QPSK, UL Sub)	LTE-TDD	7.99	± 9.6 %
10510	AAE	LTE-TDD (SC-FDMA, 100% RB, 15 MHz, 16-QAM, UL Sub)	LTE-TDD	8.49	± 9.6 %
10511	AAE	LTE-TDD (SC-FDMA, 100% RB, 15 MHz, 64-QAM, UL Sub)	LTE-TDD	8.51	± 9.6 %
10512	AAF	LTE-TDD (SC-FDMA, 100% RB, 20 MHz, QPSK, UL Sub)	LTE-TDD	7.74	± 9.6 %
10513	AAF	LTE-TDD (SC-FDMA, 100% RB, 20 MHz, 16-QAM, UL Sub)	LTE-TDD	8.42	± 9.6 %
10514	AAF	LTE-TDD (SC-FDMA, 100% RB, 20 MHz, 64-QAM, UL Sub)	LTE-TDD	8.45	± 9.6 %
10515	AAA	IEEE 802.11b WiFi 2.4 GHz (DSSS, 2 Mbps, 99pc dc)	WLAN	1.58	± 9.6 %
10516	AAA	IEEE 802.11b WiFi 2.4 GHz (DSSS, 5.5 Mbps, 99pc dc)	WLAN	1.57	± 9.6 %
10517	AAA	IEEE 802.11b WiFi 2.4 GHz (DSSS, 11 Mbps, 99pc dc)	WLAN	1.58	± 9.6 %
10518	AAC	IEEE 802.11a/h WiFi 5 GHz (OFDM, 9 Mbps, 99pc dc)	WLAN	8.23	± 9.6 %
10519	AAC	IEEE 802.11a/h WiFi 5 GHz (OFDM, 12 Mbps, 99pc dc)	WLAN	8.39	± 9.6 %
10520	AAC	IEEE 802.11a/h WiFi 5 GHz (OFDM, 18 Mbps, 99pc dc)	WLAN	8.12	± 9.6 %
10521	AAC	IEEE 802.11a/h WiFi 5 GHz (OFDM, 24 Mbps, 99pc dc)	WLAN	7.97	± 9.6 %
10522	AAC	IEEE 802.11a/h WiFi 5 GHz (OFDM, 36 Mbps, 99pc dc)	WLAN	8.45	± 9.6 %
10523	AAC	IEEE 802.11a/h WiFi 5 GHz (OFDM, 48 Mbps, 99pc dc)	WLAN	8.08	± 9.6 %
10524	AAC	IEEE 802.11a/h WiFi 5 GHz (OFDM, 54 Mbps, 99pc dc)	WLAN	8.27	± 9.6 %
10525	AAC	IEEE 802.11ac WiFi (20MHz, MCS0, 99pc dc)	WLAN	8.36	± 9.6 %
10526	AAC	IEEE 802.11ac WiFi (20MHz, MCS1, 99pc dc)	WLAN	8.42	± 9.6 %
10527	AAC	IEEE 802.11ac WiFi (20MHz, MCS2, 99pc dc)	WLAN	8.21	± 9.6 %
10528	AAC	IEEE 802.11ac WiFi (20MHz, MCS3, 99pc dc)	WLAN	8.36	± 9.6 %
10529	AAC	IEEE 802.11ac WiFi (20MHz, MCS4, 99pc dc)	WLAN	8.36	± 9.6 %
10531	AAC	IEEE 802.11ac WiFi (20MHz, MCS6, 99pc dc)	WLAN	8.43	± 9.6 %
10532	AAC	IEEE 802.11ac WiFi (20MHz, MCS7, 99pc dc)	WLAN	8.29	± 9.6 %
10533	AAC	IEEE 802.11ac WiFi (20MHz, MCS8, 99pc dc)	WLAN	8.38	± 9.6 %
10534	AAC	IEEE 802.11ac WiFi (40MHz, MCS0, 99pc dc)	WLAN	8.45	± 9.6 %
10535	AAC	IEEE 802.11ac WiFi (40MHz, MCS1, 99pc dc)	WLAN	8.45	± 9.6 %
10536	AAC	IEEE 802.11ac WiFi (40MHz, MCS2, 99pc dc)	WLAN	8.32	± 9.6 %
10537	AAC	IEEE 802.11ac WiFi (40MHz, MCS3, 99pc dc)	WLAN	8.44	± 9.6 %
10538	AAC	IEEE 802.11ac WiFi (40MHz, MCS4, 99pc dc)	WLAN	8.54	± 9.6 %
10540	AAC	IEEE 802.11ac WiFi (40MHz, MCS6, 99pc dc)	WLAN	8.39	± 9.6 %
10541	AAC	IEEE 802.11ac WiFi (40MHz, MCS7, 99pc dc)	WLAN	8.46	± 9.6 %
10542	AAC	IEEE 802.11ac WiFi (40MHz, MCS8, 99pc dc)	WLAN	8.65	± 9.6 %
10543	AAC	IEEE 802.11ac WiFi (40MHz, MCS9, 99pc dc)	WLAN	8.65	± 9.6 %
10544	AAC	IEEE 802.11ac WiFi (80MHz, MCS0, 99pc dc)	WLAN	8.47	± 9.6 %
10545	AAC	IEEE 802.11ac WiFi (80MHz, MCS1, 99pc dc)	WLAN	8.55	± 9.6 %
10546	AAC	IEEE 802.11ac WiFi (80MHz, MCS2, 99pc dc)	WLAN	8.35	± 9.6 %

10547	AAC	IEEE 802.11ac WiFi (80MHz, MCS3, 99pc dc)	WLAN	8.49	± 9.6 %
10548	AAC	IEEE 802.11ac WiFi (80MHz, MCS4, 99pc dc)	WLAN	8.37	± 9.6 %
10550	AAC	IEEE 802.11ac WiFi (80MHz, MCS6, 99pc dc)	WLAN	8.39	± 9.6 %
10551	AAC	IEEE 802.11ac WiFi (80MHz, MCS7, 99pc dc)	WLAN	8.50	± 9.6 %
10552	AAC	IEEE 802.11ac WiFi (80MHz, MCS8, 99pc dc)	WLAN	8.42	± 9.6 %
10553	AAC	IEEE 802.11ac WiFi (80MHz, MCS9, 99pc dc)	WLAN	8.45	± 9.6 %
10554	AAD	IEEE 802.11ac WiFi (160MHz, MCS0, 99pc dc)	WLAN	8.48	± 9.6 %
10555	AAD	IEEE 802.11ac WiFi (160MHz, MCS1, 99pc dc)	WLAN	8.47	± 9.6 %
10556	AAD	IEEE 802.11ac WiFi (160MHz, MCS2, 99pc dc)	WLAN	8.50	± 9.6 %
10557	AAD	IEEE 802.11ac WiFi (160MHz, MCS3, 99pc dc)	WLAN	8.52	± 9.6 %
10558	AAD	IEEE 802.11ac WiFi (160MHz, MCS4, 99pc dc)	WLAN	8.61	± 9.6 %
10560	AAD	IEEE 802.11ac WiFi (160MHz, MCS6, 99pc dc)	WLAN	8.73	± 9.6 %
10561	AAD	IEEE 802.11ac WiFi (160MHz, MCS7, 99pc dc)	WLAN	8.56	± 9.6 %
10562	AAD	IEEE 802.11ac WiFi (160MHz, MCS8, 99pc dc)	WLAN	8.69	± 9.6 %
10563	AAD	IEEE 802.11ac WiFi (160MHz, MCS9, 99pc dc)	WLAN	8.77	± 9.6 %
10564	AAA	IEEE 802.11g WiFi 2.4 GHz (DSSS-OFDM, 9 Mbps, 99pc dc)	WLAN	8.25	± 9.6 %
10565	AAA	IEEE 802.11g WiFi 2.4 GHz (DSSS-OFDM, 12 Mbps, 99pc dc)	WLAN	8.45	± 9.6 %
10566	AAA	IEEE 802.11g WiFi 2.4 GHz (DSSS-OFDM, 18 Mbps, 99pc dc)	WLAN	8.13	± 9.6 %
10567	AAA	IEEE 802.11g WiFi 2.4 GHz (DSSS-OFDM, 24 Mbps, 99pc dc)	WLAN	8.00	± 9.6 %
10568	AAA	IEEE 802.11g WiFi 2.4 GHz (DSSS-OFDM, 36 Mbps, 99pc dc)	WLAN	8.37	± 9.6 %
10569	AAA	IEEE 802.11g WiFi 2.4 GHz (DSSS-OFDM, 48 Mbps, 99pc dc)	WLAN	8.10	± 9.6 %
10570	AAA	IEEE 802.11g WiFi 2.4 GHz (DSSS-OFDM, 54 Mbps, 99pc dc)	WLAN	8.30	± 9.6 %
10571	AAA	IEEE 802.11b WiFi 2.4 GHz (DSSS, 1 Mbps, 90pc dc)	WLAN	1.99	± 9.6 %
10572	AAA	IEEE 802.11b WiFi 2.4 GHz (DSSS, 2 Mbps, 90pc dc)	WLAN	1.99	± 9.6 %
10573	AAA	IEEE 802.11b WiFi 2.4 GHz (DSSS, 5.5 Mbps, 90pc dc)	WLAN	1.98	± 9.6 %
10574	AAA	IEEE 802.11b WiFi 2.4 GHz (DSSS, 11 Mbps, 90pc dc)	WLAN	1.98	± 9.6 %
10575	AAA	IEEE 802.11g WiFi 2.4 GHz (DSSS-OFDM, 6 Mbps, 90pc dc)	WLAN	8.59	± 9.6 %
10576	AAA	IEEE 802.11g WiFi 2.4 GHz (DSSS-OFDM, 9 Mbps, 90pc dc)	WLAN	8.60	± 9.6 %
10577	AAA	IEEE 802.11g WiFi 2.4 GHz (DSSS-OFDM, 12 Mbps, 90pc dc)	WLAN	8.70	± 9.6 %
10578	AAA	IEEE 802.11g WiFi 2.4 GHz (DSSS-OFDM, 18 Mbps, 90pc dc)	WLAN	8.49	± 9.6 %
10579	AAA	IEEE 802.11g WiFi 2.4 GHz (DSSS-OFDM, 24 Mbps, 90pc dc)	WLAN	8.36	± 9.6 %
10580	AAA	IEEE 802.11g WiFi 2.4 GHz (DSSS-OFDM, 36 Mbps, 90pc dc)	WLAN	8.76	± 9.6 %
10581	AAA	IEEE 802.11g WiFi 2.4 GHz (DSSS-OFDM, 48 Mbps, 90pc dc)	WLAN	8.35	± 9.6 %
10582	AAA	IEEE 802.11g WiFi 2.4 GHz (DSSS-OFDM, 54 Mbps, 90pc dc)	WLAN	8.67	± 9.6 %
10583	AAC	IEEE 802.11a/h WiFi 5 GHz (OFDM, 6 Mbps, 90pc dc)	WLAN	8.59	± 9.6 %
10584	AAC	IEEE 802.11a/h WiFi 5 GHz (OFDM, 9 Mbps, 90pc dc)	WLAN	8.60	± 9.6 %
10585	AAC	IEEE 802.11a/h WiFi 5 GHz (OFDM, 12 Mbps, 90pc dc)	WLAN	8.70	± 9.6 %
10586	AAC	IEEE 802.11a/h WiFi 5 GHz (OFDM, 18 Mbps, 90pc dc)	WLAN	8.49	± 9.6 %
10587	AAC	IEEE 802.11a/h WiFi 5 GHz (OFDM, 24 Mbps, 90pc dc)	WLAN	8.36	± 9.6 %
10588	AAC	IEEE 802.11a/h WiFi 5 GHz (OFDM, 36 Mbps, 90pc dc)	WLAN	8.76	± 9.6 %
10589	AAC	IEEE 802.11a/h WiFi 5 GHz (OFDM, 48 Mbps, 90pc dc)	WLAN	8.35	± 9.6 %
10590	AAC	IEEE 802.11a/h WiFi 5 GHz (OFDM, 54 Mbps, 90pc dc)	WLAN	8.67	± 9.6 %
10591	AAC	IEEE 802.11n (HT Mixed, 20MHz, MCS0, 90pc dc)	WLAN	8.63	± 9.6 %
10592	AAC	IEEE 802.11n (HT Mixed, 20MHz, MCS1, 90pc dc)	WLAN	8.79	± 9.6 %
10593	AAC	IEEE 802.11n (HT Mixed, 20MHz, MCS2, 90pc dc)	WLAN	8.64	± 9.6 %
10594	AAC	IEEE 802.11n (HT Mixed, 20MHz, MCS3, 90pc dc)	WLAN	8.74	± 9.6 %
10595	AAC	IEEE 802.11n (HT Mixed, 20MHz, MCS4, 90pc dc)	WLAN	8.74	± 9.6 %
10596	AAC	IEEE 802.11n (HT Mixed, 20MHz, MCS5, 90pc dc)	WLAN	8.71	± 9.6 %
10597	AAC	IEEE 802.11n (HT Mixed, 20MHz, MCS6, 90pc dc)	WLAN	8.72	± 9.6 %
10598	AAC	IEEE 802.11n (HT Mixed, 20MHz, MCS7, 90pc dc)	WLAN	8.50	± 9.6 %
10599	AAC	IEEE 802.11n (HT Mixed, 40MHz, MCS0, 90pc dc)	WLAN	8.79	± 9.6 %
10600	AAC	IEEE 802.11n (HT Mixed, 40MHz, MCS1, 90pc dc)	WLAN	8.88	± 9.6 %
10601	AAC	IEEE 802.11n (HT Mixed, 40MHz, MCS2, 90pc dc)	WLAN	8.82	± 9.6 %
10602	AAC	IEEE 802.11n (HT Mixed, 40MHz, MCS3, 90pc dc)	WLAN	8.94	± 9.6 %
10603	AAC	IEEE 802.11n (HT Mixed, 40MHz, MCS4, 90pc dc)	WLAN	9.03	± 9.6 %
10604	AAC	IEEE 802.11n (HT Mixed, 40MHz, MCS5, 90pc dc)	WLAN	8.76	± 9.6 %

10605	AAC	IEEE 802.11n (HT Mixed, 40MHz, MCS6, 90pc dc)	WLAN	8.97	± 9.6 %
10606	AAC	IEEE 802.11n (HT Mixed, 40MHz, MCS7, 90pc dc)	WLAN	8.82	± 9.6 %
10607	AAC	IEEE 802.11ac WiFi (20MHz, MCS0, 90pc dc)	WLAN	8.64	± 9.6 %
10608	AAC	IEEE 802.11ac WiFi (20MHz, MCS1, 90pc dc)	WLAN	8.77	± 9.6 %
10609	AAC	IEEE 802.11ac WiFi (20MHz, MCS2, 90pc dc)	WLAN	8.57	± 9.6 %
10610	AAC	IEEE 802.11ac WiFi (20MHz, MCS3, 90pc dc)	WLAN	8.78	± 9.6 %
10611	AAC	IEEE 802.11ac WiFi (20MHz, MCS4, 90pc dc)	WLAN	8.70	± 9.6 %
10612	AAC	IEEE 802.11ac WiFi (20MHz, MCS5, 90pc dc)	WLAN	8.77	± 9.6 %
10613	AAC	IEEE 802.11ac WiFi (20MHz, MCS6, 90pc dc)	WLAN	8.94	± 9.6 %
10614	AAC	IEEE 802.11ac WiFi (20MHz, MCS7, 90pc dc)	WLAN	8.59	± 9.6 %
10615	AAC	IEEE 802.11ac WiFi (20MHz, MCS8, 90pc dc)	WLAN	8.82	± 9.6 %
10616	AAC	IEEE 802.11ac WiFi (40MHz, MCS0, 90pc dc)	WLAN	8.82	± 9.6 %
10617	AAC	IEEE 802.11ac WiFi (40MHz, MCS1, 90pc dc)	WLAN	8.81	± 9.6 %
10618	AAC	IEEE 802.11ac WiFi (40MHz, MCS2, 90pc dc)	WLAN	8.58	± 9.6 %
10619	AAC	IEEE 802.11ac WiFi (40MHz, MCS3, 90pc dc)	WLAN	8.86	± 9.6 %
10620	AAC	IEEE 802.11ac WiFi (40MHz, MCS4, 90pc dc)	WLAN	8.87	± 9.6 %
10621	AAC	IEEE 802.11ac WiFi (40MHz, MCS5, 90pc dc)	WLAN	8.77	± 9.6 %
10622	AAC	IEEE 802.11ac WiFi (40MHz, MCS6, 90pc dc)	WLAN	8.68	± 9.6 %
10623	AAC	IEEE 802.11ac WiFi (40MHz, MCS7, 90pc dc)	WLAN	8.82	± 9.6 %
10624	AAC	IEEE 802.11ac WiFi (40MHz, MCS8, 90pc dc)	WLAN	8.96	± 9.6 %
10625	AAC	IEEE 802.11ac WiFi (40MHz, MCS9, 90pc dc)	WLAN	8.96	± 9.6 %
10626	AAC	IEEE 802.11ac WiFi (80MHz, MCS0, 90pc dc)	WLAN	8.83	± 9.6 %
10627	AAC	IEEE 802.11ac WiFi (80MHz, MCS1, 90pc dc)	WLAN	8.88	± 9.6 %
10628	AAC	IEEE 802.11ac WiFi (80MHz, MCS2, 90pc dc)	WLAN	8.71	± 9.6 %
10629	AAC	IEEE 802.11ac WiFi (80MHz, MCS3, 90pc dc)	WLAN	8.85	± 9.6 %
10630	AAC	IEEE 802.11ac WiFi (80MHz, MCS4, 90pc dc)	WLAN	8.72	± 9.6 %
10631	AAC	IEEE 802.11ac WiFi (80MHz, MCS5, 90pc dc)	WLAN	8.81	± 9.6 %
10632	AAC	IEEE 802.11ac WiFi (80MHz, MCS6, 90pc dc)	WLAN	8.74	± 9.6 %
10633	AAC	IEEE 802.11ac WiFi (80MHz, MCS7, 90pc dc)	WLAN	8.83	± 9.6 %
10634	AAC	IEEE 802.11ac WiFi (80MHz, MCS8, 90pc dc)	WLAN	8.80	± 9.6 %
10635	AAC	IEEE 802.11ac WiFi (80MHz, MCS9, 90pc dc)	WLAN	8.81	± 9.6 %
10636	AAD	IEEE 802.11ac WiFi (160MHz, MCS0, 90pc dc)	WLAN	8.83	± 9.6 %
10637	AAD	IEEE 802.11ac WiFi (160MHz, MCS1, 90pc dc)	WLAN	8.79	± 9.6 %
10638	AAD	IEEE 802.11ac WiFi (160MHz, MCS2, 90pc dc)	WLAN	8.86	± 9.6 %
10639	AAD	IEEE 802.11ac WiFi (160MHz, MCS3, 90pc dc)	WLAN	8.85	± 9.6 %
10640	AAD	IEEE 802.11ac WiFi (160MHz, MCS4, 90pc dc)	WLAN	8.98	± 9.6 %
10641	AAD	IEEE 802.11ac WiFi (160MHz, MCS5, 90pc dc)	WLAN	9.06	± 9.6 %
10642	AAD	IEEE 802.11ac WiFi (160MHz, MCS6, 90pc dc)	WLAN	9.06	± 9.6 %
10643	AAD	IEEE 802.11ac WiFi (160MHz, MCS7, 90pc dc)	WLAN	8.89	± 9.6 %
10644	AAD	IEEE 802.11ac WiFi (160MHz, MCS8, 90pc dc)	WLAN	9.05	± 9.6 %
10645	AAD	IEEE 802.11ac WiFi (160MHz, MCS9, 90pc dc)	WLAN	9.11	± 9.6 %
10646	AAG	LTE-TDD (SC-FDMA, 1 RB, 5 MHz, QPSK, UL Sub=2,7)	LTE-TDD	11.96	± 9.6 %
10647	AAF	LTE-TDD (SC-FDMA, 1 RB, 20 MHz, QPSK, UL Sub=2,7)	LTE-TDD	11.96	± 9.6 %
10648	AAA	CDMA2000 (1x Advanced)	CDMA2000	3.45	± 9.6 %
10652	AAE	LTE-TDD (OFDMA, 5 MHz, E-TM 3.1, Clipping 44%)	LTE-TDD	6.91	± 9.6 %
10653	AAE	LTE-TDD (OFDMA, 10 MHz, E-TM 3.1, Clipping 44%)	LTE-TDD	7.42	± 9.6 %
10654	AAD	LTE-TDD (OFDMA, 15 MHz, E-TM 3.1, Clipping 44%)	LTE-TDD	6.96	± 9.6 %
10655	AAE	LTE-TDD (OFDMA, 20 MHz, E-TM 3.1, Clipping 44%)	LTE-TDD	7.21	± 9.6 %
10658	AAA	Pulse Waveform (200Hz, 10%)	Test	10.00	± 9.6 %
10659	AAA	Pulse Waveform (200Hz, 20%)	Test	6.99	± 9.6 %
10660	AAA	Pulse Waveform (200Hz, 40%)	Test	3.98	± 9.6 %
10661	AAA	Pulse Waveform (200Hz, 60%)	Test	2.22	± 9.6 %
10662	AAA	Pulse Waveform (200Hz, 80%)	Test	0.97	± 9.6 %
10670	AAA	Bluetooth Low Energy	Bluetooth	2.19	± 9.6 %
10671	AAC	IEEE 802.11ax (20MHz, MCS0, 90pc dc)	WLAN	9.09	± 9.6 %
10672	AAC	IEEE 802.11ax (20MHz, MCS1, 90pc dc)	WLAN	8.57	± 9.6 %

10673	AAC	IEEE 802.11ax (20MHz, MCS2, 90pc dc)	WLAN	8.78	± 9.6 %
10674	AAC	IEEE 802.11ax (20MHz, MCS3, 90pc dc)	WLAN	8.74	± 9.6 %
10675	AAC	IEEE 802.11ax (20MHz, MCS4, 90pc dc)	WLAN	8.90	± 9.6 %
10676	AAC	IEEE 802.11ax (20MHz, MCS5, 90pc dc)	WLAN	8.77	± 9.6 %
10677	AAC	IEEE 802.11ax (20MHz, MCS6, 90pc dc)	WLAN	8.73	± 9.6 %
10678	AAC	IEEE 802.11ax (20MHz, MCS7, 90pc dc)	WLAN	8.78	± 9.6 %
10679	AAC	IEEE 802.11ax (20MHz, MCS8, 90pc dc)	WLAN	8.89	± 9.6 %
10680	AAC	IEEE 802.11ax (20MHz, MCS9, 90pc dc)	WLAN	8.80	± 9.6 %
10681	AAC	IEEE 802.11ax (20MHz, MCS10, 90pc dc)	WLAN	8.62	± 9.6 %
10682	AAC	IEEE 802.11ax (20MHz, MCS11, 90pc dc)	WLAN	8.83	± 9.6 %
10683	AAC	IEEE 802.11ax (20MHz, MCS0, 99pc dc)	WLAN	8.42	± 9.6 %
10684	AAC	IEEE 802.11ax (20MHz, MCS1, 99pc dc)	WLAN	8.26	± 9.6 %
10685	AAC	IEEE 802.11ax (20MHz, MCS2, 99pc dc)	WLAN	8.33	± 9.6 %
10686	AAC	IEEE 802.11ax (20MHz, MCS3, 99pc dc)	WLAN	8.28	± 9.6 %
10687	AAC	IEEE 802.11ax (20MHz, MCS4, 99pc dc)	WLAN	8.45	± 9.6 %
10688	AAC	IEEE 802.11ax (20MHz, MCS5, 99pc dc)	WLAN	8.29	± 9.6 %
10689	AAC	IEEE 802.11ax (20MHz, MCS6, 99pc dc)	WLAN	8.55	± 9.6 %
10690	AAC	IEEE 802.11ax (20MHz, MCS7, 99pc dc)	WLAN	8.29	± 9.6 %
10691	AAC	IEEE 802.11ax (20MHz, MCS8, 99pc dc)	WLAN	8.25	± 9.6 %
10692	AAC	IEEE 802.11ax (20MHz, MCS9, 99pc dc)	WLAN	8.29	± 9.6 %
10693	AAC	IEEE 802.11ax (20MHz, MCS10, 99pc dc)	WLAN	8.25	± 9.6 %
10694	AAC	IEEE 802.11ax (20MHz, MCS11, 99pc dc)	WLAN	8.57	± 9.6 %
10695	AAC	IEEE 802.11ax (40MHz, MCS0, 90pc dc)	WLAN	8.78	± 9.6 %
10696	AAC	IEEE 802.11ax (40MHz, MCS1, 90pc dc)	WLAN	8.91	± 9.6 %
10697	AAC	IEEE 802.11ax (40MHz, MCS2, 90pc dc)	WLAN	8.61	± 9.6 %
10698	AAC	IEEE 802.11ax (40MHz, MCS3, 90pc dc)	WLAN	8.89	± 9.6 %
10699	AAC	IEEE 802.11ax (40MHz, MCS4, 90pc dc)	WLAN	8.82	± 9.6 %
10700	AAC	IEEE 802.11ax (40MHz, MCS5, 90pc dc)	WLAN	8.73	± 9.6 %
10701	AAC	IEEE 802.11ax (40MHz, MCS6, 90pc dc)	WLAN	8.86	± 9.6 %
10702	AAC	IEEE 802.11ax (40MHz, MCS7, 90pc dc)	WLAN	8.70	± 9.6 %
10703	AAC	IEEE 802.11ax (40MHz, MCS8, 90pc dc)	WLAN	8.82	± 9.6 %
10704	AAC	IEEE 802.11ax (40MHz, MCS9, 90pc dc)	WLAN	8.56	± 9.6 %
10705	AAC	IEEE 802.11ax (40MHz, MCS10, 90pc dc)	WLAN	8.69	± 9.6 %
10706	AAC	IEEE 802.11ax (40MHz, MCS11, 90pc dc)	WLAN	8.66	± 9.6 %
10707	AAC	IEEE 802.11ax (40MHz, MCS0, 99pc dc)	WLAN	8.32	± 9.6 %
10708	AAC	IEEE 802.11ax (40MHz, MCS1, 99pc dc)	WLAN	8.55	± 9.6 %
10709	AAC	IEEE 802.11ax (40MHz, MCS2, 99pc dc)	WLAN	8.33	± 9.6 %
10710	AAC	IEEE 802.11ax (40MHz, MCS3, 99pc dc)	WLAN	8.29	± 9.6 %
10711	AAC	IEEE 802.11ax (40MHz, MCS4, 99pc dc)	WLAN	8.39	± 9.6 %
10712	AAC	IEEE 802.11ax (40MHz, MCS5, 99pc dc)	WLAN	8.67	± 9.6 %
10713	AAC	IEEE 802.11ax (40MHz, MCS6, 99pc dc)	WLAN	8.33	± 9.6 %
10714	AAC	IEEE 802.11ax (40MHz, MCS7, 99pc dc)	WLAN	8.26	± 9.6 %
10715	AAC	IEEE 802.11ax (40MHz, MCS8, 99pc dc)	WLAN	8.45	± 9.6 %
10716	AAC	IEEE 802.11ax (40MHz, MCS9, 99pc dc)	WLAN	8.30	± 9.6 %
10717	AAC	IEEE 802.11ax (40MHz, MCS10, 99pc dc)	WLAN	8.48	± 9.6 %
10718	AAC	IEEE 802.11ax (40MHz, MCS11, 99pc dc)	WLAN	8.24	± 9.6 %
10719	AAC	IEEE 802.11ax (80MHz, MCS0, 90pc dc)	WLAN	8.81	± 9.6 %
10720	AAC	IEEE 802.11ax (80MHz, MCS1, 90pc dc)	WLAN	8.87	± 9.6 %
10721	AAC	IEEE 802.11ax (80MHz, MCS2, 90pc dc)	WLAN	8.76	± 9.6 %
10722	AAC	IEEE 802.11ax (80MHz, MCS3, 90pc dc)	WLAN	8.55	± 9.6 %
10723	AAC	IEEE 802.11ax (80MHz, MCS4, 90pc dc)	WLAN	8.70	± 9.6 %
10724	AAC	IEEE 802.11ax (80MHz, MCS5, 90pc dc)	WLAN	8.90	± 9.6 %
10725	AAC	IEEE 802.11ax (80MHz, MCS6, 90pc dc)	WLAN	8.74	± 9.6 %
10726	AAC	IEEE 802.11ax (80MHz, MCS7, 90pc dc)	WLAN	8.72	± 9.6 %
10727	AAC	IEEE 802.11ax (80MHz, MCS8, 90pc dc)	WLAN	8.66	± 9.6 %
10728	AAC	IEEE 802.11ax (80MHz, MCS9, 90pc dc)	WLAN	8.65	± 9.6 %

10729	AAC	IEEE 802.11ax (80MHz, MCS10, 90pc dc)	WLAN	8.64	± 9.6 %
10730	AAC	IEEE 802.11ax (80MHz, MCS11, 90pc dc)	WLAN	8.67	± 9.6 %
10731	AAC	IEEE 802.11ax (80MHz, MCS0, 99pc dc)	WLAN	8.42	± 9.6 %
10732	AAC	IEEE 802.11ax (80MHz, MCS1, 99pc dc)	WLAN	8.46	± 9.6 %
10733	AAC	IEEE 802.11ax (80MHz, MCS2, 99pc dc)	WLAN	8.40	± 9.6 %
10734	AAC	IEEE 802.11ax (80MHz, MCS3, 99pc dc)	WLAN	8.25	± 9.6 %
10735	AAC	IEEE 802.11ax (80MHz, MCS4, 99pc dc)	WLAN	8.33	± 9.6 %
10736	AAC	IEEE 802.11ax (80MHz, MCS5, 99pc dc)	WLAN	8.27	± 9.6 %
10737	AAC	IEEE 802.11ax (80MHz, MCS6, 99pc dc)	WLAN	8.36	± 9.6 %
10738	AAC	IEEE 802.11ax (80MHz, MCS7, 99pc dc)	WLAN	8.42	± 9.6 %
10739	AAC	IEEE 802.11ax (80MHz, MCS8, 99pc dc)	WLAN	8.29	± 9.6 %
10740	AAC	IEEE 802.11ax (80MHz, MCS9, 99pc dc)	WLAN	8.48	± 9.6 %
10741	AAC	IEEE 802.11ax (80MHz, MCS10, 99pc dc)	WLAN	8.40	± 9.6 %
10742	AAC	IEEE 802.11ax (80MHz, MCS11, 99pc dc)	WLAN	8.43	± 9.6 %
10743	AAC	IEEE 802.11ax (160MHz, MCS0, 90pc dc)	WLAN	8.94	± 9.6 %
10744	AAC	IEEE 802.11ax (160MHz, MCS1, 90pc dc)	WLAN	9.16	± 9.6 %
10745	AAC	IEEE 802.11ax (160MHz, MCS2, 90pc dc)	WLAN	8.93	± 9.6 %
10746	AAC	IEEE 802.11ax (160MHz, MCS3, 90pc dc)	WLAN	9.11	± 9.6 %
10747	AAC	IEEE 802.11ax (160MHz, MCS4, 90pc dc)	WLAN	9.04	± 9.6 %
10748	AAC	IEEE 802.11ax (160MHz, MCS5, 90pc dc)	WLAN	8.93	± 9.6 %
10749	AAC	IEEE 802.11ax (160MHz, MCS6, 90pc dc)	WLAN	8.90	± 9.6 %
10750	AAC	IEEE 802.11ax (160MHz, MCS7, 90pc dc)	WLAN	8.79	± 9.6 %
10751	AAC	IEEE 802.11ax (160MHz, MCS8, 90pc dc)	WLAN	8.82	± 9.6 %
10752	AAC	IEEE 802.11ax (160MHz, MCS9, 90pc dc)	WLAN	8.81	± 9.6 %
10753	AAC	IEEE 802.11ax (160MHz, MCS10, 90pc dc)	WLAN	9.00	± 9.6 %
10754	AAC	IEEE 802.11ax (160MHz, MCS11, 90pc dc)	WLAN	8.94	± 9.6 %
10755	AAC	IEEE 802.11ax (160MHz, MCS0, 99pc dc)	WLAN	8.64	± 9.6 %
10756	AAC	IEEE 802.11ax (160MHz, MCS1, 99pc dc)	WLAN	8.77	± 9.6 %
10757	AAC	IEEE 802.11ax (160MHz, MCS2, 99pc dc)	WLAN	8.77	± 9.6 %
10758	AAC	IEEE 802.11ax (160MHz, MCS3, 99pc dc)	WLAN	8.69	± 9.6 %
10759	AAC	IEEE 802.11ax (160MHz, MCS4, 99pc dc)	WLAN	8.58	± 9.6 %
10760	AAC	IEEE 802.11ax (160MHz, MCS5, 99pc dc)	WLAN	8.49	± 9.6 %
10761	AAC	IEEE 802.11ax (160MHz, MCS6, 99pc dc)	WLAN	8.58	± 9.6 %
10762	AAC	IEEE 802.11ax (160MHz, MCS7, 99pc dc)	WLAN	8.49	± 9.6 %
10763	AAC	IEEE 802.11ax (160MHz, MCS8, 99pc dc)	WLAN	8.53	± 9.6 %
10764	AAC	IEEE 802.11ax (160MHz, MCS9, 99pc dc)	WLAN	8.54	± 9.6 %
10765	AAC	IEEE 802.11ax (160MHz, MCS10, 99pc dc)	WLAN	8.54	± 9.6 %
10766	AAC	IEEE 802.11ax (160MHz, MCS11, 99pc dc)	WLAN	8.51	± 9.6 %
10767	AAE	5G NR (CP-OFDM, 1 RB, 5 MHz, QPSK, 15 kHz)	5G NR FR1 TDD	7.99	± 9.6 %
10768	AAD	5G NR (CP-OFDM, 1 RB, 10 MHz, QPSK, 15 kHz)	5G NR FR1 TDD	8.01	± 9.6 %
10769	AAD	5G NR (CP-OFDM, 1 RB, 15 MHz, QPSK, 15 kHz)	5G NR FR1 TDD	8.01	± 9.6 %
10770	AAD	5G NR (CP-OFDM, 1 RB, 20 MHz, QPSK, 15 kHz)	5G NR FR1 TDD	8.02	± 9.6 %
10771	AAD	5G NR (CP-OFDM, 1 RB, 25 MHz, QPSK, 15 kHz)	5G NR FR1 TDD	8.02	± 9.6 %
10772	AAD	5G NR (CP-OFDM, 1 RB, 30 MHz, QPSK, 15 kHz)	5G NR FR1 TDD	8.23	± 9.6 %
10773	AAD	5G NR (CP-OFDM, 1 RB, 40 MHz, QPSK, 15 kHz)	5G NR FR1 TDD	8.03	± 9.6 %
10774	AAD	5G NR (CP-OFDM, 1 RB, 50 MHz, QPSK, 15 kHz)	5G NR FR1 TDD	8.02	± 9.6 %
10775	AAD	5G NR (CP-OFDM, 50% RB, 5 MHz, QPSK, 15 kHz)	5G NR FR1 TDD	8.31	± 9.6 %
10776	AAD	5G NR (CP-OFDM, 50% RB, 10 MHz, QPSK, 15 kHz)	5G NR FR1 TDD	8.30	± 9.6 %
10777	AAC	5G NR (CP-OFDM, 50% RB, 15 MHz, QPSK, 15 kHz)	5G NR FR1 TDD	8.30	± 9.6 %
10778	AAD	5G NR (CP-OFDM, 50% RB, 20 MHz, QPSK, 15 kHz)	5G NR FR1 TDD	8.34	± 9.6 %
10779	AAC	5G NR (CP-OFDM, 50% RB, 25 MHz, QPSK, 15 kHz)	5G NR FR1 TDD	8.42	± 9.6 %
10780	AAD	5G NR (CP-OFDM, 50% RB, 30 MHz, QPSK, 15 kHz)	5G NR FR1 TDD	8.38	± 9.6 %
10781	AAD	5G NR (CP-OFDM, 50% RB, 40 MHz, QPSK, 15 kHz)	5G NR FR1 TDD	8.38	± 9.6 %
10782	AAD	5G NR (CP-OFDM, 50% RB, 50 MHz, QPSK, 15 kHz)	5G NR FR1 TDD	8.43	± 9.6 %
10783	AAE	5G NR (CP-OFDM, 100% RB, 5 MHz, QPSK, 15 kHz)	5G NR FR1 TDD	8.31	± 9.6 %
10784	AAD	5G NR (CP-OFDM, 100% RB, 10 MHz, QPSK, 15 kHz)	5G NR FR1 TDD	8.29	± 9.6 %

10785	AAD	5G NR (CP-OFDM, 100% RB, 15 MHz, QPSK, 15 kHz)	5G NR FR1 TDD	8.40	± 9.6 %
10786	AAD	5G NR (CP-OFDM, 100% RB, 20 MHz, QPSK, 15 kHz)	5G NR FR1 TDD	8.35	± 9.6 %
10787	AAD	5G NR (CP-OFDM, 100% RB, 25 MHz, QPSK, 15 kHz)	5G NR FR1 TDD	8.44	± 9.6 %
10788	AAD	5G NR (CP-OFDM, 100% RB, 30 MHz, QPSK, 15 kHz)	5G NR FR1 TDD	8.39	± 9.6 %
10789	AAD	5G NR (CP-OFDM, 100% RB, 40 MHz, QPSK, 15 kHz)	5G NR FR1 TDD	8.37	± 9.6 %
10790	AAD	5G NR (CP-OFDM, 100% RB, 50 MHz, QPSK, 15 kHz)	5G NR FR1 TDD	8.39	± 9.6 %
10791	AAE	5G NR (CP-OFDM, 1 RB, 5 MHz, QPSK, 30 kHz)	5G NR FR1 TDD	7.83	± 9.6 %
10792	AAD	5G NR (CP-OFDM, 1 RB, 10 MHz, QPSK, 30 kHz)	5G NR FR1 TDD	7.92	± 9.6 %
10793	AAD	5G NR (CP-OFDM, 1 RB, 15 MHz, QPSK, 30 kHz)	5G NR FR1 TDD	7.95	± 9.6 %
10794	AAD	5G NR (CP-OFDM, 1 RB, 20 MHz, QPSK, 30 kHz)	5G NR FR1 TDD	7.82	± 9.6 %
10795	AAD	5G NR (CP-OFDM, 1 RB, 25 MHz, QPSK, 30 kHz)	5G NR FR1 TDD	7.84	± 9.6 %
10796	AAD	5G NR (CP-OFDM, 1 RB, 30 MHz, QPSK, 30 kHz)	5G NR FR1 TDD	7.82	± 9.6 %
10797	AAD	5G NR (CP-OFDM, 1 RB, 40 MHz, QPSK, 30 kHz)	5G NR FR1 TDD	8.01	± 9.6 %
10798	AAD	5G NR (CP-OFDM, 1 RB, 50 MHz, QPSK, 30 kHz)	5G NR FR1 TDD	7.89	± 9.6 %
10799	AAD	5G NR (CP-OFDM, 1 RB, 60 MHz, QPSK, 30 kHz)	5G NR FR1 TDD	7.93	± 9.6 %
10801	AAD	5G NR (CP-OFDM, 1 RB, 80 MHz, QPSK, 30 kHz)	5G NR FR1 TDD	7.89	± 9.6 %
10802	AAD	5G NR (CP-OFDM, 1 RB, 90 MHz, QPSK, 30 kHz)	5G NR FR1 TDD	7.87	± 9.6 %
10803	AAD	5G NR (CP-OFDM, 1 RB, 100 MHz, QPSK, 30 kHz)	5G NR FR1 TDD	7.93	± 9.6 %
10805	AAD	5G NR (CP-OFDM, 50% RB, 10 MHz, QPSK, 30 kHz)	5G NR FR1 TDD	8.34	± 9.6 %
10806	AAD	5G NR (CP-OFDM, 50% RB, 15 MHz, QPSK, 30 kHz)	5G NR FR1 TDD	8.37	± 9.6 %
10809	AAD	5G NR (CP-OFDM, 50% RB, 30 MHz, QPSK, 30 kHz)	5G NR FR1 TDD	8.34	± 9.6 %
10810	AAD	5G NR (CP-OFDM, 50% RB, 40 MHz, QPSK, 30 kHz)	5G NR FR1 TDD	8.34	± 9.6 %
10812	AAD	5G NR (CP-OFDM, 50% RB, 60 MHz, QPSK, 30 kHz)	5G NR FR1 TDD	8.35	± 9.6 %
10817	AAE	5G NR (CP-OFDM, 100% RB, 5 MHz, QPSK, 30 kHz)	5G NR FR1 TDD	8.35	± 9.6 %
10818	AAD	5G NR (CP-OFDM, 100% RB, 10 MHz, QPSK, 30 kHz)	5G NR FR1 TDD	8.34	± 9.6 %
10819	AAD	5G NR (CP-OFDM, 100% RB, 15 MHz, QPSK, 30 kHz)	5G NR FR1 TDD	8.33	± 9.6 %
10820	AAD	5G NR (CP-OFDM, 100% RB, 20 MHz, QPSK, 30 kHz)	5G NR FR1 TDD	8.30	± 9.6 %
10821	AAD	5G NR (CP-OFDM, 100% RB, 25 MHz, QPSK, 30 kHz)	5G NR FR1 TDD	8.41	± 9.6 %
10822	AAD	5G NR (CP-OFDM, 100% RB, 30 MHz, QPSK, 30 kHz)	5G NR FR1 TDD	8.41	± 9.6 %
10823	AAD	5G NR (CP-OFDM, 100% RB, 40 MHz, QPSK, 30 kHz)	5G NR FR1 TDD	8.36	± 9.6 %
10824	AAD	5G NR (CP-OFDM, 100% RB, 50 MHz, QPSK, 30 kHz)	5G NR FR1 TDD	8.39	± 9.6 %
10825	AAD	5G NR (CP-OFDM, 100% RB, 60 MHz, QPSK, 30 kHz)	5G NR FR1 TDD	8.41	± 9.6 %
10827	AAD	5G NR (CP-OFDM, 100% RB, 80 MHz, QPSK, 30 kHz)	5G NR FR1 TDD	8.42	± 9.6 %
10828	AAD	5G NR (CP-OFDM, 100% RB, 90 MHz, QPSK, 30 kHz)	5G NR FR1 TDD	8.43	± 9.6 %
10829	AAD	5G NR (CP-OFDM, 100% RB, 100 MHz, QPSK, 30 kHz)	5G NR FR1 TDD	8.40	± 9.6 %
10830	AAD	5G NR (CP-OFDM, 1 RB, 10 MHz, QPSK, 60 kHz)	5G NR FR1 TDD	7.63	± 9.6 %
10831	AAD	5G NR (CP-OFDM, 1 RB, 15 MHz, QPSK, 60 kHz)	5G NR FR1 TDD	7.73	± 9.6 %
10832	AAD	5G NR (CP-OFDM, 1 RB, 20 MHz, QPSK, 60 kHz)	5G NR FR1 TDD	7.74	± 9.6 %
10833	AAD	5G NR (CP-OFDM, 1 RB, 25 MHz, QPSK, 60 kHz)	5G NR FR1 TDD	7.70	± 9.6 %
10834	AAD	5G NR (CP-OFDM, 1 RB, 30 MHz, QPSK, 60 kHz)	5G NR FR1 TDD	7.75	± 9.6 %
10835	AAD	5G NR (CP-OFDM, 1 RB, 40 MHz, QPSK, 60 kHz)	5G NR FR1 TDD	7.70	± 9.6 %
10836	AAD	5G NR (CP-OFDM, 1 RB, 50 MHz, QPSK, 60 kHz)	5G NR FR1 TDD	7.66	± 9.6 %
10837	AAD	5G NR (CP-OFDM, 1 RB, 60 MHz, QPSK, 60 kHz)	5G NR FR1 TDD	7.68	± 9.6 %
10839	AAD	5G NR (CP-OFDM, 1 RB, 80 MHz, QPSK, 60 kHz)	5G NR FR1 TDD	7.70	± 9.6 %
10840	AAD	5G NR (CP-OFDM, 1 RB, 90 MHz, QPSK, 60 kHz)	5G NR FR1 TDD	7.67	± 9.6 %
10841	AAD	5G NR (CP-OFDM, 1 RB, 100 MHz, QPSK, 60 kHz)	5G NR FR1 TDD	7.71	± 9.6 %
10843	AAD	5G NR (CP-OFDM, 50% RB, 15 MHz, QPSK, 60 kHz)	5G NR FR1 TDD	8.49	± 9.6 %
10844	AAD	5G NR (CP-OFDM, 50% RB, 20 MHz, QPSK, 60 kHz)	5G NR FR1 TDD	8.34	± 9.6 %
10846	AAD	5G NR (CP-OFDM, 50% RB, 30 MHz, QPSK, 60 kHz)	5G NR FR1 TDD	8.41	± 9.6 %
10854	AAD	5G NR (CP-OFDM, 100% RB, 10 MHz, QPSK, 60 kHz)	5G NR FR1 TDD	8.34	± 9.6 %
10855	AAD	5G NR (CP-OFDM, 100% RB, 15 MHz, QPSK, 60 kHz)	5G NR FR1 TDD	8.36	± 9.6 %
10856	AAD	5G NR (CP-OFDM, 100% RB, 20 MHz, QPSK, 60 kHz)	5G NR FR1 TDD	8.37	± 9.6 %
10857	AAD	5G NR (CP-OFDM, 100% RB, 25 MHz, QPSK, 60 kHz)	5G NR FR1 TDD	8.35	± 9.6 %
10858	AAD	5G NR (CP-OFDM, 100% RB, 30 MHz, QPSK, 60 kHz)	5G NR FR1 TDD	8.36	± 9.6 %
10859	AAD	5G NR (CP-OFDM, 100% RB, 40 MHz, QPSK, 60 kHz)	5G NR FR1 TDD	8.34	± 9.6 %
10860	AAD	5G NR (CP-OFDM, 100% RB, 50 MHz, QPSK, 60 kHz)	5G NR FR1 TDD	8.41	± 9.6 %

10861	AAD	5G NR (CP-OFDM, 100% RB, 60 MHz, QPSK, 60 kHz)	5G NR FR1 TDD	8.40	± 9.6 %
10863	AAD	5G NR (CP-OFDM, 100% RB, 80 MHz, QPSK, 60 kHz)	5G NR FR1 TDD	8.41	± 9.6 %
10864	AAD	5G NR (CP-OFDM, 100% RB, 90 MHz, QPSK, 60 kHz)	5G NR FR1 TDD	8.37	± 9.6 %
10865	AAD	5G NR (CP-OFDM, 100% RB, 100 MHz, QPSK, 60 kHz)	5G NR FR1 TDD	8.41	± 9.6 %
10866	AAD	5G NR (DFT-s-OFDM, 1 RB, 100 MHz, QPSK, 30 kHz)	5G NR FR1 TDD	5.68	± 9.6 %
10868	AAD	5G NR (DFT-s-OFDM, 100% RB, 100 MHz, QPSK, 30 kHz)	5G NR FR1 TDD	5.89	± 9.6 %
10869	AAD	5G NR (DFT-s-OFDM, 1 RB, 100 MHz, QPSK, 120 kHz)	5G NR FR2 TDD	5.75	± 9.6 %
10870	AAD	5G NR (DFT-s-OFDM, 100% RB, 100 MHz, QPSK, 120 kHz)	5G NR FR2 TDD	5.86	± 9.6 %
10871	AAD	5G NR (DFT-s-OFDM, 1 RB, 100 MHz, 16QAM, 120 kHz)	5G NR FR2 TDD	5.75	± 9.6 %
10872	AAD	5G NR (DFT-s-OFDM, 100% RB, 100 MHz, 16QAM, 120 kHz)	5G NR FR2 TDD	6.52	± 9.6 %
10873	AAD	5G NR (DFT-s-OFDM, 1 RB, 100 MHz, 64QAM, 120 kHz)	5G NR FR2 TDD	6.61	± 9.6 %
10874	AAD	5G NR (DFT-s-OFDM, 100% RB, 100 MHz, 64QAM, 120 kHz)	5G NR FR2 TDD	6.65	± 9.6 %
10875	AAD	5G NR (CP-OFDM, 1 RB, 100 MHz, QPSK, 120 kHz)	5G NR FR2 TDD	7.78	± 9.6 %
10876	AAD	5G NR (CP-OFDM, 100% RB, 100 MHz, QPSK, 120 kHz)	5G NR FR2 TDD	8.39	± 9.6 %
10877	AAD	5G NR (CP-OFDM, 1 RB, 100 MHz, 16QAM, 120 kHz)	5G NR FR2 TDD	7.95	± 9.6 %
10878	AAD	5G NR (CP-OFDM, 100% RB, 100 MHz, 16QAM, 120 kHz)	5G NR FR2 TDD	8.41	± 9.6 %
10879	AAD	5G NR (CP-OFDM, 1 RB, 100 MHz, 64QAM, 120 kHz)	5G NR FR2 TDD	8.12	± 9.6 %
10880	AAD	5G NR (CP-OFDM, 100% RB, 100 MHz, 64QAM, 120 kHz)	5G NR FR2 TDD	8.38	± 9.6 %
10881	AAD	5G NR (DFT-s-OFDM, 1 RB, 50 MHz, QPSK, 120 kHz)	5G NR FR2 TDD	5.75	± 9.6 %
10882	AAD	5G NR (DFT-s-OFDM, 100% RB, 50 MHz, QPSK, 120 kHz)	5G NR FR2 TDD	5.96	± 9.6 %
10883	AAD	5G NR (DFT-s-OFDM, 1 RB, 50 MHz, 16QAM, 120 kHz)	5G NR FR2 TDD	6.57	± 9.6 %
10884	AAD	5G NR (DFT-s-OFDM, 100% RB, 50 MHz, 16QAM, 120 kHz)	5G NR FR2 TDD	6.53	± 9.6 %
10885	AAD	5G NR (DFT-s-OFDM, 1 RB, 50 MHz, 64QAM, 120 kHz)	5G NR FR2 TDD	6.61	± 9.6 %
10886	AAD	5G NR (DFT-s-OFDM, 100% RB, 50 MHz, 64QAM, 120 kHz)	5G NR FR2 TDD	6.65	± 9.6 %
10887	AAD	5G NR (CP-OFDM, 1 RB, 50 MHz, QPSK, 120 kHz)	5G NR FR2 TDD	7.78	± 9.6 %
10888	AAD	5G NR (CP-OFDM, 100% RB, 50 MHz, QPSK, 120 kHz)	5G NR FR2 TDD	8.35	± 9.6 %
10889	AAD	5G NR (CP-OFDM, 1 RB, 50 MHz, 16QAM, 120 kHz)	5G NR FR2 TDD	8.02	± 9.6 %
10890	AAD	5G NR (CP-OFDM, 100% RB, 50 MHz, 16QAM, 120 kHz)	5G NR FR2 TDD	8.40	± 9.6 %
10891	AAD	5G NR (CP-OFDM, 1 RB, 50 MHz, 64QAM, 120 kHz)	5G NR FR2 TDD	8.13	± 9.6 %
10892	AAD	5G NR (CP-OFDM, 100% RB, 50 MHz, 64QAM, 120 kHz)	5G NR FR2 TDD	8.41	± 9.6 %
10897	AAC	5G NR (DFT-s-OFDM, 1 RB, 5 MHz, QPSK, 30 kHz)	5G NR FR1 TDD	5.66	± 9.6 %
10898	AAB	5G NR (DFT-s-OFDM, 1 RB, 10 MHz, QPSK, 30 kHz)	5G NR FR1 TDD	5.67	± 9.6 %
10899	AAB	5G NR (DFT-s-OFDM, 1 RB, 15 MHz, QPSK, 30 kHz)	5G NR FR1 TDD	5.67	± 9.6 %
10900	AAB	5G NR (DFT-s-OFDM, 1 RB, 20 MHz, QPSK, 30 kHz)	5G NR FR1 TDD	5.68	± 9.6 %
10901	AAB	5G NR (DFT-s-OFDM, 1 RB, 25 MHz, QPSK, 30 kHz)	5G NR FR1 TDD	5.68	± 9.6 %
10902	AAB	5G NR (DFT-s-OFDM, 1 RB, 30 MHz, QPSK, 30 kHz)	5G NR FR1 TDD	5.68	± 9.6 %
10903	AAB	5G NR (DFT-s-OFDM, 1 RB, 40 MHz, QPSK, 30 kHz)	5G NR FR1 TDD	5.68	± 9.6 %
10904	AAB	5G NR (DFT-s-OFDM, 1 RB, 50 MHz, QPSK, 30 kHz)	5G NR FR1 TDD	5.68	± 9.6 %
10905	AAB	5G NR (DFT-s-OFDM, 1 RB, 60 MHz, QPSK, 30 kHz)	5G NR FR1 TDD	5.68	± 9.6 %
10906	AAB	5G NR (DFT-s-OFDM, 1 RB, 80 MHz, QPSK, 30 kHz)	5G NR FR1 TDD	5.68	± 9.6 %
10907	AAC	5G NR (DFT-s-OFDM, 50% RB, 5 MHz, QPSK, 30 kHz)	5G NR FR1 TDD	5.78	± 9.6 %
10908	AAB	5G NR (DFT-s-OFDM, 50% RB, 10 MHz, QPSK, 30 kHz)	5G NR FR1 TDD	5.93	± 9.6 %
10909	AAB	5G NR (DFT-s-OFDM, 50% RB, 15 MHz, QPSK, 30 kHz)	5G NR FR1 TDD	5.96	± 9.6 %
10910	AAB	5G NR (DFT-s-OFDM, 50% RB, 20 MHz, QPSK, 30 kHz)	5G NR FR1 TDD	5.83	± 9.6 %
10911	AAB	5G NR (DFT-s-OFDM, 50% RB, 25 MHz, QPSK, 30 kHz)	5G NR FR1 TDD	5.93	± 9.6 %
10912	AAB	5G NR (DFT-s-OFDM, 50% RB, 30 MHz, QPSK, 30 kHz)	5G NR FR1 TDD	5.84	± 9.6 %
10913	AAB	5G NR (DFT-s-OFDM, 50% RB, 40 MHz, QPSK, 30 kHz)	5G NR FR1 TDD	5.84	± 9.6 %
10914	AAB	5G NR (DFT-s-OFDM, 50% RB, 50 MHz, QPSK, 30 kHz)	5G NR FR1 TDD	5.85	± 9.6 %
10915	AAB	5G NR (DFT-s-OFDM, 50% RB, 60 MHz, QPSK, 30 kHz)	5G NR FR1 TDD	5.83	± 9.6 %
10916	AAB	5G NR (DFT-s-OFDM, 50% RB, 80 MHz, QPSK, 30 kHz)	5G NR FR1 TDD	5.87	± 9.6 %
10917	AAB	5G NR (DFT-s-OFDM, 50% RB, 100 MHz, QPSK, 30 kHz)	5G NR FR1 TDD	5.94	± 9.6 %
10918	AAC	5G NR (DFT-s-OFDM, 100% RB, 5 MHz, QPSK, 30 kHz)	5G NR FR1 TDD	5.86	± 9.6 %
10919	AAB	5G NR (DFT-s-OFDM, 100% RB, 10 MHz, QPSK, 30 kHz)	5G NR FR1 TDD	5.86	± 9.6 %
10920	AAB	5G NR (DFT-s-OFDM, 100% RB, 15 MHz, QPSK, 30 kHz)	5G NR FR1 TDD	5.87	± 9.6 %
10921	AAB	5G NR (DFT-s-OFDM, 100% RB, 20 MHz, QPSK, 30 kHz)	5G NR FR1 TDD	5.84	± 9.6 %
10922	AAB	5G NR (DFT-s-OFDM, 100% RB, 25 MHz, QPSK, 30 kHz)	5G NR FR1 TDD	5.82	± 9.6 %

10923	AAB	5G NR (DFT-s-OFDM, 100% RB, 30 MHz, QPSK, 30 kHz)	5G NR FR1 TDD	5.84	± 9.6 %
10924	AAB	5G NR (DFT-s-OFDM, 100% RB, 40 MHz, QPSK, 30 kHz)	5G NR FR1 TDD	5.84	± 9.6 %
10925	AAB	5G NR (DFT-s-OFDM, 100% RB, 50 MHz, QPSK, 30 kHz)	5G NR FR1 TDD	5.95	± 9.6 %
10926	AAB	5G NR (DFT-s-OFDM, 100% RB, 60 MHz, QPSK, 30 kHz)	5G NR FR1 TDD	5.84	± 9.6 %
10927	AAB	5G NR (DFT-s-OFDM, 100% RB, 80 MHz, QPSK, 30 kHz)	5G NR FR1 TDD	5.94	± 9.6 %
10928	AAC	5G NR (DFT-s-OFDM, 1 RB, 5 MHz, QPSK, 15 kHz)	5G NR FR1 FDD	5.52	± 9.6 %
10929	AAC	5G NR (DFT-s-OFDM, 1 RB, 10 MHz, QPSK, 15 kHz)	5G NR FR1 FDD	5.52	± 9.6 %
10930	AAC	5G NR (DFT-s-OFDM, 1 RB, 15 MHz, QPSK, 15 kHz)	5G NR FR1 FDD	5.52	± 9.6 %
10931	AAC	5G NR (DFT-s-OFDM, 1 RB, 20 MHz, QPSK, 15 kHz)	5G NR FR1 FDD	5.51	± 9.6 %
10932	AAC	5G NR (DFT-s-OFDM, 1 RB, 25 MHz, QPSK, 15 kHz)	5G NR FR1 FDD	5.51	± 9.6 %
10933	AAC	5G NR (DFT-s-OFDM, 1 RB, 30 MHz, QPSK, 15 kHz)	5G NR FR1 FDD	5.51	± 9.6 %
10934	AAC	5G NR (DFT-s-OFDM, 1 RB, 40 MHz, QPSK, 15 kHz)	5G NR FR1 FDD	5.51	± 9.6 %
10935	AAD	5G NR (DFT-s-OFDM, 1 RB, 50 MHz, QPSK, 15 kHz)	5G NR FR1 FDD	5.51	± 9.6 %
10936	AAC	5G NR (DFT-s-OFDM, 50% RB, 5 MHz, QPSK, 15 kHz)	5G NR FR1 FDD	5.90	± 9.6 %
10937	AAC	5G NR (DFT-s-OFDM, 50% RB, 10 MHz, QPSK, 15 kHz)	5G NR FR1 FDD	5.77	± 9.6 %
10938	AAC	5G NR (DFT-s-OFDM, 50% RB, 15 MHz, QPSK, 15 kHz)	5G NR FR1 FDD	5.90	± 9.6 %
10939	AAC	5G NR (DFT-s-OFDM, 50% RB, 20 MHz, QPSK, 15 kHz)	5G NR FR1 FDD	5.82	± 9.6 %
10940	AAC	5G NR (DFT-s-OFDM, 50% RB, 25 MHz, QPSK, 15 kHz)	5G NR FR1 FDD	5.89	± 9.6 %
10941	AAC	5G NR (DFT-s-OFDM, 50% RB, 30 MHz, QPSK, 15 kHz)	5G NR FR1 FDD	5.83	± 9.6 %
10942	AAC	5G NR (DFT-s-OFDM, 50% RB, 40 MHz, QPSK, 15 kHz)	5G NR FR1 FDD	5.85	± 9.6 %
10943	AAD	5G NR (DFT-s-OFDM, 50% RB, 50 MHz, QPSK, 15 kHz)	5G NR FR1 FDD	5.95	± 9.6 %
10944	AAC	5G NR (DFT-s-OFDM, 100% RB, 5 MHz, QPSK, 15 kHz)	5G NR FR1 FDD	5.81	± 9.6 %
10945	AAC	5G NR (DFT-s-OFDM, 100% RB, 10 MHz, QPSK, 15 kHz)	5G NR FR1 FDD	5.85	± 9.6 %
10946	AAC	5G NR (DFT-s-OFDM, 100% RB, 15 MHz, QPSK, 15 kHz)	5G NR FR1 FDD	5.83	± 9.6 %
10947	AAC	5G NR (DFT-s-OFDM, 100% RB, 20 MHz, QPSK, 15 kHz)	5G NR FR1 FDD	5.87	± 9.6 %
10948	AAC	5G NR (DFT-s-OFDM, 100% RB, 25 MHz, QPSK, 15 kHz)	5G NR FR1 FDD	5.94	± 9.6 %
10949	AAC	5G NR (DFT-s-OFDM, 100% RB, 30 MHz, QPSK, 15 kHz)	5G NR FR1 FDD	5.87	± 9.6 %
10950	AAC	5G NR (DFT-s-OFDM, 100% RB, 40 MHz, QPSK, 15 kHz)	5G NR FR1 FDD	5.94	± 9.6 %
10951	AAD	5G NR (DFT-s-OFDM, 100% RB, 50 MHz, QPSK, 15 kHz)	5G NR FR1 FDD	5.92	± 9.6 %
10952	AAA	5G NR DL (CP-OFDM, TM 3.1, 5 MHz, 64-QAM, 15 kHz)	5G NR FR1 FDD	8.25	± 9.6 %
10953	AAA	5G NR DL (CP-OFDM, TM 3.1, 10 MHz, 64-QAM, 15 kHz)	5G NR FR1 FDD	8.15	± 9.6 %
10954	AAA	5G NR DL (CP-OFDM, TM 3.1, 15 MHz, 64-QAM, 15 kHz)	5G NR FR1 FDD	8.23	± 9.6 %
10955	AAA	5G NR DL (CP-OFDM, TM 3.1, 20 MHz, 64-QAM, 15 kHz)	5G NR FR1 FDD	8.42	± 9.6 %
10956	AAA	5G NR DL (CP-OFDM, TM 3.1, 5 MHz, 64-QAM, 30 kHz)	5G NR FR1 FDD	8.14	± 9.6 %
10957	AAA	5G NR DL (CP-OFDM, TM 3.1, 10 MHz, 64-QAM, 30 kHz)	5G NR FR1 FDD	8.31	± 9.6 %
10958	AAA	5G NR DL (CP-OFDM, TM 3.1, 15 MHz, 64-QAM, 30 kHz)	5G NR FR1 FDD	8.61	± 9.6 %
10959	AAA	5G NR DL (CP-OFDM, TM 3.1, 20 MHz, 64-QAM, 30 kHz)	5G NR FR1 FDD	8.33	± 9.6 %
10960	AAC	5G NR DL (CP-OFDM, TM 3.1, 5 MHz, 64-QAM, 15 kHz)	5G NR FR1 TDD	9.32	± 9.6 %
10961	AAB	5G NR DL (CP-OFDM, TM 3.1, 10 MHz, 64-QAM, 15 kHz)	5G NR FR1 TDD	9.36	± 9.6 %
10962	AAB	5G NR DL (CP-OFDM, TM 3.1, 15 MHz, 64-QAM, 15 kHz)	5G NR FR1 TDD	9.40	± 9.6 %
10963	AAB	5G NR DL (CP-OFDM, TM 3.1, 20 MHz, 64-QAM, 15 kHz)	5G NR FR1 TDD	9.55	± 9.6 %
10964	AAC	5G NR DL (CP-OFDM, TM 3.1, 5 MHz, 64-QAM, 30 kHz)	5G NR FR1 TDD	9.29	± 9.6 %
10965	AAB	5G NR DL (CP-OFDM, TM 3.1, 10 MHz, 64-QAM, 30 kHz)	5G NR FR1 TDD	9.37	± 9.6 %
10966	AAB	5G NR DL (CP-OFDM, TM 3.1, 15 MHz, 64-QAM, 30 kHz)	5G NR FR1 TDD	9.55	± 9.6 %
10967	AAB	5G NR DL (CP-OFDM, TM 3.1, 20 MHz, 64-QAM, 30 kHz)	5G NR FR1 TDD	9.42	± 9.6 %
10968	AAB	5G NR DL (CP-OFDM, TM 3.1, 100 MHz, 64-QAM, 30 kHz)	5G NR FR1 TDD	9.49	± 9.6 %
10972	AAB	5G NR (CP-OFDM, 1 RB, 20 MHz, QPSK, 15 kHz)	5G NR FR1 TDD	11.59	± 9.6 %
10973	AAB	5G NR (DFT-s-OFDM, 1 RB, 100 MHz, QPSK, 30 kHz)	5G NR FR1 TDD	9.06	± 9.6 %
10974	AAB	5G NR (CP-OFDM, 100% RB, 100 MHz, 256-QAM, 30 kHz)	5G NR FR1 TDD	10.28	± 9.6 %
10978	AAA	ULLA BDR	ULLA	2.23	± 9.6 %
10979	AAA	ULLA HDR4	ULLA	7.02	± 9.6 %
10980	AAA	ULLA HDR8	ULLA	8.82	± 9.6 %
10981	AAA	ULLA HDRp4	ULLA	1.50	± 9.6 %
10982	AAA	ULLA HDRp8	ULLA	1.44	± 9.6 %

^E Uncertainty is determined using the max. deviation from linear response applying rectangular distribution and is expressed for the square of the field value.



Accredited by the Swiss Accreditation Service (SAS)
The Swiss Accreditation Service is one of the signatories to the EA
Multilateral Agreement for the recognition of calibration certificates

Accreditation No.: **SCS 0108**

Client **B.V.ADT (Auden)**

Certificate No: **EX3-7736_May22**

CALIBRATION CERTIFICATE

Object **EX3DV4 - SN:7736**

Calibration procedure(s) **QA CAL-01.v9, QA CAL-14.v6, QA CAL-23.v5, QA CAL-25.v7
Calibration procedure for dosimetric E-field probes**

Calibration date: **May 30, 2022**

This calibration certificate documents the traceability to national standards, which realize the physical units of measurements (SI).
The measurements and the uncertainties with confidence probability are given on the following pages and are part of the certificate.

All calibrations have been conducted in the closed laboratory facility: environment temperature (22 ± 3)°C and humidity < 70%.

Calibration Equipment used (M&TE critical for calibration)

Primary Standards	ID	Cal Date (Certificate No.)	Scheduled Calibration
Power meter NRP	SN: 104778	04-Apr-22 (No. 217-03525/03524)	Apr-23
Power sensor NRP-Z91	SN: 103244	04-Apr-22 (No. 217-03524)	Apr-23
Power sensor NRP-Z91	SN: 103245	04-Apr-22 (No. 217-03525)	Apr-23
Reference 20 dB Attenuator	SN: CC2552 (20x)	04-Apr-22 (No. 217-03527)	Apr-23
DAE4	SN: 660	13-Oct-21 (No. DAE4-660_Oct21)	Oct-22
Reference Probe ES3DV2	SN: 3013	27-Dec-21 (No. ES3-3013_Dec21)	Dec-22
Secondary Standards	ID	Check Date (in house)	Scheduled Check
Power meter E4419B	SN: GB41293874	06-Apr-16 (in house check Jun-20)	In house check: Jun-22
Power sensor E4412A	SN: MY41498087	06-Apr-16 (in house check Jun-20)	In house check: Jun-22
Power sensor E4412A	SN: 000110210	06-Apr-16 (in house check Jun-20)	In house check: Jun-22
RF generator HP 8648C	SN: US3642U01700	04-Aug-99 (in house check Jun-20)	In house check: Jun-22
Network Analyzer E8358A	SN: US41080477	31-Mar-14 (in house check Oct-20)	In house check: Oct-22

	Name	Function	Signature
Calibrated by:	Leif Klynsner	Laboratory Technician	
Approved by:	Sven Kühn	Technical Manager	
			Issued: May 31, 2022

This calibration certificate shall not be reproduced except in full without written approval of the laboratory.



Accredited by the Swiss Accreditation Service (SAS)

Accreditation No.: **SCS 0108**

The Swiss Accreditation Service is one of the signatories to the EA
Multilateral Agreement for the recognition of calibration certificates

Glossary:

TSL	tissue simulating liquid
NORM _{x,y,z}	sensitivity in free space
ConvF	sensitivity in TSL / NORM _{x,y,z}
DCP	diode compression point
CF	crest factor (1/duty_cycle) of the RF signal
A, B, C, D	modulation dependent linearization parameters
Polarization φ	φ rotation around probe axis
Polarization ϑ	ϑ rotation around an axis that is in the plane normal to probe axis (at measurement center), i.e., $\vartheta = 0$ is normal to probe axis
Connector Angle	information used in DASY system to align probe sensor X to the robot coordinate system

Calibration is Performed According to the Following Standards:

- IEC/IEEE 62209-1528, "Measurement Procedure For The Assessment Of Specific Absorption Rate Of Human Exposure To Radio Frequency Fields From Hand-Held And Body-Worn Wireless Communication Devices - Part 1528: Human Models, Instrumentation And Procedures (Frequency Range of 4 MHz to 10 GHz)", October 2020.
- KDB 865664, "SAR Measurement Requirements for 100 MHz to 6 GHz"

Methods Applied and Interpretation of Parameters:

- NORM_{x,y,z}**: Assessed for E-field polarization $\vartheta = 0$ ($f \leq 900$ MHz in TEM-cell; $f > 1800$ MHz: R22 waveguide). NORM_{x,y,z} are only intermediate values, i.e., the uncertainties of NORM_{x,y,z} does not affect the E²-field uncertainty inside TSL (see below ConvF).
- NORM(f)_{x,y,z}** = NORM_{x,y,z} * frequency_response (see Frequency Response Chart). This linearization is implemented in DASY4 software versions later than 4.2. The uncertainty of the frequency response is included in the stated uncertainty of ConvF.
- DCP_{x,y,z}**: DCP are numerical linearization parameters assessed based on the data of power sweep with CW signal (no uncertainty required). DCP does not depend on frequency nor media.
- PAR**: PAR is the Peak to Average Ratio that is not calibrated but determined based on the signal characteristics
- A_{x,y,z}; B_{x,y,z}; C_{x,y,z}; D_{x,y,z}; VR_{x,y,z}**: A, B, C, D are numerical linearization parameters assessed based on the data of power sweep for specific modulation signal. The parameters do not depend on frequency nor media. VR is the maximum calibration range expressed in RMS voltage across the diode.
- ConvF and Boundary Effect Parameters**: Assessed in flat phantom using E-field (or Temperature Transfer Standard for $f \leq 800$ MHz) and inside waveguide using analytical field distributions based on power measurements for $f > 800$ MHz. The same setups are used for assessment of the parameters applied for boundary compensation (alpha, depth) of which typical uncertainty values are given. These parameters are used in DASY4 software to improve probe accuracy close to the boundary. The sensitivity in TSL corresponds to NORM_{x,y,z} * ConvF whereby the uncertainty corresponds to that given for ConvF. A frequency dependent ConvF is used in DASY version 4.4 and higher which allows extending the validity from ± 50 MHz to ± 100 MHz.
- Spherical isotropy (3D deviation from isotropy)**: in a field of low gradients realized using a flat phantom exposed by a patch antenna.
- Sensor Offset**: The sensor offset corresponds to the offset of virtual measurement center from the probe tip (on probe axis). No tolerance required.
- Connector Angle**: The angle is assessed using the information gained by determining the NORM_x (no uncertainty required).

DASY/EASY - Parameters of Probe: EX3DV4 - SN:7736

Basic Calibration Parameters

	Sensor X	Sensor Y	Sensor Z	Unc (k=2)
Norm ($\mu\text{V}/(\text{V}/\text{m})^2$) ^A	0.42	0.47	0.46	$\pm 10.1 \%$
DCP (mV) ^B	105.5	102.0	103.8	

Calibration Results for Modulation Response

UID	Communication System Name		A dB	B dB $\sqrt{\mu\text{V}}$	C	D dB	VR mV	Max dev.	Max Unc ^E (k=2)
0	CW	X	0.00	0.00	1.00	0.00	139.4	$\pm 2.7 \%$	$\pm 4.7 \%$
		Y	0.00	0.00	1.00		138.6		
		Z	0.00	0.00	1.00		146.2		
10352-AAA	Pulse Waveform (200Hz, 10%)	X	1.58	61.34	7.22	10.00	60.0	$\pm 2.7 \%$	$\pm 9.6 \%$
		Y	1.39	60.09	6.00		60.0		
		Z	1.59	61.27	7.02		60.0		
10353-AAA	Pulse Waveform (200Hz, 20%)	X	0.89	60.55	5.69	6.99	80.0	$\pm 2.7 \%$	$\pm 9.6 \%$
		Y	20.00	74.00	9.00		80.0		
		Z	0.79	60.00	5.23		80.0		
10354-AAA	Pulse Waveform (200Hz, 40%)	X	0.43	60.00	4.21	3.98	95.0	$\pm 2.7 \%$	$\pm 9.6 \%$
		Y	0.13	137.62	0.05		95.0		
		Z	0.02	121.85	0.21		95.0		
10355-AAA	Pulse Waveform (200Hz, 60%)	X	7.45	159.85	18.73	2.22	120.0	$\pm 2.2 \%$	$\pm 9.6 \%$
		Y	7.19	159.92	13.92		120.0		
		Z	4.00	159.68	13.75		120.0		
10387-AAA	QPSK Waveform, 1 MHz	X	0.48	63.38	12.37	1.00	150.0	$\pm 4.5 \%$	$\pm 9.6 \%$
		Y	0.64	66.14	14.09		150.0		
		Z	0.48	62.98	11.50		150.0		
10388-AAA	QPSK Waveform, 10 MHz	X	1.40	67.09	14.46	0.00	150.0	$\pm 0.9 \%$	$\pm 9.6 \%$
		Y	1.46	67.31	14.91		150.0		
		Z	1.25	65.24	13.49		150.0		
10396-AAA	64-QAM Waveform, 100 kHz	X	1.79	65.59	16.66	3.01	150.0	$\pm 1.3 \%$	$\pm 9.6 \%$
		Y	1.60	63.86	15.86		150.0		
		Z	1.57	63.46	15.42		150.0		
10399-AAA	64-QAM Waveform, 40 MHz	X	2.86	66.74	15.38	0.00	150.0	$\pm 2.4 \%$	$\pm 9.6 \%$
		Y	2.87	66.55	15.41		150.0		
		Z	2.74	65.85	14.89		150.0		
10414-AAA	WLAN CCDF, 64-QAM, 40MHz	X	3.83	66.31	15.47	0.00	150.0	$\pm 4.1 \%$	$\pm 9.6 \%$
		Y	3.99	66.67	15.75		150.0		
		Z	3.88	66.22	15.42		150.0		

Note: For details on UID parameters see Appendix

The reported uncertainty of measurement is stated as the standard uncertainty of measurement multiplied by the coverage factor k=2, which for a normal distribution corresponds to a coverage probability of approximately 95%.

^A The uncertainties of Norm X,Y,Z do not affect the E²-field uncertainty inside TSL (see Pages 5 and 6).

^B Numerical linearization parameter: uncertainty not required.

^E Uncertainty is determined using the max. deviation from linear response applying rectangular distribution and is expressed for the square of the field value.

DASY/EASY - Parameters of Probe: EX3DV4 - SN:7736

Sensor Model Parameters

	C1 fF	C2 fF	α V^{-1}	T1 $ms.V^{-2}$	T2 $ms.V^{-1}$	T3 ms	T4 V^{-2}	T5 V^{-1}	T6
X	9.3	68.11	34.13	3.91	0.00	4.97	0.73	0.00	1.00
Y	10.0	73.17	34.20	3.54	0.00	4.90	0.16	0.02	1.00
Z	10.0	74.27	34.84	3.20	0.00	4.98	0.00	0.07	1.00

Other Probe Parameters

Sensor Arrangement	Triangular
Connector Angle (°)	168.6
Mechanical Surface Detection Mode	enabled
Optical Surface Detection Mode	disabled
Probe Overall Length	337 mm
Probe Body Diameter	10 mm
Tip Length	9 mm
Tip Diameter	2.5 mm
Probe Tip to Sensor X Calibration Point	1 mm
Probe Tip to Sensor Y Calibration Point	1 mm
Probe Tip to Sensor Z Calibration Point	1 mm
Recommended Measurement Distance from Surface	1.4 mm

Note: Measurement distance from surface can be increased to 3-4 mm for an *Area Scan* job.

DASY/EASY - Parameters of Probe: EX3DV4 - SN:7736

Calibration Parameter Determined in Head Tissue Simulating Media

f (MHz) ^C	Relative Permittivity ^F	Conductivity (S/m) ^F	ConvF X	ConvF Y	ConvF Z	Alpha ^G	Depth ^G (mm)	Unc (k=2)
750	41.9	0.89	10.21	10.21	10.21	0.57	0.90	± 12.0 %
835	41.5	0.90	9.93	9.93	9.93	0.49	0.98	± 12.0 %
1450	40.5	1.20	8.98	8.98	8.98	0.54	0.80	± 12.0 %
1750	40.1	1.37	8.71	8.71	8.71	0.28	0.86	± 12.0 %
1900	40.0	1.40	8.34	8.34	8.34	0.30	0.86	± 12.0 %
2000	40.0	1.40	8.30	8.30	8.30	0.26	0.86	± 12.0 %
2300	39.5	1.67	8.29	8.29	8.29	0.31	0.90	± 12.0 %
2450	39.2	1.80	8.12	8.12	8.12	0.31	0.90	± 12.0 %
2600	39.0	1.96	7.86	7.86	7.86	0.28	0.90	± 12.0 %
3300	38.2	2.71	6.89	6.89	6.89	0.30	1.35	± 13.1 %
3500	37.9	2.91	6.82	6.82	6.82	0.30	1.35	± 13.1 %
3700	37.7	3.12	6.79	6.79	6.79	0.30	1.35	± 13.1 %
3900	37.5	3.32	6.38	6.38	6.38	0.40	1.60	± 13.1 %
4100	37.2	3.53	6.35	6.35	6.35	0.40	1.60	± 13.1 %
4200	37.1	3.63	6.20	6.20	6.20	0.40	1.70	± 13.1 %
4400	36.9	3.84	6.17	6.17	6.17	0.40	1.70	± 13.1 %
4600	36.7	4.04	6.15	6.15	6.15	0.40	1.80	± 13.1 %
4800	36.4	4.25	6.10	6.10	6.10	0.40	1.80	± 13.1 %
4950	36.3	4.40	6.04	6.04	6.04	0.40	1.80	± 13.1 %
5250	35.9	4.71	5.74	5.74	5.74	0.40	1.80	± 13.1 %
5600	35.5	5.07	4.93	4.93	4.93	0.40	1.80	± 13.1 %
5750	35.4	5.22	5.05	5.05	5.05	0.40	1.80	± 13.1 %

^C Frequency validity above 300 MHz of ± 100 MHz only applies for DASY v4.4 and higher (see Page 2), else it is restricted to ± 50 MHz. The uncertainty is the RSS of the ConvF uncertainty at calibration frequency and the uncertainty for the indicated frequency band. Frequency validity below 300 MHz is ± 10, 25, 40, 50 and 70 MHz for ConvF assessments at 30, 64, 128, 150 and 220 MHz respectively. Validity of ConvF assessed at 6 MHz is 4-9 MHz, and ConvF assessed at 13 MHz is 9-19 MHz. Above 5 GHz frequency validity can be extended to ± 110 MHz.

^F At frequencies below 3 GHz, the validity of tissue parameters (ϵ and σ) can be relaxed to ± 10% if liquid compensation formula is applied to measured SAR values. At frequencies above 3 GHz, the validity of tissue parameters (ϵ and σ) is restricted to ± 5%. The uncertainty is the RSS of the ConvF uncertainty for indicated target tissue parameters.

^G Alpha/Depth are determined during calibration. SPEAG warrants that the remaining deviation due to the boundary effect after compensation is always less than ± 1% for frequencies below 3 GHz and below ± 2% for frequencies between 3-6 GHz at any distance larger than half the probe tip diameter from the boundary.

DASY/EASY - Parameters of Probe: EX3DV4 - SN:7736

Calibration Parameter Determined in Head Tissue Simulating Media

f (MHz) ^C	Relative Permittivity ^F	Conductivity (S/m) ^F	ConvF X	ConvF Y	ConvF Z	Alpha ^G	Depth ^G (mm)	Unc (k=2)
6500	34.5	6.07	5.45	5.45	5.45	0.20	2.50	± 18.6 %

^C Frequency validity at 6.5 GHz is -600/+700 MHz, and ± 700 MHz at or above 7 GHz. The uncertainty is the RSS of the ConvF uncertainty at calibration frequency and the uncertainty for the indicated frequency band.

^F At frequencies 6-10 GHz, the validity of tissue parameters (ϵ and σ) can be relaxed to ± 10% if liquid compensation formula is applied to measured SAR values. The uncertainty is the RSS of the ConvF uncertainty for indicated target tissue parameters.

^G Alpha/Depth are determined during calibration. SPEAG warrants that the remaining deviation due to the boundary effect after compensation is always less than ± 1% for frequencies below 3 GHz; below ± 2% for frequencies between 3-6 GHz; and below ± 4% for frequencies between 6-10 GHz at any distance larger than half the probe tip diameter from the boundary.

Frequency Response of E-Field (TEM-Cell:ifi110 EXX, Waveguide: R22)

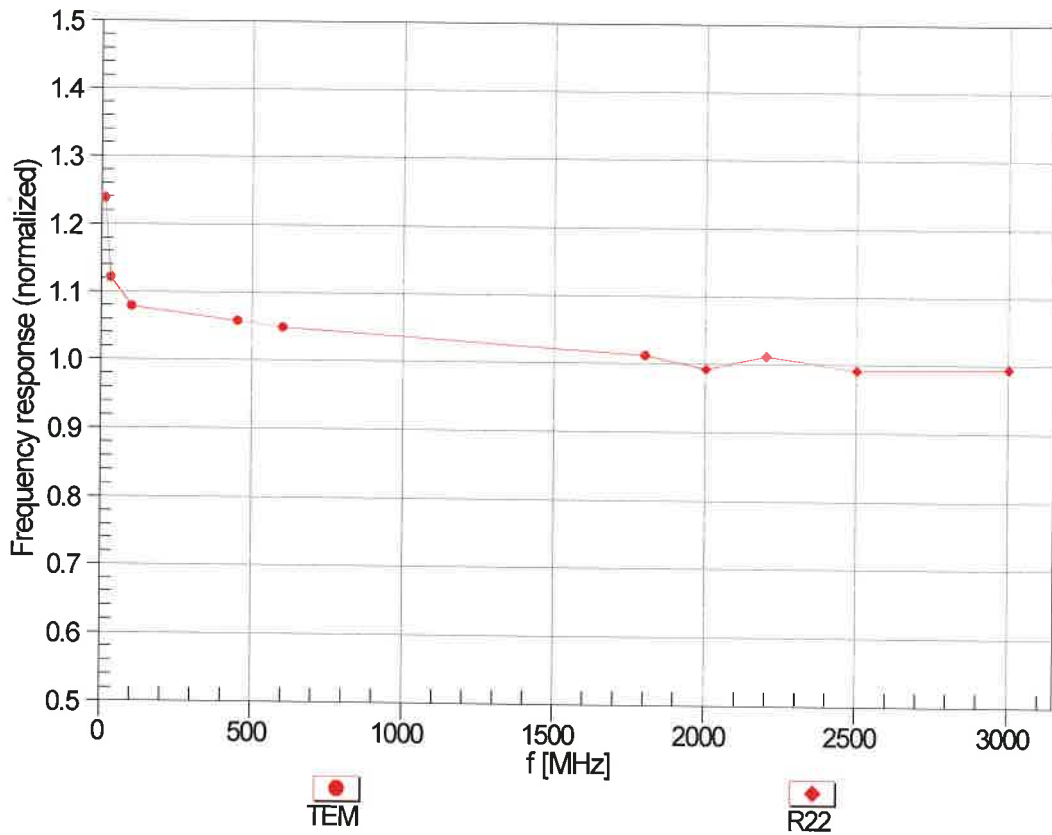

Uncertainty of Frequency Response of E-field: $\pm 6.3\%$ (k=2)

Receiving Pattern (ϕ), $\theta = 0^\circ$

f=600 MHz,TEM

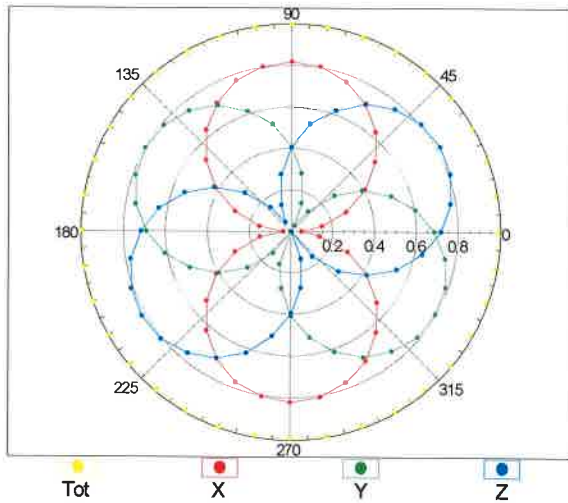

f=1800 MHz,R22

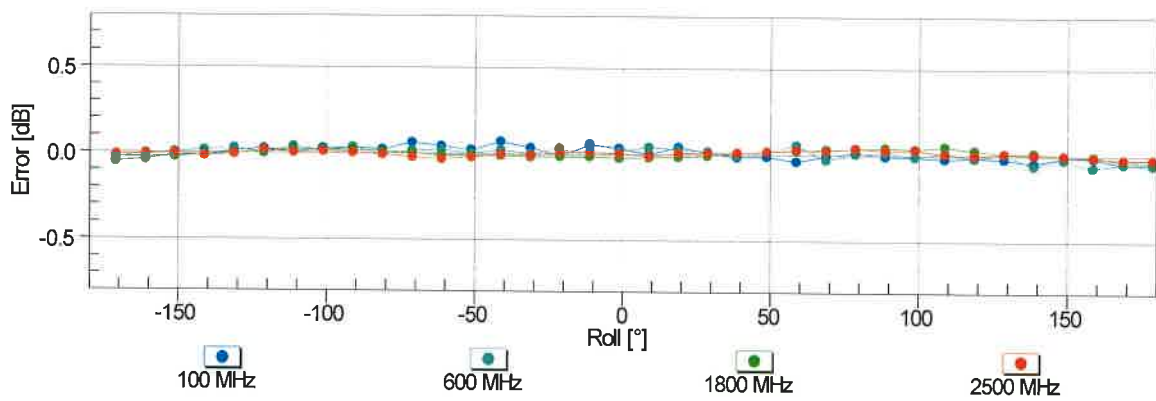
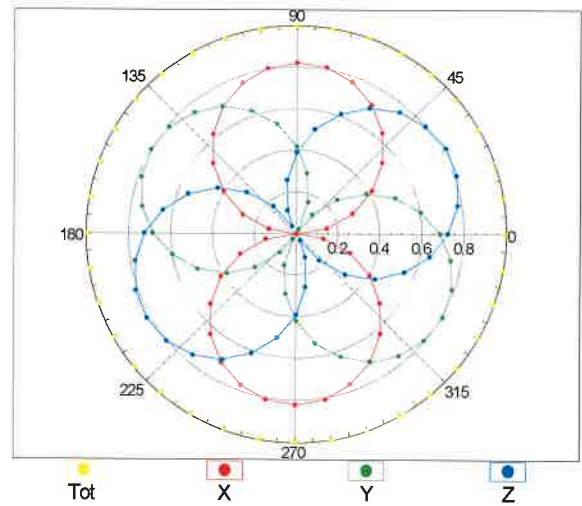

Uncertainty of Axial Isotropy Assessment: $\pm 0.5\%$ (k=2)

Dynamic Range f(SAR_{head}) (TEM cell , f_{eval}= 1900 MHz)

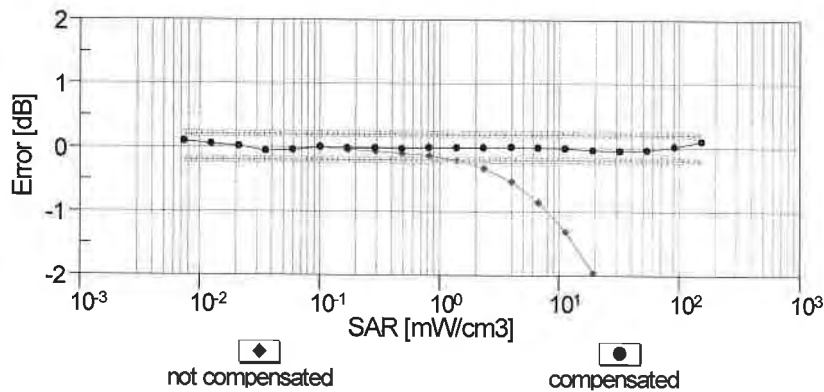
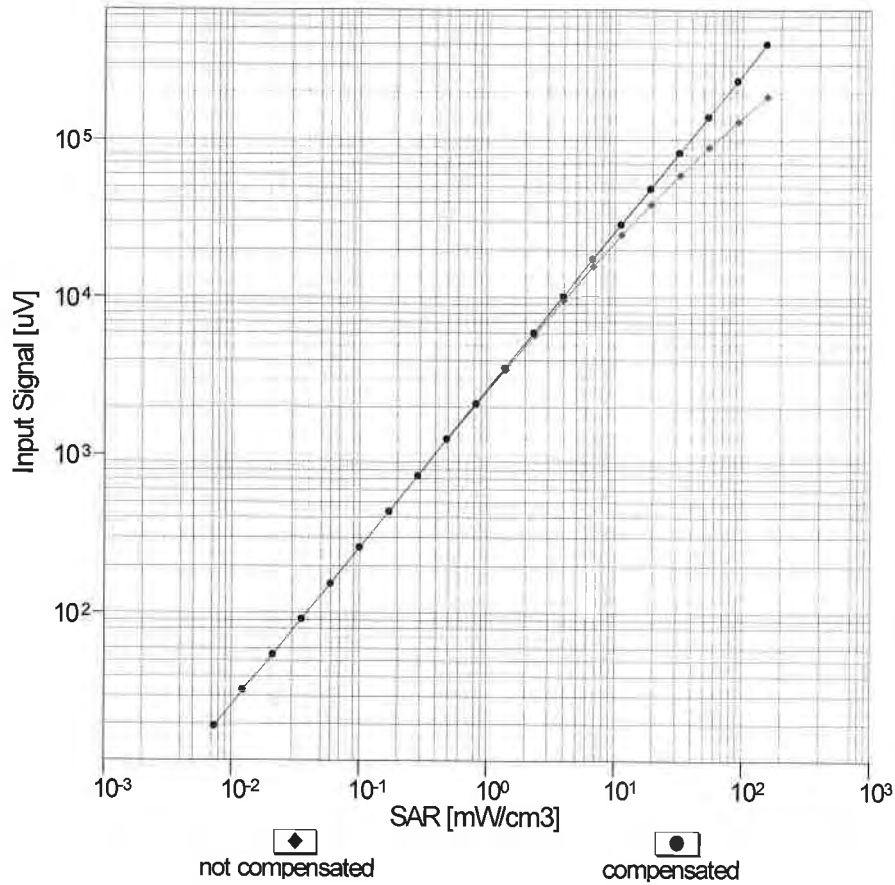

Uncertainty of Linearity Assessment: ± 0.6% (k=2)

Conversion Factor Assessment

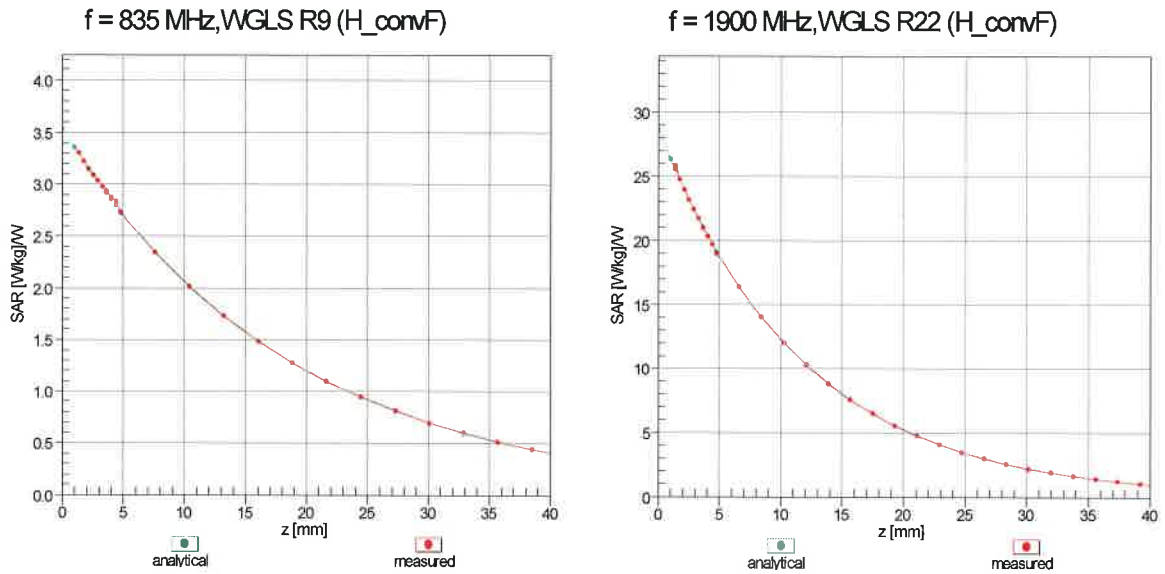

Deviation from Isotropy in Liquid Error (ϕ, θ), f = 900 MHz

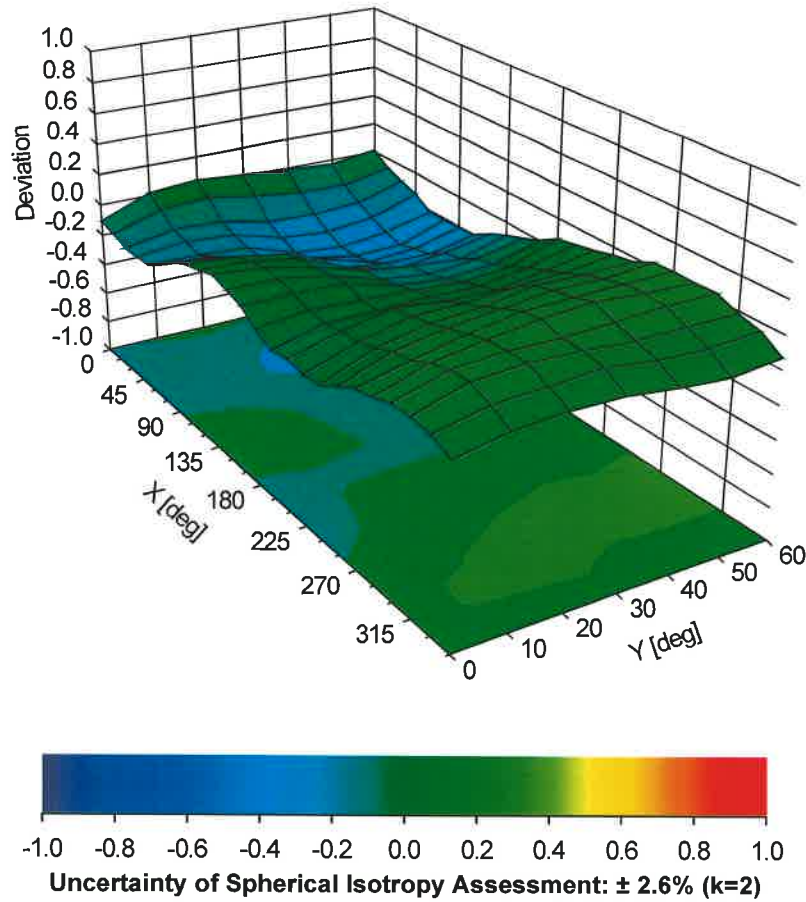

Appendix: Modulation Calibration Parameters

UID	Rev	Communication System Name	Group	PAR (dB)	Unc ^E (k=2)
0	-	CW	CW	0.00	± 4.7 %
10010	CAA	SAR Validation (Square, 100ms, 10ms)	Test	10.00	± 9.6 %
10011	CAB	UMTS-FDD (WCDMA)	WCDMA	2.91	± 9.6 %
10012	CAB	IEEE 802.11b WiFi 2.4 GHz (DSSS, 1 Mbps)	WLAN	1.87	± 9.6 %
10013	CAB	IEEE 802.11g WiFi 2.4 GHz (DSSS-OFDM, 6 Mbps)	WLAN	9.46	± 9.6 %
10021	DAC	GSM-FDD (TDMA, GMSK)	GSM	9.39	± 9.6 %
10023	DAC	GPRS-FDD (TDMA, GMSK, TN 0)	GSM	9.57	± 9.6 %
10024	DAC	GPRS-FDD (TDMA, GMSK, TN 0-1)	GSM	6.56	± 9.6 %
10025	DAC	EDGE-FDD (TDMA, 8PSK, TN 0)	GSM	12.62	± 9.6 %
10026	DAC	EDGE-FDD (TDMA, 8PSK, TN 0-1)	GSM	9.55	± 9.6 %
10027	DAC	GPRS-FDD (TDMA, GMSK, TN 0-1-2)	GSM	4.80	± 9.6 %
10028	DAC	GPRS-FDD (TDMA, GMSK, TN 0-1-2-3)	GSM	3.55	± 9.6 %
10029	DAC	EDGE-FDD (TDMA, 8PSK, TN 0-1-2)	GSM	7.78	± 9.6 %
10030	CAA	IEEE 802.15.1 Bluetooth (GFSK, DH1)	Bluetooth	5.30	± 9.6 %
10031	CAA	IEEE 802.15.1 Bluetooth (GFSK, DH3)	Bluetooth	1.87	± 9.6 %
10032	CAA	IEEE 802.15.1 Bluetooth (GFSK, DH5)	Bluetooth	1.16	± 9.6 %
10033	CAA	IEEE 802.15.1 Bluetooth (PI/4-DQPSK, DH1)	Bluetooth	7.74	± 9.6 %
10034	CAA	IEEE 802.15.1 Bluetooth (PI/4-DQPSK, DH3)	Bluetooth	4.53	± 9.6 %
10035	CAA	IEEE 802.15.1 Bluetooth (PI/4-DQPSK, DH5)	Bluetooth	3.83	± 9.6 %
10036	CAA	IEEE 802.15.1 Bluetooth (8-DPSK, DH1)	Bluetooth	8.01	± 9.6 %
10037	CAA	IEEE 802.15.1 Bluetooth (8-DPSK, DH3)	Bluetooth	4.77	± 9.6 %
10038	CAA	IEEE 802.15.1 Bluetooth (8-DPSK, DH5)	Bluetooth	4.10	± 9.6 %
10039	CAB	CDMA2000 (1xRTT, RC1)	CDMA2000	4.57	± 9.6 %
10042	CAB	IS-54 / IS-136 FDD (TDMA/FDM, PI/4-DQPSK, Halfrate)	AMPS	7.78	± 9.6 %
10044	CAA	IS-91/EIA/TIA-553 FDD (FDMA, FM)	AMPS	0.00	± 9.6 %
10048	CAA	DECT (TDD, TDMA/FDM, GFSK, Full Slot, 24)	DECT	13.80	± 9.6 %
10049	CAA	DECT (TDD, TDMA/FDM, GFSK, Double Slot, 12)	DECT	10.79	± 9.6 %
10056	CAA	UMTS-TDD (TD-SCDMA, 1.28 Mcps)	TD-SCDMA	11.01	± 9.6 %
10058	DAC	EDGE-FDD (TDMA, 8PSK, TN 0-1-2-3)	GSM	6.52	± 9.6 %
10059	CAB	IEEE 802.11b WiFi 2.4 GHz (DSSS, 2 Mbps)	WLAN	2.12	± 9.6 %
10060	CAB	IEEE 802.11b WiFi 2.4 GHz (DSSS, 5.5 Mbps)	WLAN	2.83	± 9.6 %
10061	CAB	IEEE 802.11b WiFi 2.4 GHz (DSSS, 11 Mbps)	WLAN	3.60	± 9.6 %
10062	CAD	IEEE 802.11a/h WiFi 5 GHz (OFDM, 6 Mbps)	WLAN	8.68	± 9.6 %
10063	CAD	IEEE 802.11a/h WiFi 5 GHz (OFDM, 9 Mbps)	WLAN	8.63	± 9.6 %
10064	CAD	IEEE 802.11a/h WiFi 5 GHz (OFDM, 12 Mbps)	WLAN	9.09	± 9.6 %
10065	CAD	IEEE 802.11a/h WiFi 5 GHz (OFDM, 18 Mbps)	WLAN	9.00	± 9.6 %
10066	CAD	IEEE 802.11a/h WiFi 5 GHz (OFDM, 24 Mbps)	WLAN	9.38	± 9.6 %
10067	CAD	IEEE 802.11a/h WiFi 5 GHz (OFDM, 36 Mbps)	WLAN	10.12	± 9.6 %
10068	CAD	IEEE 802.11a/h WiFi 5 GHz (OFDM, 48 Mbps)	WLAN	10.24	± 9.6 %
10069	CAD	IEEE 802.11a/h WiFi 5 GHz (OFDM, 54 Mbps)	WLAN	10.56	± 9.6 %
10071	CAB	IEEE 802.11g WiFi 2.4 GHz (DSSS/OFDM, 9 Mbps)	WLAN	9.83	± 9.6 %
10072	CAB	IEEE 802.11g WiFi 2.4 GHz (DSSS/OFDM, 12 Mbps)	WLAN	9.62	± 9.6 %
10073	CAB	IEEE 802.11g WiFi 2.4 GHz (DSSS/OFDM, 18 Mbps)	WLAN	9.94	± 9.6 %
10074	CAB	IEEE 802.11g WiFi 2.4 GHz (DSSS/OFDM, 24 Mbps)	WLAN	10.30	± 9.6 %
10075	CAB	IEEE 802.11g WiFi 2.4 GHz (DSSS/OFDM, 36 Mbps)	WLAN	10.77	± 9.6 %
10076	CAB	IEEE 802.11g WiFi 2.4 GHz (DSSS/OFDM, 48 Mbps)	WLAN	10.94	± 9.6 %
10077	CAB	IEEE 802.11g WiFi 2.4 GHz (DSSS/OFDM, 54 Mbps)	WLAN	11.00	± 9.6 %
10081	CAB	CDMA2000 (1xRTT, RC3)	CDMA2000	3.97	± 9.6 %
10082	CAB	IS-54 / IS-136 FDD (TDMA/FDM, PI/4-DQPSK, Fullrate)	AMPS	4.77	± 9.6 %
10090	DAC	GPRS-FDD (TDMA, GMSK, TN 0-4)	GSM	6.56	± 9.6 %
10097	CAB	UMTS-FDD (HSDPA)	WCDMA	3.98	± 9.6 %
10098	CAB	UMTS-FDD (HSUPA, Subtest 2)	WCDMA	3.98	± 9.6 %
10099	DAC	EDGE-FDD (TDMA, 8PSK, TN 0-4)	GSM	9.55	± 9.6 %

10100	CAE	LTE-FDD (SC-FDMA, 100% RB, 20 MHz, QPSK)	LTE-FDD	5.67	± 9.6 %
10101	CAE	LTE-FDD (SC-FDMA, 100% RB, 20 MHz, 16-QAM)	LTE-FDD	6.42	± 9.6 %
10102	CAE	LTE-FDD (SC-FDMA, 100% RB, 20 MHz, 64-QAM)	LTE-FDD	6.60	± 9.6 %
10103	CAG	LTE-TDD (SC-FDMA, 100% RB, 20 MHz, QPSK)	LTE-TDD	9.29	± 9.6 %
10104	CAG	LTE-TDD (SC-FDMA, 100% RB, 20 MHz, 16-QAM)	LTE-TDD	9.97	± 9.6 %
10105	CAG	LTE-TDD (SC-FDMA, 100% RB, 20 MHz, 64-QAM)	LTE-TDD	10.01	± 9.6 %
10108	CAG	LTE-FDD (SC-FDMA, 100% RB, 10 MHz, QPSK)	LTE-FDD	5.80	± 9.6 %
10109	CAG	LTE-FDD (SC-FDMA, 100% RB, 10 MHz, 16-QAM)	LTE-FDD	6.43	± 9.6 %
10110	CAG	LTE-FDD (SC-FDMA, 100% RB, 5 MHz, QPSK)	LTE-FDD	5.75	± 9.6 %
10111	CAG	LTE-FDD (SC-FDMA, 100% RB, 5 MHz, 16-QAM)	LTE-FDD	6.44	± 9.6 %
10112	CAG	LTE-FDD (SC-FDMA, 100% RB, 10 MHz, 64-QAM)	LTE-FDD	6.59	± 9.6 %
10113	CAG	LTE-FDD (SC-FDMA, 100% RB, 5 MHz, 64-QAM)	LTE-FDD	6.62	± 9.6 %
10114	CAD	IEEE 802.11n (HT Greenfield, 13.5 Mbps, BPSK)	WLAN	8.10	± 9.6 %
10115	CAD	IEEE 802.11n (HT Greenfield, 81 Mbps, 16-QAM)	WLAN	8.46	± 9.6 %
10116	CAD	IEEE 802.11n (HT Greenfield, 135 Mbps, 64-QAM)	WLAN	8.15	± 9.6 %
10117	CAD	IEEE 802.11n (HT Mixed, 13.5 Mbps, BPSK)	WLAN	8.07	± 9.6 %
10118	CAD	IEEE 802.11n (HT Mixed, 81 Mbps, 16-QAM)	WLAN	8.59	± 9.6 %
10119	CAD	IEEE 802.11n (HT Mixed, 135 Mbps, 64-QAM)	WLAN	8.13	± 9.6 %
10140	CAE	LTE-FDD (SC-FDMA, 100% RB, 15 MHz, 16-QAM)	LTE-FDD	6.49	± 9.6 %
10141	CAE	LTE-FDD (SC-FDMA, 100% RB, 15 MHz, 64-QAM)	LTE-FDD	6.53	± 9.6 %
10142	CAE	LTE-FDD (SC-FDMA, 100% RB, 3 MHz, QPSK)	LTE-FDD	5.73	± 9.6 %
10143	CAE	LTE-FDD (SC-FDMA, 100% RB, 3 MHz, 16-QAM)	LTE-FDD	6.35	± 9.6 %
10144	CAE	LTE-FDD (SC-FDMA, 100% RB, 3 MHz, 64-QAM)	LTE-FDD	6.65	± 9.6 %
10145	CAF	LTE-FDD (SC-FDMA, 100% RB, 1.4 MHz, QPSK)	LTE-FDD	5.76	± 9.6 %
10146	CAF	LTE-FDD (SC-FDMA, 100% RB, 1.4 MHz, 16-QAM)	LTE-FDD	6.41	± 9.6 %
10147	CAF	LTE-FDD (SC-FDMA, 100% RB, 1.4 MHz, 64-QAM)	LTE-FDD	6.72	± 9.6 %
10149	CAE	LTE-FDD (SC-FDMA, 50% RB, 20 MHz, 16-QAM)	LTE-FDD	6.42	± 9.6 %
10150	CAE	LTE-FDD (SC-FDMA, 50% RB, 20 MHz, 64-QAM)	LTE-FDD	6.60	± 9.6 %
10151	CAG	LTE-TDD (SC-FDMA, 50% RB, 20 MHz, QPSK)	LTE-TDD	9.28	± 9.6 %
10152	CAG	LTE-TDD (SC-FDMA, 50% RB, 20 MHz, 16-QAM)	LTE-TDD	9.92	± 9.6 %
10153	CAG	LTE-TDD (SC-FDMA, 50% RB, 20 MHz, 64-QAM)	LTE-TDD	10.05	± 9.6 %
10154	CAG	LTE-FDD (SC-FDMA, 50% RB, 10 MHz, QPSK)	LTE-FDD	5.75	± 9.6 %
10155	CAG	LTE-FDD (SC-FDMA, 50% RB, 10 MHz, 16-QAM)	LTE-FDD	6.43	± 9.6 %
10156	CAG	LTE-FDD (SC-FDMA, 50% RB, 5 MHz, QPSK)	LTE-FDD	5.79	± 9.6 %
10157	CAG	LTE-FDD (SC-FDMA, 50% RB, 5 MHz, 16-QAM)	LTE-FDD	6.49	± 9.6 %
10158	CAG	LTE-FDD (SC-FDMA, 50% RB, 10 MHz, 64-QAM)	LTE-FDD	6.62	± 9.6 %
10159	CAG	LTE-FDD (SC-FDMA, 50% RB, 5 MHz, 64-QAM)	LTE-FDD	6.56	± 9.6 %
10160	CAE	LTE-FDD (SC-FDMA, 50% RB, 15 MHz, QPSK)	LTE-FDD	5.82	± 9.6 %
10161	CAE	LTE-FDD (SC-FDMA, 50% RB, 15 MHz, 16-QAM)	LTE-FDD	6.43	± 9.6 %
10162	CAE	LTE-FDD (SC-FDMA, 50% RB, 15 MHz, 64-QAM)	LTE-FDD	6.58	± 9.6 %
10166	CAF	LTE-FDD (SC-FDMA, 50% RB, 1.4 MHz, QPSK)	LTE-FDD	5.46	± 9.6 %
10167	CAF	LTE-FDD (SC-FDMA, 50% RB, 1.4 MHz, 16-QAM)	LTE-FDD	6.21	± 9.6 %
10168	CAF	LTE-FDD (SC-FDMA, 50% RB, 1.4 MHz, 64-QAM)	LTE-FDD	6.79	± 9.6 %
10169	CAE	LTE-FDD (SC-FDMA, 1 RB, 20 MHz, QPSK)	LTE-FDD	5.73	± 9.6 %
10170	CAE	LTE-FDD (SC-FDMA, 1 RB, 20 MHz, 16-QAM)	LTE-FDD	6.52	± 9.6 %
10171	AAE	LTE-FDD (SC-FDMA, 1 RB, 20 MHz, 64-QAM)	LTE-FDD	6.49	± 9.6 %
10172	CAG	LTE-TDD (SC-FDMA, 1 RB, 20 MHz, QPSK)	LTE-TDD	9.21	± 9.6 %
10173	CAG	LTE-TDD (SC-FDMA, 1 RB, 20 MHz, 16-QAM)	LTE-TDD	9.48	± 9.6 %
10174	CAG	LTE-TDD (SC-FDMA, 1 RB, 20 MHz, 64-QAM)	LTE-TDD	10.25	± 9.6 %
10175	CAG	LTE-FDD (SC-FDMA, 1 RB, 10 MHz, QPSK)	LTE-FDD	5.72	± 9.6 %
10176	CAG	LTE-FDD (SC-FDMA, 1 RB, 10 MHz, 16-QAM)	LTE-FDD	6.52	± 9.6 %
10177	CAI	LTE-FDD (SC-FDMA, 1 RB, 5 MHz, QPSK)	LTE-FDD	5.73	± 9.6 %
10178	CAG	LTE-FDD (SC-FDMA, 1 RB, 5 MHz, 16-QAM)	LTE-FDD	6.52	± 9.6 %
10179	CAG	LTE-FDD (SC-FDMA, 1 RB, 10 MHz, 64-QAM)	LTE-FDD	6.50	± 9.6 %
10180	CAG	LTE-FDD (SC-FDMA, 1 RB, 5 MHz, 64-QAM)	LTE-FDD	6.50	± 9.6 %
10181	CAE	LTE-FDD (SC-FDMA, 1 RB, 15 MHz, QPSK)	LTE-FDD	5.73	± 9.6 %

10182	CAE	LTE-FDD (SC-FDMA, 1 RB, 15 MHz, 16-QAM)	LTE-FDD	6.52	± 9.6 %
10183	AAD	LTE-FDD (SC-FDMA, 1 RB, 15 MHz, 64-QAM)	LTE-FDD	6.50	± 9.6 %
10184	CAE	LTE-FDD (SC-FDMA, 1 RB, 3 MHz, QPSK)	LTE-FDD	5.73	± 9.6 %
10185	CAE	LTE-FDD (SC-FDMA, 1 RB, 3 MHz, 16-QAM)	LTE-FDD	6.51	± 9.6 %
10186	AAE	LTE-FDD (SC-FDMA, 1 RB, 3 MHz, 64-QAM)	LTE-FDD	6.50	± 9.6 %
10187	CAF	LTE-FDD (SC-FDMA, 1 RB, 1.4 MHz, QPSK)	LTE-FDD	5.73	± 9.6 %
10188	CAF	LTE-FDD (SC-FDMA, 1 RB, 1.4 MHz, 16-QAM)	LTE-FDD	6.52	± 9.6 %
10189	AAF	LTE-FDD (SC-FDMA, 1 RB, 1.4 MHz, 64-QAM)	LTE-FDD	6.50	± 9.6 %
10193	CAD	IEEE 802.11n (HT Greenfield, 6.5 Mbps, BPSK)	WLAN	8.09	± 9.6 %
10194	CAD	IEEE 802.11n (HT Greenfield, 39 Mbps, 16-QAM)	WLAN	8.12	± 9.6 %
10195	CAD	IEEE 802.11n (HT Greenfield, 65 Mbps, 64-QAM)	WLAN	8.21	± 9.6 %
10196	CAD	IEEE 802.11n (HT Mixed, 6.5 Mbps, BPSK)	WLAN	8.10	± 9.6 %
10197	CAD	IEEE 802.11n (HT Mixed, 39 Mbps, 16-QAM)	WLAN	8.13	± 9.6 %
10198	CAD	IEEE 802.11n (HT Mixed, 65 Mbps, 64-QAM)	WLAN	8.27	± 9.6 %
10219	CAD	IEEE 802.11n (HT Mixed, 7.2 Mbps, BPSK)	WLAN	8.03	± 9.6 %
10220	CAD	IEEE 802.11n (HT Mixed, 43.3 Mbps, 16-QAM)	WLAN	8.13	± 9.6 %
10221	CAD	IEEE 802.11n (HT Mixed, 72.2 Mbps, 64-QAM)	WLAN	8.27	± 9.6 %
10222	CAD	IEEE 802.11n (HT Mixed, 15 Mbps, BPSK)	WLAN	8.06	± 9.6 %
10223	CAD	IEEE 802.11n (HT Mixed, 90 Mbps, 16-QAM)	WLAN	8.48	± 9.6 %
10224	CAD	IEEE 802.11n (HT Mixed, 150 Mbps, 64-QAM)	WLAN	8.08	± 9.6 %
10225	CAB	UMTS-FDD (HSPA+)	WCDMA	5.97	± 9.6 %
10226	CAB	LTE-TDD (SC-FDMA, 1 RB, 1.4 MHz, 16-QAM)	LTE-TDD	9.49	± 9.6 %
10227	CAB	LTE-TDD (SC-FDMA, 1 RB, 1.4 MHz, 64-QAM)	LTE-TDD	10.26	± 9.6 %
10228	CAB	LTE-TDD (SC-FDMA, 1 RB, 1.4 MHz, QPSK)	LTE-TDD	9.22	± 9.6 %
10229	CAD	LTE-TDD (SC-FDMA, 1 RB, 3 MHz, 16-QAM)	LTE-TDD	9.48	± 9.6 %
10230	CAD	LTE-TDD (SC-FDMA, 1 RB, 3 MHz, 64-QAM)	LTE-TDD	10.25	± 9.6 %
10231	CAD	LTE-TDD (SC-FDMA, 1 RB, 3 MHz, QPSK)	LTE-TDD	9.19	± 9.6 %
10232	CAG	LTE-TDD (SC-FDMA, 1 RB, 5 MHz, 16-QAM)	LTE-TDD	9.48	± 9.6 %
10233	CAG	LTE-TDD (SC-FDMA, 1 RB, 5 MHz, 64-QAM)	LTE-TDD	10.25	± 9.6 %
10234	CAG	LTE-TDD (SC-FDMA, 1 RB, 5 MHz, QPSK)	LTE-TDD	9.21	± 9.6 %
10235	CAG	LTE-TDD (SC-FDMA, 1 RB, 10 MHz, 16-QAM)	LTE-TDD	9.48	± 9.6 %
10236	CAG	LTE-TDD (SC-FDMA, 1 RB, 10 MHz, 64-QAM)	LTE-TDD	10.25	± 9.6 %
10237	CAG	LTE-TDD (SC-FDMA, 1 RB, 10 MHz, QPSK)	LTE-TDD	9.21	± 9.6 %
10238	CAF	LTE-TDD (SC-FDMA, 1 RB, 15 MHz, 16-QAM)	LTE-TDD	9.48	± 9.6 %
10239	CAF	LTE-TDD (SC-FDMA, 1 RB, 15 MHz, 64-QAM)	LTE-TDD	10.25	± 9.6 %
10240	CAF	LTE-TDD (SC-FDMA, 1 RB, 15 MHz, QPSK)	LTE-TDD	9.21	± 9.6 %
10241	CAB	LTE-TDD (SC-FDMA, 50% RB, 1.4 MHz, 16-QAM)	LTE-TDD	9.82	± 9.6 %
10242	CAB	LTE-TDD (SC-FDMA, 50% RB, 1.4 MHz, 64-QAM)	LTE-TDD	9.86	± 9.6 %
10243	CAB	LTE-TDD (SC-FDMA, 50% RB, 1.4 MHz, QPSK)	LTE-TDD	9.46	± 9.6 %
10244	CAD	LTE-TDD (SC-FDMA, 50% RB, 3 MHz, 16-QAM)	LTE-TDD	10.06	± 9.6 %
10245	CAD	LTE-TDD (SC-FDMA, 50% RB, 3 MHz, 64-QAM)	LTE-TDD	10.06	± 9.6 %
10246	CAD	LTE-TDD (SC-FDMA, 50% RB, 3 MHz, QPSK)	LTE-TDD	9.30	± 9.6 %
10247	CAG	LTE-TDD (SC-FDMA, 50% RB, 5 MHz, 16-QAM)	LTE-TDD	9.91	± 9.6 %
10248	CAG	LTE-TDD (SC-FDMA, 50% RB, 5 MHz, 64-QAM)	LTE-TDD	10.09	± 9.6 %
10249	CAG	LTE-TDD (SC-FDMA, 50% RB, 5 MHz, QPSK)	LTE-TDD	9.29	± 9.6 %
10250	CAG	LTE-TDD (SC-FDMA, 50% RB, 10 MHz, 16-QAM)	LTE-TDD	9.81	± 9.6 %
10251	CAG	LTE-TDD (SC-FDMA, 50% RB, 10 MHz, 64-QAM)	LTE-TDD	10.17	± 9.6 %
10252	CAG	LTE-TDD (SC-FDMA, 50% RB, 10 MHz, QPSK)	LTE-TDD	9.24	± 9.6 %
10253	CAF	LTE-TDD (SC-FDMA, 50% RB, 15 MHz, 16-QAM)	LTE-TDD	9.90	± 9.6 %
10254	CAF	LTE-TDD (SC-FDMA, 50% RB, 15 MHz, 64-QAM)	LTE-TDD	10.14	± 9.6 %
10255	CAF	LTE-TDD (SC-FDMA, 50% RB, 15 MHz, QPSK)	LTE-TDD	9.20	± 9.6 %
10256	CAB	LTE-TDD (SC-FDMA, 100% RB, 1.4 MHz, 16-QAM)	LTE-TDD	9.96	± 9.6 %
10257	CAB	LTE-TDD (SC-FDMA, 100% RB, 1.4 MHz, 64-QAM)	LTE-TDD	10.08	± 9.6 %
10258	CAB	LTE-TDD (SC-FDMA, 100% RB, 1.4 MHz, QPSK)	LTE-TDD	9.34	± 9.6 %
10259	CAD	LTE-TDD (SC-FDMA, 100% RB, 3 MHz, 16-QAM)	LTE-TDD	9.98	± 9.6 %
10260	CAD	LTE-TDD (SC-FDMA, 100% RB, 3 MHz, 64-QAM)	LTE-TDD	9.97	± 9.6 %

10261	CAD	LTE-TDD (SC-FDMA, 100% RB, 3 MHz, QPSK)	LTE-TDD	9.24	± 9.6 %
10262	CAG	LTE-TDD (SC-FDMA, 100% RB, 5 MHz, 16-QAM)	LTE-TDD	9.83	± 9.6 %
10263	CAG	LTE-TDD (SC-FDMA, 100% RB, 5 MHz, 64-QAM)	LTE-TDD	10.16	± 9.6 %
10264	CAG	LTE-TDD (SC-FDMA, 100% RB, 5 MHz, QPSK)	LTE-TDD	9.23	± 9.6 %
10265	CAG	LTE-TDD (SC-FDMA, 100% RB, 10 MHz, 16-QAM)	LTE-TDD	9.92	± 9.6 %
10266	CAG	LTE-TDD (SC-FDMA, 100% RB, 10 MHz, 64-QAM)	LTE-TDD	10.07	± 9.6 %
10267	CAG	LTE-TDD (SC-FDMA, 100% RB, 10 MHz, QPSK)	LTE-TDD	9.30	± 9.6 %
10268	CAF	LTE-TDD (SC-FDMA, 100% RB, 15 MHz, 16-QAM)	LTE-TDD	10.06	± 9.6 %
10269	CAF	LTE-TDD (SC-FDMA, 100% RB, 15 MHz, 64-QAM)	LTE-TDD	10.13	± 9.6 %
10270	CAF	LTE-TDD (SC-FDMA, 100% RB, 15 MHz, QPSK)	LTE-TDD	9.58	± 9.6 %
10274	CAB	UMTS-FDD (HSUPA, Subtest 5, 3GPP Rel8.10)	WCDMA	4.87	± 9.6 %
10275	CAB	UMTS-FDD (HSUPA, Subtest 5, 3GPP Rel8.4)	WCDMA	3.96	± 9.6 %
10277	CAA	PHS (QPSK)	PHS	11.81	± 9.6 %
10278	CAA	PHS (QPSK, BW 884MHz, Rolloff 0.5)	PHS	11.81	± 9.6 %
10279	CAA	PHS (QPSK, BW 884MHz, Rolloff 0.38)	PHS	12.18	± 9.6 %
10290	AAB	CDMA2000, RC1, SO55, Full Rate	CDMA2000	3.91	± 9.6 %
10291	AAB	CDMA2000, RC3, SO55, Full Rate	CDMA2000	3.46	± 9.6 %
10292	AAB	CDMA2000, RC3, SO32, Full Rate	CDMA2000	3.39	± 9.6 %
10293	AAB	CDMA2000, RC3, SO3, Full Rate	CDMA2000	3.50	± 9.6 %
10295	AAB	CDMA2000, RC1, SO3, 1/8th Rate 25 fr.	CDMA2000	12.49	± 9.6 %
10297	AAD	LTE-FDD (SC-FDMA, 50% RB, 20 MHz, QPSK)	LTE-FDD	5.81	± 9.6 %
10298	AAD	LTE-FDD (SC-FDMA, 50% RB, 3 MHz, QPSK)	LTE-FDD	5.72	± 9.6 %
10299	AAD	LTE-FDD (SC-FDMA, 50% RB, 3 MHz, 16-QAM)	LTE-FDD	6.39	± 9.6 %
10300	AAD	LTE-FDD (SC-FDMA, 50% RB, 3 MHz, 64-QAM)	LTE-FDD	6.60	± 9.6 %
10301	AAA	IEEE 802.16e WiMAX (29:18, 5ms, 10MHz, QPSK, PUSC)	WiMAX	12.03	± 9.6 %
10302	AAA	IEEE 802.16e WiMAX (29:18, 5ms, 10MHz, QPSK, PUSC, 3CTRL)	WiMAX	12.57	± 9.6 %
10303	AAA	IEEE 802.16e WiMAX (31:15, 5ms, 10MHz, 64QAM, PUSC)	WiMAX	12.52	± 9.6 %
10304	AAA	IEEE 802.16e WiMAX (29:18, 5ms, 10MHz, 64QAM, PUSC)	WiMAX	11.86	± 9.6 %
10305	AAA	IEEE 802.16e WiMAX (31:15, 10ms, 10MHz, 64QAM, PUSC)	WiMAX	15.24	± 9.6 %
10306	AAA	IEEE 802.16e WiMAX (29:18, 10ms, 10MHz, 64QAM, PUSC)	WiMAX	14.67	± 9.6 %
10307	AAA	IEEE 802.16e WiMAX (29:18, 10ms, 10MHz, QPSK, PUSC)	WiMAX	14.49	± 9.6 %
10308	AAA	IEEE 802.16e WiMAX (29:18, 10ms, 10MHz, 16QAM, PUSC)	WiMAX	14.46	± 9.6 %
10309	AAA	IEEE 802.16e WiMAX (29:18, 10ms, 10MHz, 16QAM, AMC 2x3)	WiMAX	14.58	± 9.6 %
10310	AAA	IEEE 802.16e WiMAX (29:18, 10ms, 10MHz, QPSK, AMC 2x3)	WiMAX	14.57	± 9.6 %
10311	AAD	LTE-FDD (SC-FDMA, 100% RB, 15 MHz, QPSK)	LTE-FDD	6.06	± 9.6 %
10313	AAA	iDEN 1:3	iDEN	10.51	± 9.6 %
10314	AAA	iDEN 1:6	iDEN	13.48	± 9.6 %
10315	AAB	IEEE 802.11b WiFi 2.4 GHz (DSSS, 1 Mbps, 96pc dc)	WLAN	1.71	± 9.6 %
10316	AAB	IEEE 802.11g WiFi 2.4 GHz (ERP-OFDM, 6 Mbps, 96pc dc)	WLAN	8.36	± 9.6 %
10317	AAD	IEEE 802.11a WiFi 5 GHz (OFDM, 6 Mbps, 96pc dc)	WLAN	8.36	± 9.6 %
10352	AAA	Pulse Waveform (200Hz, 10%)	Generic	10.00	± 9.6 %
10353	AAA	Pulse Waveform (200Hz, 20%)	Generic	6.99	± 9.6 %
10354	AAA	Pulse Waveform (200Hz, 40%)	Generic	3.98	± 9.6 %
10355	AAA	Pulse Waveform (200Hz, 60%)	Generic	2.22	± 9.6 %
10356	AAA	Pulse Waveform (200Hz, 80%)	Generic	0.97	± 9.6 %
10387	AAA	QPSK Waveform, 1 MHz	Generic	5.10	± 9.6 %
10388	AAA	QPSK Waveform, 10 MHz	Generic	5.22	± 9.6 %
10396	AAA	64-QAM Waveform, 100 kHz	Generic	6.27	± 9.6 %
10399	AAA	64-QAM Waveform, 40 MHz	Generic	6.27	± 9.6 %
10400	AAE	IEEE 802.11ac WiFi (20MHz, 64-QAM, 99pc dc)	WLAN	8.37	± 9.6 %
10401	AAE	IEEE 802.11ac WiFi (40MHz, 64-QAM, 99pc dc)	WLAN	8.60	± 9.6 %
10402	AAE	IEEE 802.11ac WiFi (80MHz, 64-QAM, 99pc dc)	WLAN	8.53	± 9.6 %
10403	AAB	CDMA2000 (1xEV-DO, Rev. 0)	CDMA2000	3.76	± 9.6 %
10404	AAB	CDMA2000 (1xEV-DO, Rev. A)	CDMA2000	3.77	± 9.6 %
10406	AAB	CDMA2000, RC3, SO32, SCH0, Full Rate	CDMA2000	5.22	± 9.6 %
10410	AAG	LTE-TDD (SC-FDMA, 1 RB, 10 MHz, QPSK, UL Sub=2,3,4,7,8,9)	LTE-TDD	7.82	± 9.6 %

10414	AAA	WLAN CCDF, 64-QAM, 40MHz	Generic	8.54	± 9.6 %
10415	AAA	IEEE 802.11b WiFi 2.4 GHz (DSSS, 1 Mbps, 99pc dc)	WLAN	1.54	± 9.6 %
10416	AAA	IEEE 802.11g WiFi 2.4 GHz (ERP-OFDM, 6 Mbps, 99pc dc)	WLAN	8.23	± 9.6 %
10417	AAC	IEEE 802.11a/h WiFi 5 GHz (OFDM, 6 Mbps, 99pc dc)	WLAN	8.23	± 9.6 %
10418	AAA	IEEE 802.11g WiFi 2.4 GHz (DSSS-OFDM, 6 Mbps, 99pc, Long)	WLAN	8.14	± 9.6 %
10419	AAA	IEEE 802.11g WiFi 2.4 GHz (DSSS-OFDM, 6 Mbps, 99pc, Short)	WLAN	8.19	± 9.6 %
10422	AAC	IEEE 802.11n (HT Greenfield, 7.2 Mbps, BPSK)	WLAN	8.32	± 9.6 %
10423	AAC	IEEE 802.11n (HT Greenfield, 43.3 Mbps, 16-QAM)	WLAN	8.47	± 9.6 %
10424	AAC	IEEE 802.11n (HT Greenfield, 72.2 Mbps, 64-QAM)	WLAN	8.40	± 9.6 %
10425	AAC	IEEE 802.11n (HT Greenfield, 15 Mbps, BPSK)	WLAN	8.41	± 9.6 %
10426	AAC	IEEE 802.11n (HT Greenfield, 90 Mbps, 16-QAM)	WLAN	8.45	± 9.6 %
10427	AAC	IEEE 802.11n (HT Greenfield, 150 Mbps, 64-QAM)	WLAN	8.41	± 9.6 %
10430	AAD	LTE-FDD (OFDMA, 5 MHz, E-TM 3.1)	LTE-FDD	8.28	± 9.6 %
10431	AAD	LTE-FDD (OFDMA, 10 MHz, E-TM 3.1)	LTE-FDD	8.38	± 9.6 %
10432	AAC	LTE-FDD (OFDMA, 15 MHz, E-TM 3.1)	LTE-FDD	8.34	± 9.6 %
10433	AAC	LTE-FDD (OFDMA, 20 MHz, E-TM 3.1)	LTE-FDD	8.34	± 9.6 %
10434	AAA	W-CDMA (BS Test Model 1, 64 DPCH)	WCDMA	8.60	± 9.6 %
10435	AAF	LTE-TDD (SC-FDMA, 1 RB, 20 MHz, QPSK, UL Sub)	LTE-TDD	7.82	± 9.6 %
10447	AAD	LTE-FDD (OFDMA, 5 MHz, E-TM 3.1, Clipping 44%)	LTE-FDD	7.56	± 9.6 %
10448	AAD	LTE-FDD (OFDMA, 10 MHz, E-TM 3.1, Clipping 44%)	LTE-FDD	7.53	± 9.6 %
10449	AAC	LTE-FDD (OFDMA, 15 MHz, E-TM 3.1, Clipping 44%)	LTE-FDD	7.51	± 9.6 %
10450	AAC	LTE-FDD (OFDMA, 20 MHz, E-TM 3.1, Clipping 44%)	LTE-FDD	7.48	± 9.6 %
10451	AAA	W-CDMA (BS Test Model 1, 64 DPCH, Clipping 44%)	WCDMA	7.59	± 9.6 %
10453	AAD	Validation (Square, 10ms, 1ms)	Test	10.00	± 9.6 %
10456	AAC	IEEE 802.11ac WiFi (160MHz, 64-QAM, 99pc dc)	WLAN	8.63	± 9.6 %
10457	AAA	UMTS-FDD (DC-HSDPA)	WCDMA	6.62	± 9.6 %
10458	AAA	CDMA2000 (1xEV-DO, Rev. B, 2 carriers)	CDMA2000	6.55	± 9.6 %
10459	AAA	CDMA2000 (1xEV-DO, Rev. B, 3 carriers)	CDMA2000	8.25	± 9.6 %
10460	AAA	UMTS-FDD (WCDMA, AMR)	WCDMA	2.39	± 9.6 %
10461	AAB	LTE-TDD (SC-FDMA, 1 RB, 1.4 MHz, QPSK, UL Sub)	LTE-TDD	7.82	± 9.6 %
10462	AAB	LTE-TDD (SC-FDMA, 1 RB, 1.4 MHz, 16-QAM, UL Sub)	LTE-TDD	8.30	± 9.6 %
10463	AAB	LTE-TDD (SC-FDMA, 1 RB, 1.4 MHz, 64-QAM, UL Sub)	LTE-TDD	8.56	± 9.6 %
10464	AAC	LTE-TDD (SC-FDMA, 1 RB, 3 MHz, QPSK, UL Sub)	LTE-TDD	7.82	± 9.6 %
10465	AAC	LTE-TDD (SC-FDMA, 1 RB, 3 MHz, 16-QAM, UL Sub)	LTE-TDD	8.32	± 9.6 %
10466	AAC	LTE-TDD (SC-FDMA, 1 RB, 3 MHz, 64-QAM, UL Sub)	LTE-TDD	8.57	± 9.6 %
10467	AAF	LTE-TDD (SC-FDMA, 1 RB, 5 MHz, QPSK, UL Sub)	LTE-TDD	7.82	± 9.6 %
10468	AAF	LTE-TDD (SC-FDMA, 1 RB, 5 MHz, 16-QAM, UL Sub)	LTE-TDD	8.32	± 9.6 %
10469	AAF	LTE-TDD (SC-FDMA, 1 RB, 5 MHz, 64-QAM, UL Sub)	LTE-TDD	8.56	± 9.6 %
10470	AAF	LTE-TDD (SC-FDMA, 1 RB, 10 MHz, QPSK, UL Sub)	LTE-TDD	7.82	± 9.6 %
10471	AAF	LTE-TDD (SC-FDMA, 1 RB, 10 MHz, 16-QAM, UL Sub)	LTE-TDD	8.32	± 9.6 %
10472	AAF	LTE-TDD (SC-FDMA, 1 RB, 10 MHz, 64-QAM, UL Sub)	LTE-TDD	8.57	± 9.6 %
10473	AAE	LTE-TDD (SC-FDMA, 1 RB, 15 MHz, QPSK, UL Sub)	LTE-TDD	7.82	± 9.6 %
10474	AAE	LTE-TDD (SC-FDMA, 1 RB, 15 MHz, 16-QAM, UL Sub)	LTE-TDD	8.32	± 9.6 %
10475	AAE	LTE-TDD (SC-FDMA, 1 RB, 15 MHz, 64-QAM, UL Sub)	LTE-TDD	8.57	± 9.6 %
10477	AAF	LTE-TDD (SC-FDMA, 1 RB, 20 MHz, 16-QAM, UL Sub)	LTE-TDD	8.32	± 9.6 %
10478	AAF	LTE-TDD (SC-FDMA, 1 RB, 20 MHz, 64-QAM, UL Sub)	LTE-TDD	8.57	± 9.6 %
10479	AAB	LTE-TDD (SC-FDMA, 50% RB, 1.4 MHz, QPSK, UL Sub)	LTE-TDD	7.74	± 9.6 %
10480	AAB	LTE-TDD (SC-FDMA, 50% RB, 1.4 MHz, 16-QAM, UL Sub)	LTE-TDD	8.18	± 9.6 %
10481	AAB	LTE-TDD (SC-FDMA, 50% RB, 1.4 MHz, 64-QAM, UL Sub)	LTE-TDD	8.45	± 9.6 %
10482	AAC	LTE-TDD (SC-FDMA, 50% RB, 3 MHz, QPSK, UL Sub)	LTE-TDD	7.71	± 9.6 %
10483	AAC	LTE-TDD (SC-FDMA, 50% RB, 3 MHz, 16-QAM, Sub)	LTE-TDD	8.39	± 9.6 %
10484	AAC	LTE-TDD (SC-FDMA, 50% RB, 3 MHz, 64-QAM, UL Sub)	LTE-TDD	8.47	± 9.6 %
10485	AAF	LTE-TDD (SC-FDMA, 50% RB, 5 MHz, QPSK, UL Sub)	LTE-TDD	7.59	± 9.6 %
10486	AAF	LTE-TDD (SC-FDMA, 50% RB, 5 MHz, 16-QAM, UL Sub)	LTE-TDD	8.38	± 9.6 %
10487	AAF	LTE-TDD (SC-FDMA, 50% RB, 5 MHz, 64-QAM, UL Sub)	LTE-TDD	8.60	± 9.6 %
10488	AAF	LTE-TDD (SC-FDMA, 50% RB, 10 MHz, QPSK, UL Sub)	LTE-TDD	7.70	± 9.6 %

10489	AAF	LTE-TDD (SC-FDMA, 50% RB, 10 MHz, 16-QAM, UL Sub)	LTE-TDD	8.31	± 9.6 %
10490	AAF	LTE-TDD (SC-FDMA, 50% RB, 10 MHz, 64-QAM, UL Sub)	LTE-TDD	8.54	± 9.6 %
10491	AAE	LTE-TDD (SC-FDMA, 50% RB, 15 MHz, QPSK, UL Sub)	LTE-TDD	7.74	± 9.6 %
10492	AAE	LTE-TDD (SC-FDMA, 50% RB, 15 MHz, 16-QAM, UL Sub)	LTE-TDD	8.41	± 9.6 %
10493	AAE	LTE-TDD (SC-FDMA, 50% RB, 15 MHz, 64-QAM, UL Sub)	LTE-TDD	8.55	± 9.6 %
10494	AAF	LTE-TDD (SC-FDMA, 50% RB, 20 MHz, QPSK, UL Sub)	LTE-TDD	7.74	± 9.6 %
10495	AAF	LTE-TDD (SC-FDMA, 50% RB, 20 MHz, 16-QAM, UL Sub)	LTE-TDD	8.37	± 9.6 %
10496	AAF	LTE-TDD (SC-FDMA, 50% RB, 20 MHz, 64-QAM, UL Sub)	LTE-TDD	8.54	± 9.6 %
10497	AAB	LTE-TDD (SC-FDMA, 100% RB, 1.4 MHz, QPSK, UL Sub)	LTE-TDD	7.67	± 9.6 %
10498	AAB	LTE-TDD (SC-FDMA, 100% RB, 1.4 MHz, 16-QAM, UL Sub)	LTE-TDD	8.40	± 9.6 %
10499	AAB	LTE-TDD (SC-FDMA, 100% RB, 1.4 MHz, 64-QAM, UL Sub)	LTE-TDD	8.68	± 9.6 %
10500	AAC	LTE-TDD (SC-FDMA, 100% RB, 3 MHz, QPSK, UL Sub)	LTE-TDD	7.67	± 9.6 %
10501	AAC	LTE-TDD (SC-FDMA, 100% RB, 3 MHz, 16-QAM, UL Sub)	LTE-TDD	8.44	± 9.6 %
10502	AAC	LTE-TDD (SC-FDMA, 100% RB, 3 MHz, 64-QAM, UL Sub)	LTE-TDD	8.52	± 9.6 %
10503	AAF	LTE-TDD (SC-FDMA, 100% RB, 5 MHz, QPSK, UL Sub)	LTE-TDD	7.72	± 9.6 %
10504	AAF	LTE-TDD (SC-FDMA, 100% RB, 5 MHz, 16-QAM, UL Sub)	LTE-TDD	8.31	± 9.6 %
10505	AAF	LTE-TDD (SC-FDMA, 100% RB, 5 MHz, 64-QAM, UL Sub)	LTE-TDD	8.54	± 9.6 %
10506	AAF	LTE-TDD (SC-FDMA, 100% RB, 10 MHz, QPSK, UL Sub)	LTE-TDD	7.74	± 9.6 %
10507	AAF	LTE-TDD (SC-FDMA, 100% RB, 10 MHz, 16-QAM, UL Sub)	LTE-TDD	8.36	± 9.6 %
10508	AAF	LTE-TDD (SC-FDMA, 100% RB, 10 MHz, 64-QAM, UL Sub)	LTE-TDD	8.55	± 9.6 %
10509	AAE	LTE-TDD (SC-FDMA, 100% RB, 15 MHz, QPSK, UL Sub)	LTE-TDD	7.99	± 9.6 %
10510	AAE	LTE-TDD (SC-FDMA, 100% RB, 15 MHz, 16-QAM, UL Sub)	LTE-TDD	8.49	± 9.6 %
10511	AAE	LTE-TDD (SC-FDMA, 100% RB, 15 MHz, 64-QAM, UL Sub)	LTE-TDD	8.51	± 9.6 %
10512	AAF	LTE-TDD (SC-FDMA, 100% RB, 20 MHz, QPSK, UL Sub)	LTE-TDD	7.74	± 9.6 %
10513	AAF	LTE-TDD (SC-FDMA, 100% RB, 20 MHz, 16-QAM, UL Sub)	LTE-TDD	8.42	± 9.6 %
10514	AAF	LTE-TDD (SC-FDMA, 100% RB, 20 MHz, 64-QAM, UL Sub)	LTE-TDD	8.45	± 9.6 %
10515	AAA	IEEE 802.11b WiFi 2.4 GHz (DSSS, 2 Mbps, 99pc dc)	WLAN	1.58	± 9.6 %
10516	AAA	IEEE 802.11b WiFi 2.4 GHz (DSSS, 5.5 Mbps, 99pc dc)	WLAN	1.57	± 9.6 %
10517	AAA	IEEE 802.11b WiFi 2.4 GHz (DSSS, 11 Mbps, 99pc dc)	WLAN	1.58	± 9.6 %
10518	AAC	IEEE 802.11a/h WiFi 5 GHz (OFDM, 9 Mbps, 99pc dc)	WLAN	8.23	± 9.6 %
10519	AAC	IEEE 802.11a/h WiFi 5 GHz (OFDM, 12 Mbps, 99pc dc)	WLAN	8.39	± 9.6 %
10520	AAC	IEEE 802.11a/h WiFi 5 GHz (OFDM, 18 Mbps, 99pc dc)	WLAN	8.12	± 9.6 %
10521	AAC	IEEE 802.11a/h WiFi 5 GHz (OFDM, 24 Mbps, 99pc dc)	WLAN	7.97	± 9.6 %
10522	AAC	IEEE 802.11a/h WiFi 5 GHz (OFDM, 36 Mbps, 99pc dc)	WLAN	8.45	± 9.6 %
10523	AAC	IEEE 802.11a/h WiFi 5 GHz (OFDM, 48 Mbps, 99pc dc)	WLAN	8.08	± 9.6 %
10524	AAC	IEEE 802.11a/h WiFi 5 GHz (OFDM, 54 Mbps, 99pc dc)	WLAN	8.27	± 9.6 %
10525	AAC	IEEE 802.11ac WiFi (20MHz, MCS0, 99pc dc)	WLAN	8.36	± 9.6 %
10526	AAC	IEEE 802.11ac WiFi (20MHz, MCS1, 99pc dc)	WLAN	8.42	± 9.6 %
10527	AAC	IEEE 802.11ac WiFi (20MHz, MCS2, 99pc dc)	WLAN	8.21	± 9.6 %
10528	AAC	IEEE 802.11ac WiFi (20MHz, MCS3, 99pc dc)	WLAN	8.36	± 9.6 %
10529	AAC	IEEE 802.11ac WiFi (20MHz, MCS4, 99pc dc)	WLAN	8.36	± 9.6 %
10531	AAC	IEEE 802.11ac WiFi (20MHz, MCS6, 99pc dc)	WLAN	8.43	± 9.6 %
10532	AAC	IEEE 802.11ac WiFi (20MHz, MCS7, 99pc dc)	WLAN	8.29	± 9.6 %
10533	AAC	IEEE 802.11ac WiFi (20MHz, MCS8, 99pc dc)	WLAN	8.38	± 9.6 %
10534	AAC	IEEE 802.11ac WiFi (40MHz, MCS0, 99pc dc)	WLAN	8.45	± 9.6 %
10535	AAC	IEEE 802.11ac WiFi (40MHz, MCS1, 99pc dc)	WLAN	8.45	± 9.6 %
10536	AAC	IEEE 802.11ac WiFi (40MHz, MCS2, 99pc dc)	WLAN	8.32	± 9.6 %
10537	AAC	IEEE 802.11ac WiFi (40MHz, MCS3, 99pc dc)	WLAN	8.44	± 9.6 %
10538	AAC	IEEE 802.11ac WiFi (40MHz, MCS4, 99pc dc)	WLAN	8.54	± 9.6 %
10540	AAC	IEEE 802.11ac WiFi (40MHz, MCS6, 99pc dc)	WLAN	8.39	± 9.6 %
10541	AAC	IEEE 802.11ac WiFi (40MHz, MCS7, 99pc dc)	WLAN	8.46	± 9.6 %
10542	AAC	IEEE 802.11ac WiFi (40MHz, MCS8, 99pc dc)	WLAN	8.65	± 9.6 %
10543	AAC	IEEE 802.11ac WiFi (40MHz, MCS9, 99pc dc)	WLAN	8.65	± 9.6 %
10544	AAC	IEEE 802.11ac WiFi (80MHz, MCS0, 99pc dc)	WLAN	8.47	± 9.6 %
10545	AAC	IEEE 802.11ac WiFi (80MHz, MCS1, 99pc dc)	WLAN	8.55	± 9.6 %
10546	AAC	IEEE 802.11ac WiFi (80MHz, MCS2, 99pc dc)	WLAN	8.35	± 9.6 %

10547	AAC	IEEE 802.11ac WiFi (80MHz, MCS3, 99pc dc)	WLAN	8.49	± 9.6 %
10548	AAC	IEEE 802.11ac WiFi (80MHz, MCS4, 99pc dc)	WLAN	8.37	± 9.6 %
10550	AAC	IEEE 802.11ac WiFi (80MHz, MCS6, 99pc dc)	WLAN	8.39	± 9.6 %
10551	AAC	IEEE 802.11ac WiFi (80MHz, MCS7, 99pc dc)	WLAN	8.50	± 9.6 %
10552	AAC	IEEE 802.11ac WiFi (80MHz, MCS8, 99pc dc)	WLAN	8.42	± 9.6 %
10553	AAC	IEEE 802.11ac WiFi (80MHz, MCS9, 99pc dc)	WLAN	8.45	± 9.6 %
10554	AAD	IEEE 802.11ac WiFi (160MHz, MCS0, 99pc dc)	WLAN	8.48	± 9.6 %
10555	AAD	IEEE 802.11ac WiFi (160MHz, MCS1, 99pc dc)	WLAN	8.47	± 9.6 %
10556	AAD	IEEE 802.11ac WiFi (160MHz, MCS2, 99pc dc)	WLAN	8.50	± 9.6 %
10557	AAD	IEEE 802.11ac WiFi (160MHz, MCS3, 99pc dc)	WLAN	8.52	± 9.6 %
10558	AAD	IEEE 802.11ac WiFi (160MHz, MCS4, 99pc dc)	WLAN	8.61	± 9.6 %
10560	AAD	IEEE 802.11ac WiFi (160MHz, MCS6, 99pc dc)	WLAN	8.73	± 9.6 %
10561	AAD	IEEE 802.11ac WiFi (160MHz, MCS7, 99pc dc)	WLAN	8.56	± 9.6 %
10562	AAD	IEEE 802.11ac WiFi (160MHz, MCS8, 99pc dc)	WLAN	8.69	± 9.6 %
10563	AAD	IEEE 802.11ac WiFi (160MHz, MCS9, 99pc dc)	WLAN	8.77	± 9.6 %
10564	AAA	IEEE 802.11g WiFi 2.4 GHz (DSSS-OFDM, 9 Mbps, 99pc dc)	WLAN	8.25	± 9.6 %
10565	AAA	IEEE 802.11g WiFi 2.4 GHz (DSSS-OFDM, 12 Mbps, 99pc dc)	WLAN	8.45	± 9.6 %
10566	AAA	IEEE 802.11g WiFi 2.4 GHz (DSSS-OFDM, 18 Mbps, 99pc dc)	WLAN	8.13	± 9.6 %
10567	AAA	IEEE 802.11g WiFi 2.4 GHz (DSSS-OFDM, 24 Mbps, 99pc dc)	WLAN	8.00	± 9.6 %
10568	AAA	IEEE 802.11g WiFi 2.4 GHz (DSSS-OFDM, 36 Mbps, 99pc dc)	WLAN	8.37	± 9.6 %
10569	AAA	IEEE 802.11g WiFi 2.4 GHz (DSSS-OFDM, 48 Mbps, 99pc dc)	WLAN	8.10	± 9.6 %
10570	AAA	IEEE 802.11g WiFi 2.4 GHz (DSSS-OFDM, 54 Mbps, 99pc dc)	WLAN	8.30	± 9.6 %
10571	AAA	IEEE 802.11b WiFi 2.4 GHz (DSSS, 1 Mbps, 90pc dc)	WLAN	1.99	± 9.6 %
10572	AAA	IEEE 802.11b WiFi 2.4 GHz (DSSS, 2 Mbps, 90pc dc)	WLAN	1.99	± 9.6 %
10573	AAA	IEEE 802.11b WiFi 2.4 GHz (DSSS, 5.5 Mbps, 90pc dc)	WLAN	1.98	± 9.6 %
10574	AAA	IEEE 802.11b WiFi 2.4 GHz (DSSS, 11 Mbps, 90pc dc)	WLAN	1.98	± 9.6 %
10575	AAA	IEEE 802.11g WiFi 2.4 GHz (DSSS-OFDM, 6 Mbps, 90pc dc)	WLAN	8.59	± 9.6 %
10576	AAA	IEEE 802.11g WiFi 2.4 GHz (DSSS-OFDM, 9 Mbps, 90pc dc)	WLAN	8.60	± 9.6 %
10577	AAA	IEEE 802.11g WiFi 2.4 GHz (DSSS-OFDM, 12 Mbps, 90pc dc)	WLAN	8.70	± 9.6 %
10578	AAA	IEEE 802.11g WiFi 2.4 GHz (DSSS-OFDM, 18 Mbps, 90pc dc)	WLAN	8.49	± 9.6 %
10579	AAA	IEEE 802.11g WiFi 2.4 GHz (DSSS-OFDM, 24 Mbps, 90pc dc)	WLAN	8.36	± 9.6 %
10580	AAA	IEEE 802.11g WiFi 2.4 GHz (DSSS-OFDM, 36 Mbps, 90pc dc)	WLAN	8.76	± 9.6 %
10581	AAA	IEEE 802.11g WiFi 2.4 GHz (DSSS-OFDM, 48 Mbps, 90pc dc)	WLAN	8.35	± 9.6 %
10582	AAA	IEEE 802.11g WiFi 2.4 GHz (DSSS-OFDM, 54 Mbps, 90pc dc)	WLAN	8.67	± 9.6 %
10583	AAC	IEEE 802.11a/h WiFi 5 GHz (OFDM, 6 Mbps, 90pc dc)	WLAN	8.59	± 9.6 %
10584	AAC	IEEE 802.11a/h WiFi 5 GHz (OFDM, 9 Mbps, 90pc dc)	WLAN	8.60	± 9.6 %
10585	AAC	IEEE 802.11a/h WiFi 5 GHz (OFDM, 12 Mbps, 90pc dc)	WLAN	8.70	± 9.6 %
10586	AAC	IEEE 802.11a/h WiFi 5 GHz (OFDM, 18 Mbps, 90pc dc)	WLAN	8.49	± 9.6 %
10587	AAC	IEEE 802.11a/h WiFi 5 GHz (OFDM, 24 Mbps, 90pc dc)	WLAN	8.36	± 9.6 %
10588	AAC	IEEE 802.11a/h WiFi 5 GHz (OFDM, 36 Mbps, 90pc dc)	WLAN	8.76	± 9.6 %
10589	AAC	IEEE 802.11a/h WiFi 5 GHz (OFDM, 48 Mbps, 90pc dc)	WLAN	8.35	± 9.6 %
10590	AAC	IEEE 802.11a/h WiFi 5 GHz (OFDM, 54 Mbps, 90pc dc)	WLAN	8.67	± 9.6 %
10591	AAC	IEEE 802.11n (HT Mixed, 20MHz, MCS0, 90pc dc)	WLAN	8.63	± 9.6 %
10592	AAC	IEEE 802.11n (HT Mixed, 20MHz, MCS1, 90pc dc)	WLAN	8.79	± 9.6 %
10593	AAC	IEEE 802.11n (HT Mixed, 20MHz, MCS2, 90pc dc)	WLAN	8.64	± 9.6 %
10594	AAC	IEEE 802.11n (HT Mixed, 20MHz, MCS3, 90pc dc)	WLAN	8.74	± 9.6 %
10595	AAC	IEEE 802.11n (HT Mixed, 20MHz, MCS4, 90pc dc)	WLAN	8.74	± 9.6 %
10596	AAC	IEEE 802.11n (HT Mixed, 20MHz, MCS5, 90pc dc)	WLAN	8.71	± 9.6 %
10597	AAC	IEEE 802.11n (HT Mixed, 20MHz, MCS6, 90pc dc)	WLAN	8.72	± 9.6 %
10598	AAC	IEEE 802.11n (HT Mixed, 20MHz, MCS7, 90pc dc)	WLAN	8.50	± 9.6 %
10599	AAC	IEEE 802.11n (HT Mixed, 40MHz, MCS0, 90pc dc)	WLAN	8.79	± 9.6 %
10600	AAC	IEEE 802.11n (HT Mixed, 40MHz, MCS1, 90pc dc)	WLAN	8.88	± 9.6 %
10601	AAC	IEEE 802.11n (HT Mixed, 40MHz, MCS2, 90pc dc)	WLAN	8.82	± 9.6 %
10602	AAC	IEEE 802.11n (HT Mixed, 40MHz, MCS3, 90pc dc)	WLAN	8.94	± 9.6 %
10603	AAC	IEEE 802.11n (HT Mixed, 40MHz, MCS4, 90pc dc)	WLAN	9.03	± 9.6 %
10604	AAC	IEEE 802.11n (HT Mixed, 40MHz, MCS5, 90pc dc)	WLAN	8.76	± 9.6 %

10605	AAC	IEEE 802.11n (HT Mixed, 40MHz, MCS6, 90pc dc)	WLAN	8.97	± 9.6 %
10606	AAC	IEEE 802.11n (HT Mixed, 40MHz, MCS7, 90pc dc)	WLAN	8.82	± 9.6 %
10607	AAC	IEEE 802.11ac WiFi (20MHz, MCS0, 90pc dc)	WLAN	8.64	± 9.6 %
10608	AAC	IEEE 802.11ac WiFi (20MHz, MCS1, 90pc dc)	WLAN	8.77	± 9.6 %
10609	AAC	IEEE 802.11ac WiFi (20MHz, MCS2, 90pc dc)	WLAN	8.57	± 9.6 %
10610	AAC	IEEE 802.11ac WiFi (20MHz, MCS3, 90pc dc)	WLAN	8.78	± 9.6 %
10611	AAC	IEEE 802.11ac WiFi (20MHz, MCS4, 90pc dc)	WLAN	8.70	± 9.6 %
10612	AAC	IEEE 802.11ac WiFi (20MHz, MCS5, 90pc dc)	WLAN	8.77	± 9.6 %
10613	AAC	IEEE 802.11ac WiFi (20MHz, MCS6, 90pc dc)	WLAN	8.94	± 9.6 %
10614	AAC	IEEE 802.11ac WiFi (20MHz, MCS7, 90pc dc)	WLAN	8.59	± 9.6 %
10615	AAC	IEEE 802.11ac WiFi (20MHz, MCS8, 90pc dc)	WLAN	8.82	± 9.6 %
10616	AAC	IEEE 802.11ac WiFi (40MHz, MCS0, 90pc dc)	WLAN	8.82	± 9.6 %
10617	AAC	IEEE 802.11ac WiFi (40MHz, MCS1, 90pc dc)	WLAN	8.81	± 9.6 %
10618	AAC	IEEE 802.11ac WiFi (40MHz, MCS2, 90pc dc)	WLAN	8.58	± 9.6 %
10619	AAC	IEEE 802.11ac WiFi (40MHz, MCS3, 90pc dc)	WLAN	8.86	± 9.6 %
10620	AAC	IEEE 802.11ac WiFi (40MHz, MCS4, 90pc dc)	WLAN	8.87	± 9.6 %
10621	AAC	IEEE 802.11ac WiFi (40MHz, MCS5, 90pc dc)	WLAN	8.77	± 9.6 %
10622	AAC	IEEE 802.11ac WiFi (40MHz, MCS6, 90pc dc)	WLAN	8.68	± 9.6 %
10623	AAC	IEEE 802.11ac WiFi (40MHz, MCS7, 90pc dc)	WLAN	8.82	± 9.6 %
10624	AAC	IEEE 802.11ac WiFi (40MHz, MCS8, 90pc dc)	WLAN	8.96	± 9.6 %
10625	AAC	IEEE 802.11ac WiFi (40MHz, MCS9, 90pc dc)	WLAN	8.96	± 9.6 %
10626	AAC	IEEE 802.11ac WiFi (80MHz, MCS0, 90pc dc)	WLAN	8.83	± 9.6 %
10627	AAC	IEEE 802.11ac WiFi (80MHz, MCS1, 90pc dc)	WLAN	8.88	± 9.6 %
10628	AAC	IEEE 802.11ac WiFi (80MHz, MCS2, 90pc dc)	WLAN	8.71	± 9.6 %
10629	AAC	IEEE 802.11ac WiFi (80MHz, MCS3, 90pc dc)	WLAN	8.85	± 9.6 %
10630	AAC	IEEE 802.11ac WiFi (80MHz, MCS4, 90pc dc)	WLAN	8.72	± 9.6 %
10631	AAC	IEEE 802.11ac WiFi (80MHz, MCS5, 90pc dc)	WLAN	8.81	± 9.6 %
10632	AAC	IEEE 802.11ac WiFi (80MHz, MCS6, 90pc dc)	WLAN	8.74	± 9.6 %
10633	AAC	IEEE 802.11ac WiFi (80MHz, MCS7, 90pc dc)	WLAN	8.83	± 9.6 %
10634	AAC	IEEE 802.11ac WiFi (80MHz, MCS8, 90pc dc)	WLAN	8.80	± 9.6 %
10635	AAC	IEEE 802.11ac WiFi (80MHz, MCS9, 90pc dc)	WLAN	8.81	± 9.6 %
10636	AAD	IEEE 802.11ac WiFi (160MHz, MCS0, 90pc dc)	WLAN	8.83	± 9.6 %
10637	AAD	IEEE 802.11ac WiFi (160MHz, MCS1, 90pc dc)	WLAN	8.79	± 9.6 %
10638	AAD	IEEE 802.11ac WiFi (160MHz, MCS2, 90pc dc)	WLAN	8.86	± 9.6 %
10639	AAD	IEEE 802.11ac WiFi (160MHz, MCS3, 90pc dc)	WLAN	8.85	± 9.6 %
10640	AAD	IEEE 802.11ac WiFi (160MHz, MCS4, 90pc dc)	WLAN	8.98	± 9.6 %
10641	AAD	IEEE 802.11ac WiFi (160MHz, MCS5, 90pc dc)	WLAN	9.06	± 9.6 %
10642	AAD	IEEE 802.11ac WiFi (160MHz, MCS6, 90pc dc)	WLAN	9.06	± 9.6 %
10643	AAD	IEEE 802.11ac WiFi (160MHz, MCS7, 90pc dc)	WLAN	8.89	± 9.6 %
10644	AAD	IEEE 802.11ac WiFi (160MHz, MCS8, 90pc dc)	WLAN	9.05	± 9.6 %
10645	AAD	IEEE 802.11ac WiFi (160MHz, MCS9, 90pc dc)	WLAN	9.11	± 9.6 %
10646	AAG	LTE-TDD (SC-FDMA, 1 RB, 5 MHz, QPSK, UL Sub=2,7)	LTE-TDD	11.96	± 9.6 %
10647	AAF	LTE-TDD (SC-FDMA, 1 RB, 20 MHz, QPSK, UL Sub=2,7)	LTE-TDD	11.96	± 9.6 %
10648	AAA	CDMA2000 (1x Advanced)	CDMA2000	3.45	± 9.6 %
10652	AAE	LTE-TDD (OFDMA, 5 MHz, E-TM 3.1, Clipping 44%)	LTE-TDD	6.91	± 9.6 %
10653	AAE	LTE-TDD (OFDMA, 10 MHz, E-TM 3.1, Clipping 44%)	LTE-TDD	7.42	± 9.6 %
10654	AAD	LTE-TDD (OFDMA, 15 MHz, E-TM 3.1, Clipping 44%)	LTE-TDD	6.96	± 9.6 %
10655	AAE	LTE-TDD (OFDMA, 20 MHz, E-TM 3.1, Clipping 44%)	LTE-TDD	7.21	± 9.6 %
10658	AAA	Pulse Waveform (200Hz, 10%)	Test	10.00	± 9.6 %
10659	AAA	Pulse Waveform (200Hz, 20%)	Test	6.99	± 9.6 %
10660	AAA	Pulse Waveform (200Hz, 40%)	Test	3.98	± 9.6 %
10661	AAA	Pulse Waveform (200Hz, 60%)	Test	2.22	± 9.6 %
10662	AAA	Pulse Waveform (200Hz, 80%)	Test	0.97	± 9.6 %
10670	AAA	Bluetooth Low Energy	Bluetooth	2.19	± 9.6 %
10671	AAC	IEEE 802.11ax (20MHz, MCS0, 90pc dc)	WLAN	9.09	± 9.6 %
10672	AAC	IEEE 802.11ax (20MHz, MCS1, 90pc dc)	WLAN	8.57	± 9.6 %

10673	AAC	IEEE 802.11ax (20MHz, MCS2, 90pc dc)	WLAN	8.78	± 9.6 %
10674	AAC	IEEE 802.11ax (20MHz, MCS3, 90pc dc)	WLAN	8.74	± 9.6 %
10675	AAC	IEEE 802.11ax (20MHz, MCS4, 90pc dc)	WLAN	8.90	± 9.6 %
10676	AAC	IEEE 802.11ax (20MHz, MCS5, 90pc dc)	WLAN	8.77	± 9.6 %
10677	AAC	IEEE 802.11ax (20MHz, MCS6, 90pc dc)	WLAN	8.73	± 9.6 %
10678	AAC	IEEE 802.11ax (20MHz, MCS7, 90pc dc)	WLAN	8.78	± 9.6 %
10679	AAC	IEEE 802.11ax (20MHz, MCS8, 90pc dc)	WLAN	8.89	± 9.6 %
10680	AAC	IEEE 802.11ax (20MHz, MCS9, 90pc dc)	WLAN	8.80	± 9.6 %
10681	AAC	IEEE 802.11ax (20MHz, MCS10, 90pc dc)	WLAN	8.62	± 9.6 %
10682	AAC	IEEE 802.11ax (20MHz, MCS11, 90pc dc)	WLAN	8.83	± 9.6 %
10683	AAC	IEEE 802.11ax (20MHz, MCS0, 99pc dc)	WLAN	8.42	± 9.6 %
10684	AAC	IEEE 802.11ax (20MHz, MCS1, 99pc dc)	WLAN	8.26	± 9.6 %
10685	AAC	IEEE 802.11ax (20MHz, MCS2, 99pc dc)	WLAN	8.33	± 9.6 %
10686	AAC	IEEE 802.11ax (20MHz, MCS3, 99pc dc)	WLAN	8.28	± 9.6 %
10687	AAC	IEEE 802.11ax (20MHz, MCS4, 99pc dc)	WLAN	8.45	± 9.6 %
10688	AAC	IEEE 802.11ax (20MHz, MCS5, 99pc dc)	WLAN	8.29	± 9.6 %
10689	AAC	IEEE 802.11ax (20MHz, MCS6, 99pc dc)	WLAN	8.55	± 9.6 %
10690	AAC	IEEE 802.11ax (20MHz, MCS7, 99pc dc)	WLAN	8.29	± 9.6 %
10691	AAC	IEEE 802.11ax (20MHz, MCS8, 99pc dc)	WLAN	8.25	± 9.6 %
10692	AAC	IEEE 802.11ax (20MHz, MCS9, 99pc dc)	WLAN	8.29	± 9.6 %
10693	AAC	IEEE 802.11ax (20MHz, MCS10, 99pc dc)	WLAN	8.25	± 9.6 %
10694	AAC	IEEE 802.11ax (20MHz, MCS11, 99pc dc)	WLAN	8.57	± 9.6 %
10695	AAC	IEEE 802.11ax (40MHz, MCS0, 90pc dc)	WLAN	8.78	± 9.6 %
10696	AAC	IEEE 802.11ax (40MHz, MCS1, 90pc dc)	WLAN	8.91	± 9.6 %
10697	AAC	IEEE 802.11ax (40MHz, MCS2, 90pc dc)	WLAN	8.61	± 9.6 %
10698	AAC	IEEE 802.11ax (40MHz, MCS3, 90pc dc)	WLAN	8.89	± 9.6 %
10699	AAC	IEEE 802.11ax (40MHz, MCS4, 90pc dc)	WLAN	8.82	± 9.6 %
10700	AAC	IEEE 802.11ax (40MHz, MCS5, 90pc dc)	WLAN	8.73	± 9.6 %
10701	AAC	IEEE 802.11ax (40MHz, MCS6, 90pc dc)	WLAN	8.86	± 9.6 %
10702	AAC	IEEE 802.11ax (40MHz, MCS7, 90pc dc)	WLAN	8.70	± 9.6 %
10703	AAC	IEEE 802.11ax (40MHz, MCS8, 90pc dc)	WLAN	8.82	± 9.6 %
10704	AAC	IEEE 802.11ax (40MHz, MCS9, 90pc dc)	WLAN	8.56	± 9.6 %
10705	AAC	IEEE 802.11ax (40MHz, MCS10, 90pc dc)	WLAN	8.69	± 9.6 %
10706	AAC	IEEE 802.11ax (40MHz, MCS11, 90pc dc)	WLAN	8.66	± 9.6 %
10707	AAC	IEEE 802.11ax (40MHz, MCS0, 99pc dc)	WLAN	8.32	± 9.6 %
10708	AAC	IEEE 802.11ax (40MHz, MCS1, 99pc dc)	WLAN	8.55	± 9.6 %
10709	AAC	IEEE 802.11ax (40MHz, MCS2, 99pc dc)	WLAN	8.33	± 9.6 %
10710	AAC	IEEE 802.11ax (40MHz, MCS3, 99pc dc)	WLAN	8.29	± 9.6 %
10711	AAC	IEEE 802.11ax (40MHz, MCS4, 99pc dc)	WLAN	8.39	± 9.6 %
10712	AAC	IEEE 802.11ax (40MHz, MCS5, 99pc dc)	WLAN	8.67	± 9.6 %
10713	AAC	IEEE 802.11ax (40MHz, MCS6, 99pc dc)	WLAN	8.33	± 9.6 %
10714	AAC	IEEE 802.11ax (40MHz, MCS7, 99pc dc)	WLAN	8.26	± 9.6 %
10715	AAC	IEEE 802.11ax (40MHz, MCS8, 99pc dc)	WLAN	8.45	± 9.6 %
10716	AAC	IEEE 802.11ax (40MHz, MCS9, 99pc dc)	WLAN	8.30	± 9.6 %
10717	AAC	IEEE 802.11ax (40MHz, MCS10, 99pc dc)	WLAN	8.48	± 9.6 %
10718	AAC	IEEE 802.11ax (40MHz, MCS11, 99pc dc)	WLAN	8.24	± 9.6 %
10719	AAC	IEEE 802.11ax (80MHz, MCS0, 90pc dc)	WLAN	8.81	± 9.6 %
10720	AAC	IEEE 802.11ax (80MHz, MCS1, 90pc dc)	WLAN	8.87	± 9.6 %
10721	AAC	IEEE 802.11ax (80MHz, MCS2, 90pc dc)	WLAN	8.76	± 9.6 %
10722	AAC	IEEE 802.11ax (80MHz, MCS3, 90pc dc)	WLAN	8.55	± 9.6 %
10723	AAC	IEEE 802.11ax (80MHz, MCS4, 90pc dc)	WLAN	8.70	± 9.6 %
10724	AAC	IEEE 802.11ax (80MHz, MCS5, 90pc dc)	WLAN	8.90	± 9.6 %
10725	AAC	IEEE 802.11ax (80MHz, MCS6, 90pc dc)	WLAN	8.74	± 9.6 %
10726	AAC	IEEE 802.11ax (80MHz, MCS7, 90pc dc)	WLAN	8.72	± 9.6 %
10727	AAC	IEEE 802.11ax (80MHz, MCS8, 90pc dc)	WLAN	8.66	± 9.6 %
10728	AAC	IEEE 802.11ax (80MHz, MCS9, 90pc dc)	WLAN	8.65	± 9.6 %

10729	AAC	IEEE 802.11ax (80MHz, MCS10, 90pc dc)	WLAN	8.64	± 9.6 %
10730	AAC	IEEE 802.11ax (80MHz, MCS11, 90pc dc)	WLAN	8.67	± 9.6 %
10731	AAC	IEEE 802.11ax (80MHz, MCS0, 99pc dc)	WLAN	8.42	± 9.6 %
10732	AAC	IEEE 802.11ax (80MHz, MCS1, 99pc dc)	WLAN	8.46	± 9.6 %
10733	AAC	IEEE 802.11ax (80MHz, MCS2, 99pc dc)	WLAN	8.40	± 9.6 %
10734	AAC	IEEE 802.11ax (80MHz, MCS3, 99pc dc)	WLAN	8.25	± 9.6 %
10735	AAC	IEEE 802.11ax (80MHz, MCS4, 99pc dc)	WLAN	8.33	± 9.6 %
10736	AAC	IEEE 802.11ax (80MHz, MCS5, 99pc dc)	WLAN	8.27	± 9.6 %
10737	AAC	IEEE 802.11ax (80MHz, MCS6, 99pc dc)	WLAN	8.36	± 9.6 %
10738	AAC	IEEE 802.11ax (80MHz, MCS7, 99pc dc)	WLAN	8.42	± 9.6 %
10739	AAC	IEEE 802.11ax (80MHz, MCS8, 99pc dc)	WLAN	8.29	± 9.6 %
10740	AAC	IEEE 802.11ax (80MHz, MCS9, 99pc dc)	WLAN	8.48	± 9.6 %
10741	AAC	IEEE 802.11ax (80MHz, MCS10, 99pc dc)	WLAN	8.40	± 9.6 %
10742	AAC	IEEE 802.11ax (80MHz, MCS11, 99pc dc)	WLAN	8.43	± 9.6 %
10743	AAC	IEEE 802.11ax (160MHz, MCS0, 90pc dc)	WLAN	8.94	± 9.6 %
10744	AAC	IEEE 802.11ax (160MHz, MCS1, 90pc dc)	WLAN	9.16	± 9.6 %
10745	AAC	IEEE 802.11ax (160MHz, MCS2, 90pc dc)	WLAN	8.93	± 9.6 %
10746	AAC	IEEE 802.11ax (160MHz, MCS3, 90pc dc)	WLAN	9.11	± 9.6 %
10747	AAC	IEEE 802.11ax (160MHz, MCS4, 90pc dc)	WLAN	9.04	± 9.6 %
10748	AAC	IEEE 802.11ax (160MHz, MCS5, 90pc dc)	WLAN	8.93	± 9.6 %
10749	AAC	IEEE 802.11ax (160MHz, MCS6, 90pc dc)	WLAN	8.90	± 9.6 %
10750	AAC	IEEE 802.11ax (160MHz, MCS7, 90pc dc)	WLAN	8.79	± 9.6 %
10751	AAC	IEEE 802.11ax (160MHz, MCS8, 90pc dc)	WLAN	8.82	± 9.6 %
10752	AAC	IEEE 802.11ax (160MHz, MCS9, 90pc dc)	WLAN	8.81	± 9.6 %
10753	AAC	IEEE 802.11ax (160MHz, MCS10, 90pc dc)	WLAN	9.00	± 9.6 %
10754	AAC	IEEE 802.11ax (160MHz, MCS11, 90pc dc)	WLAN	8.94	± 9.6 %
10755	AAC	IEEE 802.11ax (160MHz, MCS0, 99pc dc)	WLAN	8.64	± 9.6 %
10756	AAC	IEEE 802.11ax (160MHz, MCS1, 99pc dc)	WLAN	8.77	± 9.6 %
10757	AAC	IEEE 802.11ax (160MHz, MCS2, 99pc dc)	WLAN	8.77	± 9.6 %
10758	AAC	IEEE 802.11ax (160MHz, MCS3, 99pc dc)	WLAN	8.69	± 9.6 %
10759	AAC	IEEE 802.11ax (160MHz, MCS4, 99pc dc)	WLAN	8.58	± 9.6 %
10760	AAC	IEEE 802.11ax (160MHz, MCS5, 99pc dc)	WLAN	8.49	± 9.6 %
10761	AAC	IEEE 802.11ax (160MHz, MCS6, 99pc dc)	WLAN	8.58	± 9.6 %
10762	AAC	IEEE 802.11ax (160MHz, MCS7, 99pc dc)	WLAN	8.49	± 9.6 %
10763	AAC	IEEE 802.11ax (160MHz, MCS8, 99pc dc)	WLAN	8.53	± 9.6 %
10764	AAC	IEEE 802.11ax (160MHz, MCS9, 99pc dc)	WLAN	8.54	± 9.6 %
10765	AAC	IEEE 802.11ax (160MHz, MCS10, 99pc dc)	WLAN	8.54	± 9.6 %
10766	AAC	IEEE 802.11ax (160MHz, MCS11, 99pc dc)	WLAN	8.51	± 9.6 %
10767	AAE	5G NR (CP-OFDM, 1 RB, 5 MHz, QPSK, 15 kHz)	5G NR FR1 TDD	7.99	± 9.6 %
10768	AAD	5G NR (CP-OFDM, 1 RB, 10 MHz, QPSK, 15 kHz)	5G NR FR1 TDD	8.01	± 9.6 %
10769	AAD	5G NR (CP-OFDM, 1 RB, 15 MHz, QPSK, 15 kHz)	5G NR FR1 TDD	8.01	± 9.6 %
10770	AAD	5G NR (CP-OFDM, 1 RB, 20 MHz, QPSK, 15 kHz)	5G NR FR1 TDD	8.02	± 9.6 %
10771	AAD	5G NR (CP-OFDM, 1 RB, 25 MHz, QPSK, 15 kHz)	5G NR FR1 TDD	8.02	± 9.6 %
10772	AAD	5G NR (CP-OFDM, 1 RB, 30 MHz, QPSK, 15 kHz)	5G NR FR1 TDD	8.23	± 9.6 %
10773	AAD	5G NR (CP-OFDM, 1 RB, 40 MHz, QPSK, 15 kHz)	5G NR FR1 TDD	8.03	± 9.6 %
10774	AAD	5G NR (CP-OFDM, 1 RB, 50 MHz, QPSK, 15 kHz)	5G NR FR1 TDD	8.02	± 9.6 %
10775	AAD	5G NR (CP-OFDM, 50% RB, 5 MHz, QPSK, 15 kHz)	5G NR FR1 TDD	8.31	± 9.6 %
10776	AAD	5G NR (CP-OFDM, 50% RB, 10 MHz, QPSK, 15 kHz)	5G NR FR1 TDD	8.30	± 9.6 %
10777	AAC	5G NR (CP-OFDM, 50% RB, 15 MHz, QPSK, 15 kHz)	5G NR FR1 TDD	8.30	± 9.6 %
10778	AAD	5G NR (CP-OFDM, 50% RB, 20 MHz, QPSK, 15 kHz)	5G NR FR1 TDD	8.34	± 9.6 %
10779	AAC	5G NR (CP-OFDM, 50% RB, 25 MHz, QPSK, 15 kHz)	5G NR FR1 TDD	8.42	± 9.6 %
10780	AAD	5G NR (CP-OFDM, 50% RB, 30 MHz, QPSK, 15 kHz)	5G NR FR1 TDD	8.38	± 9.6 %
10781	AAD	5G NR (CP-OFDM, 50% RB, 40 MHz, QPSK, 15 kHz)	5G NR FR1 TDD	8.38	± 9.6 %
10782	AAD	5G NR (CP-OFDM, 50% RB, 50 MHz, QPSK, 15 kHz)	5G NR FR1 TDD	8.43	± 9.6 %
10783	AAE	5G NR (CP-OFDM, 100% RB, 5 MHz, QPSK, 15 kHz)	5G NR FR1 TDD	8.31	± 9.6 %
10784	AAD	5G NR (CP-OFDM, 100% RB, 10 MHz, QPSK, 15 kHz)	5G NR FR1 TDD	8.29	± 9.6 %

10785	AAD	5G NR (CP-OFDM, 100% RB, 15 MHz, QPSK, 15 kHz)	5G NR FR1 TDD	8.40	± 9.6 %
10786	AAD	5G NR (CP-OFDM, 100% RB, 20 MHz, QPSK, 15 kHz)	5G NR FR1 TDD	8.35	± 9.6 %
10787	AAD	5G NR (CP-OFDM, 100% RB, 25 MHz, QPSK, 15 kHz)	5G NR FR1 TDD	8.44	± 9.6 %
10788	AAD	5G NR (CP-OFDM, 100% RB, 30 MHz, QPSK, 15 kHz)	5G NR FR1 TDD	8.39	± 9.6 %
10789	AAD	5G NR (CP-OFDM, 100% RB, 40 MHz, QPSK, 15 kHz)	5G NR FR1 TDD	8.37	± 9.6 %
10790	AAD	5G NR (CP-OFDM, 100% RB, 50 MHz, QPSK, 15 kHz)	5G NR FR1 TDD	8.39	± 9.6 %
10791	AAE	5G NR (CP-OFDM, 1 RB, 5 MHz, QPSK, 30 kHz)	5G NR FR1 TDD	7.83	± 9.6 %
10792	AAD	5G NR (CP-OFDM, 1 RB, 10 MHz, QPSK, 30 kHz)	5G NR FR1 TDD	7.92	± 9.6 %
10793	AAD	5G NR (CP-OFDM, 1 RB, 15 MHz, QPSK, 30 kHz)	5G NR FR1 TDD	7.95	± 9.6 %
10794	AAD	5G NR (CP-OFDM, 1 RB, 20 MHz, QPSK, 30 kHz)	5G NR FR1 TDD	7.82	± 9.6 %
10795	AAD	5G NR (CP-OFDM, 1 RB, 25 MHz, QPSK, 30 kHz)	5G NR FR1 TDD	7.84	± 9.6 %
10796	AAD	5G NR (CP-OFDM, 1 RB, 30 MHz, QPSK, 30 kHz)	5G NR FR1 TDD	7.82	± 9.6 %
10797	AAD	5G NR (CP-OFDM, 1 RB, 40 MHz, QPSK, 30 kHz)	5G NR FR1 TDD	8.01	± 9.6 %
10798	AAD	5G NR (CP-OFDM, 1 RB, 50 MHz, QPSK, 30 kHz)	5G NR FR1 TDD	7.89	± 9.6 %
10799	AAD	5G NR (CP-OFDM, 1 RB, 60 MHz, QPSK, 30 kHz)	5G NR FR1 TDD	7.93	± 9.6 %
10801	AAD	5G NR (CP-OFDM, 1 RB, 80 MHz, QPSK, 30 kHz)	5G NR FR1 TDD	7.89	± 9.6 %
10802	AAD	5G NR (CP-OFDM, 1 RB, 90 MHz, QPSK, 30 kHz)	5G NR FR1 TDD	7.87	± 9.6 %
10803	AAD	5G NR (CP-OFDM, 1 RB, 100 MHz, QPSK, 30 kHz)	5G NR FR1 TDD	7.93	± 9.6 %
10805	AAD	5G NR (CP-OFDM, 50% RB, 10 MHz, QPSK, 30 kHz)	5G NR FR1 TDD	8.34	± 9.6 %
10806	AAD	5G NR (CP-OFDM, 50% RB, 15 MHz, QPSK, 30 kHz)	5G NR FR1 TDD	8.37	± 9.6 %
10809	AAD	5G NR (CP-OFDM, 50% RB, 30 MHz, QPSK, 30 kHz)	5G NR FR1 TDD	8.34	± 9.6 %
10810	AAD	5G NR (CP-OFDM, 50% RB, 40 MHz, QPSK, 30 kHz)	5G NR FR1 TDD	8.34	± 9.6 %
10812	AAD	5G NR (CP-OFDM, 50% RB, 60 MHz, QPSK, 30 kHz)	5G NR FR1 TDD	8.35	± 9.6 %
10817	AAE	5G NR (CP-OFDM, 100% RB, 5 MHz, QPSK, 30 kHz)	5G NR FR1 TDD	8.35	± 9.6 %
10818	AAD	5G NR (CP-OFDM, 100% RB, 10 MHz, QPSK, 30 kHz)	5G NR FR1 TDD	8.34	± 9.6 %
10819	AAD	5G NR (CP-OFDM, 100% RB, 15 MHz, QPSK, 30 kHz)	5G NR FR1 TDD	8.33	± 9.6 %
10820	AAD	5G NR (CP-OFDM, 100% RB, 20 MHz, QPSK, 30 kHz)	5G NR FR1 TDD	8.30	± 9.6 %
10821	AAD	5G NR (CP-OFDM, 100% RB, 25 MHz, QPSK, 30 kHz)	5G NR FR1 TDD	8.41	± 9.6 %
10822	AAD	5G NR (CP-OFDM, 100% RB, 30 MHz, QPSK, 30 kHz)	5G NR FR1 TDD	8.41	± 9.6 %
10823	AAD	5G NR (CP-OFDM, 100% RB, 40 MHz, QPSK, 30 kHz)	5G NR FR1 TDD	8.36	± 9.6 %
10824	AAD	5G NR (CP-OFDM, 100% RB, 50 MHz, QPSK, 30 kHz)	5G NR FR1 TDD	8.39	± 9.6 %
10825	AAD	5G NR (CP-OFDM, 100% RB, 60 MHz, QPSK, 30 kHz)	5G NR FR1 TDD	8.41	± 9.6 %
10827	AAD	5G NR (CP-OFDM, 100% RB, 80 MHz, QPSK, 30 kHz)	5G NR FR1 TDD	8.42	± 9.6 %
10828	AAD	5G NR (CP-OFDM, 100% RB, 90 MHz, QPSK, 30 kHz)	5G NR FR1 TDD	8.43	± 9.6 %
10829	AAD	5G NR (CP-OFDM, 100% RB, 100 MHz, QPSK, 30 kHz)	5G NR FR1 TDD	8.40	± 9.6 %
10830	AAD	5G NR (CP-OFDM, 1 RB, 10 MHz, QPSK, 60 kHz)	5G NR FR1 TDD	7.63	± 9.6 %
10831	AAD	5G NR (CP-OFDM, 1 RB, 15 MHz, QPSK, 60 kHz)	5G NR FR1 TDD	7.73	± 9.6 %
10832	AAD	5G NR (CP-OFDM, 1 RB, 20 MHz, QPSK, 60 kHz)	5G NR FR1 TDD	7.74	± 9.6 %
10833	AAD	5G NR (CP-OFDM, 1 RB, 25 MHz, QPSK, 60 kHz)	5G NR FR1 TDD	7.70	± 9.6 %
10834	AAD	5G NR (CP-OFDM, 1 RB, 30 MHz, QPSK, 60 kHz)	5G NR FR1 TDD	7.75	± 9.6 %
10835	AAD	5G NR (CP-OFDM, 1 RB, 40 MHz, QPSK, 60 kHz)	5G NR FR1 TDD	7.70	± 9.6 %
10836	AAD	5G NR (CP-OFDM, 1 RB, 50 MHz, QPSK, 60 kHz)	5G NR FR1 TDD	7.66	± 9.6 %
10837	AAD	5G NR (CP-OFDM, 1 RB, 60 MHz, QPSK, 60 kHz)	5G NR FR1 TDD	7.68	± 9.6 %
10839	AAD	5G NR (CP-OFDM, 1 RB, 80 MHz, QPSK, 60 kHz)	5G NR FR1 TDD	7.70	± 9.6 %
10840	AAD	5G NR (CP-OFDM, 1 RB, 90 MHz, QPSK, 60 kHz)	5G NR FR1 TDD	7.67	± 9.6 %
10841	AAD	5G NR (CP-OFDM, 1 RB, 100 MHz, QPSK, 60 kHz)	5G NR FR1 TDD	7.71	± 9.6 %
10843	AAD	5G NR (CP-OFDM, 50% RB, 15 MHz, QPSK, 60 kHz)	5G NR FR1 TDD	8.49	± 9.6 %
10844	AAD	5G NR (CP-OFDM, 50% RB, 20 MHz, QPSK, 60 kHz)	5G NR FR1 TDD	8.34	± 9.6 %
10846	AAD	5G NR (CP-OFDM, 50% RB, 30 MHz, QPSK, 60 kHz)	5G NR FR1 TDD	8.41	± 9.6 %
10854	AAD	5G NR (CP-OFDM, 100% RB, 10 MHz, QPSK, 60 kHz)	5G NR FR1 TDD	8.34	± 9.6 %
10855	AAD	5G NR (CP-OFDM, 100% RB, 15 MHz, QPSK, 60 kHz)	5G NR FR1 TDD	8.36	± 9.6 %
10856	AAD	5G NR (CP-OFDM, 100% RB, 20 MHz, QPSK, 60 kHz)	5G NR FR1 TDD	8.37	± 9.6 %
10857	AAD	5G NR (CP-OFDM, 100% RB, 25 MHz, QPSK, 60 kHz)	5G NR FR1 TDD	8.35	± 9.6 %
10858	AAD	5G NR (CP-OFDM, 100% RB, 30 MHz, QPSK, 60 kHz)	5G NR FR1 TDD	8.36	± 9.6 %
10859	AAD	5G NR (CP-OFDM, 100% RB, 40 MHz, QPSK, 60 kHz)	5G NR FR1 TDD	8.34	± 9.6 %
10860	AAD	5G NR (CP-OFDM, 100% RB, 50 MHz, QPSK, 60 kHz)	5G NR FR1 TDD	8.41	± 9.6 %

10861	AAD	5G NR (CP-OFDM, 100% RB, 60 MHz, QPSK, 60 kHz)	5G NR FR1 TDD	8.40	± 9.6 %
10863	AAD	5G NR (CP-OFDM, 100% RB, 80 MHz, QPSK, 60 kHz)	5G NR FR1 TDD	8.41	± 9.6 %
10864	AAD	5G NR (CP-OFDM, 100% RB, 90 MHz, QPSK, 60 kHz)	5G NR FR1 TDD	8.37	± 9.6 %
10865	AAD	5G NR (CP-OFDM, 100% RB, 100 MHz, QPSK, 60 kHz)	5G NR FR1 TDD	8.41	± 9.6 %
10866	AAD	5G NR (DFT-s-OFDM, 1 RB, 100 MHz, QPSK, 30 kHz)	5G NR FR1 TDD	5.68	± 9.6 %
10868	AAD	5G NR (DFT-s-OFDM, 100% RB, 100 MHz, QPSK, 30 kHz)	5G NR FR1 TDD	5.89	± 9.6 %
10869	AAD	5G NR (DFT-s-OFDM, 1 RB, 100 MHz, QPSK, 120 kHz)	5G NR FR2 TDD	5.75	± 9.6 %
10870	AAD	5G NR (DFT-s-OFDM, 100% RB, 100 MHz, QPSK, 120 kHz)	5G NR FR2 TDD	5.86	± 9.6 %
10871	AAD	5G NR (DFT-s-OFDM, 1 RB, 100 MHz, 16QAM, 120 kHz)	5G NR FR2 TDD	5.75	± 9.6 %
10872	AAD	5G NR (DFT-s-OFDM, 100% RB, 100 MHz, 16QAM, 120 kHz)	5G NR FR2 TDD	6.52	± 9.6 %
10873	AAD	5G NR (DFT-s-OFDM, 1 RB, 100 MHz, 64QAM, 120 kHz)	5G NR FR2 TDD	6.61	± 9.6 %
10874	AAD	5G NR (DFT-s-OFDM, 100% RB, 100 MHz, 64QAM, 120 kHz)	5G NR FR2 TDD	6.65	± 9.6 %
10875	AAD	5G NR (CP-OFDM, 1 RB, 100 MHz, QPSK, 120 kHz)	5G NR FR2 TDD	7.78	± 9.6 %
10876	AAD	5G NR (CP-OFDM, 100% RB, 100 MHz, QPSK, 120 kHz)	5G NR FR2 TDD	8.39	± 9.6 %
10877	AAD	5G NR (CP-OFDM, 1 RB, 100 MHz, 16QAM, 120 kHz)	5G NR FR2 TDD	7.95	± 9.6 %
10878	AAD	5G NR (CP-OFDM, 100% RB, 100 MHz, 16QAM, 120 kHz)	5G NR FR2 TDD	8.41	± 9.6 %
10879	AAD	5G NR (CP-OFDM, 1 RB, 100 MHz, 64QAM, 120 kHz)	5G NR FR2 TDD	8.12	± 9.6 %
10880	AAD	5G NR (CP-OFDM, 100% RB, 100 MHz, 64QAM, 120 kHz)	5G NR FR2 TDD	8.38	± 9.6 %
10881	AAD	5G NR (DFT-s-OFDM, 1 RB, 50 MHz, QPSK, 120 kHz)	5G NR FR2 TDD	5.75	± 9.6 %
10882	AAD	5G NR (DFT-s-OFDM, 100% RB, 50 MHz, QPSK, 120 kHz)	5G NR FR2 TDD	5.96	± 9.6 %
10883	AAD	5G NR (DFT-s-OFDM, 1 RB, 50 MHz, 16QAM, 120 kHz)	5G NR FR2 TDD	6.57	± 9.6 %
10884	AAD	5G NR (DFT-s-OFDM, 100% RB, 50 MHz, 16QAM, 120 kHz)	5G NR FR2 TDD	6.53	± 9.6 %
10885	AAD	5G NR (DFT-s-OFDM, 1 RB, 50 MHz, 64QAM, 120 kHz)	5G NR FR2 TDD	6.61	± 9.6 %
10886	AAD	5G NR (DFT-s-OFDM, 100% RB, 50 MHz, 64QAM, 120 kHz)	5G NR FR2 TDD	6.65	± 9.6 %
10887	AAD	5G NR (CP-OFDM, 1 RB, 50 MHz, QPSK, 120 kHz)	5G NR FR2 TDD	7.78	± 9.6 %
10888	AAD	5G NR (CP-OFDM, 100% RB, 50 MHz, QPSK, 120 kHz)	5G NR FR2 TDD	8.35	± 9.6 %
10889	AAD	5G NR (CP-OFDM, 1 RB, 50 MHz, 16QAM, 120 kHz)	5G NR FR2 TDD	8.02	± 9.6 %
10890	AAD	5G NR (CP-OFDM, 100% RB, 50 MHz, 16QAM, 120 kHz)	5G NR FR2 TDD	8.40	± 9.6 %
10891	AAD	5G NR (CP-OFDM, 1 RB, 50 MHz, 64QAM, 120 kHz)	5G NR FR2 TDD	8.13	± 9.6 %
10892	AAD	5G NR (CP-OFDM, 100% RB, 50 MHz, 64QAM, 120 kHz)	5G NR FR2 TDD	8.41	± 9.6 %
10897	AAC	5G NR (DFT-s-OFDM, 1 RB, 5 MHz, QPSK, 30 kHz)	5G NR FR1 TDD	5.66	± 9.6 %
10898	AAB	5G NR (DFT-s-OFDM, 1 RB, 10 MHz, QPSK, 30 kHz)	5G NR FR1 TDD	5.67	± 9.6 %
10899	AAB	5G NR (DFT-s-OFDM, 1 RB, 15 MHz, QPSK, 30 kHz)	5G NR FR1 TDD	5.67	± 9.6 %
10900	AAB	5G NR (DFT-s-OFDM, 1 RB, 20 MHz, QPSK, 30 kHz)	5G NR FR1 TDD	5.68	± 9.6 %
10901	AAB	5G NR (DFT-s-OFDM, 1 RB, 25 MHz, QPSK, 30 kHz)	5G NR FR1 TDD	5.68	± 9.6 %
10902	AAB	5G NR (DFT-s-OFDM, 1 RB, 30 MHz, QPSK, 30 kHz)	5G NR FR1 TDD	5.68	± 9.6 %
10903	AAB	5G NR (DFT-s-OFDM, 1 RB, 40 MHz, QPSK, 30 kHz)	5G NR FR1 TDD	5.68	± 9.6 %
10904	AAB	5G NR (DFT-s-OFDM, 1 RB, 50 MHz, QPSK, 30 kHz)	5G NR FR1 TDD	5.68	± 9.6 %
10905	AAB	5G NR (DFT-s-OFDM, 1 RB, 60 MHz, QPSK, 30 kHz)	5G NR FR1 TDD	5.68	± 9.6 %
10906	AAB	5G NR (DFT-s-OFDM, 1 RB, 80 MHz, QPSK, 30 kHz)	5G NR FR1 TDD	5.68	± 9.6 %
10907	AAC	5G NR (DFT-s-OFDM, 50% RB, 5 MHz, QPSK, 30 kHz)	5G NR FR1 TDD	5.78	± 9.6 %
10908	AAB	5G NR (DFT-s-OFDM, 50% RB, 10 MHz, QPSK, 30 kHz)	5G NR FR1 TDD	5.93	± 9.6 %
10909	AAB	5G NR (DFT-s-OFDM, 50% RB, 15 MHz, QPSK, 30 kHz)	5G NR FR1 TDD	5.96	± 9.6 %
10910	AAB	5G NR (DFT-s-OFDM, 50% RB, 20 MHz, QPSK, 30 kHz)	5G NR FR1 TDD	5.83	± 9.6 %
10911	AAB	5G NR (DFT-s-OFDM, 50% RB, 25 MHz, QPSK, 30 kHz)	5G NR FR1 TDD	5.93	± 9.6 %
10912	AAB	5G NR (DFT-s-OFDM, 50% RB, 30 MHz, QPSK, 30 kHz)	5G NR FR1 TDD	5.84	± 9.6 %
10913	AAB	5G NR (DFT-s-OFDM, 50% RB, 40 MHz, QPSK, 30 kHz)	5G NR FR1 TDD	5.84	± 9.6 %
10914	AAB	5G NR (DFT-s-OFDM, 50% RB, 50 MHz, QPSK, 30 kHz)	5G NR FR1 TDD	5.85	± 9.6 %
10915	AAB	5G NR (DFT-s-OFDM, 50% RB, 60 MHz, QPSK, 30 kHz)	5G NR FR1 TDD	5.83	± 9.6 %
10916	AAB	5G NR (DFT-s-OFDM, 50% RB, 80 MHz, QPSK, 30 kHz)	5G NR FR1 TDD	5.87	± 9.6 %
10917	AAB	5G NR (DFT-s-OFDM, 50% RB, 100 MHz, QPSK, 30 kHz)	5G NR FR1 TDD	5.94	± 9.6 %
10918	AAC	5G NR (DFT-s-OFDM, 100% RB, 5 MHz, QPSK, 30 kHz)	5G NR FR1 TDD	5.86	± 9.6 %
10919	AAB	5G NR (DFT-s-OFDM, 100% RB, 10 MHz, QPSK, 30 kHz)	5G NR FR1 TDD	5.86	± 9.6 %
10920	AAB	5G NR (DFT-s-OFDM, 100% RB, 15 MHz, QPSK, 30 kHz)	5G NR FR1 TDD	5.87	± 9.6 %
10921	AAB	5G NR (DFT-s-OFDM, 100% RB, 20 MHz, QPSK, 30 kHz)	5G NR FR1 TDD	5.84	± 9.6 %
10922	AAB	5G NR (DFT-s-OFDM, 100% RB, 25 MHz, QPSK, 30 kHz)	5G NR FR1 TDD	5.82	± 9.6 %

10923	AAB	5G NR (DFT-s-OFDM, 100% RB, 30 MHz, QPSK, 30 kHz)	5G NR FR1 TDD	5.84	± 9.6 %
10924	AAB	5G NR (DFT-s-OFDM, 100% RB, 40 MHz, QPSK, 30 kHz)	5G NR FR1 TDD	5.84	± 9.6 %
10925	AAB	5G NR (DFT-s-OFDM, 100% RB, 50 MHz, QPSK, 30 kHz)	5G NR FR1 TDD	5.95	± 9.6 %
10926	AAB	5G NR (DFT-s-OFDM, 100% RB, 60 MHz, QPSK, 30 kHz)	5G NR FR1 TDD	5.84	± 9.6 %
10927	AAB	5G NR (DFT-s-OFDM, 100% RB, 80 MHz, QPSK, 30 kHz)	5G NR FR1 TDD	5.94	± 9.6 %
10928	AAC	5G NR (DFT-s-OFDM, 1 RB, 5 MHz, QPSK, 15 kHz)	5G NR FR1 FDD	5.52	± 9.6 %
10929	AAC	5G NR (DFT-s-OFDM, 1 RB, 10 MHz, QPSK, 15 kHz)	5G NR FR1 FDD	5.52	± 9.6 %
10930	AAC	5G NR (DFT-s-OFDM, 1 RB, 15 MHz, QPSK, 15 kHz)	5G NR FR1 FDD	5.52	± 9.6 %
10931	AAC	5G NR (DFT-s-OFDM, 1 RB, 20 MHz, QPSK, 15 kHz)	5G NR FR1 FDD	5.51	± 9.6 %
10932	AAC	5G NR (DFT-s-OFDM, 1 RB, 25 MHz, QPSK, 15 kHz)	5G NR FR1 FDD	5.51	± 9.6 %
10933	AAC	5G NR (DFT-s-OFDM, 1 RB, 30 MHz, QPSK, 15 kHz)	5G NR FR1 FDD	5.51	± 9.6 %
10934	AAC	5G NR (DFT-s-OFDM, 1 RB, 40 MHz, QPSK, 15 kHz)	5G NR FR1 FDD	5.51	± 9.6 %
10935	AAD	5G NR (DFT-s-OFDM, 1 RB, 50 MHz, QPSK, 15 kHz)	5G NR FR1 FDD	5.51	± 9.6 %
10936	AAC	5G NR (DFT-s-OFDM, 50% RB, 5 MHz, QPSK, 15 kHz)	5G NR FR1 FDD	5.90	± 9.6 %
10937	AAC	5G NR (DFT-s-OFDM, 50% RB, 10 MHz, QPSK, 15 kHz)	5G NR FR1 FDD	5.77	± 9.6 %
10938	AAC	5G NR (DFT-s-OFDM, 50% RB, 15 MHz, QPSK, 15 kHz)	5G NR FR1 FDD	5.90	± 9.6 %
10939	AAC	5G NR (DFT-s-OFDM, 50% RB, 20 MHz, QPSK, 15 kHz)	5G NR FR1 FDD	5.82	± 9.6 %
10940	AAC	5G NR (DFT-s-OFDM, 50% RB, 25 MHz, QPSK, 15 kHz)	5G NR FR1 FDD	5.89	± 9.6 %
10941	AAC	5G NR (DFT-s-OFDM, 50% RB, 30 MHz, QPSK, 15 kHz)	5G NR FR1 FDD	5.83	± 9.6 %
10942	AAC	5G NR (DFT-s-OFDM, 50% RB, 40 MHz, QPSK, 15 kHz)	5G NR FR1 FDD	5.85	± 9.6 %
10943	AAD	5G NR (DFT-s-OFDM, 50% RB, 50 MHz, QPSK, 15 kHz)	5G NR FR1 FDD	5.95	± 9.6 %
10944	AAC	5G NR (DFT-s-OFDM, 100% RB, 5 MHz, QPSK, 15 kHz)	5G NR FR1 FDD	5.81	± 9.6 %
10945	AAC	5G NR (DFT-s-OFDM, 100% RB, 10 MHz, QPSK, 15 kHz)	5G NR FR1 FDD	5.85	± 9.6 %
10946	AAC	5G NR (DFT-s-OFDM, 100% RB, 15 MHz, QPSK, 15 kHz)	5G NR FR1 FDD	5.83	± 9.6 %
10947	AAC	5G NR (DFT-s-OFDM, 100% RB, 20 MHz, QPSK, 15 kHz)	5G NR FR1 FDD	5.87	± 9.6 %
10948	AAC	5G NR (DFT-s-OFDM, 100% RB, 25 MHz, QPSK, 15 kHz)	5G NR FR1 FDD	5.94	± 9.6 %
10949	AAC	5G NR (DFT-s-OFDM, 100% RB, 30 MHz, QPSK, 15 kHz)	5G NR FR1 FDD	5.87	± 9.6 %
10950	AAC	5G NR (DFT-s-OFDM, 100% RB, 40 MHz, QPSK, 15 kHz)	5G NR FR1 FDD	5.94	± 9.6 %
10951	AAD	5G NR (DFT-s-OFDM, 100% RB, 50 MHz, QPSK, 15 kHz)	5G NR FR1 FDD	5.92	± 9.6 %
10952	AAA	5G NR DL (CP-OFDM, TM 3.1, 5 MHz, 64-QAM, 15 kHz)	5G NR FR1 FDD	8.25	± 9.6 %
10953	AAA	5G NR DL (CP-OFDM, TM 3.1, 10 MHz, 64-QAM, 15 kHz)	5G NR FR1 FDD	8.15	± 9.6 %
10954	AAA	5G NR DL (CP-OFDM, TM 3.1, 15 MHz, 64-QAM, 15 kHz)	5G NR FR1 FDD	8.23	± 9.6 %
10955	AAA	5G NR DL (CP-OFDM, TM 3.1, 20 MHz, 64-QAM, 15 kHz)	5G NR FR1 FDD	8.42	± 9.6 %
10956	AAA	5G NR DL (CP-OFDM, TM 3.1, 5 MHz, 64-QAM, 30 kHz)	5G NR FR1 FDD	8.14	± 9.6 %
10957	AAA	5G NR DL (CP-OFDM, TM 3.1, 10 MHz, 64-QAM, 30 kHz)	5G NR FR1 FDD	8.31	± 9.6 %
10958	AAA	5G NR DL (CP-OFDM, TM 3.1, 15 MHz, 64-QAM, 30 kHz)	5G NR FR1 FDD	8.61	± 9.6 %
10959	AAA	5G NR DL (CP-OFDM, TM 3.1, 20 MHz, 64-QAM, 30 kHz)	5G NR FR1 FDD	8.33	± 9.6 %
10960	AAC	5G NR DL (CP-OFDM, TM 3.1, 5 MHz, 64-QAM, 15 kHz)	5G NR FR1 TDD	9.32	± 9.6 %
10961	AAB	5G NR DL (CP-OFDM, TM 3.1, 10 MHz, 64-QAM, 15 kHz)	5G NR FR1 TDD	9.36	± 9.6 %
10962	AAB	5G NR DL (CP-OFDM, TM 3.1, 15 MHz, 64-QAM, 15 kHz)	5G NR FR1 TDD	9.40	± 9.6 %
10963	AAB	5G NR DL (CP-OFDM, TM 3.1, 20 MHz, 64-QAM, 15 kHz)	5G NR FR1 TDD	9.55	± 9.6 %
10964	AAC	5G NR DL (CP-OFDM, TM 3.1, 5 MHz, 64-QAM, 30 kHz)	5G NR FR1 TDD	9.29	± 9.6 %
10965	AAB	5G NR DL (CP-OFDM, TM 3.1, 10 MHz, 64-QAM, 30 kHz)	5G NR FR1 TDD	9.37	± 9.6 %
10966	AAB	5G NR DL (CP-OFDM, TM 3.1, 15 MHz, 64-QAM, 30 kHz)	5G NR FR1 TDD	9.55	± 9.6 %
10967	AAB	5G NR DL (CP-OFDM, TM 3.1, 20 MHz, 64-QAM, 30 kHz)	5G NR FR1 TDD	9.42	± 9.6 %
10968	AAB	5G NR DL (CP-OFDM, TM 3.1, 100 MHz, 64-QAM, 30 kHz)	5G NR FR1 TDD	9.49	± 9.6 %
10972	AAB	5G NR (CP-OFDM, 1 RB, 20 MHz, QPSK, 15 kHz)	5G NR FR1 TDD	11.59	± 9.6 %
10973	AAB	5G NR (DFT-s-OFDM, 1 RB, 100 MHz, QPSK, 30 kHz)	5G NR FR1 TDD	9.06	± 9.6 %
10974	AAB	5G NR (CP-OFDM, 100% RB, 100 MHz, 256-QAM, 30 kHz)	5G NR FR1 TDD	10.28	± 9.6 %
10978	AAA	ULLA BDR	ULLA	2.23	± 9.6 %
10979	AAA	ULLA HDR4	ULLA	7.02	± 9.6 %
10980	AAA	ULLA HDR8	ULLA	8.82	± 9.6 %
10981	AAA	ULLA HDRp4	ULLA	1.50	± 9.6 %
10982	AAA	ULLA HDRp8	ULLA	1.44	± 9.6 %
10983	AAA	5G NR DL (CP-OFDM, TM 3.1, 40 MHz, 64-QAM, 15 kHz)	5G NR FR1 TDD	9.31	± 9.6 %
10984	AAA	5G NR DL (CP-OFDM, TM 3.1, 50 MHz, 64-QAM, 15 kHz)	5G NR FR1 TDD	9.42	± 9.6 %

10985	AAA	5G NR DL (CP-OFDM, TM 3.1, 40 MHz, 64-QAM, 30 kHz)	5G NR FR1 TDD	9.54	± 9.6 %
10986	AAA	5G NR DL (CP-OFDM, TM 3.1, 50 MHz, 64-QAM, 30 kHz)	5G NR FR1 TDD	9.50	± 9.6 %
10987	AAA	5G NR DL (CP-OFDM, TM 3.1, 60 MHz, 64-QAM, 30 kHz)	5G NR FR1 TDD	9.53	± 9.6 %
10988	AAA	5G NR DL (CP-OFDM, TM 3.1, 70 MHz, 64-QAM, 30 kHz)	5G NR FR1 TDD	9.38	± 9.6 %
10989	AAA	5G NR DL (CP-OFDM, TM 3.1, 80 MHz, 64-QAM, 30 kHz)	5G NR FR1 TDD	9.33	± 9.6 %
10990	AAA	5G NR DL (CP-OFDM, TM 3.1, 90 MHz, 64-QAM, 30 kHz)	5G NR FR1 TDD	9.52	± 9.6 %

^E Uncertainty is determined using the max. deviation from linear response applying rectangular distribution and is expressed for the square of the field value.



Accredited by the Swiss Accreditation Service (SAS)
The Swiss Accreditation Service is one of the signatories to the EA
Multilateral Agreement for the recognition of calibration certificates

Accreditation No.: **SCS 0108**

Client **B.V. ADT (Auden)**

Certificate No: **5G-Veri10-1025_Jan22**

CALIBRATION CERTIFICATE

Object **5G Verification Source 10 GHz - SN: 1025**

Calibration procedure(s) **QA CAL-45.v3
Calibration procedure for sources in air above 6 GHz**

Calibration date: **January 17, 2022**

This calibration certificate documents the traceability to national standards, which realize the physical units of measurements (SI).
The measurements and the uncertainties with confidence probability are given on the following pages and are part of the certificate.

All calibrations have been conducted in the closed laboratory facility: environment temperature (22 ± 3)°C and humidity < 70%.

Calibration Equipment used (M&TE critical for calibration)

Primary Standards	ID #	Cal Date (Certificate No.)	Scheduled Calibration
Reference Probe EUmmWV3	SN: 9374	2021-12-21 (No. EUmmWV3-9374_Dec21)	Dec-22
DAE4ip	SN: 1602	2021-06-25 (No. DAE4ip-1602_Jun21)	Jun-22

Secondary Standards	ID #	Check Date (in house)	Scheduled Check

Calibrated by:	Name Leif Klysner	Function Laboratory Technician
Approved by:	Sven Kühn	Deputy Manager

Signature

Issued: January 26, 2022

This calibration certificate shall not be reproduced except in full without written approval of the laboratory.



Accredited by the Swiss Accreditation Service (SAS)

The Swiss Accreditation Service is one of the signatories to the EA Multilateral Agreement for the recognition of calibration certificates

Accreditation No.: **SCS 0108**

Glossary

CW Continuous wave

Calibration is Performed According to the Following Standards

- Internal procedure QA CAL-45-5Gsources
- IEC TR 63170 ED1, "Measurement procedure for the evaluation of power density related to human exposure to radio frequency fields from wireless communication devices operating between 6 GHz and 100 GHz", January 2018

Methods Applied and Interpretation of Parameters

- *Coordinate System:* z-axis in the waveguide horn boresight, x-axis is in the direction of the E-field, y-axis normal to the others in the field scanning plane parallel to the horn flare and horn flange.
- *Measurement Conditions:* (1) 10 GHz: The radiated power is the forward power to the horn antenna minus ohmic and mismatch loss. The forward power is measured prior and after the measurement with a power sensor. During the measurements, the horn is directly connected to the cable and the antenna ohmic and mismatch losses are determined by far-field measurements. (2) 30, 45, 60 and 90 GHz: The verification sources are switched on for at least 30 minutes. Absorbers are used around the probe cub and at the ceiling to minimize reflections.
- *Horn Positioning:* The waveguide horn is mounted vertically on the flange of the waveguide source to allow vertical positioning of the EUmmW probe during the scan. The plane is parallel to the phantom surface. Probe distance is verified using mechanical gauges positioned on the flare of the horn.
- *E- field distribution:* E field is measured in two x-y-plane (10mm, 10mm + $\lambda/4$) with a vectorial E-field probe. The E-field value stated as calibration value represents the E-field-maxima and the averaged (1cm² and 4cm²) power density values at 10mm in front of the horn.
- *Field polarization:* Above the open horn, linear polarization of the field is expected. This is verified graphically in the field representation.

Calibrated Quantity

- Local peak E-field (V/m) and average of peak spatial components of the poynting vector (W/m²) averaged over the surface area of 1 cm² and 4cm² at the nominal operational frequency of the verification source. Both square and circular averaging results are listed.

The reported uncertainty of measurement is stated as the standard uncertainty of measurement multiplied by the coverage factor k=2, which for a normal distribution corresponds to a coverage probability of approximately 95%.

Measurement Conditions

DASY system configuration, as far as not given on page 1.

DASY Version	cDASY6 Module mmWave	V2.4
Phantom	5G Phantom	
Distance Horn Aperture - plane	10 mm	
XY Scan Resolution	dx, dy = 7.5 mm	
Number of measured planes	2 (10mm, 10mm + $\lambda/4$)	
Frequency	10 GHz \pm 10 MHz	

Calibration Parameters, 10 GHz

Circular Averaging

Distance Horn Aperture to Measured Plane	<i>Prad</i> ¹ (mW)	Max E-field (V/m)	Uncertainty (k = 2)	Avg Power Density Avg (<i>psPD</i> _{n+} , <i>psPD</i> _{tot+} , <i>psPD</i> _{mod+}) (W/m ²)		Uncertainty (k = 2)
				1 cm ²	4 cm ²	
10 mm	86.1	148	1.27 dB	54.5	51.3	1.28 dB

Square Averaging

Distance Horn Aperture to Measured Plane	<i>Prad</i> ¹ (mW)	Max E-field (V/m)	Uncertainty (k = 2)	Avg Power Density Avg (<i>psPD</i> _{n+} , <i>psPD</i> _{tot+} , <i>psPD</i> _{mod+}) (W/m ²)		Uncertainty (k = 2)
				1 cm ²	4 cm ²	
10 mm	86.1	148	1.27 dB	54.5	51.3	1.28 dB

¹ Assessed ohmic and mismatch loss plus numerical offset: 0.55 dB

DASY Report

Measurement Report for 5G Verification Source 10 GHz, UID 0 -, Channel 10000 (10000.0MHz)

Device under Test Properties

Name, Manufacturer	Dimensions [mm]	IMEI	DUT Type
5G Verification Source 10 GHz	100.0 x 100.0 x 172.0	SN: 1025	-

Exposure Conditions

Phantom Section	Position, Test Distance [mm]	Band	Group,	Frequency [MHz], Channel Number	Conversion Factor
5G -	10.0 mm	Validation band	CW	10000.0, 10000	1.0

Hardware Setup

Phantom	Medium	Probe, Calibration Date	DAE, Calibration Date
mmWave Phantom - 1002	Air	EUmWV3 - SN9374_F1-55GHz, 2021-12-21	DAE4ip Sn1602, 2021-06-25

Scan Setup

Grid Extents [mm]
Grid Steps [lambda]
Sensor Surface [mm]
MAIA

5G Scan
120.0 x 120.0
0.25 x 0.25
10.0
MAIA not used

Measurement Results

5G Scan
Date: 2022-01-17, 16:55
Avg. Area [cm²]: 1.00
psPDn+ [W/m²]: 54.2
psPDtot+ [W/m²]: 54.5
psPDmod+ [W/m²]: 54.7
E_{max} [V/m]: 148
Power Drift [dB]: 0.04

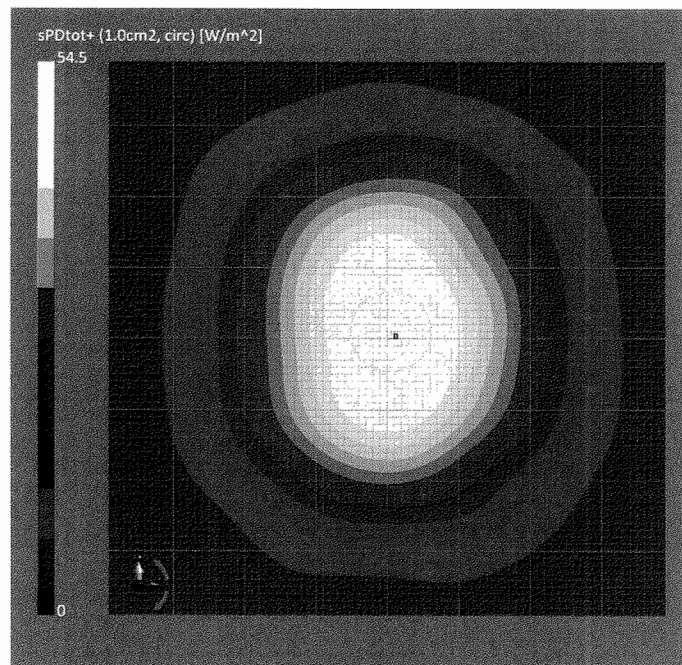

DASY Report

Measurement Report for 5G Verification Source 10 GHz, UID 0 -, Channel 10000 (10000.0MHz)

Device under Test Properties

Name, Manufacturer	Dimensions [mm]	IMEI	DUT Type
5G Verification Source 10 GHz	100.0 x 100.0 x 172.0	SN: 1025	-

Exposure Conditions

Phantom Section	Position, Test Distance [mm]	Band	Group,	Frequency [MHz], Channel Number	Conversion Factor
5G -	10.0 mm	Validation band	CW	10000.0, 10000	1.0

Hardware Setup

Phantom	Medium	Probe, Calibration Date	DAE, Calibration Date
mmWave Phantom - 1002	Air	EUmmWV3 - SN9374_F1-55GHz, 2021-12-21	DAE4ip Sn1602, 2021-06-25

Scan Setup

	5G Scan
Grid Extents [mm]	120.0 x 120.0
Grid Steps [lambda]	0.25 x 0.25
Sensor Surface [mm]	10.0
MAIA	MAIA not used

Measurement Results

	5G Scan
Date	2022-01-17, 16:55
Avg. Area [cm ²]	4.00
psPDn+ [W/m ²]	51.1
psPDtot+ [W/m ²]	51.4
psPDmod+ [W/m ²]	51.5
E _{max} [V/m]	148
Power Drift [dB]	0.04

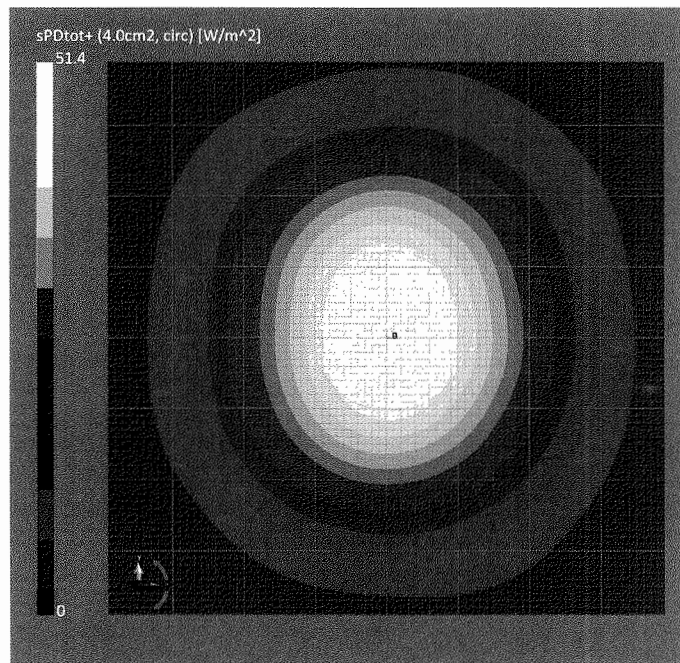

DASY Report

Measurement Report for 5G Verification Source 10 GHz, UID 0 -, Channel 10000 (10000.0MHz)

Device under Test Properties

Name, Manufacturer	Dimensions [mm]	IMEI	DUT Type
5G Verification Source 10 GHz	100.0 x 100.0 x 172.0	SN: 1025	-

Exposure Conditions

Phantom Section	Position, Test Distance [mm]	Band	Group,	Frequency [MHz], Channel Number	Conversion Factor
5G -	10.0 mm	Validation band	CW	10000.0, 10000	1.0

Hardware Setup

Phantom	Medium	Probe, Calibration Date	DAE, Calibration Date
mmWave Phantom - 1002	Air	EUmmWV3 - SN9374_F1-55GHz, 2021-12-21	DAE4ip Sn1602, 2021-06-25

Scan Setup

	5G Scan
Grid Extents [mm]	120.0 x 120.0
Grid Steps [lambda]	0.25 x 0.25
Sensor Surface [mm]	10.0
MAIA	MAIA not used

Measurement Results

	5G Scan
Date	2022-01-17, 16:55
Avg. Area [cm ²]	1.00
psPDn+ [W/m ²]	54.2
psPDtot+ [W/m ²]	54.5
psPDmod+ [W/m ²]	54.8
E _{max} [V/m]	148
Power Drift [dB]	0.04

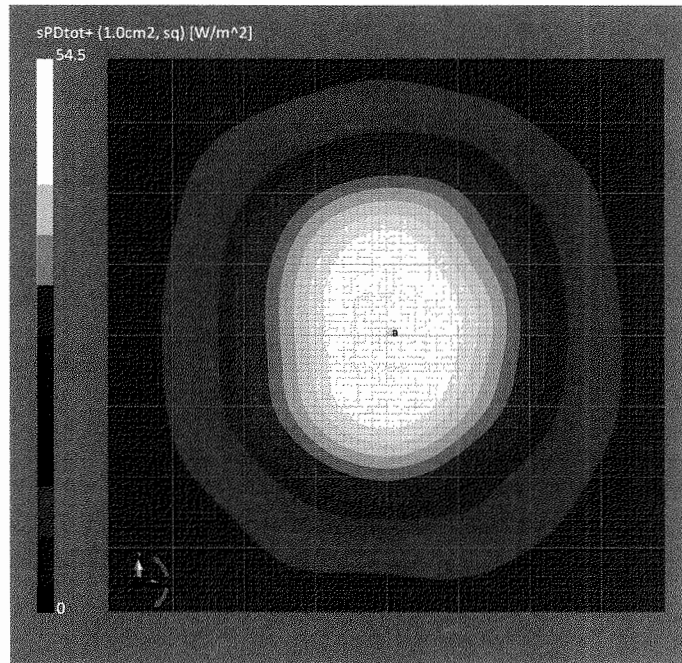

DASY Report

Measurement Report for 5G Verification Source 10 GHz, UID 0 -, Channel 10000 (10000.0MHz)

Device under Test Properties

Name, Manufacturer	Dimensions [mm]	IMEI	DUT Type
5G Verification Source 10 GHz	100.0 x 100.0 x 172.0	SN: 1025	-

Exposure Conditions

Phantom Section	Position, Test Distance [mm]	Band	Group,	Frequency [MHz], Channel Number	Conversion Factor
5G -	10.0 mm	Validation band	CW	10000.0, 10000	1.0

Hardware Setup

Phantom	Medium	Probe, Calibration Date	DAE, Calibration Date
mmWave Phantom - 1002	Air	EUmmWV3 - SN9374_F1-55GHz, 2021-12-21	DAE4ip Sn1602, 2021-06-25

Scan Setup

	5G Scan
Grid Extents [mm]	120.0 x 120.0
Grid Steps [lambda]	0.25 x 0.25
Sensor Surface [mm]	10.0
MAIA	MAIA not used

Measurement Results

	5G Scan
Date	2022-01-17, 16:55
Avg. Area [cm ²]	4.00
psPDn+ [W/m ²]	51.1
psPDtot+ [W/m ²]	51.3
psPDmod+ [W/m ²]	51.5
E _{max} [V/m]	148
Power Drift [dB]	0.04

