

TEST REPORT

CERTIFICATE OF CONFORMITY

Standard: 47 CFR FCC Part 15, Subpart C (Section 15.247)
Report No.: RFBARR-WTW-P22060042A
FCC ID: RAS-MT7927
Product: 2TX 11be (WiFi7) BW320 + BT/BLE Combo Card
Brand: MediaTek
Model No.: MT7927
Received Date: 2022/10/6
Test Date: 2022/11/8 ~ 2022/12/25
Issued Date: 2023/3/21

Applicant: MediaTek Inc.
Address: No. 1, Dusing 1st Rd., Hsinchu Science Park, Hsinchu City, 30078 Taiwan
Issued By: Bureau Veritas Consumer Products Services (H.K.) Ltd., Taoyuan Branch
Hsin Chu Laboratory
Lab Address: E-2, No.1, Li Hsin 1st Road, Hsinchu Science Park, Hsinchu City 300, Taiwan
Test Location: E-2, No.1, Li Hsin 1st Road, Hsinchu Science Park, Hsinchu City 300, Taiwan
FCC Registration / 723255 / TW2022
Designation Number:

Approved by: _____

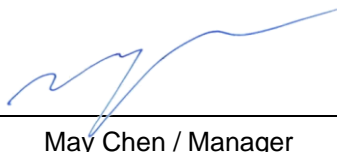

May Chen / Manager

, Date: _____

2023/3/21

This test report consists of 115 pages in total. It may be duplicated completely for legal use with the approval of the applicant. It should not be reproduced except in full, without the written approval of our laboratory. The test results in the report only apply to the tested sample. The test results in this report are traceable to the national or international standards.



Prepared by : Claire Kuan / Specialist

This report is governed by, and incorporates by reference, the Conditions of Testing as posted at the date of issuance of this report at <http://www.bureauveritas.com/home/about-us/our-business/cps/about-us/terms-conditions/> and is intended for your exclusive use. Any copying or replication of this report to or for any other person or entity, or use of our name or trademark, is permitted only with our prior written permission. This report sets forth our findings solely with respect to the test samples identified herein. The results set forth in this report are not indicative or representative of the quality or characteristics of the lot from which a test sample was taken or any similar or identical product unless specifically and expressly noted. Our report includes all of the tests requested by you and the results thereof based upon the information that you provided to us. Measurement uncertainty is only provided upon request for accredited tests. Statements of conformity are based on simple acceptance criteria without taking measurement uncertainty into account, unless otherwise requested in writing. You have 60 days from date of issuance of this report to notify us of any material error or omission caused by our negligence or if you require measurement uncertainty; provided, however, that such notice shall be in writing and shall specifically address the issue you wish to raise. A failure to raise such issue within the prescribed time shall constitute your unqualified acceptance of the completeness of this report, the tests conducted and the correctness of the report contents.

Table of Contents

Release Control Record	4
1 Certificate	5
2 Summary of Test Results	6
2.1 Measurement Uncertainty	6
2.2 Supplementary Information	6
3 General Information	7
3.1 General Description	7
3.2 Antenna Description of EUT	8
3.3 Channel List	9
3.4 Test Mode Applicability and Tested Channel Detail	10
3.5 Duty Cycle of Test Signal	11
3.6 Test Program Used and Operation Descriptions	13
3.7 Connection Diagram of EUT and Peripheral Devices	13
3.8 Configuration of Peripheral Devices and Cable Connections	14
4 Test Instruments	15
4.1 RF Output Power	15
4.2 Power Spectral Density	15
4.3 6 dB Bandwidth	15
4.4 Conducted Out of Band Emissions	15
4.5 AC Power Conducted Emissions	16
4.6 Unwanted Emissions below 1 GHz	16
4.7 Unwanted Emissions above 1 GHz	17
5 Limits of Test Items	18
5.1 RF Output Power	18
5.2 Power Spectral Density	18
5.3 6 dB Bandwidth	18
5.4 Conducted Out of Band Emissions	18
5.5 AC Power Conducted Emissions	18
5.6 Unwanted Emissions below 1 GHz	19
5.7 Unwanted Emissions above 1 GHz	19
6 Test Arrangements	20
6.1 RF Output Power	20
6.1.1 Test Setup	20
6.1.2 Test Procedure	20
6.2 Power Spectral Density	20
6.2.1 Test Setup	20
6.2.2 Test Procedure	20
6.3 6 dB Bandwidth	21
6.3.1 Test Setup	21
6.3.2 Test Procedure	21
6.4 Conducted Out of Band Emissions	21
6.4.1 Test Setup	21
6.4.2 Test Procedure	21
6.5 AC Power Conducted Emissions	22
6.5.1 Test Setup	22
6.5.2 Test Procedure	22
6.6 Unwanted Emissions below 1 GHz	23
6.6.1 Test Setup	23
6.6.2 Test Procedure	24
6.7 Unwanted Emissions above 1 GHz	25
6.7.1 Test Setup	25
6.7.2 Test Procedure	25
7 Test Results of Test Item	26



7.1	RF Output Power.....	26
7.2	Power Spectral Density	28
7.3	6 dB Bandwidth	31
7.4	Conducted Out of Band Emissions	34
7.5	AC Power Conducted Emissions	54
7.6	Unwanted Emissions below 1 GHz	56
7.7	Unwanted Emissions above 1 GHz.....	58
8	Pictures of Test Arrangements	114
9	Information of the Testing Laboratories	115



Release Control Record

Issue No.	Description	Date Issued
RFBARR-WTW-P22060042A	Original release.	2023/3/21

1 Certificate

Product: 2TX 11be (WiFi7) BW320 + BT/BLE Combo Card

Brand: MediaTek

Test Model: MT7927

Sample Status: Engineering sample

Applicant: MediaTek Inc.

Test Date: 2022/11/8 ~ 2022/12/25

Standard: 47 CFR FCC Part 15, Subpart C (Section 15.247)

Measurement ANSI C63.10-2013

procedure: KDB 558074 D01 15.247 Meas Guidance v05r02

KDB 662911 D01 Multiple Transmitter Output v02r01

The above equipment has been tested by **Bureau Veritas Consumer Products Services (H.K.) Ltd., Taoyuan Branch**, and found compliance with the requirement of the above standards. The test record, data evaluation & Equipment Under Test (EUT) configurations represented herein are true and accurate accounts of the measurements of the sample's RF characteristics under the conditions specified in this report.

2 Summary of Test Results

47 CFR FCC Part 15, Subpart C (Section 15.247)			
Standard / Clause	Test Item	Result	Remark
15.247(b)	RF Output Power	Pass	Meet the requirement of limit.
15.247(e)	Power Spectral Density	Pass	Meet the requirement of limit.
15.247(a)(2)	6 dB Bandwidth	Pass	Meet the requirement of limit.
15.247(d)	Conducted Out of Band Emissions	Pass	Meet the requirement of limit.
15.207	AC Power Conducted Emissions	Pass	Minimum passing margin is -6.60 dB at 0.15000 MHz
15.205 / 15.209 / 15.247(d)	Unwanted Emissions below 1 GHz	Pass	Minimum passing margin is -3.1 dB at 199.55 MHz
15.205 / 15.209 / 15.247(d)	Unwanted Emissions above 1 GHz	Pass	Minimum passing margin is -0.1 dB at 2390.00, 2483.50 MHz
15.203	Antenna Requirement	Pass	No antenna connector is used.

Note: Determining compliance based on the results of the compliance measurement, not taking into account measurement instrumentation uncertainty.

2.1 Measurement Uncertainty

Where relevant, the following measurement uncertainty levels have been estimated for tests performed on the EUT as specified in CISPR 16-4-2:

Measurement	Specification	Expanded Uncertainty (k=2) (±)
Conducted Out of Band Emissions	9 kHz ~ 40 GHz	2.5 dB
AC Power Conducted Emissions	150 kHz ~ 30 MHz	1.9 dB
Unwanted Emissions below 1 GHz	9 kHz ~ 30 MHz	3.1 dB
	30 MHz ~ 1 GHz	5.5 dB
Unwanted Emissions above 1 GHz	1 GHz ~ 18 GHz	5.1 dB
	18 GHz ~ 40 GHz	5.3 dB

The other instruments specified are routine verified to remain within the calibrated levels, no measurement uncertainty is required to be calculated.

2.2 Supplementary Information

There is not any deviation from the test standards for the test method, and no modifications required for compliance.

3 General Information

3.1 General Description

Product	2TX 11be (WiFi7) BW320 + BT/BLE Combo Card
Brand	MediaTek
Test Model	MT7927
Status of EUT	Engineering sample
Power Supply Rating	3.3Vdc from host equipment
Modulation Type	CCK, DQPSK, DBPSK for DSSS 64QAM, 16QAM, QPSK, BPSK for OFDM 256QAM for OFDM in VHT mode 1024QAM for OFDMA in 11ax mode 4096QAM for OFDMA in 11be mode
Modulation Technology	DSSS, OFDM, OFDMA
Transfer Rate	802.11b: up to 11 Mbps 802.11g: up to 54 Mbps 802.11n: up to 300 Mbps VHT: up to 400 Mbps 802.11ax: up to 573.5 Mbps 802.11be: up to 688.2 Mbps
Operating Frequency	2412 ~ 2472 MHz
Number of Channel	802.11b, 802.11g, 802.11n (HT20), VHT20, 802.11ax (HE20), 802.11be (EHT20): 13 802.11n (HT40), VHT40, 802.11ax (HE40), 802.11be (EHT40): 9
Resource Unit (RU)	Single RU: 26-tone, 52-tone, 106-tone, 242-tone, 484-tone, 996-tone Multi-RU(Small RU): 52-tone + 26-tone, 106-tone + 26-tone
Output Power	278.691 mW (24.45 dBm)

Note:

1. This is a supplementary report of Report No: RFBARR-WTW-P22060042. The differences between them are as below information:

◆ Add Tone RU / MRU (2T)

2. According to above conditions, all test items need to be performed. And all data are verified to meet the requirement.

3. There are Bluetooth and WLAN (2.4GHz & 5GHz & 5.9GHz & 6GHz) technology used for the EUT.

4. Simultaneously transmission condition.

Condition	Technology	
1	WLAN (5GHz or 5.9GHz)	Bluetooth
2	WLAN (6GHz)	Bluetooth
3	WLAN (2.4GHz)	WLAN (5GHz or 5.9GHz)
4	WLAN (2.4GHz)	WLAN (6GHz)

Note: The emission of the simultaneous operation has been evaluated and no non-compliance was found.

5. The EUT support MRU mode is listed as below.

BW	Small size	
	26+52	26+106
20MHz	v	v
40MHz	v	v

6. The above EUT information is declared by manufacturer and for more detailed features description, please refer to the manufacturer's specifications or user's manual.

3.2 Antenna Description of EUT

1. The antenna information is listed as below.

Antenna Set No	RF Chain No.	Brand	Model	Antenna Net Gain (dBi)	Frequency Range (GHz)	Antenna Type	Connector Type	Cable Length (mm)
1	Chain0	PSA	RFMTA340718EMLB302	3.18	2.4~2.4835	PIFA	ipex(MHF)	200
				4.92	5.15~5.895			
	Chain1	PSA	RFMTA340718EMLB302	3.18	2.4~2.4835	PIFA	ipex(MHF)	200
				4.92	5.15~5.895			
2	Chain0	PSA	RFMTA311020EMMB301	1.71	2.4~2.4835	PIFA	ipex(MHF)	200
				4.82	5.15~5.895			
				4.76	5.925~6.425			
				4.29	6.425~6.525			
	Chain1	PSA	RFMTA311020EMMB301	4.61	6.525~6.875	PIFA	ipex(MHF)	200
				4.09	6.875~7.125			
				1.71	2.4~2.4835			
				4.82	5.15~5.895			
3	Chain0	PSA	RFMTA421208IMMB701	-4.99	5.925~7.125	PIFA	i-pex(MHF)	300
	Chain1	PSA	RFMTA421208IMMB701	-4.99	5.925~7.125	PIFA	i-pex(MHF)	300

Note:

1. Max. gain was selected for the final test.

* Detail antenna specification please refer to antenna datasheet and/or antenna measurement report.

2. The EUT incorporates a MIMO function:

2.4 GHz Band		
Modulation Mode	TX & RX Configuration	
802.11b	2TX	2RX
802.11g	2TX	2RX
802.11n (HT20)	2TX	2RX
802.11n (HT40)	2TX	2RX
VHT20	2TX	2RX
VHT40	2TX	2RX
802.11ax (HE20)	2TX	2RX
802.11ax (HE40)	2TX	2RX
802.11be (EHT20)	2TX	2RX
802.11be (EHT40)	2TX	2RX

Note: The modulation and bandwidth are similar for 802.11n mode for 20MHz (40MHz), VHT mode for 20MHz (40MHz), 802.11ax mode for 20MHz (40MHz) and 802.11be mode for 20MHz (40MHz), therefore the manufacturer will control the power for 802.11n/VHT/ax mode is the same as the 802.11be or more lower than it and investigated worst case to representative mode in test report.

3.3 Channel List

13 channels are provided for 802.11b, 802.11g, 802.11n (HT20), VHT20 and 802.11ax (HE20), 802.11be (EHT20):

Channel	Frequency	Channel	Frequency
1	2412MHz	8	2447MHz
2	2417MHz	9	2452MHz
3	2422MHz	10	2457MHz
4	2427MHz	11	2462MHz
5	2432MHz	12	2467MHz
6	2437MHz	13	2472MHz
7	2442MHz		

9 channels are provided for 802.11n (HT40), VHT40 and 802.11ax (HE40), 802.11be (EHT40):

Channel	Frequency	Channel	Frequency
3	2422MHz	8	2447MHz
4	2427MHz	9	2452MHz
5	2432MHz	10	2457MHz
6	2437MHz	11	2462MHz
7	2442MHz		

3.4 Test Mode Applicability and Tested Channel Detail

Pre-Scan:	1. EUT can be used in the following ways: X-axis/ Y-axis/ Z-axis. Pre-scan these ways and find the worst case as a representative test condition.
Worst Case:	1. In the original report: X-axis/ Y-axis/ Z-axis Worst Condition: Z-axis

Following channel(s) was (were) selected for the final test as listed below:

Test Item	Mode	Tested Channel	Modulation	Data Rate Parameter	RU/MRU Index
RF Output Power / Power Spectral Density	802.11be (EHT) 26-tone RU	1, 6, 11, 12, 13	BPSK	MCS0	0, 0, 8, 8, 8
	802.11be (EHT) 52-tone RU	1, 6, 11, 12, 13	BPSK	MCS0	37, 37, 40, 40, 40
	802.11be (EHT) 106-tone RU	1, 6, 11, 12, 13	BPSK	MCS0	53, 53, 54, 54, 54
	802.11be (EHT) 52+26-tone MRU	1, 11, 12, 13	BPSK	MCS0	70, 72, 72, 72
	802.11be (EHT) 106+26-tone MRU	1, 11, 12, 13	BPSK	MCS0	82, 83, 83, 83
6 dB Bandwidth / Conducted Out of Band Emissions	802.11be (EHT) 26-tone RU	1, 6, 11, 12, 13	BPSK	MCS0	0, 0, 8, 8, 8
	802.11be (EHT) 52-tone RU	1, 6, 11, 12, 13	BPSK	MCS0	37, 37, 40, 40, 40
	802.11be (EHT) 106-tone RU	1, 6, 11, 12, 13	BPSK	MCS0	53, 53, 54, 54, 54
	802.11be (EHT) 52+26-tone MRU	1, 11, 12, 13	BPSK	MCS0	70, 72, 72, 72
	802.11be (EHT) 106+26-tone MRU	1, 11, 12, 13	BPSK	MCS0	82, 83, 83, 83
AC Power Conducted Emissions	802.11be (EHT) 52-tone RU	6	BPSK	MCS0	0
Unwanted Emissions below 1 GHz	802.11be (EHT) 52-tone RU	6	BPSK	MCS0	0
0Unwanted Emissions above 1 GHz	802.11be (EHT) 26-tone RU	1, 6, 11, 12, 13	BPSK	MCS0	0, 0, 8, 8, 8
	802.11be (EHT) 52-tone RU	1, 6, 11, 12, 13	BPSK	MCS0	37, 37, 40, 40, 40
	802.11be (EHT) 106-tone RU	1, 6, 11, 12, 13	BPSK	MCS0	53, 53, 54, 54, 54
	802.11be (EHT) 52+26-tone MRU	1, 11, 12, 13	BPSK	MCS0	70, 72, 72, 72
	802.11be (EHT) 106+26-tone MRU	1, 11, 12, 13	BPSK	MCS0	82, 83, 83, 83

3.5 Duty Cycle of Test Signal

802.11be (EHT) 26-tone RU: Duty cycle = 0.585 ms / 0.699 ms x 100% = 83.7%, duty factor = $10 * \log (1/\text{Duty cycle}) = 0.77 \text{ dB}$

802.11be (EHT) 52-tone RU: Duty cycle = 0.496 ms / 0.611 ms x 100% = 81.2%, duty factor = $10 * \log (1/\text{Duty cycle}) = 0.91 \text{ dB}$

802.11be (EHT) 106-tone RU: Duty cycle = 0.436 ms / 0.551 ms x 100% = 79.1%, duty factor = $10 * \log (1/\text{Duty cycle}) = 1.02 \text{ dB}$

802.11be (EHT 20M) 52+26-tone MRU: Duty cycle = 0.579 ms / 0.692 ms x 100% = 83.7%, duty factor = $10 * \log (1/\text{Duty cycle}) = 0.77 \text{ dB}$

802.11be (EHT 20M) 106+26-tone MRU: Duty cycle = 0.501 ms / 0.615 ms x 100% = 81.5%, duty factor = $10 * \log (1/\text{Duty cycle}) = 0.89 \text{ dB}$

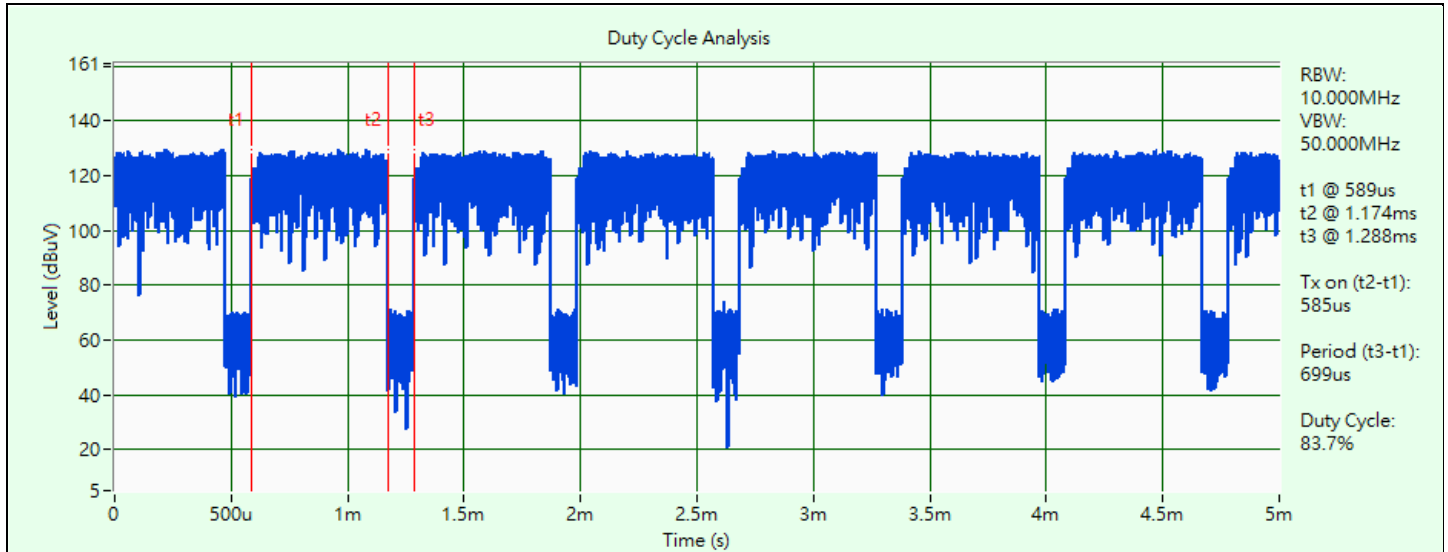

802.11be (EHT) 26-tone RU

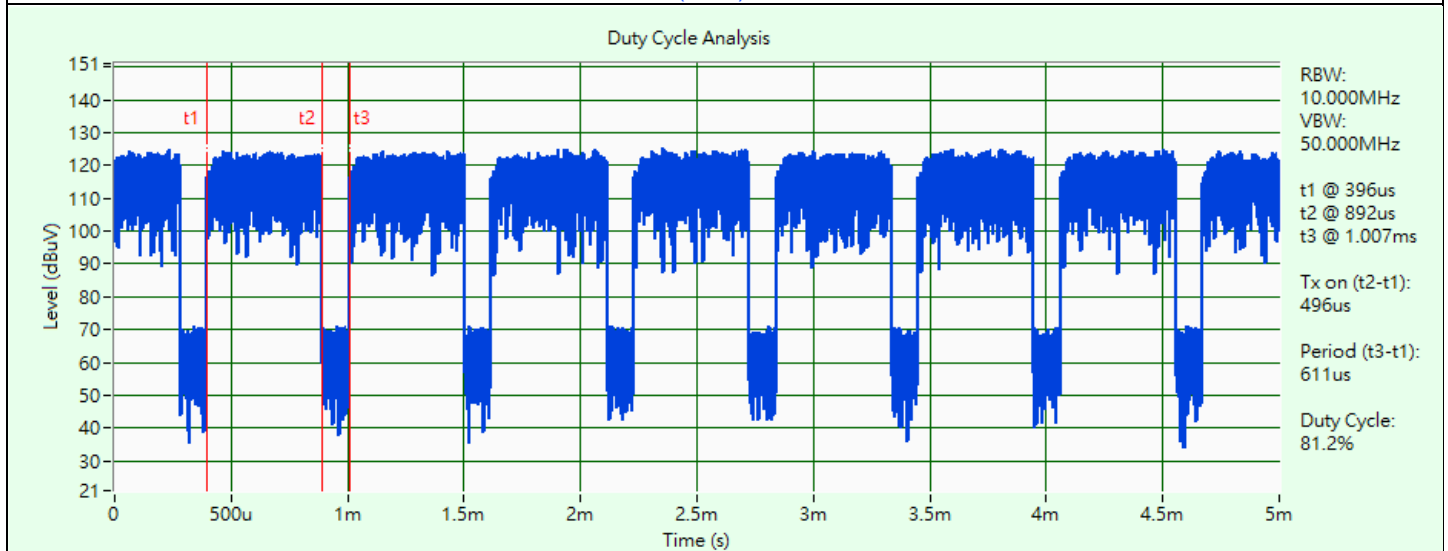

802.11be (EHT) 52-tone RU

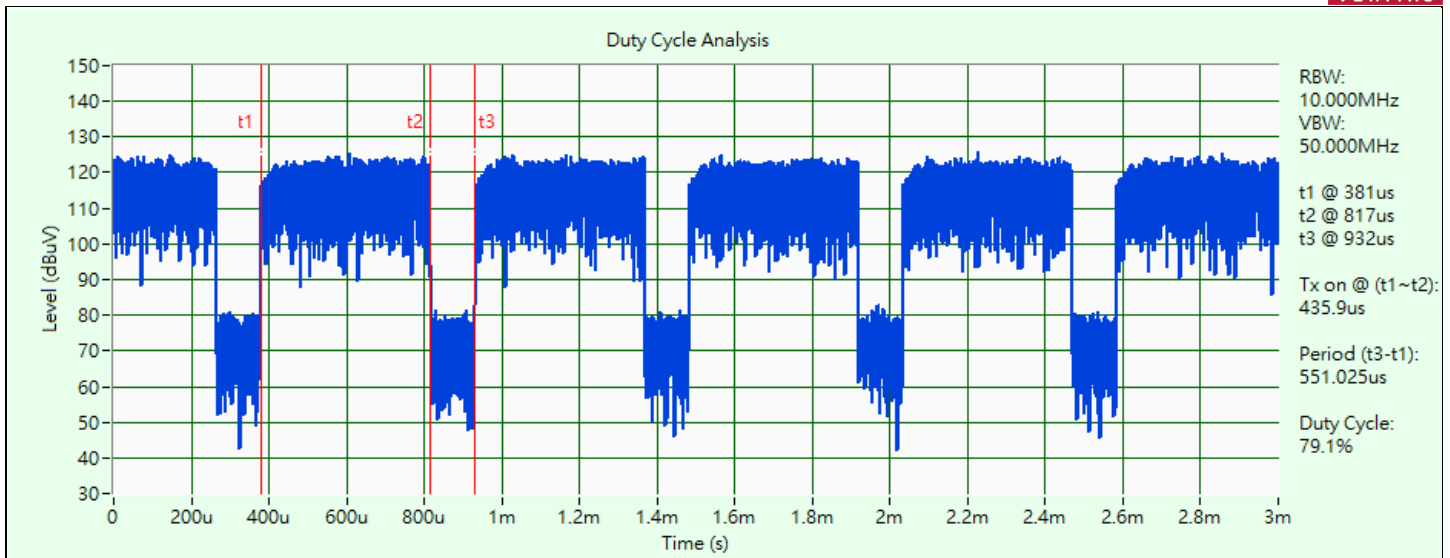

802.11be (EHT) 106-tone RU

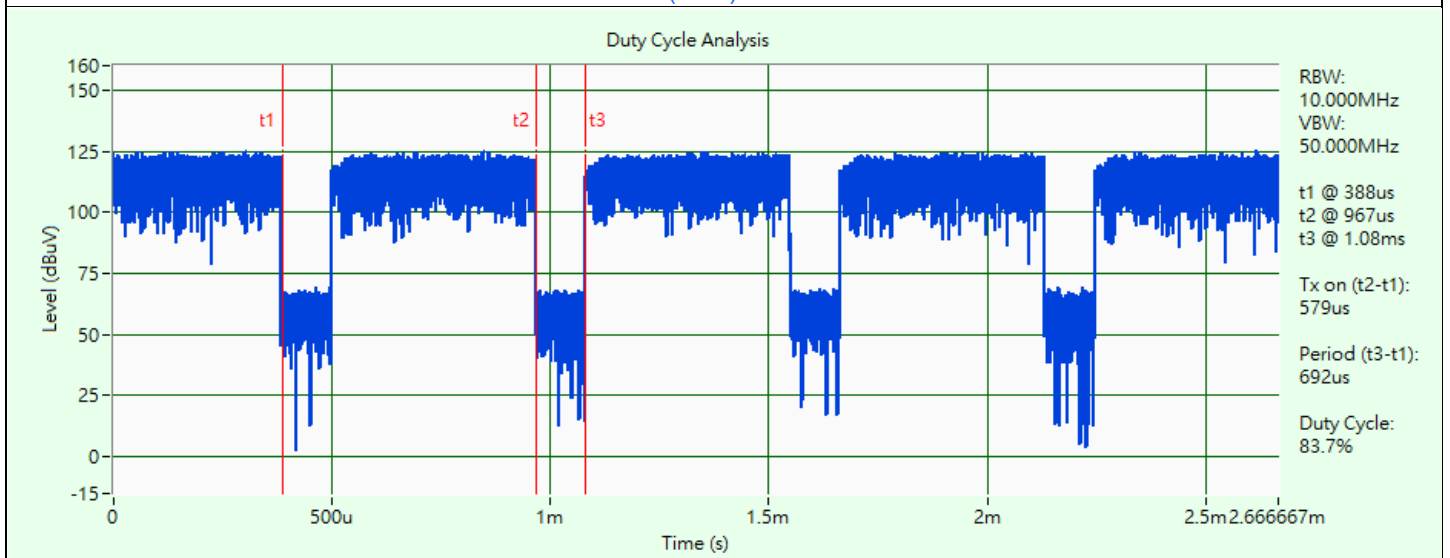

802.11be (EHT 20M) 52+26-tone MRU

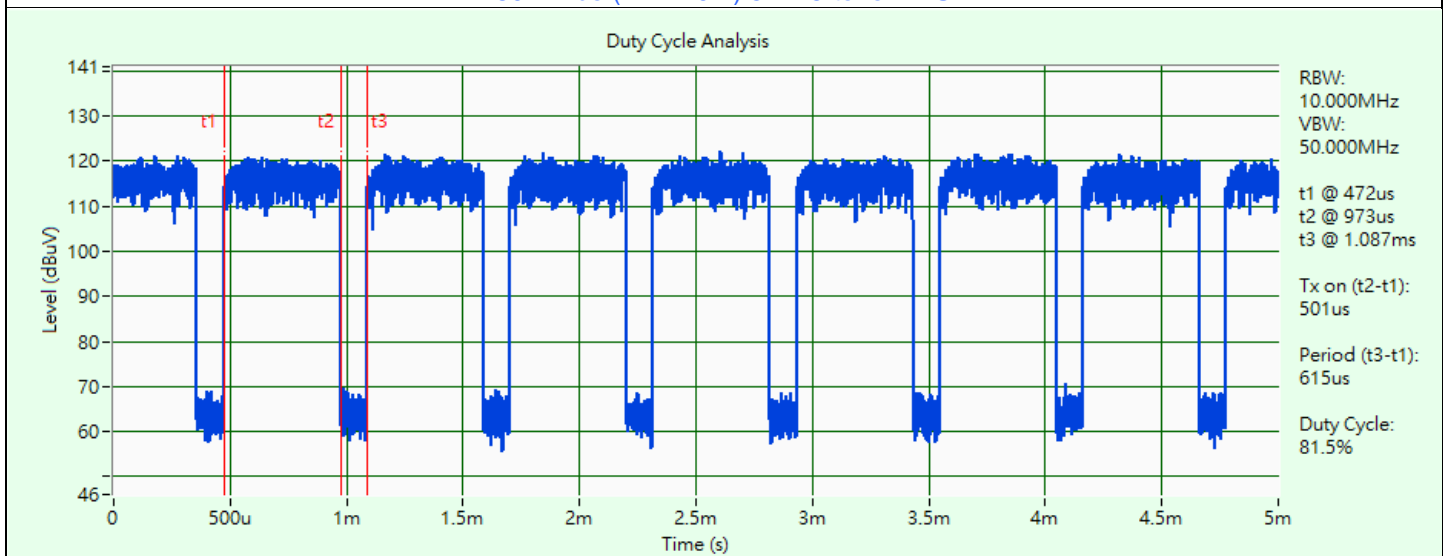

802.11be (EHT 20M) 106+26-tone MRU

3.6 Test Program Used and Operation Descriptions

Controlling software (QAtool_V26 (0.0.2.93)) has been activated to set the EUT under transmission condition continuously at specific channel frequency.

3.7 Connection Diagram of EUT and Peripheral Devices

For AC Power Conducted Emission test

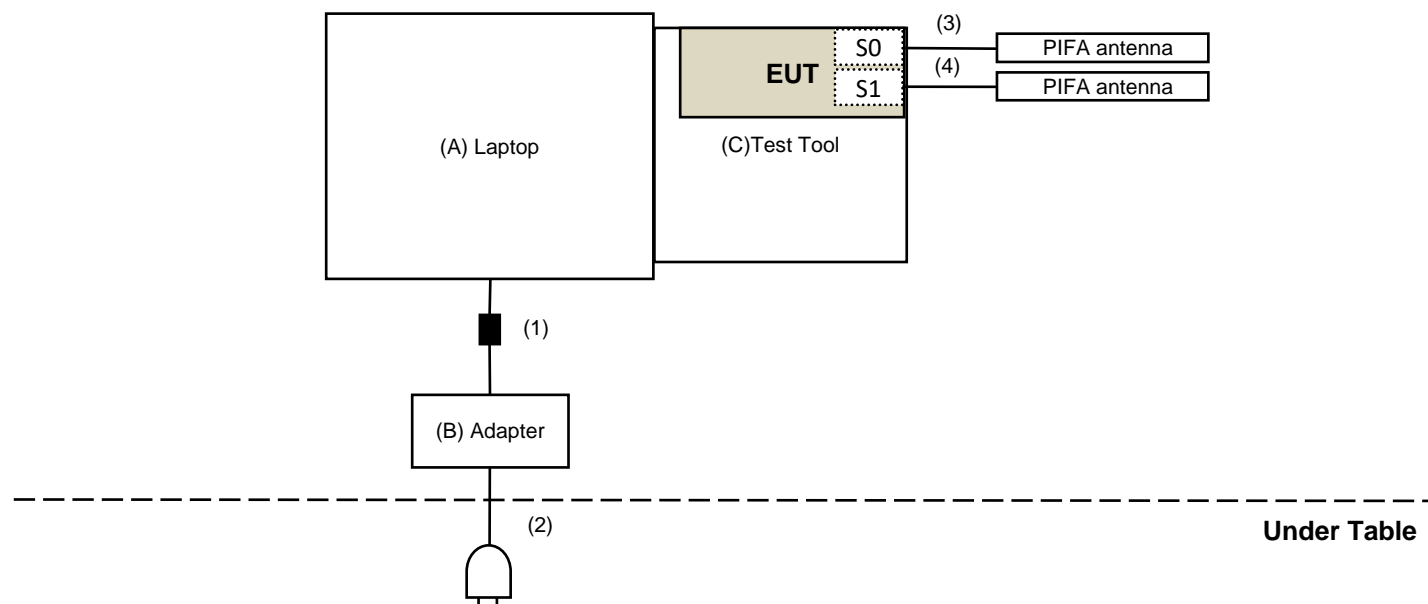

For Unwanted Emission test

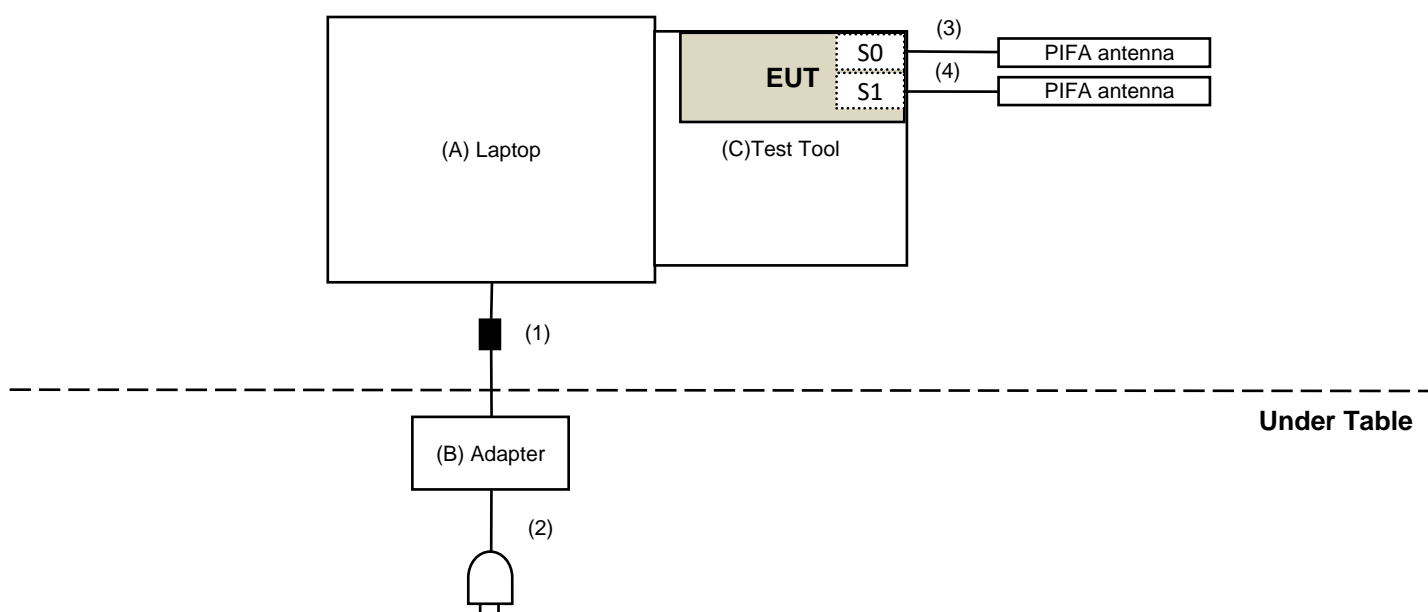

3.8 Configuration of Peripheral Devices and Cable Connections

ID	Product	Brand	Model No.	Serial No.	FCC ID	Remarks
A	Laptop	DELL	E5430	HYV4VY1	DoC	Provided by Lab
B	Adapter	DELL	LLA65NS2-01	N/A	N/A	Provided by Lab
C	Test Tool	Mediatek	MTK1849	N/A	N/A	Supplied by applicant

ID	Cable Descriptions	Qty.	Length (m)	Shielding (Yes/No)	Cores (Qty.)	Remarks
1	DC Cable	1	1.8	No	1	Provided by Lab
2	AC Cable	1	1	No	0	Provided by Lab
3	RF Cable	1	0.2	No	0	Supplied by applicant
4	RF Cable	1	0.2	No	0	Supplied by applicant

4 Test Instruments

The calibration interval of the all test instruments are 12 months and the calibrations are traceable to NML/ROC and NIST/USA.

4.1 RF Output Power

Description Manufacturer	Model No.	Serial No.	Calibrated Date	Calibrated Until
Power Meter Anritsu	ML2495A	1529002	2022/6/22	2023/6/21
Pulse Power Sensor Anritsu	MA2411B	1726434	2022/6/22	2023/6/21

Notes:

1. The test was performed in Oven room 2.
2. Tested Date: 2022/12/21

4.2 Power Spectral Density

Description Manufacturer	Model No.	Serial No.	Calibrated Date	Calibrated Until
Attenuator WOKEN	MDCS18N-10	MDCS18N-10-01	2022/4/5	2023/4/4
Software	ADT_RF Test Software V6.6.5.4	N/A	N/A	N/A
Spectrum Analyzer Keysight	N9020B	MY60112409	2022/3/11	2023/3/10

Notes:

1. The test was performed in Oven room 2.
2. Tested Date: 2022/12/21

4.3 6 dB Bandwidth

Refer to section 4.2 to get information of the instruments.

4.4 Conducted Out of Band Emissions

Refer to section 4.2 to get information of the instruments.

4.5 AC Power Conducted Emissions

Description Manufacturer	Model No.	Serial No.	Calibrated Date	Calibrated Until
50 ohm terminal resistance	N/A	EMC-01	2022/9/27	2023/9/26
Fixed attenuator STI	STI02-2200-10	005	2022/8/24	2023/8/23
LISN R&S	ESH3-Z5	848773/004	2022/10/18	2023/10/17
RF Coaxial Cable JYEBO	5D-FB	COCCAB-001	2022/8/24	2023/8/23
Software BVADT	BVADT_Cond_V7.3.7.4	N/A	N/A	N/A
TEST RECEIVER R&S	ESCS 30	847124/029	2022/10/14	2023/10/13

Notes:

1. The test was performed in Conduction 1
2. Tested Date: 2022/12/25

4.6 Unwanted Emissions below 1 GHz

Description Manufacturer	Model No.	Serial No.	Calibrated Date	Calibrated Until
Boresight Antenna Tower & Turn Table Max-Full	MF-7802BS	MF780208530	N/A	N/A
Fixed attenuator Mini-Circuits	UNAT-5+	PAD-ATT5-03	2022/1/10	2023/1/9
LOOP ANTENNA Electro-Metrics	EM-6879	264	2022/3/18	2023/3/17
Pre_Amplifier Agilent	8447D	2944A10636	2022/3/19	2023/3/18
Pre_Amplifier EMCI	EMC330N	980701	2022/3/8	2023/3/7
RF Coaxial Cable COMMATE/PEWC	8D	966-4-1	2022/3/8	2023/3/7
		966-4-2	2022/3/8	2023/3/7
		966-4-3	2022/3/8	2023/3/7
RF Coaxial Cable JYEBO	5D-FB	LOOPCAB-001	2022/1/6	2023/1/5
		LOOPCAB-002	2022/12/19	2023/12/18
Software	ADT_Radiated_V8.7.08	N/A	N/A	N/A
Spectrum Analyzer KEYSIGHT	N9030B	MY57142938	2022/4/26	2023/4/25
Trilog Broadband Antenna Schwarzbeck	VULB 9168	9168-406	2022/10/21	2023/10/20

Notes:

1. The test was performed in 966 Chamber No. 4.
2. Tested Date: 2022/12/21

4.7 Unwanted Emissions above 1 GHz

Description Manufacturer	Model No.	Serial No.	Calibrated Date	Calibrated Until
Boresight Antenna Tower & Turn Table Max-Full	MF-7802BS	MF780208530	N/A	N/A
Horn Antenna Schwarzbeck	BBHA 9120D	9120D-783	2021/11/14	2022/11/13
			2022/11/13	2023/11/12
	BBHA 9170	9170-739	2021/11/14	2022/11/13
			2022/11/13	2023/11/12
Pre_Amplifier EMCI	EMC12630SE	980688	2022/10/4	2023/10/3
	EMC184045SE	980387	2022/1/10	2023/1/9
RF Cable-Frequency Range : 1- 26.5GHz EMCI	EMC104-SM-SM-1200	160922	2021/12/24 2022/12/15	2022/12/23 2023/12/14
RF Cable-Frequency range: 1- 40GHz EMCI	EMC102-KM-KM-1200	160924	2022/1/10	2023/1/9
RF Coaxial Cable EMCI	EMC-KM-KM-4000	200214	2022/3/8	2023/3/7
	EMC104-SM-SM-2000	180502	2022/4/25	2023/4/24
	EMC104-SM-SM-6000	210704	2022/11/4	2023/11/3
Software	ADT_Radiated_V8.7.08	N/A	N/A	N/A
Spectrum Analyzer Keysight	N9020B	MY60112410	2022/3/13	2023/3/12

Notes:

1. The test was performed in 966 Chamber No. 4.
1. Tested Date: 2022/11/8 ~ 2022/12/23

5 Limits of Test Items

5.1 RF Output Power

For systems using digital modulation in the 2400–2483.5 MHz bands: 1 Watt (30 dBm)

Per KDB 662911 D01 Multiple Transmitter Output Method of conducted output power measurement on IEEE 802.11 devices,

Array Gain = 0 dB (i.e., no array gain) for $N_{ANT} \leq 4$;

Array Gain = 0 dB (i.e., no array gain) for channel widths ≥ 40 MHz for any N_{ANT} ;

Array Gain = $5 \log(N_{ANT}/N_{SS})$ dB or 3 dB, whichever is less, for 20-MHz channel widths with $N_{ANT} \geq 5$.

For power measurements on all other devices: Array Gain = $10 \log(N_{ANT}/N_{SS})$ dB.

5.2 Power Spectral Density

The Maximum of Power Spectral Density Measurement is 8 dBm in any 3 kHz.

5.3 6 dB Bandwidth

The minimum of 6 dB Bandwidth Measurement is 0.5 MHz.

5.4 Conducted Out of Band Emissions

Below 30 dB of the highest emission level of operating band (in 100 kHz Resolution Bandwidth).

5.5 AC Power Conducted Emissions

Frequency (MHz)	Conducted Limit (dBuV)	
	Quasi-peak	Average
0.15 - 0.5	66 - 56	56 - 46
0.50 - 5.0	56	46
5.0 - 30.0	60	50

Notes:

1. The lower limit shall apply at the transition frequencies.
2. The limit decreases in line with the logarithm of the frequency in the range of 0.15 to 0.50 MHz.

5.6 Unwanted Emissions below 1 GHz

Radiated emissions up to 1 GHz which fall in the restricted bands must comply with the radiated emission limits specified as below table. Other emissions shall be at least 30 dB below the highest level of the desired power:

Frequencies (MHz)	Field Strength (microvolts/meter)	Measurement Distance (meters)
0.009 ~ 0.490	2400/F(kHz)	300
0.490 ~ 1.705	24000/F(kHz)	30
1.705 ~ 30.0	30	30
30 ~ 88	100	3
88 ~ 216	150	3
216 ~ 960	200	3
Above 960	500	3

Notes:

1. The lower limit shall apply at the transition frequencies.
2. Emission level (dBuV/m) = 20 log Emission level (uV/m).

5.7 Unwanted Emissions above 1 GHz

Radiated emissions above 1 GHz which fall in the restricted bands must comply with the radiated emission limits specified as below table. Other emissions shall be at least 30 dB below the highest level of the desired power:

Frequencies (MHz)	Field Strength (microvolts/meter)	Measurement Distance (meters)
Above 960	500	3

Notes:

1. The lower limit shall apply at the transition frequencies.
2. Emission level (dBuV/m) = 20 log Emission level (uV/m).
3. For frequencies above 1000 MHz, the field strength limits are based on average detector, however, the peak field strength of any emission shall not exceed the maximum permitted average limits, specified above by more than 20 dB under any condition of modulation.

6 Test Arrangements

6.1 RF Output Power

6.1.1 Test Setup

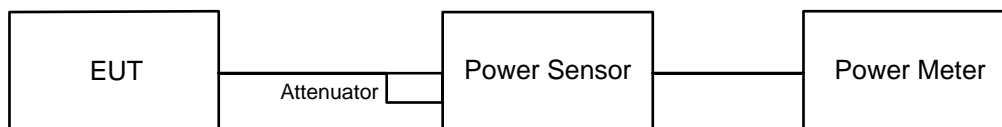

6.1.2 Test Procedure

Average Power:

Average power sensor was used to perform output power measurement, trigger and gating function of wide band power meter is enabled to measure max output power of TX on burst. Duty factor is not added to measured value.

6.2 Power Spectral Density

6.2.1 Test Setup

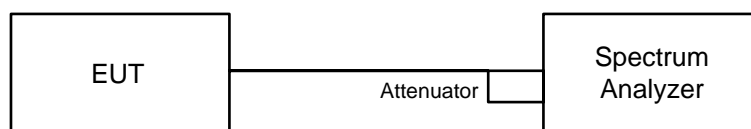

6.2.2 Test Procedure

- a. Measure the duty cycle (x).
- b. Set instrument center frequency to DTS channel center frequency.
- c. Set span to at least 1.5 times the OBW.
- d. Set RBW to: 3 kHz.
- e. Set VBW $\geq 3 \times$ RBW.
- f. Detector = power averaging (RMS) or sample detector (when RMS not available).
- g. Ensure that the number of measurement points in the sweep $\geq 2 \times$ span/RBW.
- h. Sweep time = auto couple.
- i. Do not use sweep triggering. Allow sweep to "free run".
- j. Employ trace averaging (RMS) mode over a minimum of 100 traces.
- k. Use the peak marker function to determine the maximum amplitude level.
- l. Note: If Duty cycle < 98%, Add $10 \log (1/x)$, where x is the duty cycle measured in step (a), to the measured PSD to compute the average PSD during the actual transmission time.

6.3 6 dB Bandwidth

6.3.1 Test Setup

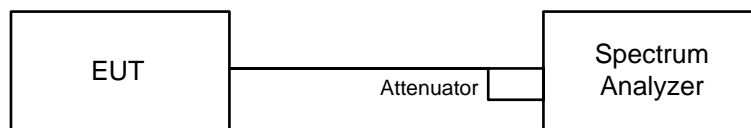

6.3.2 Test Procedure

- Set resolution bandwidth (RBW) = 100 kHz.
- Set the video bandwidth (VBW) $\geq 3 \times$ RBW, Detector = Peak.
- Trace mode = max hold.
- Sweep = auto couple.
- Measure the maximum width of the emission that is constrained by the frequencies associated with the two amplitude points (upper and lower) that are attenuated by 6 dB relative to the maximum level measured in the fundamental emission.

6.4 Conducted Out of Band Emissions

6.4.1 Test Setup

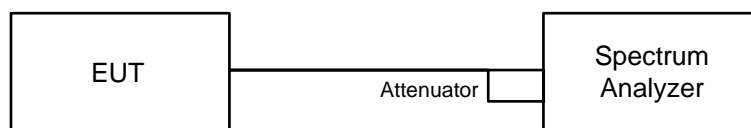

6.4.2 Test Procedure

MEASUREMENT PROCEDURE REF

- Set the RBW = 100 kHz.
- Set the VBW ≥ 300 kHz.
- Detector = peak.
- Sweep time = auto couple.
- Trace mode = max hold.
- Allow trace to fully stabilize.
- Use the peak marker function to determine the maximum power level in any 100 kHz band segment within the fundamental EBW.

MEASUREMENT PROCEDURE OOB

- Set RBW = 100 kHz.
- Set VBW ≥ 300 kHz.
- Detector = peak.
- Sweep = auto couple.
- Trace Mode = max hold.
- Allow trace to fully stabilize.
- Use the peak marker function to determine the maximum amplitude level.

6.5 AC Power Conducted Emissions

6.5.1 Test Setup

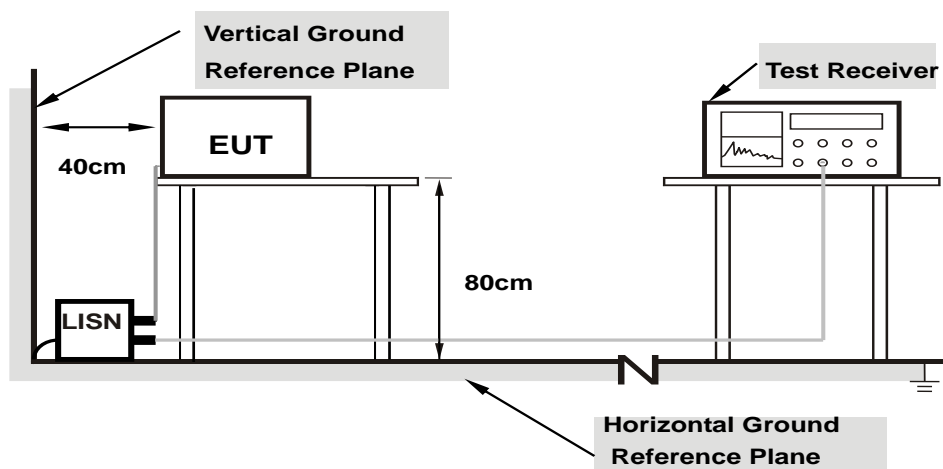

Note: 1.Support units were connected to second LISN.

For the actual test configuration, please refer to the attached file (Test Setup Photo).

6.5.2 Test Procedure

- The EUT was placed on a 0.8 meter to the top of table and placed 0.4 meters from the conducting wall of the shielded room with EUT being connected to the power mains through a line impedance stabilization network (LISN). Other support units were connected to the power mains through another LISN. The two LISNs provide 50 ohm/ 50 uH of coupling impedance for the measuring instrument.
- Both lines of the power mains connected to the EUT were checked for maximum conducted interference.
- The frequency range from 150 kHz to 30 MHz was searched. Emission levels under (Limit – 20 dB) was not recorded.

Note: The resolution bandwidth and video bandwidth of test receiver is 9 kHz for quasi-peak detection (QP) and average detection (AV) at frequency 0.15 MHz-30 MHz.

6.6 Unwanted Emissions below 1 GHz

6.6.1 Test Setup

For Radiated emission below 30 MHz

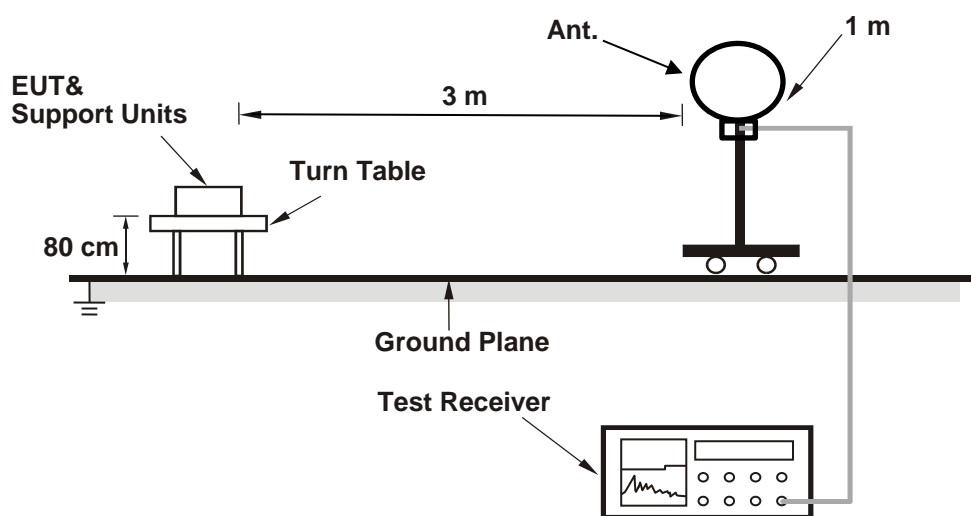

For Radiated emission above 30 MHz

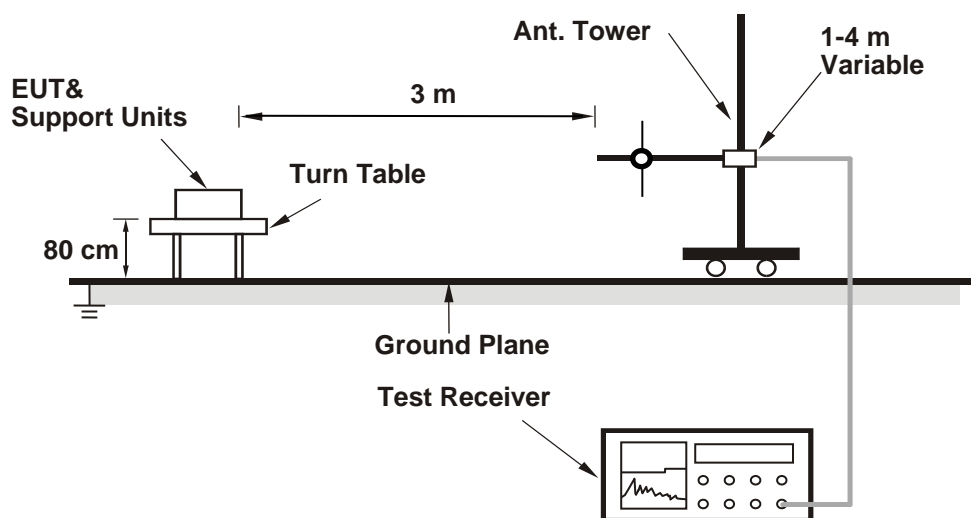

For the actual test configuration, please refer to the attached file (Test Setup Photo).

6.6.2 Test Procedure

For Radiated emission below 30 MHz

- a. The EUT was placed on the top of a rotating table 0.8 meters above the ground at 3 meter chamber room for test. The table was rotated 360 degrees to determine the position of the highest radiation.
- b. The EUT was set 3 meters away from the interference-receiving antenna, which was mounted on the top of a variable-height antenna tower.
- c. Parallel, perpendicular, and ground-parallel orientations of the antenna are set to make the measurement.
- d. For each suspected emission, the EUT was arranged to its worst case and the rotatable table was turned from 0 degrees to 360 degrees to find the maximum reading.
- e. The test-receiver system was set to Quasi-Peak Detect Function and Specified Bandwidth with Maximum Hold Mode, except for the frequency band (9 kHz to 90 kHz and 110 kHz to 490 kHz) set to average detect function and peak detect function.

Notes:

1. The resolution bandwidth and video bandwidth of test receiver/spectrum analyzer is 200 Hz at frequency below 150 kHz.
2. The resolution bandwidth and video bandwidth of test receiver/spectrum analyzer is 9 kHz or 10 kHz at frequency (150 kHz to 30 MHz).
3. All modes of operation were investigated and the worst-case emissions are reported.

For Radiated emission above 30 MHz

- a. The EUT was placed on the top of a rotating table 0.8 meters above the ground at 3 meter chamber room for test. The table was rotated 360 degrees to determine the position of the highest radiation.
- b. The EUT was set 3 meters away from the interference-receiving antenna, which was mounted on the top of a variable-height antenna tower.
- c. The height of antenna is varied from one meter to four meters above the ground to determine the maximum value of the field strength. Both horizontal and vertical polarizations of the antenna are set to make the measurement.
- d. For each suspected emission, the EUT was arranged to its worst case and then the antenna was tuned to heights from 1 meter to 4 meters and the rotatable table was turned from 0 degrees to 360 degrees to find the maximum reading.
- e. The test-receiver system was set to quasi-peak detect function and specified bandwidth with maximum hold mode when the test frequency is below 1 GHz.

Notes:

1. The resolution bandwidth and video bandwidth of test receiver/spectrum analyzer is 120 kHz for Quasi-peak detection (QP) at frequency below 1 GHz.
2. All modes of operation were investigated and the worst-case emissions are reported.

6.7 Unwanted Emissions above 1 GHz

6.7.1 Test Setup

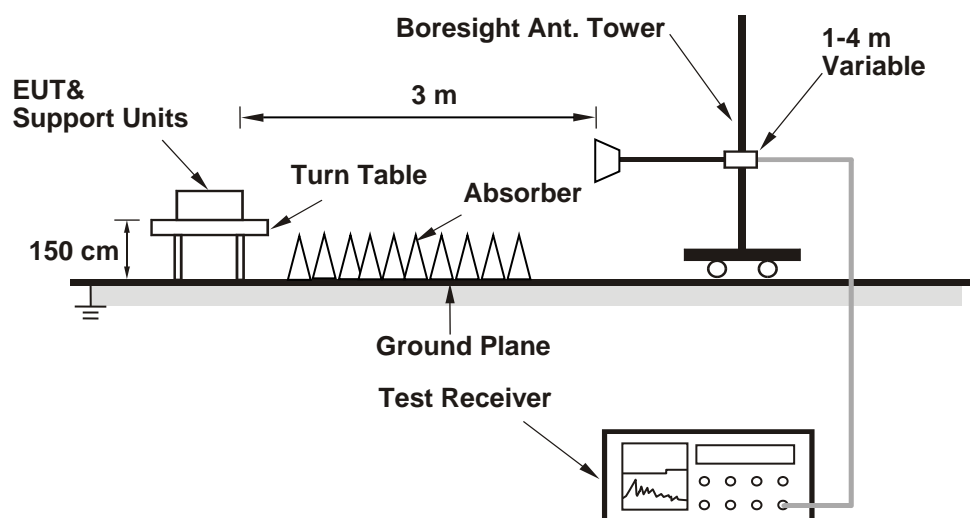

For the actual test configuration, please refer to the attached file (Test Setup Photo).

6.7.2 Test Procedure

- The EUT was placed on the top of a rotating table 1.5 meters above the ground at 3 meter chamber room for test. The table was rotated 360 degrees to determine the position of the highest radiation.
- The EUT was set 3 meters away from the interference-receiving antenna, which was mounted on the top of a variable-height antenna tower.
- The height of antenna is varied from one meter to four meters above the ground to determine the maximum value of the field strength. Both horizontal and vertical polarizations of the antenna are set to make the measurement.
- For each suspected emission, the EUT was arranged to its worst case and then the antenna was tuned to heights from 1 meter to 4 meters and the rotatable table was turned from 0 degrees to 360 degrees to find the maximum reading.
- The test-receiver system was set to peak and average detects function and specified bandwidth with maximum hold mode when the test frequency is above 1 GHz. If the peak reading value also meets average limit, measurement with the average detector is unnecessary.

Notes:

- The resolution bandwidth of test receiver/spectrum analyzer is 1 MHz and the video bandwidth is 3 MHz for Peak detection (PK) and Average detection (AV) at frequency above 1 GHz.
- For fundamental and harmonic signal measurement, the resolution bandwidth of test receiver/spectrum analyzer is 1 MHz and the video bandwidth is $\geq 1/T$ (Duty cycle $< 98\%$) or 10 Hz (Duty cycle $\geq 98\%$) for Average detection (AV) at frequency above 1 GHz.
- All modes of operation were investigated and the worst-case emissions are reported.

7 Test Results of Test Item

7.1 RF Output Power

Input Power:	3.3 Vdc	Environmental Conditions:	25°C, 65% RH	Tested By:	Katina Lu
--------------	---------	---------------------------	--------------	------------	-----------

802.11be (EHT) 26-tone RU

Chan.	Chan. Freq. (MHz)	Average Power (dBm)		Total Power (mW)	Total Power (dBm)	Power Limit (dBm)	Test Result
		Chain 0	Chain 1				
1	2412	16.71	16.57	92.275	19.65	30	Pass
6	2437	21.36	21.43	275.768	24.41	30	Pass
11	2462	15.75	15.54	73.393	18.66	30	Pass
12	2467	14.48	14.17	54.176	17.34	30	Pass
13	2472	13.54	12.97	42.41	16.27	30	Pass

Notes:

1. Directional gain is the maximum gain of antennas.
2. The maximum gain is 3.18 dBi < 6 dBi, so the output power limit shall not be reduced.

802.11be (EHT) 52-tone RU

Chan.	Chan. Freq. (MHz)	Average Power (dBm)		Total Power (mW)	Total Power (dBm)	Power Limit (dBm)	Test Result
		Chain 0	Chain 1				
1	2412	17.22	17.18	104.963	20.21	30	Pass
6	2437	21.53	21.35	278.691	24.45	30	Pass
11	2462	16.61	16.31	88.57	19.47	30	Pass
12	2467	14.30	14.22	53.339	17.27	30	Pass
13	2472	12.37	12.23	33.969	15.31	30	Pass

Notes:

1. Directional gain is the maximum gain of antennas.
2. The maximum gain is 3.18 dBi < 6 dBi, so the output power limit shall not be reduced.

802.11be (EHT) 106-tone RU

Chan.	Chan. Freq. (MHz)	Average Power (dBm)		Total Power (mW)	Total Power (dBm)	Power Limit (dBm)	Test Result
		Chain 0	Chain 1				
1	2412	17.59	17.36	111.862	20.49	30	Pass
6	2437	21.48	21.35	277.063	24.43	30	Pass
11	2462	16.77	16.58	93.032	19.69	30	Pass
12	2467	14.73	14.49	57.836	17.62	30	Pass
13	2472	12.42	12.05	33.491	15.25	30	Pass

Notes:

1. Directional gain is the maximum gain of antennas.
2. The maximum gain is 3.18 dBi < 6 dBi, so the output power limit shall not be reduced.

802.11be (EHT 20M) 52+26-tone MRU

Chan.	Chan. Freq. (MHz)	Average Power (dBm)		Total Power (mW)	Total Power (dBm)	Power Limit (dBm)	Test Result
		Chain 0	Chain 1				
1	2412	16.69	16.42	90.519	19.57	30	Pass
11	2462	17.43	17.32	109.286	20.39	30	Pass
12	2467	15.47	15.16	68.047	18.33	30	Pass
13	2472	13.86	13.29	45.652	16.59	30	Pass

Notes:

1. Directional gain is the maximum gain of antennas.
2. The maximum gain is 3.18 dBi < 6 dBi, so the output power limit shall not be reduced.

802.11be (EHT 20M) 106+26-tone MRU

Chan.	Chan. Freq. (MHz)	Average Power (dBm)		Total Power (mW)	Total Power (dBm)	Power Limit (dBm)	Test Result
		Chain 0	Chain 1				
1	2412	16.15	15.74	78.707	18.96	30	Pass
11	2462	17.38	17.17	106.821	20.29	30	Pass
12	2467	14.80	14.53	58.579	17.68	30	Pass
13	2472	12.19	11.97	32.298	15.09	30	Pass

Notes:

1. Directional gain is the maximum gain of antennas.
2. The maximum gain is 3.18 dBi < 6 dBi, so the output power limit shall not be reduced.

7.2 Power Spectral Density

Input Power:	3.3 Vdc	Environmental Conditions:	25°C, 65% RH	Tested By:	Katina Lu
--------------	---------	---------------------------	--------------	------------	-----------

802.11be (EHT) 26-tone RU

Chan.	Chan. Freq. (MHz)	PSD w/o Duty Factor (dBm/3kHz)		Duty Factor (dB)	Total PSD (dBm/3kHz)	PSD Limit (dBm/3kHz)	Test Result
		Chain 0	Chain 1				
1	2412	-9.78	-8.92	0.77	-5.55	7.81	Pass
6	2437	-3.80	-3.02	0.77	0.39	7.81	Pass
11	2462	-10.69	-9.43	0.77	-6.23	7.81	Pass
12	2467	-11.63	-11.53	0.77	-7.80	7.81	Pass
13	2472	-12.96	-13.11	0.77	-9.25	7.81	Pass

Notes:

- Method E) 2) b) Measure and sum spectral maxima across the outputs of KDB 662911 is using for calculating total power density.
- Directional gain = gain of antenna element + 10 log (2 of TX antenna elements)
- The directional gain is 6.19 dBi > 6 dBi, so the power density limit shall be reduced to $8 - (6.19 - 6) = 7.81$ dBm/3kHz.

802.11be (EHT) 52-tone RU

Chan.	Chan. Freq. (MHz)	PSD w/o Duty Factor (dBm/3kHz)		Duty Factor (dB)	Total PSD (dBm/3kHz)	PSD Limit (dBm/3kHz)	Test Result
		Chain 0	Chain 1				
1	2412	-9.78	-9.59	0.91	-5.77	7.81	Pass
6	2437	-4.89	-5.89	0.91	-1.45	7.81	Pass
11	2462	-10.66	-11.03	0.91	-6.93	7.81	Pass
12	2467	-12.53	-13.08	0.91	-8.88	7.81	Pass
13	2472	-15.08	-15.83	0.91	-11.52	7.81	Pass

Notes:

- Method E) 2) b) Measure and sum spectral maxima across the outputs of KDB 662911 is using for calculating total power density.
- Directional gain = gain of antenna element + 10 log (2 of TX antenna elements)
- The directional gain is 6.19 dBi > 6 dBi, so the power density limit shall be reduced to $8 - (6.19 - 6) = 7.81$ dBm/3kHz.

802.11be (EHT) 106-tone RU

Chan.	Chan. Freq. (MHz)	PSD w/o Duty Factor (dBm/3kHz)		Duty Factor (dB)	Total PSD (dBm/3kHz)	PSD Limit (dBm/3kHz)	Test Result
		Chain 0	Chain 1				
1	2412	-13.96	-13.78	1.02	-9.84	7.81	Pass
6	2437	-9.94	-8.60	1.02	-5.19	7.81	Pass
11	2462	-13.94	-13.48	1.02	-9.68	7.81	Pass
12	2467	-15.91	-15.86	1.02	-11.86	7.81	Pass
13	2472	-17.78	-19.57	1.02	-14.56	7.81	Pass

Notes:

- Method E) 2) b) Measure and sum spectral maxima across the outputs of KDB 662911 is using for calculating total power density.
- Directional gain = gain of antenna element + 10 log (2 of TX antenna elements)
- The directional gain is 6.19 dBi > 6 dBi, so the power density limit shall be reduced to $8-(6.19-6) = 7.81$ dBm/3kHz.

802.11be (EHT 20M) 52+26-tone MRU

Chan.	Chan. Freq. (MHz)	PSD w/o Duty Factor (dBm/3kHz)		Duty Factor (dB)	Total PSD (dBm/3kHz)	PSD Limit (dBm/3kHz)	Test Result
		Chain 0	Chain 1				
1	2412	-11.16	-11.50	0.77	-7.54	7.81	Pass
11	2462	-11.55	-12.11	0.77	-8.04	7.81	Pass
12	2467	-13.73	-13.94	0.77	-10.05	7.81	Pass
13	2472	-15.52	-15.03	0.77	-11.48	7.81	Pass

Notes:

- Method E) 2) b) Measure and sum spectral maxima across the outputs of KDB 662911 is using for calculating total power density.
- Directional gain = gain of antenna element + 10 log (2 of TX antenna elements)
- The directional gain is 6.19 dBi > 6 dBi, so the power density limit shall be reduced to $8-(6.19-6) = 7.81$ dBm/3kHz.

802.11be (EHT 20M) 106+26-tone MRU

Chan.	Chan. Freq. (MHz)	PSD w/o Duty Factor (dBm/3kHz)		Duty Factor (dB)	Total PSD (dBm/3kHz)	PSD Limit (dBm/3kHz)	Test Result
		Chain 0	Chain 1				
1	2412	-15.21	-15.49	0.89	-11.45	7.81	Pass
11	2462	-13.19	-14.02	0.89	-9.68	7.81	Pass
12	2467	-14.85	-16.56	0.89	-11.72	7.81	Pass
13	2472	-18.14	-18.76	0.89	-14.54	7.81	Pass

Notes:

- Method E) 2) b) Measure and sum spectral maxima across the outputs of KDB 662911 is using for calculating total power density.
- Directional gain = gain of antenna element + 10 log (2 of TX antenna elements)
- The directional gain is 6.19 dBi > 6 dBi, so the power density limit shall be reduced to $8-(6.19-6) = 7.81$ dBm/3kHz.



Spectrum Plot of Maximum Value

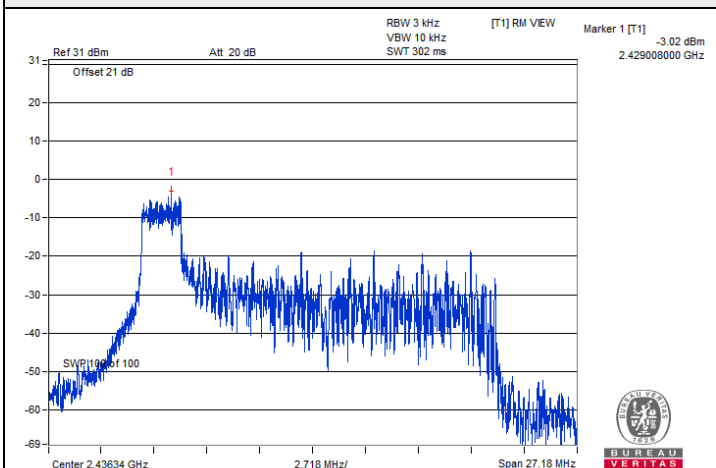

802.11be (EHT) 26-tone RU / Chain 1 : CH 6@0

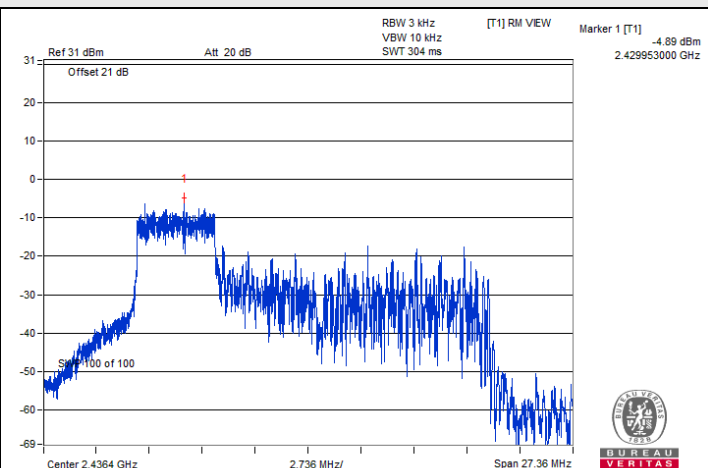

802.11be (EHT) 52-tone RU / Chain 0 : CH 6@37

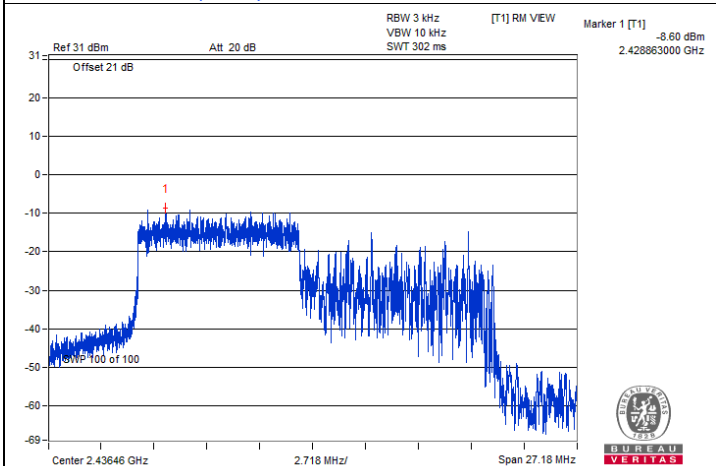

802.11be (EHT) 106-tone RU / Chain 1 : CH 6@53

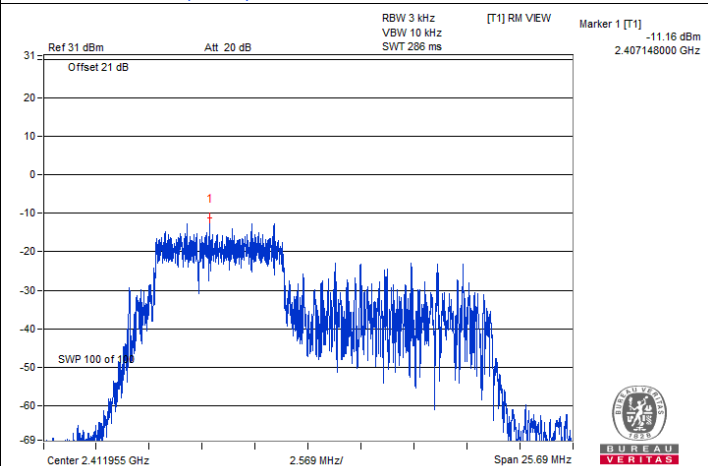

802.11be (EHT 20M) 52+26-tone MRU / Chain 0 : CH 1@70

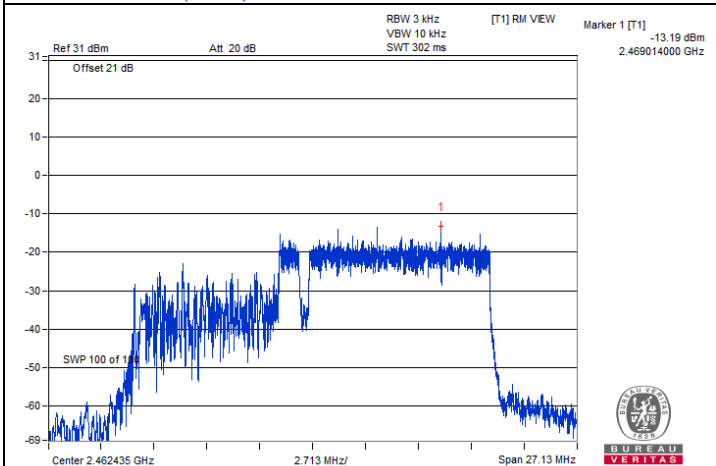

802.11be (EHT 20M) 106+26-tone MRU / Chain 0 : CH 11@83

7.3 6 dB Bandwidth

Input Power:	3.3 Vdc	Environmental Conditions:	25°C, 65% RH	Tested By:	Katina Lu
--------------	---------	---------------------------	--------------	------------	-----------

802.11be (EHT) 26-tone RU

Channel	Frequency (MHz)	6 dB Bandwidth (MHz)		Minimum Limit (MHz)	Test Result
		Chain 0	Chain 1		
1	2412	2.08	2.11	0.5	Pass
6	2437	2.08	2.11	0.5	Pass
11	2462	2.13	2.08	0.5	Pass
12	2467	2.09	2.10	0.5	Pass
13	2472	2.06	2.06	0.5	Pass

802.11be (EHT) 52-tone RU

Channel	Frequency (MHz)	6 dB Bandwidth (MHz)		Minimum Limit (MHz)	Test Result
		Chain 0	Chain 1		
1	2412	17.09	17.08	0.5	Pass
6	2437	17.09	17.07	0.5	Pass
11	2462	15.78	17.02	0.5	Pass
12	2467	17.09	17.06	0.5	Pass
13	2472	17.07	17.04	0.5	Pass

802.11be (EHT) 106-tone RU

Channel	Frequency (MHz)	6 dB Bandwidth (MHz)		Minimum Limit (MHz)	Test Result
		Chain 0	Chain 1		
1	2412	17.18	17.18	0.5	Pass
6	2437	17.21	17.18	0.5	Pass
11	2462	17.18	17.20	0.5	Pass
12	2467	17.18	17.21	0.5	Pass
13	2472	17.17	17.17	0.5	Pass

802.11be (EHT 20M) 52+26-tone MRU

Channel	Frequency (MHz)	6 dB Bandwidth (MHz)		Minimum Limit (MHz)	Test Result
		Chain 0	Chain 1		
1	2412	15.18	15.17	0.5	Pass
11	2462	15.18	15.18	0.5	Pass
12	2467	15.19	15.17	0.5	Pass
13	2472	15.18	15.18	0.5	Pass

802.11be (EHT 20M) 106+26-tone MRU

Channel	Frequency (MHz)	6 dB Bandwidth (MHz)		Minimum Limit (MHz)	Test Result
		Chain 0	Chain 1		
1	2412	17.20	17.20	0.5	Pass
11	2462	17.19	17.22	0.5	Pass
12	2467	17.86	17.23	0.5	Pass
13	2472	17.16	17.21	0.5	Pass

Spectrum Plot of Minimum Value

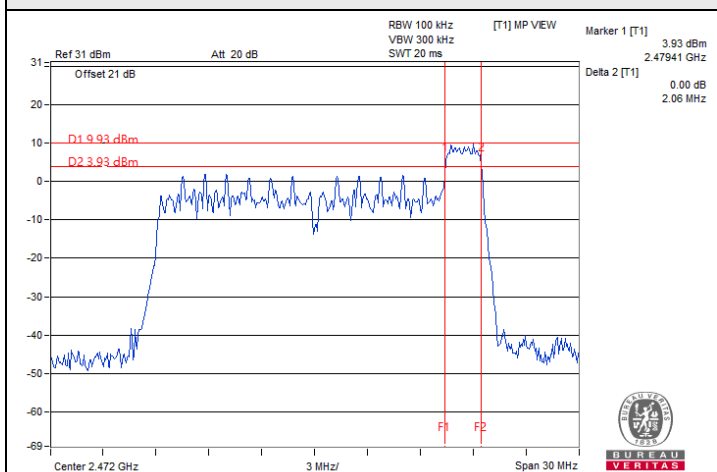

802.11be (EHT) 26-tone RU / Chain 0 : CH 13@8

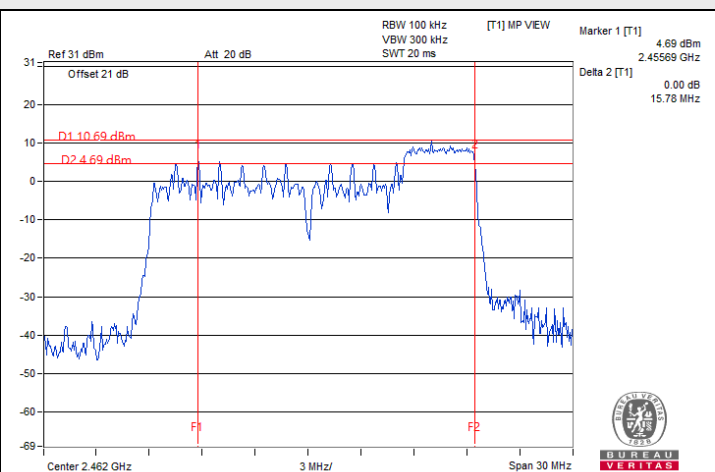

802.11be (EHT) 52-tone RU / Chain 0 : CH 11@40

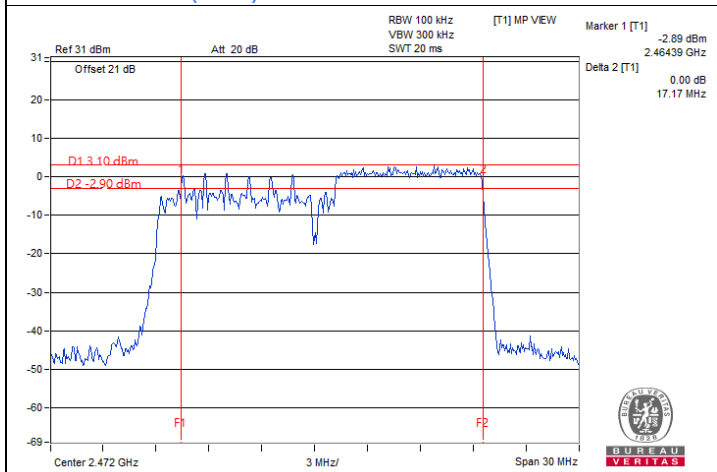

802.11be (EHT) 106-tone RU / Chain 0 : CH 13@54

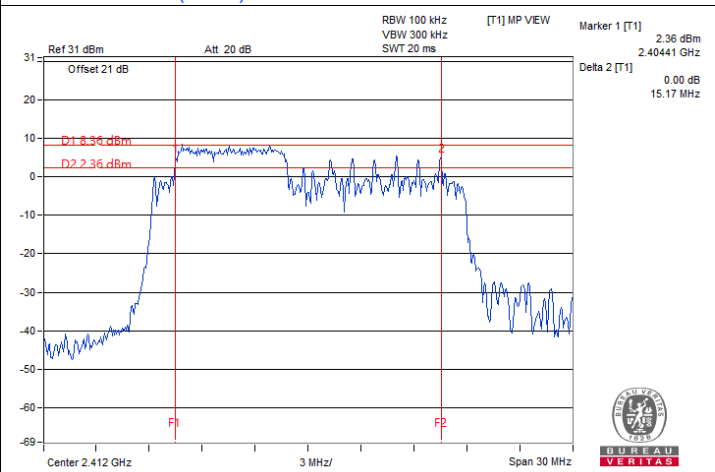

802.11be (EHT 20M) 52+26-tone MRU / Chain 1 : CH 1@70

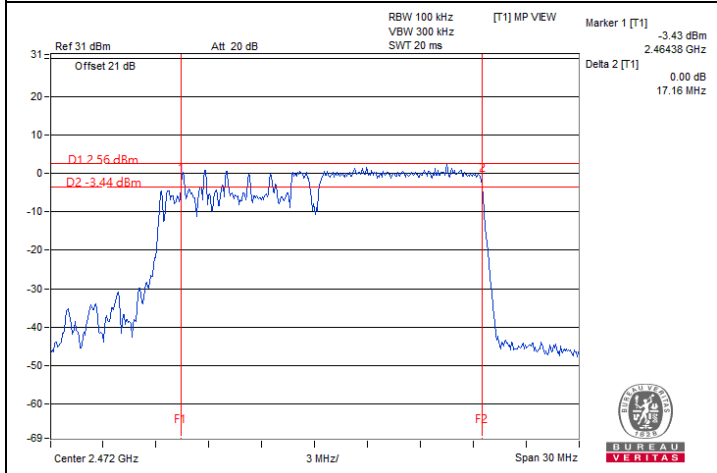

802.11be (EHT 20M) 106+26-tone MRU / Chain 0 : CH 13@83



7.4 Conducted Out of Band Emissions

Input Power:	3.3 Vdc	Environmental Conditions:	25°C, 65% RH	Tested By:	Katina Lu
--------------	---------	---------------------------	--------------	------------	-----------

802.11be (EHT) 26-tone RU

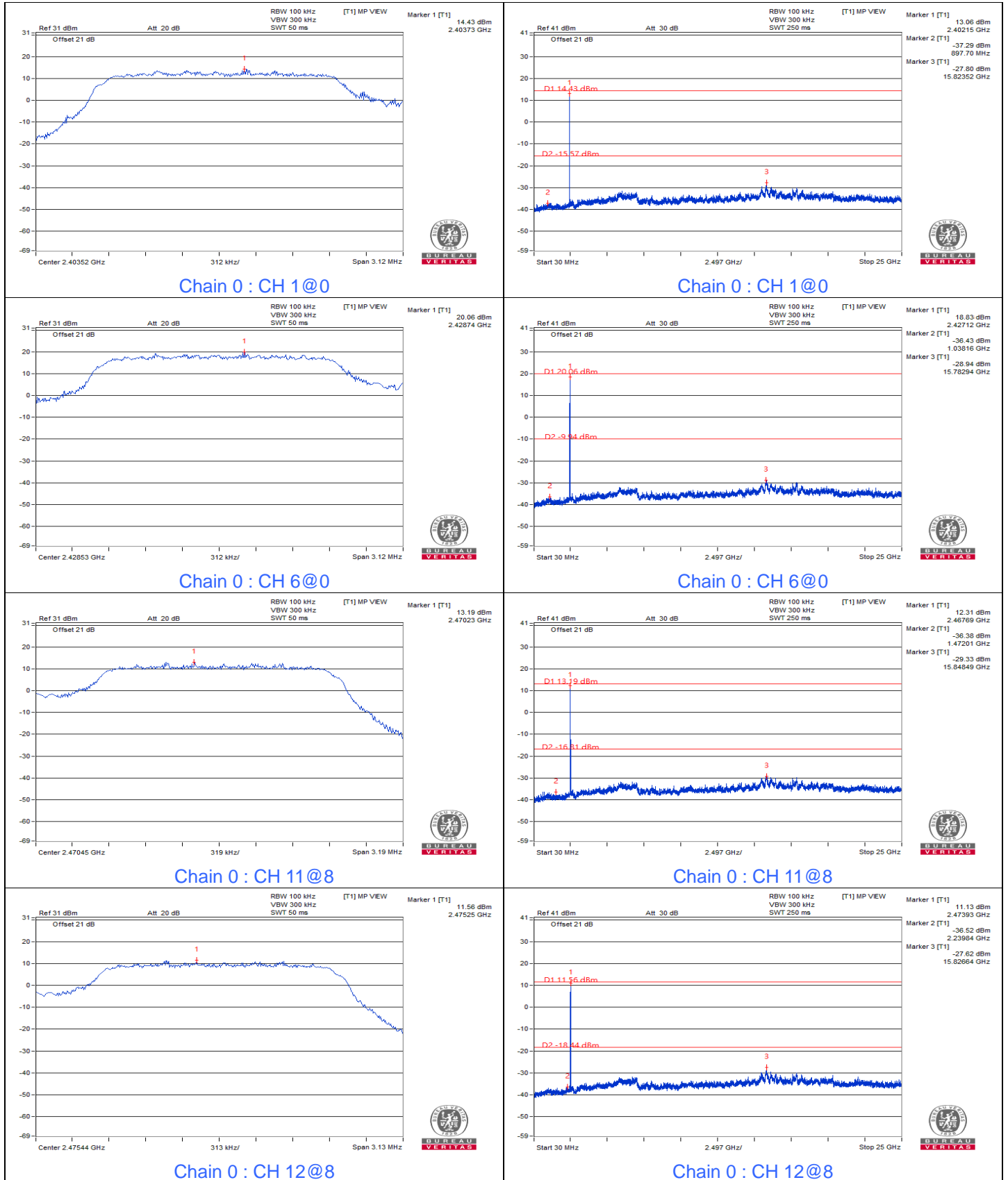

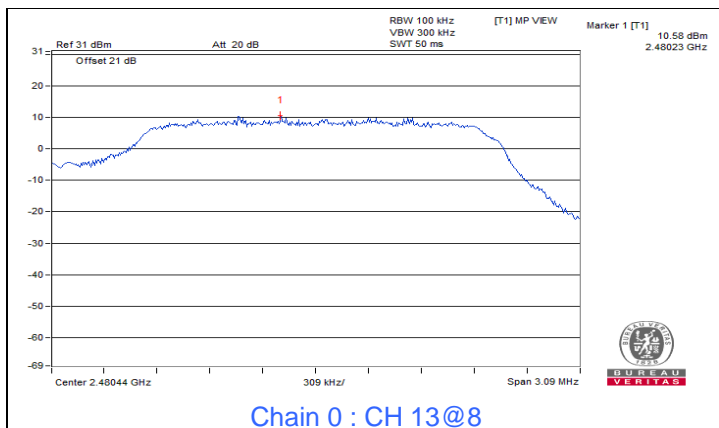

Chain 0 : CH 13@8

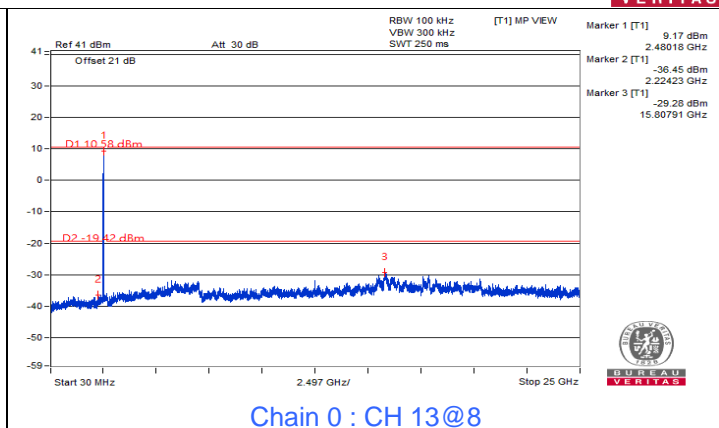

Chain 0 : CH 13@8

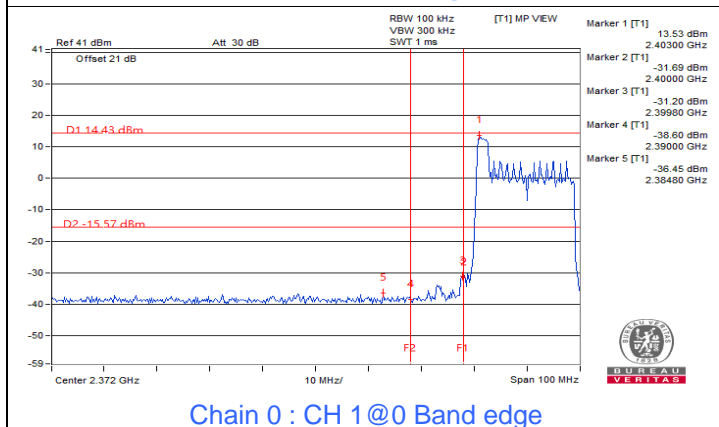

Chain 0 : CH 1@0 Band edge

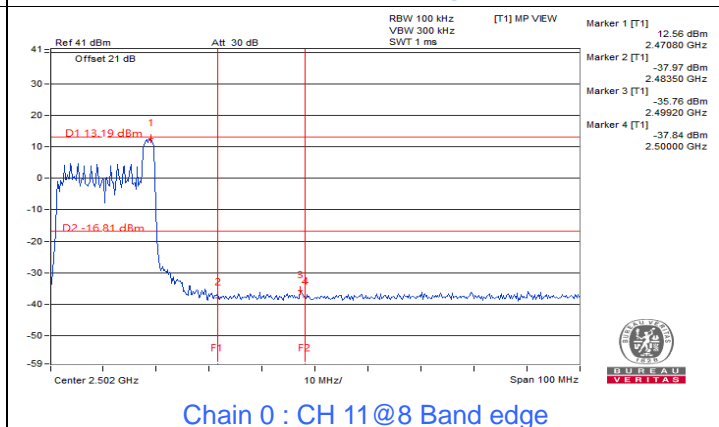

Chain 0 : CH 11@8 Band edge

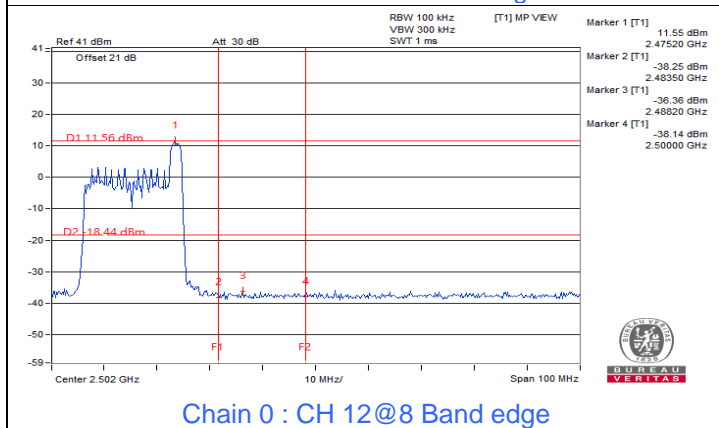

Chain 0 : CH 12@8 Band edge

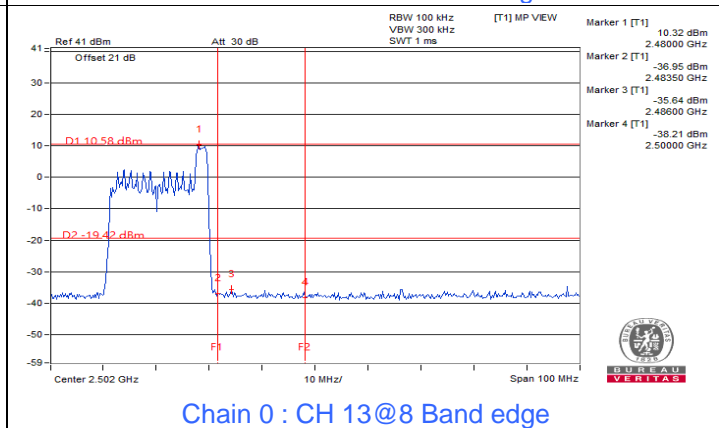

Chain 0 : CH 13@8 Band edge

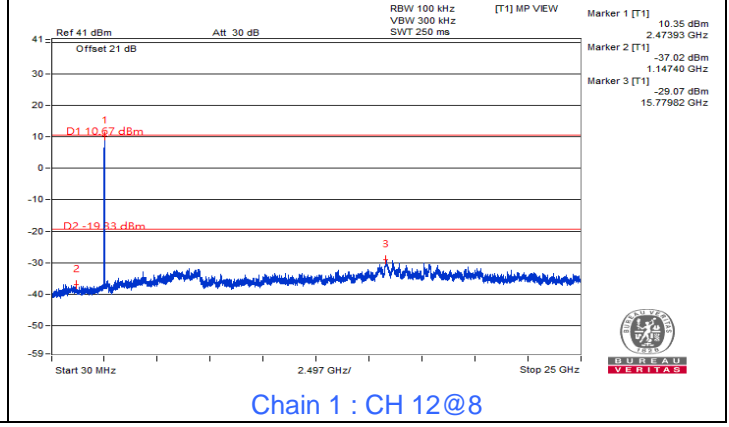
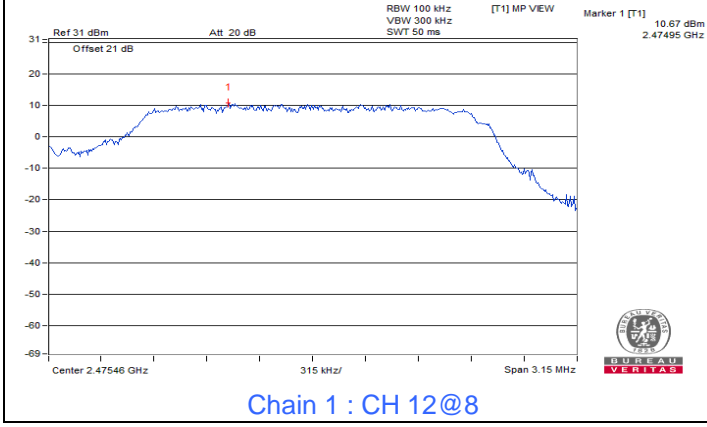
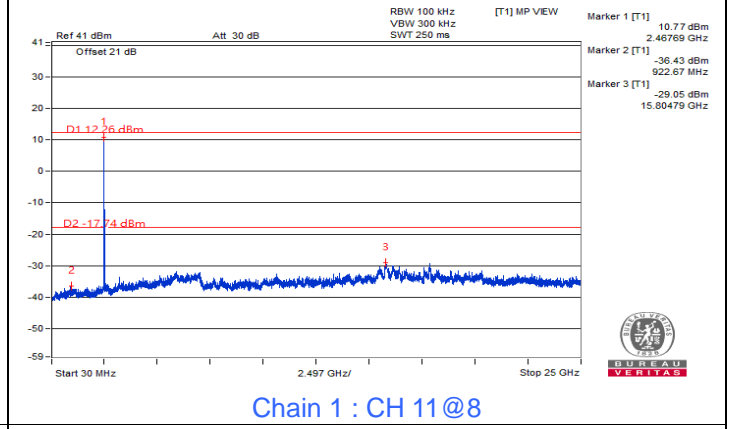
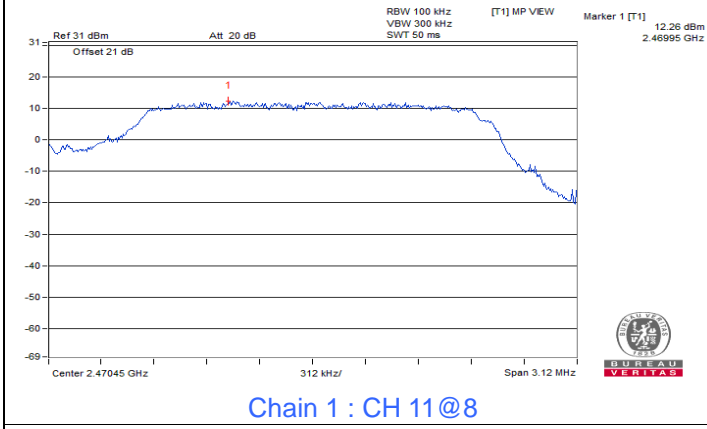
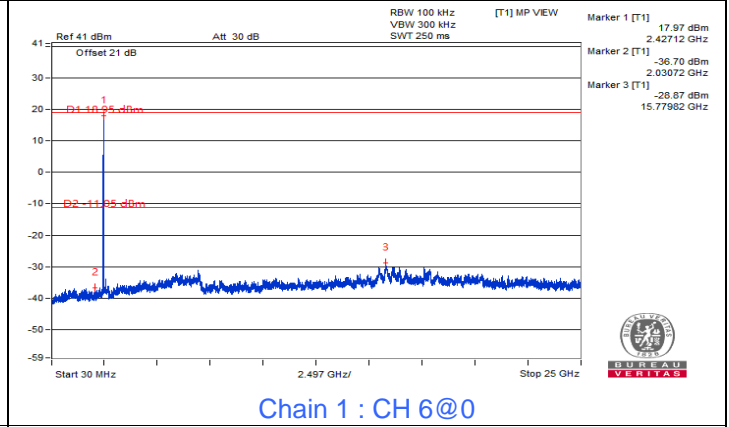
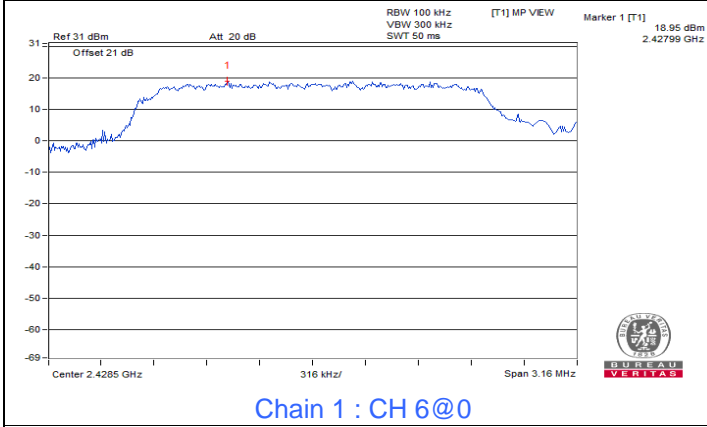
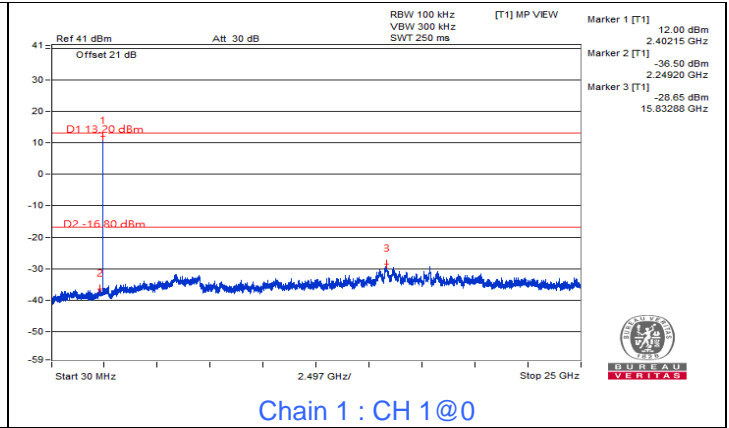
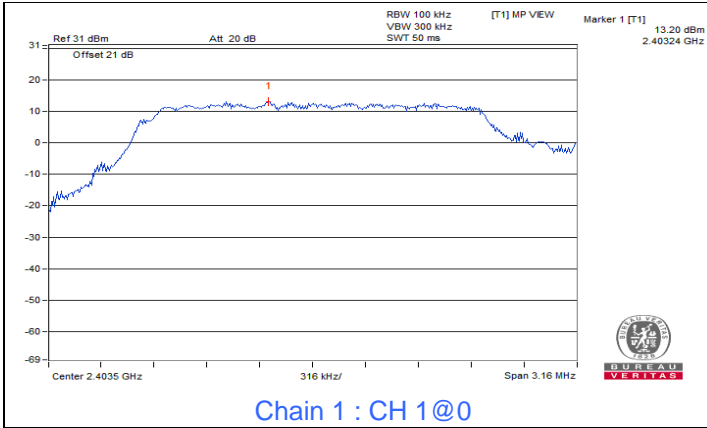

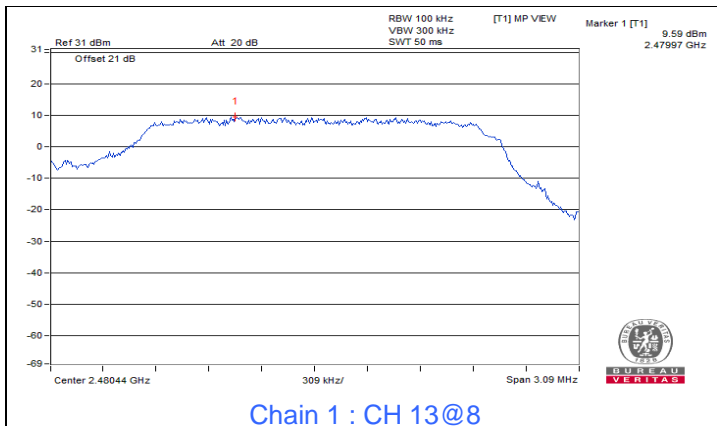

Chain 1 : CH 13@8

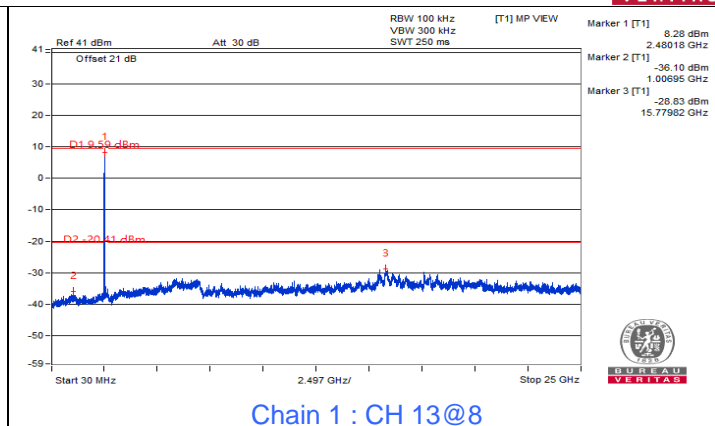

Chain 1 : CH 13@8

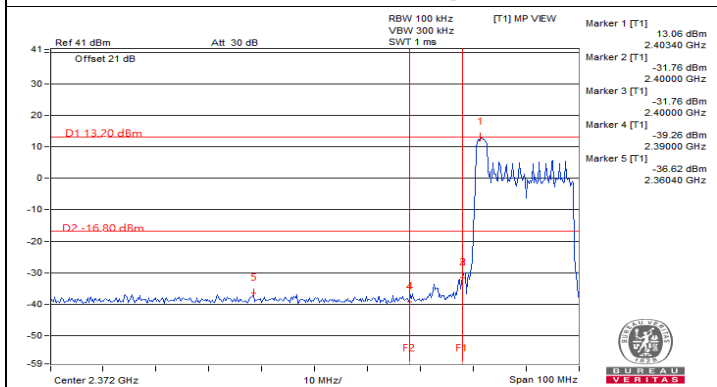

Chain 1 : CH 1@0 Band edge

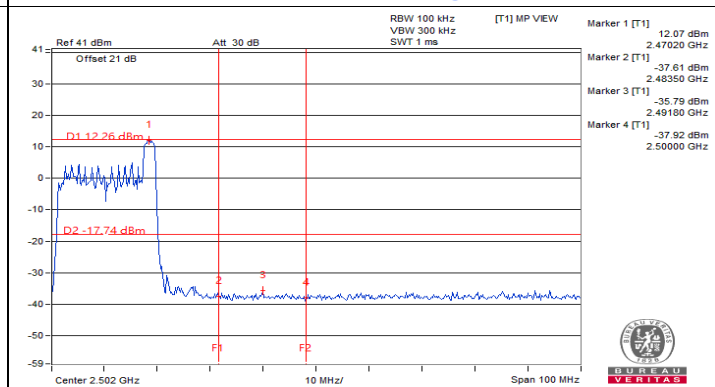

Chain 1 : CH 11@8 Band edge

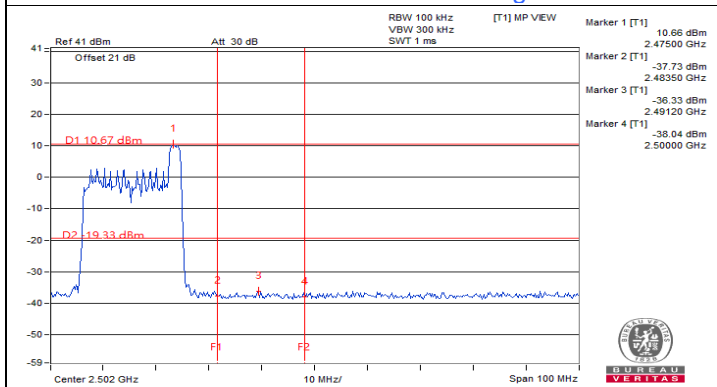

Chain 1 : CH 12@8 Band edge

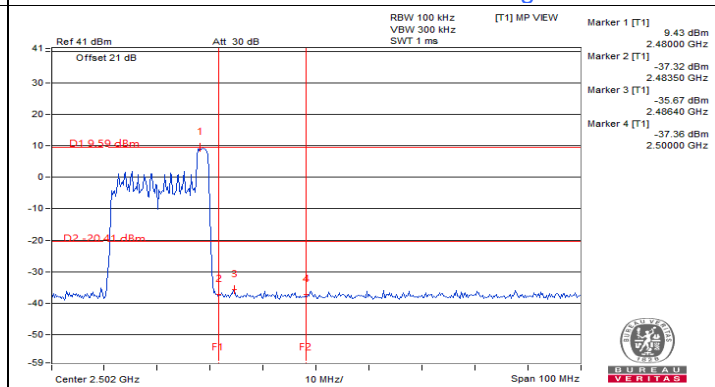

Chain 1 : CH 13@8 Band edge



802.11be (EHT) 52-tone RU

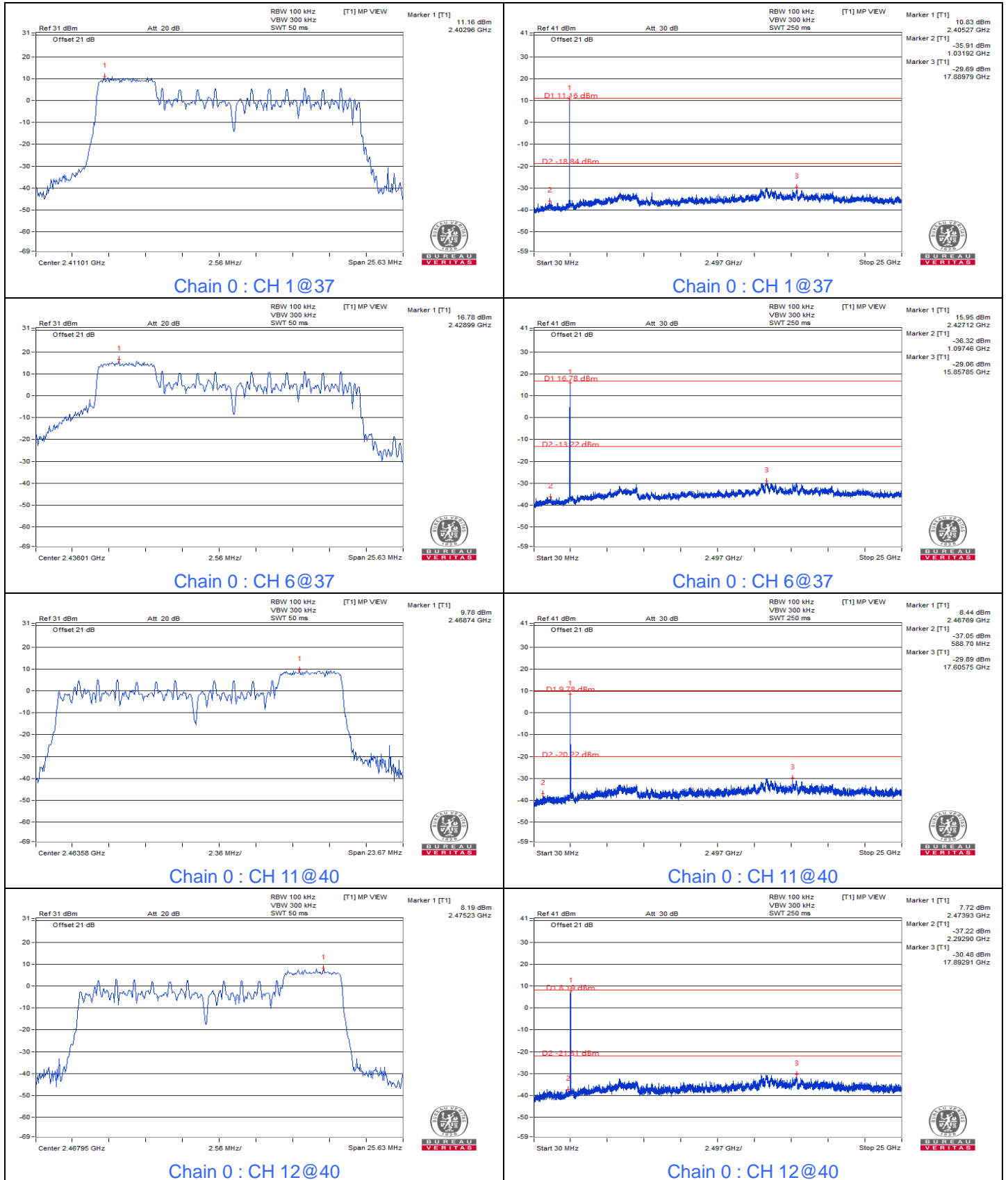

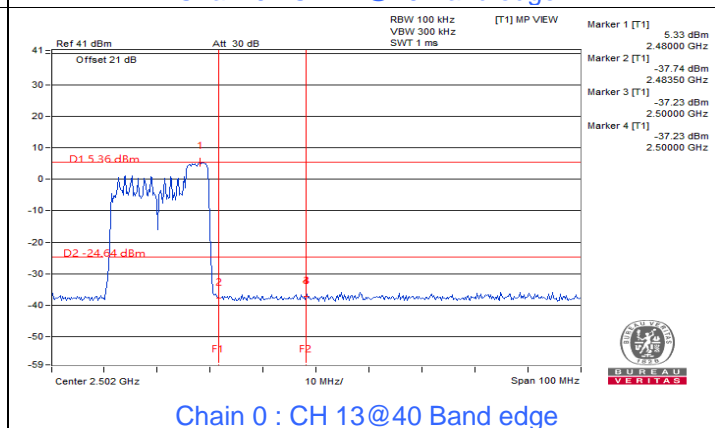
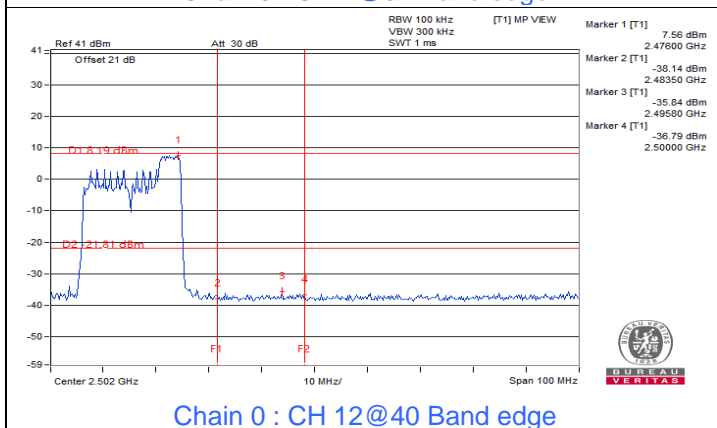
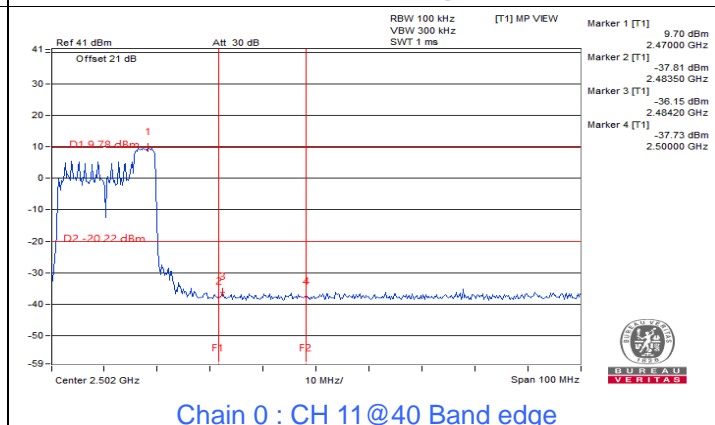
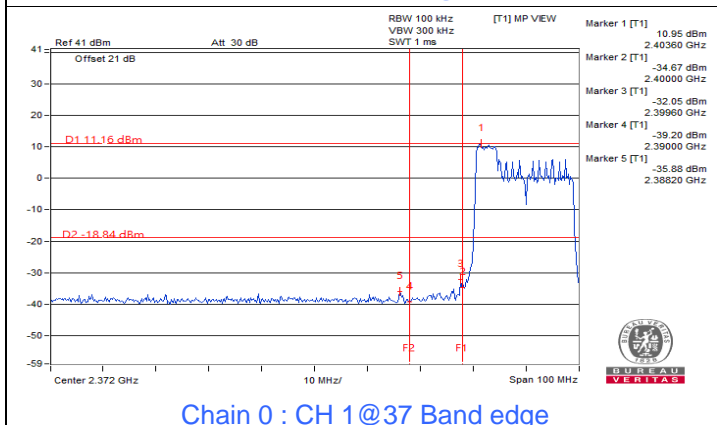
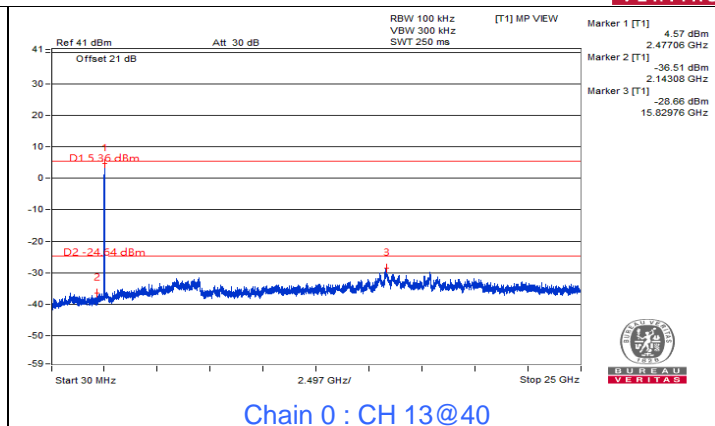
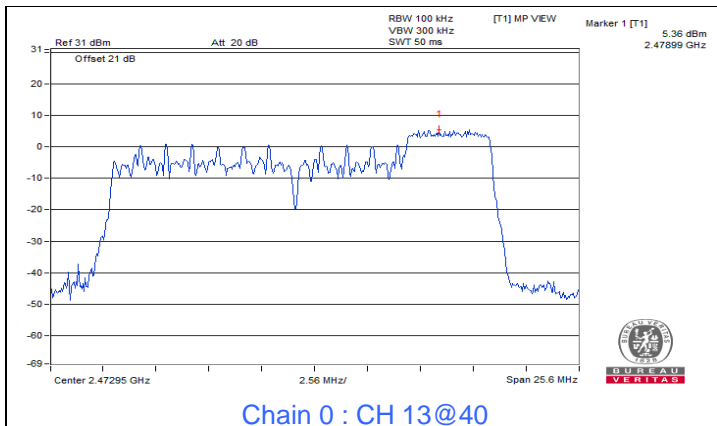

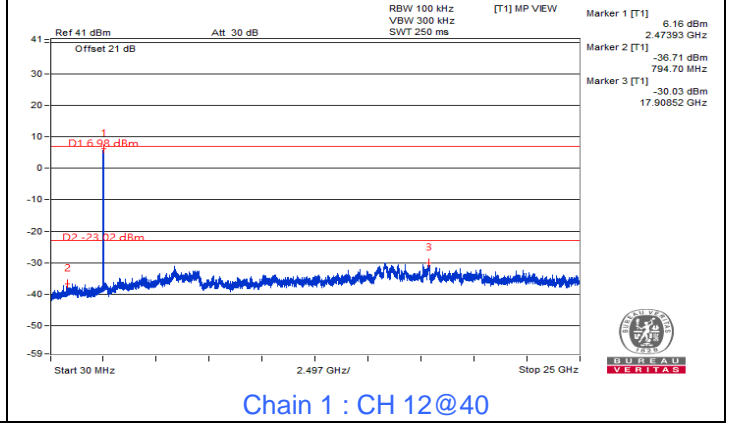
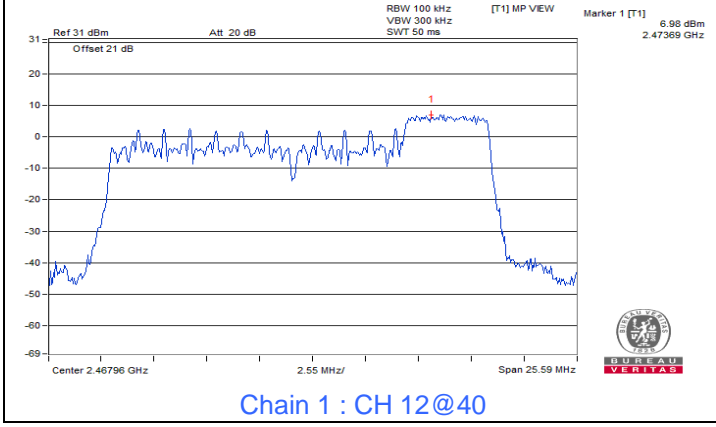
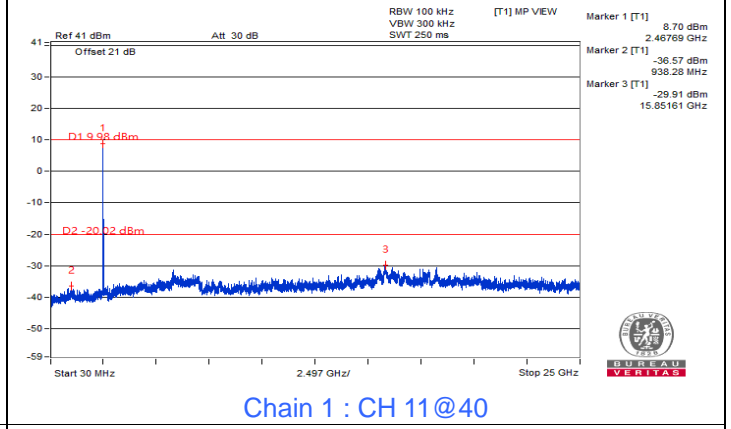
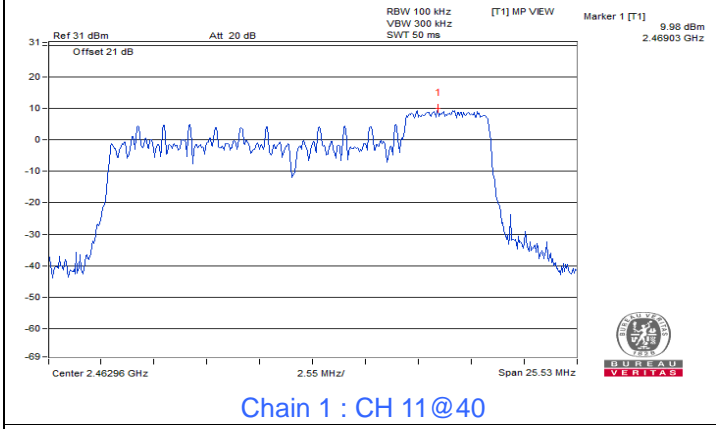
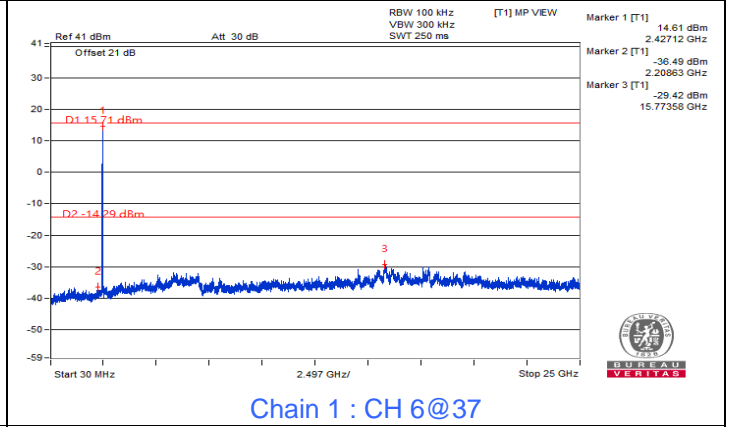
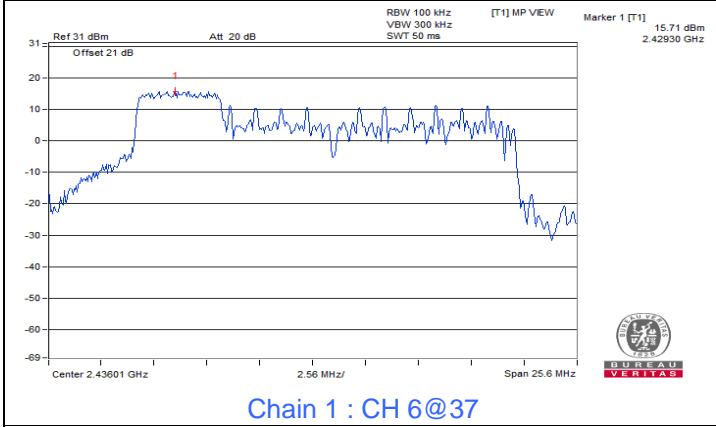
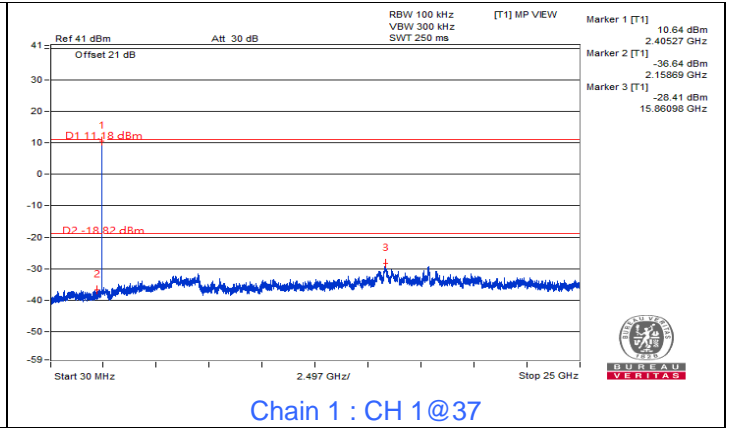
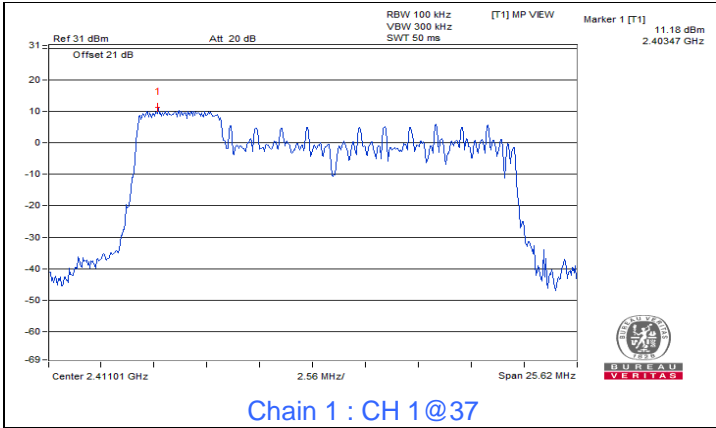

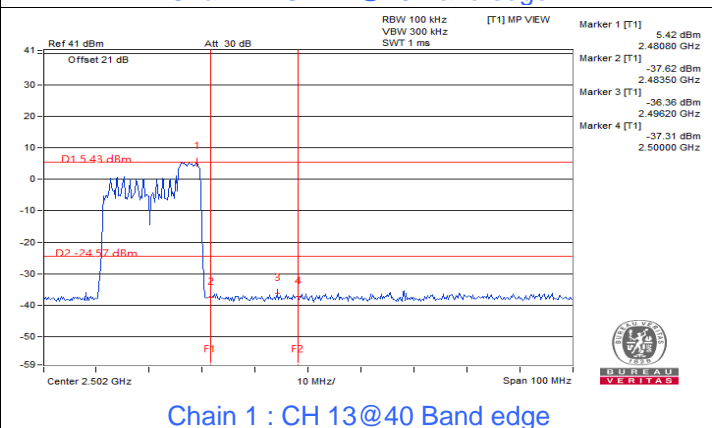
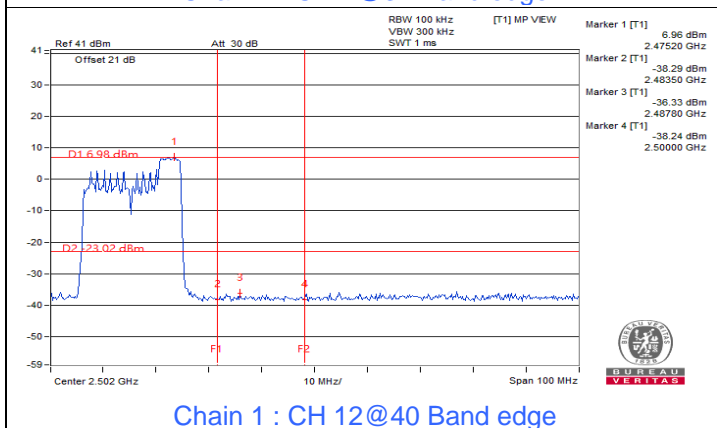
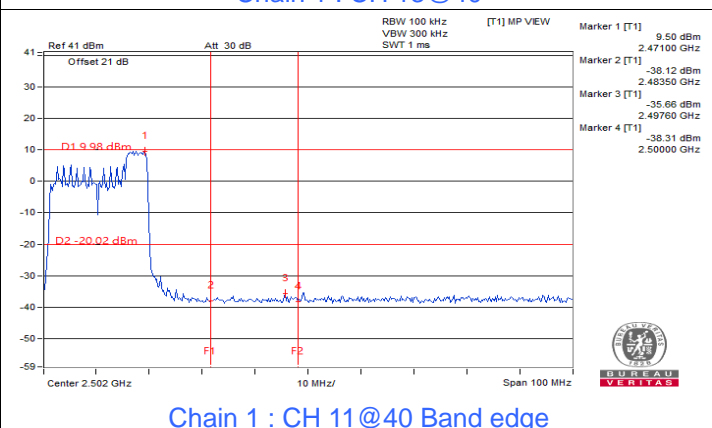
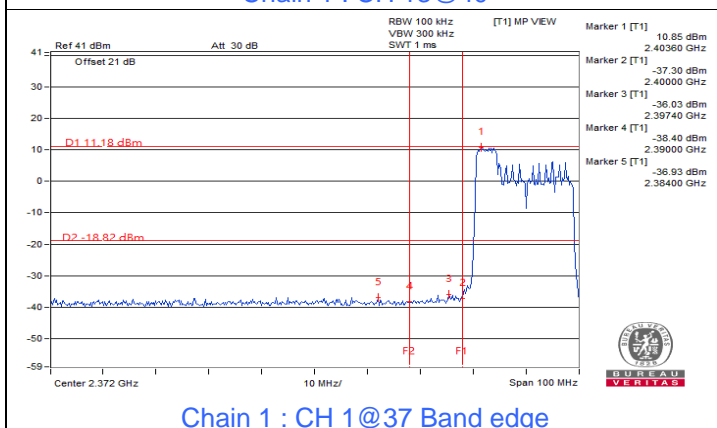
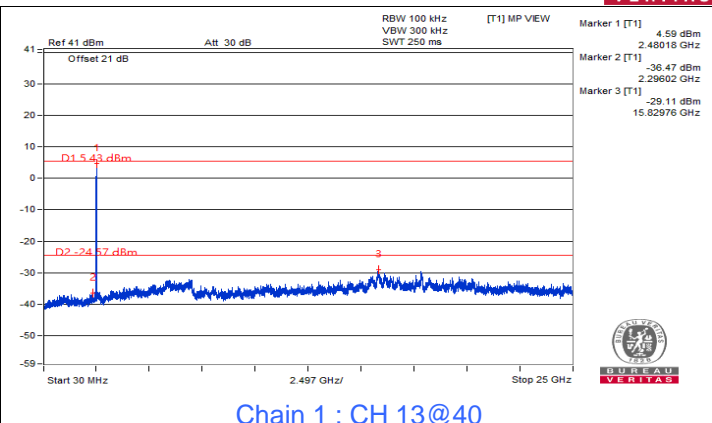
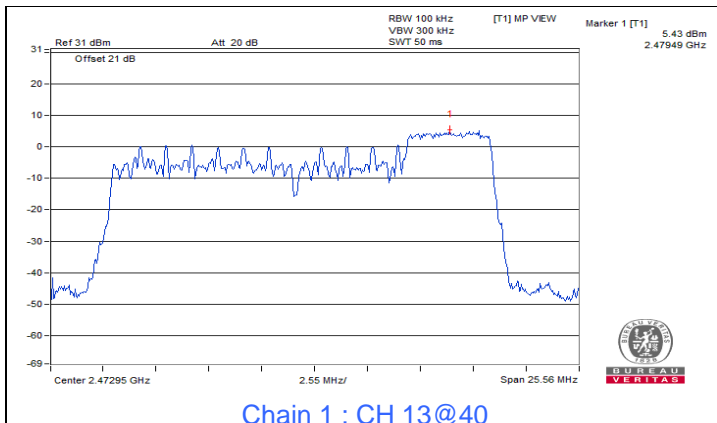



802.11be (EHT) 106-tone RU

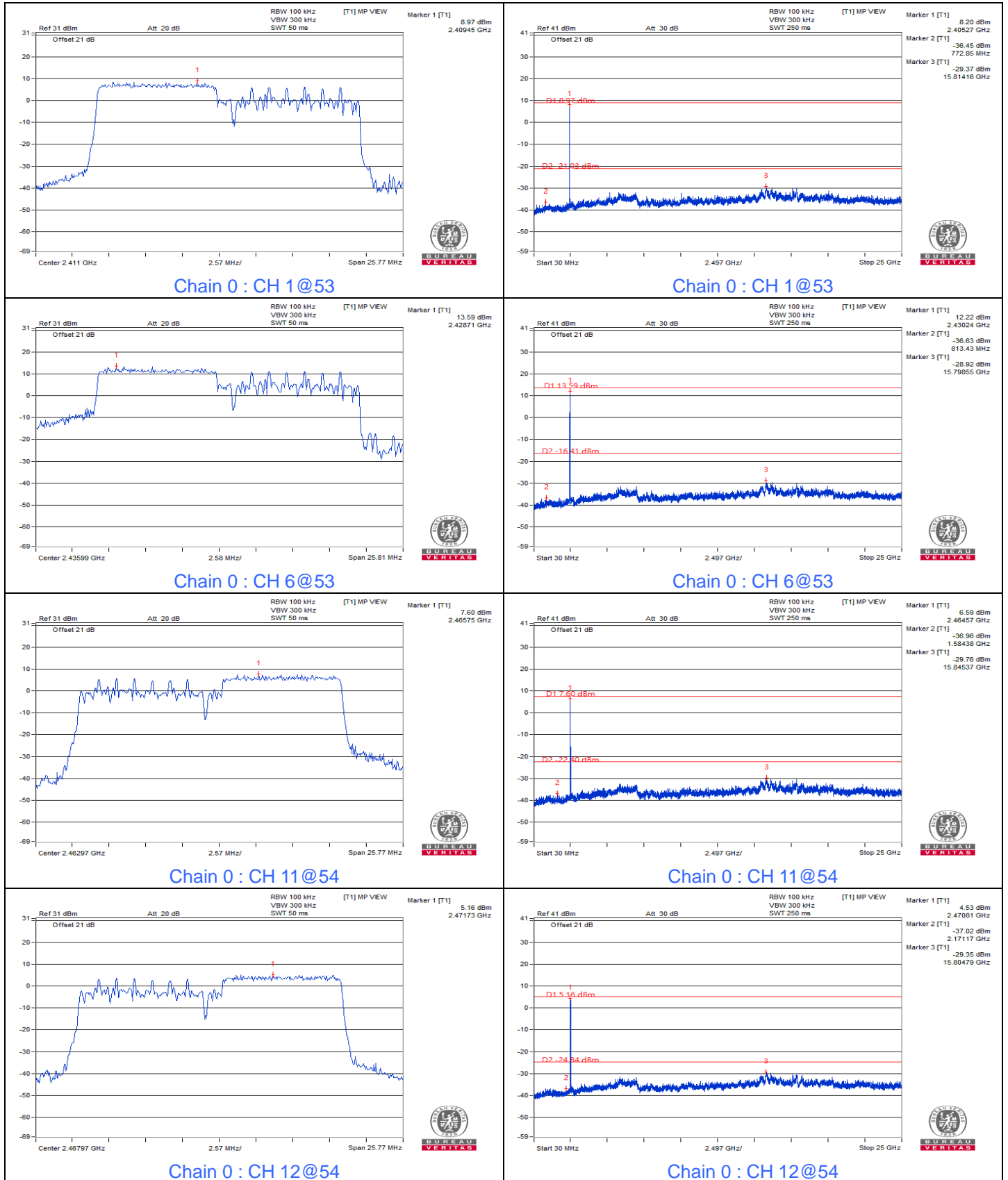

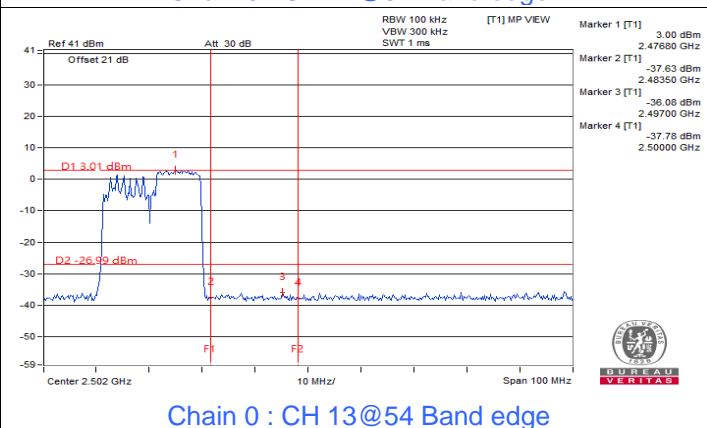
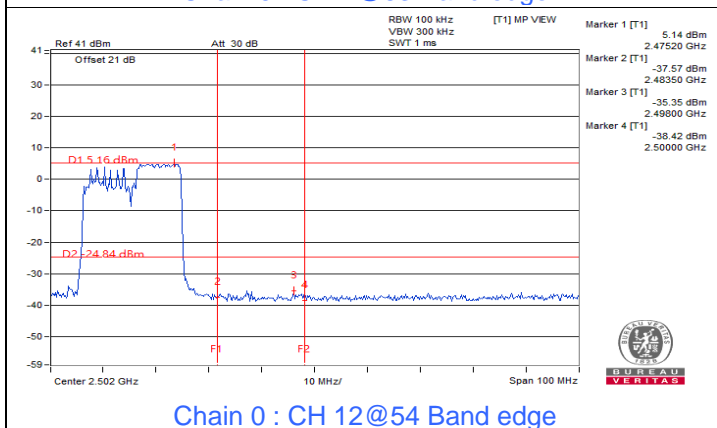
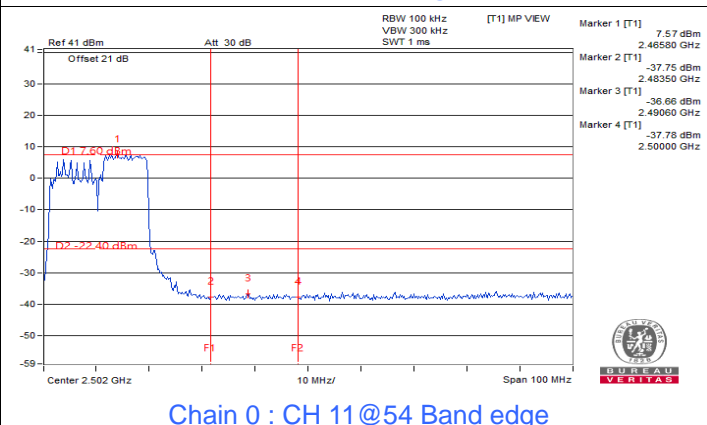
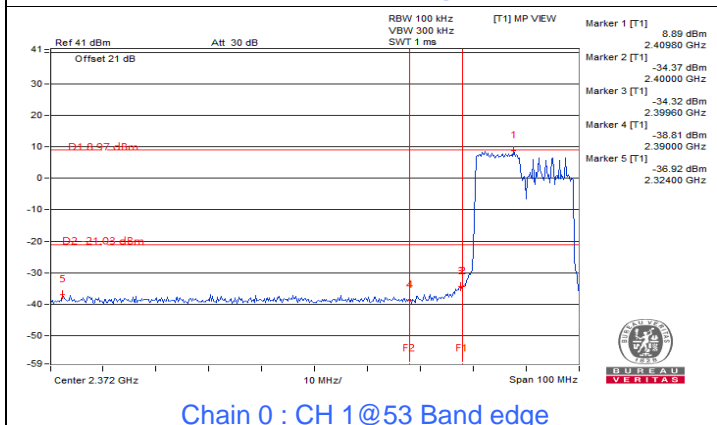
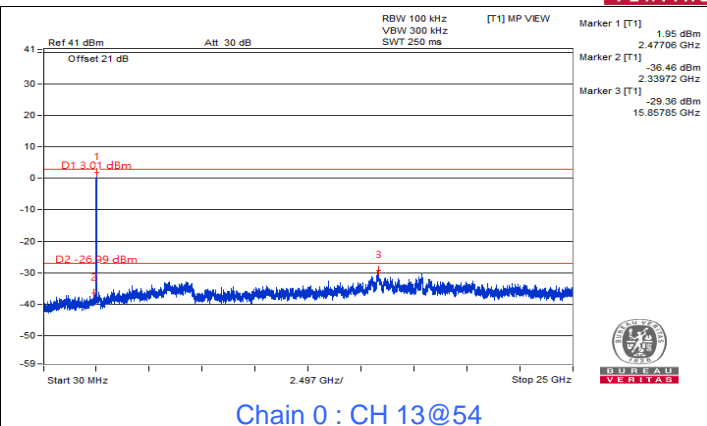
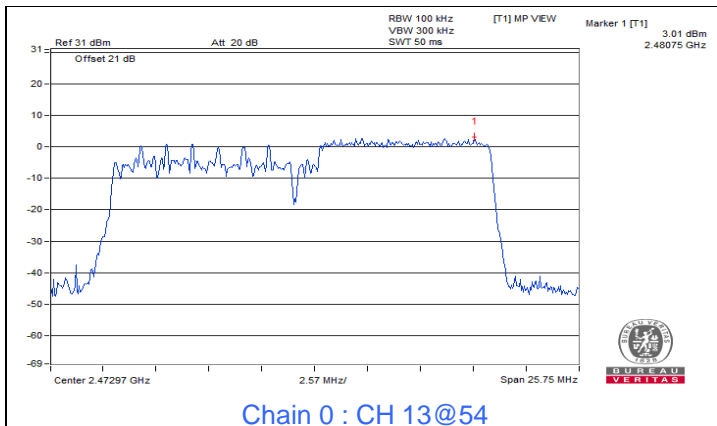

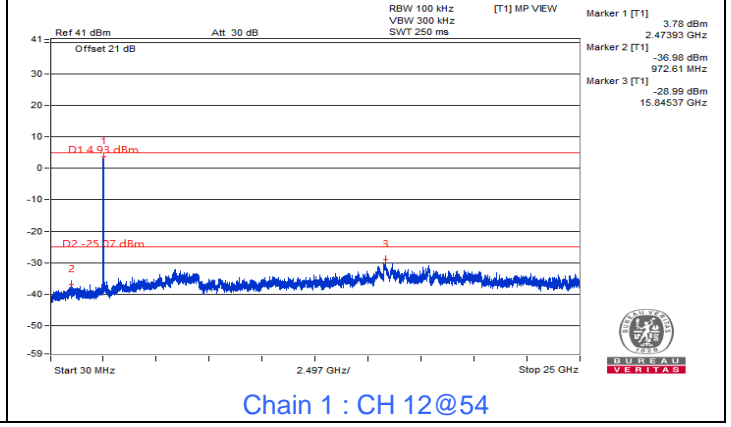
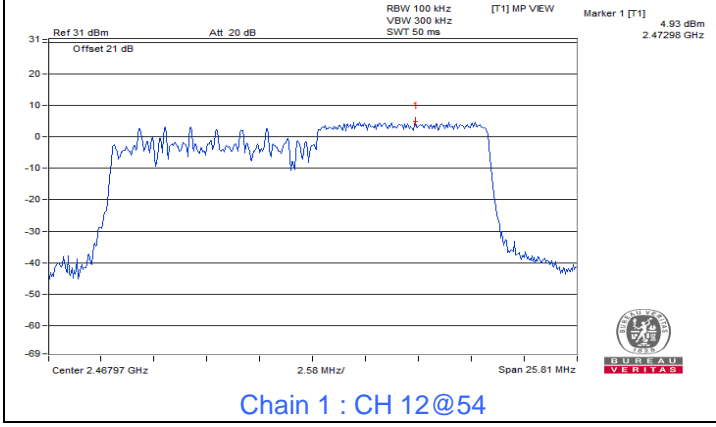
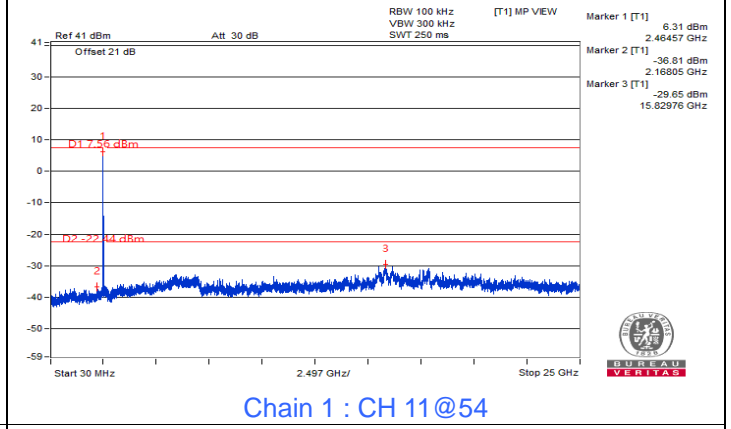
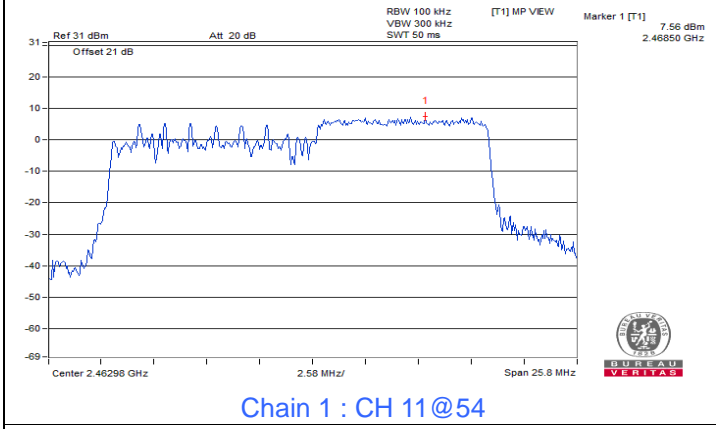
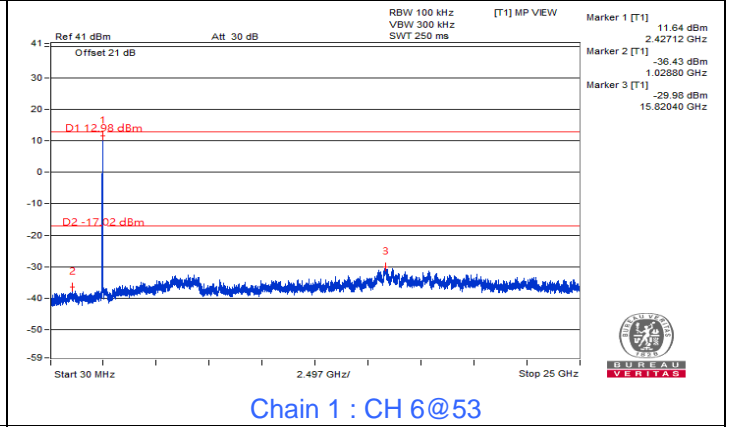
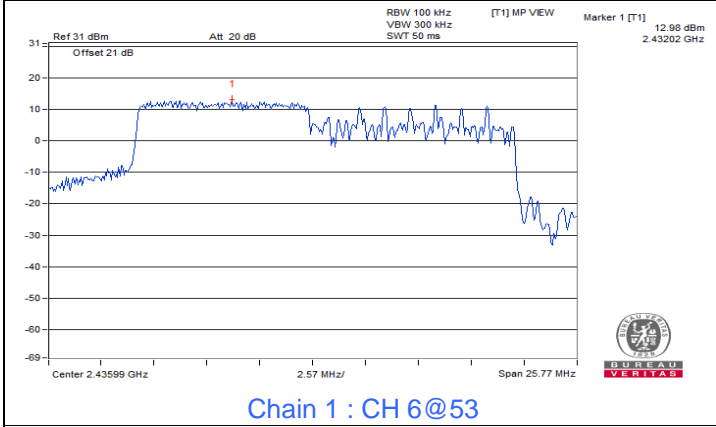
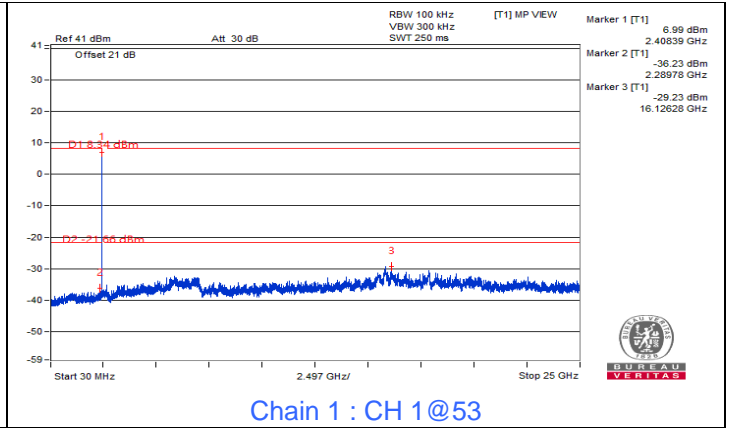
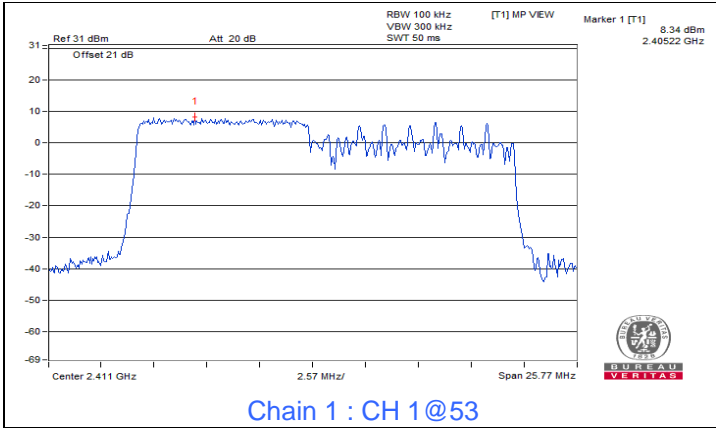

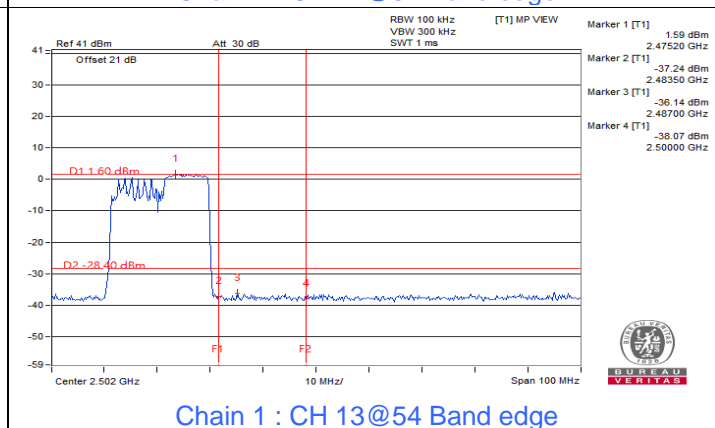
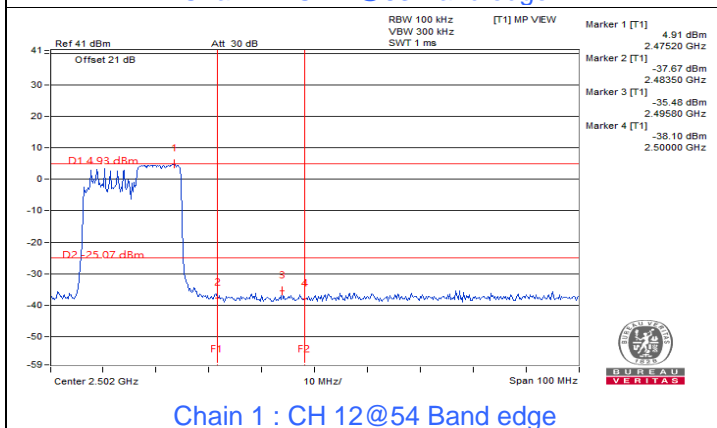
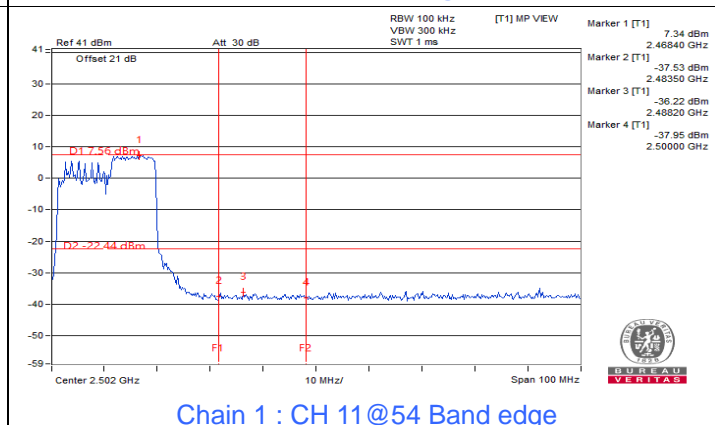
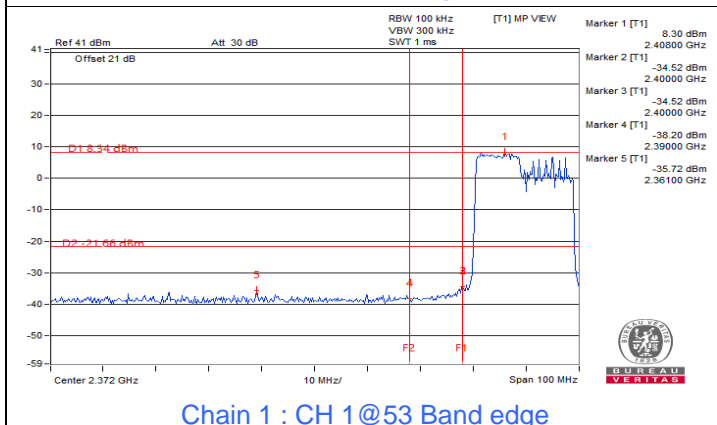
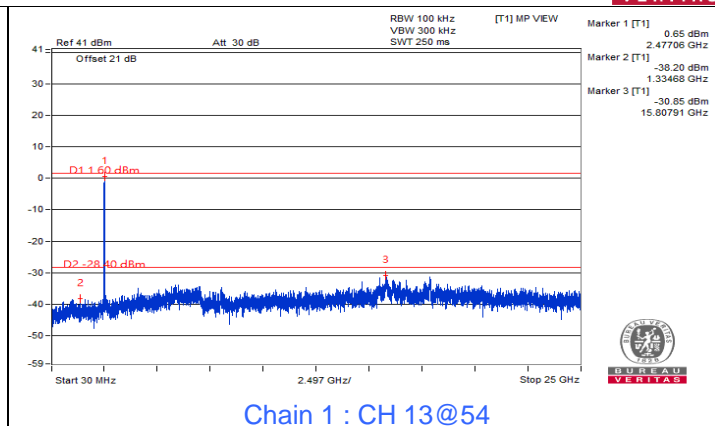
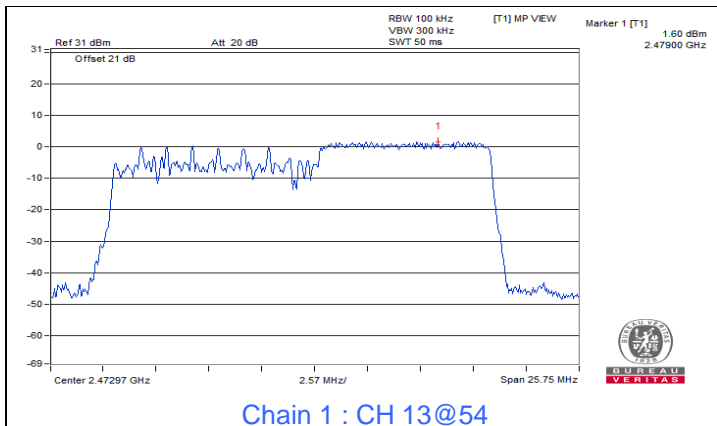



802.11be (EHT 20M) 52+26-tone MRU

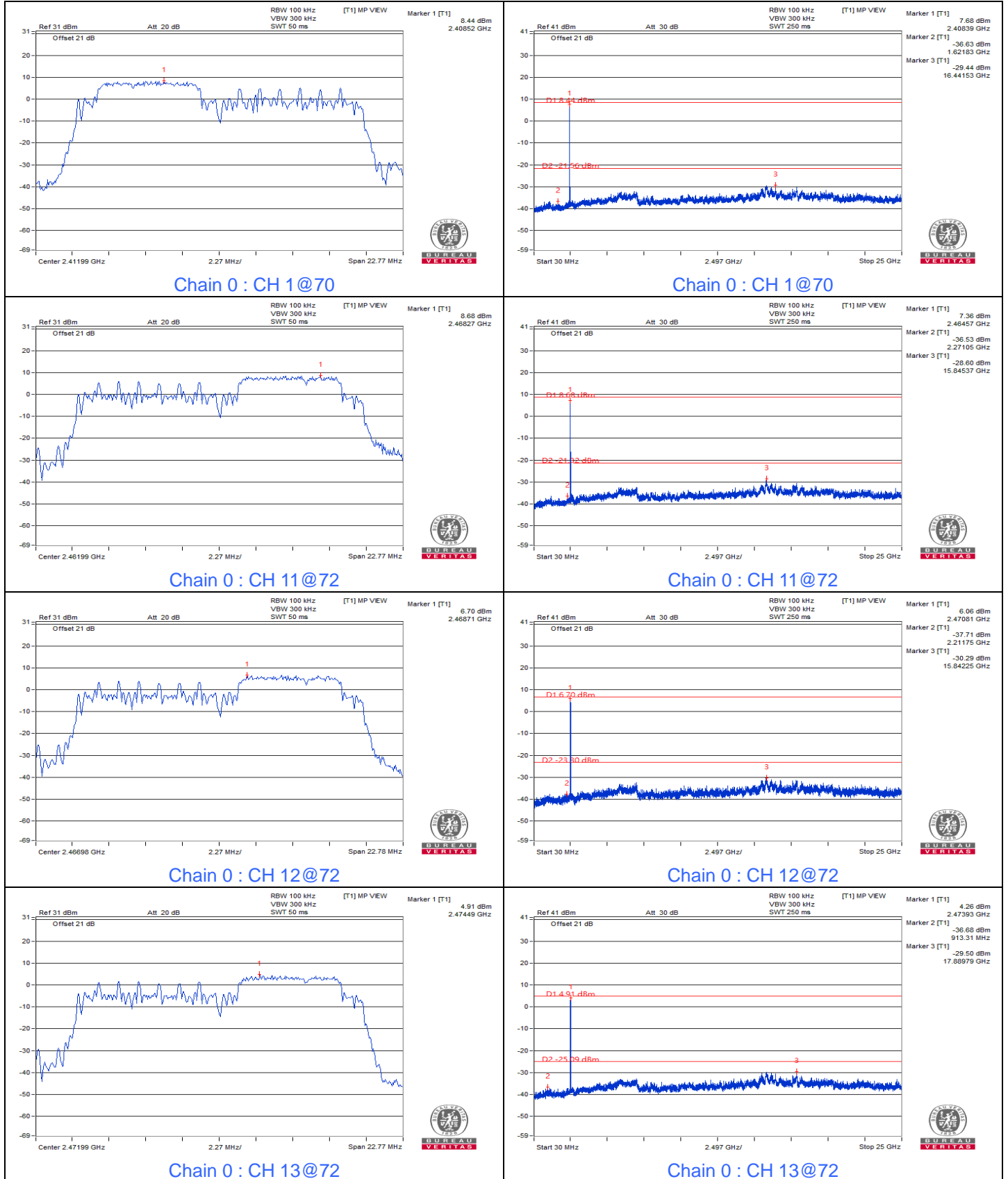

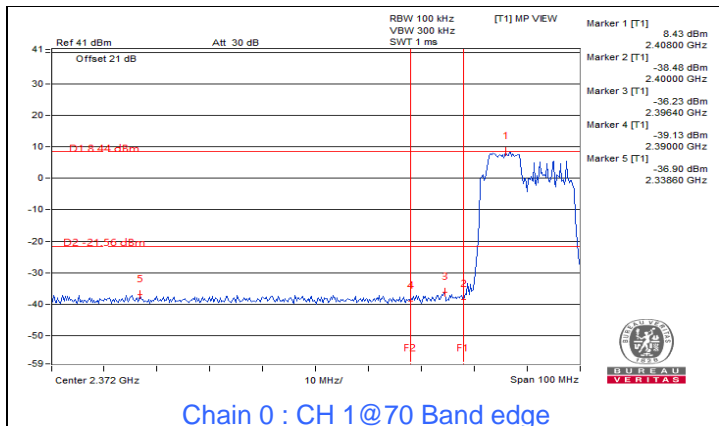

Chain 0 : CH 1@70 Band edge

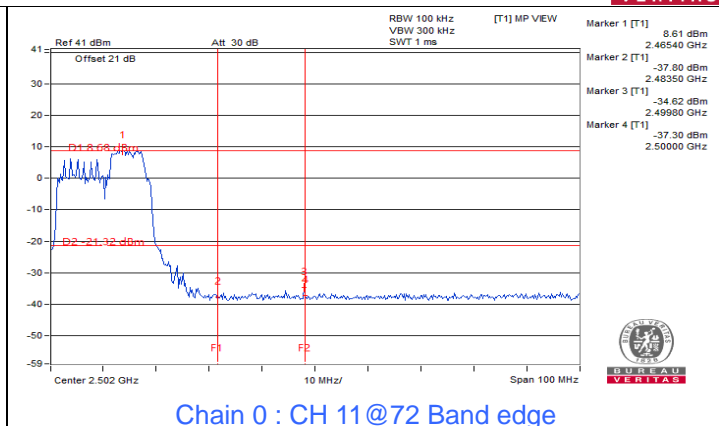

Chain 0 : CH 11@72 Band edge

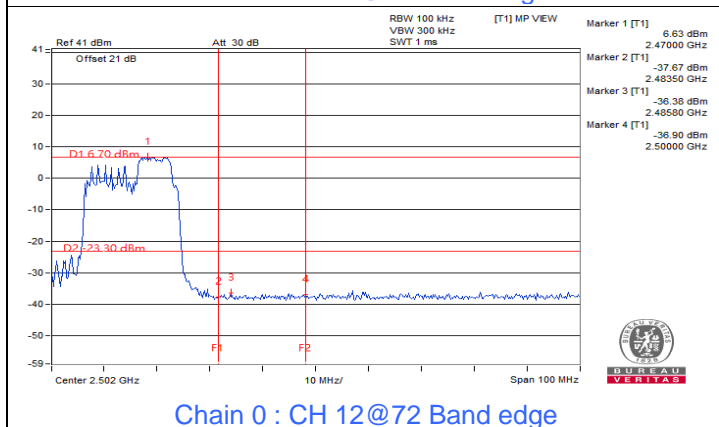

Chain 0 : CH 12@72 Band edge

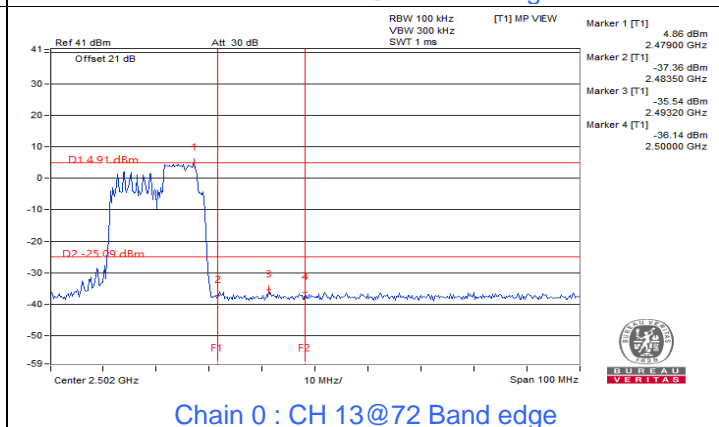

Chain 0 : CH 13@72 Band edge

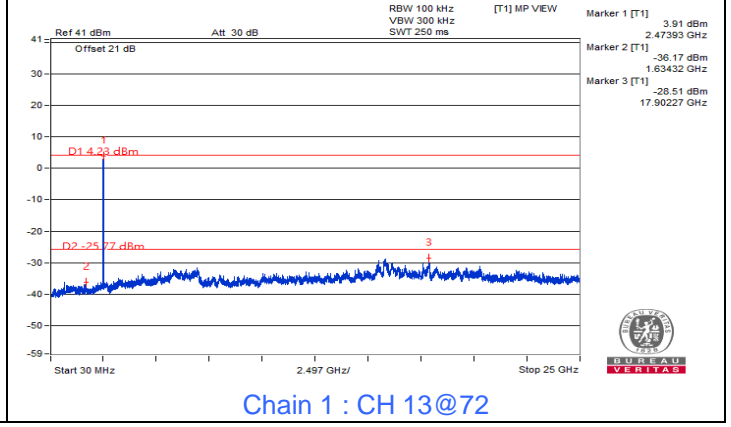
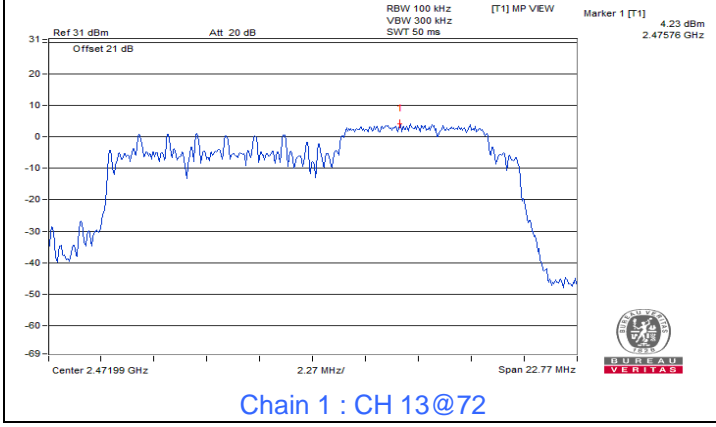
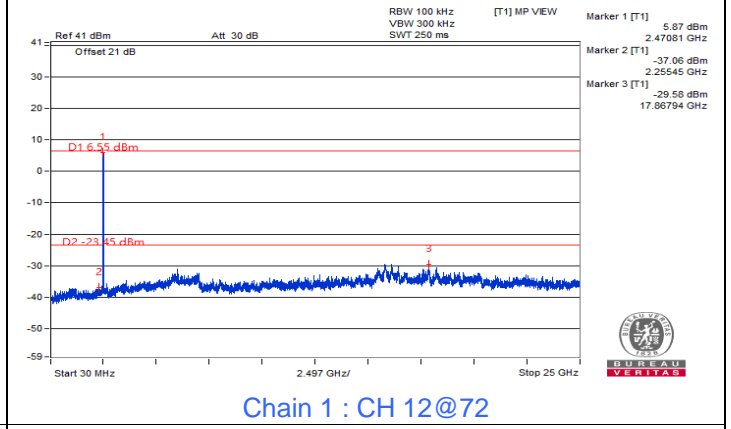
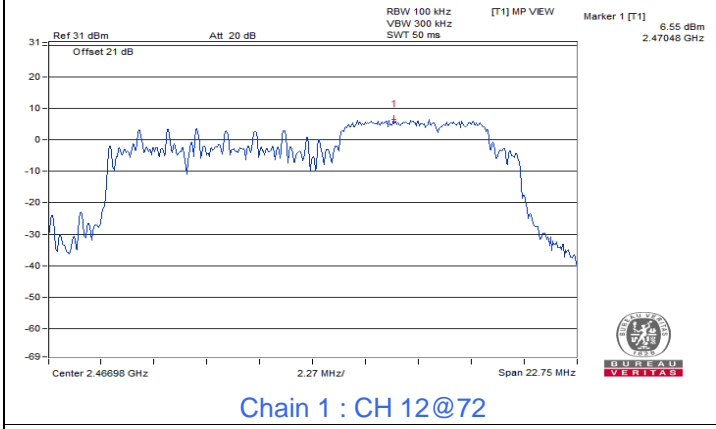
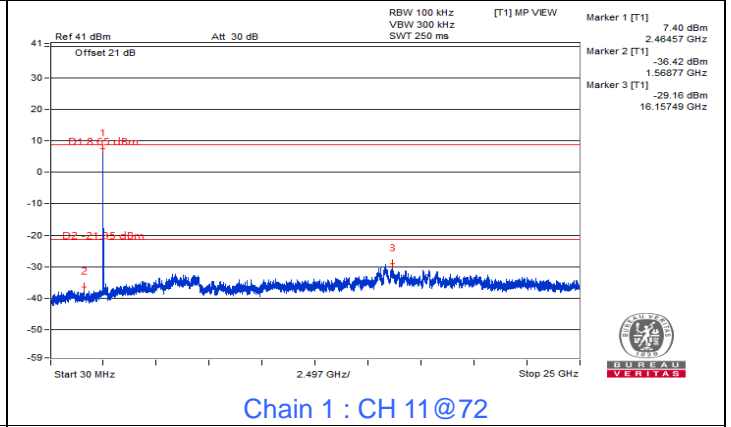
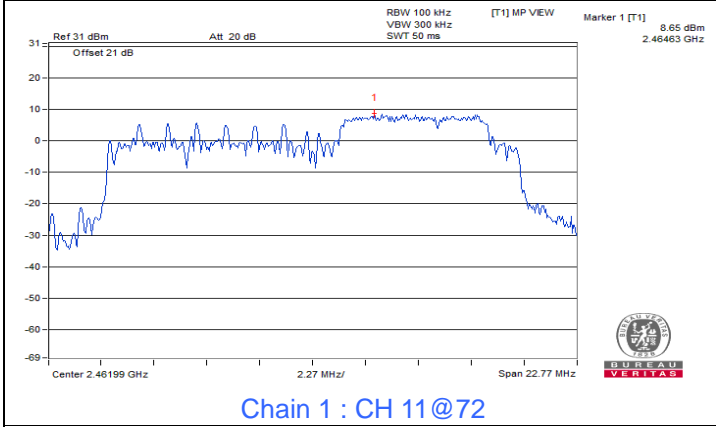
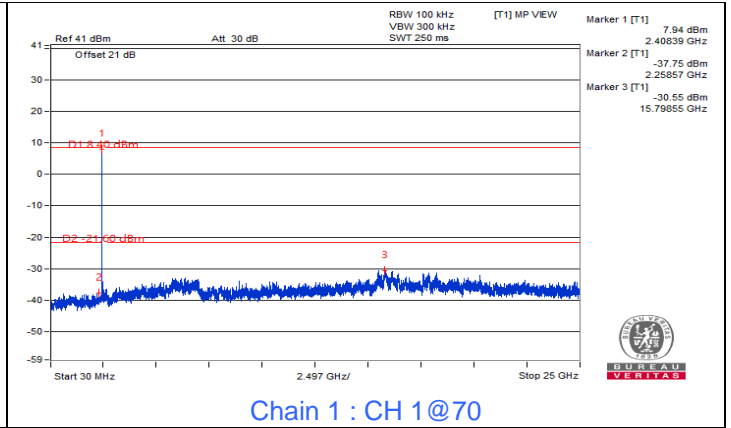
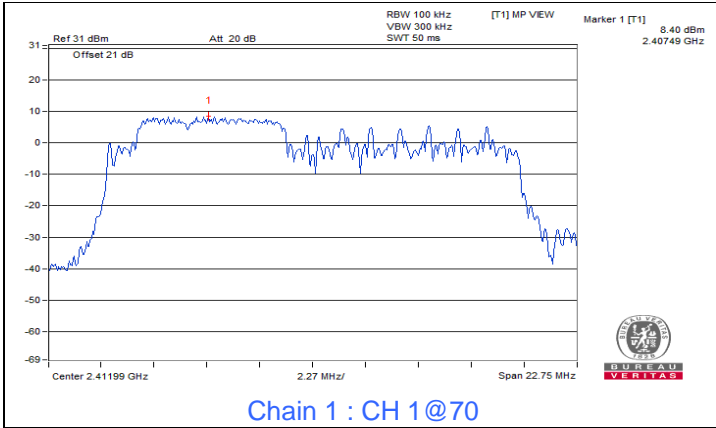

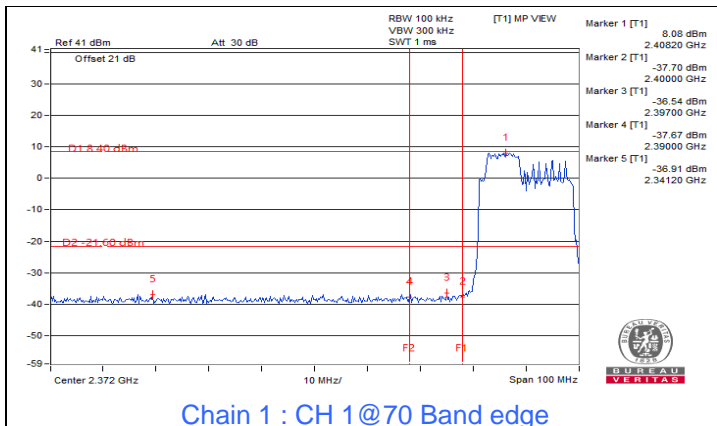

Chain 1 : CH 1@70 Band edge

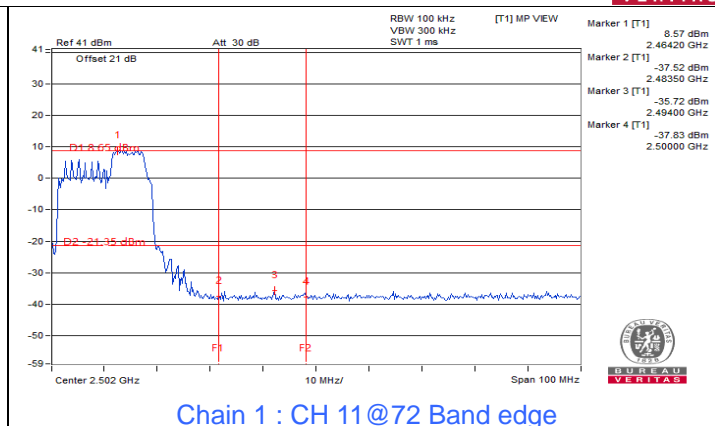

Chain 1 : CH 11@72 Band edge

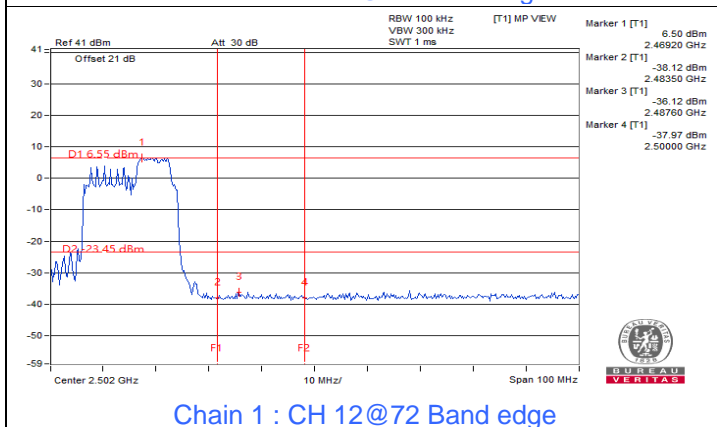

Chain 1 : CH 12@72 Band edge

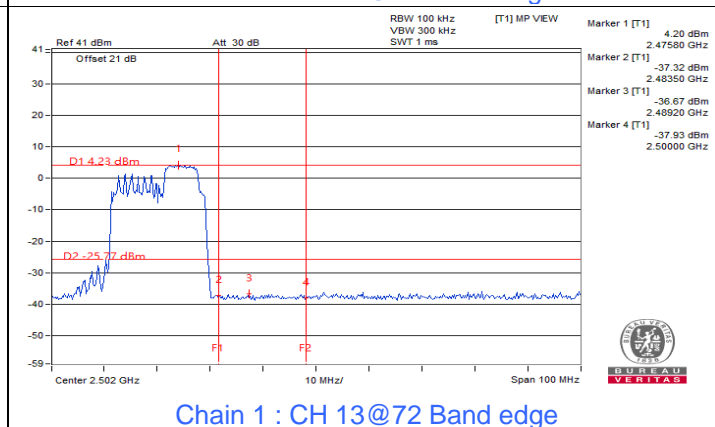

Chain 1 : CH 13@72 Band edge



802.11be (EHT 20M) 106+26-tone MRU

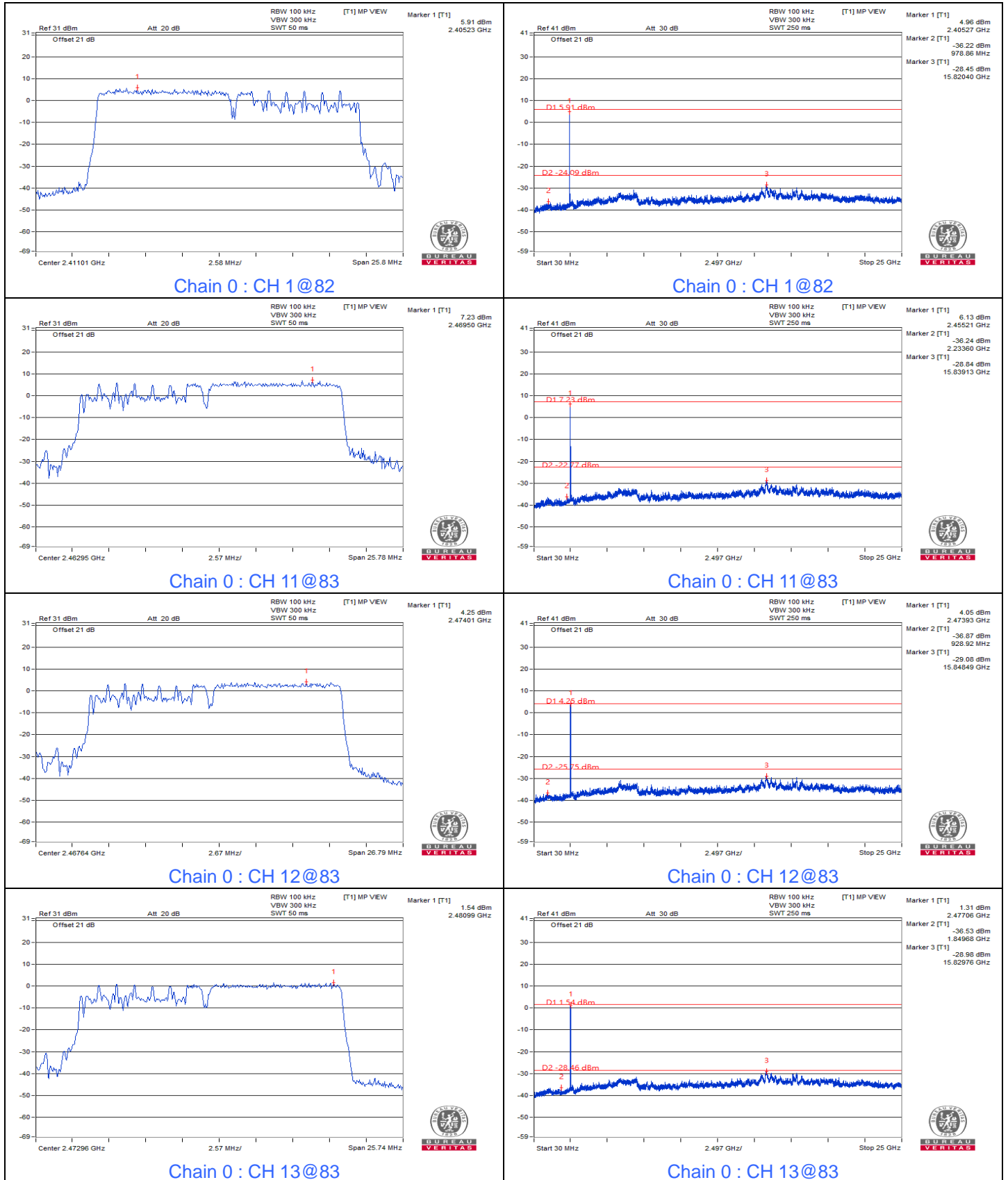

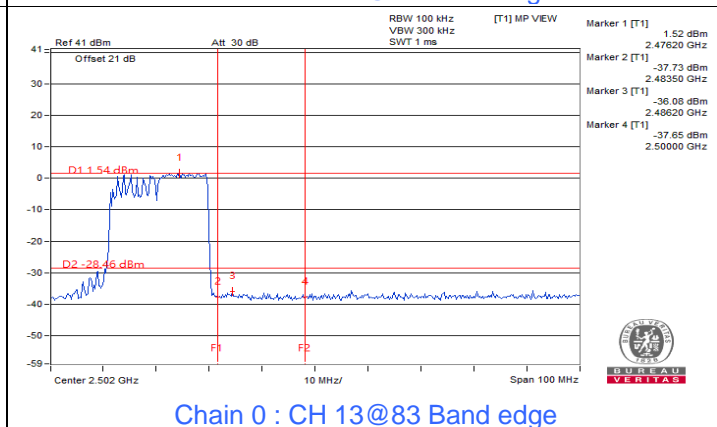
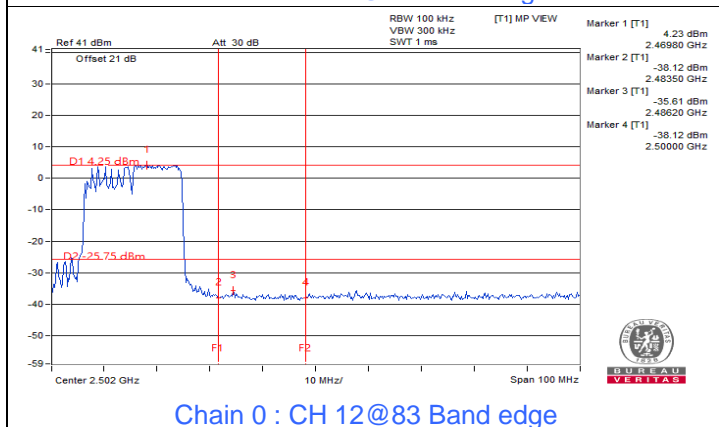
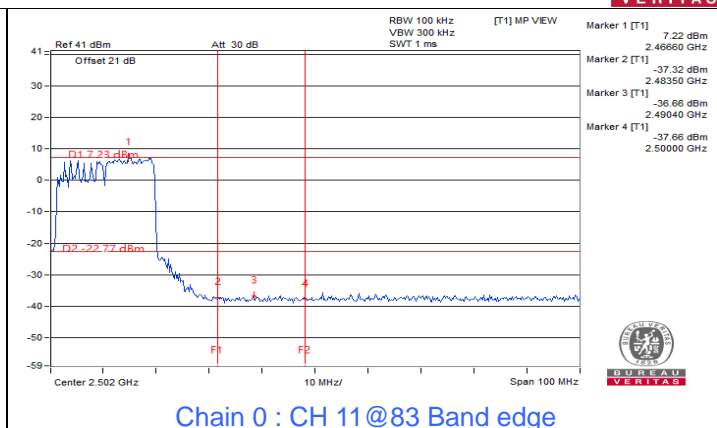
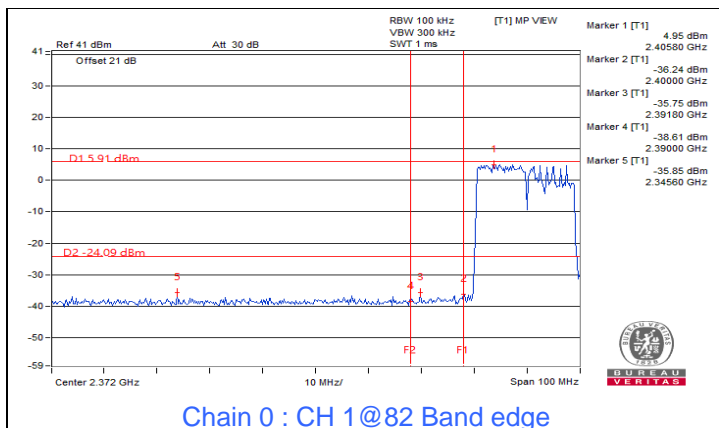

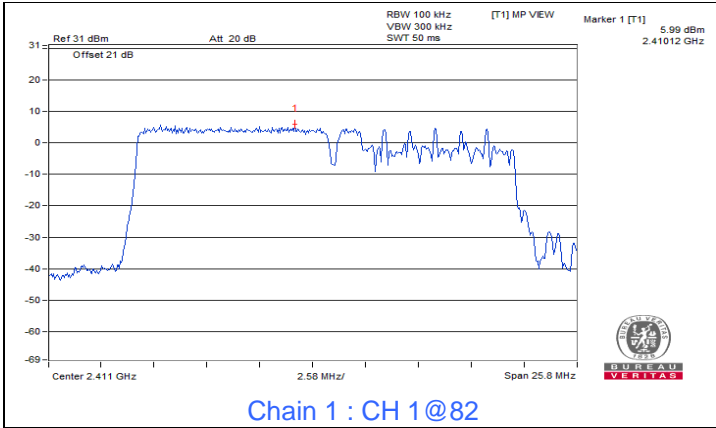

Chain 1 : CH 1@82

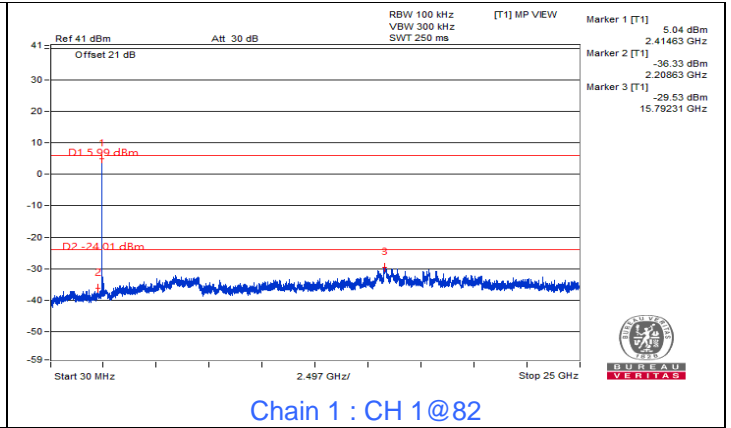

Chain 1 : CH 1@82

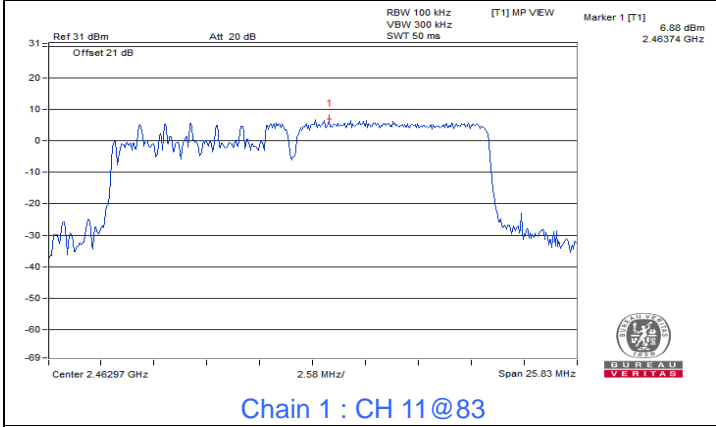

Chain 1 : CH 11@83

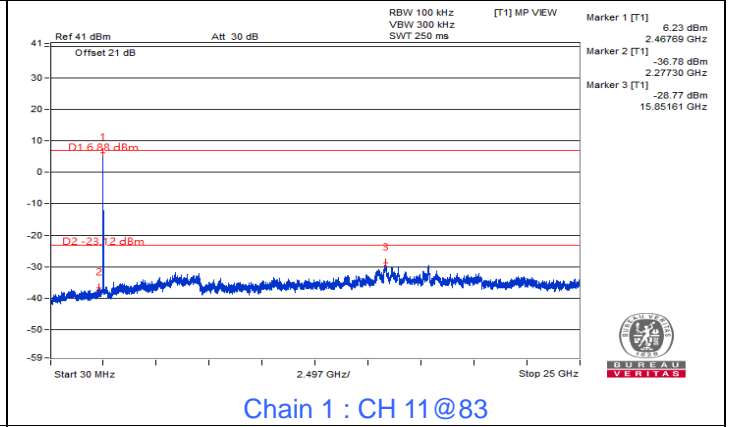

Chain 1 : CH 11@83

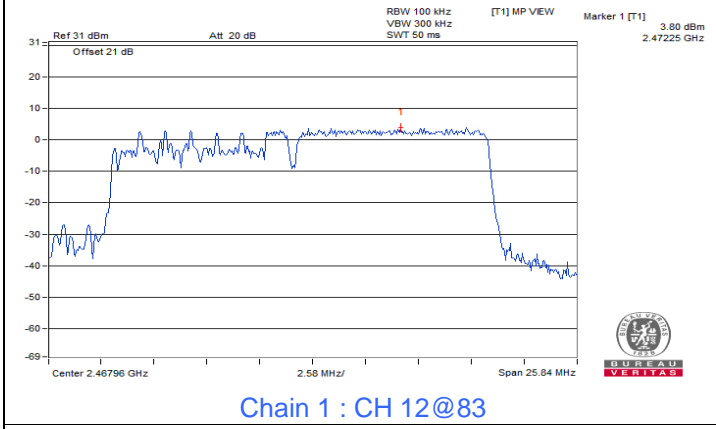

Chain 1 : CH 12@83

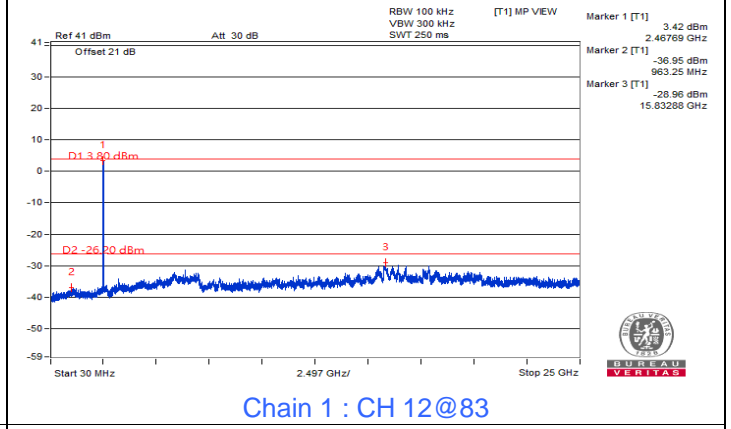

Chain 1 : CH 12@83

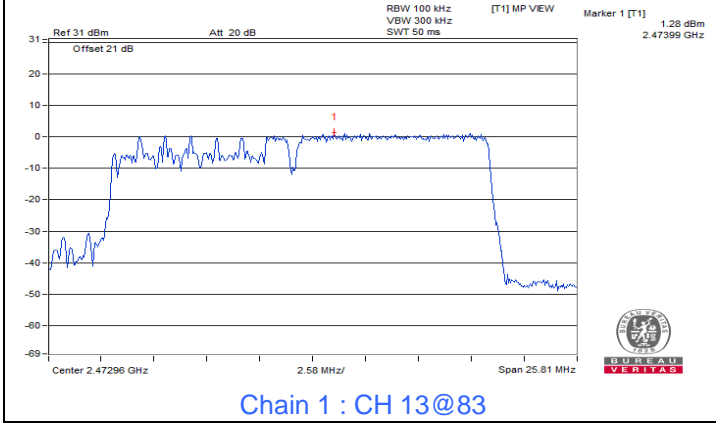

Chain 1 : CH 13@83

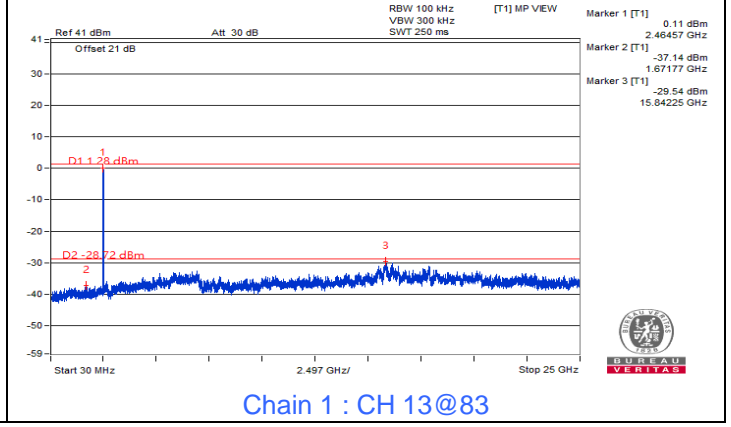

Chain 1 : CH 13@83

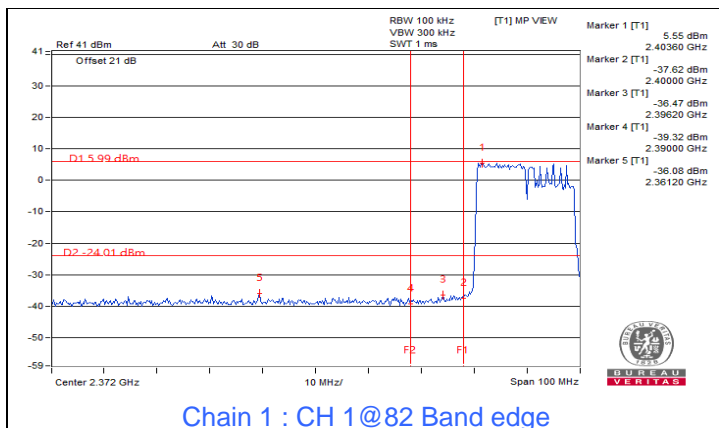

Chain 1 : CH 1@82 Band edge

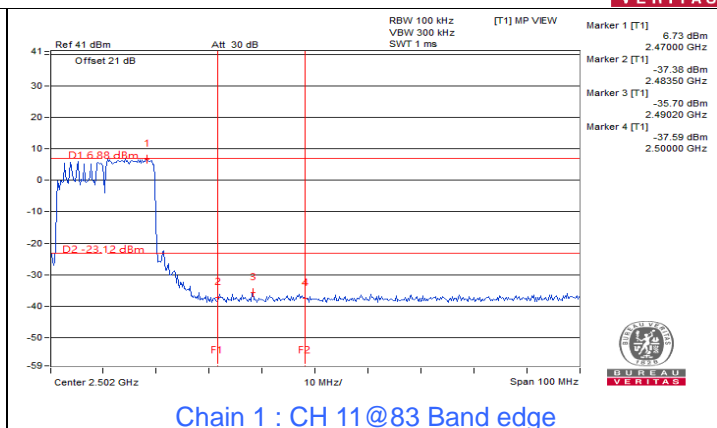

Chain 1 : CH 11@83 Band edge

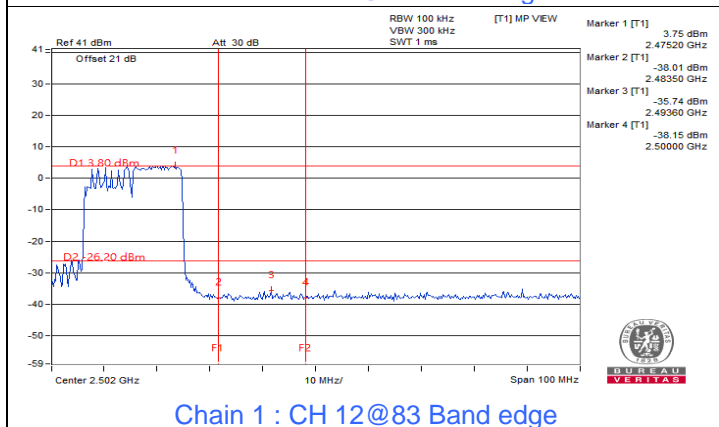

Chain 1 : CH 12@83 Band edge

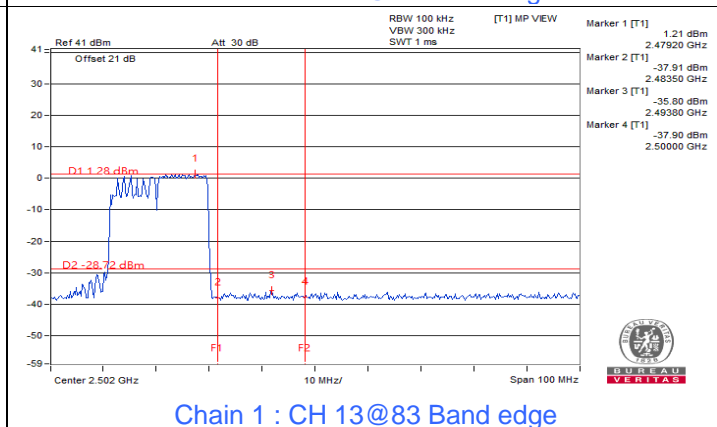

Chain 1 : CH 13@83 Band edge

7.5 AC Power Conducted Emissions

RF Mode	802.11be (EHT) 52-tone RU	Channel	CH 6 : 2437 MHz
Frequency Range	150 kHz ~ 30 MHz	Detector Function & Resolution Bandwidth	Quasi-Peak (QP) / Average (AV), 9 kHz
Input Power (System)	120 Vac, 60Hz	Environmental Conditions	23°C, 68% RH
Tested By	Tom Yang		

Phase Of Power : Line (L)

No	Frequency (MHz)	Correction Factor (dB)	Reading Value (dBuV)		Emission Level (dBuV)		Limit (dBuV)		Margin (dB)	
			Q.P.	AV.	Q.P.	AV.	Q.P.	AV.	Q.P.	AV.
1	0.15391	9.96	48.54	27.21	58.50	37.17	65.79	55.79	-7.29	-18.62
2	0.25156	9.96	35.63	14.11	45.59	24.07	61.71	51.71	-16.12	-27.64
3	0.44688	9.97	19.12	4.00	29.09	13.97	56.93	46.93	-27.84	-32.96
4	3.46484	10.12	24.22	16.49	34.34	26.61	56.00	46.00	-21.66	-19.39
5	15.34766	10.82	16.23	5.70	27.05	16.52	60.00	50.00	-32.95	-33.48
6	25.85156	11.19	25.33	21.91	36.52	33.10	60.00	50.00	-23.48	-16.90

Remarks:

1. Q.P. and AV. are abbreviations of quasi-peak and average individually.
2. The emission levels of other frequencies were very low against the limit.
3. Margin value = Emission level – Limit value
4. Correction factor = Insertion loss + Cable loss
5. Emission Level = Correction Factor + Reading Value

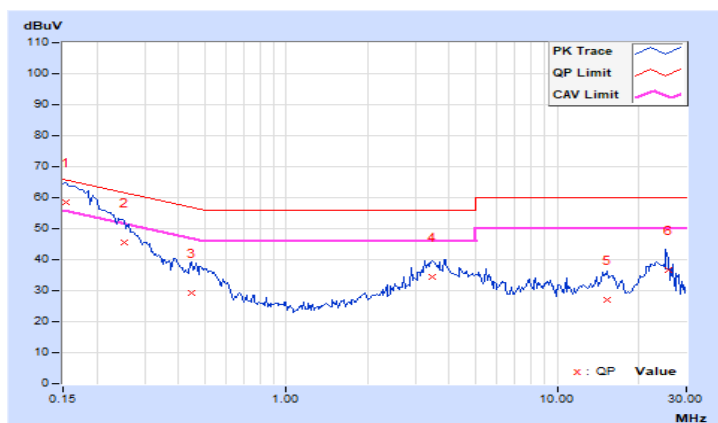

RF Mode	802.11be (EHT) 52-tone RU	Channel	CH 6 : 2437 MHz
Frequency Range	150 kHz ~ 30 MHz	Detector Function & Resolution Bandwidth	Quasi-Peak (QP) / Average (AV), 9 kHz
Input Power (System)	120 Vac, 60Hz	Environmental Conditions	23°C, 68% RH
Tested By	Tom Yang		

Phase Of Power : Neutral (N)										
No	Frequency (MHz)	Correction Factor (dB)	Reading Value (dBuV)		Emission Level (dBuV)		Limit (dBuV)		Margin (dB)	
			Q.P.	AV.	Q.P.	AV.	Q.P.	AV.	Q.P.	AV.
1	0.15000	9.93	49.47	26.95	59.40	36.88	66.00	56.00	-6.60	-19.12
2	0.19687	9.94	41.96	20.65	51.90	30.59	63.74	53.74	-11.84	-23.15
3	0.43516	9.94	17.29	1.47	27.23	11.41	57.15	47.15	-29.92	-35.74
4	3.45703	10.08	22.43	15.68	32.51	25.76	56.00	46.00	-23.49	-20.24
5	14.93359	10.60	17.57	8.23	28.17	18.83	60.00	50.00	-31.83	-31.17
6	25.09625	10.86	31.33	27.84	42.19	38.70	60.00	50.00	-17.81	-11.30

Remarks:

1. Q.P. and AV. are abbreviations of quasi-peak and average individually.
2. The emission levels of other frequencies were very low against the limit.
3. Margin value = Emission level – Limit value
4. Correction factor = Insertion loss + Cable loss
5. Emission Level = Correction Factor + Reading Value

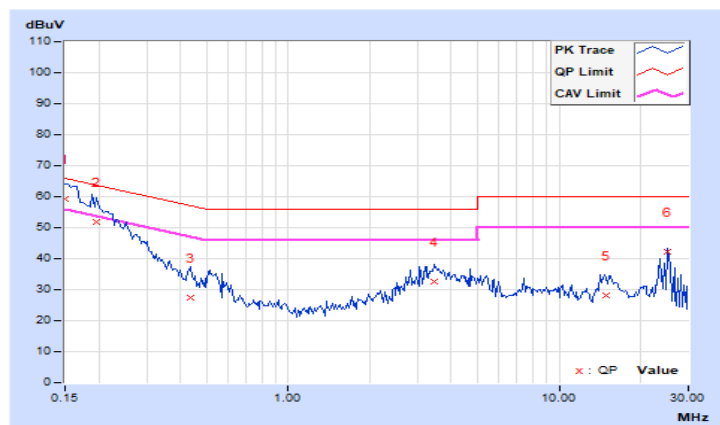

7.6 Unwanted Emissions below 1 GHz

RF Mode	802.11be (EHT) 52-tone RU	Channel	CH 6 : 2437 MHz
Frequency Range	30 MHz ~ 1 GHz	Detector Function & Bandwidth	(QP) RB = 120kHz
Input Power (System)	120 Vac, 60Hz	Environmental Conditions	25°C, 67% RH
Tested By	Tom Yang		

Antenna Polarity & Test Distance : Horizontal at 3 m

No	Frequency (MHz)	Emission Level (dBuV/m)	Limit (dBuV/m)	Margin (dB)	Antenna Height (m)	Table Angle (Degree)	Raw Value (dBuV)	Correction Factor (dB/m)
1	181.27	38.6 QP	43.5	-4.9	1.50 H	155	52.3	-13.7
2	199.55	40.4 QP	43.5	-3.1	2.00 H	360	55.4	-15.0
3	299.02	41.5 QP	46.0	-4.5	1.50 H	360	52.3	-10.8
4	398.31	32.9 QP	46.0	-13.1	1.00 H	137	40.8	-7.9
5	698.45	40.6 QP	46.0	-5.4	1.50 H	360	41.3	-0.7
6	896.19	42.2 QP	46.0	-3.8	1.50 H	102	39.0	3.2

Remarks:

1. Emission Level(dBuV/m) = Raw Value(dBuV) + Correction Factor(dB/m)
2. Correction Factor(dB/m) = Antenna Factor(dB/m) + Cable Factor(dB) – Pre-Amplifier Factor(dB)
3. Margin value = Emission Level – Limit value
4. The other emission levels were very low against the limit of frequency range 30 MHz ~ 1 GHz.
5. The emission levels were very low against the limit of frequency range 9 kHz ~ 30 MHz: the amplitude of spurious emissions attenuated more than 20 dB below the permissible value to be report.

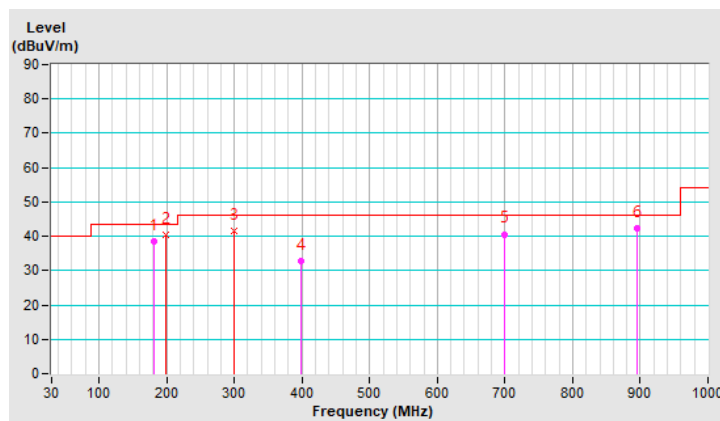

RF Mode	802.11be (EHT) 52-tone RU	Channel	CH 6 : 2437 MHz
Frequency Range	30 MHz ~ 1 GHz	Detector Function & Bandwidth	(QP) RB = 120kHz
Input Power (System)	120 Vac, 60Hz	Environmental Conditions	25°C, 67% RH
Tested By	Tom Yang		

Antenna Polarity & Test Distance : Vertical at 3 m								
No	Frequency (MHz)	Emission Level (dBuV/m)	Limit (dBuV/m)	Margin (dB)	Antenna Height (m)	Table Angle (Degree)	Raw Value (dBuV)	Correction Factor (dB/m)
1	38.71	22.6 QP	40.0	-17.4	1.00 V	360	35.6	-13.0
2	199.14	34.0 QP	43.5	-9.5	1.50 V	95	49.0	-15.0
3	298.74	39.6 QP	46.0	-6.4	1.00 V	91	50.4	-10.8
4	398.31	29.6 QP	46.0	-16.4	1.50 V	139	37.5	-7.9
5	698.43	35.1 QP	46.0	-10.9	2.00 V	51	35.8	-0.7
6	898.00	39.8 QP	46.0	-6.2	1.00 V	72	36.6	3.2

Remarks:

1. Emission Level(dBuV/m) = Raw Value(dBuV) + Correction Factor(dB/m)
2. Correction Factor(dB/m) = Antenna Factor(dB/m) + Cable Factor(dB) – Pre-Amplifier Factor(dB)
3. Margin value = Emission Level – Limit value
4. The other emission levels were very low against the limit of frequency range 30 MHz ~ 1 GHz.
5. The emission levels were very low against the limit of frequency range 9 kHz ~ 30 MHz: the amplitude of spurious emissions attenuated more than 20 dB below the permissible value to be report.

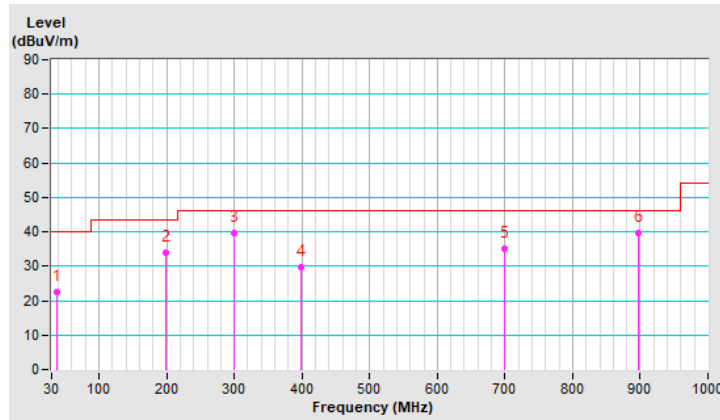

7.7 Unwanted Emissions above 1 GHz

RF Mode	802.11be (EHT) 26-tone RU	Channel	CH 1 : 2412 MHz
Frequency Range	1 GHz ~ 25 GHz	Detector Function & Bandwidth	(PK) RB = 1 MHz, VB = 3 MHz (AV) RB = 1 MHz, VB = 2 kHz
Input Power (System)	120 Vac, 60Hz	Environmental Conditions	25°C, 68% RH
Tested By	Tom Yang		

Antenna Polarity & Test Distance : Horizontal at 3 m								
No	Frequency (MHz)	Emission Level (dBuV/m)	Limit (dBuV/m)	Margin (dB)	Antenna Height (m)	Table Angle (Degree)	Raw Value (dBuV)	Correction Factor (dB/m)
1	2390.00	73.7 PK	74.0	-0.3	3.02 H	72	74.6	-0.9
2	2390.00	53.9 AV	54.0	-0.1	3.02 H	72	54.8	-0.9
3	*2412.00	124.4 PK			3.02 H	72	125.3	-0.9
4	*2412.00	115.5 AV			3.02 H	72	116.4	-0.9
5	4824.00	44.9 PK	74.0	-29.1	1.20 H	140	41.5	3.4
6	4824.00	32.5 AV	54.0	-21.5	1.20 H	140	29.1	3.4

Remarks:

1. Emission Level(dBuV/m) = Raw Value(dBuV) + Correction Factor(dB/m)
2. Correction Factor(dB/m) = Antenna Factor(dB/m) + Cable Factor(dB) – Pre-Amplifier Factor(dB)
3. Margin value = Emission Level – Limit value
4. The other emission levels were very low against the limit.
5. " * ": Fundamental frequency, the limit was restricted at the RF Output Power.
- 6.

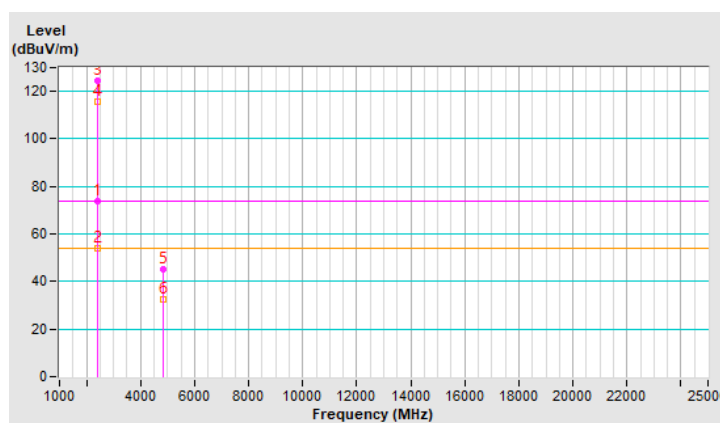

RF Mode	802.11be (EHT) 26-tone RU	Channel	CH 1 : 2412 MHz
Frequency Range	1 GHz ~ 25 GHz	Detector Function & Bandwidth	(PK) RB = 1 MHz, VB = 3 MHz (AV) RB = 1 MHz, VB = 2 kHz
Input Power (System)	120 Vac, 60Hz	Environmental Conditions	25°C, 68% RH
Tested By	Tom Yang		

Antenna Polarity & Test Distance : Vertical at 3 m								
No	Frequency (MHz)	Emission Level (dBuV/m)	Limit (dBuV/m)	Margin (dB)	Antenna Height (m)	Table Angle (Degree)	Raw Value (dBuV)	Correction Factor (dB/m)
1	2390.00	68.4 PK	74.0	-5.6	1.91 V	359	69.3	-0.9
2	2390.00	50.0 AV	54.0	-4.0	1.91 V	359	50.9	-0.9
3	*2412.00	119.1 PK			1.91 V	359	120.0	-0.9
4	*2412.00	110.6 AV			1.91 V	359	111.5	-0.9
5	4824.00	42.1 PK	74.0	-31.9	2.32 V	147	38.7	3.4
6	4824.00	30.5 AV	54.0	-23.5	2.32 V	147	27.1	3.4

Remarks:

1. Emission Level(dBuV/m) = Raw Value(dBuV) + Correction Factor(dB/m)
2. Correction Factor(dB/m) = Antenna Factor(dB/m) + Cable Factor(dB) – Pre-Amplifier Factor(dB)
3. Margin value = Emission Level – Limit value
4. The other emission levels were very low against the limit.
5. " * " : Fundamental frequency, the limit was restricted at the RF Output Power.

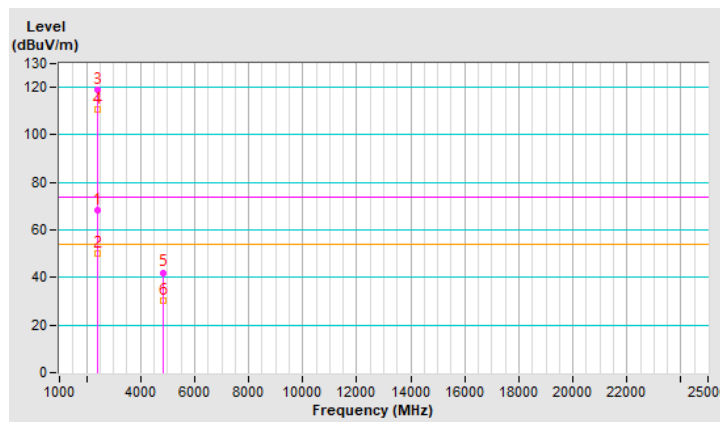

RF Mode	802.11be (EHT) 26-tone RU	Channel	CH 6 : 2437 MHz
Frequency Range	1 GHz ~ 25 GHz	Detector Function & Bandwidth	(PK) RB = 1 MHz, VB = 3 MHz (AV) RB = 1 MHz, VB = 2 kHz
Input Power (System)	120 Vac, 60Hz	Environmental Conditions	25°C, 68% RH
Tested By	Tom Yang		

Antenna Polarity & Test Distance : Horizontal at 3 m								
No	Frequency (MHz)	Emission Level (dBuV/m)	Limit (dBuV/m)	Margin (dB)	Antenna Height (m)	Table Angle (Degree)	Raw Value (dBuV)	Correction Factor (dB/m)
1	2390.00	72.6 PK	74.0	-1.4	2.83 H	64	73.5	-0.9
2	2390.00	53.6 AV	54.0	-0.4	2.83 H	64	54.5	-0.9
3	*2437.00	126.6 PK			2.83 H	64	127.4	-0.8
4	*2437.00	118.2 AV			2.83 H	64	119.0	-0.8
5	2483.50	70.4 PK	74.0	-3.6	2.83 H	64	71.4	-1.0
6	2483.50	49.4 AV	54.0	-4.6	2.83 H	64	50.4	-1.0
7	4874.00	52.4 PK	74.0	-21.6	1.15 H	131	48.9	3.5
8	4874.00	40.4 AV	54.0	-13.6	1.15 H	131	36.9	3.5
9	7311.00	51.2 PK	74.0	-22.8	2.05 H	326	41.1	10.1
10	7311.00	40.0 AV	54.0	-14.0	2.05 H	326	29.9	10.1

Remarks:

1. Emission Level(dBuV/m) = Raw Value(dBuV) + Correction Factor(dB/m)
2. Correction Factor(dB/m) = Antenna Factor(dB/m) + Cable Factor(dB) – Pre-Amplifier Factor(dB)
3. Margin value = Emission Level – Limit value
4. The other emission levels were very low against the limit.
5. " * " : Fundamental frequency, the limit was restricted at the RF Output Power.

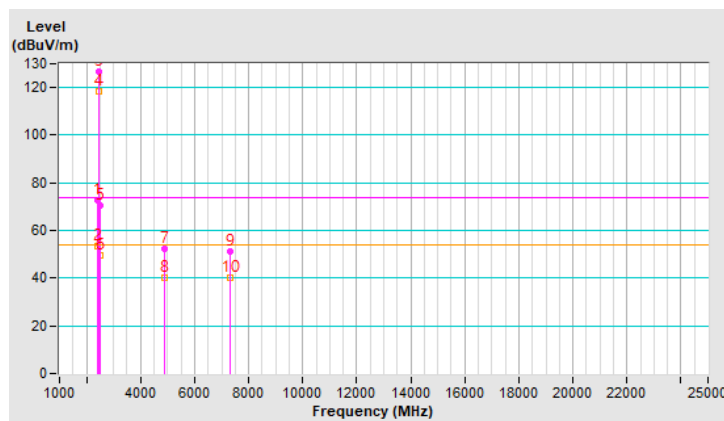

RF Mode	802.11be (EHT) 26-tone RU	Channel	CH 6 : 2437 MHz
Frequency Range	1 GHz ~ 25 GHz	Detector Function & Bandwidth	(PK) RB = 1 MHz, VB = 3 MHz (AV) RB = 1 MHz, VB = 2 kHz
Input Power (System)	120 Vac, 60Hz	Environmental Conditions	25°C, 68% RH
Tested By	Tom Yang		

Antenna Polarity & Test Distance : Vertical at 3 m								
No	Frequency (MHz)	Emission Level (dBuV/m)	Limit (dBuV/m)	Margin (dB)	Antenna Height (m)	Table Angle (Degree)	Raw Value (dBuV)	Correction Factor (dB/m)
1	2390.00	68.4 PK	74.0	-5.6	2.30 V	18	69.3	-0.9
2	2390.00	49.8 AV	54.0	-4.2	2.30 V	18	50.7	-0.9
3	*2437.00	121.3 PK			2.30 V	18	122.1	-0.8
4	*2437.00	112.9 AV			2.30 V	18	113.7	-0.8
5	2483.50	62.8 PK	74.0	-11.2	2.30 V	18	63.8	-1.0
6	2483.50	48.1 AV	54.0	-5.9	2.30 V	18	49.1	-1.0
7	4874.00	50.4 PK	74.0	-23.6	2.35 V	146	46.9	3.5
8	4874.00	39.0 AV	54.0	-15.0	2.35 V	146	35.5	3.5
9	7311.00	54.5 PK	74.0	-19.5	3.60 V	156	44.4	10.1
10	7311.00	42.9 AV	54.0	-11.1	3.60 V	156	32.8	10.1

Remarks:

1. Emission Level(dBuV/m) = Raw Value(dBuV) + Correction Factor(dB/m)
2. Correction Factor(dB/m) = Antenna Factor(dB/m) + Cable Factor(dB) – Pre-Amplifier Factor(dB)
3. Margin value = Emission Level – Limit value
4. The other emission levels were very low against the limit.
5. " * " : Fundamental frequency, the limit was restricted at the RF Output Power.

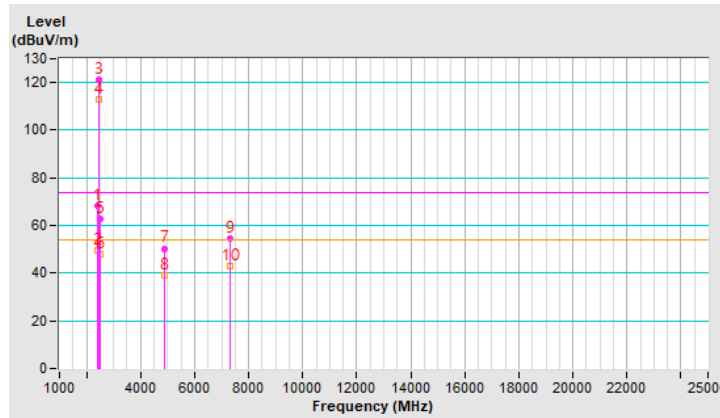

RF Mode	802.11be (EHT) 26-tone RU	Channel	CH 11 : 2462 MHz
Frequency Range	1 GHz ~ 25 GHz	Detector Function & Bandwidth	(PK) RB = 1 MHz, VB = 3 MHz (AV) RB = 1 MHz, VB = 2 kHz
Input Power (System)	120 Vac, 60Hz	Environmental Conditions	25°C, 68% RH
Tested By	Tom Yang		

Antenna Polarity & Test Distance : Horizontal at 3 m								
No	Frequency (MHz)	Emission Level (dBuV/m)	Limit (dBuV/m)	Margin (dB)	Antenna Height (m)	Table Angle (Degree)	Raw Value (dBuV)	Correction Factor (dB/m)
1	*2462.00	123.2 PK			2.81 H	70	124.0	-0.8
2	*2462.00	113.9 AV			2.81 H	70	114.7	-0.8
3	2483.50	73.9 PK	74.0	-0.1	2.81 H	70	74.9	-1.0
4	2483.50	53.9 AV	54.0	-0.1	2.81 H	70	54.9	-1.0
5	4924.00	44.6 PK	74.0	-29.4	1.16 H	127	41.0	3.6
6	4924.00	32.4 AV	54.0	-21.6	1.16 H	127	28.8	3.6
7	7386.00	43.3 PK	74.0	-30.7	2.07 H	337	33.1	10.2
8	7386.00	32.0 AV	54.0	-22.0	2.07 H	337	21.8	10.2

Remarks:

1. Emission Level(dBuV/m) = Raw Value(dBuV) + Correction Factor(dB/m)
2. Correction Factor(dB/m) = Antenna Factor(dB/m) + Cable Factor(dB) – Pre-Amplifier Factor(dB)
3. Margin value = Emission Level – Limit value
4. The other emission levels were very low against the limit.
5. " * ": Fundamental frequency, the limit was restricted at the RF Output Power.

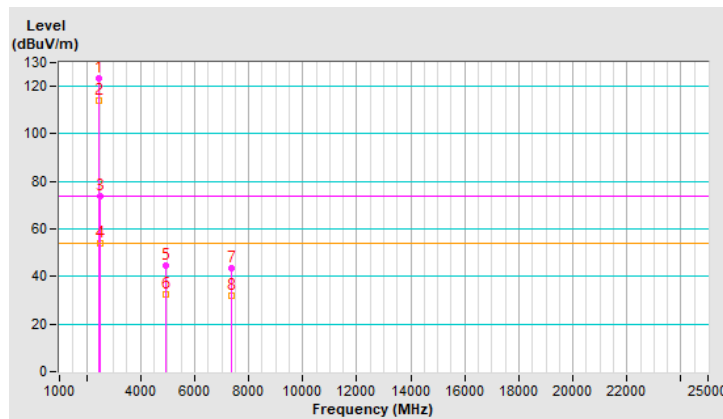

RF Mode	802.11be (EHT) 26-tone RU	Channel	CH 11 : 2462 MHz
Frequency Range	1 GHz ~ 25 GHz	Detector Function & Bandwidth	(PK) RB = 1 MHz, VB = 3 MHz (AV) RB = 1 MHz, VB = 2 kHz
Input Power (System)	120 Vac, 60Hz	Environmental Conditions	25°C, 68% RH
Tested By	Tom Yang		

Antenna Polarity & Test Distance : Vertical at 3 m								
No	Frequency (MHz)	Emission Level (dBuV/m)	Limit (dBuV/m)	Margin (dB)	Antenna Height (m)	Table Angle (Degree)	Raw Value (dBuV)	Correction Factor (dB/m)
1	*2462.00	117.7 PK			2.33 V	7	118.5	-0.8
2	*2462.00	109.5 AV			2.33 V	7	110.3	-0.8
3	2483.50	62.8 PK	74.0	-11.2	2.33 V	7	63.8	-1.0
4	2483.50	48.0 AV	54.0	-6.0	2.33 V	7	49.0	-1.0
5	4924.00	41.6 PK	74.0	-32.4	2.32 V	155	38.0	3.6
6	4924.00	30.2 AV	54.0	-23.8	2.32 V	155	26.6	3.6
7	7386.00	46.9 PK	74.0	-27.1	3.55 V	145	36.7	10.2
8	7386.00	35.7 AV	54.0	-18.3	3.55 V	145	25.5	10.2

Remarks:

1. Emission Level(dBuV/m) = Raw Value(dBuV) + Correction Factor(dB/m)
2. Correction Factor(dB/m) = Antenna Factor(dB/m) + Cable Factor(dB) – Pre-Amplifier Factor(dB)
3. Margin value = Emission Level – Limit value
4. The other emission levels were very low against the limit.
5. " * ": Fundamental frequency, the limit was restricted at the RF Output Power.

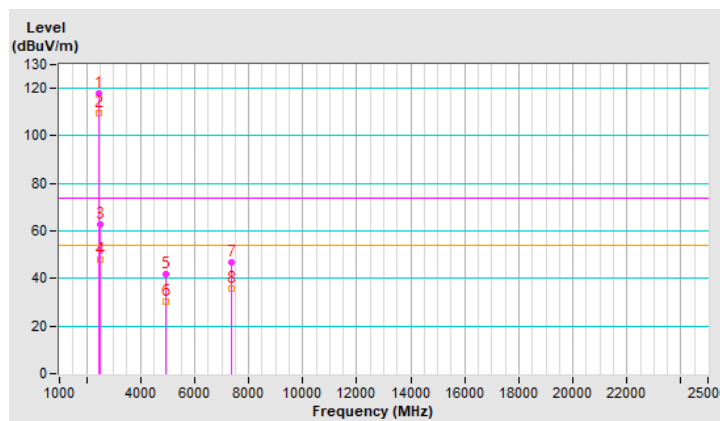

RF Mode	802.11be (EHT) 26-tone RU	Channel	CH 12 : 2467 MHz
Frequency Range	1 GHz ~ 25 GHz	Detector Function & Bandwidth	(PK) RB = 1 MHz, VB = 3 MHz (AV) RB = 1 MHz, VB = 2 kHz
Input Power (System)	120 Vac, 60Hz	Environmental Conditions	25°C, 68% RH
Tested By	Tom Yang		

Antenna Polarity & Test Distance : Horizontal at 3 m								
No	Frequency (MHz)	Emission Level (dBuV/m)	Limit (dBuV/m)	Margin (dB)	Antenna Height (m)	Table Angle (Degree)	Raw Value (dBuV)	Correction Factor (dB/m)
1	*2467.00	120.9 PK			2.82 H	61	121.7	-0.8
2	*2467.00	112.6 AV			2.82 H	61	113.4	-0.8
3	2483.50	72.5 PK	74.0	-1.5	2.82 H	61	73.5	-1.0
4	2483.50	53.8 AV	54.0	-0.2	2.82 H	61	54.8	-1.0
5	4934.00	44.0 PK	74.0	-30.0	1.17 H	131	40.4	3.6
6	4934.00	32.0 AV	54.0	-22.0	1.17 H	131	28.4	3.6
7	7401.00	43.4 PK	74.0	-30.6	2.02 H	330	33.2	10.2
8	7401.00	31.8 AV	54.0	-22.2	2.02 H	330	21.6	10.2

Remarks:

1. Emission Level(dBuV/m) = Raw Value(dBuV) + Correction Factor(dB/m)
2. Correction Factor(dB/m) = Antenna Factor(dB/m) + Cable Factor(dB) – Pre-Amplifier Factor(dB)
3. Margin value = Emission Level – Limit value
4. The other emission levels were very low against the limit.
5. " * " : Fundamental frequency, the limit was restricted at the RF Output Power.

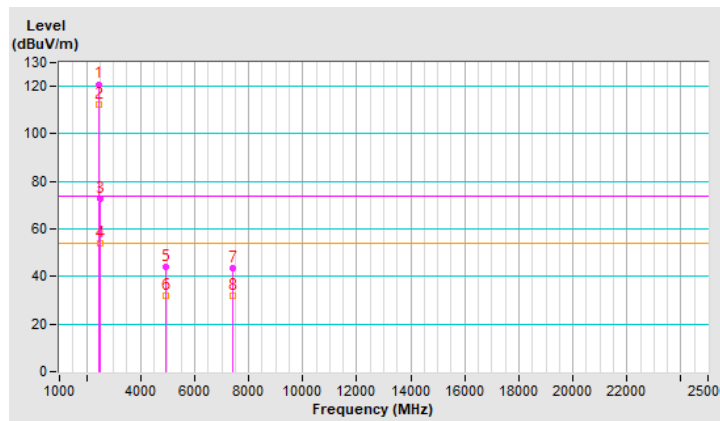

RF Mode	802.11be (EHT) 26-tone RU	Channel	CH 12 : 2467 MHz
Frequency Range	1 GHz ~ 25 GHz	Detector Function & Bandwidth	(PK) RB = 1 MHz, VB = 3 MHz (AV) RB = 1 MHz, VB = 2 kHz
Input Power (System)	120 Vac, 60Hz	Environmental Conditions	25°C, 68% RH
Tested By	Tom Yang		

Antenna Polarity & Test Distance : Vertical at 3 m								
No	Frequency (MHz)	Emission Level (dBuV/m)	Limit (dBuV/m)	Margin (dB)	Antenna Height (m)	Table Angle (Degree)	Raw Value (dBuV)	Correction Factor (dB/m)
1	*2467.00	117.8 PK			2.38 V	11	118.6	-0.8
2	*2467.00	108.8 AV			2.38 V	11	109.6	-0.8
3	2483.50	66.7 PK	74.0	-7.3	2.38 V	11	67.7	-1.0
4	2483.50	50.0 AV	54.0	-4.0	2.38 V	11	51.0	-1.0
5	4934.00	41.9 PK	74.0	-32.1	2.34 V	140	38.3	3.6
6	4934.00	30.5 AV	54.0	-23.5	2.34 V	140	26.9	3.6
7	7401.00	46.9 PK	74.0	-27.1	3.60 V	146	36.7	10.2
8	7401.00	35.8 AV	54.0	-18.2	3.60 V	146	25.6	10.2

Remarks:

1. Emission Level(dBuV/m) = Raw Value(dBuV) + Correction Factor(dB/m)
2. Correction Factor(dB/m) = Antenna Factor(dB/m) + Cable Factor(dB) – Pre-Amplifier Factor(dB)
3. Margin value = Emission Level – Limit value
4. The other emission levels were very low against the limit.
5. " * " : Fundamental frequency, the limit was restricted at the RF Output Power.

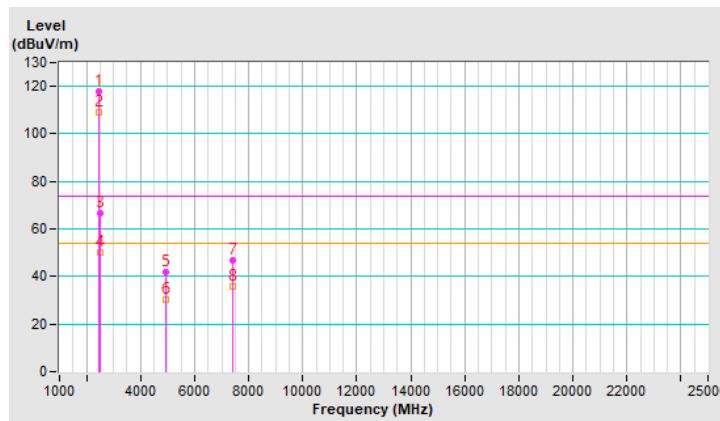

RF Mode	802.11be (EHT) 26-tone RU	Channel	CH 13 : 2472 MHz
Frequency Range	1 GHz ~ 25 GHz	Detector Function & Bandwidth	(PK) RB = 1 MHz, VB = 3 MHz (AV) RB = 1 MHz, VB = 2 kHz
Input Power (System)	120 Vac, 60Hz	Environmental Conditions	25°C, 68% RH
Tested By	Tom Yang		

Antenna Polarity & Test Distance : Horizontal at 3 m								
No	Frequency (MHz)	Emission Level (dBuV/m)	Limit (dBuV/m)	Margin (dB)	Antenna Height (m)	Table Angle (Degree)	Raw Value (dBuV)	Correction Factor (dB/m)
1	*2472.00	118.6 PK			2.48 H	67	119.5	-0.9
2	*2472.00	109.6 AV			2.48 H	67	110.5	-0.9
3	2483.50	67.9 PK	74.0	-6.1	2.48 H	67	68.9	-1.0
4	2483.50	53.8 AV	54.0	-0.2	2.48 H	67	54.8	-1.0
5	4944.00	44.4 PK	74.0	-29.6	1.19 H	126	40.7	3.7
6	4944.00	32.0 AV	54.0	-22.0	1.19 H	126	28.3	3.7
7	7416.00	42.7 PK	74.0	-31.3	2.10 H	349	32.5	10.2
8	7416.00	31.5 AV	54.0	-22.5	2.10 H	349	21.3	10.2

Remarks:

1. Emission Level(dBuV/m) = Raw Value(dBuV) + Correction Factor(dB/m)
2. Correction Factor(dB/m) = Antenna Factor(dB/m) + Cable Factor(dB) – Pre-Amplifier Factor(dB)
3. Margin value = Emission Level – Limit value
4. The other emission levels were very low against the limit.
5. " * " : Fundamental frequency, the limit was restricted at the RF Output Power.
6. The Band-edge measurements was follow ANSI C63.10 Section 11.13.3.

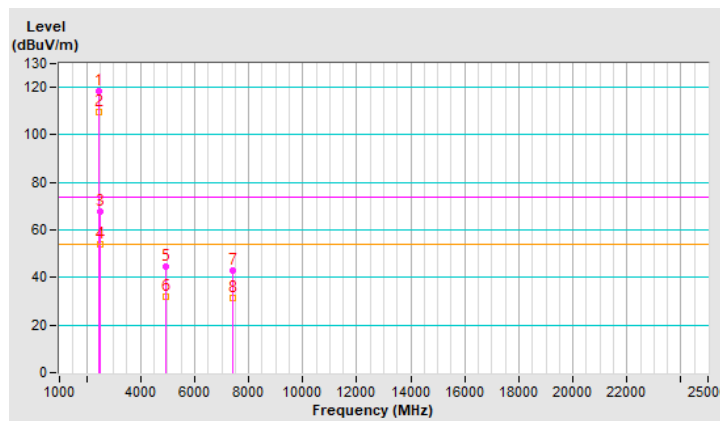

RF Mode	802.11be (EHT) 26-tone RU	Channel	CH 13 : 2472 MHz
Frequency Range	1 GHz ~ 25 GHz	Detector Function & Bandwidth	(PK) RB = 1 MHz, VB = 3 MHz (AV) RB = 1 MHz, VB = 2 kHz
Input Power (System)	120 Vac, 60Hz	Environmental Conditions	25°C, 68% RH
Tested By	Tom Yang		

Antenna Polarity & Test Distance : Vertical at 3 m								
No	Frequency (MHz)	Emission Level (dBuV/m)	Limit (dBuV/m)	Margin (dB)	Antenna Height (m)	Table Angle (Degree)	Raw Value (dBuV)	Correction Factor (dB/m)
1	*2472.00	114.5 PK			2.30 V	4	115.4	-0.9
2	*2472.00	105.9 AV			2.30 V	4	106.8	-0.9
3	2483.50	62.8 PK	74.0	-11.2	2.30 V	4	63.8	-1.0
4	2483.50	50.7 AV	54.0	-3.3	2.30 V	4	51.7	-1.0
5	4944.00	41.3 PK	74.0	-32.7	2.31 V	161	37.6	3.7
6	4944.00	30.0 AV	54.0	-24.0	2.31 V	161	26.3	3.7
7	7416.00	47.1 PK	74.0	-26.9	3.49 V	140	36.9	10.2
8	7416.00	35.8 AV	54.0	-18.2	3.49 V	140	25.6	10.2

Remarks:

1. Emission Level(dBuV/m) = Raw Value(dBuV) + Correction Factor(dB/m)
2. Correction Factor(dB/m) = Antenna Factor(dB/m) + Cable Factor(dB) – Pre-Amplifier Factor(dB)
3. Margin value = Emission Level – Limit value
4. The other emission levels were very low against the limit.
5. " * " : Fundamental frequency, the limit was restricted at the RF Output Power.
6. The Band-edge measurements was follow ANSI C63.10 Section 11.13.3.

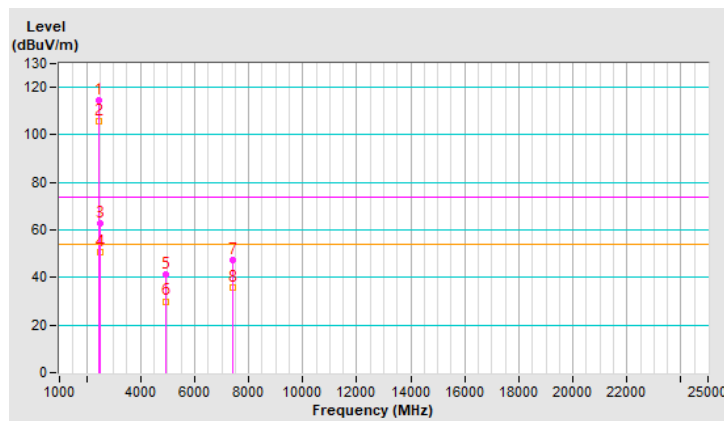

RF Mode	802.11be (EHT) 52-tone RU	Channel	CH 1 : 2412 MHz
Frequency Range	1 GHz ~ 25 GHz	Detector Function & Bandwidth	(PK) RB = 1 MHz, VB = 3 MHz (AV) RB = 1 MHz, VB = 3 kHz
Input Power (System)	120 Vac, 60Hz	Environmental Conditions	25°C, 68% RH
Tested By	Tom Yang		

Antenna Polarity & Test Distance : Horizontal at 3 m								
No	Frequency (MHz)	Emission Level (dBuV/m)	Limit (dBuV/m)	Margin (dB)	Antenna Height (m)	Table Angle (Degree)	Raw Value (dBuV)	Correction Factor (dB/m)
1	2390.00	73.8 PK	74.0	-0.2	2.95 H	73	74.7	-0.9
2	2390.00	53.8 AV	54.0	-0.2	2.95 H	73	54.7	-0.9
3	*2412.00	120.8 PK			2.95 H	73	121.7	-0.9
4	*2412.00	112.7 AV			2.95 H	73	113.6	-0.9
5	4824.00	44.1 PK	74.0	-29.9	1.15 H	110	40.7	3.4
6	4824.00	31.9 AV	54.0	-22.1	1.15 H	110	28.5	3.4

Remarks:

1. Emission Level(dBuV/m) = Raw Value(dBuV) + Correction Factor(dB/m)
2. Correction Factor(dB/m) = Antenna Factor(dB/m) + Cable Factor(dB) – Pre-Amplifier Factor(dB)
3. Margin value = Emission Level – Limit value
4. The other emission levels were very low against the limit.
5. " * " : Fundamental frequency, the limit was restricted at the RF Output Power.

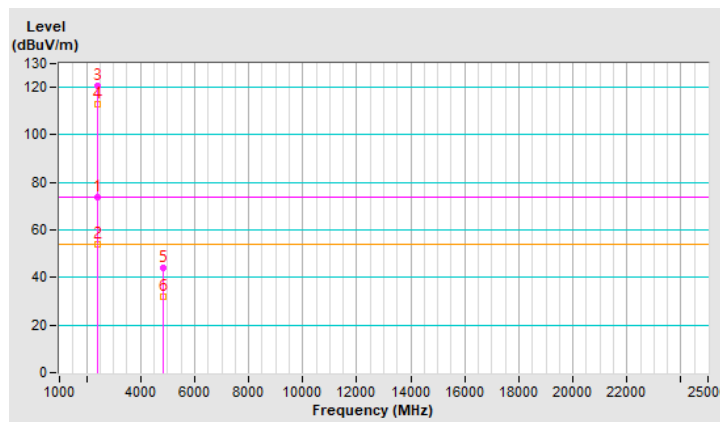

RF Mode	802.11be (EHT) 52-tone RU	Channel	CH 1 : 2412 MHz
Frequency Range	1 GHz ~ 25 GHz	Detector Function & Bandwidth	(PK) RB = 1 MHz, VB = 3 MHz (AV) RB = 1 MHz, VB = 3 kHz
Input Power (System)	120 Vac, 60Hz	Environmental Conditions	25°C, 68% RH
Tested By	Tom Yang		

Antenna Polarity & Test Distance : Vertical at 3 m								
No	Frequency (MHz)	Emission Level (dBuV/m)	Limit (dBuV/m)	Margin (dB)	Antenna Height (m)	Table Angle (Degree)	Raw Value (dBuV)	Correction Factor (dB/m)
1	2390.00	64.3 PK	74.0	-9.7	2.55 V	5	65.2	-0.9
2	2390.00	48.9 AV	54.0	-5.1	2.55 V	5	49.8	-0.9
3	*2412.00	120.5 PK			2.55 V	5	121.4	-0.9
4	*2412.00	110.2 AV			2.55 V	5	111.1	-0.9
5	4824.00	41.5 PK	74.0	-32.5	2.41 V	183	38.1	3.4
6	4824.00	30.2 AV	54.0	-23.8	2.41 V	183	26.8	3.4

Remarks:

1. Emission Level(dBuV/m) = Raw Value(dBuV) + Correction Factor(dB/m)
2. Correction Factor(dB/m) = Antenna Factor(dB/m) + Cable Factor(dB) – Pre-Amplifier Factor(dB)
3. Margin value = Emission Level – Limit value
4. The other emission levels were very low against the limit.
5. " * " : Fundamental frequency, the limit was restricted at the RF Output Power.

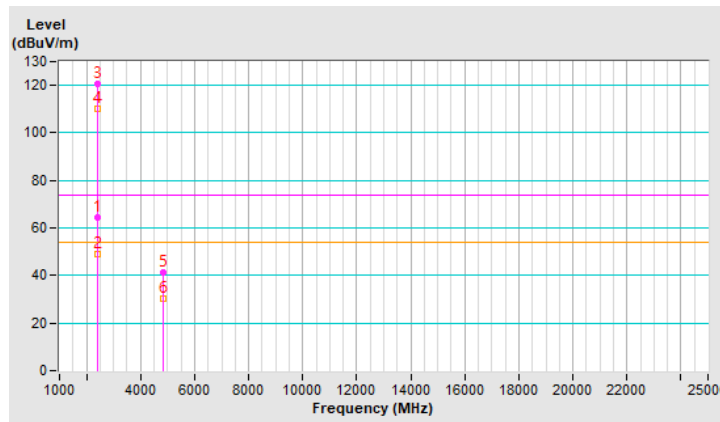

RF Mode	802.11be (EHT) 52-tone RU	Channel	CH 6 : 2437 MHz
Frequency Range	1 GHz ~ 25 GHz	Detector Function & Bandwidth	(PK) RB = 1 MHz, VB = 3 MHz (AV) RB = 1 MHz, VB = 3 kHz
Input Power (System)	120 Vac, 60Hz	Environmental Conditions	25°C, 68% RH
Tested By	Tom Yang		

Antenna Polarity & Test Distance : Horizontal at 3 m								
No	Frequency (MHz)	Emission Level (dBuV/m)	Limit (dBuV/m)	Margin (dB)	Antenna Height (m)	Table Angle (Degree)	Raw Value (dBuV)	Correction Factor (dB/m)
1	2390.00	70.8 PK	74.0	-3.2	2.63 H	63	71.7	-0.9
2	2390.00	53.5 AV	54.0	-0.5	2.63 H	63	54.4	-0.9
3	*2437.00	129.1 PK			2.63 H	63	129.9	-0.8
4	*2437.00	117.5 AV			2.63 H	63	118.3	-0.8
5	2483.50	65.5 PK	74.0	-8.5	2.63 H	63	66.5	-1.0
6	2483.50	53.9 AV	54.0	-0.1	2.63 H	63	54.9	-1.0
7	4874.00	51.6 PK	74.0	-22.4	1.17 H	123	48.1	3.5
8	4874.00	38.5 AV	54.0	-15.5	1.17 H	123	35.0	3.5
9	7311.00	50.8 PK	74.0	-23.2	2.10 H	334	40.7	10.1
10	7311.00	39.3 AV	54.0	-14.7	2.10 H	334	29.2	10.1

Remarks:

1. Emission Level(dBuV/m) = Raw Value(dBuV) + Correction Factor(dB/m)
2. Correction Factor(dB/m) = Antenna Factor(dB/m) + Cable Factor(dB) – Pre-Amplifier Factor(dB)
3. Margin value = Emission Level – Limit value
4. The other emission levels were very low against the limit.
5. " * " : Fundamental frequency, the limit was restricted at the RF Output Power.

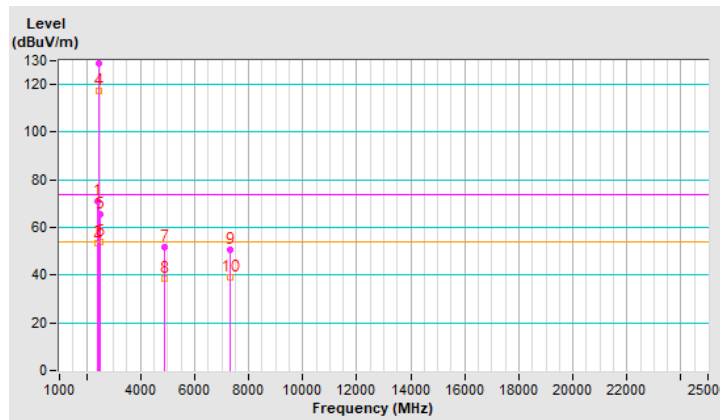

RF Mode	802.11be (EHT) 52-tone RU	Channel	CH 6 : 2437 MHz
Frequency Range	1 GHz ~ 25 GHz	Detector Function & Bandwidth	(PK) RB = 1 MHz, VB = 3 MHz (AV) RB = 1 MHz, VB = 3 kHz
Input Power (System)	120 Vac, 60Hz	Environmental Conditions	25°C, 68% RH
Tested By	Tom Yang		

Antenna Polarity & Test Distance : Vertical at 3 m								
No	Frequency (MHz)	Emission Level (dBuV/m)	Limit (dBuV/m)	Margin (dB)	Antenna Height (m)	Table Angle (Degree)	Raw Value (dBuV)	Correction Factor (dB/m)
1	2390.00	64.5 PK	74.0	-9.5	2.53 V	19	65.4	-0.9
2	2390.00	48.9 AV	54.0	-5.1	2.53 V	19	49.8	-0.9
3	*2437.00	125.7 PK			2.53 V	19	126.5	-0.8
4	*2437.00	114.6 AV			2.53 V	19	115.4	-0.8
5	2483.50	60.0 PK	74.0	-14.0	2.53 V	19	61.0	-1.0
6	2483.50	48.4 AV	54.0	-5.6	2.53 V	19	49.4	-1.0
7	4874.00	48.7 PK	74.0	-25.3	2.30 V	159	45.2	3.5
8	4874.00	37.9 AV	54.0	-16.1	2.30 V	159	34.4	3.5
9	7311.00	52.7 PK	74.0	-21.3	3.57 V	161	42.6	10.1
10	7311.00	42.3 AV	54.0	-11.7	3.57 V	161	32.2	10.1

Remarks:

1. Emission Level(dBuV/m) = Raw Value(dBuV) + Correction Factor(dB/m)
2. Correction Factor(dB/m) = Antenna Factor(dB/m) + Cable Factor(dB) – Pre-Amplifier Factor(dB)
3. Margin value = Emission Level – Limit value
4. The other emission levels were very low against the limit.
5. " * ": Fundamental frequency, the limit was restricted at the RF Output Power.

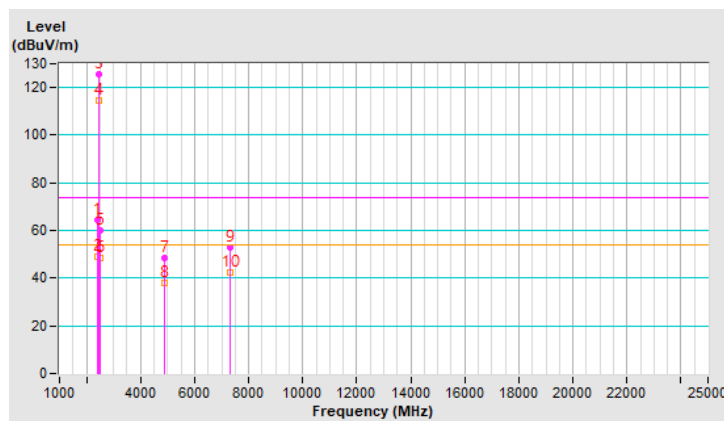

RF Mode	802.11be (EHT) 52-tone RU	Channel	CH 11 : 2462 MHz
Frequency Range	1 GHz ~ 25 GHz	Detector Function & Bandwidth	(PK) RB = 1 MHz, VB = 3 MHz (AV) RB = 1 MHz, VB = 3 kHz
Input Power (System)	120 Vac, 60Hz	Environmental Conditions	25°C, 68% RH
Tested By	Tom Yang		

Antenna Polarity & Test Distance : Horizontal at 3 m								
No	Frequency (MHz)	Emission Level (dBuV/m)	Limit (dBuV/m)	Margin (dB)	Antenna Height (m)	Table Angle (Degree)	Raw Value (dBuV)	Correction Factor (dB/m)
1	*2462.00	120.5 PK			2.72 H	65	121.3	-0.8
2	*2462.00	112.4 AV			2.72 H	65	113.2	-0.8
3	2483.50	67.7 PK	74.0	-6.3	2.72 H	65	68.7	-1.0
4	2483.50	53.8 AV	54.0	-0.2	2.72 H	65	54.8	-1.0
5	4924.00	44.0 PK	74.0	-30.0	1.18 H	124	40.4	3.6
6	4924.00	31.6 AV	54.0	-22.4	1.18 H	124	28.0	3.6
7	7386.00	43.2 PK	74.0	-30.8	2.13 H	340	33.0	10.2
8	7386.00	31.7 AV	54.0	-22.3	2.13 H	340	21.5	10.2

Remarks:

1. Emission Level(dBuV/m) = Raw Value(dBuV) + Correction Factor(dB/m)
2. Correction Factor(dB/m) = Antenna Factor(dB/m) + Cable Factor(dB) – Pre-Amplifier Factor(dB)
3. Margin value = Emission Level – Limit value
4. The other emission levels were very low against the limit.
5. " * " : Fundamental frequency, the limit was restricted at the RF Output Power.

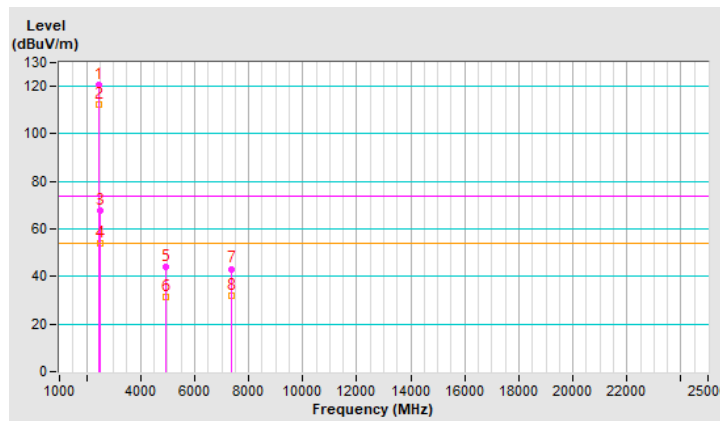

RF Mode	802.11be (EHT) 52-tone RU	Channel	CH 11 : 2462 MHz
Frequency Range	1 GHz ~ 25 GHz	Detector Function & Bandwidth	(PK) RB = 1 MHz, VB = 3 MHz (AV) RB = 1 MHz, VB = 3 kHz
Input Power (System)	120 Vac, 60Hz	Environmental Conditions	25°C, 68% RH
Tested By	Tom Yang		

Antenna Polarity & Test Distance : Vertical at 3 m								
No	Frequency (MHz)	Emission Level (dBuV/m)	Limit (dBuV/m)	Margin (dB)	Antenna Height (m)	Table Angle (Degree)	Raw Value (dBuV)	Correction Factor (dB/m)
1	*2462.00	117.7 PK			2.41 V	13	118.5	-0.8
2	*2462.00	109.0 AV			2.41 V	13	109.8	-0.8
3	2483.50	59.4 PK	74.0	-14.6	2.41 V	13	60.4	-1.0
4	2483.50	48.0 AV	54.0	-6.0	2.41 V	13	49.0	-1.0
5	4924.00	41.7 PK	74.0	-32.3	2.24 V	168	38.1	3.6
6	4924.00	30.2 AV	54.0	-23.8	2.24 V	168	26.6	3.6
7	7386.00	47.7 PK	74.0	-26.3	3.51 V	140	37.5	10.2
8	7386.00	36.2 AV	54.0	-17.8	3.51 V	140	26.0	10.2

Remarks:

1. Emission Level(dBuV/m) = Raw Value(dBuV) + Correction Factor(dB/m)
2. Correction Factor(dB/m) = Antenna Factor(dB/m) + Cable Factor(dB) – Pre-Amplifier Factor(dB)
3. Margin value = Emission Level – Limit value
4. The other emission levels were very low against the limit.
5. " * ": Fundamental frequency, the limit was restricted at the RF Output Power.

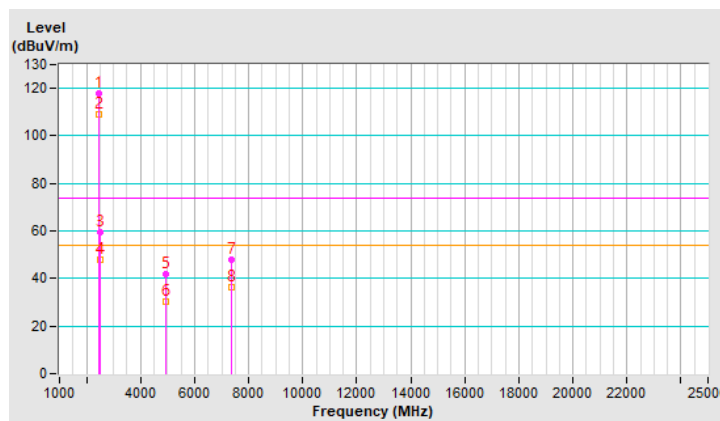

RF Mode	802.11be (EHT) 52-tone RU	Channel	CH 12 : 2467 MHz
Frequency Range	1 GHz ~ 25 GHz	Detector Function & Bandwidth	(PK) RB = 1 MHz, VB = 3 MHz (AV) RB = 1 MHz, VB = 3 kHz
Input Power (System)	120 Vac, 60Hz	Environmental Conditions	25°C, 68% RH
Tested By	Tom Yang		

Antenna Polarity & Test Distance : Horizontal at 3 m								
No	Frequency (MHz)	Emission Level (dBuV/m)	Limit (dBuV/m)	Margin (dB)	Antenna Height (m)	Table Angle (Degree)	Raw Value (dBuV)	Correction Factor (dB/m)
1	*2467.00	118.4 PK			2.62 H	62	119.2	-0.8
2	*2467.00	109.8 AV			2.62 H	62	110.6	-0.8
3	2483.50	66.9 PK	74.0	-7.1	2.62 H	62	67.9	-1.0
4	2483.50	53.5 AV	54.0	-0.5	2.62 H	62	54.5	-1.0
5	4934.00	44.4 PK	74.0	-29.6	1.18 H	141	40.8	3.6
6	4934.00	32.1 AV	54.0	-21.9	1.18 H	141	28.5	3.6
7	7401.00	42.9 PK	74.0	-31.1	2.05 H	355	32.7	10.2
8	7401.00	31.6 AV	54.0	-22.4	2.05 H	355	21.4	10.2

Remarks:

1. Emission Level(dBuV/m) = Raw Value(dBuV) + Correction Factor(dB/m)
2. Correction Factor(dB/m) = Antenna Factor(dB/m) + Cable Factor(dB) – Pre-Amplifier Factor(dB)
3. Margin value = Emission Level – Limit value
4. The other emission levels were very low against the limit.
5. " * " : Fundamental frequency, the limit was restricted at the RF Output Power.

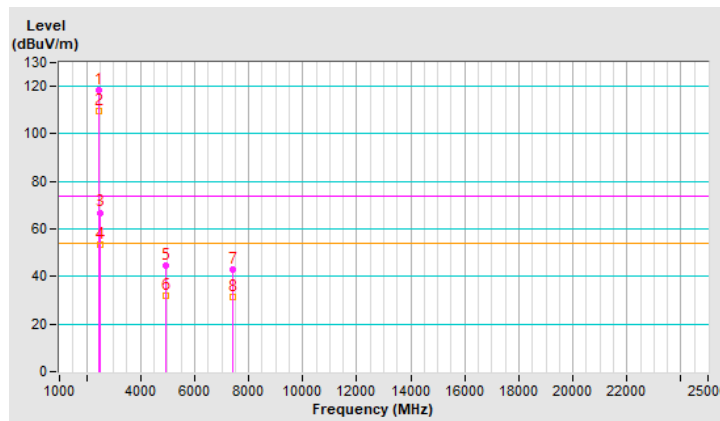

RF Mode	802.11be (EHT) 52-tone RU	Channel	CH 12 : 2467 MHz
Frequency Range	1 GHz ~ 25 GHz	Detector Function & Bandwidth	(PK) RB = 1 MHz, VB = 3 MHz (AV) RB = 1 MHz, VB = 3 kHz
Input Power (System)	120 Vac, 60Hz	Environmental Conditions	25°C, 68% RH
Tested By	Tom Yang		

Antenna Polarity & Test Distance : Vertical at 3 m								
No	Frequency (MHz)	Emission Level (dBuV/m)	Limit (dBuV/m)	Margin (dB)	Antenna Height (m)	Table Angle (Degree)	Raw Value (dBuV)	Correction Factor (dB/m)
1	*2467.00	115.6 PK			2.39 V	13	116.4	-0.8
2	*2467.00	106.1 AV			2.39 V	13	106.9	-0.8
3	2483.50	61.9 PK	74.0	-12.1	2.39 V	13	62.9	-1.0
4	2483.50	48.7 AV	54.0	-5.3	2.39 V	13	49.7	-1.0
5	4934.00	41.8 PK	74.0	-32.2	2.26 V	164	38.2	3.6
6	4934.00	30.3 AV	54.0	-23.7	2.26 V	164	26.7	3.6
7	7401.00	47.5 PK	74.0	-26.5	3.52 V	152	37.3	10.2
8	7401.00	36.1 AV	54.0	-17.9	3.52 V	152	25.9	10.2

Remarks:

1. Emission Level(dBuV/m) = Raw Value(dBuV) + Correction Factor(dB/m)
2. Correction Factor(dB/m) = Antenna Factor(dB/m) + Cable Factor(dB) – Pre-Amplifier Factor(dB)
3. Margin value = Emission Level – Limit value
4. The other emission levels were very low against the limit.
5. " * ": Fundamental frequency, the limit was restricted at the RF Output Power.

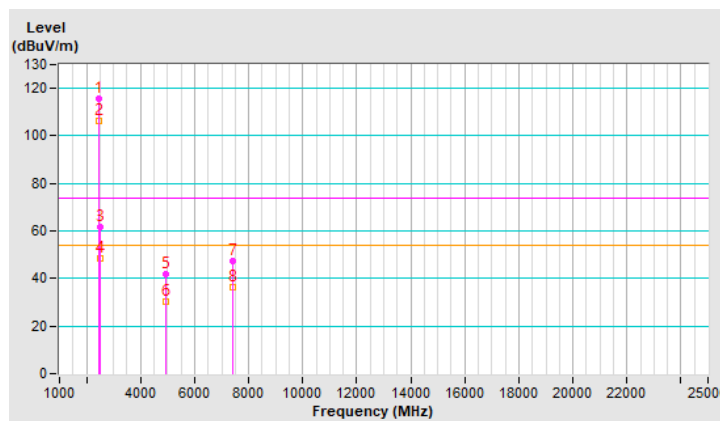

RF Mode	802.11be (EHT) 52-tone RU	Channel	CH 13 : 2472 MHz
Frequency Range	1 GHz ~ 25 GHz	Detector Function & Bandwidth	(PK) RB = 1 MHz, VB = 3 MHz (AV) RB = 1 MHz, VB = 3 kHz
Input Power (System)	120 Vac, 60Hz	Environmental Conditions	25°C, 68% RH
Tested By	Tom Yang		

Antenna Polarity & Test Distance : Horizontal at 3 m								
No	Frequency (MHz)	Emission Level (dBuV/m)	Limit (dBuV/m)	Margin (dB)	Antenna Height (m)	Table Angle (Degree)	Raw Value (dBuV)	Correction Factor (dB/m)
1	*2472.00	116.9 PK			2.65 H	52	117.8	-0.9
2	*2472.00	107.6 AV			2.65 H	52	108.5	-0.9
3	2483.50	64.4 PK	74.0	-9.6	2.65 H	52	65.4	-1.0
4	2483.50	53.5 AV	54.0	-0.5	2.65 H	52	54.5	-1.0
5	4944.00	43.9 PK	74.0	-30.1	1.20 H	111	40.2	3.7
6	4944.00	31.7 AV	54.0	-22.3	1.20 H	111	28.0	3.7
7	7416.00	42.1 PK	74.0	-31.9	2.05 H	334	31.9	10.2
8	7416.00	31.0 AV	54.0	-23.0	2.05 H	334	20.8	10.2

Remarks:

1. Emission Level(dBuV/m) = Raw Value(dBuV) + Correction Factor(dB/m)
2. Correction Factor(dB/m) = Antenna Factor(dB/m) + Cable Factor(dB) – Pre-Amplifier Factor(dB)
3. Margin value = Emission Level – Limit value
4. The other emission levels were very low against the limit.
5. " * " : Fundamental frequency, the limit was restricted at the RF Output Power.
6. The Band-edge measurements was follow ANSI C63.10 Section 11.13.3.

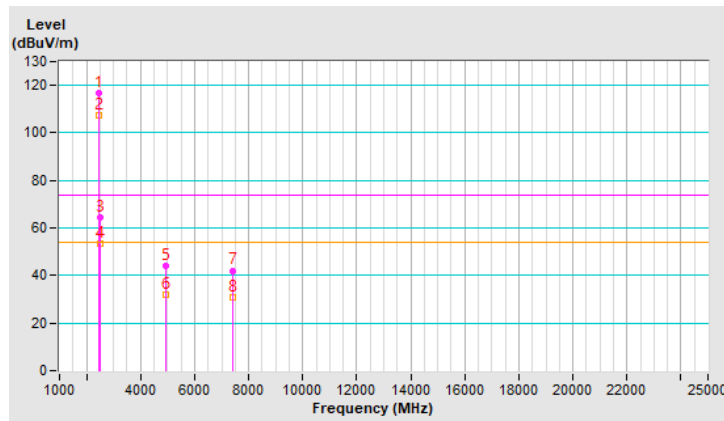

RF Mode	802.11be (EHT) 52-tone RU	Channel	CH 13 : 2472 MHz
Frequency Range	1 GHz ~ 25 GHz	Detector Function & Bandwidth	(PK) RB = 1 MHz, VB = 3 MHz (AV) RB = 1 MHz, VB = 3 kHz
Input Power (System)	120 Vac, 60Hz	Environmental Conditions	25°C, 68% RH
Tested By	Tom Yang		

Antenna Polarity & Test Distance : Vertical at 3 m								
No	Frequency (MHz)	Emission Level (dBuV/m)	Limit (dBuV/m)	Margin (dB)	Antenna Height (m)	Table Angle (Degree)	Raw Value (dBuV)	Correction Factor (dB/m)
1	*2472.00	113.9 PK			2.32 V	12	114.8	-0.9
2	*2472.00	103.7 AV			2.32 V	12	104.6	-0.9
3	2483.50	63.7 PK	74.0	-10.3	2.32 V	12	64.7	-1.0
4	2483.50	51.8 AV	54.0	-2.2	2.32 V	12	52.8	-1.0
5	4944.00	41.3 PK	74.0	-32.7	2.31 V	161	37.6	3.7
6	4944.00	29.9 AV	54.0	-24.1	2.31 V	161	26.2	3.7
7	7416.00	47.3 PK	74.0	-26.7	3.47 V	145	37.1	10.2
8	7416.00	36.0 AV	54.0	-18.0	3.47 V	145	25.8	10.2

Remarks:

1. Emission Level(dBuV/m) = Raw Value(dBuV) + Correction Factor(dB/m)
2. Correction Factor(dB/m) = Antenna Factor(dB/m) + Cable Factor(dB) – Pre-Amplifier Factor(dB)
3. Margin value = Emission Level – Limit value
4. The other emission levels were very low against the limit.
5. " * " : Fundamental frequency, the limit was restricted at the RF Output Power.
6. The Band-edge measurements was follow ANSI C63.10 Section 11.13.3.

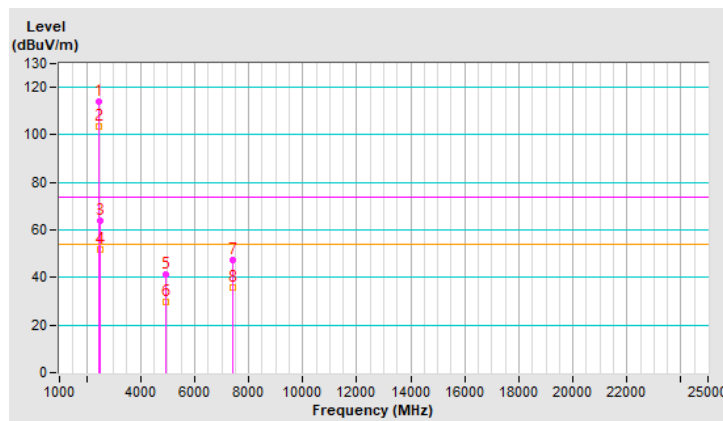

RF Mode	802.11be (EHT) 106-tone RU	Channel	CH 1 : 2412 MHz
Frequency Range	1 GHz ~ 25 GHz	Detector Function & Bandwidth	(PK) RB = 1 MHz, VB = 3 MHz (AV) RB = 1 MHz, VB = 3 kHz
Input Power (System)	120 Vac, 60Hz	Environmental Conditions	25°C, 68% RH
Tested By	Tom Yang		

Antenna Polarity & Test Distance : Horizontal at 3 m								
No	Frequency (MHz)	Emission Level (dBuV/m)	Limit (dBuV/m)	Margin (dB)	Antenna Height (m)	Table Angle (Degree)	Raw Value (dBuV)	Correction Factor (dB/m)
1	2390.00	71.3 PK	74.0	-2.7	3.03 H	61	72.2	-0.9
2	2390.00	53.5 AV	54.0	-0.5	3.03 H	61	54.4	-0.9
3	*2412.00	119.1 PK			3.03 H	61	120.0	-0.9
4	*2412.00	110.1 AV			3.03 H	61	111.0	-0.9
5	4824.00	44.6 PK	74.0	-29.4	1.21 H	115	41.2	3.4
6	4824.00	32.6 AV	54.0	-21.4	1.21 H	115	29.2	3.4

Remarks:

1. Emission Level(dBuV/m) = Raw Value(dBuV) + Correction Factor(dB/m)
2. Correction Factor(dB/m) = Antenna Factor(dB/m) + Cable Factor(dB) – Pre-Amplifier Factor(dB)
3. Margin value = Emission Level – Limit value
4. The other emission levels were very low against the limit.
5. " * " : Fundamental frequency, the limit was restricted at the RF Output Power.

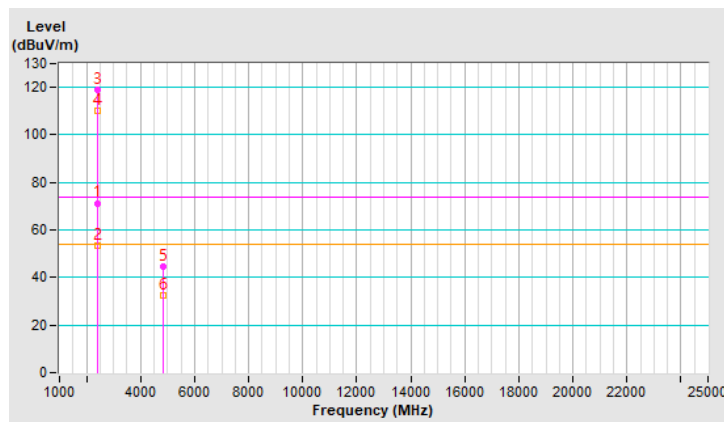

RF Mode	802.11be (EHT) 106-tone RU	Channel	CH 1 : 2412 MHz
Frequency Range	1 GHz ~ 25 GHz	Detector Function & Bandwidth	(PK) RB = 1 MHz, VB = 3 MHz (AV) RB = 1 MHz, VB = 3 kHz
Input Power (System)	120 Vac, 60Hz	Environmental Conditions	25°C, 68% RH
Tested By	Tom Yang		

Antenna Polarity & Test Distance : Vertical at 3 m								
No	Frequency (MHz)	Emission Level (dBuV/m)	Limit (dBuV/m)	Margin (dB)	Antenna Height (m)	Table Angle (Degree)	Raw Value (dBuV)	Correction Factor (dB/m)
1	2390.00	64.1 PK	74.0	-9.9	2.57 V	10	65.0	-0.9
2	2390.00	49.4 AV	54.0	-4.6	2.57 V	10	50.3	-0.9
3	*2412.00	115.6 PK			2.57 V	10	116.5	-0.9
4	*2412.00	107.3 AV			2.57 V	10	108.2	-0.9
5	4824.00	40.7 PK	74.0	-33.3	2.29 V	165	37.3	3.4
6	4824.00	29.9 AV	54.0	-24.1	2.29 V	165	26.5	3.4

Remarks:

1. Emission Level(dBuV/m) = Raw Value(dBuV) + Correction Factor(dB/m)
2. Correction Factor(dB/m) = Antenna Factor(dB/m) + Cable Factor(dB) – Pre-Amplifier Factor(dB)
3. Margin value = Emission Level – Limit value
4. The other emission levels were very low against the limit.
5. " * " : Fundamental frequency, the limit was restricted at the RF Output Power.

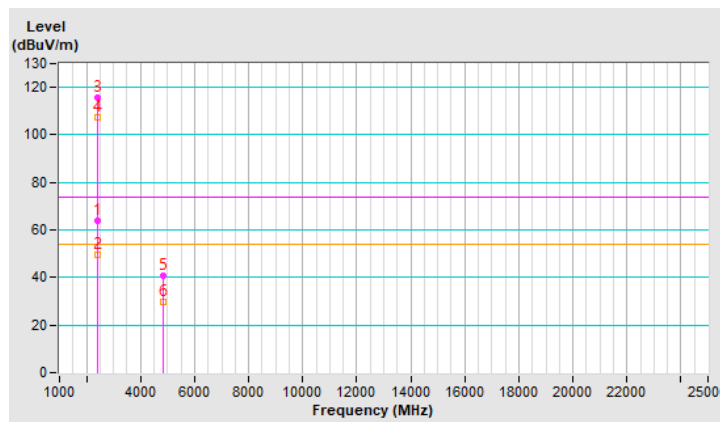

RF Mode	802.11be (EHT) 106-tone RU	Channel	CH 6 : 2437 MHz
Frequency Range	1 GHz ~ 25 GHz	Detector Function & Bandwidth	(PK) RB = 1 MHz, VB = 3 MHz (AV) RB = 1 MHz, VB = 3 kHz
Input Power (System)	120 Vac, 60Hz	Environmental Conditions	25°C, 68% RH
Tested By	Tom Yang		

Antenna Polarity & Test Distance : Horizontal at 3 m								
No	Frequency (MHz)	Emission Level (dBuV/m)	Limit (dBuV/m)	Margin (dB)	Antenna Height (m)	Table Angle (Degree)	Raw Value (dBuV)	Correction Factor (dB/m)
1	2390.00	70.2 PK	74.0	-3.8	2.51 H	61	71.1	-0.9
2	2390.00	53.9 AV	54.0	-0.1	2.51 H	61	54.8	-0.9
3	*2437.00	126.6 PK			2.51 H	61	127.4	-0.8
4	*2437.00	116.1 AV			2.51 H	61	116.9	-0.8
5	2483.50	65.2 PK	74.0	-8.8	2.51 H	61	66.2	-1.0
6	2483.50	53.7 AV	54.0	-0.3	2.51 H	61	54.7	-1.0
7	4874.00	49.6 PK	74.0	-24.4	1.14 H	108	46.1	3.5
8	4874.00	37.4 AV	54.0	-16.6	1.14 H	108	33.9	3.5
9	7311.00	49.7 PK	74.0	-24.3	2.16 H	319	39.6	10.1
10	7311.00	38.0 AV	54.0	-16.0	2.16 H	319	27.9	10.1

Remarks:

1. Emission Level(dBuV/m) = Raw Value(dBuV) + Correction Factor(dB/m)
2. Correction Factor(dB/m) = Antenna Factor(dB/m) + Cable Factor(dB) – Pre-Amplifier Factor(dB)
3. Margin value = Emission Level – Limit value
4. The other emission levels were very low against the limit.
5. " * " : Fundamental frequency, the limit was restricted at the RF Output Power.

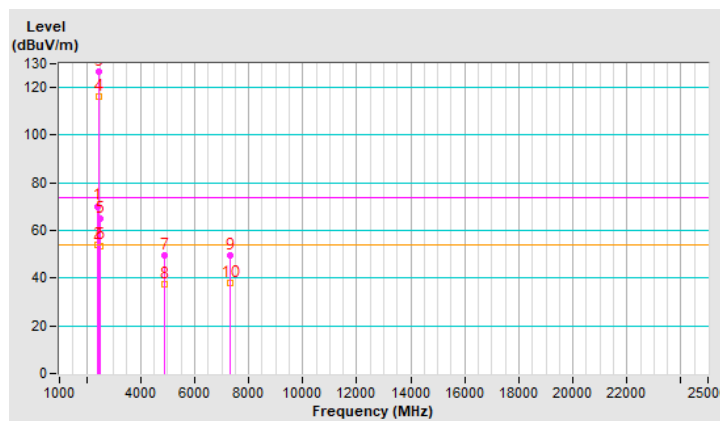

RF Mode	802.11be (EHT) 106-tone RU	Channel	CH 6 : 2437 MHz
Frequency Range	1 GHz ~ 25 GHz	Detector Function & Bandwidth	(PK) RB = 1 MHz, VB = 3 MHz (AV) RB = 1 MHz, VB = 3 kHz
Input Power (System)	120 Vac, 60Hz	Environmental Conditions	25°C, 68% RH
Tested By	Tom Yang		

Antenna Polarity & Test Distance : Vertical at 3 m								
No	Frequency (MHz)	Emission Level (dBuV/m)	Limit (dBuV/m)	Margin (dB)	Antenna Height (m)	Table Angle (Degree)	Raw Value (dBuV)	Correction Factor (dB/m)
1	2390.00	63.5 PK	74.0	-10.5	2.57 V	22	64.4	-0.9
2	2390.00	48.9 AV	54.0	-5.1	2.57 V	22	49.8	-0.9
3	*2437.00	121.4 PK			2.57 V	22	122.2	-0.8
4	*2437.00	113.7 AV			2.57 V	22	114.5	-0.8
5	2483.50	62.4 PK	74.0	-11.6	2.57 V	22	63.4	-1.0
6	2483.50	47.8 AV	54.0	-6.2	2.57 V	22	48.8	-1.0
7	4874.00	48.4 PK	74.0	-25.6	2.27 V	152	44.9	3.5
8	4874.00	36.8 AV	54.0	-17.2	2.27 V	152	33.3	3.5
9	7311.00	51.2 PK	74.0	-22.8	3.53 V	165	41.1	10.1
10	7311.00	40.9 AV	54.0	-13.1	3.53 V	165	30.8	10.1

Remarks:

1. Emission Level(dBuV/m) = Raw Value(dBuV) + Correction Factor(dB/m)
2. Correction Factor(dB/m) = Antenna Factor(dB/m) + Cable Factor(dB) – Pre-Amplifier Factor(dB)
3. Margin value = Emission Level – Limit value
4. The other emission levels were very low against the limit.
5. " * ": Fundamental frequency, the limit was restricted at the RF Output Power.

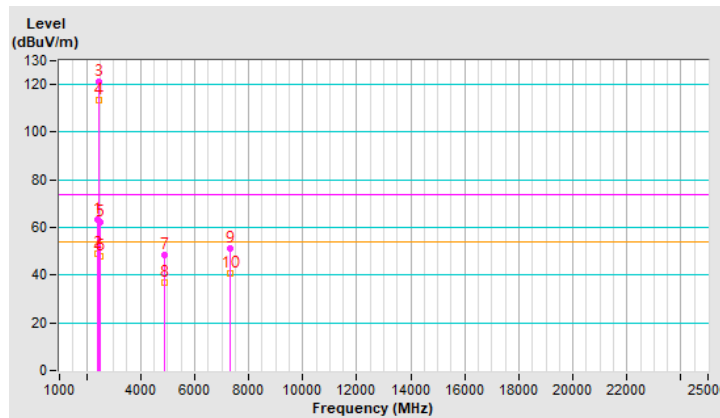

RF Mode	802.11be (EHT) 106-tone RU	Channel	CH 11 : 2462 MHz
Frequency Range	1 GHz ~ 25 GHz	Detector Function & Bandwidth	(PK) RB = 1 MHz, VB = 3 MHz (AV) RB = 1 MHz, VB = 3 kHz
Input Power (System)	120 Vac, 60Hz	Environmental Conditions	25°C, 68% RH
Tested By	Tom Yang		

Antenna Polarity & Test Distance : Horizontal at 3 m								
No	Frequency (MHz)	Emission Level (dBuV/m)	Limit (dBuV/m)	Margin (dB)	Antenna Height (m)	Table Angle (Degree)	Raw Value (dBuV)	Correction Factor (dB/m)
1	*2462.00	119.6 PK			2.48 H	52	120.4	-0.8
2	*2462.00	109.5 AV			2.48 H	52	110.3	-0.8
3	2483.50	67.6 PK	74.0	-6.4	2.48 H	52	68.6	-1.0
4	2483.50	53.8 AV	54.0	-0.2	2.48 H	52	54.8	-1.0
5	4924.00	44.4 PK	74.0	-29.6	1.16 H	110	40.8	3.6
6	4924.00	32.2 AV	54.0	-21.8	1.16 H	110	28.6	3.6
7	7386.00	43.4 PK	74.0	-30.6	2.07 H	349	33.2	10.2
8	7386.00	31.9 AV	54.0	-22.1	2.07 H	349	21.7	10.2

Remarks:

1. Emission Level(dBuV/m) = Raw Value(dBuV) + Correction Factor(dB/m)
2. Correction Factor(dB/m) = Antenna Factor(dB/m) + Cable Factor(dB) – Pre-Amplifier Factor(dB)
3. Margin value = Emission Level – Limit value
4. The other emission levels were very low against the limit.
5. " * ": Fundamental frequency, the limit was restricted at the RF Output Power.

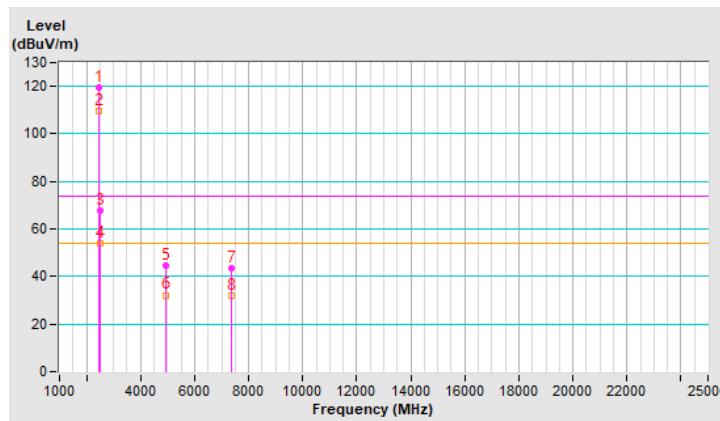

RF Mode	802.11be (EHT) 106-tone RU	Channel	CH 11 : 2462 MHz
Frequency Range	1 GHz ~ 25 GHz	Detector Function & Bandwidth	(PK) RB = 1 MHz, VB = 3 MHz (AV) RB = 1 MHz, VB = 3 kHz
Input Power (System)	120 Vac, 60Hz	Environmental Conditions	25°C, 68% RH
Tested By	Tom Yang		

Antenna Polarity & Test Distance : Vertical at 3 m								
No	Frequency (MHz)	Emission Level (dBuV/m)	Limit (dBuV/m)	Margin (dB)	Antenna Height (m)	Table Angle (Degree)	Raw Value (dBuV)	Correction Factor (dB/m)
1	*2462.00	115.9 PK			2.40 V	12	116.7	-0.8
2	*2462.00	106.5 AV			2.40 V	12	107.3	-0.8
3	2483.50	62.3 PK	74.0	-11.7	2.40 V	12	63.3	-1.0
4	2483.50	47.9 AV	54.0	-6.1	2.40 V	12	48.9	-1.0
5	4924.00	41.5 PK	74.0	-32.5	2.36 V	176	37.9	3.6
6	4924.00	30.4 AV	54.0	-23.6	2.36 V	176	26.8	3.6
7	7386.00	47.0 PK	74.0	-27.0	3.49 V	125	36.8	10.2
8	7386.00	35.7 AV	54.0	-18.3	3.49 V	125	25.5	10.2

Remarks:

1. Emission Level(dBuV/m) = Raw Value(dBuV) + Correction Factor(dB/m)
2. Correction Factor(dB/m) = Antenna Factor(dB/m) + Cable Factor(dB) – Pre-Amplifier Factor(dB)
3. Margin value = Emission Level – Limit value
4. The other emission levels were very low against the limit.
5. " * " : Fundamental frequency, the limit was restricted at the RF Output Power.

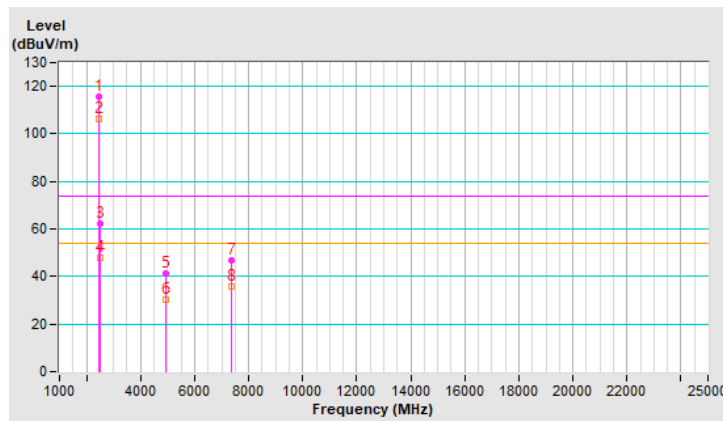

RF Mode	802.11be (EHT) 106-tone RU	Channel	CH 12 : 2467 MHz
Frequency Range	1 GHz ~ 25 GHz	Detector Function & Bandwidth	(PK) RB = 1 MHz, VB = 3 MHz (AV) RB = 1 MHz, VB = 3 kHz
Input Power (System)	120 Vac, 60Hz	Environmental Conditions	25°C, 68% RH
Tested By	Tom Yang		

Antenna Polarity & Test Distance : Horizontal at 3 m								
No	Frequency (MHz)	Emission Level (dBuV/m)	Limit (dBuV/m)	Margin (dB)	Antenna Height (m)	Table Angle (Degree)	Raw Value (dBuV)	Correction Factor (dB/m)
1	*2467.00	117.8 PK			2.49 H	58	118.6	-0.8
2	*2467.00	107.8 AV			2.49 H	58	108.6	-0.8
3	2483.50	71.6 PK	74.0	-2.4	2.49 H	58	72.6	-1.0
4	2483.50	53.7 AV	54.0	-0.3	2.49 H	58	54.7	-1.0
5	4934.00	44.7 PK	74.0	-29.3	1.20 H	124	41.1	3.6
6	4934.00	32.4 AV	54.0	-21.6	1.20 H	124	28.8	3.6
7	7401.00	43.2 PK	74.0	-30.8	2.12 H	339	33.0	10.2
8	7401.00	31.8 AV	54.0	-22.2	2.12 H	339	21.6	10.2

Remarks:

1. Emission Level(dBuV/m) = Raw Value(dBuV) + Correction Factor(dB/m)
2. Correction Factor(dB/m) = Antenna Factor(dB/m) + Cable Factor(dB) – Pre-Amplifier Factor(dB)
3. Margin value = Emission Level – Limit value
4. The other emission levels were very low against the limit.
5. " * " : Fundamental frequency, the limit was restricted at the RF Output Power.

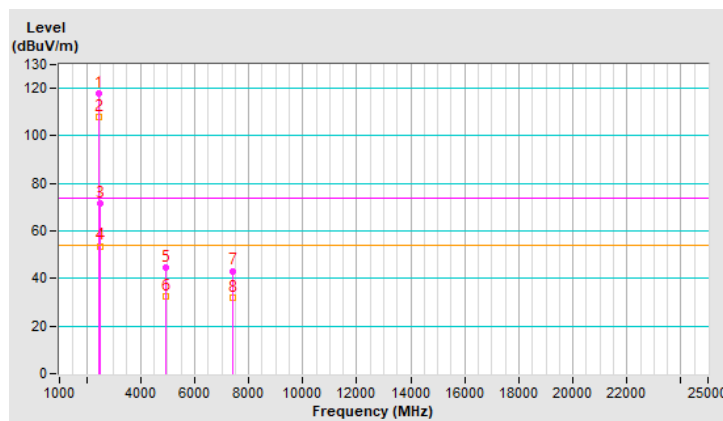

RF Mode	802.11be (EHT) 106-tone RU	Channel	CH 12 : 2467 MHz
Frequency Range	1 GHz ~ 25 GHz	Detector Function & Bandwidth	(PK) RB = 1 MHz, VB = 3 MHz (AV) RB = 1 MHz, VB = 3 kHz
Input Power (System)	120 Vac, 60Hz	Environmental Conditions	25°C, 68% RH
Tested By	Tom Yang		

Antenna Polarity & Test Distance : Vertical at 3 m								
No	Frequency (MHz)	Emission Level (dBuV/m)	Limit (dBuV/m)	Margin (dB)	Antenna Height (m)	Table Angle (Degree)	Raw Value (dBuV)	Correction Factor (dB/m)
1	*2467.00	111.7 PK			2.20 V	8	112.5	-0.8
2	*2467.00	102.4 AV			2.20 V	8	103.2	-0.8
3	2483.50	60.1 PK	74.0	-13.9	2.20 V	8	61.1	-1.0
4	2483.50	48.1 AV	54.0	-5.9	2.20 V	8	49.1	-1.0
5	4934.00	40.9 PK	74.0	-33.1	2.27 V	172	37.3	3.6
6	4934.00	29.8 AV	54.0	-24.2	2.27 V	172	26.2	3.6
7	7401.00	47.0 PK	74.0	-27.0	3.45 V	134	36.8	10.2
8	7401.00	35.5 AV	54.0	-18.5	3.45 V	134	25.3	10.2

Remarks:

1. Emission Level(dBuV/m) = Raw Value(dBuV) + Correction Factor(dB/m)
2. Correction Factor(dB/m) = Antenna Factor(dB/m) + Cable Factor(dB) – Pre-Amplifier Factor(dB)
3. Margin value = Emission Level – Limit value
4. The other emission levels were very low against the limit.
5. " * " : Fundamental frequency, the limit was restricted at the RF Output Power.

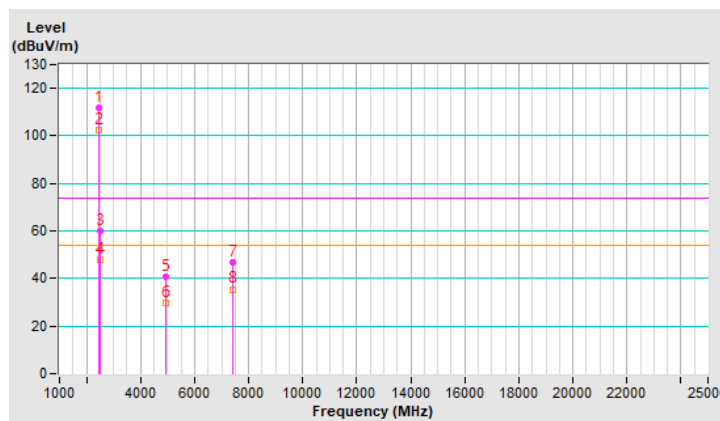

RF Mode	802.11be (EHT) 106-tone RU	Channel	CH 13 : 2472 MHz
Frequency Range	1 GHz ~ 25 GHz	Detector Function & Bandwidth	(PK) RB = 1 MHz, VB = 3 MHz (AV) RB = 1 MHz, VB = 3 kHz
Input Power (System)	120 Vac, 60Hz	Environmental Conditions	25°C, 68% RH
Tested By	Tom Yang		

Antenna Polarity & Test Distance : Horizontal at 3 m								
No	Frequency (MHz)	Emission Level (dBuV/m)	Limit (dBuV/m)	Margin (dB)	Antenna Height (m)	Table Angle (Degree)	Raw Value (dBuV)	Correction Factor (dB/m)
1	*2472.00	113.3 PK			2.89 H	56	114.2	-0.9
2	*2472.00	103.9 AV			2.89 H	56	104.8	-0.9
3	2483.50	63.7 PK	74.0	-10.3	2.89 H	56	64.7	-1.0
4	2483.50	53.5 AV	54.0	-0.5	2.89 H	56	54.5	-1.0
5	4944.00	44.6 PK	74.0	-29.4	1.18 H	136	40.9	3.7
6	4944.00	32.4 AV	54.0	-21.6	1.18 H	136	28.7	3.7
7	7416.00	43.4 PK	74.0	-30.6	2.15 H	355	33.2	10.2
8	7416.00	31.9 AV	54.0	-22.1	2.15 H	355	21.7	10.2

Remarks:

1. Emission Level(dBuV/m) = Raw Value(dBuV) + Correction Factor(dB/m)
2. Correction Factor(dB/m) = Antenna Factor(dB/m) + Cable Factor(dB) – Pre-Amplifier Factor(dB)
3. Margin value = Emission Level – Limit value
4. The other emission levels were very low against the limit.
5. " * " : Fundamental frequency, the limit was restricted at the RF Output Power.
6. The Band-edge measurements was follow ANSI C63.10 Section 11.13.3.

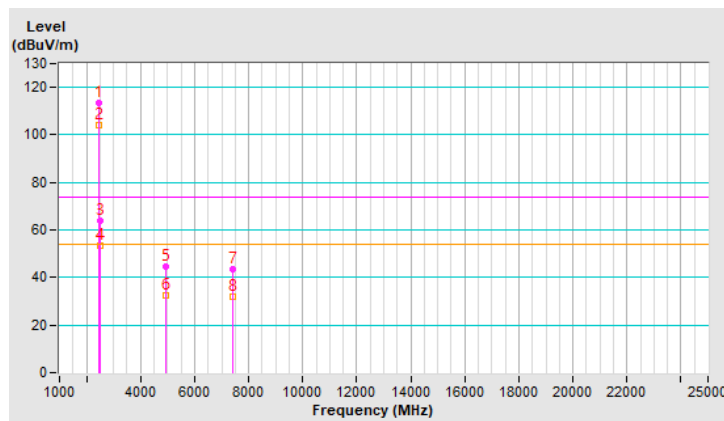

RF Mode	802.11be (EHT) 106-tone RU	Channel	CH 13 : 2472 MHz
Frequency Range	1 GHz ~ 25 GHz	Detector Function & Bandwidth	(PK) RB = 1 MHz, VB = 3 MHz (AV) RB = 1 MHz, VB = 3 kHz
Input Power (System)	120 Vac, 60Hz	Environmental Conditions	25°C, 68% RH
Tested By	Tom Yang		

Antenna Polarity & Test Distance : Vertical at 3 m								
No	Frequency (MHz)	Emission Level (dBuV/m)	Limit (dBuV/m)	Margin (dB)	Antenna Height (m)	Table Angle (Degree)	Raw Value (dBuV)	Correction Factor (dB/m)
1	*2472.00	111.0 PK			2.26 V	15	111.9	-0.9
2	*2472.00	100.9 AV			2.26 V	15	101.8	-0.9
3	2483.50	62.6 PK	74.0	-11.4	2.26 V	15	63.6	-1.0
4	2483.50	51.4 AV	54.0	-2.6	2.26 V	15	52.4	-1.0
5	4944.00	41.1 PK	74.0	-32.9	2.35 V	167	37.4	3.7
6	4944.00	30.0 AV	54.0	-24.0	2.35 V	167	26.3	3.7
7	7416.00	47.2 PK	74.0	-26.8	3.47 V	134	37.0	10.2
8	7416.00	35.6 AV	54.0	-18.4	3.47 V	134	25.4	10.2

Remarks:

1. Emission Level(dBuV/m) = Raw Value(dBuV) + Correction Factor(dB/m)
2. Correction Factor(dB/m) = Antenna Factor(dB/m) + Cable Factor(dB) – Pre-Amplifier Factor(dB)
3. Margin value = Emission Level – Limit value
4. The other emission levels were very low against the limit.
5. " * " : Fundamental frequency, the limit was restricted at the RF Output Power.
6. The Band-edge measurements was follow ANSI C63.10 Section 11.13.3.

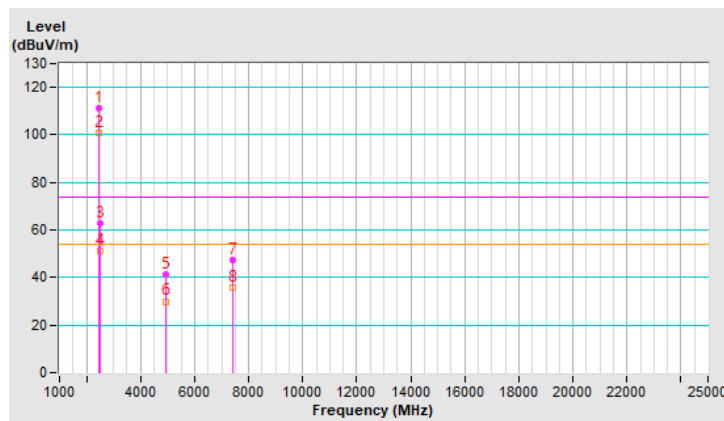

RF Mode	802.11be (EHT) 52+26-tone MRU	Channel	CH 1 : 2412 MHz
Frequency Range	1 GHz ~ 25 GHz	Detector Function & Bandwidth	(PK) RB = 1 MHz, VB = 3 MHz (AV) RB = 1 MHz, VB = 2 kHz
Input Power (System)	120 Vac, 60Hz	Environmental Conditions	25°C, 68% RH
Tested By	Tom Yang		

Antenna Polarity & Test Distance : Horizontal at 3 m								
No	Frequency (MHz)	Emission Level (dBuV/m)	Limit (dBuV/m)	Margin (dB)	Antenna Height (m)	Table Angle (Degree)	Raw Value (dBuV)	Correction Factor (dB/m)
1	2390.00	73.6 PK	74.0	-0.4	2.82 H	45	74.5	-0.9
2	2390.00	51.6 AV	54.0	-2.4	2.82 H	45	52.5	-0.9
3	*2412.00	123.7 PK			2.82 H	45	124.6	-0.9
4	*2412.00	113.5 AV			2.82 H	45	114.4	-0.9
5	4824.00	43.7 PK	74.0	-30.3	1.16 H	127	40.3	3.4
6	4824.00	32.0 AV	54.0	-22.0	1.16 H	127	28.6	3.4

Remarks:

1. Emission Level(dBuV/m) = Raw Value(dBuV) + Correction Factor(dB/m)
2. Correction Factor(dB/m) = Antenna Factor(dB/m) + Cable Factor(dB) – Pre-Amplifier Factor(dB)
3. Margin value = Emission Level – Limit value
4. The other emission levels were very low against the limit.
5. " * " : Fundamental frequency, the limit was restricted at the RF Output Power.

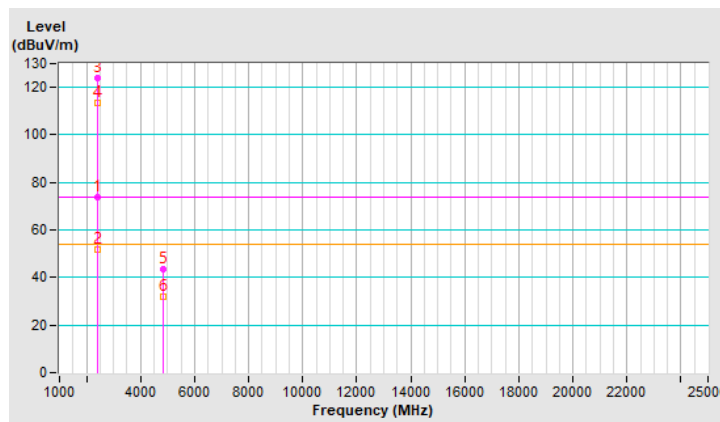

RF Mode	802.11be (EHT) 52+26-tone MRU	Channel	CH 1 : 2412 MHz
Frequency Range	1 GHz ~ 25 GHz	Detector Function & Bandwidth	(PK) RB = 1 MHz, VB = 3 MHz (AV) RB = 1 MHz, VB = 2 kHz
Input Power (System)	120 Vac, 60Hz	Environmental Conditions	25°C, 68% RH
Tested By	Tom Yang		

Antenna Polarity & Test Distance : Vertical at 3 m								
No	Frequency (MHz)	Emission Level (dBuV/m)	Limit (dBuV/m)	Margin (dB)	Antenna Height (m)	Table Angle (Degree)	Raw Value (dBuV)	Correction Factor (dB/m)
1	2390.00	60.9 PK	74.0	-13.1	2.43 V	14	61.8	-0.9
2	2390.00	47.2 AV	54.0	-6.8	2.43 V	14	48.1	-0.9
3	*2412.00	116.5 PK			2.43 V	14	117.4	-0.9
4	*2412.00	107.1 AV			2.43 V	14	108.0	-0.9
5	4824.00	41.5 PK	74.0	-32.5	2.29 V	157	38.1	3.4
6	4824.00	30.0 AV	54.0	-24.0	2.29 V	157	26.6	3.4

Remarks:

1. Emission Level(dBuV/m) = Raw Value(dBuV) + Correction Factor(dB/m)
2. Correction Factor(dB/m) = Antenna Factor(dB/m) + Cable Factor(dB) – Pre-Amplifier Factor(dB)
3. Margin value = Emission Level – Limit value
4. The other emission levels were very low against the limit.
5. " * " : Fundamental frequency, the limit was restricted at the RF Output Power.

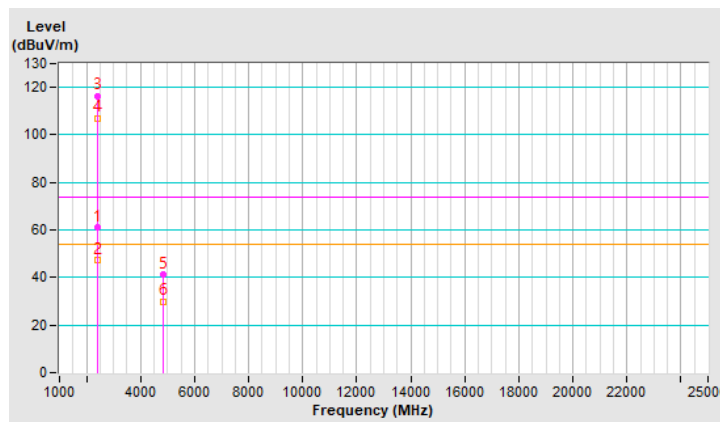

RF Mode	802.11be (EHT) 52+26-tone MRU	Channel	CH 11 : 2462 MHz
Frequency Range	1 GHz ~ 25 GHz	Detector Function & Bandwidth	(PK) RB = 1 MHz, VB = 3 MHz (AV) RB = 1 MHz, VB = 2 kHz
Input Power (System)	120 Vac, 60Hz	Environmental Conditions	25°C, 68% RH
Tested By	Tom Yang		

Antenna Polarity & Test Distance : Horizontal at 3 m								
No	Frequency (MHz)	Emission Level (dBUV/m)	Limit (dBUV/m)	Margin (dB)	Antenna Height (m)	Table Angle (Degree)	Raw Value (dBUV)	Correction Factor (dB/m)
1	*2462.00	121.9 PK			2.67 H	62	122.7	-0.8
2	*2462.00	112.5 AV			2.67 H	62	113.3	-0.8
3	2483.50	73.8 PK	74.0	-0.2	2.67 H	62	74.8	-1.0
4	2483.50	51.9 AV	54.0	-2.1	2.67 H	62	52.9	-1.0
5	4924.00	44.8 PK	74.0	-29.2	1.18 H	112	41.2	3.6
6	4924.00	32.4 AV	54.0	-21.6	1.18 H	112	28.8	3.6
7	7386.00	42.7 PK	74.0	-31.3	2.10 H	350	32.5	10.2
8	7386.00	31.6 AV	54.0	-22.4	2.10 H	350	21.4	10.2

Remarks:

1. Emission Level(dBUV/m) = Raw Value(dBUV) + Correction Factor(dB/m)
2. Correction Factor(dB/m) = Antenna Factor(dB/m) + Cable Factor(dB) – Pre-Amplifier Factor(dB)
3. Margin value = Emission Level – Limit value
4. The other emission levels were very low against the limit.
5. " * ": Fundamental frequency, the limit was restricted at the RF Output Power.

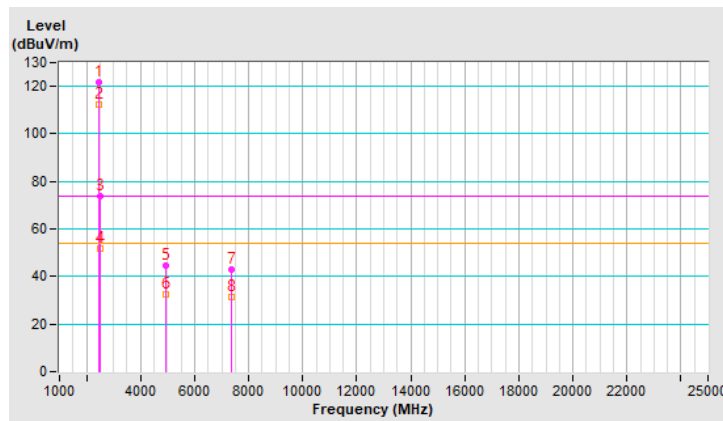

RF Mode	802.11be (EHT) 52+26-tone MRU	Channel	CH 11 : 2462 MHz
Frequency Range	1 GHz ~ 25 GHz	Detector Function & Bandwidth	(PK) RB = 1 MHz, VB = 3 MHz (AV) RB = 1 MHz, VB = 2 kHz
Input Power (System)	120 Vac, 60Hz	Environmental Conditions	25°C, 68% RH
Tested By	Tom Yang		

Antenna Polarity & Test Distance : Vertical at 3 m								
No	Frequency (MHz)	Emission Level (dBuV/m)	Limit (dBuV/m)	Margin (dB)	Antenna Height (m)	Table Angle (Degree)	Raw Value (dBuV)	Correction Factor (dB/m)
1	*2462.00	117.2 PK			2.23 V	14	118.0	-0.8
2	*2462.00	107.0 AV			2.23 V	14	107.8	-0.8
3	2483.50	60.0 PK	74.0	-14.0	2.23 V	14	61.0	-1.0
4	2483.50	46.1 AV	54.0	-7.9	2.23 V	14	47.1	-1.0
5	4924.00	41.0 PK	74.0	-33.0	2.37 V	142	37.4	3.6
6	4924.00	29.7 AV	54.0	-24.3	2.37 V	142	26.1	3.6
7	7386.00	47.2 PK	74.0	-26.8	3.52 V	135	37.0	10.2
8	7386.00	35.7 AV	54.0	-18.3	3.52 V	135	25.5	10.2

Remarks:

1. Emission Level(dBuV/m) = Raw Value(dBuV) + Correction Factor(dB/m)
2. Correction Factor(dB/m) = Antenna Factor(dB/m) + Cable Factor(dB) – Pre-Amplifier Factor(dB)
3. Margin value = Emission Level – Limit value
4. The other emission levels were very low against the limit.
5. " * ": Fundamental frequency, the limit was restricted at the RF Output Power.

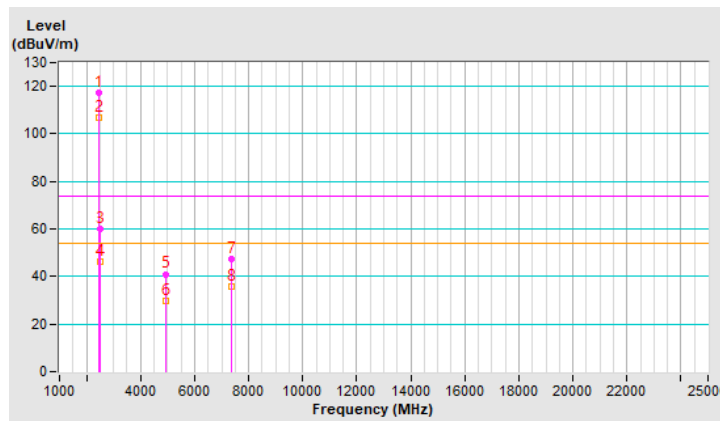

RF Mode	802.11be (EHT) 52+26-tone MRU	Channel	CH 12 : 2467 MHz
Frequency Range	1 GHz ~ 25 GHz	Detector Function & Bandwidth	(PK) RB = 1 MHz, VB = 3 MHz (AV) RB = 1 MHz, VB = 2 kHz
Input Power (System)	120 Vac, 60Hz	Environmental Conditions	25°C, 68% RH
Tested By	Tom Yang		

Antenna Polarity & Test Distance : Horizontal at 3 m								
No	Frequency (MHz)	Emission Level (dBuV/m)	Limit (dBuV/m)	Margin (dB)	Antenna Height (m)	Table Angle (Degree)	Raw Value (dBuV)	Correction Factor (dB/m)
1	*2467.00	121.2 PK			2.72 H	53	122.0	-0.8
2	*2467.00	111.5 AV			2.72 H	53	112.3	-0.8
3	2483.50	69.5 PK	74.0	-4.5	2.72 H	53	70.5	-1.0
4	2483.50	53.5 AV	54.0	-0.5	2.72 H	53	54.5	-1.0
5	4934.00	44.8 PK	74.0	-29.2	1.16 H	111	41.2	3.6
6	4934.00	32.2 AV	54.0	-21.8	1.16 H	111	28.6	3.6
7	7401.00	42.7 PK	74.0	-31.3	2.06 H	350	32.5	10.2
8	7401.00	31.3 AV	54.0	-22.7	2.06 H	350	21.1	10.2

Remarks:

1. Emission Level(dBuV/m) = Raw Value(dBuV) + Correction Factor(dB/m)
2. Correction Factor(dB/m) = Antenna Factor(dB/m) + Cable Factor(dB) – Pre-Amplifier Factor(dB)
3. Margin value = Emission Level – Limit value
4. The other emission levels were very low against the limit.
5. " * " : Fundamental frequency, the limit was restricted at the RF Output Power.

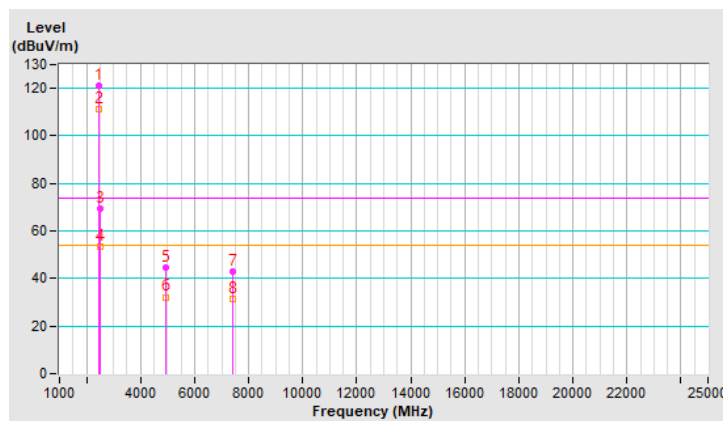

RF Mode	802.11be (EHT) 52+26-tone MRU	Channel	CH 12 : 2467 MHz
Frequency Range	1 GHz ~ 25 GHz	Detector Function & Bandwidth	(PK) RB = 1 MHz, VB = 3 MHz (AV) RB = 1 MHz, VB = 2 kHz
Input Power (System)	120 Vac, 60Hz	Environmental Conditions	25°C, 68% RH
Tested By	Tom Yang		

Antenna Polarity & Test Distance : Vertical at 3 m								
No	Frequency (MHz)	Emission Level (dBuV/m)	Limit (dBuV/m)	Margin (dB)	Antenna Height (m)	Table Angle (Degree)	Raw Value (dBuV)	Correction Factor (dB/m)
1	*2467.00	114.5 PK			2.23 V	12	115.3	-0.8
2	*2467.00	104.7 AV			2.23 V	12	105.5	-0.8
3	2483.50	64.1 PK	74.0	-9.9	2.23 V	12	65.1	-1.0
4	2483.50	47.9 AV	54.0	-6.1	2.23 V	12	48.9	-1.0
5	4934.00	41.7 PK	74.0	-32.3	2.33 V	163	38.1	3.6
6	4934.00	30.1 AV	54.0	-23.9	2.33 V	163	26.5	3.6
7	7401.00	46.9 PK	74.0	-27.1	3.52 V	154	36.7	10.2
8	7401.00	35.7 AV	54.0	-18.3	3.52 V	154	25.5	10.2

Remarks:

1. Emission Level(dBuV/m) = Raw Value(dBuV) + Correction Factor(dB/m)
2. Correction Factor(dB/m) = Antenna Factor(dB/m) + Cable Factor(dB) – Pre-Amplifier Factor(dB)
3. Margin value = Emission Level – Limit value
4. The other emission levels were very low against the limit.
5. " * " : Fundamental frequency, the limit was restricted at the RF Output Power.

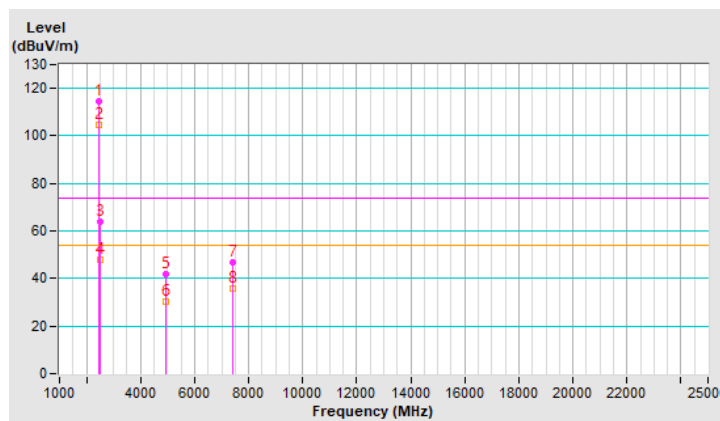

RF Mode	802.11be (EHT) 52+26-tone MRU	Channel	CH 13 : 2472 MHz
Frequency Range	1 GHz ~ 25 GHz	Detector Function & Bandwidth	(PK) RB = 1 MHz, VB = 3 MHz (AV) RB = 1 MHz, VB = 2 kHz
Input Power (System)	120 Vac, 60Hz	Environmental Conditions	25°C, 68% RH
Tested By	Tom Yang		

Antenna Polarity & Test Distance : Horizontal at 3 m								
No	Frequency (MHz)	Emission Level (dBuV/m)	Limit (dBuV/m)	Margin (dB)	Antenna Height (m)	Table Angle (Degree)	Raw Value (dBuV)	Correction Factor (dB/m)
1	*2472.00	119.8 PK			2.96 H	67	120.7	-0.9
2	*2472.00	110.0 AV			2.96 H	67	110.9	-0.9
3	2483.50	66.0 PK	74.0	-8.0	2.96 H	67	67.0	-1.0
4	2483.50	53.5 AV	54.0	-0.5	2.96 H	67	54.5	-1.0
5	4944.00	44.3 PK	74.0	-29.7	1.21 H	125	40.6	3.7
6	4944.00	31.7 AV	54.0	-22.3	1.21 H	125	28.0	3.7
7	7416.00	43.1 PK	74.0	-30.9	2.14 H	358	32.9	10.2
8	7416.00	31.7 AV	54.0	-22.3	2.14 H	358	21.5	10.2

Remarks:

1. Emission Level(dBuV/m) = Raw Value(dBuV) + Correction Factor(dB/m)
2. Correction Factor(dB/m) = Antenna Factor(dB/m) + Cable Factor(dB) – Pre-Amplifier Factor(dB)
3. Margin value = Emission Level – Limit value
4. The other emission levels were very low against the limit.
5. " * ": Fundamental frequency, the limit was restricted at the RF Output Power.
6. The Band-edge measurements was follow ANSI C63.10 Section 11.13.3.

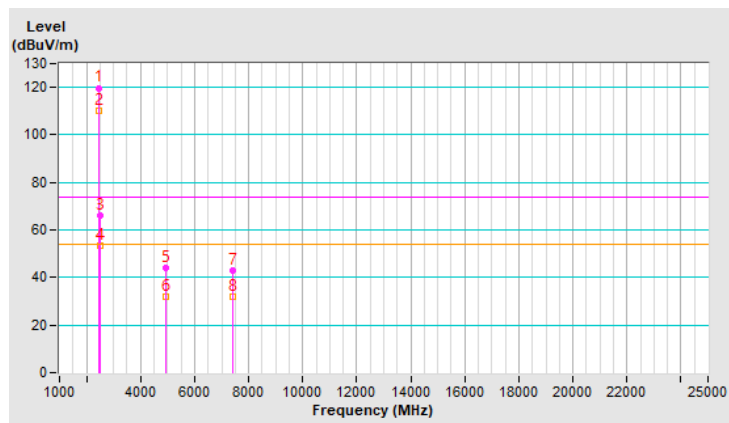

RF Mode	802.11be (EHT) 52+26-tone MRU	Channel	CH 13 : 2472 MHz
Frequency Range	1 GHz ~ 25 GHz	Detector Function & Bandwidth	(PK) RB = 1 MHz, VB = 3 MHz (AV) RB = 1 MHz, VB = 2 kHz
Input Power (System)	120 Vac, 60Hz	Environmental Conditions	25°C, 68% RH
Tested By	Tom Yang		

Antenna Polarity & Test Distance : Vertical at 3 m								
No	Frequency (MHz)	Emission Level (dBuV/m)	Limit (dBuV/m)	Margin (dB)	Antenna Height (m)	Table Angle (Degree)	Raw Value (dBuV)	Correction Factor (dB/m)
1	*2472.00	112.8 PK			2.28 V	11	113.7	-0.9
2	*2472.00	102.7 AV			2.28 V	11	103.6	-0.9
3	2483.50	60.1 PK	74.0	-13.9	2.28 V	11	61.1	-1.0
4	2483.50	48.9 AV	54.0	-5.1	2.28 V	11	49.9	-1.0
5	4944.00	41.7 PK	74.0	-32.3	2.30 V	143	38.0	3.7
6	4944.00	30.2 AV	54.0	-23.8	2.30 V	143	26.5	3.7
7	7416.00	47.3 PK	74.0	-26.7	3.53 V	133	37.1	10.2
8	7416.00	35.9 AV	54.0	-18.1	3.53 V	133	25.7	10.2

Remarks:

1. Emission Level(dBuV/m) = Raw Value(dBuV) + Correction Factor(dB/m)
2. Correction Factor(dB/m) = Antenna Factor(dB/m) + Cable Factor(dB) – Pre-Amplifier Factor(dB)
3. Margin value = Emission Level – Limit value
4. The other emission levels were very low against the limit.
5. " * " : Fundamental frequency, the limit was restricted at the RF Output Power.
6. The Band-edge measurements was follow ANSI C63.10 Section 11.13.3.

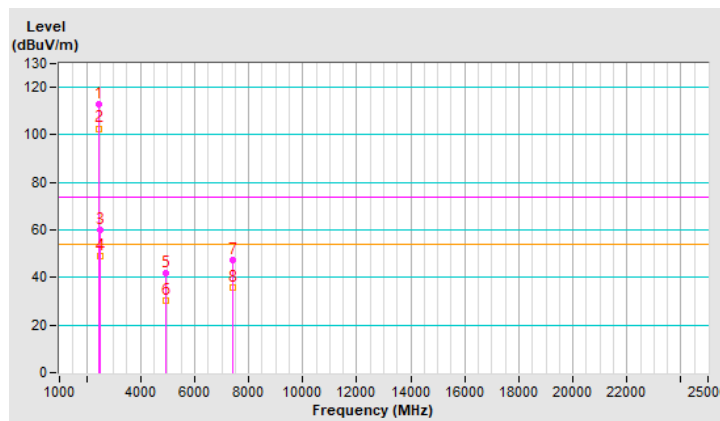

RF Mode	802.11be (EHT) 106+26-tone MRU	Channel	CH 1 : 2412 MHz
Frequency Range	1 GHz ~ 25 GHz	Detector Function & Bandwidth	(PK) RB = 1 MHz, VB = 3 MHz (AV) RB = 1 MHz, VB = 2 kHz
Input Power (System)	120 Vac, 60Hz	Environmental Conditions	25°C, 68% RH
Tested By	Tom Yang		

Antenna Polarity & Test Distance : Horizontal at 3 m								
No	Frequency (MHz)	Emission Level (dBuV/m)	Limit (dBuV/m)	Margin (dB)	Antenna Height (m)	Table Angle (Degree)	Raw Value (dBuV)	Correction Factor (dB/m)
1	2390.00	69.9 PK	74.0	-4.1	2.88 H	70	70.8	-0.9
2	2390.00	53.6 AV	54.0	-0.4	2.88 H	70	54.5	-0.9
3	*2412.00	121.5 PK			2.88 H	70	122.4	-0.9
4	*2412.00	110.7 AV			2.88 H	70	111.6	-0.9
5	4824.00	44.4 PK	74.0	-29.6	1.21 H	120	41.0	3.4
6	4824.00	32.1 AV	54.0	-21.9	1.21 H	120	28.7	3.4

Remarks:

1. Emission Level(dBuV/m) = Raw Value(dBuV) + Correction Factor(dB/m)
2. Correction Factor(dB/m) = Antenna Factor(dB/m) + Cable Factor(dB) – Pre-Amplifier Factor(dB)
3. Margin value = Emission Level – Limit value
4. The other emission levels were very low against the limit.
5. " * " : Fundamental frequency, the limit was restricted at the RF Output Power.

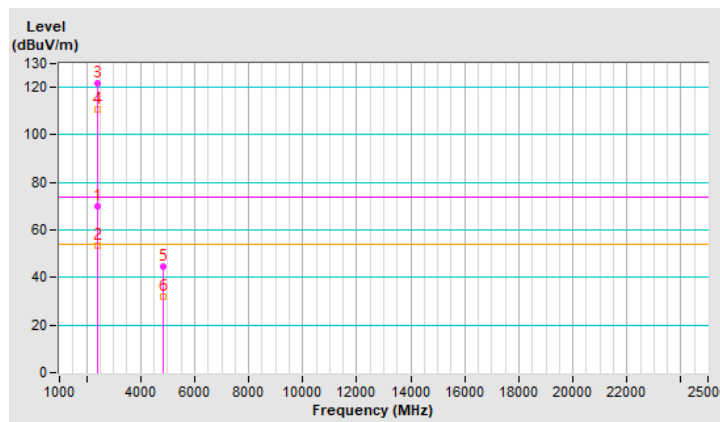

RF Mode	802.11be (EHT) 106+26-tone MRU	Channel	CH 1 : 2412 MHz
Frequency Range	1 GHz ~ 25 GHz	Detector Function & Bandwidth	(PK) RB = 1 MHz, VB = 3 MHz (AV) RB = 1 MHz, VB = 2 kHz
Input Power (System)	120 Vac, 60Hz	Environmental Conditions	25°C, 68% RH
Tested By	Tom Yang		

Antenna Polarity & Test Distance : Vertical at 3 m								
No	Frequency (MHz)	Emission Level (dBuV/m)	Limit (dBuV/m)	Margin (dB)	Antenna Height (m)	Table Angle (Degree)	Raw Value (dBuV)	Correction Factor (dB/m)
1	2390.00	60.2 PK	74.0	-13.8	2.36 V	8	61.1	-0.9
2	2390.00	47.0 AV	54.0	-7.0	2.36 V	8	47.9	-0.9
3	*2412.00	113.9 PK			2.36 V	8	114.8	-0.9
4	*2412.00	104.5 AV			2.36 V	8	105.4	-0.9
5	4824.00	41.3 PK	74.0	-32.7	2.31 V	173	37.9	3.4
6	4824.00	29.7 AV	54.0	-24.3	2.31 V	173	26.3	3.4

Remarks:

1. Emission Level(dBuV/m) = Raw Value(dBuV) + Correction Factor(dB/m)
2. Correction Factor(dB/m) = Antenna Factor(dB/m) + Cable Factor(dB) – Pre-Amplifier Factor(dB)
3. Margin value = Emission Level – Limit value
4. The other emission levels were very low against the limit.
5. " * " : Fundamental frequency, the limit was restricted at the RF Output Power.

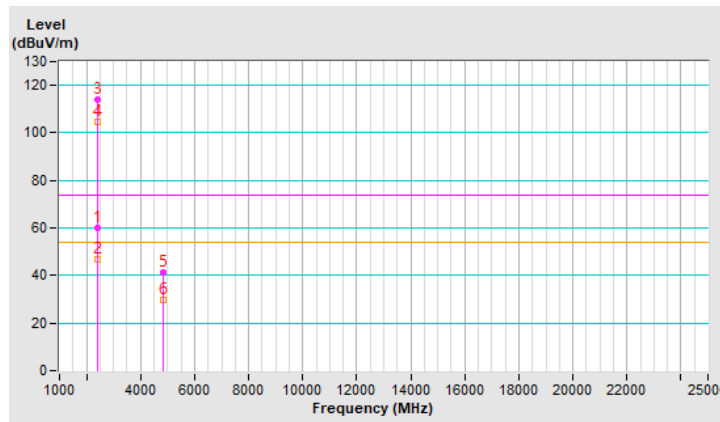

RF Mode	802.11be (EHT) 106+26-tone MRU	Channel	CH 11 : 2462 MHz
Frequency Range	1 GHz ~ 25 GHz	Detector Function & Bandwidth	(PK) RB = 1 MHz, VB = 3 MHz (AV) RB = 1 MHz, VB = 2 kHz
Input Power (System)	120 Vac, 60Hz	Environmental Conditions	25°C, 68% RH
Tested By	Tom Yang		

Antenna Polarity & Test Distance : Horizontal at 3 m								
No	Frequency (MHz)	Emission Level (dBuV/m)	Limit (dBuV/m)	Margin (dB)	Antenna Height (m)	Table Angle (Degree)	Raw Value (dBuV)	Correction Factor (dB/m)
1	*2462.00	120.9 PK			2.70 H	58	121.7	-0.8
2	*2462.00	110.5 AV			2.70 H	58	111.3	-0.8
3	2483.50	71.9 PK	74.0	-2.1	2.70 H	58	72.9	-1.0
4	2483.50	53.9 AV	54.0	-0.1	2.70 H	58	54.9	-1.0
5	4924.00	44.3 PK	74.0	-29.7	1.22 H	137	40.7	3.6
6	4924.00	32.1 AV	54.0	-21.9	1.22 H	137	28.5	3.6
7	7386.00	42.5 PK	74.0	-31.5	2.13 H	347	32.3	10.2
8	7386.00	31.2 AV	54.0	-22.8	2.13 H	347	21.0	10.2

Remarks:

1. Emission Level(dBuV/m) = Raw Value(dBuV) + Correction Factor(dB/m)
2. Correction Factor(dB/m) = Antenna Factor(dB/m) + Cable Factor(dB) – Pre-Amplifier Factor(dB)
3. Margin value = Emission Level – Limit value
4. The other emission levels were very low against the limit.
5. " * ": Fundamental frequency, the limit was restricted at the RF Output Power.

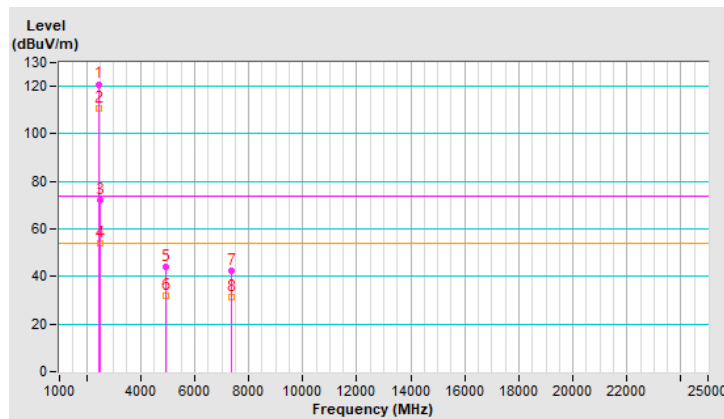

RF Mode	802.11be (EHT) 106+26-tone MRU	Channel	CH 11 : 2462 MHz
Frequency Range	1 GHz ~ 25 GHz	Detector Function & Bandwidth	(PK) RB = 1 MHz, VB = 3 MHz (AV) RB = 1 MHz, VB = 2 kHz
Input Power (System)	120 Vac, 60Hz	Environmental Conditions	25°C, 68% RH
Tested By	Tom Yang		

Antenna Polarity & Test Distance : Vertical at 3 m								
No	Frequency (MHz)	Emission Level (dBuV/m)	Limit (dBuV/m)	Margin (dB)	Antenna Height (m)	Table Angle (Degree)	Raw Value (dBuV)	Correction Factor (dB/m)
1	*2462.00	114.4 PK			2.66 V	15	115.2	-0.8
2	*2462.00	105.3 AV			2.66 V	15	106.1	-0.8
3	2483.50	61.2 PK	74.0	-12.8	2.66 V	15	62.2	-1.0
4	2483.50	46.5 AV	54.0	-7.5	2.66 V	15	47.5	-1.0
5	4924.00	41.5 PK	74.0	-32.5	2.35 V	163	37.9	3.6
6	4924.00	30.1 AV	54.0	-23.9	2.35 V	163	26.5	3.6
7	7386.00	47.4 PK	74.0	-26.6	3.51 V	150	37.2	10.2
8	7386.00	36.1 AV	54.0	-17.9	3.51 V	150	25.9	10.2

Remarks:

1. Emission Level(dBuV/m) = Raw Value(dBuV) + Correction Factor(dB/m)
2. Correction Factor(dB/m) = Antenna Factor(dB/m) + Cable Factor(dB) – Pre-Amplifier Factor(dB)
3. Margin value = Emission Level – Limit value
4. The other emission levels were very low against the limit.
5. " * ": Fundamental frequency, the limit was restricted at the RF Output Power.

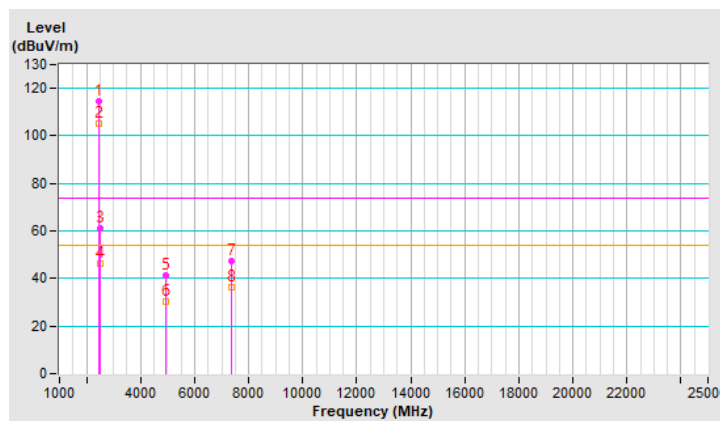

RF Mode	802.11be (EHT) 106+26-tone MRU	Channel	CH 12 : 2467 MHz
Frequency Range	1 GHz ~ 25 GHz	Detector Function & Bandwidth	(PK) RB = 1 MHz, VB = 3 MHz (AV) RB = 1 MHz, VB = 2 kHz
Input Power (System)	120 Vac, 60Hz	Environmental Conditions	25°C, 68% RH
Tested By	Tom Yang		

Antenna Polarity & Test Distance : Horizontal at 3 m								
No	Frequency (MHz)	Emission Level (dBuV/m)	Limit (dBuV/m)	Margin (dB)	Antenna Height (m)	Table Angle (Degree)	Raw Value (dBuV)	Correction Factor (dB/m)
1	*2467.00	118.5 PK			2.81 H	70	119.3	-0.8
2	*2467.00	108.6 AV			2.81 H	70	109.4	-0.8
3	2483.50	68.8 PK	74.0	-5.2	2.81 H	70	69.8	-1.0
4	2483.50	53.8 AV	54.0	-0.2	2.81 H	70	54.8	-1.0
5	4934.00	44.1 PK	74.0	-29.9	1.16 H	117	40.5	3.6
6	4934.00	31.6 AV	54.0	-22.4	1.16 H	117	28.0	3.6
7	7401.00	42.1 PK	74.0	-31.9	2.13 H	346	31.9	10.2
8	7401.00	31.1 AV	54.0	-22.9	2.13 H	346	20.9	10.2

Remarks:

1. Emission Level(dBuV/m) = Raw Value(dBuV) + Correction Factor(dB/m)
2. Correction Factor(dB/m) = Antenna Factor(dB/m) + Cable Factor(dB) – Pre-Amplifier Factor(dB)
3. Margin value = Emission Level – Limit value
4. The other emission levels were very low against the limit.
5. " * ": Fundamental frequency, the limit was restricted at the RF Output Power.

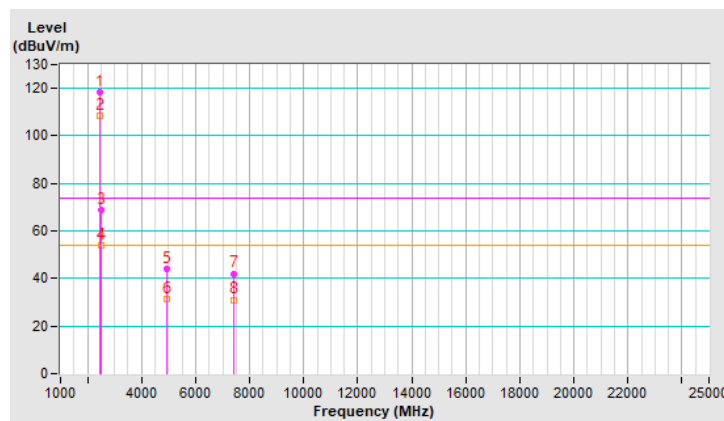

RF Mode	802.11be (EHT) 106+26-tone MRU	Channel	CH 12 : 2467 MHz
Frequency Range	1 GHz ~ 25 GHz	Detector Function & Bandwidth	(PK) RB = 1 MHz, VB = 3 MHz (AV) RB = 1 MHz, VB = 2 kHz
Input Power (System)	120 Vac, 60Hz	Environmental Conditions	25°C, 68% RH
Tested By	Tom Yang		

Antenna Polarity & Test Distance : Vertical at 3 m								
No	Frequency (MHz)	Emission Level (dBuV/m)	Limit (dBuV/m)	Margin (dB)	Antenna Height (m)	Table Angle (Degree)	Raw Value (dBuV)	Correction Factor (dB/m)
1	*2467.00	113.9 PK			2.69 V	12	114.7	-0.8
2	*2467.00	103.2 AV			2.69 V	12	104.0	-0.8
3	2483.50	64.7 PK	74.0	-9.3	2.69 V	12	65.7	-1.0
4	2483.50	50.3 AV	54.0	-3.7	2.69 V	12	51.3	-1.0
5	4934.00	41.5 PK	74.0	-32.5	2.31 V	166	37.9	3.6
6	4934.00	30.3 AV	54.0	-23.7	2.31 V	166	26.7	3.6
7	7401.00	46.8 PK	74.0	-27.2	3.51 V	160	36.6	10.2
8	7401.00	35.5 AV	54.0	-18.5	3.51 V	160	25.3	10.2

Remarks:

1. Emission Level(dBuV/m) = Raw Value(dBuV) + Correction Factor(dB/m)
2. Correction Factor(dB/m) = Antenna Factor(dB/m) + Cable Factor(dB) – Pre-Amplifier Factor(dB)
3. Margin value = Emission Level – Limit value
4. The other emission levels were very low against the limit.
5. " * " : Fundamental frequency, the limit was restricted at the RF Output Power.

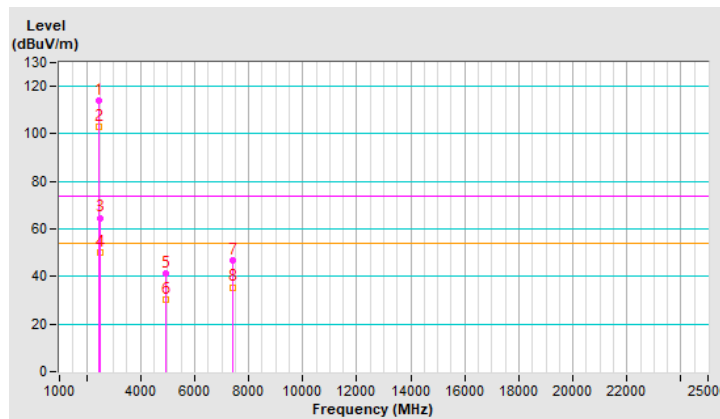

RF Mode	802.11be (EHT) 106+26-tone MRU	Channel	CH 13 : 2472 MHz
Frequency Range	1 GHz ~ 25 GHz	Detector Function & Bandwidth	(PK) RB = 1 MHz, VB = 3 MHz (AV) RB = 1 MHz, VB = 2 kHz
Input Power (System)	120 Vac, 60Hz	Environmental Conditions	25°C, 68% RH
Tested By	Tom Yang		

Antenna Polarity & Test Distance : Horizontal at 3 m								
No	Frequency (MHz)	Emission Level (dBuV/m)	Limit (dBuV/m)	Margin (dB)	Antenna Height (m)	Table Angle (Degree)	Raw Value (dBuV)	Correction Factor (dB/m)
1	*2472.00	113.4 PK			3.20 H	64	114.3	-0.9
2	*2472.00	103.4 AV			3.20 H	64	104.3	-0.9
3	2483.50	63.3 PK	74.0	-10.7	3.20 H	64	64.3	-1.0
4	2483.50	53.8 AV	54.0	-0.2	3.20 H	64	54.8	-1.0
5	4944.00	44.7 PK	74.0	-29.3	1.23 H	132	41.0	3.7
6	4944.00	32.5 AV	54.0	-21.5	1.23 H	132	28.8	3.7
7	7416.00	42.9 PK	74.0	-31.1	2.09 H	347	32.7	10.2
8	7416.00	31.8 AV	54.0	-22.2	2.09 H	347	21.6	10.2

Remarks:

1. Emission Level(dBuV/m) = Raw Value(dBuV) + Correction Factor(dB/m)
2. Correction Factor(dB/m) = Antenna Factor(dB/m) + Cable Factor(dB) – Pre-Amplifier Factor(dB)
3. Margin value = Emission Level – Limit value
4. The other emission levels were very low against the limit.
5. " * " : Fundamental frequency, the limit was restricted at the RF Output Power.
6. The Band-edge measurements was follow ANSI C63.10 Section 11.13.3.

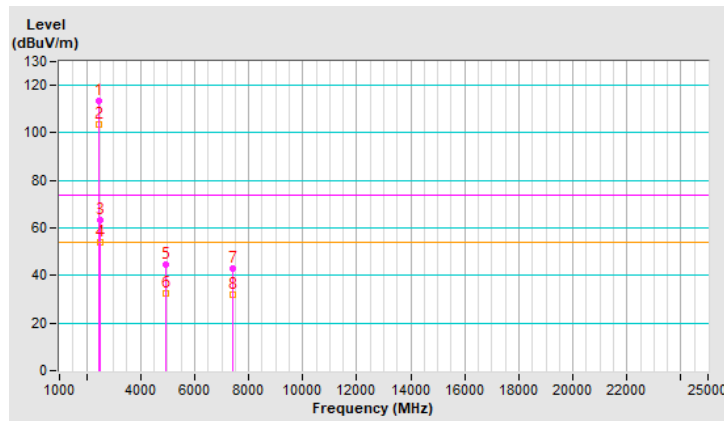

RF Mode	802.11be (EHT) 106+26-tone MRU	Channel	CH 13 : 2472 MHz
Frequency Range	1 GHz ~ 25 GHz	Detector Function & Bandwidth	(PK) RB = 1 MHz, VB = 3 MHz (AV) RB = 1 MHz, VB = 2 kHz
Input Power (System)	120 Vac, 60Hz	Environmental Conditions	25°C, 68% RH
Tested By	Tom Yang		

Antenna Polarity & Test Distance : Vertical at 3 m								
No	Frequency (MHz)	Emission Level (dBuV/m)	Limit (dBuV/m)	Margin (dB)	Antenna Height (m)	Table Angle (Degree)	Raw Value (dBuV)	Correction Factor (dB/m)
1	*2472.00	109.3 PK			2.75 V	16	110.2	-0.9
2	*2472.00	99.7 AV			2.75 V	16	100.6	-0.9
3	2483.50	61.3 PK	74.0	-12.7	2.75 V	16	62.3	-1.0
4	2483.50	51.1 AV	54.0	-2.9	2.75 V	16	52.1	-1.0
5	4944.00	41.6 PK	74.0	-32.4	2.27 V	166	37.9	3.7
6	4944.00	30.0 AV	54.0	-24.0	2.27 V	166	26.3	3.7
7	7416.00	47.3 PK	74.0	-26.7	3.53 V	146	37.1	10.2
8	7416.00	36.0 AV	54.0	-18.0	3.53 V	146	25.8	10.2

Remarks:

1. Emission Level(dBuV/m) = Raw Value(dBuV) + Correction Factor(dB/m)
2. Correction Factor(dB/m) = Antenna Factor(dB/m) + Cable Factor(dB) – Pre-Amplifier Factor(dB)
3. Margin value = Emission Level – Limit value
4. The other emission levels were very low against the limit.
5. " * " : Fundamental frequency, the limit was restricted at the RF Output Power.
6. The Band-edge measurements was follow ANSI C63.10 Section 11.13.3.

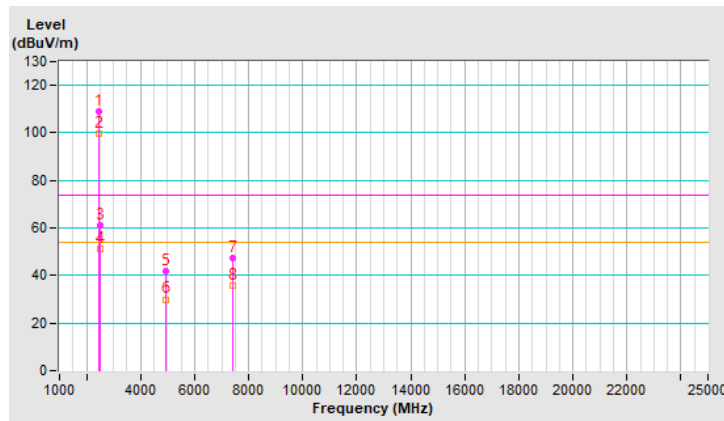

Plot of Band Edge

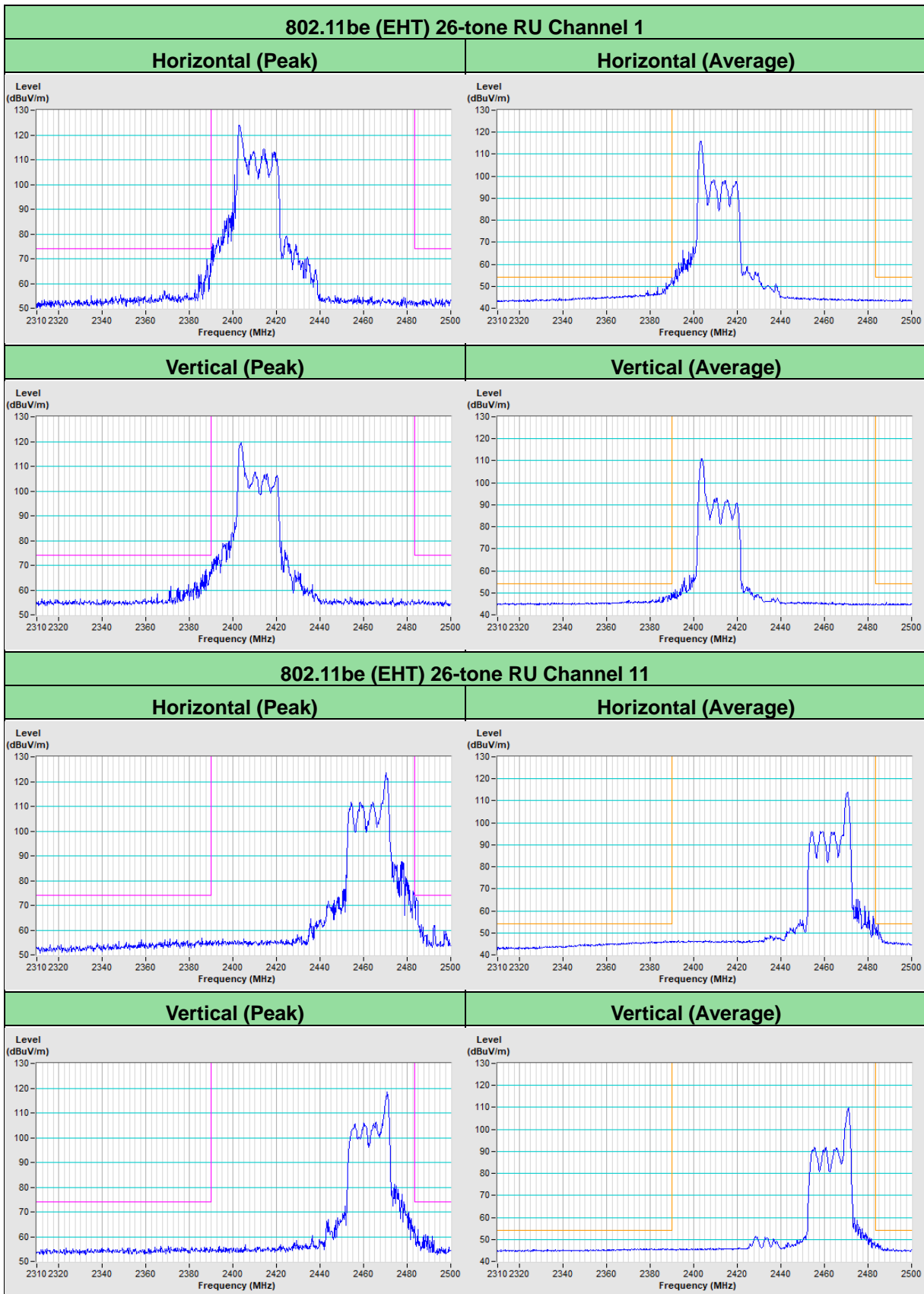

802.11be (EHT) 26-tone RU Channel 12

Horizontal (Peak)

Horizontal (Average)

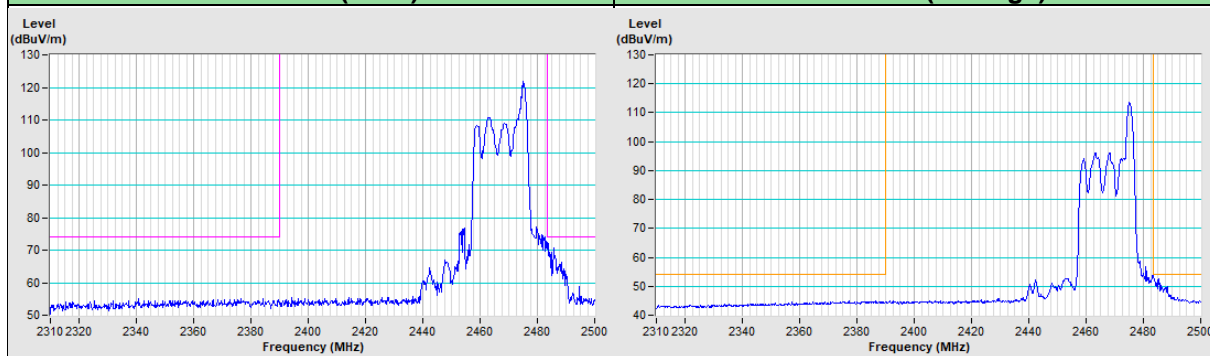

Vertical (Peak)

Vertical (Average)

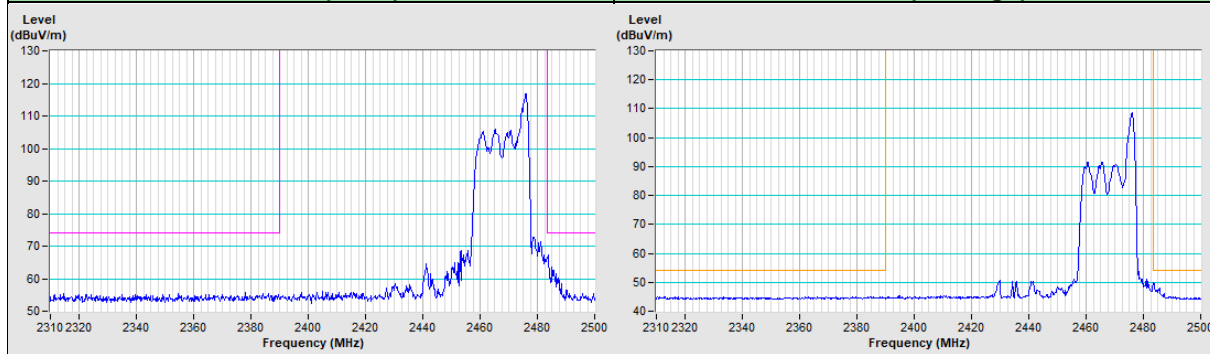

802.11be (EHT) 26-tone RU Channel 13

Horizontal (Peak)

Horizontal (Average)

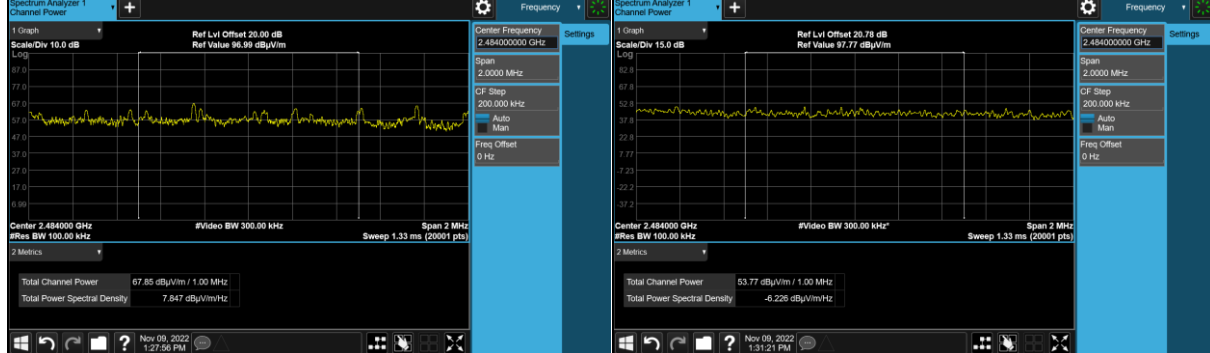

Vertical (Peak)

Vertical (Average)

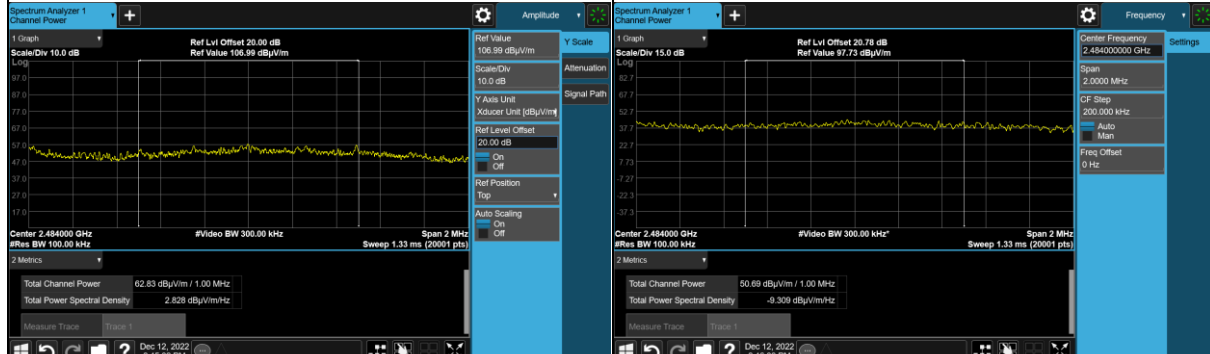

802.11be (EHT) 52-tone RU Channel 1

Horizontal (Peak) Horizontal (Average)

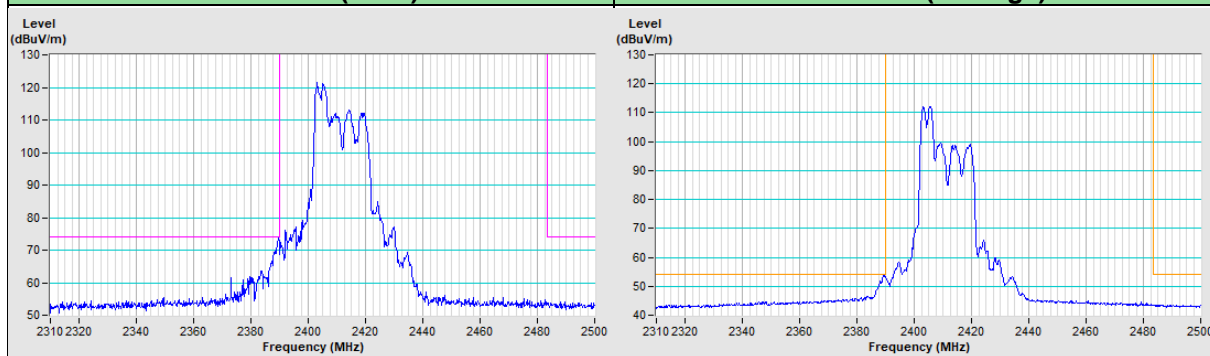

Vertical (Peak) Vertical (Average)

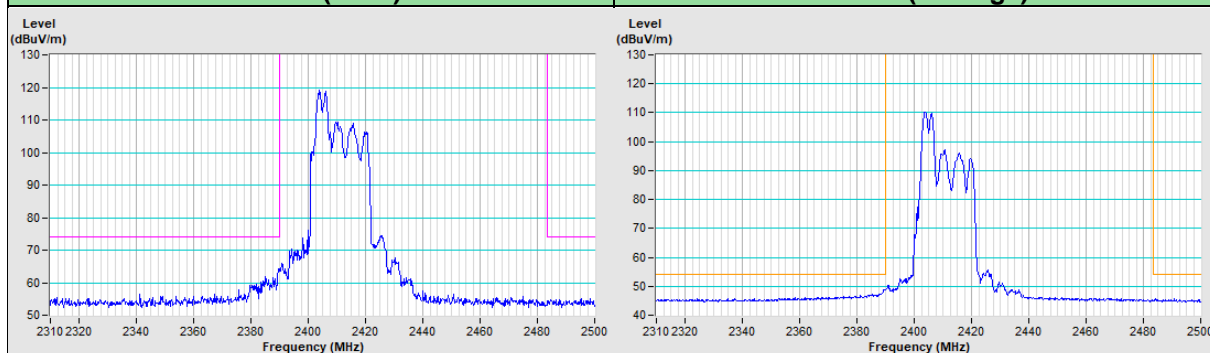

802.11be (EHT) 52-tone RU Channel 11

Horizontal (Peak) Horizontal (Average)

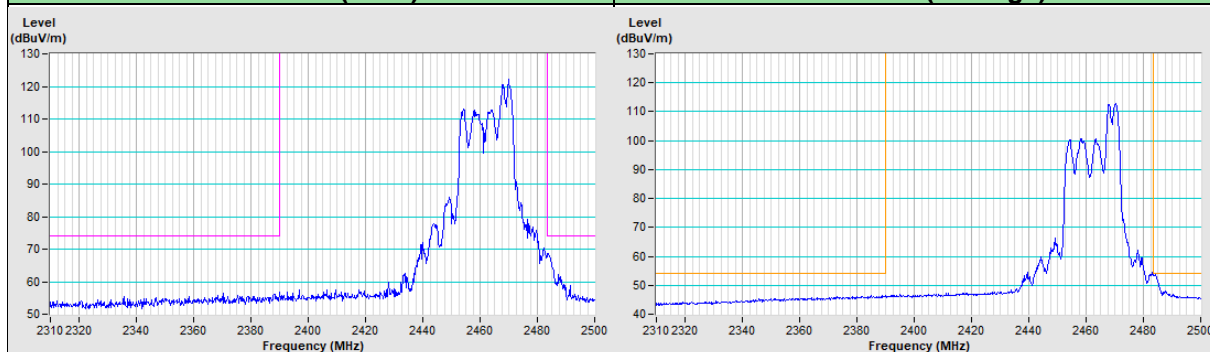

Vertical (Peak) Vertical (Average)

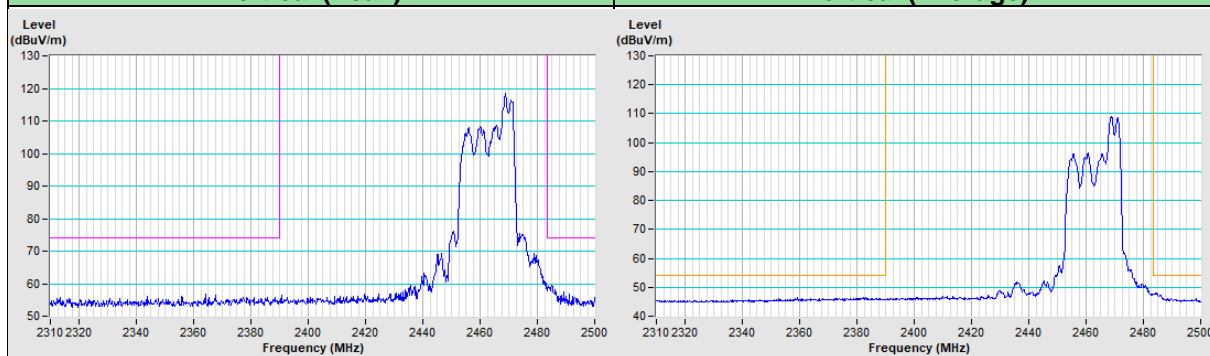

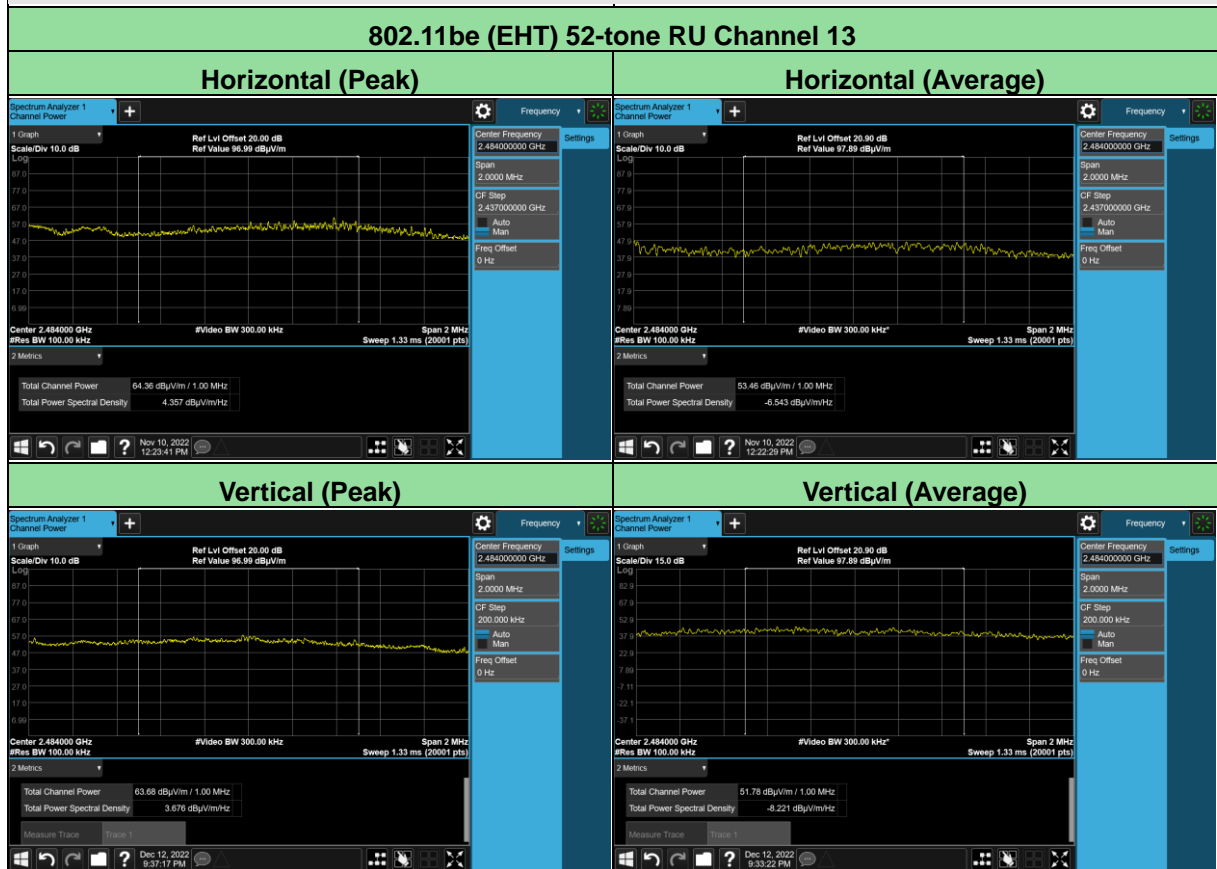
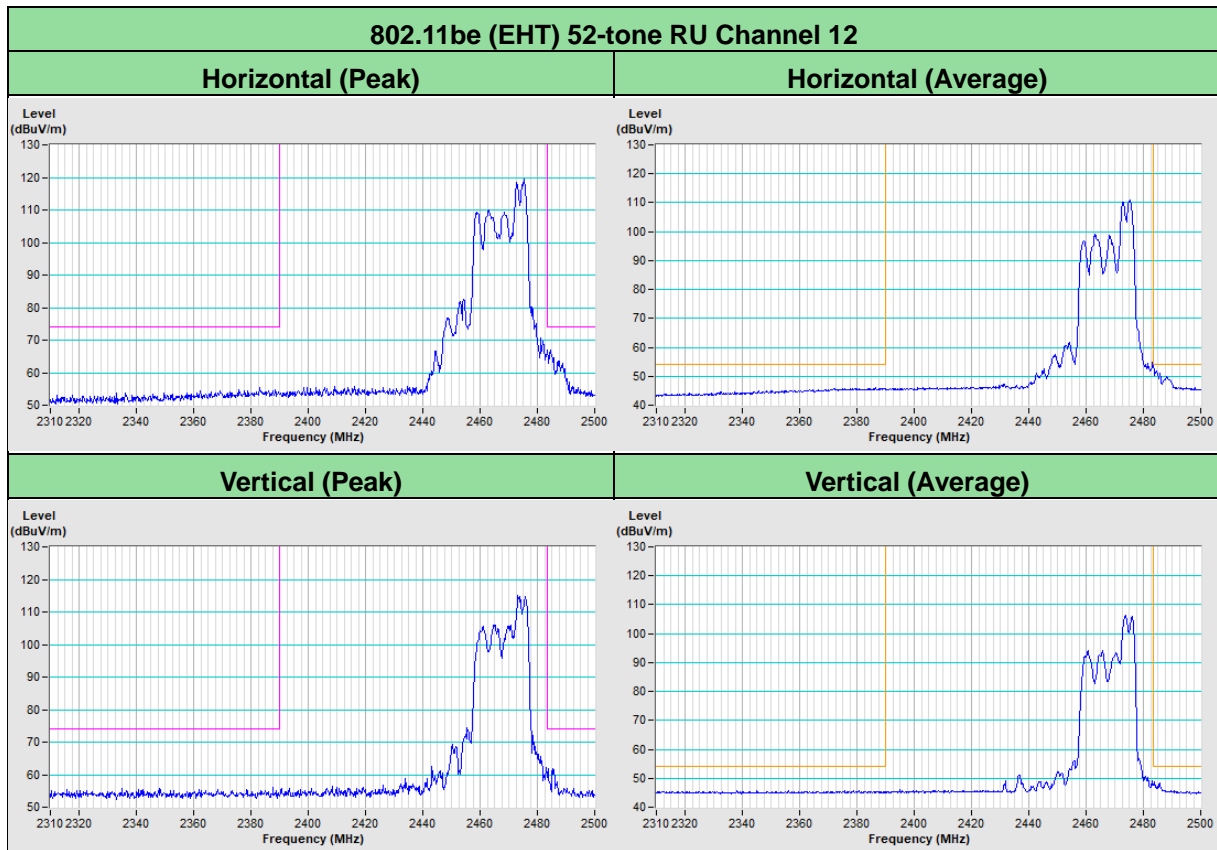

802.11be (EHT) 106-tone RU Channel 12

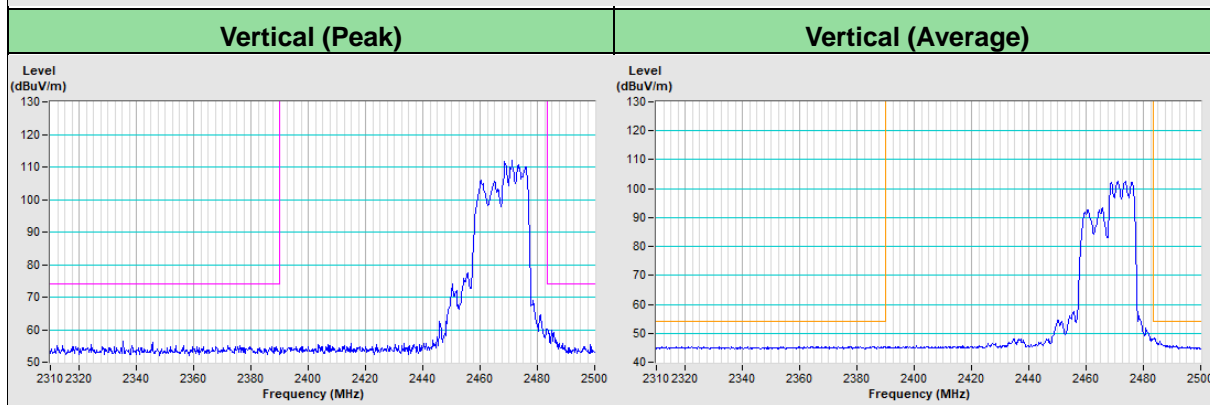
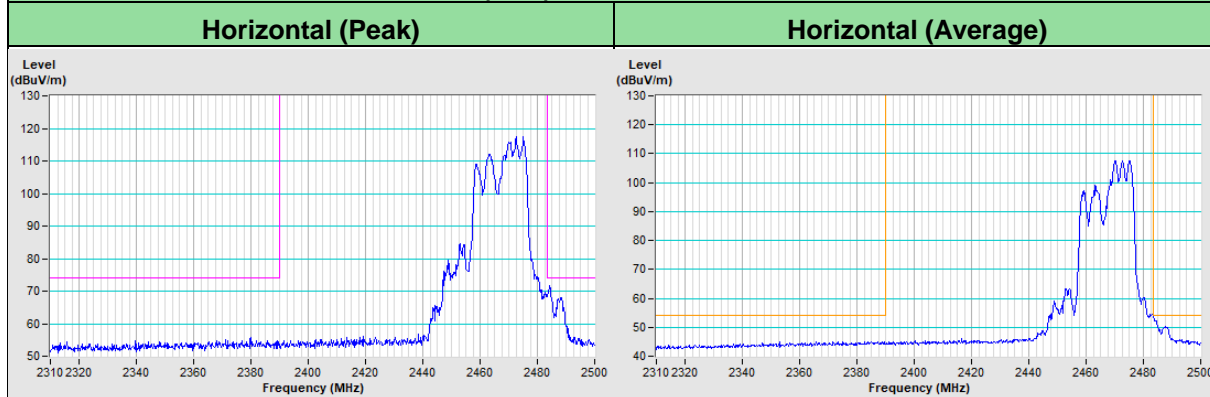

802.11be (EHT) 106-tone RU Channel 13

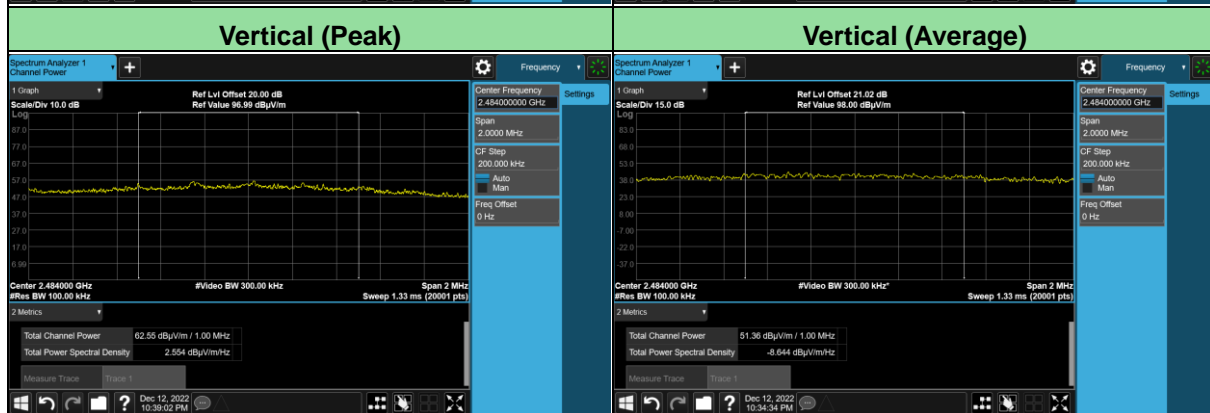
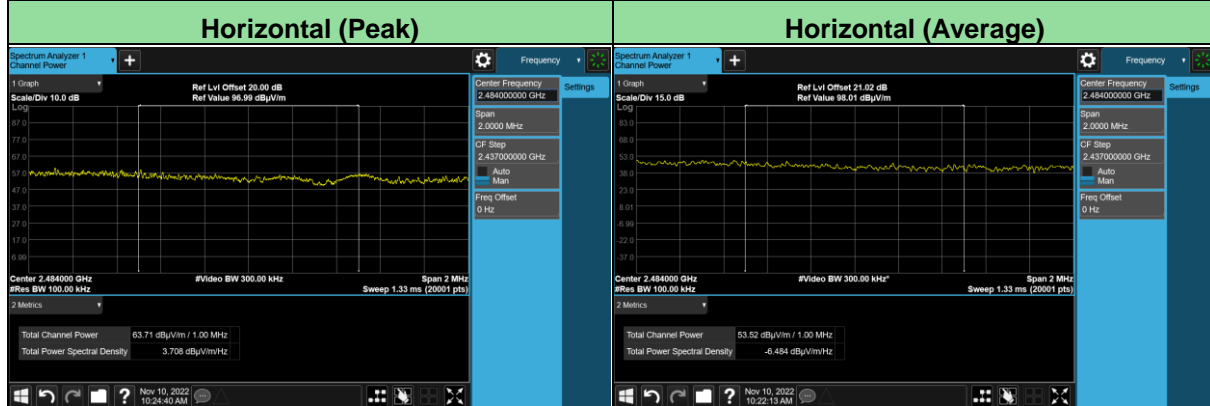

802.11be (EHT) 52+26-tone MRU Channel 12

Horizontal (Peak)

Horizontal (Average)

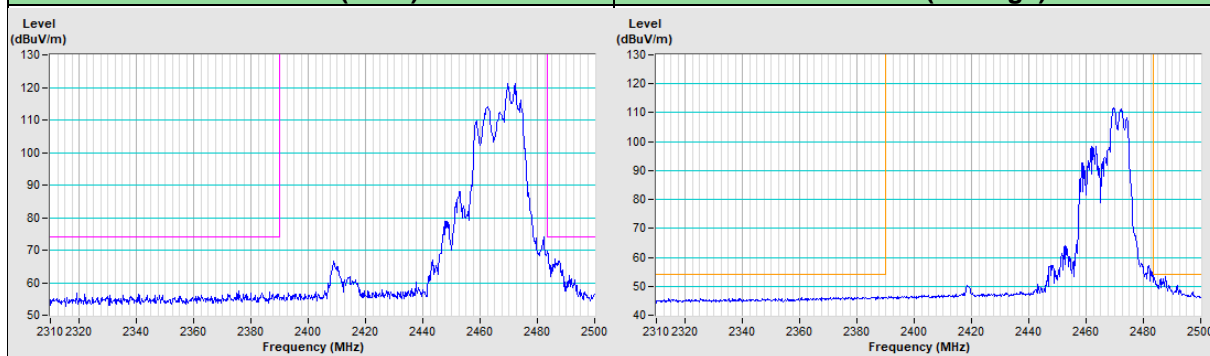

Vertical (Peak)

Vertical (Average)

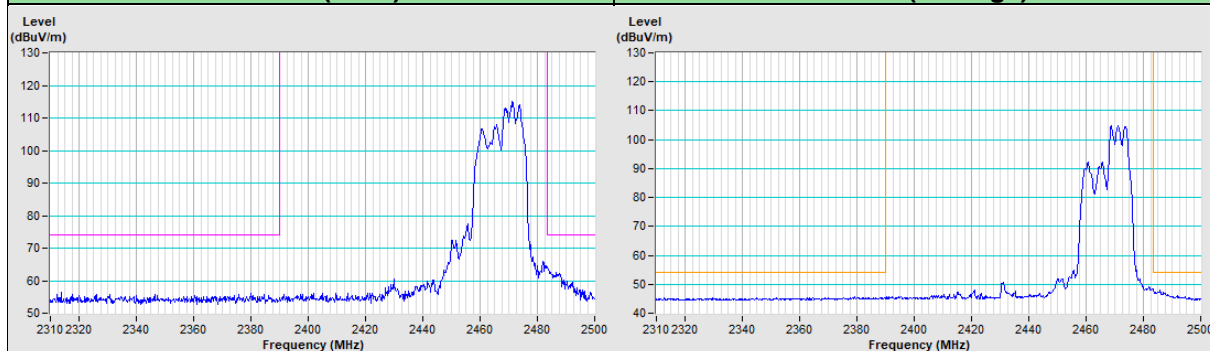

802.11be (EHT) 52+26-tone MRU Channel 13

Horizontal (Peak)

Horizontal (Average)

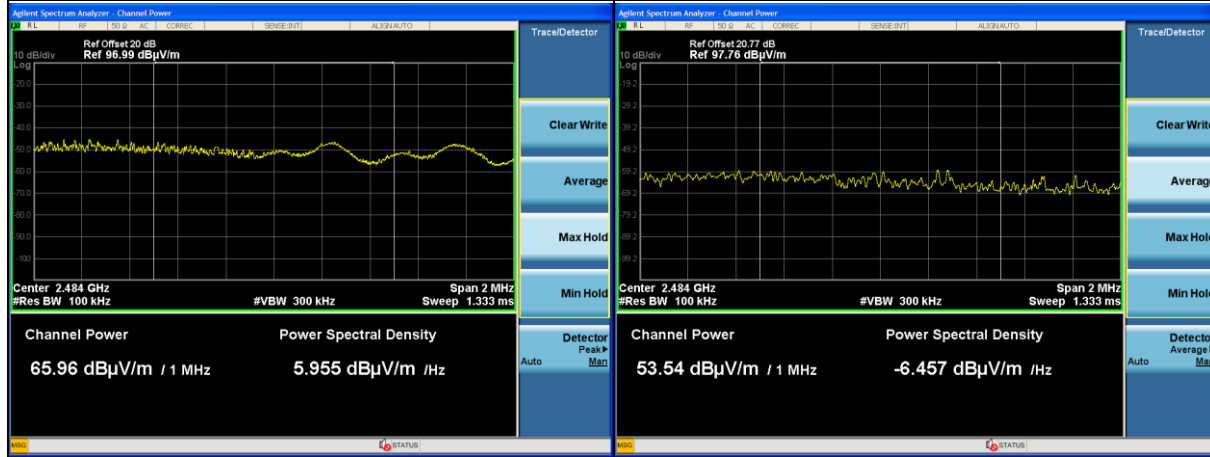

Vertical (Peak)

Vertical (Average)

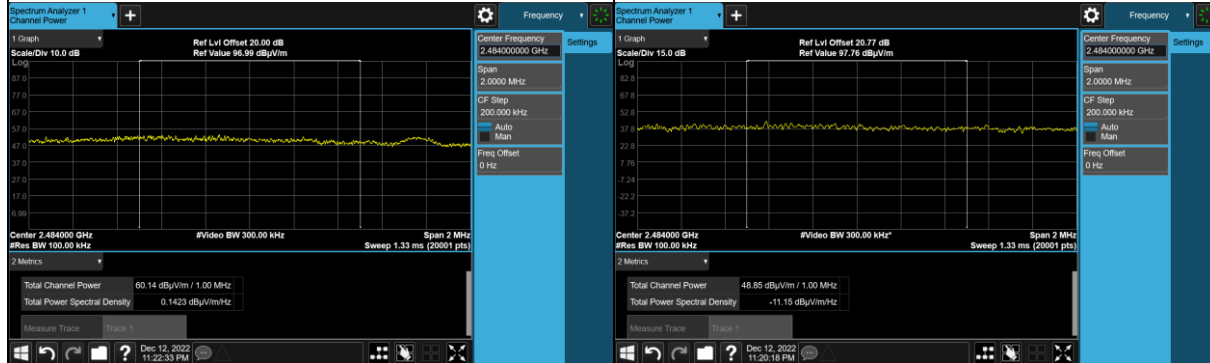

802.11be (EHT) 106+26-tone MRU Channel 1

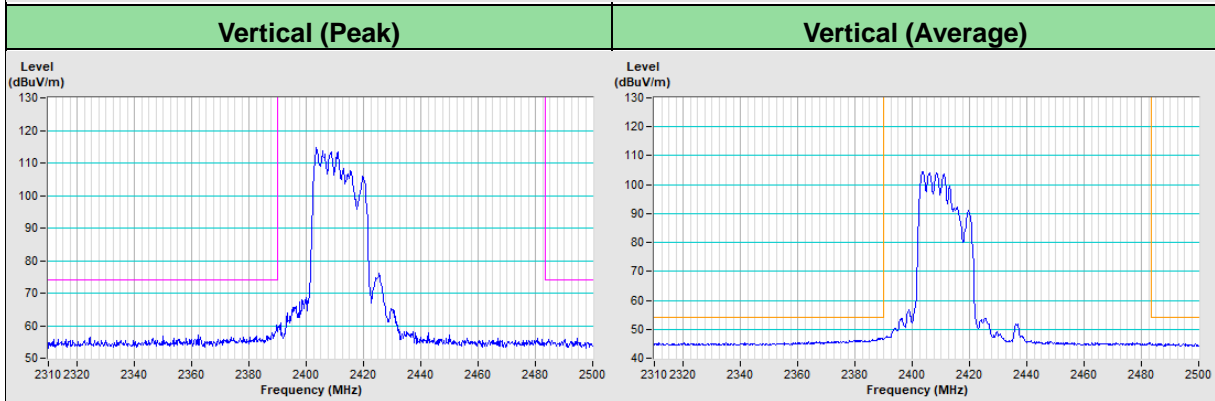
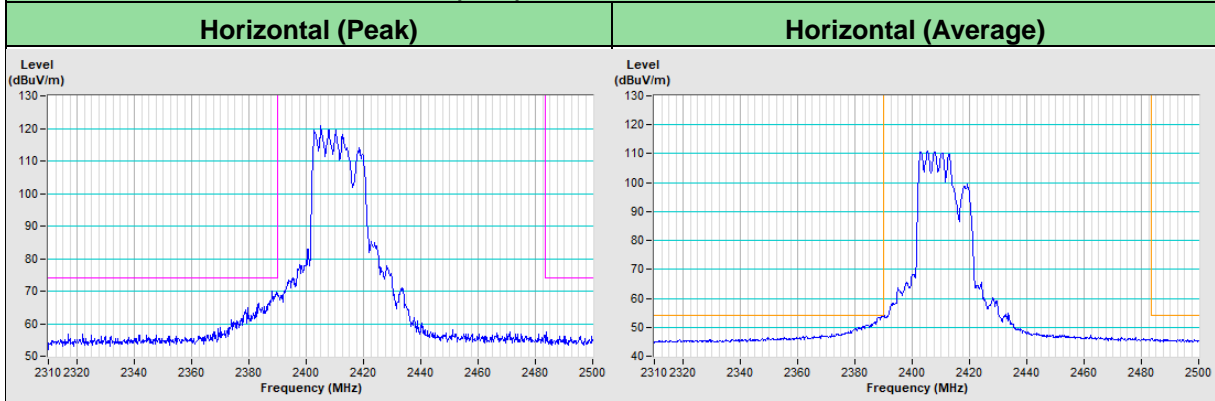

802.11be (EHT) 106+26-tone MRU Channel 11

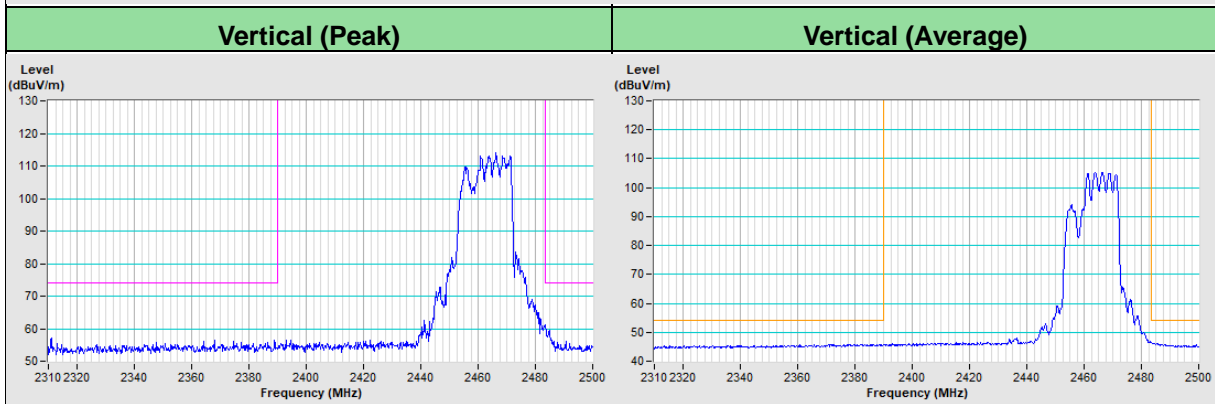
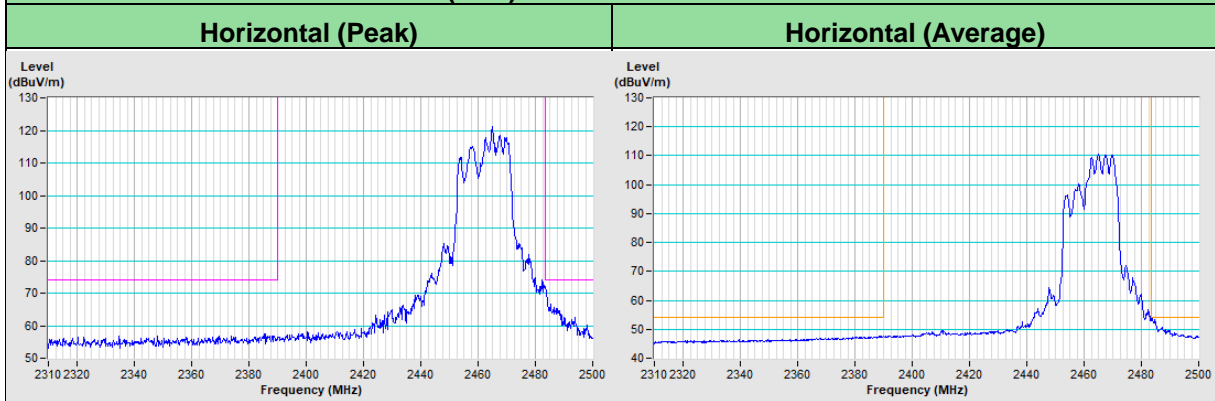

802.11be (EHT) 106+26-tone MRU Channel 12

Horizontal (Peak)

Horizontal (Average)

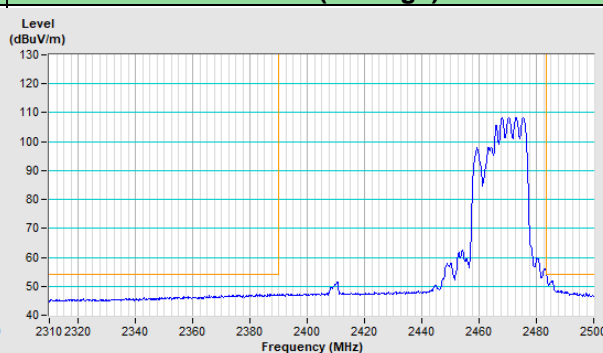
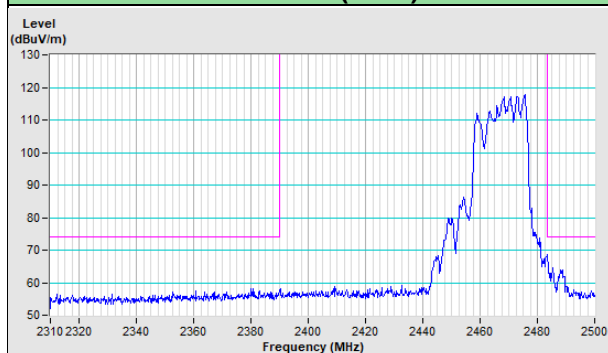

Vertical (Peak)

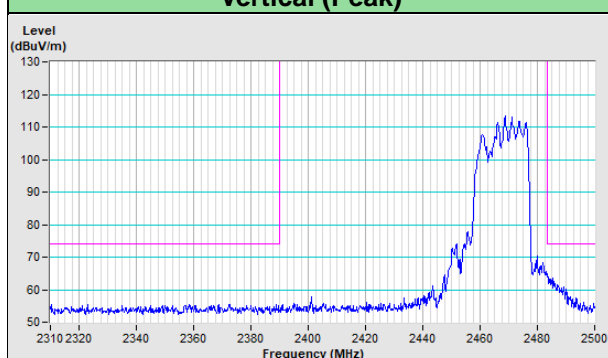

Vertical (Average)

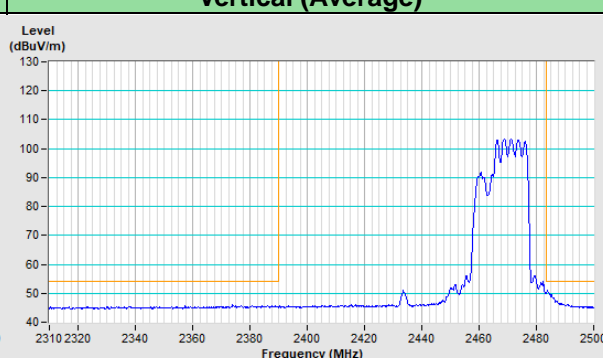

802.11be (EHT) 106+26-tone MRU Channel 13

Horizontal (Peak)

Horizontal (Average)

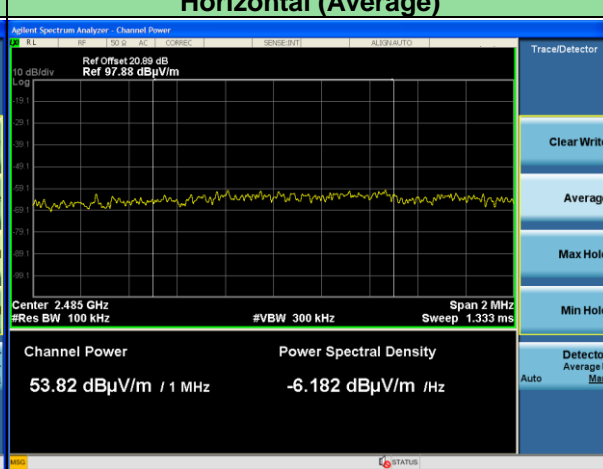
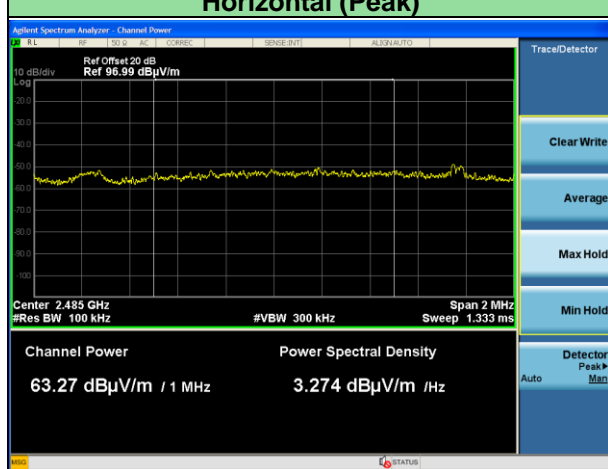

Vertical (Peak)

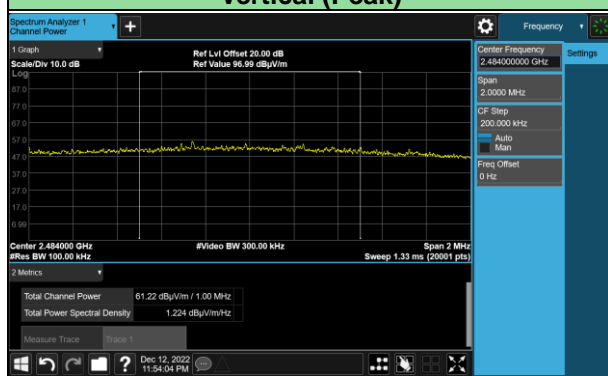

Vertical (Average)

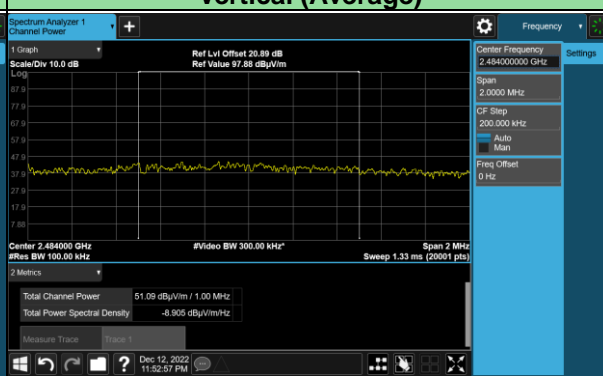

8 Pictures of Test Arrangements

Please refer to the attached file (Test Setup Photo)

9 Information of the Testing Laboratories

We, Bureau Veritas Consumer Products Services (H.K.) Ltd., Taoyuan Branch, were founded in 1988 to provide our best service in EMC, Radio, Telecom and Safety consultation. Our laboratories are FCC recognized accredited test firms and accredited according to ISO/IEC 17025.

If you have any comments, please feel free to contact us at the following:

Lin Kou EMC/RF Lab

Tel: 886-2-26052180

Fax: 886-2-26051924

Hsin Chu EMC/RF/Telecom Lab

Tel: 886-3-6668565

Fax: 886-3-6668323

Hwa Ya EMC/RF/Safety Lab

Tel: 886-3-3183232

Fax: 886-3-3270892

Email: service.adt@bureauveritas.com

Web Site: <http://ee.bureauveritas.com.tw>

The address and road map of all our labs can be found in our web site also.

--- END ---