

## FCC Test Report

**Report No.:** RFBARR-WTW-P22060042-2 R1

**FCC ID:** RAS-MT7927

**Test Model:** MT7927

**Received Date:** 2022/6/6

**Test Date:** 2022/7/8 ~ 2022/12/27

**Issued Date:** 2022/12/28

**Applicant:** MediaTek Inc.

**Address:** No. 1, Dusing 1st Rd., Hsinchu Science Park, Hsinchu City, 30078 Taiwan

**Issued By:** Bureau Veritas Consumer Products Services (H.K.) Ltd., Taoyuan Branch  
Hsin Chu Laboratory

**Lab Address:** E-2, No.1, Li Hsin 1st Road, Hsinchu Science Park, Hsinchu City 300,  
Taiwan

**Test Location:** E-2, No.1, Li Hsin 1st Road, Hsinchu Science Park, Hsinchu City 300,  
Taiwan

**FCC Registration /  
Designation Number:** 723255 / TW2022



This report is governed by, and incorporates by reference, the Conditions of Testing as posted at the date of issuance of this report at <http://www.bureauveritas.com/home/about-us/our-business/cps/about-us/terms-conditions/> and is intended for your exclusive use. Any copying or replication of this report to or for any other person or entity, or use of our name or trademark, is permitted only with our prior written permission. This report sets forth our findings solely with respect to the test samples identified herein. The results set forth in this report are not indicative or representative of the quality or characteristics of the lot from which a test sample was taken or any similar or identical product unless specifically and expressly noted. Our report includes all of the tests requested by you and the results thereof based upon the information that you provided to us. Measurement uncertainty is only provided upon request for accredited tests. Statements of conformity are based on simple acceptance criteria without taking measurement uncertainty into account, unless otherwise requested in writing. You have 60 days from date of issuance of this report to notify us of any material error or omission caused by our negligence or if you require measurement uncertainty; provided, however, that such notice shall be in writing and shall specifically address the issue you wish to raise. A failure to raise such issue within the prescribed time shall constitute your unqualified acceptance of the completeness of this report, the tests conducted and the correctness of the report contents.

## Table of Contents

<b>Release Control Record</b> .....	<b>4</b>
<b>1 Certificate of Conformity</b> .....	<b>5</b>
<b>2 Summary of Test Results</b> .....	<b>6</b>
2.1 Measurement Uncertainty.....	6
2.2 Modification Record.....	6
<b>3 General Information</b> .....	<b>7</b>
3.1 General Description of EUT.....	7
3.2 Description of Test Modes.....	10
3.2.1 Test Mode Applicability and Tested Channel Detail.....	14
3.3 Duty Cycle of Test Signal.....	20
3.4 Description of Support Units.....	22
3.4.1 Configuration of System under Test.....	23
3.5 General Description of Applied Standard.....	24
<b>4 Test Types and Results</b> .....	<b>25</b>
4.1 Radiated Emission and Bandedge Measurement.....	25
4.1.1 Limits of Radiated Emission and Bandedge Measurement.....	25
4.1.2 Test Instruments.....	26
4.1.3 Test Procedure.....	29
4.1.4 Test Setup.....	31
4.1.5 EUT Operating Condition.....	32
4.1.6 Test Results (Radiated with 50 ohm load).....	33
4.1.6.1 Test Results (Mode 1).....	34
4.1.6.2 Test Results (Mode 2).....	109
4.1.7 Test Results (Conducted).....	184
4.1.7.1 Test Results (Mode 1).....	185
4.1.7.2 Test Results (Mode 2).....	352
4.2 In-Band Emission (Mask) Measurement.....	592
4.2.1 Limits of In-Band Emission (Mask) Measurement.....	592
4.2.2 Test Setup.....	592
4.2.3 Test Instruments.....	592
4.2.4 Test Procedure.....	593
4.2.5 EUT Operating Condition.....	593
4.2.6 Test Results (Mode 1).....	594
4.2.7 Test Results (Mode 2).....	606
4.3 Conducted Emission Measurement.....	631
4.3.1 Limits of Conducted Emission Measurement.....	631
4.3.2 Test Instruments.....	631
4.3.3 Test Procedure.....	632
4.3.4 Test Setup.....	632
4.3.5 EUT Operating Condition.....	632
4.3.6 Test Results (Mode 1).....	633
4.3.7 Test Results (Mode 2).....	635
4.4 Transmit Power Measurement.....	637
4.4.1 Limits of Transmit Power Measurement.....	637
4.4.2 Test Setup.....	637
4.4.3 Test Instruments.....	637
4.4.4 Test Procedure.....	637
4.4.5 EUT Operating Condition.....	637
4.4.6 Test Result (Mode 1).....	638
4.4.7 Test Result (Mode 2).....	648
4.5 Emission Bandwidth Measurement.....	658
4.5.1 Limits of Emission Bandwidth Measurement.....	658
4.5.2 Test Setup.....	658

4.5.3	Test Instruments .....	658
4.5.4	Test Procedure .....	658
4.5.5	Test Results (Mode 1).....	659
4.5.6	Test Results (Mode 2).....	677
4.6	Peak Power Spectral Density Measurement .....	695
4.6.1	Limits of Peak Power Spectral Density Measurement .....	695
4.6.2	Test Setup.....	695
4.6.3	Test Instruments .....	695
4.6.4	Test Procedure .....	695
4.6.5	EUT Operating Condition .....	695
4.6.6	Test Results (Mode 1).....	696
4.6.7	Test Results (Mode 2).....	708
4.7	Contention Based Protocol Measurement .....	720
4.7.1	Limits of Contention Based Protocol Measurement .....	720
4.7.2	Test Setup.....	720
4.7.3	Test Instruments .....	720
4.7.4	Test Procedure .....	721
4.7.5	EUT Operating Condition .....	721
4.7.6	Test Results (Mode 1).....	722
4.7.7	Test Results (Mode 2).....	746
4.8	Frequency Stability Measurement .....	770
4.8.1	Limits of Frequency Stability Measurement .....	770
4.8.2	Test Setup.....	770
4.8.3	Test Instruments .....	770
4.8.4	Test Procedure .....	770
4.8.5	EUT Operating Condition .....	770
4.8.6	Test Results .....	771
4.9	Operational Restrictions for 6GHz U-NII Devices .....	772
4.9.1	Limits of Operational Restrictions for 6 GHz U-NII Devices.....	772
4.9.2	Test Setup.....	772
4.9.3	Test Instruments .....	772
4.9.4	Test Procedure .....	772
4.9.5	Test Results .....	772
<b>5</b>	<b>Pictures of Test Arrangements.....</b>	<b>773</b>
	<b>Appendix – Information of the Testing Laboratories .....</b>	<b>774</b>

### Release Control Record

Issue No.	Description	Date Issued
RFBARR-WTW-P22060042-2	Original release.	2022/9/8
RFBARR-WTW-P22060042-2 R1	1. Modified test instruments on section 4.1.2. 2. Modified test data on section 4.2.6 & 4.2.7 & 4.5.5 & 4.5.6 (802.11be (EHT320)).	2022/12/28

## 1 Certificate of Conformity

**Product:** 2TX 11be (WiFi7) BW320 + BT/BLE Combo Card

**Brand:** MediaTek

**Test Model:** MT7927

**Sample Status:** Engineering sample

**Applicant:** MediaTek Inc.

**Test Date:** 2022/7/8 ~ 2022/12/27

**Standard:** 47 CFR FCC Part 15, Subpart E (Section 15.407)

**Measurement** ANSI C63.10-2013

**procedure:**

KDB 987594 D02 EMC Measurement v01r01

KDB 789033 D02 General UNII Test Procedure New Rules v02r01

KDB 662911 D01 Multiple Transmitter Output v02r01

The above equipment has been tested by **Bureau Veritas Consumer Products Services (H.K.) Ltd., Taoyuan Branch**, and found compliance with the requirement of the above standards. The test record, data evaluation & Equipment Under Test (EUT) configurations represented herein are true and accurate accounts of the measurements of the sample's EMC characteristics under the conditions specified in this report.

**Prepared by :**  , **Date:** 2022/12/28  
Claire Kuan / Specialist

**Approved by :**  , **Date:** 2022/12/28  
May Chen / Manager

## 2 Summary of Test Results

47 CFR FCC Part 15, Subpart E (Section 15.407)			
FCC Clause	Test Item	Result	Remarks
15.407(b)(8)	AC Power Conducted Emissions	PASS	Meet the requirement of limit. Minimum passing margin is -15.13dB at 0.20469MHz.
15.407(b)(5)(8)	Radiated Emissions	PASS	Meet the requirement of limit. Minimum passing margin is -3.0dB at 142.04MHz.
15.407(b)(6)	In-Band Emission (Mask)	PASS	Meet the requirement of limit.
15.407(a)(4/5/6/7/8)	Max Average Transmit Power	PASS	Meet the requirement of limit.
15.407(a)(10)	Emission Bandwidth Measurement	PASS	Meet the requirement of limit.
15.407(a)(4/5/6/7/8)	Peak Power Spectral Density	PASS	Meet the requirement of limit.
15.407 (d)(6)	Contention-based Protocol.	PASS	Meet the requirement of limit.
15.407(g)	Frequency Stability	PASS	Meet the requirement of limit.
15.407(a)(7)(8)	Dual Client- Proper Power Adjustment	N/A	Device associates with low power indoor AP only.
15.407(d)	Operational restrictions for 6 GHz U-NII devices	PASS	Declaration by applicant
15.203	Antenna Requirement	PASS	Antenna connector is ipex(MHF) not a standard connector.

### Note:

Determining compliance based on the results of the compliance measurement, not taking into account measurement instrumentation uncertainty.

### 2.1 Measurement Uncertainty

Where relevant, the following measurement uncertainty levels have been estimated for tests performed on the EUT as specified in CISPR 16-4-2:

Measurement	Frequency	Expanded Uncertainty (k=2) (±)
Conducted Emissions at mains ports	150kHz ~ 30MHz	1.9 dB
Radiated Emissions up to 1 GHz	9kHz ~ 30MHz	3.1 dB
	30MHz ~ 1GHz	5.5 dB
Radiated Emissions above 1 GHz	1GHz ~ 18GHz	5.1 dB
	18GHz ~ 40GHz	5.3 dB

### 2.2 Modification Record

There were no modifications required for compliance.

### 3 General Information

#### 3.1 General Description of EUT

Product	2TX 11be (WiFi7) BW320 + BT/BLE Combo Card
Brand	MediaTek
Test Model	MT7927
Status of EUT	Engineering sample
Power Supply Rating	3.3Vdc from host equipment
Modulation Type	64QAM, 16QAM, QPSK, BPSK for OFDM 1024QAM for OFDMA in 11ax mode 4096QAM for OFDMA in 11be mode
Modulation Technology	OFDM, OFDMA
Transfer Rate	802.11a: up to 54 Mbps 802.11ax: up to 1201.0 Mbps 802.11be: up to 5764.8 Mbps
Operating Frequency	5.955 ~ 6.425GHz, 6.425 ~ 6.525GHz, 6.525 ~ 6.875GHz, 6.875 ~ 7.115GHz
Number of Channel	802.11a/ax (HE20), 802.11be (EHT20): 59 802.11ax (HE40), 802.11be (EHT40): 29 802.11ax (HE80), 802.11be (EHT80): 14 802.11ax (HE160), 802.11be (EHT160): 7 802.11be (EHT320): 6
Output Power	<b>For 1TX</b> <b>5.955 ~ 6.425GHz:</b> 65.163 mW (EIRP: 22.9 dBm / 194.984 mW) <b>6.425 ~ 6.525GHz:</b> 33.806 mW (EIRP: 19.58 dBm / 90.782 mW) <b>6.525 ~ 6.855GHz:</b> 68.077 mW (EIRP: 22.94 dBm / 196.789 mW) <b>6.875 ~ 7.115GHz:</b> 69.663 mW (EIRP: 22.52 dBm / 178.649 mW) <b>For 2TX</b> <b>5.955 ~ 6.425GHz:</b> 65.66 mW (EIRP: 22.93 dBm / 196.336 mW) <b>6.425 ~ 6.525GHz:</b> 35.177 mW (EIRP: 20.22 dBm / 105.196 mW) <b>6.525 ~ 6.855GHz:</b> 68.169 mW (EIRP: 22.95 dBm / 197.242 mW) <b>6.875 ~ 7.115GHz:</b> 69.78 mW (EIRP: 22.53 dBm / 179.061 mW)
Antenna Type	Refer to Note
Antenna Connector	Refer to Note
Accessory Device	NA
Data Cable Supplied	NA

Note:

1. There are Bluetooth and WLAN (2.4GHz & 5GHz & 6GHz) technology used for the EUT.
2. Simultaneously transmission condition.

Condition	Technology	
1	WLAN (5GHz)	Bluetooth
2	WLAN (6GHz)	Bluetooth
3	WLAN (2.4GHz)	WLAN (5GHz)
4	WLAN (2.4GHz)	WLAN (6GHz)

Note: The emission of the simultaneous operation has been evaluated and no non-compliance was found.

3. The antennas provided to the EUT, please refer to the following table:

Antenna Set No	RF Chain No.	Brand	Model	Antenna Net Gain (dBi)	Frequency Range (GHz)	Antenna Type	Connector Type	Cable Length (mm)
1	Chain0	PSA	RFMTA340718EMLB302	3.18	2.4~2.4835	PIFA	ipex(MHF)	200
				4.92	5.15~5.895			
	Chain1	PSA	RFMTA340718EMLB302	3.18	2.4~2.4835	PIFA	ipex(MHF)	200
				4.92	5.15~5.895			
2	Chain0	PSA	RFMTA311020EMMB301	1.71	2.4~2.4835	PIFA	ipex(MHF)	200
				4.82	5.15~5.895			
				4.76	5.925~6.425			
				4.29	6.425~6.525			
				4.61	6.525~6.875			
				4.09	6.875~7.125			
	Chain1	PSA	RFMTA311020EMMB301	1.71	2.4~2.4835	PIFA	ipex(MHF)	200
				4.82	5.15~5.895			
				4.76	5.925~6.425			
				4.29	6.425~6.525			
				4.61	6.525~6.875			
				4.09	6.875~7.125			
3	Chain0	PSA	RFMTA421208IMMB701	-4.99	5.925~7.125	PIFA	ipex(MHF)	300
	Chain1	PSA	RFMTA421208IMMB701	-4.99	5.925~7.125	PIFA	ipex(MHF)	300

Note:

- From the above transmission chains, the worse case was found in transmission on Chain 0 for 1TX diversity sample. Therefore only the test data of the mode was recorded in this report.
- Max. gain was selected for the final test.



4. The EUT incorporates a MIMO function:

<b>6GHz Band</b>				
<b>MODULATION MODE</b>	<b>TX configuration</b>		<b>CDD mode</b>	<b>Beamforming mode</b>
<b>802.11a</b>	<b>SISO</b>	1TX	Not Support	Not Support
<b>802.11ax (HE20)</b>		1TX	Not Support	Not Support
<b>802.11ax (HE40)</b>		1TX	Not Support	Not Support
<b>802.11ax (HE80)</b>		1TX	Not Support	Not Support
<b>802.11ax (HE160)</b>		1TX	Not Support	Not Support
<b>802.11be (EHT20)</b>		1TX	Not Support	Not Support
<b>802.11be (EHT40)</b>		1TX	Not Support	Not Support
<b>802.11be (EHT80)</b>		1TX	Not Support	Not Support
<b>802.11be (EHT160)</b>		1TX	Not Support	Not Support
<b>802.11be (EHT320)</b>		1TX	Not Support	Not Support
<b>802.11a</b>		<b>MIMO</b>	2TX	Support
<b>802.11ax (HE20)</b>	2TX		Support NSS2	Not Support
<b>802.11ax (HE40)</b>	2TX		Support NSS2	Not Support
<b>802.11ax (HE80)</b>	2TX		Support NSS2	Not Support
<b>802.11ax (HE160)</b>	2TX		Support NSS2	Not Support
<b>802.11be (EHT20)</b>	2TX		Support NSS2	Not Support
<b>802.11be (EHT40)</b>	2TX		Support NSS2	Not Support
<b>802.11be (EHT80)</b>	2TX		Support NSS2	Not Support
<b>802.11be (EHT160)</b>	2TX		Support NSS2	Not Support
<b>802.11be (EHT320)</b>	2TX		Support NSS2	Not Support

Note: The modulation and bandwidth are similar for 802.11ax mode for 20MHz (40MHz, 80MHz, 160MHz) and 802.11be mode for 20MHz (40MHz, 80MHz, 160MHz) therefore the manufacturer will control the power for 802.11ax mode is same as the 802.11be mode or more lower than it and investigated worst case to representative mode in test report. (Final test mode refer to section 3.2.1)

5. The above EUT information is declared by manufacturer and for more detailed features description, please refers to the manufacturer's specifications or user's manual.
6. Detail antenna specification please refer to antenna datasheet and/or antenna measurement report.

### 3.2 Description of Test Modes

#### U-NII-5 (5925 ~ 6425MHz)

24 channels are provided for 802.11a, 802.11ax (HE20), 802.11be (EHT20):

Channel	Frequency	Channel	Frequency	Channel	Frequency	Channel	Frequency
1	5955 MHz	5	5975 MHz	9	5955 MHz	13	6015 MHz
17	6035 MHz	21	6055 MHz	25	6075 MHz	29	6095 MHz
33	6115 MHz	37	6135 MHz	41	6155 MHz	45	6175 MHz
49	6195 MHz	53	6215 MHz	57	6235 MHz	61	6255 MHz
65	6275 MHz	69	6295 MHz	73	6315 MHz	77	6335 MHz
81	6355 MHz	85	6375 MHz	89	6395 MHz	93	6415MHz

12 channels are provided for 802.11ax (HE40), 802.11be (EHT40):

Channel	Frequency	Channel	Frequency	Channel	Frequency	Channel	Frequency
3	5965 MHz	11	6005 MHz	19	6045 MHz	27	6085 MHz
35	6125 MHz	43	6165 MHz	51	6205 MHz	59	6245 MHz
67	6285 MHz	75	6325 MHz	83	6365 MHz	91	6405 MHz

6 channels are provided for 802.11ax (HE80), 802.11be (EHT80):

Channel	Frequency	Channel	Frequency	Channel	Frequency	Channel	Frequency
7	5985 MHz	23	6065 MHz	39	6145 MHz	55	6225 MHz
71	6305 MHz	87	6385 MHz				

3 channels are provided for 802.11ax (HE160), 802.11be (EHT160):

Channel	Frequency	Channel	Frequency	Channel	Frequency
15	6025 MHz	47	6185 MHz	79	6345 MHz

2 channels are provided for 802.11be (EHT320):

Channel	Frequency	Channel	Frequency
31	6105 MHz	63	6265 MHz

### U-NII-6 (6425 ~ 6525MHz)

5 channels are provided for 802.11a, 802.11ax (HE20), 802.11be (EHT20):

Channel	Frequency	Channel	Frequency	Channel	Frequency	Channel	Frequency
97	6435 MHz	101	6455 MHz	105	6475 MHz	109	6495 MHz
113	6515 MHz						

3 channels are provided for 802.11ax (HE40), 802.11be (EHT40):

Channel	Frequency	Channel	Frequency	Channel	Frequency
99	6445 MHz	107	6485 MHz	*115	6525 MHz

1 channel is provided for 802.11ax (HE80), 802.11be (EHT80):

Channel	Frequency
103	6465 MHz

1 channel is provided for 802.11ax (HE160), 802.11be (EHT160):

Channel	Frequency
*111	6505 MHz

1 channel is provided for 802.11be (EHT320):

Channel	Frequency
*95	6425 MHz

### U-NII-7 (6525 ~ 6875MHz)

18 channels are provided for 802.11a, 802.11ax (HE20), 802.11be (EHT20):

Channel	Frequency	Channel	Frequency	Channel	Frequency	Channel	Frequency
117	6535 MHz	121	6555 MHz	125	6575 MHz	129	6595 MHz
133	6615 MHz	137	6635 MHz	141	6655 MHz	145	6675 MHz
149	6695 MHz	153	6715 MHz	157	6735 MHz	161	6755 MHz
165	6775 MHz	169	6795 MHz	173	6815 MHz	177	6835 MHz
181	6855 MHz	*185	6875 MHz				

8 channels are provided for 802.11ax (HE40), 802.11be (EHT40):

Channel	Frequency	Channel	Frequency	Channel	Frequency	Channel	Frequency
123	6565 MHz	131	6605 MHz	139	6645 MHz	147	6685 MHz
155	6725 MHz	163	6765 MHz	171	6805 MHz	179	6845 MHz

5 channels are provided for 802.11ax (HE80), 802.11be (EHT80):

Channel	Frequency	Channel	Frequency	Channel	Frequency	Channel	Frequency
*119	6545 MHz	135	6625 MHz	151	6705 MHz	167	6785 MHz
*183	6865 MHz						

2 channels are provided for 802.11ax (HE160), 802.11be (EHT160):

Channel	Frequency	Channel	Frequency
143	6665 MHz	*175	6825 MHz

2 channels are provided for 802.11be (EHT320):

Channel	Frequency	Channel	Frequency
*127	6585 MHz	*159	6745 MHz

### U-NII-8 (6875 ~ 7125MHz)

12 channels are provided for 802.11a, 802.11ax (HE20), 802.11be (EHT20):

Channel	Frequency	Channel	Frequency	Channel	Frequency	Channel	Frequency
189	6895 MHz	193	6915 MHz	197	6935 MHz	201	6955 MHz
205	6975 MHz	209	6995 MHz	213	7015 MHz	217	7035 MHz
221	7055 MHz	225	7075 MHz	229	7095 MHz	233	7115 MHz

6 channels are provided for 802.11ax (HE40), 802.11be (EHT40):

Channel	Frequency	Channel	Frequency	Channel	Frequency
*187	6885 MHz	195	6925 MHz	203	6965 MHz
211	7005 MHz	219	7045 MHz	227	7085 MHz

2 channels are provided for 802.11ax (HE80), 802.11be (EHT80):

Channel	Frequency	Channel	Frequency
199	6945 MHz	215	7025 MHz

1 channel is provided for 802.11ax (HE160), 802.11be (EHT160):

Channel	Frequency
207	6985 MHz

1 channel is provided for 802.11be (EHT320):

Channel	Frequency
*191	6905 MHz

Note: \* mean this's straddle channel.

### 3.2.1 Test Mode Applicability and Tested Channel Detail

EUT Configure Mode	Applicable To						Description
	RE $\geq$ 1G	RE<1G	IBE	PLC	CBP	APCM	
1	√	√	√	√	√	√	For 1TX
2	√	√	√	√	√	√	For 2TX

Where **RE $\geq$ 1G**: Radiated Emission above 1GHz  
**RE<1G**: Radiated Emission below 1GHz  
**PLC**: Power Line Conducted Emission  
**APCM**: Antenna Port Conducted Measurement  
**IBE**: In-Band Emission (MASK)  
**CBP**:Contention Based Protocol

Note: The EUT'antenna had been pre-tested on the positioned of each 3 axis. The worst case was found when positioned on Z-plane.

#### **Radiated Emission Measurement (Above 1GHz): (Radiated with 50 ohm load & Conducted)**

- Pre-Scan has been conducted to determine the worst-case mode from all possible combinations between available modulations, data rates and antenna ports (if EUT with antenna diversity architecture).
- Following channel(s) was (were) selected for the final test as listed below.

Mode	FREQ. Band (MHz)	Available Channel	Tested Channel	Modulation Technology	Modulation Type	Data Rate Parameter
802.11a	5955-6415	1 to 93	1, 45, 93	OFDM	BPSK	MCS0
	6435-6525	97 to 113	97, 105, 113	OFDM	BPSK	MCS0
	6525-6855	117 to 185	117, 153, 181, 185	OFDM	BPSK	MCS0
	6875-7115	185 to 233	213, 233	OFDM	BPSK	MCS0
802.11ax (HE20)	5955-6415	1 to 93	1, 233	OFDMA	BPSK	MCS0
	6435-6525	97 to 113		OFDMA	BPSK	MCS0
	6525-6855	117 to 185		OFDMA	BPSK	MCS0
	6875-7115	185 to 233		OFDMA	BPSK	MCS0
802.11ax (HE40)	5955-6415	3 to 91	3, 227	OFDMA	BPSK	MCS0
	6435-6525	99 to 115		OFDMA	BPSK	MCS0
	6525-6855	115 to 179		OFDMA	BPSK	MCS0
	6875-7115	187 to 227		OFDMA	BPSK	MCS0
802.11ax (HE80)	5955-6415	7 to 87	7, 215	OFDMA	BPSK	MCS0
	6435-6525	103		OFDMA	BPSK	MCS0
	6525-6855	119 to 183		OFDMA	BPSK	MCS0
	6875-7115	199 to 215		OFDMA	BPSK	MCS0
802.11ax (HE160)	5955-6415	15 to 79	15, 47, 79	OFDMA	BPSK	MCS0
	6435-6525	111	111	OFDMA	BPSK	MCS0
	6525-6855	143 to 175	143, 175	OFDMA	BPSK	MCS0
	6875-7115	207	207	OFDMA	BPSK	MCS0

Mode	FREQ. Band (MHz)	Available Channel	Tested Channel	Modulation Technology	Modulation Type	Data Rate Parameter
802.11be (EHT20)	5955-6415	1 to 93	1, 45, 93	OFDMA	BPSK	MCS0
	6435-6525	97 to 113	97, 105, 113	OFDMA	BPSK	MCS0
	6525-6855	117 to 185	117, 153, 181, 185	OFDMA	BPSK	MCS0
	6875-7115	185 to 233	213, 233	OFDMA	BPSK	MCS0
802.11be (EHT40)	5955-6415	3 to 91	3, 43, 91	OFDMA	BPSK	MCS0
	6435-6525	99 to 115	99, 107, 115	OFDMA	BPSK	MCS0
	6525-6855	115 to 179	123, 155, 179	OFDMA	BPSK	MCS0
	6875-7115	187 to 227	187, 211, 227	OFDMA	BPSK	MCS0
802.11be (EHT80)	5955-6415	7 to 87	7, 39, 87	OFDMA	BPSK	MCS0
	6435-6525	103	103	OFDMA	BPSK	MCS0
	6525-6855	119 to 183	119, 135, 151, 167, 183	OFDMA	BPSK	MCS0
	6875-7115	199 to 215	199, 215	OFDMA	BPSK	MCS0
802.11be (EHT160)	5955-6415	15 to 79	15, 47, 79	OFDMA	BPSK	MCS0
	6435-6525	111	111	OFDMA	BPSK	MCS0
	6525-6855	143 to 175	143, 175	OFDMA	BPSK	MCS0
	6875-7115	207	207	OFDMA	BPSK	MCS0
802.11be (EHT320)	6105 & 6265	31 & 63	31, 63	OFDMA	BPSK	MCS0
	6425	95	95	OFDMA	BPSK	MCS0
	6585 & 6745	127 & 159	127, 159	OFDMA	BPSK	MCS0
	6905	191	191	OFDMA	BPSK	MCS0

#### **Radiated Emission Measurement (Below 1GHz): (Radiated with 50 ohm load & Conducted)**

- Pre-Scan has been conducted to determine the worst-case mode from all possible combinations between available modulations, data rates and antenna ports (if EUT with antenna diversity architecture).
- Following channel(s) was (were) selected for the final test as listed below.

Mode	FREQ. Band (MHz)	Available Channel	Tested Channel	Modulation Technology	Modulation Type	Data Rate Parameter
802.11be (EHT320)	6105 & 6265	31 & 63	159	OFDMA	BPSK	MCS0
	6425	95				
	6585 & 6745	127 & 159				
	6905	191				

### In-Band Emission (MASK) Measurement:

- Pre-Scan has been conducted to determine the worst-case mode from all possible combinations between available modulations, data rates and antenna ports (if EUT with antenna diversity architecture).
- Following channel(s) was (were) selected for the final test as listed below.

Mode	FREQ. Band (MHz)	Available Channel	Tested Channel	Modulation Technology	Modulation Type	Data Rate Parameter
802.11a	5955-6415	1 to 93	1, 45, 93	OFDM	BPSK	MCS0
	6435-6525	97 to 113	97, 105, 113	OFDM	BPSK	MCS0
	6525-6855	117 to 185	117, 153, 181, 185	OFDM	BPSK	MCS0
	6875-7115	185 to 233	213, 233	OFDM	BPSK	MCS0
802.11ax (HE20)	5955-6415	1 to 93	1, 233	OFDMA	BPSK	MCS0
	6435-6525	97 to 113		OFDMA	BPSK	MCS0
	6525-6855	117 to 185		OFDMA	BPSK	MCS0
	6875-7115	185 to 233		OFDMA	BPSK	MCS0
802.11ax (HE40)	5955-6415	3 to 91	3, 227	OFDMA	BPSK	MCS0
	6435-6525	99 to 115		OFDMA	BPSK	MCS0
	6525-6855	115 to 179		OFDMA	BPSK	MCS0
	6875-7115	187 to 227		OFDMA	BPSK	MCS0
802.11ax (HE80)	5955-6415	7 to 87	7, 215	OFDMA	BPSK	MCS0
	6435-6525	103		OFDMA	BPSK	MCS0
	6525-6855	119 to 183		OFDMA	BPSK	MCS0
	6875-7115	199 to 215		OFDMA	BPSK	MCS0
802.11ax (HE160)	5955-6415	15 to 79	15, 47, 79	OFDMA	BPSK	MCS0
	6435-6525	111	111	OFDMA	BPSK	MCS0
	6525-6855	143 to 175	143,175	OFDMA	BPSK	MCS0
	6875-7115	207	207	OFDMA	BPSK	MCS0
802.11be (EHT20)	5955-6415	1 to 93	1, 45, 93	OFDMA	BPSK	MCS0
	6435-6525	97 to 113	97, 105, 113	OFDMA	BPSK	MCS0
	6525-6855	117 to 185	117, 153, 181, 185	OFDMA	BPSK	MCS0
	6875-7115	185 to 233	213, 233	OFDMA	BPSK	MCS0
802.11be (EHT40)	5955-6415	3 to 91	3, 43, 91	OFDMA	BPSK	MCS0
	6435-6525	99 to 115	99, 107, 115	OFDMA	BPSK	MCS0
	6525-6855	115 to 179	123, 155, 179	OFDMA	BPSK	MCS0
	6875-7115	187 to 227	187, 211, 227	OFDMA	BPSK	MCS0
802.11be (EHT80)	5955-6415	7 to 87	7, 39, 87	OFDMA	BPSK	MCS0
	6435-6525	103	103	OFDMA	BPSK	MCS0
	6525-6855	119 to 183	119, 151, 167, 183	OFDMA	BPSK	MCS0
	6875-7115	199 to 215	199, 215	OFDMA	BPSK	MCS0
802.11be (EHT160)	5955-6415	15 to 79	15, 47, 79	OFDMA	BPSK	MCS0
	6435-6525	111	111	OFDMA	BPSK	MCS0
	6525-6855	143 to 175	143,175	OFDMA	BPSK	MCS0
	6875-7115	207	207	OFDMA	BPSK	MCS0
802.11be (EHT320)	6105 & 6265	31 & 63	31, 63	OFDMA	BPSK	MCS0
	6425	95	95	OFDMA	BPSK	MCS0
	6585 & 6745	127 & 159	127, 159	OFDMA	BPSK	MCS0
	6905	191	191	OFDMA	BPSK	MCS0



### **Power Line Conducted Emission Measurement:**

- Pre-Scan has been conducted to determine the worst-case mode from all possible combinations between available modulations, data rates and antenna ports (if EUT with antenna diversity architecture).
- Following channel(s) was (were) selected for the final test as listed below.

Mode	FREQ. Band (MHz)	Available Channel	Tested Channel	Modulation Technology	Modulation Type	Data Rate Parameter
802.11be (EHT320)	6105 & 6265	31 & 63	159	OFDMA	BPSK	MCS0
	6425	95				
	6585 & 6745	127 & 159				
	6905	191				

### **Antenna Port Conducted Measurement:**

- This item includes all test value of each mode, but only includes spectrum plot of worst value of each mode.
- Pre-Scan has been conducted to determine the worst-case mode from all possible combinations between available modulations, data rates and antenna ports (if EUT with antenna diversity architecture).
- Following channel(s) was (were) selected for the final test as listed below.

Mode	FREQ. Band (MHz)	Available Channel	Tested Channel	Modulation Technology	Modulation Type	Data Rate Parameter
802.11a	5955-6415	1 to 93	1, 45, 93	OFDM	BPSK	MCS0
	6435-6525	97 to 113	97, 105, 113	OFDM	BPSK	MCS0
	6525-6855	117 to 185	117, 153, 181, 185	OFDM	BPSK	MCS0
	6875-7115	185 to 233	213, 233	OFDM	BPSK	MCS0
802.11ax (HE20)	5955-6415	1 to 93	1, 45, 93	OFDMA	BPSK	MCS0
	6435-6525	97 to 113	97, 105, 113	OFDMA	BPSK	MCS0
	6525-6855	117 to 185	117, 153, 181, 185	OFDMA	BPSK	MCS0
	6875-7115	185 to 233	213, 233	OFDMA	BPSK	MCS0
802.11ax (HE40)	5955-6415	3 to 91	3, 43, 91	OFDMA	BPSK	MCS0
	6435-6525	99 to 115	99, 107, 115	OFDMA	BPSK	MCS0
	6525-6855	115 to 179	123, 155, 179	OFDMA	BPSK	MCS0
	6875-7115	187 to 227	187, 211, 227	OFDMA	BPSK	MCS0
802.11ax (HE80)	5955-6415	7 to 87	7, 39, 87	OFDMA	BPSK	MCS0
	6435-6525	103	103	OFDMA	BPSK	MCS0
	6525-6855	119 to 183	119, 151, 167, 183	OFDMA	BPSK	MCS0
	6875-7115	199 to 215	199, 215	OFDMA	BPSK	MCS0
802.11ax (HE160)	5955-6415	15 to 79	15,47,79	OFDMA	BPSK	MCS0
	6435-6525	111	111	OFDMA	BPSK	MCS0
	6525-6855	143 to 175	143, 175	OFDMA	BPSK	MCS0
	6875-7115	207	207	OFDMA	BPSK	MCS0

Mode	FREQ. Band (MHz)	Available Channel	Tested Channel	Modulation Technology	Modulation Type	Data Rate Parameter
802.11be (EHT20)	5955-6415	1 to 93	1, 45, 93	OFDMA	BPSK	MCS0
	6435-6525	97 to 113	97, 105, 113	OFDMA	BPSK	MCS0
	6525-6855	117 to 185	117, 153, 181, 185	OFDMA	BPSK	MCS0
	6875-7115	185 to 233	213, 233	OFDMA	BPSK	MCS0
802.11be (EHT40)	5955-6415	3 to 91	3, 43, 91	OFDMA	BPSK	MCS0
	6435-6525	99 to 115	99, 107, 115	OFDMA	BPSK	MCS0
	6525-6855	115 to 179	123, 155, 179	OFDMA	BPSK	MCS0
	6875-7115	187 to 227	187, 211, 227	OFDMA	BPSK	MCS0
802.11be (EHT80)	5955-6415	7 to 87	7, 39, 87	OFDMA	BPSK	MCS0
	6435-6525	103	103	OFDMA	BPSK	MCS0
	6525-6855	119 to 183	119, 151, 167, 183	OFDMA	BPSK	MCS0
	6875-7115	199 to 215	199, 215	OFDMA	BPSK	MCS0
802.11be (EHT160)	5955-6415	15 to 79	15,47,79	OFDMA	BPSK	MCS0
	6435-6525	111	111	OFDMA	BPSK	MCS0
	6525-6855	143 to 175	143, 175	OFDMA	BPSK	MCS0
	6875-7115	207	207	OFDMA	BPSK	MCS0
802.11be (EHT320)	6105 & 6265	31 & 63	31, 63	OFDMA	BPSK	MCS0
	6425	95	95	OFDMA	BPSK	MCS0
	6585 & 6745	127 & 159	127, 159	OFDMA	BPSK	MCS0
	6905	191	191	OFDMA	BPSK	MCS0

#### **Contention Based Protocol Measurement:**

- Pre-Scan has been conducted to determine the worst-case mode from all possible combinations between available modulations, data rates and antenna ports (if EUT with antenna diversity architecture).
- Following channel(s) was (were) selected for the final test as listed below.

Mode	FREQ. Band (MHz)	Available Channel	Tested Channel	Modulation Technology	Modulation Type	Data Rate Parameter
802.11ax (HE20)	5955-6415	1 to 93	1	OFDMA	BPSK	MCS0
	6435-6525	97 to 113	97	OFDMA	BPSK	MCS0
	6525-6855	117 to 185	129	OFDMA	BPSK	MCS0
	6875-7115	185 to 233	193	OFDMA	BPSK	MCS0
802.11ax (HE160)	5955-6415	15 to 79	15	OFDMA	BPSK	MCS0
	6435-6525	111	111	OFDMA	BPSK	MCS0
	6525-6855	143 to 175	143	OFDMA	BPSK	MCS0
	6875-7115	207	207	OFDMA	BPSK	MCS0
802.11be (EHT20)	5955-6415	1 to 93	1	OFDMA	BPSK	MCS0
	6435-6525	97 to 113	97	OFDMA	BPSK	MCS0
	6525-6855	117 to 185	129	OFDMA	BPSK	MCS0
	6875-7115	185 to 233	193	OFDMA	BPSK	MCS0
802.11be (EHT320)	6105 & 6265	31 & 63	31	OFDMA	BPSK	MCS0
	6425	95	95	OFDMA	BPSK	MCS0
	6585 & 6745	127 & 159	159	OFDMA	BPSK	MCS0
	6905	191	191	OFDMA	BPSK	MCS0

**Test Condition:**

Applicable To	Environmental Conditions	Input Power (System)	Tested By
RE $\geq$ 1G	25deg. C, 68%RH	120Vac, 60Hz	Tom Yang
RE<1G	25deg. C, 66%RH	120Vac, 60Hz	Tom Yang
PLC	24deg. C, 71%RH 25deg. C, 75%RH	120Vac, 60Hz	Sampson Chen
APCM	25deg. C, 63%RH	120Vac, 60Hz	Eric Peng
CBP	25deg. C, 60%RH	120Vac, 60Hz	Tobey Chen

### 3.3 Duty Cycle of Test Signal

Duty cycle of test signal is  $\geq 98\%$ , duty factor is not required.  
 Duty cycle of test signal is  $< 98\%$ , duty factor shall be considered.

- 802.11a:** Duty cycle = 2.018 ms / 2.154 ms x 100% = 93.7%, duty factor =  $10 \cdot \log(1/\text{Duty cycle}) = 0.28$  dB
- 802.11ax (HE20):** Duty cycle = 3.938 ms / 4.079 ms x 100% = 96.5%, duty factor =  $10 \cdot \log(1/\text{Duty cycle}) = 0.15$  dB
- 802.11ax (HE40):** Duty cycle = 3.955 ms / 4.081 ms x 100% = 96.9%, duty factor =  $10 \cdot \log(1/\text{Duty cycle}) = 0.14$  dB
- 802.11ax (HE80):** Duty cycle = 1.928 ms / 2.048 ms x 100% = 94.1%, duty factor =  $10 \cdot \log(1/\text{Duty cycle}) = 0.26$  dB
- 802.11ax (HE160):** Duty cycle = 1.008 ms / 1.124 ms x 100% = 89.7%, duty factor =  $10 \cdot \log(1/\text{Duty cycle}) = 0.47$  dB
- 802.11be (EHT20):** Duty cycle = 4.642 ms / 4.767 ms x 100% = 97.4%, duty factor =  $10 \cdot \log(1/\text{Duty cycle}) = 0.12$  dB
- 802.11be (EHT40):** Duty cycle = 4.658 ms / 4.775 ms x 100% = 97.5%, duty factor =  $10 \cdot \log(1/\text{Duty cycle}) = 0.11$  dB
- 802.11be (EHT80):** Duty cycle = 2.268 ms / 2.39 ms x 100% = 94.9%, duty factor =  $10 \cdot \log(1/\text{Duty cycle}) = 0.23$  dB
- 802.11be (EHT160):** Duty cycle = 1.175 ms / 1.294 ms x 100% = 90.8%, duty factor =  $10 \cdot \log(1/\text{Duty cycle}) = 0.42$  dB
- 802.11be (EHT320):** Duty cycle = 0.627 ms / 0.745 ms x 100% = 84.2%, duty factor =  $10 \cdot \log(1/\text{Duty cycle}) = 0.75$  dB

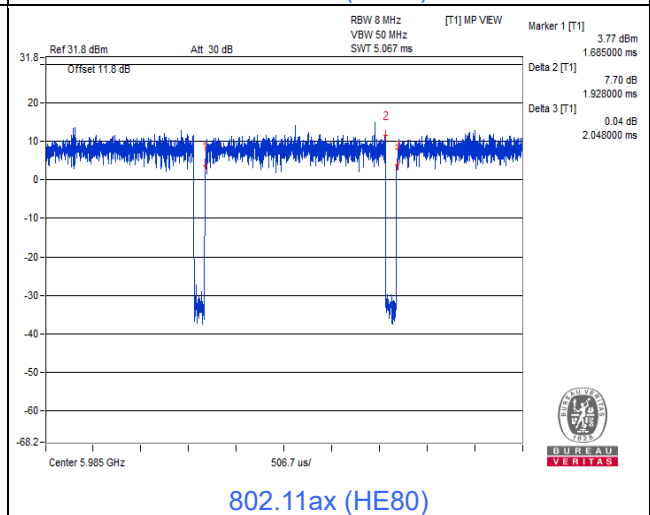
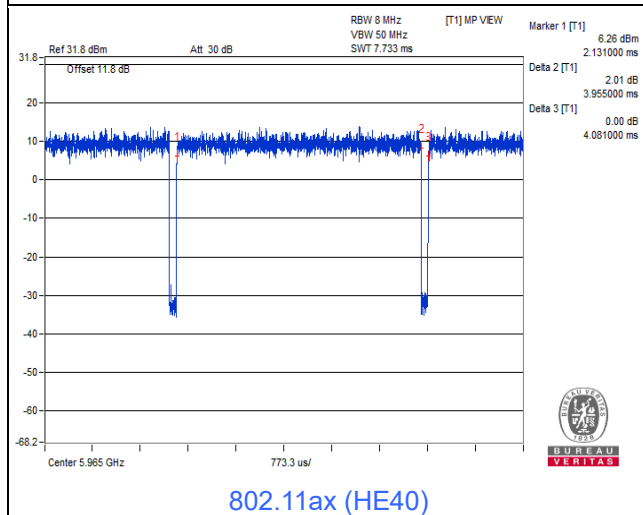
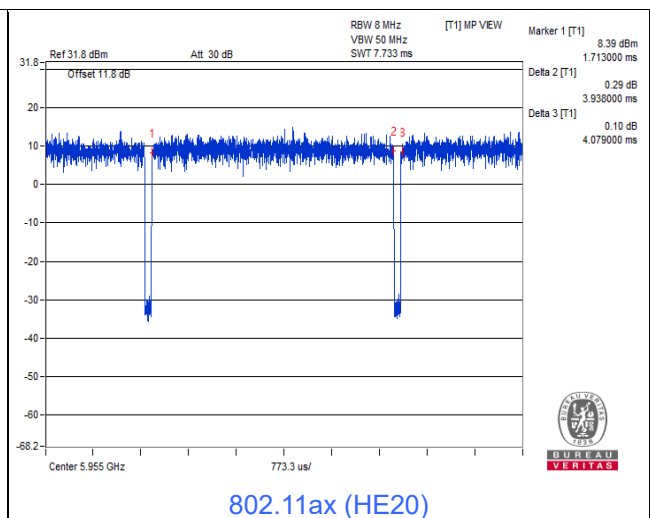
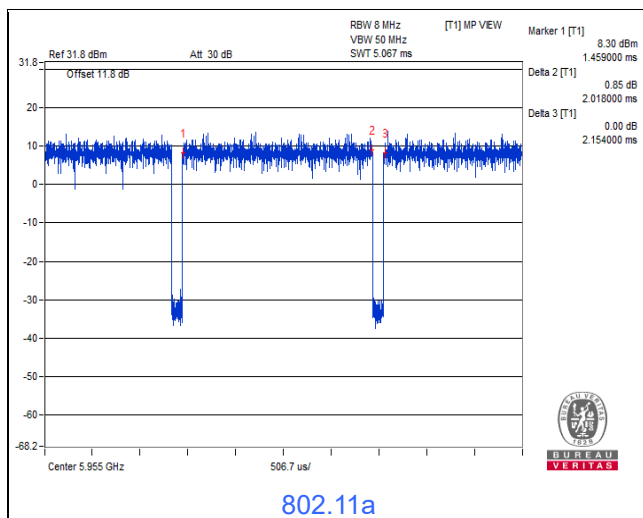

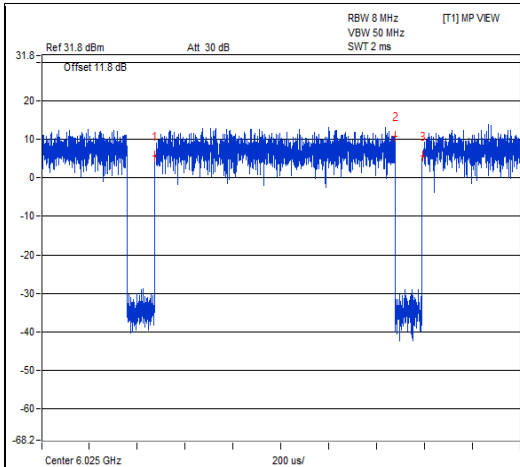

802.11ax (HE160)

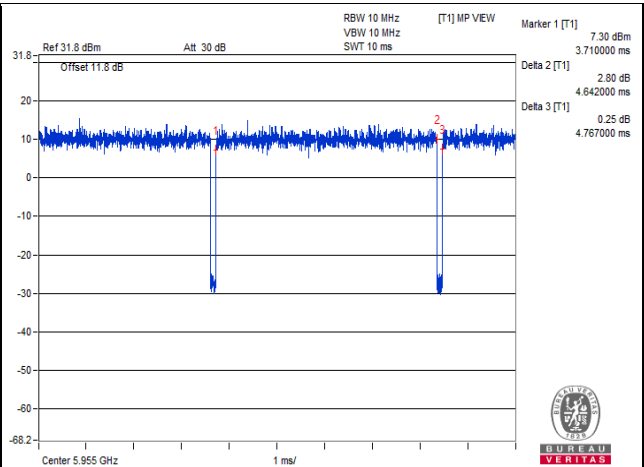

802.11be (EHT20)

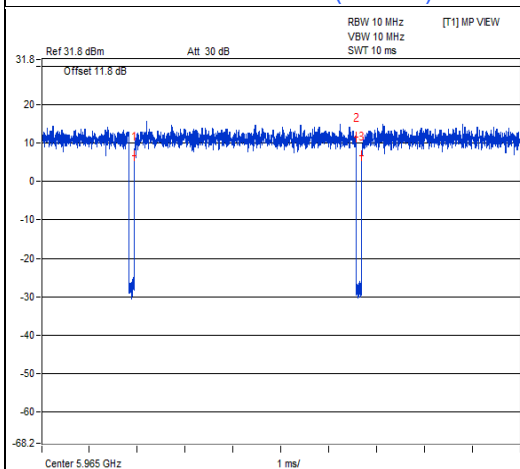

802.11be (EHT40)

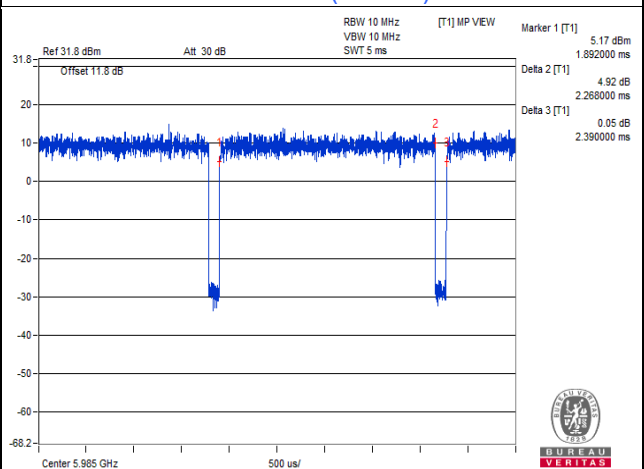

802.11be (EHT80)

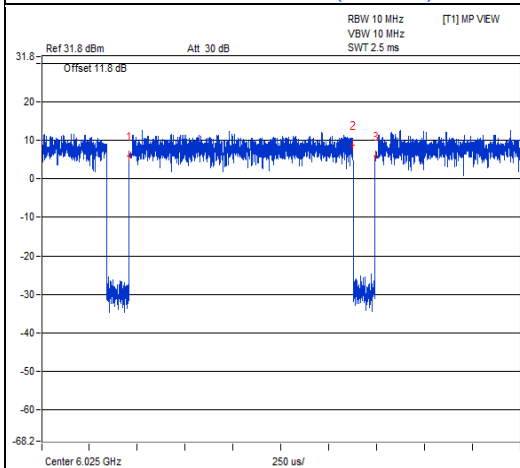

802.11be (EHT160)

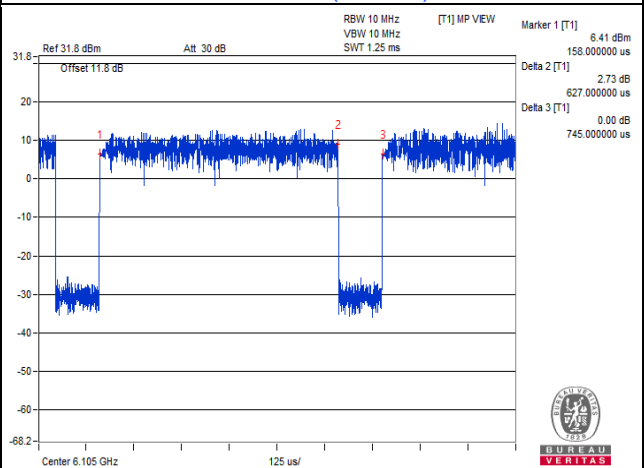

802.11be (EHT320)

### 3.4 Description of Support Units

The EUT has been tested as an independent unit together with other necessary accessories or support units. The following support units or accessories were used to form a representative test configuration during the tests.

ID	Product	Brand	Model No.	Serial No.	FCC ID	Remarks
A.	Laptop	DELL	E5430	HYV4VY1	DoC	Provided by Lab
B.	Adapter	DELL	LLA65NS2-01	NA	NA	Provided by Lab
C.	Test Tool	Mediatek	MTK1849	NA	NA	Supplied by applicant
D.	Termination	Marvelous	MVE5185	NA	NA	Provided by Lab
E.	Termination	Marvelous	MVE5185	NA	NA	Provided by Lab

Note:

1. All power cords of the above support units are non-shielded (1.8m).

ID	Descriptions	Qty.	Length (m)	Shielding (Yes/No)	Cores (Qty.)	Remarks
1.	DC Cable	1	1.8	No	1	Provided by Lab
2.	AC Cable	1	1	No	0	Provided by Lab
3.	RF Cable	1	0.2	No	0	Provided by Lab
4.	RF Cable	1	0.2	No	0	Provided by Lab

Note: The core(s) is(are) originally attached to the cable(s).

### 3.4.1 Configuration of System under Test

For AC Power Conducted Emission test

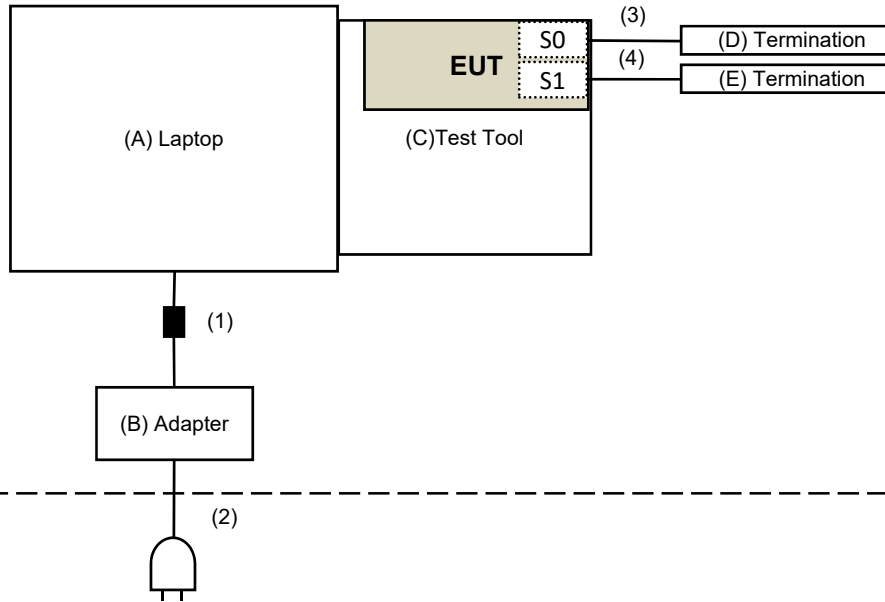

For Radiated Emission test

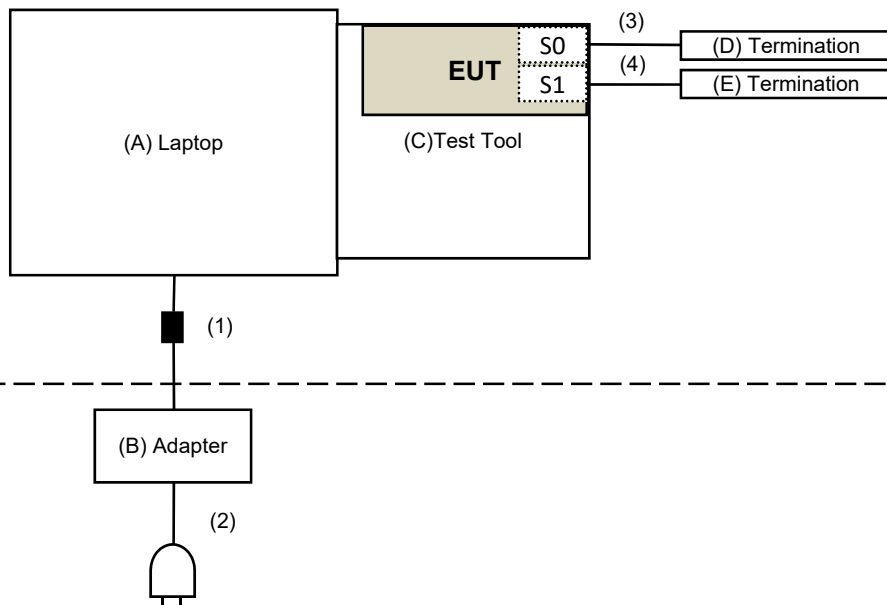

### 3.5 General Description of Applied Standard

The EUT is a RF Product. According to the specifications of the manufacturer, it must comply with the requirements of the following standards and references:

**Test Standard:**

**FCC Part 15, Subpart E (15.407)**

All test items have been performed and recorded as per the above standards.

**References Test Guidance:**

**ANSI C63.10-2013**

**KDB 987594 D02 EMC Measurement v01r01**

**KDB 789033 D02 General UNII Test Procedure New Rules v02r01**

**KDB 662911 D01 Multiple Transmitter Output v02r01**

All test items have been performed as a reference to the above KDB test guidance.



## 4 Test Types and Results

### 4.1 Radiated Emission and Bandedge Measurement

#### 4.1.1 Limits of Radiated Emission and Bandedge Measurement

Radiated emissions which fall in the restricted bands must comply with the radiated emission limits specified as below table.

Frequencies (MHz)	Field Strength (microvolts/meter)	Measurement Distance (meters)
0.009 ~ 0.490	2400/F(kHz)	300
0.490 ~ 1.705	24000/F(kHz)	30
1.705 ~ 30.0	30	30
30 ~ 88	100	3
88 ~ 216	150	3
216 ~ 960	200	3
Above 960	500	3

**NOTE:**

1. The lower limit shall apply at the transition frequencies.
2. Emission level (dBuV/m) = 20 log Emission level (uV/m).
3. For frequencies above 1000MHz, the field strength limits are based on average detector, however, the peak field strength of any emission shall not exceed the maximum permitted average limits, specified above by more than 20dB under any condition of modulation.

Limits of unwanted emission out of the restricted bands

Frequencies (MHz)	EIRP Limit	Equivalent Field Strength at 3m
5925MHz > F > 7125MHz	Peak:-7 (dBm/MHz)	88.2(dBμV/m)
	Average: -27 (dBm/MHz)	68.2(dBμV/m)

**Note:**

The following formula is used to convert the equipment isotropic radiated power (eirp) to field strength:

$$E = \frac{1000000\sqrt{30P}}{3} \mu\text{V/m, where P is the eirp (Watts).}$$

## 4.1.2 Test Instruments

**For Radiated Emission & BandEdge test:**

Description & Manufacturer	Model No.	Serial No.	Calibrated Date	Calibrated Until
Test Receiver Agilent	N9038A	MY51210202	2021/11/19	2022/11/18
Software	ADT_Radiated_V8.7.08	NA	NA	NA
Boresight Antenna Tower & Turn Table Max-Full	MF-7802BS	MF780208530	NA	NA
Pre_Amplifier Agilent	8447D	2944A10636	2022/3/19	2023/3/18
LOOP ANTENNA Electro-Metrics	EM-6879	264	2022/3/18	2023/3/17
RF Coaxial Cable JYEBO	5D-FB	LOOPCAB-001	2022/1/6	2023/1/5
RF Coaxial Cable JYEBO	5D-FB	LOOPCAB-002	2022/1/6	2023/1/5
Pre_Amplifier EMCI	EMC330N	980701	2022/3/8	2023/3/7
Trilog Broadband Antenna Schwarzbeck	VULB 9168	9168-406	2021/10/27	2022/10/26
RF Coaxial Cable COMMATE/PEWC	8D	966-4-1	2022/3/8	2023/3/7
RF Coaxial Cable COMMATE/PEWC	8D	966-4-2	2022/3/8	2023/3/7
RF Coaxial Cable COMMATE/PEWC	8D	966-4-3	2022/3/8	2023/3/7
Fixed attenuator Mini-Circuits	UNAT-5+	PAD-ATT5-03	2022/1/10	2023/1/9
Test Receiver Agilent	N9038A	MY51210202	2021/11/19	2022/11/18
Software	ADT_Radiated_V8.7.08	NA	NA	NA
Boresight Antenna Tower & Turn Table Max-Full	MF-7802BS	MF780208530	NA	NA
Horn Antenna Schwarzbeck	BBHA 9120D	9120D-783	2021/11/14	2022/11/13
Pre_Amplifier EMCI	EMC 12630 SE	980638	2022/4/5	2023/4/4
RF Cable-Frequency Range : 1-26.5GHz EMCI	EMC104-SM-SM-1200	160922	2021/12/24	2022/12/23
RF Coaxial Cable EMCI	EMC104-SM-SM-2000	180502	2022/4/25	2023/4/24
RF Coaxial Cable EMCI	EMC104-SM-SM-6000	210704	2021/11/9	2022/11/8
Test Receiver Agilent	N9038A	MY51210202	2021/11/19	2022/11/18
Software	ADT_Radiated_V8.7.08	NA	NA	NA
Boresight Antenna Tower & Turn Table Max-Full	MF-7802BS	MF780208530	NA	NA
Pre_Amplifier EMCI	EMC184045SE	980387	2022/1/10	2023/1/9
Horn Antenna Schwarzbeck	BBHA 9170	9170-739	2021/11/14	2022/11/13

RF Cable-Frequency range: 1-40GHz EMCI	EMC102-KM-KM-1200	160924	2022/1/10	2023/1/9
RF Coaxial Cable EMCI	EMC-KM-KM-4000	200214	2022/3/8	2023/3/7

**Note:**

1. The calibration interval of the above test instruments is 12 months and the calibrations are traceable to NML/ROC and NIST/USA.
2. The test was performed in 966 Chamber No. 4.
3. Tested Date: 2022/7/8 ~ 2022/8/15

**For other test items:**

Description & Manufacturer	Model No.	Serial No.	Calibrated Date	Calibrated Until
Power Meter Anritsu	ML2495A	1529002	2022/6/22	2023/6/21
Pulse Power Sensor Anritsu	MA2411B	1726434	2022/6/22	2023/6/21
Spectrum Analyzer R&S	FSV40	101516	2022/3/7	2023/3/6
Spectrum Analyzer Keysight	N9020B	MY60112409	2022/3/11	2023/3/10
Attenuator WOKEN	MDCS18N-10	MDCS18N-10-01	2022/4/5	2023/4/4
Software	ADT_RF Test Software V6.6.5.4	NA	NA	NA
Temperature & Humidity Chamber Giant Force	GTH-150-40-SP- AR	MAA0812-008	2022/1/14	2023/1/13
DC POWER SUPPLY Topward	6603D	795558	NA	NA
True RMS Clamp Meter Fluke	325	31130711WS	2022/6/9	2023/6/8
Combiner Mini-Circuits	ZFRSC-123-S+	F698501347_02	2021/12/22 2022/12/15	2022/12/21 2023/12/14

- NOTE:**
1. The test was performed in Oven room 2.
  2. The calibration interval of the above test instruments is 12 months and the calibrations are traceable to NML/ROC and NIST/USA.
  3. Tested Date: 2022/7/28 ~ 2022/12/27

#### 4.1.3 Test Procedure

Following FCC KDB 789033 D02 General UNII Test Procedures:  
Radiated versus Conducted Measurements.

The unwanted emission limits in both the restricted and non-restricted bands are based on antenna-port conducted measurements in conjunction with cabinet emissions tests are permitted to demonstrate compliance.

The following steps was performed:

- a. Cabinet emissions measurements. Radiated measurement was performed to ensure that cabinet emissions are below the emission limits. For the cabinet-emission measurements the antenna was replaced by a termination matching the nominal impedance of the antenna.
- b. Conducted tests was performed using equipment that matches the nominal impedance of the antenna assembly used with the EUT.
- c. EIRP calculation. A value representative of an upper bound on out-of-band antenna gain (in dBi) shall be added to the measured antenna-port conducted emission power to compute EIRP within the specified measurement bandwidth. (For emissions in the restricted bands, additional calculations are required to convert EIRP to field strength at the specified distance.) The upper bound on antenna gain for a device with a single RF output shall be selected as the maximum in-band gain of the antenna across all operating bands or 2 dBi, whichever is greater.
- d. EIRP adjustments for multiple outputs. (Follow the procedures specified in FCC KDB Publication 662911)
- e. For all of Radiation emission test

##### **For Radiated emission below 30MHz**

- e-1.1. The EUT was placed on the top of a rotating table 0.8 meters above the ground at a 3 meter chamber room. The table was rotated 360 degrees to determine the position of the highest radiation.
- e-1.2. The EUT was set 3 meters away from the interference-receiving antenna, which was mounted on the top of a variable-height antenna tower.
- e-1.3. Parallel, perpendicular, and ground-parallel orientations of the antenna are set to make the measurement.
- e-1.4. For each suspected emission, the EUT was arranged to its worst case and the rotatable table was turned from 0 degrees to 360 degrees to find the maximum reading.
- e-1.5. The test-receiver system was set to Quasi-Peak Detect Function and Specified Bandwidth with Maximum Hold Mode.

##### **Note:**

1. The resolution bandwidth and video bandwidth of test receiver/spectrum analyzer is 9kHz at frequency below 30MHz.
2. KDB 414788 OATS and Chamber Correlation Justification
  - Based on FCC 15.31(f)(2) : measurements may be performed at a distance closer than that specified in the regulations; however, an attempts should be made to avoid making measurements in the near field.
  - OATs and chamber correlation testing had been performed and chamber measured test result is the worst case test result.

### For Radiated emission above 30MHz

- e-2.1. The EUT was placed on the top of a rotating table 0.8 meters (for 30MHz ~ 1GHz) / 1.5 meters (for above 1GHz) above the ground at 3 meter chamber room for test. The table was rotated 360 degrees to determine the position of the highest radiation.
- e-2.2. The EUT was set 3 meters away from the interference-receiving antenna, which was mounted on the top of a variable-height antenna tower.
- e-2.3. The height of antenna is varied from one meter to four meters above the ground to determine the maximum value of the field strength. Both horizontal and vertical polarizations of the antenna are set to make the measurement.
- e-2.4. For each suspected emission, the EUT was arranged to its worst case and then the antenna was tuned to heights from 1 meter to 4 meters and the rotatable table was turned from 0 degrees to 360 degrees to find the maximum reading.
- e-2.5. The test-receiver system was set to quasi-peak detect function and specified bandwidth with maximum hold mode when the test frequency is below 1 GHz.
- e-2.6. The test-receiver system was set to peak and average detects function and specified bandwidth with maximum hold mode when the test frequency is above 1 GHz. If the peak reading value also meets average limit, measurement with the average detector is unnecessary.

#### Note:

1. The resolution bandwidth and video bandwidth of test receiver/spectrum analyzer is 120kHz for Quasi-peak detection (QP) at frequency below 1GHz.
2. The resolution bandwidth of test receiver/spectrum analyzer is 1 MHz and the video bandwidth is 3 MHz for Peak detection (PK) at frequency above 1GHz.
3. The resolution bandwidth of test receiver/spectrum analyzer is 1MHz and the video bandwidth is  $\geq 1/T$  (Duty cycle < 98%) or 10Hz (Duty cycle  $\geq$  98%) for Average detection (AV) at frequency above 1GHz.
4. All modes of operation were investigated and the worst-case emissions are reported.

#### 4.1.4 Test Setup

For radiated configuration:

For Radiated emission below 30MHz

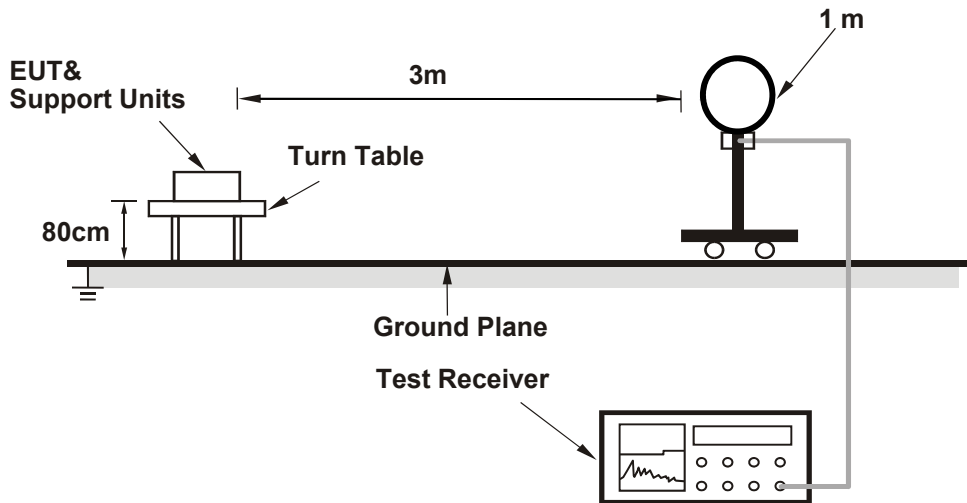

For Radiated emission 30MHz to 1GHz

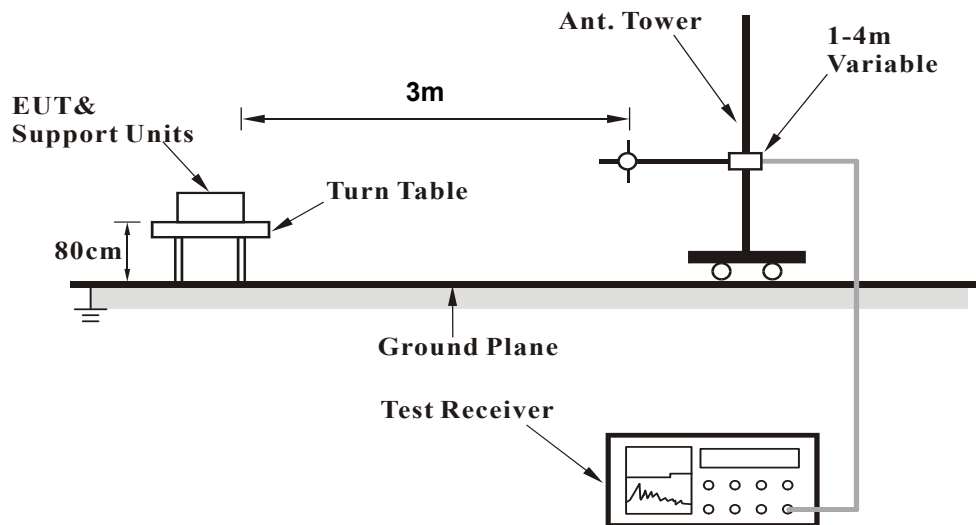

### For Radiated emission above 1GHz

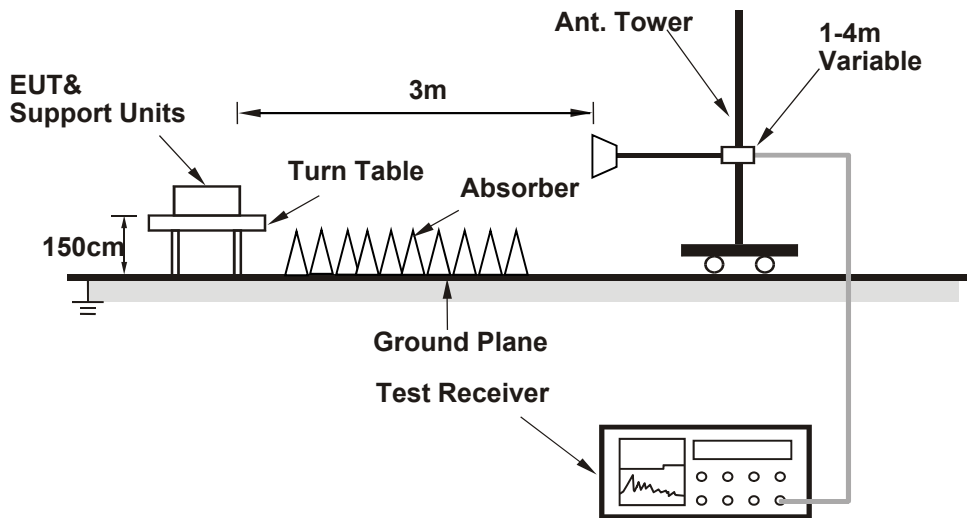

### For conducted configuration:

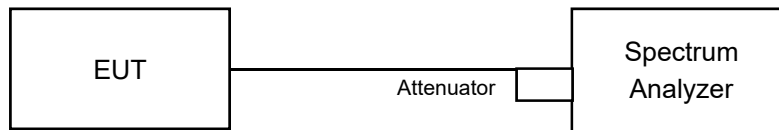

For the actual test configuration, please refer to the attached file (Test Setup Photo).

#### 4.1.5 EUT Operating Condition

- a. Connected the EUT with the Laptop which is placed on the testing table.
- b. Controlling software (QATool\_Dbg.exe (V19)) has been activated to set the EUT under transmission condition continuously.



#### 4.1.6 Test Results (Radiated with 50 ohm load)

Radiated versus Conducted Measurement	
<input type="checkbox"/> Conducted measurement	<input checked="" type="checkbox"/> Radiated measurement
<p><u>For Radiated measurement:</u> The level of unwanted emissions was measured when radiated by the cabinet or structure of the equipment with the antenna connector(s) terminated by a specified load (cabinet radiation)</p> <p><u>For Conducted measurement:</u> The level of unwanted emissions was measured as their power in a specified load (conducted spurious emissions).</p>	

## 4.1.6.1 Test Results (Mode 1)

## Above 1GHz Data:

<b>RF Mode</b>	TX 802.11a 6G	<b>Channel</b>	CH 1 : 5955 MHz
<b>Frequency Range</b>	1 GHz ~ 40 GHz	<b>Detector Function &amp; Bandwidth</b>	(PK) RB = 1 MHz, VB = 3 MHz (AV) RB = 1 MHz, VB = 510 Hz
<b>Input Power (System)</b>	120Vac, 60Hz	<b>Environmental Conditions</b>	25°C, 68% RH
<b>Tested By</b>	Tom Yang		

**Antenna Polarity & Test Distance : Horizontal at 3 m**

No	Frequency (MHz)	Emission Level (dBuV/m)	Limit (dBuV/m)	Margin (dB)	Antenna Height (m)	Table Angle (Degree)	Raw Value (dBuV)	Correction Factor (dB/m)
1	11910.00	42.1 PK	74.0	-31.9	2.31 H	345	31.2	10.9
2	11910.00	29.7 AV	54.0	-24.3	2.31 H	345	18.8	10.9
3	17865.00	42.6 PK	74.0	-31.4	1.69 H	131	21.0	21.6
4	17865.00	32.2 AV	54.0	-21.8	1.69 H	131	10.6	21.6
5	23820.00	44.5 PK	74.0	-29.5	2.58 H	194	46.9	-2.4
6	23820.00	34.3 AV	54.0	-19.7	2.58 H	194	36.7	-2.4

**Antenna Polarity & Test Distance : Vertical at 3 m**

No	Frequency (MHz)	Emission Level (dBuV/m)	Limit (dBuV/m)	Margin (dB)	Antenna Height (m)	Table Angle (Degree)	Raw Value (dBuV)	Correction Factor (dB/m)
1	11910.00	44.1 PK	74.0	-29.9	1.38 V	183	33.2	10.9
2	11910.00	31.4 AV	54.0	-22.6	1.38 V	183	20.5	10.9
3	17865.00	42.0 PK	74.0	-32.0	1.75 V	244	20.4	21.6
4	17865.00	30.6 AV	54.0	-23.4	1.75 V	244	9.0	21.6
5	23820.00	43.3 PK	74.0	-30.7	2.12 V	306	45.7	-2.4
6	23820.00	33.2 AV	54.0	-20.8	2.12 V	306	35.6	-2.4

**Remarks:**

1. Emission Level(dBuV/m) = Raw Value(dBuV) + Correction Factor(dB/m)
2. Correction Factor(dB/m) = Antenna Factor(dB/m) + Cable Factor(dB) – Pre-Amplifier Factor(dB)
3. Margin value = Emission Level – Limit value
4. The other emission levels were very low against the limit.

<b>RF Mode</b>	TX 802.11a 6G	<b>Channel</b>	CH 45 : 6175 MHz
<b>Frequency Range</b>	1 GHz ~ 40 GHz	<b>Detector Function &amp; Bandwidth</b>	(PK) RB = 1 MHz, VB = 3 MHz (AV) RB = 1 MHz, VB = 510 Hz
<b>Input Power (System)</b>	120Vac, 60Hz	<b>Environmental Conditions</b>	25°C, 68% RH
<b>Tested By</b>	Tom Yang		

**Antenna Polarity & Test Distance : Horizontal at 3 m**

No	Frequency (MHz)	Emission Level (dBuV/m)	Limit (dBuV/m)	Margin (dB)	Antenna Height (m)	Table Angle (Degree)	Raw Value (dBuV)	Correction Factor (dB/m)
1	12350.00	42.9 PK	74.0	-31.1	2.36 H	332	32.9	10.0
2	12350.00	30.8 AV	54.0	-23.2	2.36 H	332	20.8	10.0
3	18525.00	43.7 PK	74.0	-30.3	1.71 H	132	50.8	-7.1
4	18525.00	32.9 AV	54.0	-21.1	1.71 H	132	40.0	-7.1
5	#24700.00	44.6 PK	88.2	-43.6	2.67 H	209	46.2	-1.6
6	#24700.00	34.6 AV	68.2	-33.6	2.67 H	209	36.2	-1.6

**Antenna Polarity & Test Distance : Vertical at 3 m**

No	Frequency (MHz)	Emission Level (dBuV/m)	Limit (dBuV/m)	Margin (dB)	Antenna Height (m)	Table Angle (Degree)	Raw Value (dBuV)	Correction Factor (dB/m)
1	12350.00	43.7 PK	74.0	-30.3	1.33 V	183	33.7	10.0
2	12350.00	30.8 AV	54.0	-23.2	1.33 V	183	20.8	10.0
3	18525.00	43.2 PK	74.0	-30.8	1.73 V	258	50.3	-7.1
4	18525.00	31.3 AV	54.0	-22.7	1.73 V	258	38.4	-7.1
5	#24700.00	42.8 PK	88.2	-45.4	2.17 V	289	44.4	-1.6
6	#24700.00	32.9 AV	68.2	-35.3	2.17 V	289	34.5	-1.6

**Remarks:**

1. Emission Level(dBuV/m) = Raw Value(dBuV) + Correction Factor(dB/m)
2. Correction Factor(dB/m) = Antenna Factor(dB/m) + Cable Factor(dB) – Pre-Amplifier Factor(dB)
3. Margin value = Emission Level – Limit value
4. The other emission levels were very low against the limit.
5. "#": The radiated frequency is out of the restricted band.

<b>RF Mode</b>	TX 802.11a 6G	<b>Channel</b>	CH 93 : 6415 MHz
<b>Frequency Range</b>	1 GHz ~ 40 GHz	<b>Detector Function &amp; Bandwidth</b>	(PK) RB = 1 MHz, VB = 3 MHz (AV) RB = 1 MHz, VB = 510 Hz
<b>Input Power (System)</b>	120Vac, 60Hz	<b>Environmental Conditions</b>	25°C, 68% RH
<b>Tested By</b>	Tom Yang		

**Antenna Polarity & Test Distance : Horizontal at 3 m**

No	Frequency (MHz)	Emission Level (dBuV/m)	Limit (dBuV/m)	Margin (dB)	Antenna Height (m)	Table Angle (Degree)	Raw Value (dBuV)	Correction Factor (dB/m)
1	#12830.00	43.4 PK	88.2	-44.8	2.34 H	334	32.9	10.5
2	#12830.00	30.9 AV	68.2	-37.3	2.34 H	334	20.4	10.5
3	19245.00	43.4 PK	74.0	-30.6	1.73 H	69	49.9	-6.5
4	19245.00	33.6 AV	54.0	-20.4	1.73 H	69	40.1	-6.5
5	#25660.00	43.2 PK	88.2	-45.0	2.60 H	216	44.4	-1.2
6	#25660.00	33.1 AV	68.2	-35.1	2.60 H	216	34.3	-1.2

**Antenna Polarity & Test Distance : Vertical at 3 m**

No	Frequency (MHz)	Emission Level (dBuV/m)	Limit (dBuV/m)	Margin (dB)	Antenna Height (m)	Table Angle (Degree)	Raw Value (dBuV)	Correction Factor (dB/m)
1	#12830.00	44.0 PK	88.2	-44.2	1.42 V	140	33.5	10.5
2	#12830.00	31.1 AV	68.2	-37.1	1.42 V	140	20.6	10.5
3	19245.00	43.3 PK	74.0	-30.7	1.79 V	272	49.8	-6.5
4	19245.00	31.8 AV	54.0	-22.2	1.79 V	272	38.3	-6.5
5	#25660.00	44.0 PK	88.2	-44.2	2.22 V	305	45.2	-1.2
6	#25660.00	33.7 AV	68.2	-34.5	2.22 V	305	34.9	-1.2

**Remarks:**

1. Emission Level(dBuV/m) = Raw Value(dBuV) + Correction Factor(dB/m)
2. Correction Factor(dB/m) = Antenna Factor(dB/m) + Cable Factor(dB) – Pre-Amplifier Factor(dB)
3. Margin value = Emission Level – Limit value
4. The other emission levels were very low against the limit.
5. " # ": The radiated frequency is out of the restricted band.

<b>RF Mode</b>	TX 802.11a 6G	<b>Channel</b>	CH 97 : 6435 MHz
<b>Frequency Range</b>	1 GHz ~ 40 GHz	<b>Detector Function &amp; Bandwidth</b>	(PK) RB = 1 MHz, VB = 3 MHz (AV) RB = 1 MHz, VB = 510 Hz
<b>Input Power (System)</b>	120Vac, 60Hz	<b>Environmental Conditions</b>	25°C, 68% RH
<b>Tested By</b>	Tom Yang		

**Antenna Polarity & Test Distance : Horizontal at 3 m**

No	Frequency (MHz)	Emission Level (dBuV/m)	Limit (dBuV/m)	Margin (dB)	Antenna Height (m)	Table Angle (Degree)	Raw Value (dBuV)	Correction Factor (dB/m)
1	#12870.00	41.9 PK	88.2	-46.3	2.27 H	345	31.4	10.5
2	#12870.00	29.5 AV	68.2	-38.7	2.27 H	345	19.0	10.5
3	19305.00	43.2 PK	74.0	-30.8	1.69 H	120	50.0	-6.8
4	19305.00	32.6 AV	54.0	-21.4	1.69 H	120	39.4	-6.8
5	#25740.00	44.7 PK	88.2	-43.5	2.59 H	204	45.9	-1.2
6	#25740.00	34.6 AV	68.2	-33.6	2.59 H	204	35.8	-1.2

**Antenna Polarity & Test Distance : Vertical at 3 m**

No	Frequency (MHz)	Emission Level (dBuV/m)	Limit (dBuV/m)	Margin (dB)	Antenna Height (m)	Table Angle (Degree)	Raw Value (dBuV)	Correction Factor (dB/m)
1	#12870.00	44.0 PK	88.2	-44.2	1.21 V	146	33.5	10.5
2	#12870.00	31.1 AV	68.2	-37.1	1.21 V	146	20.6	10.5
3	19305.00	43.2 PK	74.0	-30.8	1.68 V	250	50.0	-6.8
4	19305.00	31.6 AV	54.0	-22.4	1.68 V	250	38.4	-6.8
5	#25740.00	44.1 PK	88.2	-44.1	2.11 V	314	45.3	-1.2
6	#25740.00	33.3 AV	68.2	-34.9	2.11 V	314	34.5	-1.2

**Remarks:**

1. Emission Level(dBuV/m) = Raw Value(dBuV) + Correction Factor(dB/m)
2. Correction Factor(dB/m) = Antenna Factor(dB/m) + Cable Factor(dB) – Pre-Amplifier Factor(dB)
3. Margin value = Emission Level – Limit value
4. The other emission levels were very low against the limit.
5. " # ": The radiated frequency is out of the restricted band.

<b>RF Mode</b>	TX 802.11a 6G	<b>Channel</b>	CH 105 : 6475 MHz
<b>Frequency Range</b>	1 GHz ~ 40 GHz	<b>Detector Function &amp; Bandwidth</b>	(PK) RB = 1 MHz, VB = 3 MHz (AV) RB = 1 MHz, VB = 510 Hz
<b>Input Power (System)</b>	120Vac, 60Hz	<b>Environmental Conditions</b>	25°C, 68% RH
<b>Tested By</b>	Tom Yang		

**Antenna Polarity & Test Distance : Horizontal at 3 m**

No	Frequency (MHz)	Emission Level (dBuV/m)	Limit (dBuV/m)	Margin (dB)	Antenna Height (m)	Table Angle (Degree)	Raw Value (dBuV)	Correction Factor (dB/m)
1	#12950.00	43.0 PK	88.2	-45.2	2.29 H	349	32.5	10.5
2	#12950.00	30.5 AV	68.2	-37.7	2.29 H	349	20.0	10.5
3	19425.00	43.8 PK	74.0	-30.2	1.57 H	122	50.3	-6.5
4	19425.00	32.7 AV	54.0	-21.3	1.57 H	122	39.2	-6.5
5	#25900.00	43.9 PK	88.2	-44.3	2.60 H	217	45.0	-1.1
6	#25900.00	33.2 AV	68.2	-35.0	2.60 H	217	34.3	-1.1

**Antenna Polarity & Test Distance : Vertical at 3 m**

No	Frequency (MHz)	Emission Level (dBuV/m)	Limit (dBuV/m)	Margin (dB)	Antenna Height (m)	Table Angle (Degree)	Raw Value (dBuV)	Correction Factor (dB/m)
1	#12950.00	42.5 PK	88.2	-45.7	1.30 V	127	32.0	10.5
2	#12950.00	29.3 AV	68.2	-38.9	1.30 V	127	18.8	10.5
3	19425.00	43.2 PK	74.0	-30.8	1.75 V	272	49.7	-6.5
4	19425.00	31.7 AV	54.0	-22.3	1.75 V	272	38.2	-6.5
5	#25900.00	44.7 PK	88.2	-43.5	2.09 V	305	45.8	-1.1
6	#25900.00	33.3 AV	68.2	-34.9	2.09 V	305	34.4	-1.1

**Remarks:**

1. Emission Level(dBuV/m) = Raw Value(dBuV) + Correction Factor(dB/m)
2. Correction Factor(dB/m) = Antenna Factor(dB/m) + Cable Factor(dB) – Pre-Amplifier Factor(dB)
3. Margin value = Emission Level – Limit value
4. The other emission levels were very low against the limit.
5. "#": The radiated frequency is out of the restricted band.

<b>RF Mode</b>	TX 802.11a 6G	<b>Channel</b>	CH 113 : 6515 MHz
<b>Frequency Range</b>	1 GHz ~ 40 GHz	<b>Detector Function &amp; Bandwidth</b>	(PK) RB = 1 MHz, VB = 3 MHz (AV) RB = 1 MHz, VB = 510 Hz
<b>Input Power (System)</b>	120Vac, 60Hz	<b>Environmental Conditions</b>	25°C, 68% RH
<b>Tested By</b>	Tom Yang		

**Antenna Polarity & Test Distance : Horizontal at 3 m**

No	Frequency (MHz)	Emission Level (dBuV/m)	Limit (dBuV/m)	Margin (dB)	Antenna Height (m)	Table Angle (Degree)	Raw Value (dBuV)	Correction Factor (dB/m)
1	#13030.00	42.1 PK	88.2	-46.1	2.39 H	330	31.5	10.6
2	#13030.00	30.1 AV	68.2	-38.1	2.39 H	330	19.5	10.6
3	19545.00	43.9 PK	74.0	-30.1	1.56 H	107	50.1	-6.2
4	19545.00	33.2 AV	54.0	-20.8	1.56 H	107	39.4	-6.2
5	#26060.00	43.5 PK	88.2	-44.7	2.71 H	206	44.5	-1.0
6	#26060.00	33.8 AV	68.2	-34.4	2.71 H	206	34.8	-1.0

**Antenna Polarity & Test Distance : Vertical at 3 m**

No	Frequency (MHz)	Emission Level (dBuV/m)	Limit (dBuV/m)	Margin (dB)	Antenna Height (m)	Table Angle (Degree)	Raw Value (dBuV)	Correction Factor (dB/m)
1	#13030.00	43.0 PK	88.2	-45.2	1.06 V	151	32.4	10.6
2	#13030.00	30.0 AV	68.2	-38.2	1.06 V	151	19.4	10.6
3	19545.00	43.4 PK	74.0	-30.6	1.91 V	262	49.6	-6.2
4	19545.00	32.4 AV	54.0	-21.6	1.91 V	262	38.6	-6.2
5	#26060.00	42.2 PK	88.2	-46.0	2.18 V	313	43.2	-1.0
6	#26060.00	32.7 AV	68.2	-35.5	2.18 V	313	33.7	-1.0

**Remarks:**

1. Emission Level(dBuV/m) = Raw Value(dBuV) + Correction Factor(dB/m)
2. Correction Factor(dB/m) = Antenna Factor(dB/m) + Cable Factor(dB) – Pre-Amplifier Factor(dB)
3. Margin value = Emission Level – Limit value
4. The other emission levels were very low against the limit.
5. "#": The radiated frequency is out of the restricted band.

<b>RF Mode</b>	TX 802.11a 6G	<b>Channel</b>	CH 117 : 6535 MHz
<b>Frequency Range</b>	1 GHz ~ 40 GHz	<b>Detector Function &amp; Bandwidth</b>	(PK) RB = 1 MHz, VB = 3 MHz (AV) RB = 1 MHz, VB = 510 Hz
<b>Input Power (System)</b>	120Vac, 60Hz	<b>Environmental Conditions</b>	25°C, 68% RH
<b>Tested By</b>	Tom Yang		

**Antenna Polarity & Test Distance : Horizontal at 3 m**

No	Frequency (MHz)	Emission Level (dBuV/m)	Limit (dBuV/m)	Margin (dB)	Antenna Height (m)	Table Angle (Degree)	Raw Value (dBuV)	Correction Factor (dB/m)
1	#13070.00	43.2 PK	88.2	-45.0	2.28 H	340	32.4	10.8
2	#13070.00	30.5 AV	68.2	-37.7	2.28 H	340	19.7	10.8
3	19605.00	42.2 PK	74.0	-31.8	1.76 H	91	48.2	-6.0
4	19605.00	32.6 AV	54.0	-21.4	1.76 H	91	38.6	-6.0
5	#26140.00	43.7 PK	88.2	-44.5	2.64 H	207	44.6	-0.9
6	#26140.00	33.4 AV	68.2	-34.8	2.64 H	207	34.3	-0.9

**Antenna Polarity & Test Distance : Vertical at 3 m**

No	Frequency (MHz)	Emission Level (dBuV/m)	Limit (dBuV/m)	Margin (dB)	Antenna Height (m)	Table Angle (Degree)	Raw Value (dBuV)	Correction Factor (dB/m)
1	#13070.00	42.3 PK	88.2	-45.9	1.09 V	178	31.5	10.8
2	#13070.00	29.2 AV	68.2	-39.0	1.09 V	178	18.4	10.8
3	19605.00	43.4 PK	74.0	-30.6	1.88 V	237	49.4	-6.0
4	19605.00	32.4 AV	54.0	-21.6	1.88 V	237	38.4	-6.0
5	#26140.00	43.1 PK	88.2	-45.1	2.24 V	306	44.0	-0.9
6	#26140.00	33.3 AV	68.2	-34.9	2.24 V	306	34.2	-0.9

**Remarks:**

1. Emission Level(dBuV/m) = Raw Value(dBuV) + Correction Factor(dB/m)
2. Correction Factor(dB/m) = Antenna Factor(dB/m) + Cable Factor(dB) – Pre-Amplifier Factor(dB)
3. Margin value = Emission Level – Limit value
4. The other emission levels were very low against the limit.
5. "#": The radiated frequency is out of the restricted band.



<b>RF Mode</b>	TX 802.11a 6G	<b>Channel</b>	CH 153 : 6715 MHz
<b>Frequency Range</b>	1 GHz ~ 40 GHz	<b>Detector Function &amp; Bandwidth</b>	(PK) RB = 1 MHz, VB = 3 MHz (AV) RB = 1 MHz, VB = 510 Hz
<b>Input Power (System)</b>	120Vac, 60Hz	<b>Environmental Conditions</b>	25°C, 68% RH
<b>Tested By</b>	Tom Yang		

**Antenna Polarity & Test Distance : Horizontal at 3 m**

No	Frequency (MHz)	Emission Level (dBuV/m)	Limit (dBuV/m)	Margin (dB)	Antenna Height (m)	Table Angle (Degree)	Raw Value (dBuV)	Correction Factor (dB/m)
1	#13430.00	43.3 PK	88.2	-44.9	2.35 H	351	31.1	12.2
2	#13430.00	30.8 AV	68.2	-37.4	2.35 H	351	18.6	12.2
3	20145.00	44.2 PK	74.0	-29.8	1.61 H	130	49.8	-5.6
4	20145.00	33.0 AV	54.0	-21.0	1.61 H	130	38.6	-5.6
5	#26860.00	44.1 PK	88.2	-44.1	2.55 H	214	44.9	-0.8
6	#26860.00	33.6 AV	68.2	-34.6	2.55 H	214	34.4	-0.8

**Antenna Polarity & Test Distance : Vertical at 3 m**

No	Frequency (MHz)	Emission Level (dBuV/m)	Limit (dBuV/m)	Margin (dB)	Antenna Height (m)	Table Angle (Degree)	Raw Value (dBuV)	Correction Factor (dB/m)
1	#13430.00	43.5 PK	88.2	-44.7	1.17 V	144	31.3	12.2
2	#13430.00	30.8 AV	68.2	-37.4	1.17 V	144	18.6	12.2
3	20145.00	43.0 PK	74.0	-31.0	1.68 V	237	48.6	-5.6
4	20145.00	31.6 AV	54.0	-22.4	1.68 V	237	37.2	-5.6
5	#26860.00	43.6 PK	88.2	-44.6	2.07 V	329	44.4	-0.8
6	#26860.00	32.9 AV	68.2	-35.3	2.07 V	329	33.7	-0.8

**Remarks:**

1. Emission Level(dBuV/m) = Raw Value(dBuV) + Correction Factor(dB/m)
2. Correction Factor(dB/m) = Antenna Factor(dB/m) + Cable Factor(dB) – Pre-Amplifier Factor(dB)
3. Margin value = Emission Level – Limit value
4. The other emission levels were very low against the limit.
5. "#": The radiated frequency is out of the restricted band.

<b>RF Mode</b>	TX 802.11a 6G	<b>Channel</b>	CH 181 : 6855 MHz
<b>Frequency Range</b>	1 GHz ~ 40 GHz	<b>Detector Function &amp; Bandwidth</b>	(PK) RB = 1 MHz, VB = 3 MHz (AV) RB = 1 MHz, VB = 510 Hz
<b>Input Power (System)</b>	120Vac, 60Hz	<b>Environmental Conditions</b>	25°C, 68% RH
<b>Tested By</b>	Tom Yang		

**Antenna Polarity & Test Distance : Horizontal at 3 m**

No	Frequency (MHz)	Emission Level (dBuV/m)	Limit (dBuV/m)	Margin (dB)	Antenna Height (m)	Table Angle (Degree)	Raw Value (dBuV)	Correction Factor (dB/m)
1	#13710.00	43.4 PK	88.2	-44.8	2.32 H	339	30.6	12.8
2	#13710.00	31.2 AV	68.2	-37.0	2.32 H	339	18.4	12.8
3	20565.00	44.8 PK	74.0	-29.2	1.62 H	120	49.5	-4.7
4	20565.00	33.3 AV	54.0	-20.7	1.62 H	120	38.0	-4.7
5	#27420.00	44.2 PK	88.2	-44.0	2.55 H	211	45.1	-0.9
6	#27420.00	33.5 AV	68.2	-34.7	2.55 H	211	34.4	-0.9

**Antenna Polarity & Test Distance : Vertical at 3 m**

No	Frequency (MHz)	Emission Level (dBuV/m)	Limit (dBuV/m)	Margin (dB)	Antenna Height (m)	Table Angle (Degree)	Raw Value (dBuV)	Correction Factor (dB/m)
1	#13710.00	42.5 PK	88.2	-45.7	1.07 V	166	29.7	12.8
2	#13710.00	29.7 AV	68.2	-38.5	1.07 V	166	16.9	12.8
3	20565.00	43.4 PK	74.0	-30.6	1.92 V	275	48.1	-4.7
4	20565.00	32.2 AV	54.0	-21.8	1.92 V	275	36.9	-4.7
5	#27420.00	42.3 PK	88.2	-45.9	2.22 V	300	43.2	-0.9
6	#27420.00	32.9 AV	68.2	-35.3	2.22 V	300	33.8	-0.9

**Remarks:**

1. Emission Level(dBuV/m) = Raw Value(dBuV) + Correction Factor(dB/m)
2. Correction Factor(dB/m) = Antenna Factor(dB/m) + Cable Factor(dB) – Pre-Amplifier Factor(dB)
3. Margin value = Emission Level – Limit value
4. The other emission levels were very low against the limit.
5. "#": The radiated frequency is out of the restricted band.

<b>RF Mode</b>	TX 802.11a 6G	<b>Channel</b>	CH 185 : 6875 MHz
<b>Frequency Range</b>	1 GHz ~ 40 GHz	<b>Detector Function &amp; Bandwidth</b>	(PK) RB = 1 MHz, VB = 3 MHz (AV) RB = 1 MHz, VB = 510 Hz
<b>Input Power (System)</b>	120Vac, 60Hz	<b>Environmental Conditions</b>	25°C, 68% RH
<b>Tested By</b>	Tom Yang		

**Antenna Polarity & Test Distance : Horizontal at 3 m**

No	Frequency (MHz)	Emission Level (dBuV/m)	Limit (dBuV/m)	Margin (dB)	Antenna Height (m)	Table Angle (Degree)	Raw Value (dBuV)	Correction Factor (dB/m)
1	#13750.00	42.7 PK	88.2	-45.5	2.30 H	347	29.8	12.9
2	#13750.00	30.0 AV	68.2	-38.2	2.30 H	347	17.1	12.9
3	20625.00	43.6 PK	74.0	-30.4	1.62 H	117	48.4	-4.8
4	20625.00	32.4 AV	54.0	-21.6	1.62 H	117	37.2	-4.8
5	#27500.00	43.5 PK	88.2	-44.7	2.59 H	217	44.4	-0.9
6	#27500.00	32.8 AV	68.2	-35.4	2.59 H	217	33.7	-0.9

**Antenna Polarity & Test Distance : Vertical at 3 m**

No	Frequency (MHz)	Emission Level (dBuV/m)	Limit (dBuV/m)	Margin (dB)	Antenna Height (m)	Table Angle (Degree)	Raw Value (dBuV)	Correction Factor (dB/m)
1	#13750.00	43.1 PK	88.2	-45.1	1.15 V	131	30.2	12.9
2	#13750.00	30.5 AV	68.2	-37.7	1.15 V	131	17.6	12.9
3	20625.00	43.0 PK	74.0	-31.0	1.68 V	244	47.8	-4.8
4	20625.00	31.6 AV	54.0	-22.4	1.68 V	244	36.4	-4.8
5	#27500.00	43.6 PK	88.2	-44.6	2.03 V	332	44.5	-0.9
6	#27500.00	33.2 AV	68.2	-35.0	2.03 V	332	34.1	-0.9

**Remarks:**

1. Emission Level(dBuV/m) = Raw Value(dBuV) + Correction Factor(dB/m)
2. Correction Factor(dB/m) = Antenna Factor(dB/m) + Cable Factor(dB) – Pre-Amplifier Factor(dB)
3. Margin value = Emission Level – Limit value
4. The other emission levels were very low against the limit.
5. "#": The radiated frequency is out of the restricted band.

<b>RF Mode</b>	TX 802.11a 6G	<b>Channel</b>	CH 213 : 7015 MHz
<b>Frequency Range</b>	1 GHz ~ 40 GHz	<b>Detector Function &amp; Bandwidth</b>	(PK) RB = 1 MHz, VB = 3 MHz (AV) RB = 1 MHz, VB = 510 Hz
<b>Input Power (System)</b>	120Vac, 60Hz	<b>Environmental Conditions</b>	25°C, 68% RH
<b>Tested By</b>	Tom Yang		

**Antenna Polarity & Test Distance : Horizontal at 3 m**

No	Frequency (MHz)	Emission Level (dBuV/m)	Limit (dBuV/m)	Margin (dB)	Antenna Height (m)	Table Angle (Degree)	Raw Value (dBuV)	Correction Factor (dB/m)
1	#14030.00	42.5 PK	88.2	-45.7	2.43 H	329	29.4	13.1
2	#14030.00	30.3 AV	68.2	-37.9	2.43 H	329	17.2	13.1
3	21045.00	44.2 PK	74.0	-29.8	1.51 H	119	48.3	-4.1
4	21045.00	33.7 AV	54.0	-20.3	1.51 H	119	37.8	-4.1
5	#28060.00	43.2 PK	88.2	-45.0	2.66 H	205	44.4	-1.2
6	#28060.00	33.4 AV	68.2	-34.8	2.66 H	205	34.6	-1.2

**Antenna Polarity & Test Distance : Vertical at 3 m**

No	Frequency (MHz)	Emission Level (dBuV/m)	Limit (dBuV/m)	Margin (dB)	Antenna Height (m)	Table Angle (Degree)	Raw Value (dBuV)	Correction Factor (dB/m)
1	#14030.00	42.4 PK	88.2	-45.8	1.10 V	174	29.3	13.1
2	#14030.00	29.2 AV	68.2	-39.0	1.10 V	174	16.1	13.1
3	21045.00	43.3 PK	74.0	-30.7	1.88 V	236	47.4	-4.1
4	21045.00	32.3 AV	54.0	-21.7	1.88 V	236	36.4	-4.1
5	#28060.00	43.7 PK	88.2	-44.5	2.29 V	318	44.9	-1.2
6	#28060.00	33.8 AV	68.2	-34.4	2.29 V	318	35.0	-1.2

**Remarks:**

1. Emission Level(dBuV/m) = Raw Value(dBuV) + Correction Factor(dB/m)
2. Correction Factor(dB/m) = Antenna Factor(dB/m) + Cable Factor(dB) – Pre-Amplifier Factor(dB)
3. Margin value = Emission Level – Limit value
4. The other emission levels were very low against the limit.
5. "#": The radiated frequency is out of the restricted band.

<b>RF Mode</b>	TX 802.11a 6G	<b>Channel</b>	CH 233 : 7115 MHz
<b>Frequency Range</b>	1 GHz ~ 40 GHz	<b>Detector Function &amp; Bandwidth</b>	(PK) RB = 1 MHz, VB = 3 MHz (AV) RB = 1 MHz, VB = 510 Hz
<b>Input Power (System)</b>	120Vac, 60Hz	<b>Environmental Conditions</b>	25°C, 68% RH
<b>Tested By</b>	Tom Yang		

**Antenna Polarity & Test Distance : Horizontal at 3 m**

No	Frequency (MHz)	Emission Level (dBuV/m)	Limit (dBuV/m)	Margin (dB)	Antenna Height (m)	Table Angle (Degree)	Raw Value (dBuV)	Correction Factor (dB/m)
1	#14230.00	41.9 PK	88.2	-46.3	2.39 H	331	28.4	13.5
2	#14230.00	30.1 AV	68.2	-38.1	2.39 H	331	16.6	13.5
3	21345.00	44.4 PK	74.0	-29.6	1.51 H	114	48.2	-3.8
4	21345.00	33.6 AV	54.0	-20.4	1.51 H	114	37.4	-3.8
5	#28460.00	42.9 PK	88.2	-45.3	2.76 H	221	44.2	-1.3
6	#28460.00	33.4 AV	68.2	-34.8	2.76 H	221	34.7	-1.3

**Antenna Polarity & Test Distance : Vertical at 3 m**

No	Frequency (MHz)	Emission Level (dBuV/m)	Limit (dBuV/m)	Margin (dB)	Antenna Height (m)	Table Angle (Degree)	Raw Value (dBuV)	Correction Factor (dB/m)
1	#14230.00	42.6 PK	88.2	-45.6	1.06 V	171	29.1	13.5
2	#14230.00	29.8 AV	68.2	-38.4	1.06 V	171	16.3	13.5
3	21345.00	43.4 PK	74.0	-30.6	1.90 V	263	47.2	-3.8
4	21345.00	32.4 AV	54.0	-21.6	1.90 V	263	36.2	-3.8
5	#28460.00	42.5 PK	88.2	-45.7	2.17 V	300	43.8	-1.3
6	#28460.00	33.2 AV	68.2	-35.0	2.17 V	300	34.5	-1.3

**Remarks:**

1. Emission Level(dBuV/m) = Raw Value(dBuV) + Correction Factor(dB/m)
2. Correction Factor(dB/m) = Antenna Factor(dB/m) + Cable Factor(dB) – Pre-Amplifier Factor(dB)
3. Margin value = Emission Level – Limit value
4. The other emission levels were very low against the limit.
5. "#": The radiated frequency is out of the restricted band.

<b>RF Mode</b>	TX 802.11ax (HE20)	<b>Channel</b>	CH 1 : 5955 MHz
<b>Frequency Range</b>	1 GHz ~ 40 GHz	<b>Detector Function &amp; Bandwidth</b>	(PK) RB = 1 MHz, VB = 3 MHz (AV) RB = 1 MHz, VB = 300 Hz
<b>Input Power (System)</b>	120Vac, 60Hz	<b>Environmental Conditions</b>	25°C, 68% RH
<b>Tested By</b>	Tom Yang		

**Antenna Polarity & Test Distance : Horizontal at 3 m**

No	Frequency (MHz)	Emission Level (dBuV/m)	Limit (dBuV/m)	Margin (dB)	Antenna Height (m)	Table Angle (Degree)	Raw Value (dBuV)	Correction Factor (dB/m)
1	11910.00	43.1 PK	74.0	-30.9	2.23 H	353	32.2	10.9
2	11910.00	30.3 AV	54.0	-23.7	2.23 H	353	19.4	10.9
3	17865.00	42.6 PK	74.0	-31.4	1.81 H	93	21.0	21.6
4	17865.00	33.0 AV	54.0	-21.0	1.81 H	93	11.4	21.6
5	23820.00	43.7 PK	74.0	-30.3	2.65 H	195	46.1	-2.4
6	23820.00	33.1 AV	54.0	-20.9	2.65 H	195	35.5	-2.4

**Antenna Polarity & Test Distance : Vertical at 3 m**

No	Frequency (MHz)	Emission Level (dBuV/m)	Limit (dBuV/m)	Margin (dB)	Antenna Height (m)	Table Angle (Degree)	Raw Value (dBuV)	Correction Factor (dB/m)
1	11910.00	42.5 PK	74.0	-31.5	1.18 V	119	31.6	10.9
2	11910.00	30.2 AV	54.0	-23.8	1.18 V	119	19.3	10.9
3	17865.00	43.4 PK	74.0	-30.6	1.66 V	234	21.8	21.6
4	17865.00	32.0 AV	54.0	-22.0	1.66 V	234	10.4	21.6
5	23820.00	43.5 PK	74.0	-30.5	2.05 V	323	45.9	-2.4
6	23820.00	33.2 AV	54.0	-20.8	2.05 V	323	35.6	-2.4

**Remarks:**

1. Emission Level(dBuV/m) = Raw Value(dBuV) + Correction Factor(dB/m)
2. Correction Factor(dB/m) = Antenna Factor(dB/m) + Cable Factor(dB) – Pre-Amplifier Factor(dB)
3. Margin value = Emission Level – Limit value
4. The other emission levels were very low against the limit.

<b>RF Mode</b>	TX 802.11ax (HE20)	<b>Channel</b>	CH 233 : 7115 MHz
<b>Frequency Range</b>	1 GHz ~ 40 GHz	<b>Detector Function &amp; Bandwidth</b>	(PK) RB = 1 MHz, VB = 3 MHz (AV) RB = 1 MHz, VB = 300 Hz
<b>Input Power (System)</b>	120Vac, 60Hz	<b>Environmental Conditions</b>	25°C, 68% RH
<b>Tested By</b>	Tom Yang		

**Antenna Polarity & Test Distance : Horizontal at 3 m**

No	Frequency (MHz)	Emission Level (dBuV/m)	Limit (dBuV/m)	Margin (dB)	Antenna Height (m)	Table Angle (Degree)	Raw Value (dBuV)	Correction Factor (dB/m)
1	#14230.00	43.7 PK	88.2	-44.5	2.30 H	339	30.2	13.5
2	#14230.00	31.6 AV	68.2	-36.6	2.30 H	339	18.1	13.5
3	21345.00	44.6 PK	74.0	-29.4	1.56 H	121	48.4	-3.8
4	21345.00	33.4 AV	54.0	-20.6	1.56 H	121	37.2	-3.8
5	#28460.00	43.6 PK	88.2	-44.6	2.55 H	223	44.9	-1.3
6	#28460.00	33.1 AV	68.2	-35.1	2.55 H	223	34.4	-1.3

**Antenna Polarity & Test Distance : Vertical at 3 m**

No	Frequency (MHz)	Emission Level (dBuV/m)	Limit (dBuV/m)	Margin (dB)	Antenna Height (m)	Table Angle (Degree)	Raw Value (dBuV)	Correction Factor (dB/m)
1	#14230.00	41.7 PK	88.2	-46.5	1.10 V	188	28.2	13.5
2	#14230.00	29.3 AV	68.2	-38.9	1.10 V	188	15.8	13.5
3	21345.00	43.3 PK	74.0	-30.7	1.87 V	245	47.1	-3.8
4	21345.00	32.5 AV	54.0	-21.5	1.87 V	245	36.3	-3.8
5	#28460.00	44.1 PK	88.2	-44.1	2.28 V	338	45.4	-1.3
6	#28460.00	34.2 AV	68.2	-34.0	2.28 V	338	35.5	-1.3

**Remarks:**

1. Emission Level(dBuV/m) = Raw Value(dBuV) + Correction Factor(dB/m)
2. Correction Factor(dB/m) = Antenna Factor(dB/m) + Cable Factor(dB) – Pre-Amplifier Factor(dB)
3. Margin value = Emission Level – Limit value
4. The other emission levels were very low against the limit.
5. "#": The radiated frequency is out of the restricted band.

<b>RF Mode</b>	TX 802.11ax (HE40)	<b>Channel</b>	CH 3 : 5965 MHz
<b>Frequency Range</b>	1 GHz ~ 40 GHz	<b>Detector Function &amp; Bandwidth</b>	(PK) RB = 1 MHz, VB = 3 MHz (AV) RB = 1 MHz, VB = 300 Hz
<b>Input Power (System)</b>	120Vac, 60Hz	<b>Environmental Conditions</b>	25°C, 68% RH
<b>Tested By</b>	Tom Yang		

**Antenna Polarity & Test Distance : Horizontal at 3 m**

No	Frequency (MHz)	Emission Level (dBuV/m)	Limit (dBuV/m)	Margin (dB)	Antenna Height (m)	Table Angle (Degree)	Raw Value (dBuV)	Correction Factor (dB/m)
1	11930.00	43.5 PK	74.0	-30.5	2.34 H	354	32.6	10.9
2	11930.00	31.5 AV	54.0	-22.5	2.34 H	354	20.6	10.9
3	17895.00	44.7 PK	74.0	-29.3	1.68 H	123	22.5	22.2
4	17895.00	33.2 AV	54.0	-20.8	1.68 H	123	11.0	22.2
5	23860.00	44.1 PK	74.0	-29.9	2.55 H	207	46.5	-2.4
6	23860.00	33.6 AV	54.0	-20.4	2.55 H	207	36.0	-2.4

**Antenna Polarity & Test Distance : Vertical at 3 m**

No	Frequency (MHz)	Emission Level (dBuV/m)	Limit (dBuV/m)	Margin (dB)	Antenna Height (m)	Table Angle (Degree)	Raw Value (dBuV)	Correction Factor (dB/m)
1	11930.00	42.0 PK	74.0	-32.0	1.29 V	136	31.1	10.9
2	11930.00	29.5 AV	54.0	-24.5	1.29 V	136	18.6	10.9
3	17895.00	42.7 PK	74.0	-31.3	1.58 V	264	20.5	22.2
4	17895.00	32.1 AV	54.0	-21.9	1.58 V	264	9.9	22.2
5	23860.00	44.1 PK	74.0	-29.9	1.97 V	339	46.5	-2.4
6	23860.00	33.4 AV	54.0	-20.6	1.97 V	339	35.8	-2.4

**Remarks:**

1. Emission Level(dBuV/m) = Raw Value(dBuV) + Correction Factor(dB/m)
2. Correction Factor(dB/m) = Antenna Factor(dB/m) + Cable Factor(dB) – Pre-Amplifier Factor(dB)
3. Margin value = Emission Level – Limit value
4. The other emission levels were very low against the limit.



<b>RF Mode</b>	TX 802.11ax (HE40)	<b>Channel</b>	CH 227 : 7085 MHz
<b>Frequency Range</b>	1 GHz ~ 40 GHz	<b>Detector Function &amp; Bandwidth</b>	(PK) RB = 1 MHz, VB = 3 MHz (AV) RB = 1 MHz, VB = 300 Hz
<b>Input Power (System)</b>	120Vac, 60Hz	<b>Environmental Conditions</b>	25°C, 68% RH
<b>Tested By</b>	Tom Yang		

**Antenna Polarity & Test Distance : Horizontal at 3 m**

No	Frequency (MHz)	Emission Level (dBuV/m)	Limit (dBuV/m)	Margin (dB)	Antenna Height (m)	Table Angle (Degree)	Raw Value (dBuV)	Correction Factor (dB/m)
1	#14170.00	43.3 PK	88.2	-44.9	2.26 H	342	29.8	13.5
2	#14170.00	31.1 AV	68.2	-37.1	2.26 H	342	17.6	13.5
3	21255.00	44.8 PK	74.0	-29.2	1.48 H	135	48.8	-4.0
4	21255.00	33.8 AV	54.0	-20.2	1.48 H	135	37.8	-4.0
5	#28340.00	43.6 PK	88.2	-44.6	2.62 H	207	44.7	-1.1
6	#28340.00	33.1 AV	68.2	-35.1	2.62 H	207	34.2	-1.1

**Antenna Polarity & Test Distance : Vertical at 3 m**

No	Frequency (MHz)	Emission Level (dBuV/m)	Limit (dBuV/m)	Margin (dB)	Antenna Height (m)	Table Angle (Degree)	Raw Value (dBuV)	Correction Factor (dB/m)
1	#14170.00	44.4 PK	88.2	-43.8	1.25 V	172	30.9	13.5
2	#14170.00	31.0 AV	68.2	-37.2	1.25 V	172	17.5	13.5
3	21255.00	43.2 PK	74.0	-30.8	1.77 V	264	47.2	-4.0
4	21255.00	31.8 AV	54.0	-22.2	1.77 V	264	35.8	-4.0
5	#28340.00	43.8 PK	88.2	-44.4	2.10 V	303	44.9	-1.1
6	#28340.00	33.2 AV	68.2	-35.0	2.10 V	303	34.3	-1.1

**Remarks:**

1. Emission Level(dBuV/m) = Raw Value(dBuV) + Correction Factor(dB/m)
2. Correction Factor(dB/m) = Antenna Factor(dB/m) + Cable Factor(dB) – Pre-Amplifier Factor(dB)
3. Margin value = Emission Level – Limit value
4. The other emission levels were very low against the limit.
5. "#": The radiated frequency is out of the restricted band.

<b>RF Mode</b>	TX 802.11ax (HE80)	<b>Channel</b>	CH 7 : 5985 MHz
<b>Frequency Range</b>	1 GHz ~ 40 GHz	<b>Detector Function &amp; Bandwidth</b>	(PK) RB = 1 MHz, VB = 3 MHz (AV) RB = 1 MHz, VB = 1 kHz
<b>Input Power (System)</b>	120Vac, 60Hz	<b>Environmental Conditions</b>	25°C, 68% RH
<b>Tested By</b>	Tom Yang		

**Antenna Polarity & Test Distance : Horizontal at 3 m**

No	Frequency (MHz)	Emission Level (dBuV/m)	Limit (dBuV/m)	Margin (dB)	Antenna Height (m)	Table Angle (Degree)	Raw Value (dBuV)	Correction Factor (dB/m)
1	11970.00	44.2 PK	74.0	-29.8	2.33 H	326	33.4	10.8
2	11970.00	31.2 AV	54.0	-22.8	2.33 H	326	20.4	10.8
3	17955.00	44.3 PK	74.0	-29.7	1.49 H	113	20.8	23.5
4	17955.00	33.7 AV	54.0	-20.3	1.49 H	113	10.2	23.5
5	23940.00	45.1 PK	74.0	-28.9	2.60 H	195	47.3	-2.2
6	23940.00	33.7 AV	54.0	-20.3	2.60 H	195	35.9	-2.2

**Antenna Polarity & Test Distance : Vertical at 3 m**

No	Frequency (MHz)	Emission Level (dBuV/m)	Limit (dBuV/m)	Margin (dB)	Antenna Height (m)	Table Angle (Degree)	Raw Value (dBuV)	Correction Factor (dB/m)
1	11970.00	44.3 PK	74.0	-29.7	1.20 V	157	33.5	10.8
2	11970.00	30.9 AV	54.0	-23.1	1.20 V	157	20.1	10.8
3	17955.00	42.7 PK	74.0	-31.3	1.78 V	260	19.2	23.5
4	17955.00	31.4 AV	54.0	-22.6	1.78 V	260	7.9	23.5
5	23940.00	44.2 PK	74.0	-29.8	2.13 V	299	46.4	-2.2
6	23940.00	33.6 AV	54.0	-20.4	2.13 V	299	35.8	-2.2

**Remarks:**

1. Emission Level(dBuV/m) = Raw Value(dBuV) + Correction Factor(dB/m)
2. Correction Factor(dB/m) = Antenna Factor(dB/m) + Cable Factor(dB) – Pre-Amplifier Factor(dB)
3. Margin value = Emission Level – Limit value
4. The other emission levels were very low against the limit.

<b>RF Mode</b>	TX 802.11ax (HE80)	<b>Channel</b>	CH 215 : 7025 MHz
<b>Frequency Range</b>	1 GHz ~ 40 GHz	<b>Detector Function &amp; Bandwidth</b>	(PK) RB = 1 MHz, VB = 3 MHz (AV) RB = 1 MHz, VB = 1 kHz
<b>Input Power (System)</b>	120Vac, 60Hz	<b>Environmental Conditions</b>	25°C, 68% RH
<b>Tested By</b>	Tom Yang		

**Antenna Polarity & Test Distance : Horizontal at 3 m**

No	Frequency (MHz)	Emission Level (dBuV/m)	Limit (dBuV/m)	Margin (dB)	Antenna Height (m)	Table Angle (Degree)	Raw Value (dBuV)	Correction Factor (dB/m)
1	#14050.00	44.8 PK	88.2	-43.4	2.32 H	336	31.6	13.2
2	#14050.00	31.5 AV	68.2	-36.7	2.32 H	336	18.3	13.2
3	21075.00	43.9 PK	74.0	-30.1	1.51 H	136	48.0	-4.1
4	21075.00	33.1 AV	54.0	-20.9	1.51 H	136	37.2	-4.1
5	#28100.00	44.3 PK	88.2	-43.9	2.56 H	186	45.5	-1.2
6	#28100.00	33.0 AV	68.2	-35.2	2.56 H	186	34.2	-1.2

**Antenna Polarity & Test Distance : Vertical at 3 m**

No	Frequency (MHz)	Emission Level (dBuV/m)	Limit (dBuV/m)	Margin (dB)	Antenna Height (m)	Table Angle (Degree)	Raw Value (dBuV)	Correction Factor (dB/m)
1	#14050.00	44.6 PK	88.2	-43.6	1.24 V	166	31.4	13.2
2	#14050.00	31.4 AV	68.2	-36.8	1.24 V	166	18.2	13.2
3	21075.00	43.6 PK	74.0	-30.4	1.79 V	280	47.7	-4.1
4	21075.00	32.5 AV	54.0	-21.5	1.79 V	280	36.6	-4.1
5	#28100.00	42.6 PK	88.2	-45.6	2.13 V	305	43.8	-1.2
6	#28100.00	32.3 AV	68.2	-35.9	2.13 V	305	33.5	-1.2

**Remarks:**

1. Emission Level(dBuV/m) = Raw Value(dBuV) + Correction Factor(dB/m)
2. Correction Factor(dB/m) = Antenna Factor(dB/m) + Cable Factor(dB) – Pre-Amplifier Factor(dB)
3. Margin value = Emission Level – Limit value
4. The other emission levels were very low against the limit.
5. " # ": The radiated frequency is out of the restricted band.

<b>RF Mode</b>	TX 802.11ax (HE160)	<b>Channel</b>	CH 15 : 6025 MHz
<b>Frequency Range</b>	1 GHz ~ 40 GHz	<b>Detector Function &amp; Bandwidth</b>	(PK) RB = 1 MHz, VB = 3 MHz (AV) RB = 1 MHz, VB = 1 kHz
<b>Input Power (System)</b>	120Vac, 60Hz	<b>Environmental Conditions</b>	25°C, 68% RH
<b>Tested By</b>	Tom Yang		

**Antenna Polarity & Test Distance : Horizontal at 3 m**

No	Frequency (MHz)	Emission Level (dBuV/m)	Limit (dBuV/m)	Margin (dB)	Antenna Height (m)	Table Angle (Degree)	Raw Value (dBuV)	Correction Factor (dB/m)
1	12050.00	44.3 PK	74.0	-29.7	2.33 H	332	33.4	10.9
2	12050.00	31.1 AV	54.0	-22.9	2.33 H	332	20.2	10.9
3	18075.00	43.8 PK	74.0	-30.2	1.53 H	138	38.0	5.8
4	18075.00	33.5 AV	54.0	-20.5	1.53 H	138	27.7	5.8
5	#24100.00	45.2 PK	88.2	-43.0	2.53 H	202	47.4	-2.2
6	#24100.00	33.9 AV	68.2	-34.3	2.53 H	202	36.1	-2.2

**Antenna Polarity & Test Distance : Vertical at 3 m**

No	Frequency (MHz)	Emission Level (dBuV/m)	Limit (dBuV/m)	Margin (dB)	Antenna Height (m)	Table Angle (Degree)	Raw Value (dBuV)	Correction Factor (dB/m)
1	12050.00	44.0 PK	74.0	-30.0	1.21 V	167	33.1	10.9
2	12050.00	31.0 AV	54.0	-23.0	1.21 V	167	20.1	10.9
3	18075.00	42.5 PK	74.0	-31.5	1.75 V	286	36.7	5.8
4	18075.00	31.2 AV	54.0	-22.8	1.75 V	286	25.4	5.8
5	#24100.00	42.1 PK	88.2	-46.1	2.11 V	335	44.3	-2.2
6	#24100.00	32.3 AV	68.2	-35.9	2.11 V	335	34.5	-2.2

**Remarks:**

1. Emission Level(dBuV/m) = Raw Value(dBuV) + Correction Factor(dB/m)
2. Correction Factor(dB/m) = Antenna Factor(dB/m) + Cable Factor(dB) – Pre-Amplifier Factor(dB)
3. Margin value = Emission Level – Limit value
4. The other emission levels were very low against the limit.
5. " # ": The radiated frequency is out of the restricted band.

<b>RF Mode</b>	TX 802.11ax (HE160)	<b>Channel</b>	CH 47 : 6185 MHz
<b>Frequency Range</b>	1 GHz ~ 40 GHz	<b>Detector Function &amp; Bandwidth</b>	(PK) RB = 1 MHz, VB = 3 MHz (AV) RB = 1 MHz, VB = 1 kHz
<b>Input Power (System)</b>	120Vac, 60Hz	<b>Environmental Conditions</b>	25°C, 68% RH
<b>Tested By</b>	Tom Yang		

**Antenna Polarity & Test Distance : Horizontal at 3 m**

No	Frequency (MHz)	Emission Level (dBuV/m)	Limit (dBuV/m)	Margin (dB)	Antenna Height (m)	Table Angle (Degree)	Raw Value (dBuV)	Correction Factor (dB/m)
1	12370.00	45.5 PK	74.0	-28.5	2.25 H	360	35.5	10.0
2	12370.00	32.9 AV	54.0	-21.1	2.25 H	360	22.9	10.0
3	18555.00	43.2 PK	74.0	-30.8	1.53 H	114	50.2	-7.0
4	18555.00	32.7 AV	54.0	-21.3	1.53 H	114	39.7	-7.0
5	#24740.00	45.2 PK	88.2	-43.0	2.51 H	169	46.7	-1.5
6	#24740.00	33.2 AV	68.2	-35.0	2.51 H	169	34.7	-1.5

**Antenna Polarity & Test Distance : Vertical at 3 m**

No	Frequency (MHz)	Emission Level (dBuV/m)	Limit (dBuV/m)	Margin (dB)	Antenna Height (m)	Table Angle (Degree)	Raw Value (dBuV)	Correction Factor (dB/m)
1	12370.00	44.6 PK	74.0	-29.4	1.21 V	161	34.6	10.0
2	12370.00	31.3 AV	54.0	-22.7	1.21 V	161	21.3	10.0
3	18555.00	43.3 PK	74.0	-30.7	1.83 V	284	50.3	-7.0
4	18555.00	32.1 AV	54.0	-21.9	1.83 V	284	39.1	-7.0
5	#24740.00	42.7 PK	88.2	-45.5	2.13 V	311	44.2	-1.5
6	#24740.00	32.5 AV	68.2	-35.7	2.13 V	311	34.0	-1.5

**Remarks:**

1. Emission Level(dBuV/m) = Raw Value(dBuV) + Correction Factor(dB/m)
2. Correction Factor(dB/m) = Antenna Factor(dB/m) + Cable Factor(dB) – Pre-Amplifier Factor(dB)
3. Margin value = Emission Level – Limit value
4. The other emission levels were very low against the limit.
5. " # ": The radiated frequency is out of the restricted band.

<b>RF Mode</b>	TX 802.11ax (HE160)	<b>Channel</b>	CH 79 : 6345 MHz
<b>Frequency Range</b>	1 GHz ~ 40 GHz	<b>Detector Function &amp; Bandwidth</b>	(PK) RB = 1 MHz, VB = 3 MHz (AV) RB = 1 MHz, VB = 1 kHz
<b>Input Power (System)</b>	120Vac, 60Hz	<b>Environmental Conditions</b>	25°C, 68% RH
<b>Tested By</b>	Tom Yang		

**Antenna Polarity & Test Distance : Horizontal at 3 m**

No	Frequency (MHz)	Emission Level (dBuV/m)	Limit (dBuV/m)	Margin (dB)	Antenna Height (m)	Table Angle (Degree)	Raw Value (dBuV)	Correction Factor (dB/m)
1	12690.00	44.7 PK	74.0	-29.3	2.34 H	333	34.4	10.3
2	12690.00	32.2 AV	54.0	-21.8	2.34 H	333	21.9	10.3
3	19035.00	43.1 PK	74.0	-30.9	1.52 H	109	49.7	-6.6
4	19035.00	32.7 AV	54.0	-21.3	1.52 H	109	39.3	-6.6
5	#25380.00	45.1 PK	88.2	-43.1	2.56 H	180	46.5	-1.4
6	#25380.00	33.5 AV	68.2	-34.7	2.56 H	180	34.9	-1.4

**Antenna Polarity & Test Distance : Vertical at 3 m**

No	Frequency (MHz)	Emission Level (dBuV/m)	Limit (dBuV/m)	Margin (dB)	Antenna Height (m)	Table Angle (Degree)	Raw Value (dBuV)	Correction Factor (dB/m)
1	12690.00	44.9 PK	74.0	-29.1	1.26 V	169	34.6	10.3
2	12690.00	31.8 AV	54.0	-22.2	1.26 V	169	21.5	10.3
3	19035.00	43.9 PK	74.0	-30.1	1.79 V	286	50.5	-6.6
4	19035.00	32.6 AV	54.0	-21.4	1.79 V	286	39.2	-6.6
5	#25380.00	42.4 PK	88.2	-45.8	2.13 V	305	43.8	-1.4
6	#25380.00	32.2 AV	68.2	-36.0	2.13 V	305	33.6	-1.4

**Remarks:**

1. Emission Level(dBuV/m) = Raw Value(dBuV) + Correction Factor(dB/m)
2. Correction Factor(dB/m) = Antenna Factor(dB/m) + Cable Factor(dB) – Pre-Amplifier Factor(dB)
3. Margin value = Emission Level – Limit value
4. The other emission levels were very low against the limit.
5. " # ": The radiated frequency is out of the restricted band.

<b>RF Mode</b>	TX 802.11ax (HE160)	<b>Channel</b>	CH 111 : 6505 MHz
<b>Frequency Range</b>	1 GHz ~ 40 GHz	<b>Detector Function &amp; Bandwidth</b>	(PK) RB = 1 MHz, VB = 3 MHz (AV) RB = 1 MHz, VB = 1 kHz
<b>Input Power (System)</b>	120Vac, 60Hz	<b>Environmental Conditions</b>	25°C, 68% RH
<b>Tested By</b>	Tom Yang		

**Antenna Polarity & Test Distance : Horizontal at 3 m**

No	Frequency (MHz)	Emission Level (dBuV/m)	Limit (dBuV/m)	Margin (dB)	Antenna Height (m)	Table Angle (Degree)	Raw Value (dBuV)	Correction Factor (dB/m)
1	#13010.00	44.6 PK	88.2	-43.6	2.37 H	348	34.0	10.6
2	#13010.00	32.3 AV	68.2	-35.9	2.37 H	348	21.7	10.6
3	19515.00	43.3 PK	74.0	-30.7	1.55 H	107	49.5	-6.2
4	19515.00	32.8 AV	54.0	-21.2	1.55 H	107	39.0	-6.2
5	#26020.00	44.8 PK	88.2	-43.4	2.60 H	193	45.8	-1.0
6	#26020.00	33.1 AV	68.2	-35.1	2.60 H	193	34.1	-1.0

**Antenna Polarity & Test Distance : Vertical at 3 m**

No	Frequency (MHz)	Emission Level (dBuV/m)	Limit (dBuV/m)	Margin (dB)	Antenna Height (m)	Table Angle (Degree)	Raw Value (dBuV)	Correction Factor (dB/m)
1	#13010.00	43.8 PK	88.2	-44.4	1.17 V	168	33.2	10.6
2	#13010.00	30.6 AV	68.2	-37.6	1.17 V	168	20.0	10.6
3	19515.00	43.8 PK	74.0	-30.2	1.86 V	299	50.0	-6.2
4	19515.00	32.3 AV	54.0	-21.7	1.86 V	299	38.5	-6.2
5	#26020.00	41.7 PK	88.2	-46.5	2.08 V	306	42.7	-1.0
6	#26020.00	31.6 AV	68.2	-36.6	2.08 V	306	32.6	-1.0

**Remarks:**

1. Emission Level(dBuV/m) = Raw Value(dBuV) + Correction Factor(dB/m)
2. Correction Factor(dB/m) = Antenna Factor(dB/m) + Cable Factor(dB) – Pre-Amplifier Factor(dB)
3. Margin value = Emission Level – Limit value
4. The other emission levels were very low against the limit.
5. "#": The radiated frequency is out of the restricted band.

<b>RF Mode</b>	TX 802.11ax (HE160)	<b>Channel</b>	CH 143 : 6665 MHz
<b>Frequency Range</b>	1 GHz ~ 40 GHz	<b>Detector Function &amp; Bandwidth</b>	(PK) RB = 1 MHz, VB = 3 MHz (AV) RB = 1 MHz, VB = 1 kHz
<b>Input Power (System)</b>	120Vac, 60Hz	<b>Environmental Conditions</b>	25°C, 68% RH
<b>Tested By</b>	Tom Yang		

**Antenna Polarity & Test Distance : Horizontal at 3 m**

No	Frequency (MHz)	Emission Level (dBuV/m)	Limit (dBuV/m)	Margin (dB)	Antenna Height (m)	Table Angle (Degree)	Raw Value (dBuV)	Correction Factor (dB/m)
1	13330.00	45.1 PK	74.0	-28.9	2.31 H	348	33.4	11.7
2	13330.00	32.5 AV	54.0	-21.5	2.31 H	348	20.8	11.7
3	19995.00	42.9 PK	74.0	-31.1	1.54 H	112	48.5	-5.6
4	19995.00	32.6 AV	54.0	-21.4	1.54 H	112	38.2	-5.6
5	#26660.00	45.4 PK	88.2	-42.8	2.55 H	174	46.1	-0.7
6	#26660.00	33.2 AV	68.2	-35.0	2.55 H	174	33.9	-0.7

**Antenna Polarity & Test Distance : Vertical at 3 m**

No	Frequency (MHz)	Emission Level (dBuV/m)	Limit (dBuV/m)	Margin (dB)	Antenna Height (m)	Table Angle (Degree)	Raw Value (dBuV)	Correction Factor (dB/m)
1	13330.00	43.9 PK	74.0	-30.1	1.21 V	190	32.2	11.7
2	13330.00	30.9 AV	54.0	-23.1	1.21 V	190	19.2	11.7
3	19995.00	43.1 PK	74.0	-30.9	1.77 V	278	48.7	-5.6
4	19995.00	32.0 AV	54.0	-22.0	1.77 V	278	37.6	-5.6
5	#26660.00	41.9 PK	88.2	-46.3	2.13 V	321	42.6	-0.7
6	#26660.00	32.0 AV	68.2	-36.2	2.13 V	321	32.7	-0.7

**Remarks:**

1. Emission Level(dBuV/m) = Raw Value(dBuV) + Correction Factor(dB/m)
2. Correction Factor(dB/m) = Antenna Factor(dB/m) + Cable Factor(dB) – Pre-Amplifier Factor(dB)
3. Margin value = Emission Level – Limit value
4. The other emission levels were very low against the limit.
5. " # ": The radiated frequency is out of the restricted band.



<b>RF Mode</b>	TX 802.11ax (HE160)	<b>Channel</b>	CH 175 : 6825 MHz
<b>Frequency Range</b>	1 GHz ~ 40 GHz	<b>Detector Function &amp; Bandwidth</b>	(PK) RB = 1 MHz, VB = 3 MHz (AV) RB = 1 MHz, VB = 1 kHz
<b>Input Power (System)</b>	120Vac, 60Hz	<b>Environmental Conditions</b>	25°C, 68% RH
<b>Tested By</b>	Tom Yang		

**Antenna Polarity & Test Distance : Horizontal at 3 m**

No	Frequency (MHz)	Emission Level (dBuV/m)	Limit (dBuV/m)	Margin (dB)	Antenna Height (m)	Table Angle (Degree)	Raw Value (dBuV)	Correction Factor (dB/m)
1	#13650.00	44.2 PK	88.2	-44.0	2.29 H	339	31.3	12.9
2	#13650.00	31.8 AV	68.2	-36.4	2.29 H	339	18.9	12.9
3	20475.00	42.7 PK	74.0	-31.3	1.48 H	107	47.5	-4.8
4	20475.00	32.5 AV	54.0	-21.5	1.48 H	107	37.3	-4.8
5	#27300.00	45.3 PK	88.2	-42.9	2.52 H	174	46.3	-1.0
6	#27300.00	33.4 AV	68.2	-34.8	2.52 H	174	34.4	-1.0

**Antenna Polarity & Test Distance : Vertical at 3 m**

No	Frequency (MHz)	Emission Level (dBuV/m)	Limit (dBuV/m)	Margin (dB)	Antenna Height (m)	Table Angle (Degree)	Raw Value (dBuV)	Correction Factor (dB/m)
1	#13650.00	41.9 PK	88.2	-46.3	1.06 V	189	29.0	12.9
2	#13650.00	29.6 AV	68.2	-38.6	1.06 V	189	16.7	12.9
3	20475.00	43.6 PK	74.0	-30.4	1.99 V	240	48.4	-4.8
4	20475.00	32.7 AV	54.0	-21.3	1.99 V	240	37.5	-4.8
5	#27300.00	44.4 PK	88.2	-43.8	2.31 V	335	45.4	-1.0
6	#27300.00	34.2 AV	68.2	-34.0	2.31 V	335	35.2	-1.0

**Remarks:**

1. Emission Level(dBuV/m) = Raw Value(dBuV) + Correction Factor(dB/m)
2. Correction Factor(dB/m) = Antenna Factor(dB/m) + Cable Factor(dB) – Pre-Amplifier Factor(dB)
3. Margin value = Emission Level – Limit value
4. The other emission levels were very low against the limit.
5. "#": The radiated frequency is out of the restricted band.

<b>RF Mode</b>	TX 802.11ax (HE160)	<b>Channel</b>	CH 207 : 6985 MHz
<b>Frequency Range</b>	1 GHz ~ 40 GHz	<b>Detector Function &amp; Bandwidth</b>	(PK) RB = 1 MHz, VB = 3 MHz (AV) RB = 1 MHz, VB = 1 kHz
<b>Input Power (System)</b>	120Vac, 60Hz	<b>Environmental Conditions</b>	25°C, 68% RH
<b>Tested By</b>	Tom Yang		

**Antenna Polarity & Test Distance : Horizontal at 3 m**

No	Frequency (MHz)	Emission Level (dBuV/m)	Limit (dBuV/m)	Margin (dB)	Antenna Height (m)	Table Angle (Degree)	Raw Value (dBuV)	Correction Factor (dB/m)
1	#13970.00	44.1 PK	88.2	-44.1	2.43 H	314	31.0	13.1
2	#13970.00	31.1 AV	68.2	-37.1	2.43 H	314	18.0	13.1
3	20955.00	44.0 PK	74.0	-30.0	1.54 H	113	48.1	-4.1
4	20955.00	33.2 AV	54.0	-20.8	1.54 H	113	37.3	-4.1
5	#27940.00	44.6 PK	88.2	-43.6	2.54 H	190	45.7	-1.1
6	#27940.00	33.4 AV	68.2	-34.8	2.54 H	190	34.5	-1.1

**Antenna Polarity & Test Distance : Vertical at 3 m**

No	Frequency (MHz)	Emission Level (dBuV/m)	Limit (dBuV/m)	Margin (dB)	Antenna Height (m)	Table Angle (Degree)	Raw Value (dBuV)	Correction Factor (dB/m)
1	#13970.00	41.9 PK	88.2	-46.3	1.02 V	177	28.8	13.1
2	#13970.00	29.4 AV	68.2	-38.8	1.02 V	177	16.3	13.1
3	20955.00	43.5 PK	74.0	-30.5	1.89 V	231	47.6	-4.1
4	20955.00	32.4 AV	54.0	-21.6	1.89 V	231	36.5	-4.1
5	#27940.00	44.4 PK	88.2	-43.8	2.23 V	344	45.5	-1.1
6	#27940.00	34.5 AV	68.2	-33.7	2.23 V	344	35.6	-1.1

**Remarks:**

1. Emission Level(dBuV/m) = Raw Value(dBuV) + Correction Factor(dB/m)
2. Correction Factor(dB/m) = Antenna Factor(dB/m) + Cable Factor(dB) – Pre-Amplifier Factor(dB)
3. Margin value = Emission Level – Limit value
4. The other emission levels were very low against the limit.
5. " # ": The radiated frequency is out of the restricted band.

<b>RF Mode</b>	TX 802.11be (EHT20)	<b>Channel</b>	CH 1 : 5955 MHz
<b>Frequency Range</b>	1 GHz ~ 40 GHz	<b>Detector Function &amp; Bandwidth</b>	(PK) RB = 1 MHz, VB = 3 MHz (AV) RB = 1 MHz, VB = 300 Hz
<b>Input Power (System)</b>	120Vac, 60Hz	<b>Environmental Conditions</b>	25°C, 68% RH
<b>Tested By</b>	Tom Yang		

**Antenna Polarity & Test Distance : Horizontal at 3 m**

No	Frequency (MHz)	Emission Level (dBuV/m)	Limit (dBuV/m)	Margin (dB)	Antenna Height (m)	Table Angle (Degree)	Raw Value (dBuV)	Correction Factor (dB/m)
1	11910.00	42.5 PK	74.0	-31.5	2.30 H	326	31.6	10.9
2	11910.00	30.2 AV	54.0	-23.8	2.30 H	326	19.3	10.9
3	17865.00	44.0 PK	74.0	-30.0	1.66 H	131	22.4	21.6
4	17865.00	32.5 AV	54.0	-21.5	1.66 H	131	10.9	21.6
5	23820.00	45.6 PK	74.0	-28.4	2.58 H	208	48.0	-2.4
6	23820.00	33.7 AV	54.0	-20.3	2.58 H	208	36.1	-2.4

**Antenna Polarity & Test Distance : Vertical at 3 m**

No	Frequency (MHz)	Emission Level (dBuV/m)	Limit (dBuV/m)	Margin (dB)	Antenna Height (m)	Table Angle (Degree)	Raw Value (dBuV)	Correction Factor (dB/m)
1	11910.00	43.8 PK	74.0	-30.2	1.12 V	158	32.9	10.9
2	11910.00	31.2 AV	54.0	-22.8	1.12 V	158	20.3	10.9
3	17865.00	42.8 PK	74.0	-31.2	1.68 V	238	21.2	21.6
4	17865.00	31.2 AV	54.0	-22.8	1.68 V	238	9.6	21.6
5	23820.00	43.4 PK	74.0	-30.6	2.08 V	336	45.8	-2.4
6	23820.00	32.5 AV	54.0	-21.5	2.08 V	336	34.9	-2.4

**Remarks:**

1. Emission Level(dBuV/m) = Raw Value(dBuV) + Correction Factor(dB/m)
2. Correction Factor(dB/m) = Antenna Factor(dB/m) + Cable Factor(dB) – Pre-Amplifier Factor(dB)
3. Margin value = Emission Level – Limit value
4. The other emission levels were very low against the limit.

<b>RF Mode</b>	TX 802.11be (EHT20)	<b>Channel</b>	CH 45 : 6175 MHz
<b>Frequency Range</b>	1 GHz ~ 40 GHz	<b>Detector Function &amp; Bandwidth</b>	(PK) RB = 1 MHz, VB = 3 MHz (AV) RB = 1 MHz, VB = 300 Hz
<b>Input Power (System)</b>	120Vac, 60Hz	<b>Environmental Conditions</b>	25°C, 68% RH
<b>Tested By</b>	Tom Yang		

**Antenna Polarity & Test Distance : Horizontal at 3 m**

No	Frequency (MHz)	Emission Level (dBuV/m)	Limit (dBuV/m)	Margin (dB)	Antenna Height (m)	Table Angle (Degree)	Raw Value (dBuV)	Correction Factor (dB/m)
1	12350.00	42.5 PK	74.0	-31.5	2.37 H	336	32.5	10.0
2	12350.00	29.9 AV	54.0	-24.1	2.37 H	336	19.9	10.0
3	18525.00	44.1 PK	74.0	-29.9	1.61 H	124	51.2	-7.1
4	18525.00	32.6 AV	54.0	-21.4	1.61 H	124	39.7	-7.1
5	#24700.00	43.2 PK	88.2	-45.0	2.64 H	202	44.8	-1.6
6	#24700.00	33.2 AV	68.2	-35.0	2.64 H	202	34.8	-1.6

**Antenna Polarity & Test Distance : Vertical at 3 m**

No	Frequency (MHz)	Emission Level (dBuV/m)	Limit (dBuV/m)	Margin (dB)	Antenna Height (m)	Table Angle (Degree)	Raw Value (dBuV)	Correction Factor (dB/m)
1	12350.00	44.2 PK	74.0	-29.8	1.30 V	187	34.2	10.0
2	12350.00	31.2 AV	54.0	-22.8	1.30 V	187	21.2	10.0
3	18525.00	43.6 PK	74.0	-30.4	1.69 V	249	50.7	-7.1
4	18525.00	31.6 AV	54.0	-22.4	1.69 V	249	38.7	-7.1
5	#24700.00	42.7 PK	88.2	-45.5	2.18 V	300	44.3	-1.6
6	#24700.00	33.0 AV	68.2	-35.2	2.18 V	300	34.6	-1.6

**Remarks:**

1. Emission Level(dBuV/m) = Raw Value(dBuV) + Correction Factor(dB/m)
2. Correction Factor(dB/m) = Antenna Factor(dB/m) + Cable Factor(dB) – Pre-Amplifier Factor(dB)
3. Margin value = Emission Level – Limit value
4. The other emission levels were very low against the limit.
5. "#": The radiated frequency is out of the restricted band.

<b>RF Mode</b>	TX 802.11be (EHT20)	<b>Channel</b>	CH 93 : 6415 MHz
<b>Frequency Range</b>	1 GHz ~ 40 GHz	<b>Detector Function &amp; Bandwidth</b>	(PK) RB = 1 MHz, VB = 3 MHz (AV) RB = 1 MHz, VB = 300 Hz
<b>Input Power (System)</b>	120Vac, 60Hz	<b>Environmental Conditions</b>	25°C, 68% RH
<b>Tested By</b>	Tom Yang		

**Antenna Polarity & Test Distance : Horizontal at 3 m**

No	Frequency (MHz)	Emission Level (dBuV/m)	Limit (dBuV/m)	Margin (dB)	Antenna Height (m)	Table Angle (Degree)	Raw Value (dBuV)	Correction Factor (dB/m)
1	#12830.00	42.5 PK	88.2	-45.7	2.26 H	315	32.0	10.5
2	#12830.00	29.5 AV	68.2	-38.7	2.26 H	315	19.0	10.5
3	19245.00	44.1 PK	74.0	-29.9	1.52 H	125	50.6	-6.5
4	19245.00	32.7 AV	54.0	-21.3	1.52 H	125	39.2	-6.5
5	#25660.00	43.9 PK	88.2	-44.3	2.62 H	200	45.1	-1.2
6	#25660.00	34.0 AV	68.2	-34.2	2.62 H	200	35.2	-1.2

**Antenna Polarity & Test Distance : Vertical at 3 m**

No	Frequency (MHz)	Emission Level (dBuV/m)	Limit (dBuV/m)	Margin (dB)	Antenna Height (m)	Table Angle (Degree)	Raw Value (dBuV)	Correction Factor (dB/m)
1	#12830.00	42.6 PK	88.2	-45.6	1.28 V	125	32.1	10.5
2	#12830.00	29.5 AV	68.2	-38.7	1.28 V	125	19.0	10.5
3	19245.00	43.4 PK	74.0	-30.6	1.76 V	281	49.9	-6.5
4	19245.00	31.8 AV	54.0	-22.2	1.76 V	281	38.3	-6.5
5	#25660.00	44.4 PK	88.2	-43.8	2.12 V	296	45.6	-1.2
6	#25660.00	33.2 AV	68.2	-35.0	2.12 V	296	34.4	-1.2

**Remarks:**

1. Emission Level(dBuV/m) = Raw Value(dBuV) + Correction Factor(dB/m)
2. Correction Factor(dB/m) = Antenna Factor(dB/m) + Cable Factor(dB) – Pre-Amplifier Factor(dB)
3. Margin value = Emission Level – Limit value
4. The other emission levels were very low against the limit.
5. " # ": The radiated frequency is out of the restricted band.

<b>RF Mode</b>	TX 802.11be (EHT20)	<b>Channel</b>	CH 97 : 6435 MHz
<b>Frequency Range</b>	1 GHz ~ 40 GHz	<b>Detector Function &amp; Bandwidth</b>	(PK) RB = 1 MHz, VB = 3 MHz (AV) RB = 1 MHz, VB = 300 Hz
<b>Input Power (System)</b>	120Vac, 60Hz	<b>Environmental Conditions</b>	25°C, 68% RH
<b>Tested By</b>	Tom Yang		

**Antenna Polarity & Test Distance : Horizontal at 3 m**

No	Frequency (MHz)	Emission Level (dBuV/m)	Limit (dBuV/m)	Margin (dB)	Antenna Height (m)	Table Angle (Degree)	Raw Value (dBuV)	Correction Factor (dB/m)
1	#12870.00	43.6 PK	88.2	-44.6	2.31 H	343	33.1	10.5
2	#12870.00	31.8 AV	68.2	-36.4	2.31 H	343	21.3	10.5
3	19305.00	44.6 PK	74.0	-29.4	1.57 H	131	51.4	-6.8
4	19305.00	32.2 AV	54.0	-21.8	1.57 H	131	39.0	-6.8
5	#25740.00	43.5 PK	88.2	-44.7	2.53 H	231	44.7	-1.2
6	#25740.00	33.0 AV	68.2	-35.2	2.53 H	231	34.2	-1.2

**Antenna Polarity & Test Distance : Vertical at 3 m**

No	Frequency (MHz)	Emission Level (dBuV/m)	Limit (dBuV/m)	Margin (dB)	Antenna Height (m)	Table Angle (Degree)	Raw Value (dBuV)	Correction Factor (dB/m)
1	#12870.00	43.0 PK	88.2	-45.2	1.05 V	169	32.5	10.5
2	#12870.00	30.1 AV	68.2	-38.1	1.05 V	169	19.6	10.5
3	19305.00	42.8 PK	74.0	-31.2	1.94 V	253	49.6	-6.8
4	19305.00	31.9 AV	54.0	-22.1	1.94 V	253	38.7	-6.8
5	#25740.00	42.6 PK	88.2	-45.6	2.14 V	293	43.8	-1.2
6	#25740.00	33.1 AV	68.2	-35.1	2.14 V	293	34.3	-1.2

**Remarks:**

1. Emission Level(dBuV/m) = Raw Value(dBuV) + Correction Factor(dB/m)
2. Correction Factor(dB/m) = Antenna Factor(dB/m) + Cable Factor(dB) – Pre-Amplifier Factor(dB)
3. Margin value = Emission Level – Limit value
4. The other emission levels were very low against the limit.
5. "#": The radiated frequency is out of the restricted band.

<b>RF Mode</b>	TX 802.11be (EHT20)	<b>Channel</b>	CH 105 : 6475 MHz
<b>Frequency Range</b>	1 GHz ~ 40 GHz	<b>Detector Function &amp; Bandwidth</b>	(PK) RB = 1 MHz, VB = 3 MHz (AV) RB = 1 MHz, VB = 300 Hz
<b>Input Power (System)</b>	120Vac, 60Hz	<b>Environmental Conditions</b>	25°C, 68% RH
<b>Tested By</b>	Tom Yang		

**Antenna Polarity & Test Distance : Horizontal at 3 m**

No	Frequency (MHz)	Emission Level (dBuV/m)	Limit (dBuV/m)	Margin (dB)	Antenna Height (m)	Table Angle (Degree)	Raw Value (dBuV)	Correction Factor (dB/m)
1	#12950.00	43.7 PK	88.2	-44.5	2.27 H	351	33.2	10.5
2	#12950.00	30.9 AV	68.2	-37.3	2.27 H	351	20.4	10.5
3	19425.00	44.2 PK	74.0	-29.8	1.62 H	107	50.7	-6.5
4	19425.00	32.8 AV	54.0	-21.2	1.62 H	107	39.3	-6.5
5	#25900.00	44.1 PK	88.2	-44.1	2.65 H	203	45.2	-1.1
6	#25900.00	33.4 AV	68.2	-34.8	2.65 H	203	34.5	-1.1

**Antenna Polarity & Test Distance : Vertical at 3 m**

No	Frequency (MHz)	Emission Level (dBuV/m)	Limit (dBuV/m)	Margin (dB)	Antenna Height (m)	Table Angle (Degree)	Raw Value (dBuV)	Correction Factor (dB/m)
1	#12950.00	42.1 PK	88.2	-46.1	1.11 V	173	31.6	10.5
2	#12950.00	29.1 AV	68.2	-39.1	1.11 V	173	18.6	10.5
3	19425.00	43.2 PK	74.0	-30.8	1.91 V	249	49.7	-6.5
4	19425.00	32.4 AV	54.0	-21.6	1.91 V	249	38.9	-6.5
5	#25900.00	43.8 PK	88.2	-44.4	2.32 V	321	44.9	-1.1
6	#25900.00	33.8 AV	68.2	-34.4	2.32 V	321	34.9	-1.1

**Remarks:**

1. Emission Level(dBuV/m) = Raw Value(dBuV) + Correction Factor(dB/m)
2. Correction Factor(dB/m) = Antenna Factor(dB/m) + Cable Factor(dB) – Pre-Amplifier Factor(dB)
3. Margin value = Emission Level – Limit value
4. The other emission levels were very low against the limit.
5. "#": The radiated frequency is out of the restricted band.

<b>RF Mode</b>	TX 802.11be (EHT20)	<b>Channel</b>	CH 113 : 6515 MHz
<b>Frequency Range</b>	1 GHz ~ 40 GHz	<b>Detector Function &amp; Bandwidth</b>	(PK) RB = 1 MHz, VB = 3 MHz (AV) RB = 1 MHz, VB = 300 Hz
<b>Input Power (System)</b>	120Vac, 60Hz	<b>Environmental Conditions</b>	25°C, 68% RH
<b>Tested By</b>	Tom Yang		

**Antenna Polarity & Test Distance : Horizontal at 3 m**

No	Frequency (MHz)	Emission Level (dBuV/m)	Limit (dBuV/m)	Margin (dB)	Antenna Height (m)	Table Angle (Degree)	Raw Value (dBuV)	Correction Factor (dB/m)
1	#13030.00	43.1 PK	88.2	-45.1	2.30 H	345	32.5	10.6
2	#13030.00	30.4 AV	68.2	-37.8	2.30 H	345	19.8	10.6
3	19545.00	43.4 PK	74.0	-30.6	1.69 H	64	49.6	-6.2
4	19545.00	32.0 AV	54.0	-22.0	1.69 H	64	38.2	-6.2
5	#26060.00	43.0 PK	88.2	-45.2	2.59 H	205	44.0	-1.0
6	#26060.00	33.2 AV	68.2	-35.0	2.59 H	205	34.2	-1.0

**Antenna Polarity & Test Distance : Vertical at 3 m**

No	Frequency (MHz)	Emission Level (dBuV/m)	Limit (dBuV/m)	Margin (dB)	Antenna Height (m)	Table Angle (Degree)	Raw Value (dBuV)	Correction Factor (dB/m)
1	#13030.00	42.4 PK	88.2	-45.8	1.28 V	133	31.8	10.6
2	#13030.00	30.2 AV	68.2	-38.0	1.28 V	133	19.6	10.6
3	19545.00	42.7 PK	74.0	-31.3	1.55 V	248	48.9	-6.2
4	19545.00	31.7 AV	54.0	-22.3	1.55 V	248	37.9	-6.2
5	#26060.00	43.7 PK	88.2	-44.5	2.00 V	318	44.7	-1.0
6	#26060.00	33.4 AV	68.2	-34.8	2.00 V	318	34.4	-1.0

**Remarks:**

1. Emission Level(dBuV/m) = Raw Value(dBuV) + Correction Factor(dB/m)
2. Correction Factor(dB/m) = Antenna Factor(dB/m) + Cable Factor(dB) – Pre-Amplifier Factor(dB)
3. Margin value = Emission Level – Limit value
4. The other emission levels were very low against the limit.
5. " # ": The radiated frequency is out of the restricted band.



<b>RF Mode</b>	TX 802.11be (EHT20)	<b>Channel</b>	CH 117 : 6535 MHz
<b>Frequency Range</b>	1 GHz ~ 40 GHz	<b>Detector Function &amp; Bandwidth</b>	(PK) RB = 1 MHz, VB = 3 MHz (AV) RB = 1 MHz, VB = 300 Hz
<b>Input Power (System)</b>	120Vac, 60Hz	<b>Environmental Conditions</b>	25°C, 68% RH
<b>Tested By</b>	Tom Yang		

**Antenna Polarity & Test Distance : Horizontal at 3 m**

No	Frequency (MHz)	Emission Level (dBuV/m)	Limit (dBuV/m)	Margin (dB)	Antenna Height (m)	Table Angle (Degree)	Raw Value (dBuV)	Correction Factor (dB/m)
1	#13070.00	42.5 PK	88.2	-45.7	2.45 H	331	31.7	10.8
2	#13070.00	30.5 AV	68.2	-37.7	2.45 H	331	19.7	10.8
3	19605.00	43.8 PK	74.0	-30.2	1.52 H	98	49.8	-6.0
4	19605.00	33.1 AV	54.0	-20.9	1.52 H	98	39.1	-6.0
5	#26140.00	43.3 PK	88.2	-44.9	2.75 H	208	44.2	-0.9
6	#26140.00	33.6 AV	68.2	-34.6	2.75 H	208	34.5	-0.9

**Antenna Polarity & Test Distance : Vertical at 3 m**

No	Frequency (MHz)	Emission Level (dBuV/m)	Limit (dBuV/m)	Margin (dB)	Antenna Height (m)	Table Angle (Degree)	Raw Value (dBuV)	Correction Factor (dB/m)
1	#13070.00	42.6 PK	88.2	-45.6	1.23 V	136	31.8	10.8
2	#13070.00	29.9 AV	68.2	-38.3	1.23 V	136	19.1	10.8
3	19605.00	43.4 PK	74.0	-30.6	1.64 V	233	49.4	-6.0
4	19605.00	32.6 AV	54.0	-21.4	1.64 V	233	38.6	-6.0
5	#26140.00	43.9 PK	88.2	-44.3	1.99 V	323	44.8	-0.9
6	#26140.00	33.2 AV	68.2	-35.0	1.99 V	323	34.1	-0.9

**Remarks:**

1. Emission Level(dBuV/m) = Raw Value(dBuV) + Correction Factor(dB/m)
2. Correction Factor(dB/m) = Antenna Factor(dB/m) + Cable Factor(dB) – Pre-Amplifier Factor(dB)
3. Margin value = Emission Level – Limit value
4. The other emission levels were very low against the limit.
5. " # ": The radiated frequency is out of the restricted band.

<b>RF Mode</b>	TX 802.11be (EHT20)	<b>Channel</b>	CH 153 : 6715 MHz
<b>Frequency Range</b>	1 GHz ~ 40 GHz	<b>Detector Function &amp; Bandwidth</b>	(PK) RB = 1 MHz, VB = 3 MHz (AV) RB = 1 MHz, VB = 300 Hz
<b>Input Power (System)</b>	120Vac, 60Hz	<b>Environmental Conditions</b>	25°C, 68% RH
<b>Tested By</b>	Tom Yang		

**Antenna Polarity & Test Distance : Horizontal at 3 m**

No	Frequency (MHz)	Emission Level (dBuV/m)	Limit (dBuV/m)	Margin (dB)	Antenna Height (m)	Table Angle (Degree)	Raw Value (dBuV)	Correction Factor (dB/m)
1	#13430.00	41.9 PK	88.2	-46.3	2.46 H	341	29.7	12.2
2	#13430.00	30.2 AV	68.2	-38.0	2.46 H	341	18.0	12.2
3	20145.00	43.4 PK	74.0	-30.6	1.53 H	88	49.0	-5.6
4	20145.00	33.0 AV	54.0	-21.0	1.53 H	88	38.6	-5.6
5	#26860.00	43.5 PK	88.2	-44.7	2.69 H	204	44.3	-0.8
6	#26860.00	33.6 AV	68.2	-34.6	2.69 H	204	34.4	-0.8

**Antenna Polarity & Test Distance : Vertical at 3 m**

No	Frequency (MHz)	Emission Level (dBuV/m)	Limit (dBuV/m)	Margin (dB)	Antenna Height (m)	Table Angle (Degree)	Raw Value (dBuV)	Correction Factor (dB/m)
1	#13430.00	42.5 PK	88.2	-45.7	1.25 V	146	30.3	12.2
2	#13430.00	30.6 AV	68.2	-37.6	1.25 V	146	18.4	12.2
3	20145.00	43.3 PK	74.0	-30.7	1.56 V	248	48.9	-5.6
4	20145.00	32.0 AV	54.0	-22.0	1.56 V	248	37.6	-5.6
5	#26860.00	43.3 PK	88.2	-44.9	2.02 V	321	44.1	-0.8
6	#26860.00	33.0 AV	68.2	-35.2	2.02 V	321	33.8	-0.8

**Remarks:**

1. Emission Level(dBuV/m) = Raw Value(dBuV) + Correction Factor(dB/m)
2. Correction Factor(dB/m) = Antenna Factor(dB/m) + Cable Factor(dB) – Pre-Amplifier Factor(dB)
3. Margin value = Emission Level – Limit value
4. The other emission levels were very low against the limit.
5. "#": The radiated frequency is out of the restricted band.

<b>RF Mode</b>	TX 802.11be (EHT20)	<b>Channel</b>	CH 181 : 6855 MHz
<b>Frequency Range</b>	1 GHz ~ 40 GHz	<b>Detector Function &amp; Bandwidth</b>	(PK) RB = 1 MHz, VB = 3 MHz (AV) RB = 1 MHz, VB = 300 Hz
<b>Input Power (System)</b>	120Vac, 60Hz	<b>Environmental Conditions</b>	25°C, 68% RH
<b>Tested By</b>	Tom Yang		

**Antenna Polarity & Test Distance : Horizontal at 3 m**

No	Frequency (MHz)	Emission Level (dBuV/m)	Limit (dBuV/m)	Margin (dB)	Antenna Height (m)	Table Angle (Degree)	Raw Value (dBuV)	Correction Factor (dB/m)
1	#13710.00	41.4 PK	88.2	-46.8	2.21 H	349	28.6	12.8
2	#13710.00	29.2 AV	68.2	-39.0	2.21 H	349	16.4	12.8
3	20565.00	43.4 PK	74.0	-30.6	1.75 H	117	48.1	-4.7
4	20565.00	33.0 AV	54.0	-21.0	1.75 H	117	37.7	-4.7
5	#27420.00	44.8 PK	88.2	-43.4	2.56 H	207	45.7	-0.9
6	#27420.00	34.8 AV	68.2	-33.4	2.56 H	207	35.7	-0.9

**Antenna Polarity & Test Distance : Vertical at 3 m**

No	Frequency (MHz)	Emission Level (dBuV/m)	Limit (dBuV/m)	Margin (dB)	Antenna Height (m)	Table Angle (Degree)	Raw Value (dBuV)	Correction Factor (dB/m)
1	#13710.00	43.6 PK	88.2	-44.6	1.23 V	133	30.8	12.8
2	#13710.00	30.9 AV	68.2	-37.3	1.23 V	133	18.1	12.8
3	20565.00	43.3 PK	74.0	-30.7	1.63 V	235	48.0	-4.7
4	20565.00	31.3 AV	54.0	-22.7	1.63 V	235	36.0	-4.7
5	#27420.00	44.2 PK	88.2	-44.0	2.13 V	317	45.1	-0.9
6	#27420.00	33.4 AV	68.2	-34.8	2.13 V	317	34.3	-0.9

**Remarks:**

1. Emission Level(dBuV/m) = Raw Value(dBuV) + Correction Factor(dB/m)
2. Correction Factor(dB/m) = Antenna Factor(dB/m) + Cable Factor(dB) – Pre-Amplifier Factor(dB)
3. Margin value = Emission Level – Limit value
4. The other emission levels were very low against the limit.
5. "#": The radiated frequency is out of the restricted band.

<b>RF Mode</b>	TX 802.11be (EHT20)	<b>Channel</b>	CH 185 : 6875 MHz
<b>Frequency Range</b>	1 GHz ~ 40 GHz	<b>Detector Function &amp; Bandwidth</b>	(PK) RB = 1 MHz, VB = 3 MHz (AV) RB = 1 MHz, VB = 300 Hz
<b>Input Power (System)</b>	120Vac, 60Hz	<b>Environmental Conditions</b>	25°C, 68% RH
<b>Tested By</b>	Tom Yang		

**Antenna Polarity & Test Distance : Horizontal at 3 m**

No	Frequency (MHz)	Emission Level (dBuV/m)	Limit (dBuV/m)	Margin (dB)	Antenna Height (m)	Table Angle (Degree)	Raw Value (dBuV)	Correction Factor (dB/m)
1	#13750.00	41.9 PK	88.2	-46.3	2.42 H	338	29.0	12.9
2	#13750.00	30.4 AV	68.2	-37.8	2.42 H	338	17.5	12.9
3	20625.00	43.7 PK	74.0	-30.3	1.54 H	79	48.5	-4.8
4	20625.00	33.5 AV	54.0	-20.5	1.54 H	79	38.3	-4.8
5	#27500.00	44.1 PK	88.2	-44.1	2.72 H	208	45.0	-0.9
6	#27500.00	34.0 AV	68.2	-34.2	2.72 H	208	34.9	-0.9

**Antenna Polarity & Test Distance : Vertical at 3 m**

No	Frequency (MHz)	Emission Level (dBuV/m)	Limit (dBuV/m)	Margin (dB)	Antenna Height (m)	Table Angle (Degree)	Raw Value (dBuV)	Correction Factor (dB/m)
1	#13750.00	42.5 PK	88.2	-45.7	1.27 V	133	29.6	12.9
2	#13750.00	30.1 AV	68.2	-38.1	1.27 V	133	17.2	12.9
3	20625.00	43.0 PK	74.0	-31.0	1.61 V	237	47.8	-4.8
4	20625.00	32.0 AV	54.0	-22.0	1.61 V	237	36.8	-4.8
5	#27500.00	43.3 PK	88.2	-44.9	1.95 V	315	44.2	-0.9
6	#27500.00	33.2 AV	68.2	-35.0	1.95 V	315	34.1	-0.9

**Remarks:**

1. Emission Level(dBuV/m) = Raw Value(dBuV) + Correction Factor(dB/m)
2. Correction Factor(dB/m) = Antenna Factor(dB/m) + Cable Factor(dB) – Pre-Amplifier Factor(dB)
3. Margin value = Emission Level – Limit value
4. The other emission levels were very low against the limit.
5. "#": The radiated frequency is out of the restricted band.

<b>RF Mode</b>	TX 802.11be (EHT20)	<b>Channel</b>	CH 213 : 7015 MHz
<b>Frequency Range</b>	1 GHz ~ 40 GHz	<b>Detector Function &amp; Bandwidth</b>	(PK) RB = 1 MHz, VB = 3 MHz (AV) RB = 1 MHz, VB = 300 Hz
<b>Input Power (System)</b>	120Vac, 60Hz	<b>Environmental Conditions</b>	25°C, 68% RH
<b>Tested By</b>	Tom Yang		

**Antenna Polarity & Test Distance : Horizontal at 3 m**

No	Frequency (MHz)	Emission Level (dBuV/m)	Limit (dBuV/m)	Margin (dB)	Antenna Height (m)	Table Angle (Degree)	Raw Value (dBuV)	Correction Factor (dB/m)
1	#14030.00	43.3 PK	88.2	-44.9	2.28 H	358	30.2	13.1
2	#14030.00	31.4 AV	68.2	-36.8	2.28 H	358	18.3	13.1
3	21045.00	44.6 PK	74.0	-29.4	1.60 H	131	48.7	-4.1
4	21045.00	33.4 AV	54.0	-20.6	1.60 H	131	37.5	-4.1
5	#28060.00	43.5 PK	88.2	-44.7	2.57 H	237	44.7	-1.2
6	#28060.00	34.8 AV	68.2	-33.4	2.57 H	237	36.0	-1.2

**Antenna Polarity & Test Distance : Vertical at 3 m**

No	Frequency (MHz)	Emission Level (dBuV/m)	Limit (dBuV/m)	Margin (dB)	Antenna Height (m)	Table Angle (Degree)	Raw Value (dBuV)	Correction Factor (dB/m)
1	#14030.00	43.3 PK	88.2	-44.9	1.23 V	125	30.2	13.1
2	#14030.00	30.5 AV	68.2	-37.7	1.23 V	125	17.4	13.1
3	21045.00	43.6 PK	74.0	-30.4	1.59 V	249	47.7	-4.1
4	21045.00	31.6 AV	54.0	-22.4	1.59 V	249	35.7	-4.1
5	#28060.00	44.5 PK	88.2	-43.7	2.19 V	321	45.7	-1.2
6	#28060.00	33.7 AV	68.2	-34.5	2.19 V	321	34.9	-1.2

**Remarks:**

1. Emission Level(dBuV/m) = Raw Value(dBuV) + Correction Factor(dB/m)
2. Correction Factor(dB/m) = Antenna Factor(dB/m) + Cable Factor(dB) – Pre-Amplifier Factor(dB)
3. Margin value = Emission Level – Limit value
4. The other emission levels were very low against the limit.
5. "#": The radiated frequency is out of the restricted band.

<b>RF Mode</b>	TX 802.11be (EHT20)	<b>Channel</b>	CH 233 : 7115 MHz
<b>Frequency Range</b>	1 GHz ~ 40 GHz	<b>Detector Function &amp; Bandwidth</b>	(PK) RB = 1 MHz, VB = 3 MHz (AV) RB = 1 MHz, VB = 300 Hz
<b>Input Power (System)</b>	120Vac, 60Hz	<b>Environmental Conditions</b>	25°C, 68% RH
<b>Tested By</b>	Tom Yang		

**Antenna Polarity & Test Distance : Horizontal at 3 m**

No	Frequency (MHz)	Emission Level (dBuV/m)	Limit (dBuV/m)	Margin (dB)	Antenna Height (m)	Table Angle (Degree)	Raw Value (dBuV)	Correction Factor (dB/m)
1	#14230.00	43.3 PK	88.2	-44.9	2.30 H	355	29.8	13.5
2	#14230.00	30.5 AV	68.2	-37.7	2.30 H	355	17.0	13.5
3	21345.00	44.0 PK	74.0	-30.0	1.71 H	61	47.8	-3.8
4	21345.00	33.0 AV	54.0	-21.0	1.71 H	61	36.8	-3.8
5	#28460.00	43.2 PK	88.2	-45.0	2.64 H	200	44.5	-1.3
6	#28460.00	33.3 AV	68.2	-34.9	2.64 H	200	34.6	-1.3

**Antenna Polarity & Test Distance : Vertical at 3 m**

No	Frequency (MHz)	Emission Level (dBuV/m)	Limit (dBuV/m)	Margin (dB)	Antenna Height (m)	Table Angle (Degree)	Raw Value (dBuV)	Correction Factor (dB/m)
1	#14230.00	43.0 PK	88.2	-45.2	1.28 V	124	29.5	13.5
2	#14230.00	30.2 AV	68.2	-38.0	1.28 V	124	16.7	13.5
3	21345.00	43.8 PK	74.0	-30.2	1.67 V	225	47.6	-3.8
4	21345.00	33.0 AV	54.0	-21.0	1.67 V	225	36.8	-3.8
5	#28460.00	43.8 PK	88.2	-44.4	1.95 V	316	45.1	-1.3
6	#28460.00	33.1 AV	68.2	-35.1	1.95 V	316	34.4	-1.3

**Remarks:**

1. Emission Level(dBuV/m) = Raw Value(dBuV) + Correction Factor(dB/m)
2. Correction Factor(dB/m) = Antenna Factor(dB/m) + Cable Factor(dB) – Pre-Amplifier Factor(dB)
3. Margin value = Emission Level – Limit value
4. The other emission levels were very low against the limit.
5. "#": The radiated frequency is out of the restricted band.

<b>RF Mode</b>	TX 802.11be (EHT40)	<b>Channel</b>	CH 3 : 5965 MHz
<b>Frequency Range</b>	1 GHz ~ 40 GHz	<b>Detector Function &amp; Bandwidth</b>	(PK) RB = 1 MHz, VB = 3 MHz (AV) RB = 1 MHz, VB = 300 Hz
<b>Input Power (System)</b>	120Vac, 60Hz	<b>Environmental Conditions</b>	25°C, 68% RH
<b>Tested By</b>	Tom Yang		

**Antenna Polarity & Test Distance : Horizontal at 3 m**

No	Frequency (MHz)	Emission Level (dBuV/m)	Limit (dBuV/m)	Margin (dB)	Antenna Height (m)	Table Angle (Degree)	Raw Value (dBuV)	Correction Factor (dB/m)
1	11930.00	41.8 PK	74.0	-32.2	2.47 H	340	30.9	10.9
2	11930.00	30.1 AV	54.0	-23.9	2.47 H	340	19.2	10.9
3	17895.00	44.0 PK	74.0	-30.0	1.50 H	104	21.8	22.2
4	17895.00	33.3 AV	54.0	-20.7	1.50 H	104	11.1	22.2
5	23860.00	43.4 PK	74.0	-30.6	2.70 H	197	45.8	-2.4
6	23860.00	33.5 AV	54.0	-20.5	2.70 H	197	35.9	-2.4

**Antenna Polarity & Test Distance : Vertical at 3 m**

No	Frequency (MHz)	Emission Level (dBuV/m)	Limit (dBuV/m)	Margin (dB)	Antenna Height (m)	Table Angle (Degree)	Raw Value (dBuV)	Correction Factor (dB/m)
1	11930.00	41.9 PK	74.0	-32.1	1.12 V	183	31.0	10.9
2	11930.00	29.0 AV	54.0	-25.0	1.12 V	183	18.1	10.9
3	17895.00	43.6 PK	74.0	-30.4	1.96 V	260	21.4	22.2
4	17895.00	32.8 AV	54.0	-21.2	1.96 V	260	10.6	22.2
5	23860.00	43.8 PK	74.0	-30.2	2.37 V	328	46.2	-2.4
6	23860.00	33.5 AV	54.0	-20.5	2.37 V	328	35.9	-2.4

**Remarks:**

1. Emission Level(dBuV/m) = Raw Value(dBuV) + Correction Factor(dB/m)
2. Correction Factor(dB/m) = Antenna Factor(dB/m) + Cable Factor(dB) – Pre-Amplifier Factor(dB)
3. Margin value = Emission Level – Limit value
4. The other emission levels were very low against the limit.

<b>RF Mode</b>	TX 802.11be (EHT40)	<b>Channel</b>	CH 43 : 6165 MHz
<b>Frequency Range</b>	1 GHz ~ 40 GHz	<b>Detector Function &amp; Bandwidth</b>	(PK) RB = 1 MHz, VB = 3 MHz (AV) RB = 1 MHz, VB = 300 Hz
<b>Input Power (System)</b>	120Vac, 60Hz	<b>Environmental Conditions</b>	25°C, 68% RH
<b>Tested By</b>	Tom Yang		

**Antenna Polarity & Test Distance : Horizontal at 3 m**

No	Frequency (MHz)	Emission Level (dBuV/m)	Limit (dBuV/m)	Margin (dB)	Antenna Height (m)	Table Angle (Degree)	Raw Value (dBuV)	Correction Factor (dB/m)
1	12330.00	41.3 PK	74.0	-32.7	2.52 H	329	31.2	10.1
2	12330.00	29.8 AV	54.0	-24.2	2.52 H	329	19.7	10.1
3	18495.00	43.5 PK	74.0	-30.5	1.46 H	97	50.7	-7.2
4	18495.00	32.8 AV	54.0	-21.2	1.46 H	97	40.0	-7.2
5	#24660.00	43.4 PK	88.2	-44.8	2.73 H	195	45.1	-1.7
6	#24660.00	33.3 AV	68.2	-34.9	2.73 H	195	35.0	-1.7

**Antenna Polarity & Test Distance : Vertical at 3 m**

No	Frequency (MHz)	Emission Level (dBuV/m)	Limit (dBuV/m)	Margin (dB)	Antenna Height (m)	Table Angle (Degree)	Raw Value (dBuV)	Correction Factor (dB/m)
1	12330.00	43.1 PK	74.0	-30.9	1.25 V	134	33.0	10.1
2	12330.00	30.4 AV	54.0	-23.6	1.25 V	134	20.3	10.1
3	18495.00	43.5 PK	74.0	-30.5	1.60 V	248	50.7	-7.2
4	18495.00	31.3 AV	54.0	-22.7	1.60 V	248	38.5	-7.2
5	#24660.00	44.2 PK	88.2	-44.0	2.17 V	319	45.9	-1.7
6	#24660.00	33.5 AV	68.2	-34.7	2.17 V	319	35.2	-1.7

**Remarks:**

1. Emission Level(dBuV/m) = Raw Value(dBuV) + Correction Factor(dB/m)
2. Correction Factor(dB/m) = Antenna Factor(dB/m) + Cable Factor(dB) – Pre-Amplifier Factor(dB)
3. Margin value = Emission Level – Limit value
4. The other emission levels were very low against the limit.
5. "#": The radiated frequency is out of the restricted band.



<b>RF Mode</b>	TX 802.11be (EHT40)	<b>Channel</b>	CH 91 : 6405 MHz
<b>Frequency Range</b>	1 GHz ~ 40 GHz	<b>Detector Function &amp; Bandwidth</b>	(PK) RB = 1 MHz, VB = 3 MHz (AV) RB = 1 MHz, VB = 300 Hz
<b>Input Power (System)</b>	120Vac, 60Hz	<b>Environmental Conditions</b>	25°C, 68% RH
<b>Tested By</b>	Tom Yang		

**Antenna Polarity & Test Distance : Horizontal at 3 m**

No	Frequency (MHz)	Emission Level (dBuV/m)	Limit (dBuV/m)	Margin (dB)	Antenna Height (m)	Table Angle (Degree)	Raw Value (dBuV)	Correction Factor (dB/m)
1	#12810.00	43.4 PK	88.2	-44.8	2.29 H	360	32.9	10.5
2	#12810.00	30.7 AV	68.2	-37.5	2.29 H	360	20.2	10.5
3	19215.00	44.3 PK	74.0	-29.7	1.65 H	99	50.7	-6.4
4	19215.00	32.6 AV	54.0	-21.4	1.65 H	99	39.0	-6.4
5	#25620.00	44.0 PK	88.2	-44.2	2.62 H	201	45.3	-1.3
6	#25620.00	33.3 AV	68.2	-34.9	2.62 H	201	34.6	-1.3

**Antenna Polarity & Test Distance : Vertical at 3 m**

No	Frequency (MHz)	Emission Level (dBuV/m)	Limit (dBuV/m)	Margin (dB)	Antenna Height (m)	Table Angle (Degree)	Raw Value (dBuV)	Correction Factor (dB/m)
1	#12810.00	42.6 PK	88.2	-45.6	1.29 V	143	32.1	10.5
2	#12810.00	30.2 AV	68.2	-38.0	1.29 V	143	19.7	10.5
3	19215.00	43.6 PK	74.0	-30.4	1.67 V	240	50.0	-6.4
4	19215.00	32.6 AV	54.0	-21.4	1.67 V	240	39.0	-6.4
5	#25620.00	43.9 PK	88.2	-44.3	1.99 V	333	45.2	-1.3
6	#25620.00	33.1 AV	68.2	-35.1	1.99 V	333	34.4	-1.3

**Remarks:**

1. Emission Level(dBuV/m) = Raw Value(dBuV) + Correction Factor(dB/m)
2. Correction Factor(dB/m) = Antenna Factor(dB/m) + Cable Factor(dB) – Pre-Amplifier Factor(dB)
3. Margin value = Emission Level – Limit value
4. The other emission levels were very low against the limit.
5. "#": The radiated frequency is out of the restricted band.

<b>RF Mode</b>	TX 802.11be (EHT40)	<b>Channel</b>	CH 99 : 6445 MHz
<b>Frequency Range</b>	1 GHz ~ 40 GHz	<b>Detector Function &amp; Bandwidth</b>	(PK) RB = 1 MHz, VB = 3 MHz (AV) RB = 1 MHz, VB = 300 Hz
<b>Input Power (System)</b>	120Vac, 60Hz	<b>Environmental Conditions</b>	25°C, 68% RH
<b>Tested By</b>	Tom Yang		

**Antenna Polarity & Test Distance : Horizontal at 3 m**

No	Frequency (MHz)	Emission Level (dBuV/m)	Limit (dBuV/m)	Margin (dB)	Antenna Height (m)	Table Angle (Degree)	Raw Value (dBuV)	Correction Factor (dB/m)
1	#12890.00	42.7 PK	88.2	-45.5	2.29 H	311	32.2	10.5
2	#12890.00	30.3 AV	68.2	-37.9	2.29 H	311	19.8	10.5
3	19335.00	44.5 PK	74.0	-29.5	1.62 H	146	51.2	-6.7
4	19335.00	32.9 AV	54.0	-21.1	1.62 H	146	39.6	-6.7
5	#25780.00	42.6 PK	88.2	-45.6	2.54 H	201	43.7	-1.1
6	#25780.00	33.6 AV	68.2	-34.6	2.54 H	201	34.7	-1.1

**Antenna Polarity & Test Distance : Vertical at 3 m**

No	Frequency (MHz)	Emission Level (dBuV/m)	Limit (dBuV/m)	Margin (dB)	Antenna Height (m)	Table Angle (Degree)	Raw Value (dBuV)	Correction Factor (dB/m)
1	#12890.00	43.0 PK	88.2	-45.2	1.23 V	123	32.5	10.5
2	#12890.00	30.1 AV	68.2	-38.1	1.23 V	123	19.6	10.5
3	19335.00	43.8 PK	74.0	-30.2	1.69 V	240	50.5	-6.7
4	19335.00	33.1 AV	54.0	-20.9	1.69 V	240	39.8	-6.7
5	#25780.00	44.2 PK	88.2	-44.0	2.01 V	336	45.3	-1.1
6	#25780.00	33.7 AV	68.2	-34.5	2.01 V	336	34.8	-1.1

**Remarks:**

1. Emission Level(dBuV/m) = Raw Value(dBuV) + Correction Factor(dB/m)
2. Correction Factor(dB/m) = Antenna Factor(dB/m) + Cable Factor(dB) – Pre-Amplifier Factor(dB)
3. Margin value = Emission Level – Limit value
4. The other emission levels were very low against the limit.
5. "#": The radiated frequency is out of the restricted band.

<b>RF Mode</b>	TX 802.11be (EHT40)	<b>Channel</b>	CH 107 : 6485 MHz
<b>Frequency Range</b>	1 GHz ~ 40 GHz	<b>Detector Function &amp; Bandwidth</b>	(PK) RB = 1 MHz, VB = 3 MHz (AV) RB = 1 MHz, VB = 300 Hz
<b>Input Power (System)</b>	120Vac, 60Hz	<b>Environmental Conditions</b>	25°C, 68% RH
<b>Tested By</b>	Tom Yang		

**Antenna Polarity & Test Distance : Horizontal at 3 m**

No	Frequency (MHz)	Emission Level (dBuV/m)	Limit (dBuV/m)	Margin (dB)	Antenna Height (m)	Table Angle (Degree)	Raw Value (dBuV)	Correction Factor (dB/m)
1	#12970.00	43.6 PK	88.2	-44.6	2.29 H	327	33.1	10.5
2	#12970.00	30.8 AV	68.2	-37.4	2.29 H	327	20.3	10.5
3	19455.00	44.2 PK	74.0	-29.8	1.60 H	86	50.6	-6.4
4	19455.00	32.7 AV	54.0	-21.3	1.60 H	86	39.1	-6.4
5	#25940.00	44.0 PK	88.2	-44.2	2.62 H	210	45.1	-1.1
6	#25940.00	33.3 AV	68.2	-34.9	2.62 H	210	34.4	-1.1

**Antenna Polarity & Test Distance : Vertical at 3 m**

No	Frequency (MHz)	Emission Level (dBuV/m)	Limit (dBuV/m)	Margin (dB)	Antenna Height (m)	Table Angle (Degree)	Raw Value (dBuV)	Correction Factor (dB/m)
1	#12970.00	42.6 PK	88.2	-45.6	1.19 V	120	32.1	10.5
2	#12970.00	29.6 AV	68.2	-38.6	1.19 V	120	19.1	10.5
3	19455.00	44.2 PK	74.0	-29.8	1.70 V	231	50.6	-6.4
4	19455.00	33.3 AV	54.0	-20.7	1.70 V	231	39.7	-6.4
5	#25940.00	43.9 PK	88.2	-44.3	1.98 V	329	45.0	-1.1
6	#25940.00	33.7 AV	68.2	-34.5	1.98 V	329	34.8	-1.1

**Remarks:**

1. Emission Level(dBuV/m) = Raw Value(dBuV) + Correction Factor(dB/m)
2. Correction Factor(dB/m) = Antenna Factor(dB/m) + Cable Factor(dB) – Pre-Amplifier Factor(dB)
3. Margin value = Emission Level – Limit value
4. The other emission levels were very low against the limit.
5. "#": The radiated frequency is out of the restricted band.

<b>RF Mode</b>	TX 802.11be (EHT40)	<b>Channel</b>	CH 115 : 6525 MHz
<b>Frequency Range</b>	1 GHz ~ 40 GHz	<b>Detector Function &amp; Bandwidth</b>	(PK) RB = 1 MHz, VB = 3 MHz (AV) RB = 1 MHz, VB = 300 Hz
<b>Input Power (System)</b>	120Vac, 60Hz	<b>Environmental Conditions</b>	25°C, 68% RH
<b>Tested By</b>	Tom Yang		

**Antenna Polarity & Test Distance : Horizontal at 3 m**

No	Frequency (MHz)	Emission Level (dBuV/m)	Limit (dBuV/m)	Margin (dB)	Antenna Height (m)	Table Angle (Degree)	Raw Value (dBuV)	Correction Factor (dB/m)
1	#13050.00	44.0 PK	88.2	-44.2	2.27 H	341	33.3	10.7
2	#13050.00	30.9 AV	68.2	-37.3	2.27 H	341	20.2	10.7
3	19575.00	43.4 PK	74.0	-30.6	1.72 H	71	49.4	-6.0
4	19575.00	31.8 AV	54.0	-22.2	1.72 H	71	37.8	-6.0
5	#26100.00	43.4 PK	88.2	-44.8	2.68 H	204	44.2	-0.8
6	#26100.00	33.3 AV	68.2	-34.9	2.68 H	204	34.1	-0.8

**Antenna Polarity & Test Distance : Vertical at 3 m**

No	Frequency (MHz)	Emission Level (dBuV/m)	Limit (dBuV/m)	Margin (dB)	Antenna Height (m)	Table Angle (Degree)	Raw Value (dBuV)	Correction Factor (dB/m)
1	#13050.00	43.0 PK	88.2	-45.2	1.28 V	118	32.3	10.7
2	#13050.00	29.9 AV	68.2	-38.3	1.28 V	118	19.2	10.7
3	19575.00	43.8 PK	74.0	-30.2	1.67 V	228	49.8	-6.0
4	19575.00	32.9 AV	54.0	-21.1	1.67 V	228	38.9	-6.0
5	#26100.00	43.8 PK	88.2	-44.4	1.97 V	327	44.6	-0.8
6	#26100.00	33.5 AV	68.2	-34.7	1.97 V	327	34.3	-0.8

**Remarks:**

1. Emission Level(dBuV/m) = Raw Value(dBuV) + Correction Factor(dB/m)
2. Correction Factor(dB/m) = Antenna Factor(dB/m) + Cable Factor(dB) – Pre-Amplifier Factor(dB)
3. Margin value = Emission Level – Limit value
4. The other emission levels were very low against the limit.
5. " # ": The radiated frequency is out of the restricted band.

<b>RF Mode</b>	TX 802.11be (EHT40)	<b>Channel</b>	CH 123 : 6565 MHz
<b>Frequency Range</b>	1 GHz ~ 40 GHz	<b>Detector Function &amp; Bandwidth</b>	(PK) RB = 1 MHz, VB = 3 MHz (AV) RB = 1 MHz, VB = 300 Hz
<b>Input Power (System)</b>	120Vac, 60Hz	<b>Environmental Conditions</b>	25°C, 68% RH
<b>Tested By</b>	Tom Yang		

**Antenna Polarity & Test Distance : Horizontal at 3 m**

No	Frequency (MHz)	Emission Level (dBuV/m)	Limit (dBuV/m)	Margin (dB)	Antenna Height (m)	Table Angle (Degree)	Raw Value (dBuV)	Correction Factor (dB/m)
1	#13130.00	42.4 PK	88.2	-45.8	2.32 H	340	31.2	11.2
2	#13130.00	29.5 AV	68.2	-38.7	2.32 H	340	18.3	11.2
3	19695.00	44.2 PK	74.0	-29.8	1.65 H	129	50.2	-6.0
4	19695.00	32.9 AV	54.0	-21.1	1.65 H	129	38.9	-6.0
5	#26260.00	42.6 PK	88.2	-45.6	2.69 H	206	43.7	-1.1
6	#26260.00	33.7 AV	68.2	-34.5	2.69 H	206	34.8	-1.1

**Antenna Polarity & Test Distance : Vertical at 3 m**

No	Frequency (MHz)	Emission Level (dBuV/m)	Limit (dBuV/m)	Margin (dB)	Antenna Height (m)	Table Angle (Degree)	Raw Value (dBuV)	Correction Factor (dB/m)
1	#13130.00	43.2 PK	88.2	-45.0	1.28 V	132	32.0	11.2
2	#13130.00	30.5 AV	68.2	-37.7	1.28 V	132	19.3	11.2
3	19695.00	43.3 PK	74.0	-30.7	1.53 V	241	49.3	-6.0
4	19695.00	31.1 AV	54.0	-22.9	1.53 V	241	37.1	-6.0
5	#26260.00	44.7 PK	88.2	-43.5	2.23 V	304	45.8	-1.1
6	#26260.00	33.7 AV	68.2	-34.5	2.23 V	304	34.8	-1.1

**Remarks:**

1. Emission Level(dBuV/m) = Raw Value(dBuV) + Correction Factor(dB/m)
2. Correction Factor(dB/m) = Antenna Factor(dB/m) + Cable Factor(dB) – Pre-Amplifier Factor(dB)
3. Margin value = Emission Level – Limit value
4. The other emission levels were very low against the limit.
5. "#": The radiated frequency is out of the restricted band.

<b>RF Mode</b>	TX 802.11be (EHT40)	<b>Channel</b>	CH 155 : 6725 MHz
<b>Frequency Range</b>	1 GHz ~ 40 GHz	<b>Detector Function &amp; Bandwidth</b>	(PK) RB = 1 MHz, VB = 3 MHz (AV) RB = 1 MHz, VB = 300 Hz
<b>Input Power (System)</b>	120Vac, 60Hz	<b>Environmental Conditions</b>	25°C, 68% RH
<b>Tested By</b>	Tom Yang		

**Antenna Polarity & Test Distance : Horizontal at 3 m**

No	Frequency (MHz)	Emission Level (dBuV/m)	Limit (dBuV/m)	Margin (dB)	Antenna Height (m)	Table Angle (Degree)	Raw Value (dBuV)	Correction Factor (dB/m)
1	#13450.00	43.5 PK	88.2	-44.7	2.28 H	350	31.3	12.2
2	#13450.00	30.8 AV	68.2	-37.4	2.28 H	350	18.6	12.2
3	20175.00	43.9 PK	74.0	-30.1	1.61 H	113	49.4	-5.5
4	20175.00	32.2 AV	54.0	-21.8	1.61 H	113	37.7	-5.5
5	#26900.00	43.8 PK	88.2	-44.4	2.60 H	206	44.6	-0.8
6	#26900.00	33.0 AV	68.2	-35.2	2.60 H	206	33.8	-0.8

**Antenna Polarity & Test Distance : Vertical at 3 m**

No	Frequency (MHz)	Emission Level (dBuV/m)	Limit (dBuV/m)	Margin (dB)	Antenna Height (m)	Table Angle (Degree)	Raw Value (dBuV)	Correction Factor (dB/m)
1	#13450.00	43.3 PK	88.2	-44.9	1.05 V	178	31.1	12.2
2	#13450.00	30.4 AV	68.2	-37.8	1.05 V	178	18.2	12.2
3	20175.00	42.5 PK	74.0	-31.5	1.96 V	243	48.0	-5.5
4	20175.00	31.5 AV	54.0	-22.5	1.96 V	243	37.0	-5.5
5	#26900.00	42.4 PK	88.2	-45.8	2.19 V	307	43.2	-0.8
6	#26900.00	33.1 AV	68.2	-35.1	2.19 V	307	33.9	-0.8

**Remarks:**

1. Emission Level(dBuV/m) = Raw Value(dBuV) + Correction Factor(dB/m)
2. Correction Factor(dB/m) = Antenna Factor(dB/m) + Cable Factor(dB) – Pre-Amplifier Factor(dB)
3. Margin value = Emission Level – Limit value
4. The other emission levels were very low against the limit.
5. "#": The radiated frequency is out of the restricted band.

<b>RF Mode</b>	TX 802.11be (EHT40)	<b>Channel</b>	CH 179 : 6845 MHz
<b>Frequency Range</b>	1 GHz ~ 40 GHz	<b>Detector Function &amp; Bandwidth</b>	(PK) RB = 1 MHz, VB = 3 MHz (AV) RB = 1 MHz, VB = 300 Hz
<b>Input Power (System)</b>	120Vac, 60Hz	<b>Environmental Conditions</b>	25°C, 68% RH
<b>Tested By</b>	Tom Yang		

**Antenna Polarity & Test Distance : Horizontal at 3 m**

No	Frequency (MHz)	Emission Level (dBuV/m)	Limit (dBuV/m)	Margin (dB)	Antenna Height (m)	Table Angle (Degree)	Raw Value (dBuV)	Correction Factor (dB/m)
1	#13690.00	44.1 PK	88.2	-44.1	2.22 H	332	31.2	12.9
2	#13690.00	31.1 AV	68.2	-37.1	2.22 H	332	18.2	12.9
3	20535.00	43.6 PK	74.0	-30.4	1.70 H	66	48.3	-4.7
4	20535.00	32.9 AV	54.0	-21.1	1.70 H	66	37.6	-4.7
5	#27380.00	43.8 PK	88.2	-44.4	2.74 H	193	44.7	-0.9
6	#27380.00	33.8 AV	68.2	-34.4	2.74 H	193	34.7	-0.9

**Antenna Polarity & Test Distance : Vertical at 3 m**

No	Frequency (MHz)	Emission Level (dBuV/m)	Limit (dBuV/m)	Margin (dB)	Antenna Height (m)	Table Angle (Degree)	Raw Value (dBuV)	Correction Factor (dB/m)
1	#13690.00	43.3 PK	88.2	-44.9	1.22 V	117	30.4	12.9
2	#13690.00	30.0 AV	68.2	-38.2	1.22 V	117	17.1	12.9
3	20535.00	43.6 PK	74.0	-30.4	1.64 V	216	48.3	-4.7
4	20535.00	32.8 AV	54.0	-21.2	1.64 V	216	37.5	-4.7
5	#27380.00	43.8 PK	88.2	-44.4	1.93 V	324	44.7	-0.9
6	#27380.00	33.8 AV	68.2	-34.4	1.93 V	324	34.7	-0.9

**Remarks:**

1. Emission Level(dBuV/m) = Raw Value(dBuV) + Correction Factor(dB/m)
2. Correction Factor(dB/m) = Antenna Factor(dB/m) + Cable Factor(dB) – Pre-Amplifier Factor(dB)
3. Margin value = Emission Level – Limit value
4. The other emission levels were very low against the limit.
5. "#": The radiated frequency is out of the restricted band.

<b>RF Mode</b>	TX 802.11be (EHT40)	<b>Channel</b>	CH 187 : 6885 MHz
<b>Frequency Range</b>	1 GHz ~ 40 GHz	<b>Detector Function &amp; Bandwidth</b>	(PK) RB = 1 MHz, VB = 3 MHz (AV) RB = 1 MHz, VB = 300 Hz
<b>Input Power (System)</b>	120Vac, 60Hz	<b>Environmental Conditions</b>	25°C, 68% RH
<b>Tested By</b>	Tom Yang		

**Antenna Polarity & Test Distance : Horizontal at 3 m**

No	Frequency (MHz)	Emission Level (dBuV/m)	Limit (dBuV/m)	Margin (dB)	Antenna Height (m)	Table Angle (Degree)	Raw Value (dBuV)	Correction Factor (dB/m)
1	#13770.00	42.7 PK	88.2	-45.5	2.22 H	354	29.8	12.9
2	#13770.00	29.8 AV	68.2	-38.4	2.22 H	354	16.9	12.9
3	20655.00	43.8 PK	74.0	-30.2	1.66 H	61	48.5	-4.7
4	20655.00	33.0 AV	54.0	-21.0	1.66 H	61	37.7	-4.7
5	#27540.00	43.4 PK	88.2	-44.8	2.63 H	215	44.5	-1.1
6	#27540.00	33.6 AV	68.2	-34.6	2.63 H	215	34.7	-1.1

**Antenna Polarity & Test Distance : Vertical at 3 m**

No	Frequency (MHz)	Emission Level (dBuV/m)	Limit (dBuV/m)	Margin (dB)	Antenna Height (m)	Table Angle (Degree)	Raw Value (dBuV)	Correction Factor (dB/m)
1	#13770.00	42.9 PK	88.2	-45.3	1.33 V	107	30.0	12.9
2	#13770.00	29.7 AV	68.2	-38.5	1.33 V	107	16.8	12.9
3	20655.00	43.3 PK	74.0	-30.7	1.71 V	227	48.0	-4.7
4	20655.00	32.5 AV	54.0	-21.5	1.71 V	227	37.2	-4.7
5	#27540.00	44.3 PK	88.2	-43.9	1.92 V	320	45.4	-1.1
6	#27540.00	33.9 AV	68.2	-34.3	1.92 V	320	35.0	-1.1

**Remarks:**

1. Emission Level(dBuV/m) = Raw Value(dBuV) + Correction Factor(dB/m)
2. Correction Factor(dB/m) = Antenna Factor(dB/m) + Cable Factor(dB) – Pre-Amplifier Factor(dB)
3. Margin value = Emission Level – Limit value
4. The other emission levels were very low against the limit.
5. "#": The radiated frequency is out of the restricted band.



<b>RF Mode</b>	TX 802.11be (EHT40)	<b>Channel</b>	CH 211 : 7005 MHz
<b>Frequency Range</b>	1 GHz ~ 40 GHz	<b>Detector Function &amp; Bandwidth</b>	(PK) RB = 1 MHz, VB = 3 MHz (AV) RB = 1 MHz, VB = 300 Hz
<b>Input Power (System)</b>	120Vac, 60Hz	<b>Environmental Conditions</b>	25°C, 68% RH
<b>Tested By</b>	Tom Yang		

**Antenna Polarity & Test Distance : Horizontal at 3 m**

No	Frequency (MHz)	Emission Level (dBuV/m)	Limit (dBuV/m)	Margin (dB)	Antenna Height (m)	Table Angle (Degree)	Raw Value (dBuV)	Correction Factor (dB/m)
1	#14010.00	42.9 PK	88.2	-45.3	2.24 H	357	29.9	13.0
2	#14010.00	30.0 AV	68.2	-38.2	2.24 H	357	17.0	13.0
3	21015.00	43.4 PK	74.0	-30.6	1.65 H	38	47.4	-4.0
4	21015.00	32.3 AV	54.0	-21.7	1.65 H	38	36.3	-4.0
5	#28020.00	44.1 PK	88.2	-44.1	2.64 H	219	45.3	-1.2
6	#28020.00	33.8 AV	68.2	-34.4	2.64 H	219	35.0	-1.2

**Antenna Polarity & Test Distance : Vertical at 3 m**

No	Frequency (MHz)	Emission Level (dBuV/m)	Limit (dBuV/m)	Margin (dB)	Antenna Height (m)	Table Angle (Degree)	Raw Value (dBuV)	Correction Factor (dB/m)
1	#14010.00	43.4 PK	88.2	-44.8	1.26 V	118	30.4	13.0
2	#14010.00	30.6 AV	68.2	-37.6	1.26 V	118	17.6	13.0
3	21015.00	43.9 PK	74.0	-30.1	1.64 V	260	47.9	-4.0
4	21015.00	32.1 AV	54.0	-21.9	1.64 V	260	36.1	-4.0
5	#28020.00	44.2 PK	88.2	-44.0	2.20 V	329	45.4	-1.2
6	#28020.00	33.6 AV	68.2	-34.6	2.20 V	329	34.8	-1.2

**Remarks:**

1. Emission Level(dBuV/m) = Raw Value(dBuV) + Correction Factor(dB/m)
2. Correction Factor(dB/m) = Antenna Factor(dB/m) + Cable Factor(dB) – Pre-Amplifier Factor(dB)
3. Margin value = Emission Level – Limit value
4. The other emission levels were very low against the limit.
5. "#": The radiated frequency is out of the restricted band.

<b>RF Mode</b>	TX 802.11be (EHT40)	<b>Channel</b>	CH 227 : 7085 MHz
<b>Frequency Range</b>	1 GHz ~ 40 GHz	<b>Detector Function &amp; Bandwidth</b>	(PK) RB = 1 MHz, VB = 3 MHz (AV) RB = 1 MHz, VB = 300 Hz
<b>Input Power (System)</b>	120Vac, 60Hz	<b>Environmental Conditions</b>	25°C, 68% RH
<b>Tested By</b>	Tom Yang		

**Antenna Polarity & Test Distance : Horizontal at 3 m**

No	Frequency (MHz)	Emission Level (dBuV/m)	Limit (dBuV/m)	Margin (dB)	Antenna Height (m)	Table Angle (Degree)	Raw Value (dBuV)	Correction Factor (dB/m)
1	#14170.00	43.4 PK	88.2	-44.8	2.25 H	340	29.9	13.5
2	#14170.00	30.7 AV	68.2	-37.5	2.25 H	340	17.2	13.5
3	21255.00	43.7 PK	74.0	-30.3	1.59 H	112	47.7	-4.0
4	21255.00	32.2 AV	54.0	-21.8	1.59 H	112	36.2	-4.0
5	#28340.00	44.4 PK	88.2	-43.8	2.63 H	199	45.5	-1.1
6	#28340.00	34.5 AV	68.2	-33.7	2.63 H	199	35.6	-1.1

**Antenna Polarity & Test Distance : Vertical at 3 m**

No	Frequency (MHz)	Emission Level (dBuV/m)	Limit (dBuV/m)	Margin (dB)	Antenna Height (m)	Table Angle (Degree)	Raw Value (dBuV)	Correction Factor (dB/m)
1	#14170.00	43.6 PK	88.2	-44.6	1.16 V	110	30.1	13.5
2	#14170.00	30.1 AV	68.2	-38.1	1.16 V	110	16.6	13.5
3	21255.00	43.9 PK	74.0	-30.1	1.58 V	229	47.9	-4.0
4	21255.00	33.2 AV	54.0	-20.8	1.58 V	229	37.2	-4.0
5	#28340.00	43.4 PK	88.2	-44.8	1.94 V	332	44.5	-1.1
6	#28340.00	33.4 AV	68.2	-34.8	1.94 V	332	34.5	-1.1

**Remarks:**

1. Emission Level(dBuV/m) = Raw Value(dBuV) + Correction Factor(dB/m)
2. Correction Factor(dB/m) = Antenna Factor(dB/m) + Cable Factor(dB) – Pre-Amplifier Factor(dB)
3. Margin value = Emission Level – Limit value
4. The other emission levels were very low against the limit.
5. "#": The radiated frequency is out of the restricted band.

<b>RF Mode</b>	TX 802.11be (EHT80)	<b>Channel</b>	CH 7 : 5985 MHz
<b>Frequency Range</b>	1 GHz ~ 40 GHz	<b>Detector Function &amp; Bandwidth</b>	(PK) RB = 1 MHz, VB = 3 MHz (AV) RB = 1 MHz, VB = 510 Hz
<b>Input Power (System)</b>	120Vac, 60Hz	<b>Environmental Conditions</b>	25°C, 68% RH
<b>Tested By</b>	Tom Yang		

**Antenna Polarity & Test Distance : Horizontal at 3 m**

No	Frequency (MHz)	Emission Level (dBuV/m)	Limit (dBuV/m)	Margin (dB)	Antenna Height (m)	Table Angle (Degree)	Raw Value (dBuV)	Correction Factor (dB/m)
1	11970.00	43.0 PK	74.0	-31.0	2.19 H	337	32.2	10.8
2	11970.00	30.2 AV	54.0	-23.8	2.19 H	337	19.4	10.8
3	17955.00	43.2 PK	74.0	-30.8	1.65 H	97	19.7	23.5
4	17955.00	31.9 AV	54.0	-22.1	1.65 H	97	8.4	23.5
5	23940.00	44.6 PK	74.0	-29.4	2.68 H	193	46.8	-2.2
6	23940.00	34.7 AV	54.0	-19.3	2.68 H	193	36.9	-2.2

**Antenna Polarity & Test Distance : Vertical at 3 m**

No	Frequency (MHz)	Emission Level (dBuV/m)	Limit (dBuV/m)	Margin (dB)	Antenna Height (m)	Table Angle (Degree)	Raw Value (dBuV)	Correction Factor (dB/m)
1	11970.00	43.2 PK	74.0	-30.8	1.19 V	131	32.4	10.8
2	11970.00	30.1 AV	54.0	-23.9	1.19 V	131	19.3	10.8
3	17955.00	43.8 PK	74.0	-30.2	1.63 V	263	20.3	23.5
4	17955.00	31.8 AV	54.0	-22.2	1.63 V	263	8.3	23.5
5	23940.00	44.9 PK	74.0	-29.1	2.18 V	335	47.1	-2.2
6	23940.00	33.9 AV	54.0	-20.1	2.18 V	335	36.1	-2.2

**Remarks:**

1. Emission Level(dBuV/m) = Raw Value(dBuV) + Correction Factor(dB/m)
2. Correction Factor(dB/m) = Antenna Factor(dB/m) + Cable Factor(dB) – Pre-Amplifier Factor(dB)
3. Margin value = Emission Level – Limit value
4. The other emission levels were very low against the limit.

<b>RF Mode</b>	TX 802.11be (EHT80)	<b>Channel</b>	CH 39 : 6145 MHz
<b>Frequency Range</b>	1 GHz ~ 40 GHz	<b>Detector Function &amp; Bandwidth</b>	(PK) RB = 1 MHz, VB = 3 MHz (AV) RB = 1 MHz, VB = 510 Hz
<b>Input Power (System)</b>	120Vac, 60Hz	<b>Environmental Conditions</b>	25°C, 68% RH
<b>Tested By</b>	Tom Yang		

**Antenna Polarity & Test Distance : Horizontal at 3 m**

No	Frequency (MHz)	Emission Level (dBuV/m)	Limit (dBuV/m)	Margin (dB)	Antenna Height (m)	Table Angle (Degree)	Raw Value (dBuV)	Correction Factor (dB/m)
1	12290.00	43.9 PK	74.0	-30.1	2.16 H	343	33.8	10.1
2	12290.00	31.1 AV	54.0	-22.9	2.16 H	343	21.0	10.1
3	18435.00	43.3 PK	74.0	-30.7	1.75 H	52	50.5	-7.2
4	18435.00	32.5 AV	54.0	-21.5	1.75 H	52	39.7	-7.2
5	#24580.00	43.9 PK	88.2	-44.3	2.74 H	200	45.8	-1.9
6	#24580.00	33.7 AV	68.2	-34.5	2.74 H	200	35.6	-1.9

**Antenna Polarity & Test Distance : Vertical at 3 m**

No	Frequency (MHz)	Emission Level (dBuV/m)	Limit (dBuV/m)	Margin (dB)	Antenna Height (m)	Table Angle (Degree)	Raw Value (dBuV)	Correction Factor (dB/m)
1	12290.00	44.0 PK	74.0	-30.0	1.32 V	118	33.9	10.1
2	12290.00	31.0 AV	54.0	-23.0	1.32 V	118	20.9	10.1
3	18435.00	43.7 PK	74.0	-30.3	1.69 V	275	50.9	-7.2
4	18435.00	31.8 AV	54.0	-22.2	1.69 V	275	39.0	-7.2
5	#24580.00	44.0 PK	88.2	-44.2	2.16 V	323	45.9	-1.9
6	#24580.00	33.3 AV	68.2	-34.9	2.16 V	323	35.2	-1.9

**Remarks:**

1. Emission Level(dBuV/m) = Raw Value(dBuV) + Correction Factor(dB/m)
2. Correction Factor(dB/m) = Antenna Factor(dB/m) + Cable Factor(dB) – Pre-Amplifier Factor(dB)
3. Margin value = Emission Level – Limit value
4. The other emission levels were very low against the limit.
5. " # ": The radiated frequency is out of the restricted band.

<b>RF Mode</b>	TX 802.11be (EHT80)	<b>Channel</b>	CH 87 : 6385 MHz
<b>Frequency Range</b>	1 GHz ~ 40 GHz	<b>Detector Function &amp; Bandwidth</b>	(PK) RB = 1 MHz, VB = 3 MHz (AV) RB = 1 MHz, VB = 510 Hz
<b>Input Power (System)</b>	120Vac, 60Hz	<b>Environmental Conditions</b>	25°C, 68% RH
<b>Tested By</b>	Tom Yang		

**Antenna Polarity & Test Distance : Horizontal at 3 m**

No	Frequency (MHz)	Emission Level (dBuV/m)	Limit (dBuV/m)	Margin (dB)	Antenna Height (m)	Table Angle (Degree)	Raw Value (dBuV)	Correction Factor (dB/m)
1	#12770.00	43.5 PK	88.2	-44.7	2.24 H	312	33.1	10.4
2	#12770.00	30.9 AV	68.2	-37.3	2.24 H	312	20.5	10.4
3	19155.00	44.3 PK	74.0	-29.7	1.56 H	97	50.7	-6.4
4	19155.00	32.5 AV	54.0	-21.5	1.56 H	97	38.9	-6.4
5	#25540.00	43.5 PK	88.2	-44.7	2.66 H	218	44.9	-1.4
6	#25540.00	33.0 AV	68.2	-35.2	2.66 H	218	34.4	-1.4

**Antenna Polarity & Test Distance : Vertical at 3 m**

No	Frequency (MHz)	Emission Level (dBuV/m)	Limit (dBuV/m)	Margin (dB)	Antenna Height (m)	Table Angle (Degree)	Raw Value (dBuV)	Correction Factor (dB/m)
1	#12770.00	43.4 PK	88.2	-44.8	1.20 V	123	33.0	10.4
2	#12770.00	29.7 AV	68.2	-38.5	1.20 V	123	19.3	10.4
3	19155.00	43.6 PK	74.0	-30.4	1.57 V	227	50.0	-6.4
4	19155.00	33.2 AV	54.0	-20.8	1.57 V	227	39.6	-6.4
5	#25540.00	43.6 PK	88.2	-44.6	1.88 V	341	45.0	-1.4
6	#25540.00	33.4 AV	68.2	-34.8	1.88 V	341	34.8	-1.4

**Remarks:**

1. Emission Level(dBuV/m) = Raw Value(dBuV) + Correction Factor(dB/m)
2. Correction Factor(dB/m) = Antenna Factor(dB/m) + Cable Factor(dB) – Pre-Amplifier Factor(dB)
3. Margin value = Emission Level – Limit value
4. The other emission levels were very low against the limit.
5. "#": The radiated frequency is out of the restricted band.

<b>RF Mode</b>	TX 802.11be (EHT80)	<b>Channel</b>	CH 103 : 6465 MHz
<b>Frequency Range</b>	1 GHz ~ 40 GHz	<b>Detector Function &amp; Bandwidth</b>	(PK) RB = 1 MHz, VB = 3 MHz (AV) RB = 1 MHz, VB = 510 Hz
<b>Input Power (System)</b>	120Vac, 60Hz	<b>Environmental Conditions</b>	25°C, 68% RH
<b>Tested By</b>	Tom Yang		

**Antenna Polarity & Test Distance : Horizontal at 3 m**

No	Frequency (MHz)	Emission Level (dBuV/m)	Limit (dBuV/m)	Margin (dB)	Antenna Height (m)	Table Angle (Degree)	Raw Value (dBuV)	Correction Factor (dB/m)
1	#12930.00	43.6 PK	88.2	-44.6	2.27 H	350	33.1	10.5
2	#12930.00	30.9 AV	68.2	-37.3	2.27 H	350	20.4	10.5
3	19395.00	43.3 PK	74.0	-30.7	1.55 H	110	50.0	-6.7
4	19395.00	31.7 AV	54.0	-22.3	1.55 H	110	38.4	-6.7
5	#25860.00	44.2 PK	88.2	-44.0	2.59 H	188	45.3	-1.1
6	#25860.00	34.5 AV	68.2	-33.7	2.59 H	188	35.6	-1.1

**Antenna Polarity & Test Distance : Vertical at 3 m**

No	Frequency (MHz)	Emission Level (dBuV/m)	Limit (dBuV/m)	Margin (dB)	Antenna Height (m)	Table Angle (Degree)	Raw Value (dBuV)	Correction Factor (dB/m)
1	#12930.00	44.1 PK	88.2	-44.1	1.23 V	135	33.6	10.5
2	#12930.00	30.8 AV	68.2	-37.4	1.23 V	135	20.3	10.5
3	19395.00	43.4 PK	74.0	-30.6	1.60 V	237	50.1	-6.7
4	19395.00	31.2 AV	54.0	-22.8	1.60 V	237	37.9	-6.7
5	#25860.00	44.7 PK	88.2	-43.5	2.15 V	309	45.8	-1.1
6	#25860.00	33.4 AV	68.2	-34.8	2.15 V	309	34.5	-1.1

**Remarks:**

1. Emission Level(dBuV/m) = Raw Value(dBuV) + Correction Factor(dB/m)
2. Correction Factor(dB/m) = Antenna Factor(dB/m) + Cable Factor(dB) – Pre-Amplifier Factor(dB)
3. Margin value = Emission Level – Limit value
4. The other emission levels were very low against the limit.
5. "#": The radiated frequency is out of the restricted band.

<b>RF Mode</b>	TX 802.11be (EHT80)	<b>Channel</b>	CH 119 : 6545 MHz
<b>Frequency Range</b>	1 GHz ~ 40 GHz	<b>Detector Function &amp; Bandwidth</b>	(PK) RB = 1 MHz, VB = 3 MHz (AV) RB = 1 MHz, VB = 510 Hz
<b>Input Power (System)</b>	120Vac, 60Hz	<b>Environmental Conditions</b>	25°C, 68% RH
<b>Tested By</b>	Tom Yang		

**Antenna Polarity & Test Distance : Horizontal at 3 m**

No	Frequency (MHz)	Emission Level (dBuV/m)	Limit (dBuV/m)	Margin (dB)	Antenna Height (m)	Table Angle (Degree)	Raw Value (dBuV)	Correction Factor (dB/m)
1	#13090.00	42.6 PK	88.2	-45.6	2.13 H	328	31.6	11.0
2	#13090.00	29.8 AV	68.2	-38.4	2.13 H	328	18.8	11.0
3	19635.00	43.2 PK	74.0	-30.8	1.70 H	87	49.2	-6.0
4	19635.00	32.1 AV	54.0	-21.9	1.70 H	87	38.1	-6.0
5	#26180.00	44.7 PK	88.2	-43.5	2.66 H	190	45.7	-1.0
6	#26180.00	34.9 AV	68.2	-33.3	2.66 H	190	35.9	-1.0

**Antenna Polarity & Test Distance : Vertical at 3 m**

No	Frequency (MHz)	Emission Level (dBuV/m)	Limit (dBuV/m)	Margin (dB)	Antenna Height (m)	Table Angle (Degree)	Raw Value (dBuV)	Correction Factor (dB/m)
1	#13090.00	44.2 PK	88.2	-44.0	1.24 V	132	33.2	11.0
2	#13090.00	31.0 AV	68.2	-37.2	1.24 V	132	20.0	11.0
3	19635.00	43.6 PK	74.0	-30.4	1.55 V	240	49.6	-6.0
4	19635.00	31.3 AV	54.0	-22.7	1.55 V	240	37.3	-6.0
5	#26180.00	44.6 PK	88.2	-43.6	2.11 V	310	45.6	-1.0
6	#26180.00	33.0 AV	68.2	-35.2	2.11 V	310	34.0	-1.0

**Remarks:**

1. Emission Level(dBuV/m) = Raw Value(dBuV) + Correction Factor(dB/m)
2. Correction Factor(dB/m) = Antenna Factor(dB/m) + Cable Factor(dB) – Pre-Amplifier Factor(dB)
3. Margin value = Emission Level – Limit value
4. The other emission levels were very low against the limit.
5. " # ": The radiated frequency is out of the restricted band.

<b>RF Mode</b>	TX 802.11be (EHT80)	<b>Channel</b>	CH 135 : 6625 MHz
<b>Frequency Range</b>	1 GHz ~ 40 GHz	<b>Detector Function &amp; Bandwidth</b>	(PK) RB = 1 MHz, VB = 3 MHz (AV) RB = 1 MHz, VB = 510 Hz
<b>Input Power (System)</b>	120Vac, 60Hz	<b>Environmental Conditions</b>	25°C, 68% RH
<b>Tested By</b>	Tom Yang		

**Antenna Polarity & Test Distance : Horizontal at 3 m**

No	Frequency (MHz)	Emission Level (dBuV/m)	Limit (dBuV/m)	Margin (dB)	Antenna Height (m)	Table Angle (Degree)	Raw Value (dBuV)	Correction Factor (dB/m)
1	13250.00	43.9 PK	74.0	-30.1	2.23 H	335	32.4	11.5
2	13250.00	30.9 AV	54.0	-23.1	2.23 H	335	19.4	11.5
3	19875.00	43.5 PK	74.0	-30.5	1.68 H	57	49.5	-6.0
4	19875.00	31.6 AV	54.0	-22.4	1.68 H	57	37.6	-6.0
5	#26500.00	43.2 PK	88.2	-45.0	2.74 H	199	44.0	-0.8
6	#26500.00	32.9 AV	68.2	-35.3	2.74 H	199	33.7	-0.8

**Antenna Polarity & Test Distance : Vertical at 3 m**

No	Frequency (MHz)	Emission Level (dBuV/m)	Limit (dBuV/m)	Margin (dB)	Antenna Height (m)	Table Angle (Degree)	Raw Value (dBuV)	Correction Factor (dB/m)
1	13250.00	43.8 PK	74.0	-30.2	1.37 V	128	32.3	11.5
2	13250.00	30.7 AV	54.0	-23.3	1.37 V	128	19.2	11.5
3	19875.00	43.7 PK	74.0	-30.3	1.71 V	285	49.7	-6.0
4	19875.00	31.6 AV	54.0	-22.4	1.71 V	285	37.6	-6.0
5	#26500.00	43.4 PK	88.2	-44.8	2.14 V	326	44.2	-0.8
6	#26500.00	32.9 AV	68.2	-35.3	2.14 V	326	33.7	-0.8

**Remarks:**

1. Emission Level(dBuV/m) = Raw Value(dBuV) + Correction Factor(dB/m)
2. Correction Factor(dB/m) = Antenna Factor(dB/m) + Cable Factor(dB) – Pre-Amplifier Factor(dB)
3. Margin value = Emission Level – Limit value
4. The other emission levels were very low against the limit.
5. "#": The radiated frequency is out of the restricted band.



<b>RF Mode</b>	TX 802.11be (EHT80)	<b>Channel</b>	CH 151 : 6705 MHz
<b>Frequency Range</b>	1 GHz ~ 40 GHz	<b>Detector Function &amp; Bandwidth</b>	(PK) RB = 1 MHz, VB = 3 MHz (AV) RB = 1 MHz, VB = 510 Hz
<b>Input Power (System)</b>	120Vac, 60Hz	<b>Environmental Conditions</b>	25°C, 68% RH
<b>Tested By</b>	Tom Yang		

**Antenna Polarity & Test Distance : Horizontal at 3 m**

No	Frequency (MHz)	Emission Level (dBuV/m)	Limit (dBuV/m)	Margin (dB)	Antenna Height (m)	Table Angle (Degree)	Raw Value (dBuV)	Correction Factor (dB/m)
1	#13410.00	43.9 PK	88.2	-44.3	2.13 H	355	31.9	12.0
2	#13410.00	30.9 AV	68.2	-37.3	2.13 H	355	18.9	12.0
3	20115.00	43.5 PK	74.0	-30.5	1.76 H	43	49.0	-5.5
4	20115.00	32.8 AV	54.0	-21.2	1.76 H	43	38.3	-5.5
5	#26820.00	44.2 PK	88.2	-44.0	2.73 H	211	45.0	-0.8
6	#26820.00	33.8 AV	68.2	-34.4	2.73 H	211	34.6	-0.8

**Antenna Polarity & Test Distance : Vertical at 3 m**

No	Frequency (MHz)	Emission Level (dBuV/m)	Limit (dBuV/m)	Margin (dB)	Antenna Height (m)	Table Angle (Degree)	Raw Value (dBuV)	Correction Factor (dB/m)
1	#13410.00	43.4 PK	88.2	-44.8	1.15 V	109	31.4	12.0
2	#13410.00	29.4 AV	68.2	-38.8	1.15 V	109	17.4	12.0
3	20115.00	44.0 PK	74.0	-30.0	1.63 V	217	49.5	-5.5
4	20115.00	32.6 AV	54.0	-21.4	1.63 V	217	38.1	-5.5
5	#26820.00	43.2 PK	88.2	-45.0	1.91 V	356	44.0	-0.8
6	#26820.00	34.0 AV	68.2	-34.2	1.91 V	356	34.8	-0.8

**Remarks:**

1. Emission Level(dBuV/m) = Raw Value(dBuV) + Correction Factor(dB/m)
2. Correction Factor(dB/m) = Antenna Factor(dB/m) + Cable Factor(dB) – Pre-Amplifier Factor(dB)
3. Margin value = Emission Level – Limit value
4. The other emission levels were very low against the limit.
5. " # ": The radiated frequency is out of the restricted band.

<b>RF Mode</b>	TX 802.11be (EHT80)	<b>Channel</b>	CH 167 : 6785 MHz
<b>Frequency Range</b>	1 GHz ~ 40 GHz	<b>Detector Function &amp; Bandwidth</b>	(PK) RB = 1 MHz, VB = 3 MHz (AV) RB = 1 MHz, VB = 510 Hz
<b>Input Power (System)</b>	120Vac, 60Hz	<b>Environmental Conditions</b>	25°C, 68% RH
<b>Tested By</b>	Tom Yang		

**Antenna Polarity & Test Distance : Horizontal at 3 m**

No	Frequency (MHz)	Emission Level (dBuV/m)	Limit (dBuV/m)	Margin (dB)	Antenna Height (m)	Table Angle (Degree)	Raw Value (dBuV)	Correction Factor (dB/m)
1	#13570.00	43.7 PK	88.2	-44.5	2.19 H	358	31.0	12.7
2	#13570.00	30.8 AV	68.2	-37.4	2.19 H	358	18.1	12.7
3	20355.00	43.4 PK	74.0	-30.6	1.77 H	66	48.7	-5.3
4	20355.00	32.6 AV	54.0	-21.4	1.77 H	66	37.9	-5.3
5	#27140.00	43.7 PK	88.2	-44.5	2.75 H	189	44.7	-1.0
6	#27140.00	33.8 AV	68.2	-34.4	2.75 H	189	34.8	-1.0

**Antenna Polarity & Test Distance : Vertical at 3 m**

No	Frequency (MHz)	Emission Level (dBuV/m)	Limit (dBuV/m)	Margin (dB)	Antenna Height (m)	Table Angle (Degree)	Raw Value (dBuV)	Correction Factor (dB/m)
1	#13570.00	43.8 PK	88.2	-44.4	1.35 V	139	31.1	12.7
2	#13570.00	30.8 AV	68.2	-37.4	1.35 V	139	18.1	12.7
3	20355.00	43.8 PK	74.0	-30.2	1.68 V	274	49.1	-5.3
4	20355.00	31.5 AV	54.0	-22.5	1.68 V	274	36.8	-5.3
5	#27140.00	43.8 PK	88.2	-44.4	2.11 V	329	44.8	-1.0
6	#27140.00	33.1 AV	68.2	-35.1	2.11 V	329	34.1	-1.0

**Remarks:**

1. Emission Level(dBuV/m) = Raw Value(dBuV) + Correction Factor(dB/m)
2. Correction Factor(dB/m) = Antenna Factor(dB/m) + Cable Factor(dB) – Pre-Amplifier Factor(dB)
3. Margin value = Emission Level – Limit value
4. The other emission levels were very low against the limit.
5. "#": The radiated frequency is out of the restricted band.

<b>RF Mode</b>	TX 802.11be (EHT80)	<b>Channel</b>	CH 183 : 6865 MHz
<b>Frequency Range</b>	1 GHz ~ 40 GHz	<b>Detector Function &amp; Bandwidth</b>	(PK) RB = 1 MHz, VB = 3 MHz (AV) RB = 1 MHz, VB = 510 Hz
<b>Input Power (System)</b>	120Vac, 60Hz	<b>Environmental Conditions</b>	25°C, 68% RH
<b>Tested By</b>	Tom Yang		

**Antenna Polarity & Test Distance : Horizontal at 3 m**

No	Frequency (MHz)	Emission Level (dBuV/m)	Limit (dBuV/m)	Margin (dB)	Antenna Height (m)	Table Angle (Degree)	Raw Value (dBuV)	Correction Factor (dB/m)
1	#13730.00	43.9 PK	88.2	-44.3	2.21 H	330	31.0	12.9
2	#13730.00	31.1 AV	68.2	-37.1	2.21 H	330	18.2	12.9
3	20595.00	43.8 PK	74.0	-30.2	1.70 H	68	48.5	-4.7
4	20595.00	32.0 AV	54.0	-22.0	1.70 H	68	36.7	-4.7
5	#27460.00	42.9 PK	88.2	-45.3	2.74 H	207	43.8	-0.9
6	#27460.00	32.7 AV	68.2	-35.5	2.74 H	207	33.6	-0.9

**Antenna Polarity & Test Distance : Vertical at 3 m**

No	Frequency (MHz)	Emission Level (dBuV/m)	Limit (dBuV/m)	Margin (dB)	Antenna Height (m)	Table Angle (Degree)	Raw Value (dBuV)	Correction Factor (dB/m)
1	#13730.00	43.8 PK	88.2	-44.4	1.38 V	140	30.9	12.9
2	#13730.00	30.6 AV	68.2	-37.6	1.38 V	140	17.7	12.9
3	20595.00	44.0 PK	74.0	-30.0	1.75 V	297	48.7	-4.7
4	20595.00	31.9 AV	54.0	-22.1	1.75 V	297	36.6	-4.7
5	#27460.00	44.1 PK	88.2	-44.1	2.19 V	315	45.0	-0.9
6	#27460.00	33.3 AV	68.2	-34.9	2.19 V	315	34.2	-0.9

**Remarks:**

1. Emission Level(dBuV/m) = Raw Value(dBuV) + Correction Factor(dB/m)
2. Correction Factor(dB/m) = Antenna Factor(dB/m) + Cable Factor(dB) – Pre-Amplifier Factor(dB)
3. Margin value = Emission Level – Limit value
4. The other emission levels were very low against the limit.
5. "#": The radiated frequency is out of the restricted band.

<b>RF Mode</b>	TX 802.11be (EHT80)	<b>Channel</b>	CH 199 : 6945 MHz
<b>Frequency Range</b>	1 GHz ~ 40 GHz	<b>Detector Function &amp; Bandwidth</b>	(PK) RB = 1 MHz, VB = 3 MHz (AV) RB = 1 MHz, VB = 510 Hz
<b>Input Power (System)</b>	120Vac, 60Hz	<b>Environmental Conditions</b>	25°C, 68% RH
<b>Tested By</b>	Tom Yang		

**Antenna Polarity & Test Distance : Horizontal at 3 m**

No	Frequency (MHz)	Emission Level (dBuV/m)	Limit (dBuV/m)	Margin (dB)	Antenna Height (m)	Table Angle (Degree)	Raw Value (dBuV)	Correction Factor (dB/m)
1	#13890.00	42.8 PK	88.2	-45.4	2.21 H	360	29.8	13.0
2	#13890.00	30.2 AV	68.2	-38.0	2.21 H	360	17.2	13.0
3	20835.00	43.8 PK	74.0	-30.2	1.62 H	68	48.2	-4.4
4	20835.00	31.9 AV	54.0	-22.1	1.62 H	68	36.3	-4.4
5	#27780.00	44.0 PK	88.2	-44.2	2.66 H	210	45.2	-1.2
6	#27780.00	33.8 AV	68.2	-34.4	2.66 H	210	35.0	-1.2

**Antenna Polarity & Test Distance : Vertical at 3 m**

No	Frequency (MHz)	Emission Level (dBuV/m)	Limit (dBuV/m)	Margin (dB)	Antenna Height (m)	Table Angle (Degree)	Raw Value (dBuV)	Correction Factor (dB/m)
1	#13890.00	43.7 PK	88.2	-44.5	1.33 V	128	30.7	13.0
2	#13890.00	30.7 AV	68.2	-37.5	1.33 V	128	17.7	13.0
3	20835.00	43.6 PK	74.0	-30.4	1.69 V	282	48.0	-4.4
4	20835.00	31.3 AV	54.0	-22.7	1.69 V	282	35.7	-4.4
5	#27780.00	43.5 PK	88.2	-44.7	2.18 V	328	44.7	-1.2
6	#27780.00	33.2 AV	68.2	-35.0	2.18 V	328	34.4	-1.2

**Remarks:**

1. Emission Level(dBuV/m) = Raw Value(dBuV) + Correction Factor(dB/m)
2. Correction Factor(dB/m) = Antenna Factor(dB/m) + Cable Factor(dB) – Pre-Amplifier Factor(dB)
3. Margin value = Emission Level – Limit value
4. The other emission levels were very low against the limit.
5. "#": The radiated frequency is out of the restricted band.

<b>RF Mode</b>	TX 802.11be (EHT80)	<b>Channel</b>	CH 215 : 7025 MHz
<b>Frequency Range</b>	1 GHz ~ 40 GHz	<b>Detector Function &amp; Bandwidth</b>	(PK) RB = 1 MHz, VB = 3 MHz (AV) RB = 1 MHz, VB = 510 Hz
<b>Input Power (System)</b>	120Vac, 60Hz	<b>Environmental Conditions</b>	25°C, 68% RH
<b>Tested By</b>	Tom Yang		

**Antenna Polarity & Test Distance : Horizontal at 3 m**

No	Frequency (MHz)	Emission Level (dBuV/m)	Limit (dBuV/m)	Margin (dB)	Antenna Height (m)	Table Angle (Degree)	Raw Value (dBuV)	Correction Factor (dB/m)
1	#14050.00	44.2 PK	88.2	-44.0	2.15 H	342	31.0	13.2
2	#14050.00	31.0 AV	68.2	-37.2	2.15 H	342	17.8	13.2
3	21075.00	42.9 PK	74.0	-31.1	1.81 H	77	47.0	-4.1
4	21075.00	32.4 AV	54.0	-21.6	1.81 H	77	36.5	-4.1
5	#28100.00	43.8 PK	88.2	-44.4	2.76 H	199	45.0	-1.2
6	#28100.00	34.1 AV	68.2	-34.1	2.76 H	199	35.3	-1.2

**Antenna Polarity & Test Distance : Vertical at 3 m**

No	Frequency (MHz)	Emission Level (dBuV/m)	Limit (dBuV/m)	Margin (dB)	Antenna Height (m)	Table Angle (Degree)	Raw Value (dBuV)	Correction Factor (dB/m)
1	#14050.00	43.1 PK	88.2	-45.1	1.18 V	120	29.9	13.2
2	#14050.00	29.1 AV	68.2	-39.1	1.18 V	120	15.9	13.2
3	21075.00	44.4 PK	74.0	-29.6	1.59 V	203	48.5	-4.1
4	21075.00	33.1 AV	54.0	-20.9	1.59 V	203	37.2	-4.1
5	#28100.00	43.8 PK	88.2	-44.4	1.94 V	360	45.0	-1.2
6	#28100.00	34.4 AV	68.2	-33.8	1.94 V	360	35.6	-1.2

**Remarks:**

1. Emission Level(dBuV/m) = Raw Value(dBuV) + Correction Factor(dB/m)
2. Correction Factor(dB/m) = Antenna Factor(dB/m) + Cable Factor(dB) – Pre-Amplifier Factor(dB)
3. Margin value = Emission Level – Limit value
4. The other emission levels were very low against the limit.
5. "#": The radiated frequency is out of the restricted band.

<b>RF Mode</b>	TX 802.11be (EHT160)	<b>Channel</b>	CH 15 : 6025 MHz
<b>Frequency Range</b>	1 GHz ~ 40 GHz	<b>Detector Function &amp; Bandwidth</b>	(PK) RB = 1 MHz, VB = 3 MHz (AV) RB = 1 MHz, VB = 1 kHz
<b>Input Power (System)</b>	120Vac, 60Hz	<b>Environmental Conditions</b>	25°C, 68% RH
<b>Tested By</b>	Tom Yang		

**Antenna Polarity & Test Distance : Horizontal at 3 m**

No	Frequency (MHz)	Emission Level (dBuV/m)	Limit (dBuV/m)	Margin (dB)	Antenna Height (m)	Table Angle (Degree)	Raw Value (dBuV)	Correction Factor (dB/m)
1	12050.00	42.9 PK	74.0	-31.1	2.25 H	331	32.0	10.9
2	12050.00	30.2 AV	54.0	-23.8	2.25 H	331	19.3	10.9
3	18075.00	43.9 PK	74.0	-30.1	1.76 H	76	38.1	5.8
4	18075.00	32.3 AV	54.0	-21.7	1.76 H	76	26.5	5.8
5	#24100.00	44.0 PK	88.2	-44.2	2.69 H	206	46.2	-2.2
6	#24100.00	33.7 AV	68.2	-34.5	2.69 H	206	35.9	-2.2

**Antenna Polarity & Test Distance : Vertical at 3 m**

No	Frequency (MHz)	Emission Level (dBuV/m)	Limit (dBuV/m)	Margin (dB)	Antenna Height (m)	Table Angle (Degree)	Raw Value (dBuV)	Correction Factor (dB/m)
1	12050.00	43.7 PK	74.0	-30.3	1.20 V	120	32.8	10.9
2	12050.00	30.7 AV	54.0	-23.3	1.20 V	120	19.8	10.9
3	18075.00	43.3 PK	74.0	-30.7	1.61 V	227	37.5	5.8
4	18075.00	31.1 AV	54.0	-22.9	1.61 V	227	25.3	5.8
5	#24100.00	44.2 PK	88.2	-44.0	2.06 V	311	46.4	-2.2
6	#24100.00	32.8 AV	68.2	-35.4	2.06 V	311	35.0	-2.2

**Remarks:**

1. Emission Level(dBuV/m) = Raw Value(dBuV) + Correction Factor(dB/m)
2. Correction Factor(dB/m) = Antenna Factor(dB/m) + Cable Factor(dB) – Pre-Amplifier Factor(dB)
3. Margin value = Emission Level – Limit value
4. The other emission levels were very low against the limit.
5. " # ": The radiated frequency is out of the restricted band.

<b>RF Mode</b>	TX 802.11be (EHT160)	<b>Channel</b>	CH 47 : 6185 MHz
<b>Frequency Range</b>	1 GHz ~ 40 GHz	<b>Detector Function &amp; Bandwidth</b>	(PK) RB = 1 MHz, VB = 3 MHz (AV) RB = 1 MHz, VB = 1 kHz
<b>Input Power (System)</b>	120Vac, 60Hz	<b>Environmental Conditions</b>	25°C, 68% RH
<b>Tested By</b>	Tom Yang		

**Antenna Polarity & Test Distance : Horizontal at 3 m**

No	Frequency (MHz)	Emission Level (dBuV/m)	Limit (dBuV/m)	Margin (dB)	Antenna Height (m)	Table Angle (Degree)	Raw Value (dBuV)	Correction Factor (dB/m)
1	12370.00	44.1 PK	74.0	-29.9	2.18 H	340	34.1	10.0
2	12370.00	31.0 AV	54.0	-23.0	2.18 H	340	21.0	10.0
3	18555.00	42.3 PK	74.0	-31.7	1.77 H	72	49.3	-7.0
4	18555.00	32.0 AV	54.0	-22.0	1.77 H	72	39.0	-7.0
5	#24740.00	43.6 PK	88.2	-44.6	2.74 H	189	45.1	-1.5
6	#24740.00	33.9 AV	68.2	-34.3	2.74 H	189	35.4	-1.5

**Antenna Polarity & Test Distance : Vertical at 3 m**

No	Frequency (MHz)	Emission Level (dBuV/m)	Limit (dBuV/m)	Margin (dB)	Antenna Height (m)	Table Angle (Degree)	Raw Value (dBuV)	Correction Factor (dB/m)
1	12370.00	44.2 PK	74.0	-29.8	1.23 V	146	34.2	10.0
2	12370.00	31.3 AV	54.0	-22.7	1.23 V	146	21.3	10.0
3	18555.00	43.6 PK	74.0	-30.4	1.53 V	239	50.6	-7.0
4	18555.00	31.0 AV	54.0	-23.0	1.53 V	239	38.0	-7.0
5	#24740.00	44.7 PK	88.2	-43.5	2.16 V	298	46.2	-1.5
6	#24740.00	33.1 AV	68.2	-35.1	2.16 V	298	34.6	-1.5

**Remarks:**

1. Emission Level(dBuV/m) = Raw Value(dBuV) + Correction Factor(dB/m)
2. Correction Factor(dB/m) = Antenna Factor(dB/m) + Cable Factor(dB) – Pre-Amplifier Factor(dB)
3. Margin value = Emission Level – Limit value
4. The other emission levels were very low against the limit.
5. "#": The radiated frequency is out of the restricted band.

<b>RF Mode</b>	TX 802.11be (EHT160)	<b>Channel</b>	CH 79 : 6345 MHz
<b>Frequency Range</b>	1 GHz ~ 40 GHz	<b>Detector Function &amp; Bandwidth</b>	(PK) RB = 1 MHz, VB = 3 MHz (AV) RB = 1 MHz, VB = 1 kHz
<b>Input Power (System)</b>	120Vac, 60Hz	<b>Environmental Conditions</b>	25°C, 68% RH
<b>Tested By</b>	Tom Yang		

**Antenna Polarity & Test Distance : Horizontal at 3 m**

No	Frequency (MHz)	Emission Level (dBuV/m)	Limit (dBuV/m)	Margin (dB)	Antenna Height (m)	Table Angle (Degree)	Raw Value (dBuV)	Correction Factor (dB/m)
1	12690.00	43.7 PK	74.0	-30.3	2.12 H	360	33.4	10.3
2	12690.00	30.9 AV	54.0	-23.1	2.12 H	360	20.6	10.3
3	19035.00	43.6 PK	74.0	-30.4	1.71 H	55	50.2	-6.6
4	19035.00	32.6 AV	54.0	-21.4	1.71 H	55	39.2	-6.6
5	#25380.00	43.9 PK	88.2	-44.3	2.76 H	208	45.3	-1.4
6	#25380.00	33.4 AV	68.2	-34.8	2.76 H	208	34.8	-1.4

**Antenna Polarity & Test Distance : Vertical at 3 m**

No	Frequency (MHz)	Emission Level (dBuV/m)	Limit (dBuV/m)	Margin (dB)	Antenna Height (m)	Table Angle (Degree)	Raw Value (dBuV)	Correction Factor (dB/m)
1	12690.00	43.3 PK	74.0	-30.7	1.21 V	133	33.0	10.3
2	12690.00	29.3 AV	54.0	-24.7	1.21 V	133	19.0	10.3
3	19035.00	44.5 PK	74.0	-29.5	1.59 V	200	51.1	-6.6
4	19035.00	33.3 AV	54.0	-20.7	1.59 V	200	39.9	-6.6
5	#25380.00	44.3 PK	88.2	-43.9	1.97 V	360	45.7	-1.4
6	#25380.00	34.6 AV	68.2	-33.6	1.97 V	360	36.0	-1.4

**Remarks:**

1. Emission Level(dBuV/m) = Raw Value(dBuV) + Correction Factor(dB/m)
2. Correction Factor(dB/m) = Antenna Factor(dB/m) + Cable Factor(dB) – Pre-Amplifier Factor(dB)
3. Margin value = Emission Level – Limit value
4. The other emission levels were very low against the limit.
5. "#": The radiated frequency is out of the restricted band.



<b>RF Mode</b>	TX 802.11be (EHT160)	<b>Channel</b>	CH 111 : 6505 MHz
<b>Frequency Range</b>	1 GHz ~ 40 GHz	<b>Detector Function &amp; Bandwidth</b>	(PK) RB = 1 MHz, VB = 3 MHz (AV) RB = 1 MHz, VB = 1 kHz
<b>Input Power (System)</b>	120Vac, 60Hz	<b>Environmental Conditions</b>	25°C, 68% RH
<b>Tested By</b>	Tom Yang		

**Antenna Polarity & Test Distance : Horizontal at 3 m**

No	Frequency (MHz)	Emission Level (dBuV/m)	Limit (dBuV/m)	Margin (dB)	Antenna Height (m)	Table Angle (Degree)	Raw Value (dBuV)	Correction Factor (dB/m)
1	#13010.00	42.1 PK	88.2	-46.1	2.38 H	347	31.5	10.6
2	#13010.00	29.4 AV	68.2	-38.8	2.38 H	347	18.8	10.6
3	19515.00	44.5 PK	74.0	-29.5	1.66 H	126	50.7	-6.2
4	19515.00	33.1 AV	54.0	-20.9	1.66 H	126	39.3	-6.2
5	#26020.00	42.5 PK	88.2	-45.7	2.67 H	190	43.5	-1.0
6	#26020.00	33.4 AV	68.2	-34.8	2.67 H	190	34.4	-1.0

**Antenna Polarity & Test Distance : Vertical at 3 m**

No	Frequency (MHz)	Emission Level (dBuV/m)	Limit (dBuV/m)	Margin (dB)	Antenna Height (m)	Table Angle (Degree)	Raw Value (dBuV)	Correction Factor (dB/m)
1	#13010.00	44.2 PK	88.2	-44.0	1.35 V	138	33.6	10.6
2	#13010.00	31.1 AV	68.2	-37.1	1.35 V	138	20.5	10.6
3	19515.00	43.7 PK	74.0	-30.3	1.68 V	273	49.9	-6.2
4	19515.00	31.5 AV	54.0	-22.5	1.68 V	273	37.7	-6.2
5	#26020.00	43.1 PK	88.2	-45.1	2.16 V	332	44.1	-1.0
6	#26020.00	32.8 AV	68.2	-35.4	2.16 V	332	33.8	-1.0

**Remarks:**

1. Emission Level(dBuV/m) = Raw Value(dBuV) + Correction Factor(dB/m)
2. Correction Factor(dB/m) = Antenna Factor(dB/m) + Cable Factor(dB) – Pre-Amplifier Factor(dB)
3. Margin value = Emission Level – Limit value
4. The other emission levels were very low against the limit.
5. " # ": The radiated frequency is out of the restricted band.

<b>RF Mode</b>	TX 802.11be (EHT160)	<b>Channel</b>	CH 143 : 6665 MHz
<b>Frequency Range</b>	1 GHz ~ 40 GHz	<b>Detector Function &amp; Bandwidth</b>	(PK) RB = 1 MHz, VB = 3 MHz (AV) RB = 1 MHz, VB = 1 kHz
<b>Input Power (System)</b>	120Vac, 60Hz	<b>Environmental Conditions</b>	25°C, 68% RH
<b>Tested By</b>	Tom Yang		

**Antenna Polarity & Test Distance : Horizontal at 3 m**

No	Frequency (MHz)	Emission Level (dBuV/m)	Limit (dBuV/m)	Margin (dB)	Antenna Height (m)	Table Angle (Degree)	Raw Value (dBuV)	Correction Factor (dB/m)
1	13330.00	42.7 PK	74.0	-31.3	2.28 H	345	31.0	11.7
2	13330.00	29.9 AV	54.0	-24.1	2.28 H	345	18.2	11.7
3	19995.00	44.1 PK	74.0	-29.9	1.75 H	61	49.7	-5.6
4	19995.00	32.4 AV	54.0	-21.6	1.75 H	61	38.0	-5.6
5	#26660.00	44.6 PK	88.2	-43.6	2.71 H	207	45.3	-0.7
6	#26660.00	34.1 AV	68.2	-34.1	2.71 H	207	34.8	-0.7

**Antenna Polarity & Test Distance : Vertical at 3 m**

No	Frequency (MHz)	Emission Level (dBuV/m)	Limit (dBuV/m)	Margin (dB)	Antenna Height (m)	Table Angle (Degree)	Raw Value (dBuV)	Correction Factor (dB/m)
1	13330.00	43.9 PK	74.0	-30.1	1.22 V	154	32.2	11.7
2	13330.00	30.9 AV	54.0	-23.1	1.22 V	154	19.2	11.7
3	19995.00	43.4 PK	74.0	-30.6	1.57 V	242	49.0	-5.6
4	19995.00	31.0 AV	54.0	-23.0	1.57 V	242	36.6	-5.6
5	#26660.00	45.2 PK	88.2	-43.0	2.17 V	289	45.9	-0.7
6	#26660.00	33.3 AV	68.2	-34.9	2.17 V	289	34.0	-0.7

**Remarks:**

1. Emission Level(dBuV/m) = Raw Value(dBuV) + Correction Factor(dB/m)
2. Correction Factor(dB/m) = Antenna Factor(dB/m) + Cable Factor(dB) – Pre-Amplifier Factor(dB)
3. Margin value = Emission Level – Limit value
4. The other emission levels were very low against the limit.
5. " # ": The radiated frequency is out of the restricted band.

<b>RF Mode</b>	TX 802.11be (EHT160)	<b>Channel</b>	CH 175 : 6825 MHz
<b>Frequency Range</b>	1 GHz ~ 40 GHz	<b>Detector Function &amp; Bandwidth</b>	(PK) RB = 1 MHz, VB = 3 MHz (AV) RB = 1 MHz, VB = 1 kHz
<b>Input Power (System)</b>	120Vac, 60Hz	<b>Environmental Conditions</b>	25°C, 68% RH
<b>Tested By</b>	Tom Yang		

**Antenna Polarity & Test Distance : Horizontal at 3 m**

No	Frequency (MHz)	Emission Level (dBuV/m)	Limit (dBuV/m)	Margin (dB)	Antenna Height (m)	Table Angle (Degree)	Raw Value (dBuV)	Correction Factor (dB/m)
1	#13650.00	43.9 PK	88.2	-44.3	2.21 H	325	31.0	12.9
2	#13650.00	30.7 AV	68.2	-37.5	2.21 H	325	17.8	12.9
3	20475.00	42.3 PK	74.0	-31.7	1.77 H	57	47.1	-4.8
4	20475.00	32.1 AV	54.0	-21.9	1.77 H	57	36.9	-4.8
5	#27300.00	43.8 PK	88.2	-44.4	2.70 H	192	44.8	-1.0
6	#27300.00	33.9 AV	68.2	-34.3	2.70 H	192	34.9	-1.0

**Antenna Polarity & Test Distance : Vertical at 3 m**

No	Frequency (MHz)	Emission Level (dBuV/m)	Limit (dBuV/m)	Margin (dB)	Antenna Height (m)	Table Angle (Degree)	Raw Value (dBuV)	Correction Factor (dB/m)
1	#13650.00	44.0 PK	88.2	-44.2	1.20 V	161	31.1	12.9
2	#13650.00	30.9 AV	68.2	-37.3	1.20 V	161	18.0	12.9
3	20475.00	43.6 PK	74.0	-30.4	1.58 V	246	48.4	-4.8
4	20475.00	31.3 AV	54.0	-22.7	1.58 V	246	36.1	-4.8
5	#27300.00	45.1 PK	88.2	-43.1	2.21 V	292	46.1	-1.0
6	#27300.00	33.2 AV	68.2	-35.0	2.21 V	292	34.2	-1.0

**Remarks:**

1. Emission Level(dBuV/m) = Raw Value(dBuV) + Correction Factor(dB/m)
2. Correction Factor(dB/m) = Antenna Factor(dB/m) + Cable Factor(dB) – Pre-Amplifier Factor(dB)
3. Margin value = Emission Level – Limit value
4. The other emission levels were very low against the limit.
5. "#": The radiated frequency is out of the restricted band.

<b>RF Mode</b>	TX 802.11be (EHT160)	<b>Channel</b>	CH 207 : 6985 MHz
<b>Frequency Range</b>	1 GHz ~ 40 GHz	<b>Detector Function &amp; Bandwidth</b>	(PK) RB = 1 MHz, VB = 3 MHz (AV) RB = 1 MHz, VB = 1 kHz
<b>Input Power (System)</b>	120Vac, 60Hz	<b>Environmental Conditions</b>	25°C, 68% RH
<b>Tested By</b>	Tom Yang		

**Antenna Polarity & Test Distance : Horizontal at 3 m**

No	Frequency (MHz)	Emission Level (dBuV/m)	Limit (dBuV/m)	Margin (dB)	Antenna Height (m)	Table Angle (Degree)	Raw Value (dBuV)	Correction Factor (dB/m)
1	#13970.00	42.7 PK	88.2	-45.5	2.34 H	357	29.6	13.1
2	#13970.00	29.7 AV	68.2	-38.5	2.34 H	357	16.6	13.1
3	20955.00	44.2 PK	74.0	-29.8	1.70 H	134	48.3	-4.1
4	20955.00	33.0 AV	54.0	-21.0	1.70 H	134	37.1	-4.1
5	#27940.00	42.2 PK	88.2	-46.0	2.69 H	199	43.3	-1.1
6	#27940.00	33.1 AV	68.2	-35.1	2.69 H	199	34.2	-1.1

**Antenna Polarity & Test Distance : Vertical at 3 m**

No	Frequency (MHz)	Emission Level (dBuV/m)	Limit (dBuV/m)	Margin (dB)	Antenna Height (m)	Table Angle (Degree)	Raw Value (dBuV)	Correction Factor (dB/m)
1	#13970.00	43.7 PK	88.2	-44.5	1.26 V	118	30.6	13.1
2	#13970.00	29.4 AV	68.2	-38.8	1.26 V	118	16.3	13.1
3	20955.00	44.4 PK	74.0	-29.6	1.61 V	203	48.5	-4.1
4	20955.00	33.4 AV	54.0	-20.6	1.61 V	203	37.5	-4.1
5	#27940.00	44.3 PK	88.2	-43.9	2.02 V	346	45.4	-1.1
6	#27940.00	34.8 AV	68.2	-33.4	2.02 V	346	35.9	-1.1

**Remarks:**

1. Emission Level(dBuV/m) = Raw Value(dBuV) + Correction Factor(dB/m)
2. Correction Factor(dB/m) = Antenna Factor(dB/m) + Cable Factor(dB) – Pre-Amplifier Factor(dB)
3. Margin value = Emission Level – Limit value
4. The other emission levels were very low against the limit.
5. "#": The radiated frequency is out of the restricted band.

<b>RF Mode</b>	TX 802.11be (EHT320)	<b>Channel</b>	CH 31 : 6105 MHz
<b>Frequency Range</b>	1 GHz ~ 40 GHz	<b>Detector Function &amp; Bandwidth</b>	(PK) RB = 1 MHz, VB = 3 MHz (AV) RB = 1 MHz, VB = 2 kHz
<b>Input Power (System)</b>	120Vac, 60Hz	<b>Environmental Conditions</b>	25°C, 68% RH
<b>Tested By</b>	Tom Yang		

**Antenna Polarity & Test Distance : Horizontal at 3 m**

No	Frequency (MHz)	Emission Level (dBuV/m)	Limit (dBuV/m)	Margin (dB)	Antenna Height (m)	Table Angle (Degree)	Raw Value (dBuV)	Correction Factor (dB/m)
1	12210.00	42.9 PK	74.0	-31.1	2.24 H	332	32.5	10.4
2	12210.00	30.4 AV	54.0	-23.6	2.24 H	332	20.0	10.4
3	18315.00	44.2 PK	74.0	-29.8	1.76 H	49	51.3	-7.1
4	18315.00	32.6 AV	54.0	-21.4	1.76 H	49	39.7	-7.1
5	#24420.00	44.5 PK	88.2	-43.7	2.74 H	206	46.3	-1.8
6	#24420.00	34.3 AV	68.2	-33.9	2.74 H	206	36.1	-1.8

**Antenna Polarity & Test Distance : Vertical at 3 m**

No	Frequency (MHz)	Emission Level (dBuV/m)	Limit (dBuV/m)	Margin (dB)	Antenna Height (m)	Table Angle (Degree)	Raw Value (dBuV)	Correction Factor (dB/m)
1	12210.00	43.7 PK	74.0	-30.3	1.23 V	138	33.3	10.4
2	12210.00	30.8 AV	54.0	-23.2	1.23 V	138	20.4	10.4
3	18315.00	43.6 PK	74.0	-30.4	1.50 V	233	50.7	-7.1
4	18315.00	31.0 AV	54.0	-23.0	1.50 V	233	38.1	-7.1
5	#24420.00	44.4 PK	88.2	-43.8	2.18 V	310	46.2	-1.8
6	#24420.00	33.0 AV	68.2	-35.2	2.18 V	310	34.8	-1.8

**Remarks:**

1. Emission Level(dBuV/m) = Raw Value(dBuV) + Correction Factor(dB/m)
2. Correction Factor(dB/m) = Antenna Factor(dB/m) + Cable Factor(dB) – Pre-Amplifier Factor(dB)
3. Margin value = Emission Level – Limit value
4. The other emission levels were very low against the limit.
5. "#": The radiated frequency is out of the restricted band.

<b>RF Mode</b>	TX 802.11be (EHT320)	<b>Channel</b>	CH 63 : 6265 MHz
<b>Frequency Range</b>	1 GHz ~ 40 GHz	<b>Detector Function &amp; Bandwidth</b>	(PK) RB = 1 MHz, VB = 3 MHz (AV) RB = 1 MHz, VB = 2 kHz
<b>Input Power (System)</b>	120Vac, 60Hz	<b>Environmental Conditions</b>	25°C, 68% RH
<b>Tested By</b>	Tom Yang		

**Antenna Polarity & Test Distance : Horizontal at 3 m**

No	Frequency (MHz)	Emission Level (dBuV/m)	Limit (dBuV/m)	Margin (dB)	Antenna Height (m)	Table Angle (Degree)	Raw Value (dBuV)	Correction Factor (dB/m)
1	12530.00	43.5 PK	74.0	-30.5	2.22 H	317	33.6	9.9
2	12530.00	30.4 AV	54.0	-23.6	2.22 H	317	20.5	9.9
3	18795.00	42.7 PK	74.0	-31.3	1.71 H	65	49.6	-6.9
4	18795.00	32.5 AV	54.0	-21.5	1.71 H	65	39.4	-6.9
5	#25060.00	43.6 PK	88.2	-44.6	2.73 H	185	45.1	-1.5
6	#25060.00	33.5 AV	68.2	-34.7	2.73 H	185	35.0	-1.5

**Antenna Polarity & Test Distance : Vertical at 3 m**

No	Frequency (MHz)	Emission Level (dBuV/m)	Limit (dBuV/m)	Margin (dB)	Antenna Height (m)	Table Angle (Degree)	Raw Value (dBuV)	Correction Factor (dB/m)
1	12530.00	44.2 PK	74.0	-29.8	1.24 V	144	34.3	9.9
2	12530.00	31.2 AV	54.0	-22.8	1.24 V	144	21.3	9.9
3	18795.00	43.1 PK	74.0	-30.9	1.49 V	250	50.0	-6.9
4	18795.00	30.6 AV	54.0	-23.4	1.49 V	250	37.5	-6.9
5	#25060.00	45.2 PK	88.2	-43.0	2.20 V	303	46.7	-1.5
6	#25060.00	33.6 AV	68.2	-34.6	2.20 V	303	35.1	-1.5

**Remarks:**

1. Emission Level(dBuV/m) = Raw Value(dBuV) + Correction Factor(dB/m)
2. Correction Factor(dB/m) = Antenna Factor(dB/m) + Cable Factor(dB) – Pre-Amplifier Factor(dB)
3. Margin value = Emission Level – Limit value
4. The other emission levels were very low against the limit.
5. " # ": The radiated frequency is out of the restricted band.

<b>RF Mode</b>	TX 802.11be (EHT320)	<b>Channel</b>	CH 95 : 6425 MHz
<b>Frequency Range</b>	1 GHz ~ 40 GHz	<b>Detector Function &amp; Bandwidth</b>	(PK) RB = 1 MHz, VB = 3 MHz (AV) RB = 1 MHz, VB = 2 kHz
<b>Input Power (System)</b>	120Vac, 60Hz	<b>Environmental Conditions</b>	25°C, 68% RH
<b>Tested By</b>	Tom Yang		

**Antenna Polarity & Test Distance : Horizontal at 3 m**

No	Frequency (MHz)	Emission Level (dBuV/m)	Limit (dBuV/m)	Margin (dB)	Antenna Height (m)	Table Angle (Degree)	Raw Value (dBuV)	Correction Factor (dB/m)
1	#12850.00	42.6 PK	88.2	-45.6	2.20 H	342	32.1	10.5
2	#12850.00	30.2 AV	68.2	-38.0	2.20 H	342	19.7	10.5
3	19275.00	44.2 PK	74.0	-29.8	1.75 H	45	50.8	-6.6
4	19275.00	32.6 AV	54.0	-21.4	1.75 H	45	39.2	-6.6
5	#25700.00	44.7 PK	88.2	-43.5	2.79 H	210	45.9	-1.2
6	#25700.00	34.2 AV	68.2	-34.0	2.79 H	210	35.4	-1.2

**Antenna Polarity & Test Distance : Vertical at 3 m**

No	Frequency (MHz)	Emission Level (dBuV/m)	Limit (dBuV/m)	Margin (dB)	Antenna Height (m)	Table Angle (Degree)	Raw Value (dBuV)	Correction Factor (dB/m)
1	#12850.00	43.1 PK	88.2	-45.1	1.20 V	129	32.6	10.5
2	#12850.00	29.0 AV	68.2	-39.2	1.20 V	129	18.5	10.5
3	19275.00	44.7 PK	74.0	-29.3	1.59 V	199	51.3	-6.6
4	19275.00	33.4 AV	54.0	-20.6	1.59 V	199	40.0	-6.6
5	#25700.00	44.0 PK	88.2	-44.2	1.99 V	340	45.2	-1.2
6	#25700.00	34.6 AV	68.2	-33.6	1.99 V	340	35.8	-1.2

**Remarks:**

1. Emission Level(dBuV/m) = Raw Value(dBuV) + Correction Factor(dB/m)
2. Correction Factor(dB/m) = Antenna Factor(dB/m) + Cable Factor(dB) – Pre-Amplifier Factor(dB)
3. Margin value = Emission Level – Limit value
4. The other emission levels were very low against the limit.
5. "#": The radiated frequency is out of the restricted band.

<b>RF Mode</b>	TX 802.11be (EHT320)	<b>Channel</b>	CH 127 : 6585 MHz
<b>Frequency Range</b>	1 GHz ~ 40 GHz	<b>Detector Function &amp; Bandwidth</b>	(PK) RB = 1 MHz, VB = 3 MHz (AV) RB = 1 MHz, VB = 2 kHz
<b>Input Power (System)</b>	120Vac, 60Hz	<b>Environmental Conditions</b>	25°C, 68% RH
<b>Tested By</b>	Tom Yang		

**Antenna Polarity & Test Distance : Horizontal at 3 m**

No	Frequency (MHz)	Emission Level (dBuV/m)	Limit (dBuV/m)	Margin (dB)	Antenna Height (m)	Table Angle (Degree)	Raw Value (dBuV)	Correction Factor (dB/m)
1	#13170.00	44.2 PK	88.2	-44.0	2.12 H	335	32.9	11.3
2	#13170.00	31.4 AV	68.2	-36.8	2.12 H	335	20.1	11.3
3	19755.00	43.5 PK	74.0	-30.5	1.76 H	38	49.6	-6.1
4	19755.00	32.6 AV	54.0	-21.4	1.76 H	38	38.7	-6.1
5	#26340.00	44.0 PK	88.2	-44.2	2.79 H	215	44.9	-0.9
6	#26340.00	33.7 AV	68.2	-34.5	2.79 H	215	34.6	-0.9

**Antenna Polarity & Test Distance : Vertical at 3 m**

No	Frequency (MHz)	Emission Level (dBuV/m)	Limit (dBuV/m)	Margin (dB)	Antenna Height (m)	Table Angle (Degree)	Raw Value (dBuV)	Correction Factor (dB/m)
1	#13170.00	44.7 PK	88.2	-43.5	1.27 V	132	33.4	11.3
2	#13170.00	30.7 AV	68.2	-37.5	1.27 V	132	19.4	11.3
3	19755.00	44.0 PK	74.0	-30.0	1.44 V	240	50.1	-6.1
4	19755.00	31.4 AV	54.0	-22.6	1.44 V	240	37.5	-6.1
5	#26340.00	45.4 PK	88.2	-42.8	2.14 V	309	46.3	-0.9
6	#26340.00	33.8 AV	68.2	-34.4	2.14 V	309	34.7	-0.9

**Remarks:**

1. Emission Level(dBuV/m) = Raw Value(dBuV) + Correction Factor(dB/m)
2. Correction Factor(dB/m) = Antenna Factor(dB/m) + Cable Factor(dB) – Pre-Amplifier Factor(dB)
3. Margin value = Emission Level – Limit value
4. The other emission levels were very low against the limit.
5. " # ": The radiated frequency is out of the restricted band.



<b>RF Mode</b>	TX 802.11be (EHT320)	<b>Channel</b>	CH 159 : 6745 MHz
<b>Frequency Range</b>	1 GHz ~ 40 GHz	<b>Detector Function &amp; Bandwidth</b>	(PK) RB = 1 MHz, VB = 3 MHz (AV) RB = 1 MHz, VB = 2 kHz
<b>Input Power (System)</b>	120Vac, 60Hz	<b>Environmental Conditions</b>	25°C, 68% RH
<b>Tested By</b>	Tom Yang		

**Antenna Polarity & Test Distance : Horizontal at 3 m**

No	Frequency (MHz)	Emission Level (dBuV/m)	Limit (dBuV/m)	Margin (dB)	Antenna Height (m)	Table Angle (Degree)	Raw Value (dBuV)	Correction Factor (dB/m)
1	#13490.00	43.8 PK	88.2	-44.4	2.26 H	315	31.4	12.4
2	#13490.00	30.5 AV	68.2	-37.7	2.26 H	315	18.1	12.4
3	20235.00	42.8 PK	74.0	-31.2	1.76 H	66	48.5	-5.7
4	20235.00	32.4 AV	54.0	-21.6	1.76 H	66	38.1	-5.7
5	#26980.00	43.5 PK	88.2	-44.7	2.74 H	192	44.2	-0.7
6	#26980.00	33.2 AV	68.2	-35.0	2.74 H	192	33.9	-0.7

**Antenna Polarity & Test Distance : Vertical at 3 m**

No	Frequency (MHz)	Emission Level (dBuV/m)	Limit (dBuV/m)	Margin (dB)	Antenna Height (m)	Table Angle (Degree)	Raw Value (dBuV)	Correction Factor (dB/m)
1	#13490.00	43.7 PK	88.2	-44.5	1.29 V	149	31.3	12.4
2	#13490.00	30.7 AV	68.2	-37.5	1.29 V	149	18.3	12.4
3	20235.00	42.6 PK	74.0	-31.4	1.44 V	249	48.3	-5.7
4	20235.00	30.2 AV	54.0	-23.8	1.44 V	249	35.9	-5.7
5	#26980.00	45.0 PK	88.2	-43.2	2.18 V	310	45.7	-0.7
6	#26980.00	33.3 AV	68.2	-34.9	2.18 V	310	34.0	-0.7

**Remarks:**

1. Emission Level(dBuV/m) = Raw Value(dBuV) + Correction Factor(dB/m)
2. Correction Factor(dB/m) = Antenna Factor(dB/m) + Cable Factor(dB) – Pre-Amplifier Factor(dB)
3. Margin value = Emission Level – Limit value
4. The other emission levels were very low against the limit.
5. " # ": The radiated frequency is out of the restricted band.

<b>RF Mode</b>	TX 802.11be (EHT320)	<b>Channel</b>	CH 191 : 6905 MHz
<b>Frequency Range</b>	1 GHz ~ 40 GHz	<b>Detector Function &amp; Bandwidth</b>	(PK) RB = 1 MHz, VB = 3 MHz (AV) RB = 1 MHz, VB = 2 kHz
<b>Input Power (System)</b>	120Vac, 60Hz	<b>Environmental Conditions</b>	25°C, 68% RH
<b>Tested By</b>	Tom Yang		

**Antenna Polarity & Test Distance : Horizontal at 3 m**

No	Frequency (MHz)	Emission Level (dBuV/m)	Limit (dBuV/m)	Margin (dB)	Antenna Height (m)	Table Angle (Degree)	Raw Value (dBuV)	Correction Factor (dB/m)
1	#13810.00	43.5 PK	88.2	-44.7	2.29 H	341	30.5	13.0
2	#13810.00	31.0 AV	68.2	-37.2	2.29 H	341	18.0	13.0
3	20715.00	42.8 PK	74.0	-31.2	1.60 H	122	47.5	-4.7
4	20715.00	31.4 AV	54.0	-22.6	1.60 H	122	36.1	-4.7
5	#27620.00	43.6 PK	88.2	-44.6	2.56 H	176	44.8	-1.2
6	#27620.00	34.2 AV	68.2	-34.0	2.56 H	176	35.4	-1.2

**Antenna Polarity & Test Distance : Vertical at 3 m**

No	Frequency (MHz)	Emission Level (dBuV/m)	Limit (dBuV/m)	Margin (dB)	Antenna Height (m)	Table Angle (Degree)	Raw Value (dBuV)	Correction Factor (dB/m)
1	#13810.00	43.8 PK	88.2	-44.4	1.21 V	141	30.8	13.0
2	#13810.00	29.6 AV	68.2	-38.6	1.21 V	141	16.6	13.0
3	20715.00	44.0 PK	74.0	-30.0	1.55 V	210	48.7	-4.7
4	20715.00	32.9 AV	54.0	-21.1	1.55 V	210	37.6	-4.7
5	#27620.00	44.2 PK	88.2	-44.0	1.99 V	359	45.4	-1.2
6	#27620.00	34.3 AV	68.2	-33.9	1.99 V	359	35.5	-1.2

**Remarks:**

1. Emission Level(dBuV/m) = Raw Value(dBuV) + Correction Factor(dB/m)
2. Correction Factor(dB/m) = Antenna Factor(dB/m) + Cable Factor(dB) – Pre-Amplifier Factor(dB)
3. Margin value = Emission Level – Limit value
4. The other emission levels were very low against the limit.
5. "#": The radiated frequency is out of the restricted band.

### Below 1GHz Data:

<b>RF Mode</b>	TX 802.11be (EHT320)	<b>Channel</b>	CH 159 : 6745 MHz
<b>Frequency Range</b>	9 kHz ~ 1 GHz	<b>Detector Function &amp; Bandwidth</b>	(QP) RB = 120kHz
<b>Input Power (System)</b>	120Vac, 60Hz	<b>Environmental Conditions</b>	25°C, 66% RH
<b>Tested By</b>	Tom Yang		

#### Antenna Polarity & Test Distance : Horizontal at 3 m

No	Frequency (MHz)	Emission Level (dBuV/m)	Limit (dBuV/m)	Margin (dB)	Antenna Height (m)	Table Angle (Degree)	Raw Value (dBuV)	Correction Factor (dB/m)
1	166.00	37.1 QP	43.5	-6.4	2.00 H	4	49.0	-11.9
2	199.73	38.1 QP	43.5	-5.4	1.00 H	160	52.8	-14.7
3	298.79	42.6 QP	46.0	-3.4	1.00 H	129	53.1	-10.5
4	697.23	42.7 QP	46.0	-3.3	1.00 H	85	43.1	-0.4
5	719.78	42.5 QP	46.0	-3.5	1.50 H	51	42.7	-0.2
6	798.46	38.4 QP	46.0	-7.6	1.00 H	66	36.8	1.6

#### Remarks:

1. Emission Level(dBuV/m) = Raw Value(dBuV) + Correction Factor(dB/m)
2. Correction Factor(dB/m) = Antenna Factor(dB/m) + Cable Factor(dB) – Pre-Amplifier Factor(dB)
3. Margin value = Emission Level – Limit value
4. The other emission levels were very low against the limit of frequency range 30 MHz ~ 1 GHz.
5. The emission levels were very low against the limit of frequency range 9 kHz ~ 30 MHz: the amplitude of spurious emissions attenuated more than 20 dB below the permissible value to be report.

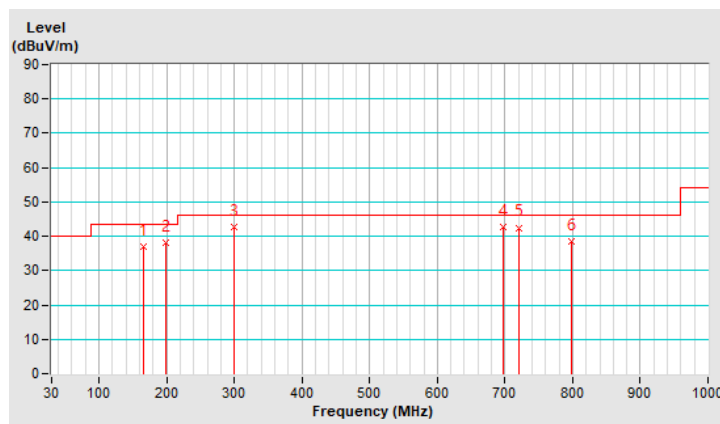

<b>RF Mode</b>	TX 802.11be (EHT320)	<b>Channel</b>	CH 159 : 6745 MHz
<b>Frequency Range</b>	9 kHz ~ 1 GHz	<b>Detector Function &amp; Bandwidth</b>	(QP) RB = 120kHz
<b>Input Power (System)</b>	120Vac, 60Hz	<b>Environmental Conditions</b>	25°C, 66% RH
<b>Tested By</b>	Tom Yang		

Antenna Polarity & Test Distance : Vertical at 3 m								
No	Frequency (MHz)	Emission Level (dBuV/m)	Limit (dBuV/m)	Margin (dB)	Antenna Height (m)	Table Angle (Degree)	Raw Value (dBuV)	Correction Factor (dB/m)
1	38.22	31.7 QP	40.0	-8.3	1.50 V	321	44.5	-12.8
2	166.01	39.5 QP	43.5	-4.0	1.00 V	260	51.4	-11.9
3	239.78	35.5 QP	46.0	-10.5	1.00 V	56	48.4	-12.9
4	299.51	42.4 QP	46.0	-3.6	1.00 V	158	52.8	-10.4
5	696.70	41.2 QP	46.0	-4.8	1.50 V	73	41.6	-0.4
6	720.58	41.4 QP	46.0	-4.6	1.00 V	87	41.5	-0.1

**Remarks:**

1. Emission Level(dBuV/m) = Raw Value(dBuV) + Correction Factor(dB/m)
2. Correction Factor(dB/m) = Antenna Factor(dB/m) + Cable Factor(dB) – Pre-Amplifier Factor(dB)
3. Margin value = Emission Level – Limit value
4. The other emission levels were very low against the limit of frequency range 30 MHz ~ 1 GHz.
5. The emission levels were very low against the limit of frequency range 9 kHz ~ 30 MHz: the amplitude of spurious emissions attenuated more than 20 dB below the permissible value to be report.

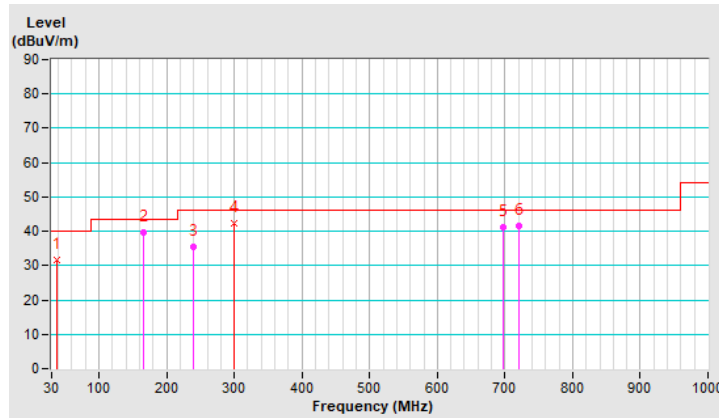

## 4.1.6.2 Test Results (Mode 2)

## Above 1GHz Data:

<b>RF Mode</b>	TX 802.11a 6G	<b>Channel</b>	CH 1 : 5955 MHz
<b>Frequency Range</b>	1 GHz ~ 40 GHz	<b>Detector Function &amp; Bandwidth</b>	(PK) RB = 1 MHz, VB = 3 MHz (AV) RB = 1 MHz, VB = 510 Hz
<b>Input Power (System)</b>	120Vac, 60Hz	<b>Environmental Conditions</b>	25°C, 68% RH
<b>Tested By</b>	Tom Yang		

**Antenna Polarity & Test Distance : Horizontal at 3 m**

No	Frequency (MHz)	Emission Level (dBuV/m)	Limit (dBuV/m)	Margin (dB)	Antenna Height (m)	Table Angle (Degree)	Raw Value (dBuV)	Correction Factor (dB/m)
1	11910.00	43.0 PK	74.0	-31.0	2.27 H	334	32.1	10.9
2	11910.00	30.2 AV	54.0	-23.8	2.27 H	334	19.3	10.9
3	17865.00	43.5 PK	74.0	-30.5	1.49 H	147	21.9	21.6
4	17865.00	32.9 AV	54.0	-21.1	1.49 H	147	11.3	21.6
5	23820.00	42.6 PK	74.0	-31.4	2.71 H	170	45.0	-2.4
6	23820.00	32.8 AV	54.0	-21.2	2.71 H	170	35.2	-2.4

**Antenna Polarity & Test Distance : Vertical at 3 m**

No	Frequency (MHz)	Emission Level (dBuV/m)	Limit (dBuV/m)	Margin (dB)	Antenna Height (m)	Table Angle (Degree)	Raw Value (dBuV)	Correction Factor (dB/m)
1	11910.00	44.5 PK	74.0	-29.5	1.21 V	183	33.6	10.9
2	11910.00	30.9 AV	54.0	-23.1	1.21 V	183	20.0	10.9
3	17865.00	43.3 PK	74.0	-30.7	1.78 V	252	21.7	21.6
4	17865.00	32.3 AV	54.0	-21.7	1.78 V	252	10.7	21.6
5	23820.00	43.7 PK	74.0	-30.3	2.15 V	329	46.1	-2.4
6	23820.00	33.4 AV	54.0	-20.6	2.15 V	329	35.8	-2.4

**Remarks:**

1. Emission Level(dBuV/m) = Raw Value(dBuV) + Correction Factor(dB/m)
2. Correction Factor(dB/m) = Antenna Factor(dB/m) + Cable Factor(dB) – Pre-Amplifier Factor(dB)
3. Margin value = Emission Level – Limit value
4. The other emission levels were very low against the limit.

<b>RF Mode</b>	TX 802.11a 6G	<b>Channel</b>	CH 45 : 6175 MHz
<b>Frequency Range</b>	1 GHz ~ 40 GHz	<b>Detector Function &amp; Bandwidth</b>	(PK) RB = 1 MHz, VB = 3 MHz (AV) RB = 1 MHz, VB = 510 Hz
<b>Input Power (System)</b>	120Vac, 60Hz	<b>Environmental Conditions</b>	25°C, 68% RH
<b>Tested By</b>	Tom Yang		

**Antenna Polarity & Test Distance : Horizontal at 3 m**

No	Frequency (MHz)	Emission Level (dBuV/m)	Limit (dBuV/m)	Margin (dB)	Antenna Height (m)	Table Angle (Degree)	Raw Value (dBuV)	Correction Factor (dB/m)
1	12350.00	43.8 PK	74.0	-30.2	2.24 H	336	33.8	10.0
2	12350.00	30.7 AV	54.0	-23.3	2.24 H	336	20.7	10.0
3	18525.00	43.5 PK	74.0	-30.5	1.53 H	158	50.6	-7.1
4	18525.00	32.7 AV	54.0	-21.3	1.53 H	158	39.8	-7.1
5	#24700.00	43.2 PK	88.2	-45.0	2.73 H	162	44.8	-1.6
6	#24700.00	33.1 AV	68.2	-35.1	2.73 H	162	34.7	-1.6

**Antenna Polarity & Test Distance : Vertical at 3 m**

No	Frequency (MHz)	Emission Level (dBuV/m)	Limit (dBuV/m)	Margin (dB)	Antenna Height (m)	Table Angle (Degree)	Raw Value (dBuV)	Correction Factor (dB/m)
1	12350.00	45.0 PK	74.0	-29.0	1.20 V	186	35.0	10.0
2	12350.00	31.2 AV	54.0	-22.8	1.20 V	186	21.2	10.0
3	18525.00	43.2 PK	74.0	-30.8	1.73 V	241	50.3	-7.1
4	18525.00	32.1 AV	54.0	-21.9	1.73 V	241	39.2	-7.1
5	#24700.00	43.4 PK	88.2	-44.8	2.19 V	324	45.0	-1.6
6	#24700.00	33.1 AV	68.2	-35.1	2.19 V	324	34.7	-1.6

**Remarks:**

1. Emission Level(dBuV/m) = Raw Value(dBuV) + Correction Factor(dB/m)
2. Correction Factor(dB/m) = Antenna Factor(dB/m) + Cable Factor(dB) – Pre-Amplifier Factor(dB)
3. Margin value = Emission Level – Limit value
4. The other emission levels were very low against the limit.
5. "#": The radiated frequency is out of the restricted band.

<b>RF Mode</b>	TX 802.11a 6G	<b>Channel</b>	CH 93 : 6415 MHz
<b>Frequency Range</b>	1 GHz ~ 40 GHz	<b>Detector Function &amp; Bandwidth</b>	(PK) RB = 1 MHz, VB = 3 MHz (AV) RB = 1 MHz, VB = 510 Hz
<b>Input Power (System)</b>	120Vac, 60Hz	<b>Environmental Conditions</b>	25°C, 68% RH
<b>Tested By</b>	Tom Yang		

**Antenna Polarity & Test Distance : Horizontal at 3 m**

No	Frequency (MHz)	Emission Level (dBuV/m)	Limit (dBuV/m)	Margin (dB)	Antenna Height (m)	Table Angle (Degree)	Raw Value (dBuV)	Correction Factor (dB/m)
1	#12830.00	44.0 PK	88.2	-44.2	2.25 H	341	33.5	10.5
2	#12830.00	31.0 AV	68.2	-37.2	2.25 H	341	20.5	10.5
3	19245.00	43.4 PK	74.0	-30.6	1.58 H	147	49.9	-6.5
4	19245.00	32.5 AV	54.0	-21.5	1.58 H	147	39.0	-6.5
5	#25660.00	43.3 PK	88.2	-44.9	2.71 H	170	44.5	-1.2
6	#25660.00	33.0 AV	68.2	-35.2	2.71 H	170	34.2	-1.2

**Antenna Polarity & Test Distance : Vertical at 3 m**

No	Frequency (MHz)	Emission Level (dBuV/m)	Limit (dBuV/m)	Margin (dB)	Antenna Height (m)	Table Angle (Degree)	Raw Value (dBuV)	Correction Factor (dB/m)
1	#12830.00	45.3 PK	88.2	-42.9	1.24 V	175	34.8	10.5
2	#12830.00	31.2 AV	68.2	-37.0	1.24 V	175	20.7	10.5
3	19245.00	43.0 PK	74.0	-31.0	1.74 V	254	49.5	-6.5
4	19245.00	32.1 AV	54.0	-21.9	1.74 V	254	38.6	-6.5
5	#25660.00	43.7 PK	88.2	-44.5	2.23 V	320	44.9	-1.2
6	#25660.00	33.1 AV	68.2	-35.1	2.23 V	320	34.3	-1.2

**Remarks:**

1. Emission Level(dBuV/m) = Raw Value(dBuV) + Correction Factor(dB/m)
2. Correction Factor(dB/m) = Antenna Factor(dB/m) + Cable Factor(dB) – Pre-Amplifier Factor(dB)
3. Margin value = Emission Level – Limit value
4. The other emission levels were very low against the limit.
5. "#": The radiated frequency is out of the restricted band.

<b>RF Mode</b>	TX 802.11a 6G	<b>Channel</b>	CH 97 : 6435 MHz
<b>Frequency Range</b>	1 GHz ~ 40 GHz	<b>Detector Function &amp; Bandwidth</b>	(PK) RB = 1 MHz, VB = 3 MHz (AV) RB = 1 MHz, VB = 510 Hz
<b>Input Power (System)</b>	120Vac, 60Hz	<b>Environmental Conditions</b>	25°C, 68% RH
<b>Tested By</b>	Tom Yang		

**Antenna Polarity & Test Distance : Horizontal at 3 m**

No	Frequency (MHz)	Emission Level (dBuV/m)	Limit (dBuV/m)	Margin (dB)	Antenna Height (m)	Table Angle (Degree)	Raw Value (dBuV)	Correction Factor (dB/m)
1	#12870.00	43.2 PK	88.2	-45.0	2.29 H	346	32.7	10.5
2	#12870.00	30.7 AV	68.2	-37.5	2.29 H	346	20.2	10.5
3	19305.00	43.2 PK	74.0	-30.8	1.46 H	160	50.0	-6.8
4	19305.00	32.7 AV	54.0	-21.3	1.46 H	160	39.5	-6.8
5	#25740.00	42.6 PK	88.2	-45.6	2.66 H	166	43.8	-1.2
6	#25740.00	32.9 AV	68.2	-35.3	2.66 H	166	34.1	-1.2

**Antenna Polarity & Test Distance : Vertical at 3 m**

No	Frequency (MHz)	Emission Level (dBuV/m)	Limit (dBuV/m)	Margin (dB)	Antenna Height (m)	Table Angle (Degree)	Raw Value (dBuV)	Correction Factor (dB/m)
1	#12870.00	44.5 PK	88.2	-43.7	1.23 V	185	34.0	10.5
2	#12870.00	31.0 AV	68.2	-37.2	1.23 V	185	20.5	10.5
3	19305.00	43.4 PK	74.0	-30.6	1.72 V	257	50.2	-6.8
4	19305.00	32.6 AV	54.0	-21.4	1.72 V	257	39.4	-6.8
5	#25740.00	43.8 PK	88.2	-44.4	2.20 V	323	45.0	-1.2
6	#25740.00	33.5 AV	68.2	-34.7	2.20 V	323	34.7	-1.2

**Remarks:**

1. Emission Level(dBuV/m) = Raw Value(dBuV) + Correction Factor(dB/m)
2. Correction Factor(dB/m) = Antenna Factor(dB/m) + Cable Factor(dB) – Pre-Amplifier Factor(dB)
3. Margin value = Emission Level – Limit value
4. The other emission levels were very low against the limit.
5. " # ": The radiated frequency is out of the restricted band.



<b>RF Mode</b>	TX 802.11a 6G	<b>Channel</b>	CH 105 : 6475 MHz
<b>Frequency Range</b>	1 GHz ~ 40 GHz	<b>Detector Function &amp; Bandwidth</b>	(PK) RB = 1 MHz, VB = 3 MHz (AV) RB = 1 MHz, VB = 510 Hz
<b>Input Power (System)</b>	120Vac, 60Hz	<b>Environmental Conditions</b>	25°C, 68% RH
<b>Tested By</b>	Tom Yang		

**Antenna Polarity & Test Distance : Horizontal at 3 m**

No	Frequency (MHz)	Emission Level (dBuV/m)	Limit (dBuV/m)	Margin (dB)	Antenna Height (m)	Table Angle (Degree)	Raw Value (dBuV)	Correction Factor (dB/m)
1	#12950.00	43.4 PK	88.2	-44.8	2.20 H	342	32.9	10.5
2	#12950.00	30.4 AV	68.2	-37.8	2.20 H	342	19.9	10.5
3	19425.00	43.8 PK	74.0	-30.2	1.57 H	147	50.3	-6.5
4	19425.00	33.2 AV	54.0	-20.8	1.57 H	147	39.7	-6.5
5	#25900.00	43.6 PK	88.2	-44.6	2.75 H	167	44.7	-1.1
6	#25900.00	33.5 AV	68.2	-34.7	2.75 H	167	34.6	-1.1

**Antenna Polarity & Test Distance : Vertical at 3 m**

No	Frequency (MHz)	Emission Level (dBuV/m)	Limit (dBuV/m)	Margin (dB)	Antenna Height (m)	Table Angle (Degree)	Raw Value (dBuV)	Correction Factor (dB/m)
1	#12950.00	43.9 PK	88.2	-44.3	1.26 V	177	33.4	10.5
2	#12950.00	30.6 AV	68.2	-37.6	1.26 V	177	20.1	10.5
3	19425.00	43.1 PK	74.0	-30.9	1.83 V	253	49.6	-6.5
4	19425.00	32.0 AV	54.0	-22.0	1.83 V	253	38.5	-6.5
5	#25900.00	43.8 PK	88.2	-44.4	2.14 V	317	44.9	-1.1
6	#25900.00	33.2 AV	68.2	-35.0	2.14 V	317	34.3	-1.1

**Remarks:**

1. Emission Level(dBuV/m) = Raw Value(dBuV) + Correction Factor(dB/m)
2. Correction Factor(dB/m) = Antenna Factor(dB/m) + Cable Factor(dB) – Pre-Amplifier Factor(dB)
3. Margin value = Emission Level – Limit value
4. The other emission levels were very low against the limit.
5. "#": The radiated frequency is out of the restricted band.

<b>RF Mode</b>	TX 802.11a 6G	<b>Channel</b>	CH 113 : 6515 MHz
<b>Frequency Range</b>	1 GHz ~ 40 GHz	<b>Detector Function &amp; Bandwidth</b>	(PK) RB = 1 MHz, VB = 3 MHz (AV) RB = 1 MHz, VB = 510 Hz
<b>Input Power (System)</b>	120Vac, 60Hz	<b>Environmental Conditions</b>	25°C, 68% RH
<b>Tested By</b>	Tom Yang		

**Antenna Polarity & Test Distance : Horizontal at 3 m**

No	Frequency (MHz)	Emission Level (dBuV/m)	Limit (dBuV/m)	Margin (dB)	Antenna Height (m)	Table Angle (Degree)	Raw Value (dBuV)	Correction Factor (dB/m)
1	#13030.00	43.0 PK	88.2	-45.2	2.25 H	358	32.4	10.6
2	#13030.00	30.0 AV	68.2	-38.2	2.25 H	358	19.4	10.6
3	19545.00	43.4 PK	74.0	-30.6	1.62 H	136	49.6	-6.2
4	19545.00	32.7 AV	54.0	-21.3	1.62 H	136	38.9	-6.2
5	#26060.00	44.6 PK	88.2	-43.6	2.74 H	183	45.6	-1.0
6	#26060.00	34.6 AV	68.2	-33.6	2.74 H	183	35.6	-1.0

**Antenna Polarity & Test Distance : Vertical at 3 m**

No	Frequency (MHz)	Emission Level (dBuV/m)	Limit (dBuV/m)	Margin (dB)	Antenna Height (m)	Table Angle (Degree)	Raw Value (dBuV)	Correction Factor (dB/m)
1	#13030.00	44.5 PK	88.2	-43.7	1.20 V	197	33.9	10.6
2	#13030.00	31.0 AV	68.2	-37.2	1.20 V	197	20.4	10.6
3	19545.00	43.1 PK	74.0	-30.9	1.78 V	250	49.3	-6.2
4	19545.00	32.2 AV	54.0	-21.8	1.78 V	250	38.4	-6.2
5	#26060.00	43.6 PK	88.2	-44.6	2.19 V	339	44.6	-1.0
6	#26060.00	33.4 AV	68.2	-34.8	2.19 V	339	34.4	-1.0

**Remarks:**

1. Emission Level(dBuV/m) = Raw Value(dBuV) + Correction Factor(dB/m)
2. Correction Factor(dB/m) = Antenna Factor(dB/m) + Cable Factor(dB) – Pre-Amplifier Factor(dB)
3. Margin value = Emission Level – Limit value
4. The other emission levels were very low against the limit.
5. "#": The radiated frequency is out of the restricted band.

<b>RF Mode</b>	TX 802.11a 6G	<b>Channel</b>	CH 117 : 6535 MHz
<b>Frequency Range</b>	1 GHz ~ 40 GHz	<b>Detector Function &amp; Bandwidth</b>	(PK) RB = 1 MHz, VB = 3 MHz (AV) RB = 1 MHz, VB = 510 Hz
<b>Input Power (System)</b>	120Vac, 60Hz	<b>Environmental Conditions</b>	25°C, 68% RH
<b>Tested By</b>	Tom Yang		

**Antenna Polarity & Test Distance : Horizontal at 3 m**

No	Frequency (MHz)	Emission Level (dBuV/m)	Limit (dBuV/m)	Margin (dB)	Antenna Height (m)	Table Angle (Degree)	Raw Value (dBuV)	Correction Factor (dB/m)
1	#13070.00	43.7 PK	88.2	-44.5	2.28 H	353	32.9	10.8
2	#13070.00	30.6 AV	68.2	-37.6	2.28 H	353	19.8	10.8
3	19605.00	43.7 PK	74.0	-30.3	1.59 H	136	49.7	-6.0
4	19605.00	32.8 AV	54.0	-21.2	1.59 H	136	38.8	-6.0
5	#26140.00	42.7 PK	88.2	-45.5	2.66 H	163	43.6	-0.9
6	#26140.00	32.6 AV	68.2	-35.6	2.66 H	163	33.5	-0.9

**Antenna Polarity & Test Distance : Vertical at 3 m**

No	Frequency (MHz)	Emission Level (dBuV/m)	Limit (dBuV/m)	Margin (dB)	Antenna Height (m)	Table Angle (Degree)	Raw Value (dBuV)	Correction Factor (dB/m)
1	#13070.00	44.0 PK	88.2	-44.2	1.20 V	175	33.2	10.8
2	#13070.00	30.5 AV	68.2	-37.7	1.20 V	175	19.7	10.8
3	19605.00	43.5 PK	74.0	-30.5	1.83 V	254	49.5	-6.0
4	19605.00	32.4 AV	54.0	-21.6	1.83 V	254	38.4	-6.0
5	#26140.00	44.2 PK	88.2	-44.0	2.19 V	327	45.1	-0.9
6	#26140.00	33.5 AV	68.2	-34.7	2.19 V	327	34.4	-0.9

**Remarks:**

1. Emission Level(dBuV/m) = Raw Value(dBuV) + Correction Factor(dB/m)
2. Correction Factor(dB/m) = Antenna Factor(dB/m) + Cable Factor(dB) – Pre-Amplifier Factor(dB)
3. Margin value = Emission Level – Limit value
4. The other emission levels were very low against the limit.
5. " # ": The radiated frequency is out of the restricted band.

<b>RF Mode</b>	TX 802.11a 6G	<b>Channel</b>	CH 153 : 6715 MHz
<b>Frequency Range</b>	1 GHz ~ 40 GHz	<b>Detector Function &amp; Bandwidth</b>	(PK) RB = 1 MHz, VB = 3 MHz (AV) RB = 1 MHz, VB = 510 Hz
<b>Input Power (System)</b>	120Vac, 60Hz	<b>Environmental Conditions</b>	25°C, 68% RH
<b>Tested By</b>	Tom Yang		

**Antenna Polarity & Test Distance : Horizontal at 3 m**

No	Frequency (MHz)	Emission Level (dBuV/m)	Limit (dBuV/m)	Margin (dB)	Antenna Height (m)	Table Angle (Degree)	Raw Value (dBuV)	Correction Factor (dB/m)
1	#13430.00	42.7 PK	88.2	-45.5	2.30 H	347	30.5	12.2
2	#13430.00	29.9 AV	68.2	-38.3	2.30 H	347	17.7	12.2
3	20145.00	43.1 PK	74.0	-30.9	1.57 H	122	48.7	-5.6
4	20145.00	32.4 AV	54.0	-21.6	1.57 H	122	38.0	-5.6
5	#26860.00	44.0 PK	88.2	-44.2	2.69 H	174	44.8	-0.8
6	#26860.00	34.1 AV	68.2	-34.1	2.69 H	174	34.9	-0.8

**Antenna Polarity & Test Distance : Vertical at 3 m**

No	Frequency (MHz)	Emission Level (dBuV/m)	Limit (dBuV/m)	Margin (dB)	Antenna Height (m)	Table Angle (Degree)	Raw Value (dBuV)	Correction Factor (dB/m)
1	#13430.00	43.6 PK	88.2	-44.6	1.26 V	186	31.4	12.2
2	#13430.00	30.5 AV	68.2	-37.7	1.26 V	186	18.3	12.2
3	20145.00	42.9 PK	74.0	-31.1	1.89 V	254	48.5	-5.6
4	20145.00	31.7 AV	54.0	-22.3	1.89 V	254	37.3	-5.6
5	#26860.00	43.8 PK	88.2	-44.4	2.13 V	330	44.6	-0.8
6	#26860.00	33.0 AV	68.2	-35.2	2.13 V	330	33.8	-0.8

**Remarks:**

1. Emission Level(dBuV/m) = Raw Value(dBuV) + Correction Factor(dB/m)
2. Correction Factor(dB/m) = Antenna Factor(dB/m) + Cable Factor(dB) – Pre-Amplifier Factor(dB)
3. Margin value = Emission Level – Limit value
4. The other emission levels were very low against the limit.
5. " # ": The radiated frequency is out of the restricted band.

<b>RF Mode</b>	TX 802.11a 6G	<b>Channel</b>	CH 181 : 6855 MHz
<b>Frequency Range</b>	1 GHz ~ 40 GHz	<b>Detector Function &amp; Bandwidth</b>	(PK) RB = 1 MHz, VB = 3 MHz (AV) RB = 1 MHz, VB = 510 Hz
<b>Input Power (System)</b>	120Vac, 60Hz	<b>Environmental Conditions</b>	25°C, 68% RH
<b>Tested By</b>	Tom Yang		

**Antenna Polarity & Test Distance : Horizontal at 3 m**

No	Frequency (MHz)	Emission Level (dBuV/m)	Limit (dBuV/m)	Margin (dB)	Antenna Height (m)	Table Angle (Degree)	Raw Value (dBuV)	Correction Factor (dB/m)
1	#13710.00	43.1 PK	88.2	-45.1	2.29 H	326	30.3	12.8
2	#13710.00	30.3 AV	68.2	-37.9	2.29 H	326	17.5	12.8
3	20565.00	43.5 PK	74.0	-30.5	1.67 H	145	48.2	-4.7
4	20565.00	32.8 AV	54.0	-21.2	1.67 H	145	37.5	-4.7
5	#27420.00	44.1 PK	88.2	-44.1	2.71 H	189	45.0	-0.9
6	#27420.00	34.1 AV	68.2	-34.1	2.71 H	189	35.0	-0.9

**Antenna Polarity & Test Distance : Vertical at 3 m**

No	Frequency (MHz)	Emission Level (dBuV/m)	Limit (dBuV/m)	Margin (dB)	Antenna Height (m)	Table Angle (Degree)	Raw Value (dBuV)	Correction Factor (dB/m)
1	#13710.00	44.5 PK	88.2	-43.7	1.16 V	191	31.7	12.8
2	#13710.00	30.9 AV	68.2	-37.3	1.16 V	191	18.1	12.8
3	20565.00	43.5 PK	74.0	-30.5	1.82 V	253	48.2	-4.7
4	20565.00	32.4 AV	54.0	-21.6	1.82 V	253	37.1	-4.7
5	#27420.00	44.3 PK	88.2	-43.9	2.15 V	331	45.2	-0.9
6	#27420.00	33.5 AV	68.2	-34.7	2.15 V	331	34.4	-0.9

**Remarks:**

1. Emission Level(dBuV/m) = Raw Value(dBuV) + Correction Factor(dB/m)
2. Correction Factor(dB/m) = Antenna Factor(dB/m) + Cable Factor(dB) – Pre-Amplifier Factor(dB)
3. Margin value = Emission Level – Limit value
4. The other emission levels were very low against the limit.
5. "#": The radiated frequency is out of the restricted band.

<b>RF Mode</b>	TX 802.11a 6G	<b>Channel</b>	CH 185 : 6875 MHz
<b>Frequency Range</b>	1 GHz ~ 40 GHz	<b>Detector Function &amp; Bandwidth</b>	(PK) RB = 1 MHz, VB = 3 MHz (AV) RB = 1 MHz, VB = 510 Hz
<b>Input Power (System)</b>	120Vac, 60Hz	<b>Environmental Conditions</b>	25°C, 68% RH
<b>Tested By</b>	Tom Yang		

**Antenna Polarity & Test Distance : Horizontal at 3 m**

No	Frequency (MHz)	Emission Level (dBuV/m)	Limit (dBuV/m)	Margin (dB)	Antenna Height (m)	Table Angle (Degree)	Raw Value (dBuV)	Correction Factor (dB/m)
1	#13750.00	43.4 PK	88.2	-44.8	2.26 H	352	30.5	12.9
2	#13750.00	30.6 AV	68.2	-37.6	2.26 H	352	17.7	12.9
3	20625.00	42.9 PK	74.0	-31.1	1.69 H	152	47.7	-4.8
4	20625.00	32.4 AV	54.0	-21.6	1.69 H	152	37.2	-4.8
5	#27500.00	44.0 PK	88.2	-44.2	2.66 H	195	44.9	-0.9
6	#27500.00	33.9 AV	68.2	-34.3	2.66 H	195	34.8	-0.9

**Antenna Polarity & Test Distance : Vertical at 3 m**

No	Frequency (MHz)	Emission Level (dBuV/m)	Limit (dBuV/m)	Margin (dB)	Antenna Height (m)	Table Angle (Degree)	Raw Value (dBuV)	Correction Factor (dB/m)
1	#13750.00	44.5 PK	88.2	-43.7	1.16 V	191	31.6	12.9
2	#13750.00	31.1 AV	68.2	-37.1	1.16 V	191	18.2	12.9
3	20625.00	44.2 PK	74.0	-29.8	1.77 V	249	49.0	-4.8
4	20625.00	32.8 AV	54.0	-21.2	1.77 V	249	37.6	-4.8
5	#27500.00	44.6 PK	88.2	-43.6	2.20 V	318	45.5	-0.9
6	#27500.00	33.6 AV	68.2	-34.6	2.20 V	318	34.5	-0.9

**Remarks:**

1. Emission Level(dBuV/m) = Raw Value(dBuV) + Correction Factor(dB/m)
2. Correction Factor(dB/m) = Antenna Factor(dB/m) + Cable Factor(dB) – Pre-Amplifier Factor(dB)
3. Margin value = Emission Level – Limit value
4. The other emission levels were very low against the limit.
5. "#": The radiated frequency is out of the restricted band.

<b>RF Mode</b>	TX 802.11a 6G	<b>Channel</b>	CH 213 : 7015 MHz
<b>Frequency Range</b>	1 GHz ~ 40 GHz	<b>Detector Function &amp; Bandwidth</b>	(PK) RB = 1 MHz, VB = 3 MHz (AV) RB = 1 MHz, VB = 510 Hz
<b>Input Power (System)</b>	120Vac, 60Hz	<b>Environmental Conditions</b>	25°C, 68% RH
<b>Tested By</b>	Tom Yang		

**Antenna Polarity & Test Distance : Horizontal at 3 m**

No	Frequency (MHz)	Emission Level (dBuV/m)	Limit (dBuV/m)	Margin (dB)	Antenna Height (m)	Table Angle (Degree)	Raw Value (dBuV)	Correction Factor (dB/m)
1	#14030.00	42.6 PK	88.2	-45.6	2.35 H	360	29.5	13.1
2	#14030.00	29.6 AV	68.2	-38.6	2.35 H	360	16.5	13.1
3	21045.00	43.6 PK	74.0	-30.4	1.55 H	117	47.7	-4.1
4	21045.00	32.7 AV	54.0	-21.3	1.55 H	117	36.8	-4.1
5	#28060.00	44.2 PK	88.2	-44.0	2.66 H	160	45.4	-1.2
6	#28060.00	34.5 AV	68.2	-33.7	2.66 H	160	35.7	-1.2

**Antenna Polarity & Test Distance : Vertical at 3 m**

No	Frequency (MHz)	Emission Level (dBuV/m)	Limit (dBuV/m)	Margin (dB)	Antenna Height (m)	Table Angle (Degree)	Raw Value (dBuV)	Correction Factor (dB/m)
1	#14030.00	43.9 PK	88.2	-44.3	1.25 V	188	30.8	13.1
2	#14030.00	30.3 AV	68.2	-37.9	1.25 V	188	17.2	13.1
3	21045.00	43.2 PK	74.0	-30.8	1.80 V	240	47.3	-4.1
4	21045.00	32.1 AV	54.0	-21.9	1.80 V	240	36.2	-4.1
5	#28060.00	44.3 PK	88.2	-43.9	2.23 V	330	45.5	-1.2
6	#28060.00	33.8 AV	68.2	-34.4	2.23 V	330	35.0	-1.2

**Remarks:**

1. Emission Level(dBuV/m) = Raw Value(dBuV) + Correction Factor(dB/m)
2. Correction Factor(dB/m) = Antenna Factor(dB/m) + Cable Factor(dB) – Pre-Amplifier Factor(dB)
3. Margin value = Emission Level – Limit value
4. The other emission levels were very low against the limit.
5. " # ": The radiated frequency is out of the restricted band.

<b>RF Mode</b>	TX 802.11a 6G	<b>Channel</b>	CH 233 : 7115 MHz
<b>Frequency Range</b>	1 GHz ~ 40 GHz	<b>Detector Function &amp; Bandwidth</b>	(PK) RB = 1 MHz, VB = 3 MHz (AV) RB = 1 MHz, VB = 510 Hz
<b>Input Power (System)</b>	120Vac, 60Hz	<b>Environmental Conditions</b>	25°C, 68% RH
<b>Tested By</b>	Tom Yang		

**Antenna Polarity & Test Distance : Horizontal at 3 m**

No	Frequency (MHz)	Emission Level (dBuV/m)	Limit (dBuV/m)	Margin (dB)	Antenna Height (m)	Table Angle (Degree)	Raw Value (dBuV)	Correction Factor (dB/m)
1	#14230.00	42.0 PK	88.2	-46.2	2.29 H	317	28.5	13.5
2	#14230.00	29.5 AV	68.2	-38.7	2.29 H	317	16.0	13.5
3	21345.00	42.8 PK	74.0	-31.2	1.58 H	134	46.6	-3.8
4	21345.00	32.3 AV	54.0	-21.7	1.58 H	134	36.1	-3.8
5	#28460.00	44.2 PK	88.2	-44.0	2.75 H	167	45.5	-1.3
6	#28460.00	34.3 AV	68.2	-33.9	2.75 H	167	35.6	-1.3

**Antenna Polarity & Test Distance : Vertical at 3 m**

No	Frequency (MHz)	Emission Level (dBuV/m)	Limit (dBuV/m)	Margin (dB)	Antenna Height (m)	Table Angle (Degree)	Raw Value (dBuV)	Correction Factor (dB/m)
1	#14230.00	43.6 PK	88.2	-44.6	1.19 V	165	30.1	13.5
2	#14230.00	30.3 AV	68.2	-37.9	1.19 V	165	16.8	13.5
3	21345.00	43.3 PK	74.0	-30.7	1.88 V	253	47.1	-3.8
4	21345.00	32.5 AV	54.0	-21.5	1.88 V	253	36.3	-3.8
5	#28460.00	44.1 PK	88.2	-44.1	2.16 V	327	45.4	-1.3
6	#28460.00	33.2 AV	68.2	-35.0	2.16 V	327	34.5	-1.3

**Remarks:**

1. Emission Level(dBuV/m) = Raw Value(dBuV) + Correction Factor(dB/m)
2. Correction Factor(dB/m) = Antenna Factor(dB/m) + Cable Factor(dB) – Pre-Amplifier Factor(dB)
3. Margin value = Emission Level – Limit value
4. The other emission levels were very low against the limit.
5. " # ": The radiated frequency is out of the restricted band.



<b>RF Mode</b>	TX 802.11ax (HE20)	<b>Channel</b>	CH 1 : 5955 MHz
<b>Frequency Range</b>	1 GHz ~ 40 GHz	<b>Detector Function &amp; Bandwidth</b>	(PK) RB = 1 MHz, VB = 3 MHz (AV) RB = 1 MHz, VB = 300 Hz
<b>Input Power (System)</b>	120Vac, 60Hz	<b>Environmental Conditions</b>	25°C, 68% RH
<b>Tested By</b>	Tom Yang		

**Antenna Polarity & Test Distance : Horizontal at 3 m**

No	Frequency (MHz)	Emission Level (dBuV/m)	Limit (dBuV/m)	Margin (dB)	Antenna Height (m)	Table Angle (Degree)	Raw Value (dBuV)	Correction Factor (dB/m)
1	11910.00	42.6 PK	74.0	-31.4	2.40 H	356	31.7	10.9
2	11910.00	29.7 AV	54.0	-24.3	2.40 H	356	18.8	10.9
3	17865.00	43.4 PK	74.0	-30.6	1.57 H	122	21.8	21.6
4	17865.00	32.3 AV	54.0	-21.7	1.57 H	122	10.7	21.6
5	23820.00	44.6 PK	74.0	-29.4	2.65 H	168	47.0	-2.4
6	23820.00	34.8 AV	54.0	-19.2	2.65 H	168	37.2	-2.4

**Antenna Polarity & Test Distance : Vertical at 3 m**

No	Frequency (MHz)	Emission Level (dBuV/m)	Limit (dBuV/m)	Margin (dB)	Antenna Height (m)	Table Angle (Degree)	Raw Value (dBuV)	Correction Factor (dB/m)
1	11910.00	43.3 PK	74.0	-30.7	1.30 V	195	32.4	10.9
2	11910.00	30.0 AV	54.0	-24.0	1.30 V	195	19.1	10.9
3	17865.00	43.5 PK	74.0	-30.5	1.75 V	242	21.9	21.6
4	17865.00	32.5 AV	54.0	-21.5	1.75 V	242	10.9	21.6
5	23820.00	43.9 PK	74.0	-30.1	2.21 V	332	46.3	-2.4
6	23820.00	33.5 AV	54.0	-20.5	2.21 V	332	35.9	-2.4

**Remarks:**

1. Emission Level(dBuV/m) = Raw Value(dBuV) + Correction Factor(dB/m)
2. Correction Factor(dB/m) = Antenna Factor(dB/m) + Cable Factor(dB) – Pre-Amplifier Factor(dB)
3. Margin value = Emission Level – Limit value
4. The other emission levels were very low against the limit.

<b>RF Mode</b>	TX 802.11ax (HE20)	<b>Channel</b>	CH 233 : 7115 MHz
<b>Frequency Range</b>	1 GHz ~ 40 GHz	<b>Detector Function &amp; Bandwidth</b>	(PK) RB = 1 MHz, VB = 3 MHz (AV) RB = 1 MHz, VB = 300 Hz
<b>Input Power (System)</b>	120Vac, 60Hz	<b>Environmental Conditions</b>	25°C, 68% RH
<b>Tested By</b>	Tom Yang		

**Antenna Polarity & Test Distance : Horizontal at 3 m**

No	Frequency (MHz)	Emission Level (dBuV/m)	Limit (dBuV/m)	Margin (dB)	Antenna Height (m)	Table Angle (Degree)	Raw Value (dBuV)	Correction Factor (dB/m)
1	#14230.00	43.1 PK	88.2	-45.1	2.31 H	352	29.6	13.5
2	#14230.00	30.0 AV	68.2	-38.2	2.31 H	352	16.5	13.5
3	21345.00	43.2 PK	74.0	-30.8	1.71 H	141	47.0	-3.8
4	21345.00	33.0 AV	54.0	-21.0	1.71 H	141	36.8	-3.8
5	#28460.00	44.8 PK	88.2	-43.4	2.68 H	162	46.1	-1.3
6	#28460.00	34.4 AV	68.2	-33.8	2.68 H	162	35.7	-1.3

**Antenna Polarity & Test Distance : Vertical at 3 m**

No	Frequency (MHz)	Emission Level (dBuV/m)	Limit (dBuV/m)	Margin (dB)	Antenna Height (m)	Table Angle (Degree)	Raw Value (dBuV)	Correction Factor (dB/m)
1	#14230.00	43.7 PK	88.2	-44.5	1.20 V	159	30.2	13.5
2	#14230.00	30.5 AV	68.2	-37.7	1.20 V	159	17.0	13.5
3	21345.00	43.5 PK	74.0	-30.5	1.79 V	237	47.3	-3.8
4	21345.00	32.0 AV	54.0	-22.0	1.79 V	237	35.8	-3.8
5	#28460.00	44.3 PK	88.2	-43.9	2.14 V	306	45.6	-1.3
6	#28460.00	34.1 AV	68.2	-34.1	2.14 V	306	35.4	-1.3

**Remarks:**

1. Emission Level(dBuV/m) = Raw Value(dBuV) + Correction Factor(dB/m)
2. Correction Factor(dB/m) = Antenna Factor(dB/m) + Cable Factor(dB) – Pre-Amplifier Factor(dB)
3. Margin value = Emission Level – Limit value
4. The other emission levels were very low against the limit.
5. "#": The radiated frequency is out of the restricted band.

<b>RF Mode</b>	TX 802.11ax (HE40)	<b>Channel</b>	CH 3 : 5965 MHz
<b>Frequency Range</b>	1 GHz ~ 40 GHz	<b>Detector Function &amp; Bandwidth</b>	(PK) RB = 1 MHz, VB = 3 MHz (AV) RB = 1 MHz, VB = 300 Hz
<b>Input Power (System)</b>	120Vac, 60Hz	<b>Environmental Conditions</b>	25°C, 68% RH
<b>Tested By</b>	Tom Yang		

**Antenna Polarity & Test Distance : Horizontal at 3 m**

No	Frequency (MHz)	Emission Level (dBuV/m)	Limit (dBuV/m)	Margin (dB)	Antenna Height (m)	Table Angle (Degree)	Raw Value (dBuV)	Correction Factor (dB/m)
1	11930.00	43.5 PK	74.0	-30.5	2.23 H	343	32.6	10.9
2	11930.00	30.6 AV	54.0	-23.4	2.23 H	343	19.7	10.9
3	17895.00	41.1 PK	74.0	-32.9	1.71 H	133	18.9	22.2
4	17895.00	31.1 AV	54.0	-22.9	1.71 H	133	8.9	22.2
5	23860.00	43.9 PK	74.0	-30.1	2.61 H	207	46.3	-2.4
6	23860.00	33.6 AV	54.0	-20.4	2.61 H	207	36.0	-2.4

**Antenna Polarity & Test Distance : Vertical at 3 m**

No	Frequency (MHz)	Emission Level (dBuV/m)	Limit (dBuV/m)	Margin (dB)	Antenna Height (m)	Table Angle (Degree)	Raw Value (dBuV)	Correction Factor (dB/m)
1	11930.00	43.8 PK	74.0	-30.2	1.30 V	177	32.9	10.9
2	11930.00	29.6 AV	54.0	-24.4	1.30 V	177	18.7	10.9
3	17895.00	43.9 PK	74.0	-30.1	1.86 V	252	21.7	22.2
4	17895.00	32.6 AV	54.0	-21.4	1.86 V	252	10.4	22.2
5	23860.00	44.6 PK	74.0	-29.4	2.28 V	328	47.0	-2.4
6	23860.00	33.4 AV	54.0	-20.6	2.28 V	328	35.8	-2.4

**Remarks:**

1. Emission Level(dBuV/m) = Raw Value(dBuV) + Correction Factor(dB/m)
2. Correction Factor(dB/m) = Antenna Factor(dB/m) + Cable Factor(dB) – Pre-Amplifier Factor(dB)
3. Margin value = Emission Level – Limit value
4. The other emission levels were very low against the limit.

<b>RF Mode</b>	TX 802.11ax (HE40)	<b>Channel</b>	CH 227 : 7085 MHz
<b>Frequency Range</b>	1 GHz ~ 40 GHz	<b>Detector Function &amp; Bandwidth</b>	(PK) RB = 1 MHz, VB = 3 MHz (AV) RB = 1 MHz, VB = 300 Hz
<b>Input Power (System)</b>	120Vac, 60Hz	<b>Environmental Conditions</b>	25°C, 68% RH
<b>Tested By</b>	Tom Yang		

**Antenna Polarity & Test Distance : Horizontal at 3 m**

No	Frequency (MHz)	Emission Level (dBuV/m)	Limit (dBuV/m)	Margin (dB)	Antenna Height (m)	Table Angle (Degree)	Raw Value (dBuV)	Correction Factor (dB/m)
1	#14170.00	43.1 PK	88.2	-45.1	2.33 H	14	29.6	13.5
2	#14170.00	30.2 AV	68.2	-38.0	2.33 H	14	16.7	13.5
3	21255.00	43.2 PK	74.0	-30.8	1.60 H	130	47.2	-4.0
4	21255.00	33.0 AV	54.0	-21.0	1.60 H	130	37.0	-4.0
5	#28340.00	43.1 PK	88.2	-45.1	2.73 H	194	44.2	-1.1
6	#28340.00	32.9 AV	68.2	-35.3	2.73 H	194	34.0	-1.1

**Antenna Polarity & Test Distance : Vertical at 3 m**

No	Frequency (MHz)	Emission Level (dBuV/m)	Limit (dBuV/m)	Margin (dB)	Antenna Height (m)	Table Angle (Degree)	Raw Value (dBuV)	Correction Factor (dB/m)
1	#14170.00	44.0 PK	88.2	-44.2	1.33 V	169	30.5	13.5
2	#14170.00	30.8 AV	68.2	-37.4	1.33 V	169	17.3	13.5
3	21255.00	42.8 PK	74.0	-31.2	1.72 V	265	46.8	-4.0
4	21255.00	31.5 AV	54.0	-22.5	1.72 V	265	35.5	-4.0
5	#28340.00	43.3 PK	88.2	-44.9	2.15 V	302	44.4	-1.1
6	#28340.00	32.8 AV	68.2	-35.4	2.15 V	302	33.9	-1.1

**Remarks:**

1. Emission Level(dBuV/m) = Raw Value(dBuV) + Correction Factor(dB/m)
2. Correction Factor(dB/m) = Antenna Factor(dB/m) + Cable Factor(dB) – Pre-Amplifier Factor(dB)
3. Margin value = Emission Level – Limit value
4. The other emission levels were very low against the limit.
5. " # ": The radiated frequency is out of the restricted band.

<b>RF Mode</b>	TX 802.11ax (HE80)	<b>Channel</b>	CH 7 : 5985 MHz
<b>Frequency Range</b>	1 GHz ~ 40 GHz	<b>Detector Function &amp; Bandwidth</b>	(PK) RB = 1 MHz, VB = 3 MHz (AV) RB = 1 MHz, VB = 1 kHz
<b>Input Power (System)</b>	120Vac, 60Hz	<b>Environmental Conditions</b>	25°C, 68% RH
<b>Tested By</b>	Tom Yang		

**Antenna Polarity & Test Distance : Horizontal at 3 m**

No	Frequency (MHz)	Emission Level (dBuV/m)	Limit (dBuV/m)	Margin (dB)	Antenna Height (m)	Table Angle (Degree)	Raw Value (dBuV)	Correction Factor (dB/m)
1	11970.00	44.2 PK	74.0	-29.8	2.27 H	346	33.4	10.8
2	11970.00	31.3 AV	54.0	-22.7	2.27 H	346	20.5	10.8
3	17955.00	42.9 PK	74.0	-31.1	1.71 H	95	19.4	23.5
4	17955.00	32.8 AV	54.0	-21.2	1.71 H	95	9.3	23.5
5	23940.00	43.7 PK	74.0	-30.3	2.59 H	202	45.9	-2.2
6	23940.00	33.3 AV	54.0	-20.7	2.59 H	202	35.5	-2.2

**Antenna Polarity & Test Distance : Vertical at 3 m**

No	Frequency (MHz)	Emission Level (dBuV/m)	Limit (dBuV/m)	Margin (dB)	Antenna Height (m)	Table Angle (Degree)	Raw Value (dBuV)	Correction Factor (dB/m)
1	11970.00	43.5 PK	74.0	-30.5	1.37 V	160	32.7	10.8
2	11970.00	30.3 AV	54.0	-23.7	1.37 V	160	19.5	10.8
3	17955.00	43.2 PK	74.0	-30.8	1.79 V	259	19.7	23.5
4	17955.00	31.7 AV	54.0	-22.3	1.79 V	259	8.2	23.5
5	23940.00	42.9 PK	74.0	-31.1	2.26 V	298	45.1	-2.2
6	23940.00	32.6 AV	54.0	-21.4	2.26 V	298	34.8	-2.2

**Remarks:**

1. Emission Level(dBuV/m) = Raw Value(dBuV) + Correction Factor(dB/m)
2. Correction Factor(dB/m) = Antenna Factor(dB/m) + Cable Factor(dB) – Pre-Amplifier Factor(dB)
3. Margin value = Emission Level – Limit value
4. The other emission levels were very low against the limit.

<b>RF Mode</b>	TX 802.11ax (HE80)	<b>Channel</b>	CH 215 : 7025 MHz
<b>Frequency Range</b>	1 GHz ~ 40 GHz	<b>Detector Function &amp; Bandwidth</b>	(PK) RB = 1 MHz, VB = 3 MHz (AV) RB = 1 MHz, VB = 1 kHz
<b>Input Power (System)</b>	120Vac, 60Hz	<b>Environmental Conditions</b>	25°C, 68% RH
<b>Tested By</b>	Tom Yang		

**Antenna Polarity & Test Distance : Horizontal at 3 m**

No	Frequency (MHz)	Emission Level (dBuV/m)	Limit (dBuV/m)	Margin (dB)	Antenna Height (m)	Table Angle (Degree)	Raw Value (dBuV)	Correction Factor (dB/m)
1	#14050.00	43.4 PK	88.2	-44.8	2.30 H	347	30.2	13.2
2	#14050.00	30.3 AV	68.2	-37.9	2.30 H	347	17.1	13.2
3	21075.00	43.4 PK	74.0	-30.6	1.62 H	123	47.5	-4.1
4	21075.00	33.3 AV	54.0	-20.7	1.62 H	123	37.4	-4.1
5	#28100.00	44.0 PK	88.2	-44.2	2.62 H	208	45.2	-1.2
6	#28100.00	34.2 AV	68.2	-34.0	2.62 H	208	35.4	-1.2

**Antenna Polarity & Test Distance : Vertical at 3 m**

No	Frequency (MHz)	Emission Level (dBuV/m)	Limit (dBuV/m)	Margin (dB)	Antenna Height (m)	Table Angle (Degree)	Raw Value (dBuV)	Correction Factor (dB/m)
1	#14050.00	43.8 PK	88.2	-44.4	1.40 V	149	30.6	13.2
2	#14050.00	30.7 AV	68.2	-37.5	1.40 V	149	17.5	13.2
3	21075.00	43.7 PK	74.0	-30.3	1.74 V	271	47.8	-4.1
4	21075.00	31.9 AV	54.0	-22.1	1.74 V	271	36.0	-4.1
5	#28100.00	43.9 PK	88.2	-44.3	2.23 V	301	45.1	-1.2
6	#28100.00	33.5 AV	68.2	-34.7	2.23 V	301	34.7	-1.2

**Remarks:**

1. Emission Level(dBuV/m) = Raw Value(dBuV) + Correction Factor(dB/m)
2. Correction Factor(dB/m) = Antenna Factor(dB/m) + Cable Factor(dB) – Pre-Amplifier Factor(dB)
3. Margin value = Emission Level – Limit value
4. The other emission levels were very low against the limit.
5. "#": The radiated frequency is out of the restricted band.

<b>RF Mode</b>	TX 802.11ax (HE160)	<b>Channel</b>	CH 15 : 6025 MHz
<b>Frequency Range</b>	1 GHz ~ 40 GHz	<b>Detector Function &amp; Bandwidth</b>	(PK) RB = 1 MHz, VB = 3 MHz (AV) RB = 1 MHz, VB = 1 kHz
<b>Input Power (System)</b>	120Vac, 60Hz	<b>Environmental Conditions</b>	25°C, 68% RH
<b>Tested By</b>	Tom Yang		

**Antenna Polarity & Test Distance : Horizontal at 3 m**

No	Frequency (MHz)	Emission Level (dBuV/m)	Limit (dBuV/m)	Margin (dB)	Antenna Height (m)	Table Angle (Degree)	Raw Value (dBuV)	Correction Factor (dB/m)
1	12050.00	43.7 PK	74.0	-30.3	2.27 H	328	32.8	10.9
2	12050.00	31.5 AV	54.0	-22.5	2.27 H	328	20.6	10.9
3	18075.00	42.5 PK	74.0	-31.5	1.69 H	110	36.7	5.8
4	18075.00	32.9 AV	54.0	-21.1	1.69 H	110	27.1	5.8
5	#24100.00	43.6 PK	88.2	-44.6	2.54 H	225	45.8	-2.2
6	#24100.00	33.6 AV	68.2	-34.6	2.54 H	225	35.8	-2.2

**Antenna Polarity & Test Distance : Vertical at 3 m**

No	Frequency (MHz)	Emission Level (dBuV/m)	Limit (dBuV/m)	Margin (dB)	Antenna Height (m)	Table Angle (Degree)	Raw Value (dBuV)	Correction Factor (dB/m)
1	12050.00	42.8 PK	74.0	-31.2	1.31 V	137	31.9	10.9
2	12050.00	29.8 AV	54.0	-24.2	1.31 V	137	18.9	10.9
3	18075.00	42.9 PK	74.0	-31.1	1.70 V	281	37.1	5.8
4	18075.00	31.3 AV	54.0	-22.7	1.70 V	281	25.5	5.8
5	#24100.00	44.9 PK	88.2	-43.3	2.11 V	312	47.1	-2.2
6	#24100.00	33.8 AV	68.2	-34.4	2.11 V	312	36.0	-2.2

**Remarks:**

1. Emission Level(dBuV/m) = Raw Value(dBuV) + Correction Factor(dB/m)
2. Correction Factor(dB/m) = Antenna Factor(dB/m) + Cable Factor(dB) – Pre-Amplifier Factor(dB)
3. Margin value = Emission Level – Limit value
4. The other emission levels were very low against the limit.
5. " # ": The radiated frequency is out of the restricted band.

<b>RF Mode</b>	TX 802.11ax (HE160)	<b>Channel</b>	CH 47 : 6185 MHz
<b>Frequency Range</b>	1 GHz ~ 40 GHz	<b>Detector Function &amp; Bandwidth</b>	(PK) RB = 1 MHz, VB = 3 MHz (AV) RB = 1 MHz, VB = 1 kHz
<b>Input Power (System)</b>	120Vac, 60Hz	<b>Environmental Conditions</b>	25°C, 68% RH
<b>Tested By</b>	Tom Yang		

**Antenna Polarity & Test Distance : Horizontal at 3 m**

No	Frequency (MHz)	Emission Level (dBuV/m)	Limit (dBuV/m)	Margin (dB)	Antenna Height (m)	Table Angle (Degree)	Raw Value (dBuV)	Correction Factor (dB/m)
1	12370.00	43.2 PK	74.0	-30.8	2.34 H	355	33.2	10.0
2	12370.00	30.3 AV	54.0	-23.7	2.34 H	355	20.3	10.0
3	18555.00	43.1 PK	74.0	-30.9	1.79 H	107	50.1	-7.0
4	18555.00	33.1 AV	54.0	-20.9	1.79 H	107	40.1	-7.0
5	#24740.00	44.1 PK	88.2	-44.1	2.64 H	234	45.6	-1.5
6	#24740.00	34.5 AV	68.2	-33.7	2.64 H	234	36.0	-1.5

**Antenna Polarity & Test Distance : Vertical at 3 m**

No	Frequency (MHz)	Emission Level (dBuV/m)	Limit (dBuV/m)	Margin (dB)	Antenna Height (m)	Table Angle (Degree)	Raw Value (dBuV)	Correction Factor (dB/m)
1	12370.00	43.3 PK	74.0	-30.7	1.31 V	157	33.3	10.0
2	12370.00	30.3 AV	54.0	-23.7	1.31 V	157	20.3	10.0
3	18555.00	42.4 PK	74.0	-31.6	1.69 V	270	49.4	-7.0
4	18555.00	30.7 AV	54.0	-23.3	1.69 V	270	37.7	-7.0
5	#24740.00	44.2 PK	88.2	-44.0	2.08 V	312	45.7	-1.5
6	#24740.00	33.5 AV	68.2	-34.7	2.08 V	312	35.0	-1.5

**Remarks:**

1. Emission Level(dBuV/m) = Raw Value(dBuV) + Correction Factor(dB/m)
2. Correction Factor(dB/m) = Antenna Factor(dB/m) + Cable Factor(dB) – Pre-Amplifier Factor(dB)
3. Margin value = Emission Level – Limit value
4. The other emission levels were very low against the limit.
5. "#": The radiated frequency is out of the restricted band.



<b>RF Mode</b>	TX 802.11ax (HE160)	<b>Channel</b>	CH 79 : 6345 MHz
<b>Frequency Range</b>	1 GHz ~ 40 GHz	<b>Detector Function &amp; Bandwidth</b>	(PK) RB = 1 MHz, VB = 3 MHz (AV) RB = 1 MHz, VB = 1 kHz
<b>Input Power (System)</b>	120Vac, 60Hz	<b>Environmental Conditions</b>	25°C, 68% RH
<b>Tested By</b>	Tom Yang		

**Antenna Polarity & Test Distance : Horizontal at 3 m**

No	Frequency (MHz)	Emission Level (dBuV/m)	Limit (dBuV/m)	Margin (dB)	Antenna Height (m)	Table Angle (Degree)	Raw Value (dBuV)	Correction Factor (dB/m)
1	12690.00	43.3 PK	74.0	-30.7	2.32 H	345	33.0	10.3
2	12690.00	30.0 AV	54.0	-24.0	2.32 H	345	19.7	10.3
3	19035.00	43.5 PK	74.0	-30.5	1.68 H	128	50.1	-6.6
4	19035.00	33.2 AV	54.0	-20.8	1.68 H	128	39.8	-6.6
5	#25380.00	44.5 PK	88.2	-43.7	2.57 H	198	45.9	-1.4
6	#25380.00	34.5 AV	68.2	-33.7	2.57 H	198	35.9	-1.4

**Antenna Polarity & Test Distance : Vertical at 3 m**

No	Frequency (MHz)	Emission Level (dBuV/m)	Limit (dBuV/m)	Margin (dB)	Antenna Height (m)	Table Angle (Degree)	Raw Value (dBuV)	Correction Factor (dB/m)
1	12690.00	43.7 PK	74.0	-30.3	1.37 V	178	33.4	10.3
2	12690.00	31.3 AV	54.0	-22.7	1.37 V	178	21.0	10.3
3	19035.00	42.6 PK	74.0	-31.4	1.77 V	257	49.2	-6.6
4	19035.00	31.0 AV	54.0	-23.0	1.77 V	257	37.6	-6.6
5	#25380.00	43.4 PK	88.2	-44.8	2.08 V	302	44.8	-1.4
6	#25380.00	33.3 AV	68.2	-34.9	2.08 V	302	34.7	-1.4

**Remarks:**

1. Emission Level(dBuV/m) = Raw Value(dBuV) + Correction Factor(dB/m)
2. Correction Factor(dB/m) = Antenna Factor(dB/m) + Cable Factor(dB) – Pre-Amplifier Factor(dB)
3. Margin value = Emission Level – Limit value
4. The other emission levels were very low against the limit.
5. " # ": The radiated frequency is out of the restricted band.

<b>RF Mode</b>	TX 802.11ax (HE160)	<b>Channel</b>	CH 111 : 6505 MHz
<b>Frequency Range</b>	1 GHz ~ 40 GHz	<b>Detector Function &amp; Bandwidth</b>	(PK) RB = 1 MHz, VB = 3 MHz (AV) RB = 1 MHz, VB = 1 kHz
<b>Input Power (System)</b>	120Vac, 60Hz	<b>Environmental Conditions</b>	25°C, 68% RH
<b>Tested By</b>	Tom Yang		

**Antenna Polarity & Test Distance : Horizontal at 3 m**

No	Frequency (MHz)	Emission Level (dBuV/m)	Limit (dBuV/m)	Margin (dB)	Antenna Height (m)	Table Angle (Degree)	Raw Value (dBuV)	Correction Factor (dB/m)
1	#13010.00	43.8 PK	88.2	-44.4	2.39 H	347	33.2	10.6
2	#13010.00	31.6 AV	68.2	-36.6	2.39 H	347	21.0	10.6
3	19515.00	42.6 PK	74.0	-31.4	1.79 H	110	48.8	-6.2
4	19515.00	33.0 AV	54.0	-21.0	1.79 H	110	39.2	-6.2
5	#26020.00	43.7 PK	88.2	-44.5	2.62 H	236	44.7	-1.0
6	#26020.00	33.7 AV	68.2	-34.5	2.62 H	236	34.7	-1.0

**Antenna Polarity & Test Distance : Vertical at 3 m**

No	Frequency (MHz)	Emission Level (dBuV/m)	Limit (dBuV/m)	Margin (dB)	Antenna Height (m)	Table Angle (Degree)	Raw Value (dBuV)	Correction Factor (dB/m)
1	#13010.00	44.3 PK	88.2	-43.9	1.34 V	183	33.7	10.6
2	#13010.00	31.4 AV	68.2	-36.8	1.34 V	183	20.8	10.6
3	19515.00	43.1 PK	74.0	-30.9	1.80 V	279	49.3	-6.2
4	19515.00	31.5 AV	54.0	-22.5	1.80 V	279	37.7	-6.2
5	#26020.00	43.0 PK	88.2	-45.2	2.13 V	315	44.0	-1.0
6	#26020.00	32.8 AV	68.2	-35.4	2.13 V	315	33.8	-1.0

**Remarks:**

1. Emission Level(dBuV/m) = Raw Value(dBuV) + Correction Factor(dB/m)
2. Correction Factor(dB/m) = Antenna Factor(dB/m) + Cable Factor(dB) – Pre-Amplifier Factor(dB)
3. Margin value = Emission Level – Limit value
4. The other emission levels were very low against the limit.
5. " # ": The radiated frequency is out of the restricted band.

<b>RF Mode</b>	TX 802.11ax (HE160)	<b>Channel</b>	CH 143 : 6665 MHz
<b>Frequency Range</b>	1 GHz ~ 40 GHz	<b>Detector Function &amp; Bandwidth</b>	(PK) RB = 1 MHz, VB = 3 MHz (AV) RB = 1 MHz, VB = 1 kHz
<b>Input Power (System)</b>	120Vac, 60Hz	<b>Environmental Conditions</b>	25°C, 68% RH
<b>Tested By</b>	Tom Yang		

**Antenna Polarity & Test Distance : Horizontal at 3 m**

No	Frequency (MHz)	Emission Level (dBuV/m)	Limit (dBuV/m)	Margin (dB)	Antenna Height (m)	Table Angle (Degree)	Raw Value (dBuV)	Correction Factor (dB/m)
1	13330.00	43.1 PK	74.0	-30.9	2.38 H	339	31.4	11.7
2	13330.00	30.4 AV	54.0	-23.6	2.38 H	339	18.7	11.7
3	19995.00	43.4 PK	74.0	-30.6	1.76 H	104	49.0	-5.6
4	19995.00	33.5 AV	54.0	-20.5	1.76 H	104	39.1	-5.6
5	#26660.00	44.5 PK	88.2	-43.7	2.63 H	227	45.2	-0.7
6	#26660.00	34.8 AV	68.2	-33.4	2.63 H	227	35.5	-0.7

**Antenna Polarity & Test Distance : Vertical at 3 m**

No	Frequency (MHz)	Emission Level (dBuV/m)	Limit (dBuV/m)	Margin (dB)	Antenna Height (m)	Table Angle (Degree)	Raw Value (dBuV)	Correction Factor (dB/m)
1	13330.00	43.1 PK	74.0	-30.9	1.32 V	152	31.4	11.7
2	13330.00	30.3 AV	54.0	-23.7	1.32 V	152	18.6	11.7
3	19995.00	41.8 PK	74.0	-32.2	1.74 V	275	47.4	-5.6
4	19995.00	30.3 AV	54.0	-23.7	1.74 V	275	35.9	-5.6
5	#26660.00	43.6 PK	88.2	-44.6	2.10 V	319	44.3	-0.7
6	#26660.00	33.1 AV	68.2	-35.1	2.10 V	319	33.8	-0.7

**Remarks:**

1. Emission Level(dBuV/m) = Raw Value(dBuV) + Correction Factor(dB/m)
2. Correction Factor(dB/m) = Antenna Factor(dB/m) + Cable Factor(dB) – Pre-Amplifier Factor(dB)
3. Margin value = Emission Level – Limit value
4. The other emission levels were very low against the limit.
5. "#": The radiated frequency is out of the restricted band.

<b>RF Mode</b>	TX 802.11ax (HE160)	<b>Channel</b>	CH 175 : 6825 MHz
<b>Frequency Range</b>	1 GHz ~ 40 GHz	<b>Detector Function &amp; Bandwidth</b>	(PK) RB = 1 MHz, VB = 3 MHz (AV) RB = 1 MHz, VB = 1 kHz
<b>Input Power (System)</b>	120Vac, 60Hz	<b>Environmental Conditions</b>	25°C, 68% RH
<b>Tested By</b>	Tom Yang		

**Antenna Polarity & Test Distance : Horizontal at 3 m**

No	Frequency (MHz)	Emission Level (dBuV/m)	Limit (dBuV/m)	Margin (dB)	Antenna Height (m)	Table Angle (Degree)	Raw Value (dBuV)	Correction Factor (dB/m)
1	#13650.00	42.8 PK	88.2	-45.4	2.35 H	352	29.9	12.9
2	#13650.00	29.7 AV	68.2	-38.5	2.35 H	352	16.8	12.9
3	20475.00	43.6 PK	74.0	-30.4	1.63 H	118	48.4	-4.8
4	20475.00	33.5 AV	54.0	-20.5	1.63 H	118	38.3	-4.8
5	#27300.00	44.5 PK	88.2	-43.7	2.52 H	205	45.5	-1.0
6	#27300.00	34.7 AV	68.2	-33.5	2.52 H	205	35.7	-1.0

**Antenna Polarity & Test Distance : Vertical at 3 m**

No	Frequency (MHz)	Emission Level (dBuV/m)	Limit (dBuV/m)	Margin (dB)	Antenna Height (m)	Table Angle (Degree)	Raw Value (dBuV)	Correction Factor (dB/m)
1	#13650.00	43.5 PK	88.2	-44.7	1.29 V	129	30.6	12.9
2	#13650.00	30.2 AV	68.2	-38.0	1.29 V	129	17.3	12.9
3	20475.00	42.9 PK	74.0	-31.1	1.74 V	271	47.7	-4.8
4	20475.00	31.1 AV	54.0	-22.9	1.74 V	271	35.9	-4.8
5	#27300.00	45.2 PK	88.2	-43.0	2.16 V	319	46.2	-1.0
6	#27300.00	34.3 AV	68.2	-33.9	2.16 V	319	35.3	-1.0

**Remarks:**

1. Emission Level(dBuV/m) = Raw Value(dBuV) + Correction Factor(dB/m)
2. Correction Factor(dB/m) = Antenna Factor(dB/m) + Cable Factor(dB) – Pre-Amplifier Factor(dB)
3. Margin value = Emission Level – Limit value
4. The other emission levels were very low against the limit.
5. "#": The radiated frequency is out of the restricted band.

<b>RF Mode</b>	TX 802.11ax (HE160)	<b>Channel</b>	CH 207 : 6985 MHz
<b>Frequency Range</b>	1 GHz ~ 40 GHz	<b>Detector Function &amp; Bandwidth</b>	(PK) RB = 1 MHz, VB = 3 MHz (AV) RB = 1 MHz, VB = 1 kHz
<b>Input Power (System)</b>	120Vac, 60Hz	<b>Environmental Conditions</b>	25°C, 68% RH
<b>Tested By</b>	Tom Yang		

**Antenna Polarity & Test Distance : Horizontal at 3 m**

No	Frequency (MHz)	Emission Level (dBuV/m)	Limit (dBuV/m)	Margin (dB)	Antenna Height (m)	Table Angle (Degree)	Raw Value (dBuV)	Correction Factor (dB/m)
1	#13970.00	43.2 PK	88.2	-45.0	2.38 H	356	30.1	13.1
2	#13970.00	29.9 AV	68.2	-38.3	2.38 H	356	16.8	13.1
3	20955.00	43.5 PK	74.0	-30.5	1.71 H	134	47.6	-4.1
4	20955.00	33.3 AV	54.0	-20.7	1.71 H	134	37.4	-4.1
5	#27940.00	44.3 PK	88.2	-43.9	2.54 H	199	45.4	-1.1
6	#27940.00	34.3 AV	68.2	-33.9	2.54 H	199	35.4	-1.1

**Antenna Polarity & Test Distance : Vertical at 3 m**

No	Frequency (MHz)	Emission Level (dBuV/m)	Limit (dBuV/m)	Margin (dB)	Antenna Height (m)	Table Angle (Degree)	Raw Value (dBuV)	Correction Factor (dB/m)
1	#13970.00	44.2 PK	88.2	-44.0	1.30 V	130	31.1	13.1
2	#13970.00	30.7 AV	68.2	-37.5	1.30 V	130	17.6	13.1
3	20955.00	43.1 PK	74.0	-30.9	1.77 V	269	47.2	-4.1
4	20955.00	31.3 AV	54.0	-22.7	1.77 V	269	35.4	-4.1
5	#27940.00	45.5 PK	88.2	-42.7	2.18 V	307	46.6	-1.1
6	#27940.00	34.7 AV	68.2	-33.5	2.18 V	307	35.8	-1.1

**Remarks:**

1. Emission Level(dBuV/m) = Raw Value(dBuV) + Correction Factor(dB/m)
2. Correction Factor(dB/m) = Antenna Factor(dB/m) + Cable Factor(dB) – Pre-Amplifier Factor(dB)
3. Margin value = Emission Level – Limit value
4. The other emission levels were very low against the limit.
5. "#": The radiated frequency is out of the restricted band.

<b>RF Mode</b>	TX 802.11be (EHT20)	<b>Channel</b>	CH 1 : 5955 MHz
<b>Frequency Range</b>	1 GHz ~ 40 GHz	<b>Detector Function &amp; Bandwidth</b>	(PK) RB = 1 MHz, VB = 3 MHz (AV) RB = 1 MHz, VB = 300 Hz
<b>Input Power (System)</b>	120Vac, 60Hz	<b>Environmental Conditions</b>	25°C, 68% RH
<b>Tested By</b>	Tom Yang		

**Antenna Polarity & Test Distance : Horizontal at 3 m**

No	Frequency (MHz)	Emission Level (dBuV/m)	Limit (dBuV/m)	Margin (dB)	Antenna Height (m)	Table Angle (Degree)	Raw Value (dBuV)	Correction Factor (dB/m)
1	11910.00	43.5 PK	74.0	-30.5	2.30 H	318	32.6	10.9
2	11910.00	30.7 AV	54.0	-23.3	2.30 H	318	19.8	10.9
3	17865.00	43.4 PK	74.0	-30.6	1.45 H	146	21.8	21.6
4	17865.00	32.6 AV	54.0	-21.4	1.45 H	146	11.0	21.6
5	23820.00	42.3 PK	74.0	-31.7	2.74 H	180	44.7	-2.4
6	23820.00	32.7 AV	54.0	-21.3	2.74 H	180	35.1	-2.4

**Antenna Polarity & Test Distance : Vertical at 3 m**

No	Frequency (MHz)	Emission Level (dBuV/m)	Limit (dBuV/m)	Margin (dB)	Antenna Height (m)	Table Angle (Degree)	Raw Value (dBuV)	Correction Factor (dB/m)
1	11910.00	43.4 PK	74.0	-30.6	1.28 V	131	32.5	10.9
2	11910.00	30.2 AV	54.0	-23.8	1.28 V	131	19.3	10.9
3	17865.00	43.0 PK	74.0	-31.0	1.78 V	267	21.4	21.6
4	17865.00	31.4 AV	54.0	-22.6	1.78 V	267	9.8	21.6
5	23820.00	45.2 PK	74.0	-28.8	2.16 V	326	47.6	-2.4
6	23820.00	34.5 AV	54.0	-19.5	2.16 V	326	36.9	-2.4

**Remarks:**

1. Emission Level(dBuV/m) = Raw Value(dBuV) + Correction Factor(dB/m)
2. Correction Factor(dB/m) = Antenna Factor(dB/m) + Cable Factor(dB) – Pre-Amplifier Factor(dB)
3. Margin value = Emission Level – Limit value
4. The other emission levels were very low against the limit.

<b>RF Mode</b>	TX 802.11be (EHT20)	<b>Channel</b>	CH 45 : 6175 MHz
<b>Frequency Range</b>	1 GHz ~ 40 GHz	<b>Detector Function &amp; Bandwidth</b>	(PK) RB = 1 MHz, VB = 3 MHz (AV) RB = 1 MHz, VB = 300 Hz
<b>Input Power (System)</b>	120Vac, 60Hz	<b>Environmental Conditions</b>	25°C, 68% RH
<b>Tested By</b>	Tom Yang		

**Antenna Polarity & Test Distance : Horizontal at 3 m**

No	Frequency (MHz)	Emission Level (dBuV/m)	Limit (dBuV/m)	Margin (dB)	Antenna Height (m)	Table Angle (Degree)	Raw Value (dBuV)	Correction Factor (dB/m)
1	12350.00	43.5 PK	74.0	-30.5	2.24 H	344	33.5	10.0
2	12350.00	30.3 AV	54.0	-23.7	2.24 H	344	20.3	10.0
3	18525.00	43.0 PK	74.0	-31.0	1.57 H	134	50.1	-7.1
4	18525.00	32.4 AV	54.0	-21.6	1.57 H	134	39.5	-7.1
5	#24700.00	45.1 PK	88.2	-43.1	2.73 H	181	46.7	-1.6
6	#24700.00	34.9 AV	68.2	-33.3	2.73 H	181	36.5	-1.6

**Antenna Polarity & Test Distance : Vertical at 3 m**

No	Frequency (MHz)	Emission Level (dBuV/m)	Limit (dBuV/m)	Margin (dB)	Antenna Height (m)	Table Angle (Degree)	Raw Value (dBuV)	Correction Factor (dB/m)
1	12350.00	43.6 PK	74.0	-30.4	1.41 V	153	33.6	10.0
2	12350.00	30.4 AV	54.0	-23.6	1.41 V	153	20.4	10.0
3	18525.00	43.9 PK	74.0	-30.1	1.73 V	297	51.0	-7.1
4	18525.00	31.7 AV	54.0	-22.3	1.73 V	297	38.8	-7.1
5	#24700.00	44.1 PK	88.2	-44.1	2.24 V	329	45.7	-1.6
6	#24700.00	34.1 AV	68.2	-34.1	2.24 V	329	35.7	-1.6

**Remarks:**

1. Emission Level(dBuV/m) = Raw Value(dBuV) + Correction Factor(dB/m)
2. Correction Factor(dB/m) = Antenna Factor(dB/m) + Cable Factor(dB) – Pre-Amplifier Factor(dB)
3. Margin value = Emission Level – Limit value
4. The other emission levels were very low against the limit.
5. "#": The radiated frequency is out of the restricted band.

<b>RF Mode</b>	TX 802.11be (EHT20)	<b>Channel</b>	CH 93 : 6415 MHz
<b>Frequency Range</b>	1 GHz ~ 40 GHz	<b>Detector Function &amp; Bandwidth</b>	(PK) RB = 1 MHz, VB = 3 MHz (AV) RB = 1 MHz, VB = 300 Hz
<b>Input Power (System)</b>	120Vac, 60Hz	<b>Environmental Conditions</b>	25°C, 68% RH
<b>Tested By</b>	Tom Yang		

**Antenna Polarity & Test Distance : Horizontal at 3 m**

No	Frequency (MHz)	Emission Level (dBuV/m)	Limit (dBuV/m)	Margin (dB)	Antenna Height (m)	Table Angle (Degree)	Raw Value (dBuV)	Correction Factor (dB/m)
1	#12830.00	44.3 PK	88.2	-43.9	2.28 H	333	33.8	10.5
2	#12830.00	31.1 AV	68.2	-37.1	2.28 H	333	20.6	10.5
3	19245.00	43.3 PK	74.0	-30.7	1.62 H	162	49.8	-6.5
4	19245.00	32.2 AV	54.0	-21.8	1.62 H	162	38.7	-6.5
5	#25660.00	43.2 PK	88.2	-45.0	2.76 H	183	44.4	-1.2
6	#25660.00	32.7 AV	68.2	-35.5	2.76 H	183	33.9	-1.2

**Antenna Polarity & Test Distance : Vertical at 3 m**

No	Frequency (MHz)	Emission Level (dBuV/m)	Limit (dBuV/m)	Margin (dB)	Antenna Height (m)	Table Angle (Degree)	Raw Value (dBuV)	Correction Factor (dB/m)
1	#12830.00	43.8 PK	88.2	-44.4	1.42 V	161	33.3	10.5
2	#12830.00	30.4 AV	68.2	-37.8	1.42 V	161	19.9	10.5
3	19245.00	43.8 PK	74.0	-30.2	1.78 V	284	50.3	-6.5
4	19245.00	31.7 AV	54.0	-22.3	1.78 V	284	38.2	-6.5
5	#25660.00	43.8 PK	88.2	-44.4	2.27 V	314	45.0	-1.2
6	#25660.00	33.7 AV	68.2	-34.5	2.27 V	314	34.9	-1.2

**Remarks:**

1. Emission Level(dBuV/m) = Raw Value(dBuV) + Correction Factor(dB/m)
2. Correction Factor(dB/m) = Antenna Factor(dB/m) + Cable Factor(dB) – Pre-Amplifier Factor(dB)
3. Margin value = Emission Level – Limit value
4. The other emission levels were very low against the limit.
5. "#": The radiated frequency is out of the restricted band.



<b>RF Mode</b>	TX 802.11be (EHT20)	<b>Channel</b>	CH 97 : 6435 MHz
<b>Frequency Range</b>	1 GHz ~ 40 GHz	<b>Detector Function &amp; Bandwidth</b>	(PK) RB = 1 MHz, VB = 3 MHz (AV) RB = 1 MHz, VB = 300 Hz
<b>Input Power (System)</b>	120Vac, 60Hz	<b>Environmental Conditions</b>	25°C, 68% RH
<b>Tested By</b>	Tom Yang		

**Antenna Polarity & Test Distance : Horizontal at 3 m**

No	Frequency (MHz)	Emission Level (dBuV/m)	Limit (dBuV/m)	Margin (dB)	Antenna Height (m)	Table Angle (Degree)	Raw Value (dBuV)	Correction Factor (dB/m)
1	#12870.00	42.9 PK	88.2	-45.3	2.15 H	330	32.4	10.5
2	#12870.00	30.0 AV	68.2	-38.2	2.15 H	330	19.5	10.5
3	19305.00	43.5 PK	74.0	-30.5	1.55 H	157	50.3	-6.8
4	19305.00	33.1 AV	54.0	-20.9	1.55 H	157	39.9	-6.8
5	#25740.00	44.2 PK	88.2	-44.0	2.80 H	164	45.4	-1.2
6	#25740.00	33.9 AV	68.2	-34.3	2.80 H	164	35.1	-1.2

**Antenna Polarity & Test Distance : Vertical at 3 m**

No	Frequency (MHz)	Emission Level (dBuV/m)	Limit (dBuV/m)	Margin (dB)	Antenna Height (m)	Table Angle (Degree)	Raw Value (dBuV)	Correction Factor (dB/m)
1	#12870.00	43.8 PK	88.2	-44.4	1.36 V	159	33.3	10.5
2	#12870.00	30.8 AV	68.2	-37.4	1.36 V	159	20.3	10.5
3	19305.00	42.1 PK	74.0	-31.9	1.78 V	280	48.9	-6.8
4	19305.00	30.4 AV	54.0	-23.6	1.78 V	280	37.2	-6.8
5	#25740.00	43.1 PK	88.2	-45.1	2.16 V	333	44.3	-1.2
6	#25740.00	32.8 AV	68.2	-35.4	2.16 V	333	34.0	-1.2

**Remarks:**

1. Emission Level(dBuV/m) = Raw Value(dBuV) + Correction Factor(dB/m)
2. Correction Factor(dB/m) = Antenna Factor(dB/m) + Cable Factor(dB) – Pre-Amplifier Factor(dB)
3. Margin value = Emission Level – Limit value
4. The other emission levels were very low against the limit.
5. "#": The radiated frequency is out of the restricted band.

<b>RF Mode</b>	TX 802.11be (EHT20)	<b>Channel</b>	CH 105 : 6475 MHz
<b>Frequency Range</b>	1 GHz ~ 40 GHz	<b>Detector Function &amp; Bandwidth</b>	(PK) RB = 1 MHz, VB = 3 MHz (AV) RB = 1 MHz, VB = 300 Hz
<b>Input Power (System)</b>	120Vac, 60Hz	<b>Environmental Conditions</b>	25°C, 68% RH
<b>Tested By</b>	Tom Yang		

**Antenna Polarity & Test Distance : Horizontal at 3 m**

No	Frequency (MHz)	Emission Level (dBuV/m)	Limit (dBuV/m)	Margin (dB)	Antenna Height (m)	Table Angle (Degree)	Raw Value (dBuV)	Correction Factor (dB/m)
1	#12950.00	43.3 PK	88.2	-44.9	2.27 H	354	32.8	10.5
2	#12950.00	30.3 AV	68.2	-37.9	2.27 H	354	19.8	10.5
3	19425.00	43.1 PK	74.0	-30.9	1.51 H	110	49.6	-6.5
4	19425.00	32.5 AV	54.0	-21.5	1.51 H	110	39.0	-6.5
5	#25900.00	44.0 PK	88.2	-44.2	2.66 H	186	45.1	-1.1
6	#25900.00	34.3 AV	68.2	-33.9	2.66 H	186	35.4	-1.1

**Antenna Polarity & Test Distance : Vertical at 3 m**

No	Frequency (MHz)	Emission Level (dBuV/m)	Limit (dBuV/m)	Margin (dB)	Antenna Height (m)	Table Angle (Degree)	Raw Value (dBuV)	Correction Factor (dB/m)
1	#12950.00	43.3 PK	88.2	-44.9	1.34 V	138	32.8	10.5
2	#12950.00	30.2 AV	68.2	-38.0	1.34 V	138	19.7	10.5
3	19425.00	41.3 PK	74.0	-32.7	1.80 V	289	47.8	-6.5
4	19425.00	29.8 AV	54.0	-24.2	1.80 V	289	36.3	-6.5
5	#25900.00	43.3 PK	88.2	-44.9	2.15 V	310	44.4	-1.1
6	#25900.00	32.7 AV	68.2	-35.5	2.15 V	310	33.8	-1.1

**Remarks:**

1. Emission Level(dBuV/m) = Raw Value(dBuV) + Correction Factor(dB/m)
2. Correction Factor(dB/m) = Antenna Factor(dB/m) + Cable Factor(dB) – Pre-Amplifier Factor(dB)
3. Margin value = Emission Level – Limit value
4. The other emission levels were very low against the limit.
5. "#": The radiated frequency is out of the restricted band.

<b>RF Mode</b>	TX 802.11be (EHT20)	<b>Channel</b>	CH 113 : 6515 MHz
<b>Frequency Range</b>	1 GHz ~ 40 GHz	<b>Detector Function &amp; Bandwidth</b>	(PK) RB = 1 MHz, VB = 3 MHz (AV) RB = 1 MHz, VB = 300 Hz
<b>Input Power (System)</b>	120Vac, 60Hz	<b>Environmental Conditions</b>	25°C, 68% RH
<b>Tested By</b>	Tom Yang		

**Antenna Polarity & Test Distance : Horizontal at 3 m**

No	Frequency (MHz)	Emission Level (dBuV/m)	Limit (dBuV/m)	Margin (dB)	Antenna Height (m)	Table Angle (Degree)	Raw Value (dBuV)	Correction Factor (dB/m)
1	#13030.00	44.0 PK	88.2	-44.2	2.28 H	333	33.4	10.6
2	#13030.00	31.0 AV	68.2	-37.2	2.28 H	333	20.4	10.6
3	19545.00	42.4 PK	74.0	-31.6	1.64 H	158	48.6	-6.2
4	19545.00	31.9 AV	54.0	-22.1	1.64 H	158	38.1	-6.2
5	#26060.00	44.0 PK	88.2	-44.2	2.63 H	181	45.0	-1.0
6	#26060.00	33.8 AV	68.2	-34.4	2.63 H	181	34.8	-1.0

**Antenna Polarity & Test Distance : Vertical at 3 m**

No	Frequency (MHz)	Emission Level (dBuV/m)	Limit (dBuV/m)	Margin (dB)	Antenna Height (m)	Table Angle (Degree)	Raw Value (dBuV)	Correction Factor (dB/m)
1	#13030.00	43.5 PK	88.2	-44.7	1.34 V	175	32.9	10.6
2	#13030.00	29.3 AV	68.2	-38.9	1.34 V	175	18.7	10.6
3	19545.00	44.2 PK	74.0	-29.8	1.86 V	257	50.4	-6.2
4	19545.00	32.7 AV	54.0	-21.3	1.86 V	257	38.9	-6.2
5	#26060.00	44.5 PK	88.2	-43.7	2.28 V	333	45.5	-1.0
6	#26060.00	33.1 AV	68.2	-35.1	2.28 V	333	34.1	-1.0

**Remarks:**

1. Emission Level(dBuV/m) = Raw Value(dBuV) + Correction Factor(dB/m)
2. Correction Factor(dB/m) = Antenna Factor(dB/m) + Cable Factor(dB) – Pre-Amplifier Factor(dB)
3. Margin value = Emission Level – Limit value
4. The other emission levels were very low against the limit.
5. "#": The radiated frequency is out of the restricted band.

<b>RF Mode</b>	TX 802.11be (EHT20)	<b>Channel</b>	CH 117 : 6535 MHz
<b>Frequency Range</b>	1 GHz ~ 40 GHz	<b>Detector Function &amp; Bandwidth</b>	(PK) RB = 1 MHz, VB = 3 MHz (AV) RB = 1 MHz, VB = 300 Hz
<b>Input Power (System)</b>	120Vac, 60Hz	<b>Environmental Conditions</b>	25°C, 68% RH
<b>Tested By</b>	Tom Yang		

**Antenna Polarity & Test Distance : Horizontal at 3 m**

No	Frequency (MHz)	Emission Level (dBuV/m)	Limit (dBuV/m)	Margin (dB)	Antenna Height (m)	Table Angle (Degree)	Raw Value (dBuV)	Correction Factor (dB/m)
1	#13070.00	42.0 PK	88.2	-46.2	2.32 H	309	31.2	10.8
2	#13070.00	29.3 AV	68.2	-38.9	2.32 H	309	18.5	10.8
3	19605.00	42.8 PK	74.0	-31.2	1.61 H	143	48.8	-6.0
4	19605.00	32.3 AV	54.0	-21.7	1.61 H	143	38.3	-6.0
5	#26140.00	44.4 PK	88.2	-43.8	2.81 H	159	45.3	-0.9
6	#26140.00	34.3 AV	68.2	-33.9	2.81 H	159	35.2	-0.9

**Antenna Polarity & Test Distance : Vertical at 3 m**

No	Frequency (MHz)	Emission Level (dBuV/m)	Limit (dBuV/m)	Margin (dB)	Antenna Height (m)	Table Angle (Degree)	Raw Value (dBuV)	Correction Factor (dB/m)
1	#13070.00	43.6 PK	88.2	-44.6	1.19 V	151	32.8	10.8
2	#13070.00	29.8 AV	68.2	-38.4	1.19 V	151	19.0	10.8
3	19605.00	43.2 PK	74.0	-30.8	1.78 V	236	49.2	-6.0
4	19605.00	31.8 AV	54.0	-22.2	1.78 V	236	37.8	-6.0
5	#26140.00	43.9 PK	88.2	-44.3	2.20 V	317	44.8	-0.9
6	#26140.00	33.7 AV	68.2	-34.5	2.20 V	317	34.6	-0.9

**Remarks:**

1. Emission Level(dBuV/m) = Raw Value(dBuV) + Correction Factor(dB/m)
2. Correction Factor(dB/m) = Antenna Factor(dB/m) + Cable Factor(dB) – Pre-Amplifier Factor(dB)
3. Margin value = Emission Level – Limit value
4. The other emission levels were very low against the limit.
5. "#": The radiated frequency is out of the restricted band.

<b>RF Mode</b>	TX 802.11be (EHT20)	<b>Channel</b>	CH 153 : 6715 MHz
<b>Frequency Range</b>	1 GHz ~ 40 GHz	<b>Detector Function &amp; Bandwidth</b>	(PK) RB = 1 MHz, VB = 3 MHz (AV) RB = 1 MHz, VB = 300 Hz
<b>Input Power (System)</b>	120Vac, 60Hz	<b>Environmental Conditions</b>	25°C, 68% RH
<b>Tested By</b>	Tom Yang		

**Antenna Polarity & Test Distance : Horizontal at 3 m**

No	Frequency (MHz)	Emission Level (dBuV/m)	Limit (dBuV/m)	Margin (dB)	Antenna Height (m)	Table Angle (Degree)	Raw Value (dBuV)	Correction Factor (dB/m)
1	#13430.00	43.2 PK	88.2	-45.0	2.25 H	325	31.0	12.2
2	#13430.00	30.4 AV	68.2	-37.8	2.25 H	325	18.2	12.2
3	20145.00	43.6 PK	74.0	-30.4	1.75 H	135	49.2	-5.6
4	20145.00	32.8 AV	54.0	-21.2	1.75 H	135	38.4	-5.6
5	#26860.00	43.8 PK	88.2	-44.4	2.73 H	192	44.6	-0.8
6	#26860.00	33.5 AV	68.2	-34.7	2.73 H	192	34.3	-0.8

**Antenna Polarity & Test Distance : Vertical at 3 m**

No	Frequency (MHz)	Emission Level (dBuV/m)	Limit (dBuV/m)	Margin (dB)	Antenna Height (m)	Table Angle (Degree)	Raw Value (dBuV)	Correction Factor (dB/m)
1	#13430.00	42.7 PK	88.2	-45.5	1.23 V	126	30.5	12.2
2	#13430.00	29.8 AV	68.2	-38.4	1.23 V	126	17.6	12.2
3	20145.00	43.0 PK	74.0	-31.0	1.73 V	264	48.6	-5.6
4	20145.00	31.2 AV	54.0	-22.8	1.73 V	264	36.8	-5.6
5	#26860.00	45.6 PK	88.2	-42.6	2.10 V	336	46.4	-0.8
6	#26860.00	34.6 AV	68.2	-33.6	2.10 V	336	35.4	-0.8

**Remarks:**

1. Emission Level(dBuV/m) = Raw Value(dBuV) + Correction Factor(dB/m)
2. Correction Factor(dB/m) = Antenna Factor(dB/m) + Cable Factor(dB) – Pre-Amplifier Factor(dB)
3. Margin value = Emission Level – Limit value
4. The other emission levels were very low against the limit.
5. " # ": The radiated frequency is out of the restricted band.

<b>RF Mode</b>	TX 802.11be (EHT20)	<b>Channel</b>	CH 181 : 6855 MHz
<b>Frequency Range</b>	1 GHz ~ 40 GHz	<b>Detector Function &amp; Bandwidth</b>	(PK) RB = 1 MHz, VB = 3 MHz (AV) RB = 1 MHz, VB = 300 Hz
<b>Input Power (System)</b>	120Vac, 60Hz	<b>Environmental Conditions</b>	25°C, 68% RH
<b>Tested By</b>	Tom Yang		

**Antenna Polarity & Test Distance : Horizontal at 3 m**

No	Frequency (MHz)	Emission Level (dBuV/m)	Limit (dBuV/m)	Margin (dB)	Antenna Height (m)	Table Angle (Degree)	Raw Value (dBuV)	Correction Factor (dB/m)
1	#13710.00	42.8 PK	88.2	-45.4	2.31 H	352	30.0	12.8
2	#13710.00	30.1 AV	68.2	-38.1	2.31 H	352	17.3	12.8
3	20565.00	42.7 PK	74.0	-31.3	1.77 H	150	47.4	-4.7
4	20565.00	32.2 AV	54.0	-21.8	1.77 H	150	36.9	-4.7
5	#27420.00	43.7 PK	88.2	-44.5	2.69 H	202	44.6	-0.9
6	#27420.00	33.5 AV	68.2	-34.7	2.69 H	202	34.4	-0.9

**Antenna Polarity & Test Distance : Vertical at 3 m**

No	Frequency (MHz)	Emission Level (dBuV/m)	Limit (dBuV/m)	Margin (dB)	Antenna Height (m)	Table Angle (Degree)	Raw Value (dBuV)	Correction Factor (dB/m)
1	#13710.00	43.9 PK	88.2	-44.3	1.15 V	158	31.1	12.8
2	#13710.00	30.2 AV	68.2	-38.0	1.15 V	158	17.4	12.8
3	20565.00	42.9 PK	74.0	-31.1	1.84 V	222	47.6	-4.7
4	20565.00	31.5 AV	54.0	-22.5	1.84 V	222	36.2	-4.7
5	#27420.00	43.8 PK	88.2	-44.4	2.23 V	325	44.7	-0.9
6	#27420.00	33.7 AV	68.2	-34.5	2.23 V	325	34.6	-0.9

**Remarks:**

1. Emission Level(dBuV/m) = Raw Value(dBuV) + Correction Factor(dB/m)
2. Correction Factor(dB/m) = Antenna Factor(dB/m) + Cable Factor(dB) – Pre-Amplifier Factor(dB)
3. Margin value = Emission Level – Limit value
4. The other emission levels were very low against the limit.
5. "#": The radiated frequency is out of the restricted band.

<b>RF Mode</b>	TX 802.11be (EHT20)	<b>Channel</b>	CH 185 : 6875 MHz
<b>Frequency Range</b>	1 GHz ~ 40 GHz	<b>Detector Function &amp; Bandwidth</b>	(PK) RB = 1 MHz, VB = 3 MHz (AV) RB = 1 MHz, VB = 300 Hz
<b>Input Power (System)</b>	120Vac, 60Hz	<b>Environmental Conditions</b>	25°C, 68% RH
<b>Tested By</b>	Tom Yang		

**Antenna Polarity & Test Distance : Horizontal at 3 m**

No	Frequency (MHz)	Emission Level (dBuV/m)	Limit (dBuV/m)	Margin (dB)	Antenna Height (m)	Table Angle (Degree)	Raw Value (dBuV)	Correction Factor (dB/m)
1	#13750.00	42.3 PK	88.2	-45.9	2.37 H	325	29.4	12.9
2	#13750.00	29.2 AV	68.2	-39.0	2.37 H	325	16.3	12.9
3	20625.00	43.7 PK	74.0	-30.3	1.51 H	138	48.5	-4.8
4	20625.00	32.7 AV	54.0	-21.3	1.51 H	138	37.5	-4.8
5	#27500.00	44.1 PK	88.2	-44.1	2.64 H	170	45.0	-0.9
6	#27500.00	34.4 AV	68.2	-33.8	2.64 H	170	35.3	-0.9

**Antenna Polarity & Test Distance : Vertical at 3 m**

No	Frequency (MHz)	Emission Level (dBuV/m)	Limit (dBuV/m)	Margin (dB)	Antenna Height (m)	Table Angle (Degree)	Raw Value (dBuV)	Correction Factor (dB/m)
1	#13750.00	43.6 PK	88.2	-44.6	1.19 V	145	30.7	12.9
2	#13750.00	29.9 AV	68.2	-38.3	1.19 V	145	17.0	12.9
3	20625.00	42.7 PK	74.0	-31.3	1.80 V	227	47.5	-4.8
4	20625.00	31.6 AV	54.0	-22.4	1.80 V	227	36.4	-4.8
5	#27500.00	43.6 PK	88.2	-44.6	2.20 V	320	44.5	-0.9
6	#27500.00	33.6 AV	68.2	-34.6	2.20 V	320	34.5	-0.9

**Remarks:**

1. Emission Level(dBuV/m) = Raw Value(dBuV) + Correction Factor(dB/m)
2. Correction Factor(dB/m) = Antenna Factor(dB/m) + Cable Factor(dB) – Pre-Amplifier Factor(dB)
3. Margin value = Emission Level – Limit value
4. The other emission levels were very low against the limit.
5. "#": The radiated frequency is out of the restricted band.

<b>RF Mode</b>	TX 802.11be (EHT20)	<b>Channel</b>	CH 213 : 7015 MHz
<b>Frequency Range</b>	1 GHz ~ 40 GHz	<b>Detector Function &amp; Bandwidth</b>	(PK) RB = 1 MHz, VB = 3 MHz (AV) RB = 1 MHz, VB = 300 Hz
<b>Input Power (System)</b>	120Vac, 60Hz	<b>Environmental Conditions</b>	25°C, 68% RH
<b>Tested By</b>	Tom Yang		

**Antenna Polarity & Test Distance : Horizontal at 3 m**

No	Frequency (MHz)	Emission Level (dBuV/m)	Limit (dBuV/m)	Margin (dB)	Antenna Height (m)	Table Angle (Degree)	Raw Value (dBuV)	Correction Factor (dB/m)
1	#14030.00	42.1 PK	88.2	-46.1	2.29 H	312	29.0	13.1
2	#14030.00	29.2 AV	68.2	-39.0	2.29 H	312	16.1	13.1
3	21045.00	43.6 PK	74.0	-30.4	1.52 H	111	47.7	-4.1
4	21045.00	32.8 AV	54.0	-21.2	1.52 H	111	36.9	-4.1
5	#28060.00	44.2 PK	88.2	-44.0	2.74 H	164	45.4	-1.2
6	#28060.00	34.3 AV	68.2	-33.9	2.74 H	164	35.5	-1.2

**Antenna Polarity & Test Distance : Vertical at 3 m**

No	Frequency (MHz)	Emission Level (dBuV/m)	Limit (dBuV/m)	Margin (dB)	Antenna Height (m)	Table Angle (Degree)	Raw Value (dBuV)	Correction Factor (dB/m)
1	#14030.00	44.1 PK	88.2	-44.1	1.17 V	166	31.0	13.1
2	#14030.00	30.6 AV	68.2	-37.6	1.17 V	166	17.5	13.1
3	21045.00	42.4 PK	74.0	-31.6	1.90 V	229	46.5	-4.1
4	21045.00	31.0 AV	54.0	-23.0	1.90 V	229	35.1	-4.1
5	#28060.00	44.2 PK	88.2	-44.0	2.19 V	322	45.4	-1.2
6	#28060.00	34.1 AV	68.2	-34.1	2.19 V	322	35.3	-1.2

**Remarks:**

1. Emission Level(dBuV/m) = Raw Value(dBuV) + Correction Factor(dB/m)
2. Correction Factor(dB/m) = Antenna Factor(dB/m) + Cable Factor(dB) – Pre-Amplifier Factor(dB)
3. Margin value = Emission Level – Limit value
4. The other emission levels were very low against the limit.
5. "#": The radiated frequency is out of the restricted band.



<b>RF Mode</b>	TX 802.11be (EHT20)	<b>Channel</b>	CH 233 : 7115 MHz
<b>Frequency Range</b>	1 GHz ~ 40 GHz	<b>Detector Function &amp; Bandwidth</b>	(PK) RB = 1 MHz, VB = 3 MHz (AV) RB = 1 MHz, VB = 300 Hz
<b>Input Power (System)</b>	120Vac, 60Hz	<b>Environmental Conditions</b>	25°C, 68% RH
<b>Tested By</b>	Tom Yang		

**Antenna Polarity & Test Distance : Horizontal at 3 m**

No	Frequency (MHz)	Emission Level (dBuV/m)	Limit (dBuV/m)	Margin (dB)	Antenna Height (m)	Table Angle (Degree)	Raw Value (dBuV)	Correction Factor (dB/m)
1	#14230.00	42.9 PK	88.2	-45.3	2.45 H	350	29.4	13.5
2	#14230.00	30.1 AV	68.2	-38.1	2.45 H	350	16.6	13.5
3	21345.00	44.1 PK	74.0	-29.9	1.60 H	114	47.9	-3.8
4	21345.00	32.7 AV	54.0	-21.3	1.60 H	114	36.5	-3.8
5	#28460.00	44.9 PK	88.2	-43.3	2.70 H	184	46.2	-1.3
6	#28460.00	35.0 AV	68.2	-33.2	2.70 H	184	36.3	-1.3

**Antenna Polarity & Test Distance : Vertical at 3 m**

No	Frequency (MHz)	Emission Level (dBuV/m)	Limit (dBuV/m)	Margin (dB)	Antenna Height (m)	Table Angle (Degree)	Raw Value (dBuV)	Correction Factor (dB/m)
1	#14230.00	42.8 PK	88.2	-45.4	1.19 V	128	29.3	13.5
2	#14230.00	29.7 AV	68.2	-38.5	1.19 V	128	16.2	13.5
3	21345.00	43.5 PK	74.0	-30.5	1.77 V	280	47.3	-3.8
4	21345.00	31.6 AV	54.0	-22.4	1.77 V	280	35.4	-3.8
5	#28460.00	46.0 PK	88.2	-42.2	2.11 V	320	47.3	-1.3
6	#28460.00	34.8 AV	68.2	-33.4	2.11 V	320	36.1	-1.3

**Remarks:**

1. Emission Level(dBuV/m) = Raw Value(dBuV) + Correction Factor(dB/m)
2. Correction Factor(dB/m) = Antenna Factor(dB/m) + Cable Factor(dB) – Pre-Amplifier Factor(dB)
3. Margin value = Emission Level – Limit value
4. The other emission levels were very low against the limit.
5. "#": The radiated frequency is out of the restricted band.

<b>RF Mode</b>	TX 802.11be (EHT40)	<b>Channel</b>	CH 3 : 5965 MHz
<b>Frequency Range</b>	1 GHz ~ 40 GHz	<b>Detector Function &amp; Bandwidth</b>	(PK) RB = 1 MHz, VB = 3 MHz (AV) RB = 1 MHz, VB = 300 Hz
<b>Input Power (System)</b>	120Vac, 60Hz	<b>Environmental Conditions</b>	25°C, 68% RH
<b>Tested By</b>	Tom Yang		

**Antenna Polarity & Test Distance : Horizontal at 3 m**

No	Frequency (MHz)	Emission Level (dBuV/m)	Limit (dBuV/m)	Margin (dB)	Antenna Height (m)	Table Angle (Degree)	Raw Value (dBuV)	Correction Factor (dB/m)
1	11930.00	42.4 PK	74.0	-31.6	2.30 H	318	31.5	10.9
2	11930.00	29.3 AV	54.0	-24.7	2.30 H	318	18.4	10.9
3	17895.00	43.7 PK	74.0	-30.3	1.51 H	121	21.5	22.2
4	17895.00	33.2 AV	54.0	-20.8	1.51 H	121	11.0	22.2
5	23860.00	44.2 PK	74.0	-29.8	2.72 H	149	46.6	-2.4
6	23860.00	34.3 AV	54.0	-19.7	2.72 H	149	36.7	-2.4

**Antenna Polarity & Test Distance : Vertical at 3 m**

No	Frequency (MHz)	Emission Level (dBuV/m)	Limit (dBuV/m)	Margin (dB)	Antenna Height (m)	Table Angle (Degree)	Raw Value (dBuV)	Correction Factor (dB/m)
1	11930.00	43.5 PK	74.0	-30.5	1.22 V	144	32.6	10.9
2	11930.00	30.2 AV	54.0	-23.8	1.22 V	144	19.3	10.9
3	17895.00	43.2 PK	74.0	-30.8	1.75 V	280	21.0	22.2
4	17895.00	31.3 AV	54.0	-22.7	1.75 V	280	9.1	22.2
5	23860.00	45.5 PK	74.0	-28.5	2.10 V	310	47.9	-2.4
6	23860.00	34.4 AV	54.0	-19.6	2.10 V	310	36.8	-2.4

**Remarks:**

1. Emission Level(dBuV/m) = Raw Value(dBuV) + Correction Factor(dB/m)
2. Correction Factor(dB/m) = Antenna Factor(dB/m) + Cable Factor(dB) – Pre-Amplifier Factor(dB)
3. Margin value = Emission Level – Limit value
4. The other emission levels were very low against the limit.

<b>RF Mode</b>	TX 802.11be (EHT40)	<b>Channel</b>	CH 43 : 6165 MHz
<b>Frequency Range</b>	1 GHz ~ 40 GHz	<b>Detector Function &amp; Bandwidth</b>	(PK) RB = 1 MHz, VB = 3 MHz (AV) RB = 1 MHz, VB = 300 Hz
<b>Input Power (System)</b>	120Vac, 60Hz	<b>Environmental Conditions</b>	25°C, 68% RH
<b>Tested By</b>	Tom Yang		

**Antenna Polarity & Test Distance : Horizontal at 3 m**

No	Frequency (MHz)	Emission Level (dBuV/m)	Limit (dBuV/m)	Margin (dB)	Antenna Height (m)	Table Angle (Degree)	Raw Value (dBuV)	Correction Factor (dB/m)
1	12330.00	42.8 PK	74.0	-31.2	2.40 H	335	32.7	10.1
2	12330.00	29.5 AV	54.0	-24.5	2.40 H	335	19.4	10.1
3	18495.00	44.1 PK	74.0	-29.9	1.49 H	154	51.3	-7.2
4	18495.00	33.0 AV	54.0	-21.0	1.49 H	154	40.2	-7.2
5	#24660.00	44.5 PK	88.2	-43.7	2.64 H	184	46.2	-1.7
6	#24660.00	34.9 AV	68.2	-33.3	2.64 H	184	36.6	-1.7

**Antenna Polarity & Test Distance : Vertical at 3 m**

No	Frequency (MHz)	Emission Level (dBuV/m)	Limit (dBuV/m)	Margin (dB)	Antenna Height (m)	Table Angle (Degree)	Raw Value (dBuV)	Correction Factor (dB/m)
1	12330.00	43.9 PK	74.0	-30.1	1.17 V	140	33.8	10.1
2	12330.00	29.9 AV	54.0	-24.1	1.17 V	140	19.8	10.1
3	18495.00	42.8 PK	74.0	-31.2	1.79 V	219	50.0	-7.2
4	18495.00	31.7 AV	54.0	-22.3	1.79 V	219	38.9	-7.2
5	#24660.00	43.8 PK	88.2	-44.4	2.16 V	307	45.5	-1.7
6	#24660.00	33.6 AV	68.2	-34.6	2.16 V	307	35.3	-1.7

**Remarks:**

1. Emission Level(dBuV/m) = Raw Value(dBuV) + Correction Factor(dB/m)
2. Correction Factor(dB/m) = Antenna Factor(dB/m) + Cable Factor(dB) – Pre-Amplifier Factor(dB)
3. Margin value = Emission Level – Limit value
4. The other emission levels were very low against the limit.
5. "#": The radiated frequency is out of the restricted band.

<b>RF Mode</b>	TX 802.11be (EHT40)	<b>Channel</b>	CH 91 : 6405 MHz
<b>Frequency Range</b>	1 GHz ~ 40 GHz	<b>Detector Function &amp; Bandwidth</b>	(PK) RB = 1 MHz, VB = 3 MHz (AV) RB = 1 MHz, VB = 300 Hz
<b>Input Power (System)</b>	120Vac, 60Hz	<b>Environmental Conditions</b>	25°C, 68% RH
<b>Tested By</b>	Tom Yang		

**Antenna Polarity & Test Distance : Horizontal at 3 m**

No	Frequency (MHz)	Emission Level (dBuV/m)	Limit (dBuV/m)	Margin (dB)	Antenna Height (m)	Table Angle (Degree)	Raw Value (dBuV)	Correction Factor (dB/m)
1	#12810.00	41.9 PK	88.2	-46.3	2.35 H	319	31.4	10.5
2	#12810.00	28.8 AV	68.2	-39.4	2.35 H	319	18.3	10.5
3	19215.00	43.8 PK	74.0	-30.2	1.48 H	99	50.2	-6.4
4	19215.00	32.8 AV	54.0	-21.2	1.48 H	99	39.2	-6.4
5	#25620.00	44.0 PK	88.2	-44.2	2.68 H	159	45.3	-1.3
6	#25620.00	34.0 AV	68.2	-34.2	2.68 H	159	35.3	-1.3

**Antenna Polarity & Test Distance : Vertical at 3 m**

No	Frequency (MHz)	Emission Level (dBuV/m)	Limit (dBuV/m)	Margin (dB)	Antenna Height (m)	Table Angle (Degree)	Raw Value (dBuV)	Correction Factor (dB/m)
1	#12810.00	43.1 PK	88.2	-45.1	1.14 V	146	32.6	10.5
2	#12810.00	29.7 AV	68.2	-38.5	1.14 V	146	19.2	10.5
3	19215.00	42.7 PK	74.0	-31.3	1.77 V	226	49.1	-6.4
4	19215.00	31.7 AV	54.0	-22.3	1.77 V	226	38.1	-6.4
5	#25620.00	43.3 PK	88.2	-44.9	2.22 V	325	44.6	-1.3
6	#25620.00	33.4 AV	68.2	-34.8	2.22 V	325	34.7	-1.3

**Remarks:**

1. Emission Level(dBuV/m) = Raw Value(dBuV) + Correction Factor(dB/m)
2. Correction Factor(dB/m) = Antenna Factor(dB/m) + Cable Factor(dB) – Pre-Amplifier Factor(dB)
3. Margin value = Emission Level – Limit value
4. The other emission levels were very low against the limit.
5. " # ": The radiated frequency is out of the restricted band.

<b>RF Mode</b>	TX 802.11be (EHT40)	<b>Channel</b>	CH 99 : 6445 MHz
<b>Frequency Range</b>	1 GHz ~ 40 GHz	<b>Detector Function &amp; Bandwidth</b>	(PK) RB = 1 MHz, VB = 3 MHz (AV) RB = 1 MHz, VB = 300 Hz
<b>Input Power (System)</b>	120Vac, 60Hz	<b>Environmental Conditions</b>	25°C, 68% RH
<b>Tested By</b>	Tom Yang		

**Antenna Polarity & Test Distance : Horizontal at 3 m**

No	Frequency (MHz)	Emission Level (dBuV/m)	Limit (dBuV/m)	Margin (dB)	Antenna Height (m)	Table Angle (Degree)	Raw Value (dBuV)	Correction Factor (dB/m)
1	#12890.00	42.3 PK	88.2	-45.9	2.40 H	337	31.8	10.5
2	#12890.00	29.8 AV	68.2	-38.4	2.40 H	337	19.3	10.5
3	19335.00	43.7 PK	74.0	-30.3	1.64 H	101	50.4	-6.7
4	19335.00	32.3 AV	54.0	-21.7	1.64 H	101	39.0	-6.7
5	#25780.00	44.5 PK	88.2	-43.7	2.72 H	194	45.6	-1.1
6	#25780.00	34.8 AV	68.2	-33.4	2.72 H	194	35.9	-1.1

**Antenna Polarity & Test Distance : Vertical at 3 m**

No	Frequency (MHz)	Emission Level (dBuV/m)	Limit (dBuV/m)	Margin (dB)	Antenna Height (m)	Table Angle (Degree)	Raw Value (dBuV)	Correction Factor (dB/m)
1	#12890.00	43.8 PK	88.2	-44.4	1.17 V	159	33.3	10.5
2	#12890.00	30.6 AV	68.2	-37.6	1.17 V	159	20.1	10.5
3	19335.00	43.6 PK	74.0	-30.4	1.76 V	276	50.3	-6.7
4	19335.00	31.5 AV	54.0	-22.5	1.76 V	276	38.2	-6.7
5	#25780.00	44.8 PK	88.2	-43.4	2.09 V	315	45.9	-1.1
6	#25780.00	34.0 AV	68.2	-34.2	2.09 V	315	35.1	-1.1

**Remarks:**

1. Emission Level(dBuV/m) = Raw Value(dBuV) + Correction Factor(dB/m)
2. Correction Factor(dB/m) = Antenna Factor(dB/m) + Cable Factor(dB) – Pre-Amplifier Factor(dB)
3. Margin value = Emission Level – Limit value
4. The other emission levels were very low against the limit.
5. "#": The radiated frequency is out of the restricted band.

<b>RF Mode</b>	TX 802.11be (EHT40)	<b>Channel</b>	CH 107 : 6485 MHz
<b>Frequency Range</b>	1 GHz ~ 40 GHz	<b>Detector Function &amp; Bandwidth</b>	(PK) RB = 1 MHz, VB = 3 MHz (AV) RB = 1 MHz, VB = 300 Hz
<b>Input Power (System)</b>	120Vac, 60Hz	<b>Environmental Conditions</b>	25°C, 68% RH
<b>Tested By</b>	Tom Yang		

**Antenna Polarity & Test Distance : Horizontal at 3 m**

No	Frequency (MHz)	Emission Level (dBuV/m)	Limit (dBuV/m)	Margin (dB)	Antenna Height (m)	Table Angle (Degree)	Raw Value (dBuV)	Correction Factor (dB/m)
1	#12970.00	43.6 PK	88.2	-44.6	2.28 H	331	33.1	10.5
2	#12970.00	30.6 AV	68.2	-37.6	2.28 H	331	20.1	10.5
3	19455.00	44.0 PK	74.0	-30.0	1.75 H	125	50.4	-6.4
4	19455.00	33.1 AV	54.0	-20.9	1.75 H	125	39.5	-6.4
5	#25940.00	44.1 PK	88.2	-44.1	2.76 H	206	45.2	-1.1
6	#25940.00	33.5 AV	68.2	-34.7	2.76 H	206	34.6	-1.1

**Antenna Polarity & Test Distance : Vertical at 3 m**

No	Frequency (MHz)	Emission Level (dBuV/m)	Limit (dBuV/m)	Margin (dB)	Antenna Height (m)	Table Angle (Degree)	Raw Value (dBuV)	Correction Factor (dB/m)
1	#12970.00	44.0 PK	88.2	-44.2	1.17 V	181	33.5	10.5
2	#12970.00	30.7 AV	68.2	-37.5	1.17 V	181	20.2	10.5
3	19455.00	42.5 PK	74.0	-31.5	1.86 V	239	48.9	-6.4
4	19455.00	31.0 AV	54.0	-23.0	1.86 V	239	37.4	-6.4
5	#25940.00	43.9 PK	88.2	-44.3	2.21 V	319	45.0	-1.1
6	#25940.00	33.9 AV	68.2	-34.3	2.21 V	319	35.0	-1.1

**Remarks:**

1. Emission Level(dBuV/m) = Raw Value(dBuV) + Correction Factor(dB/m)
2. Correction Factor(dB/m) = Antenna Factor(dB/m) + Cable Factor(dB) – Pre-Amplifier Factor(dB)
3. Margin value = Emission Level – Limit value
4. The other emission levels were very low against the limit.
5. " # ": The radiated frequency is out of the restricted band.

<b>RF Mode</b>	TX 802.11be (EHT40)	<b>Channel</b>	CH 115 : 6525 MHz
<b>Frequency Range</b>	1 GHz ~ 40 GHz	<b>Detector Function &amp; Bandwidth</b>	(PK) RB = 1 MHz, VB = 3 MHz (AV) RB = 1 MHz, VB = 300 Hz
<b>Input Power (System)</b>	120Vac, 60Hz	<b>Environmental Conditions</b>	25°C, 68% RH
<b>Tested By</b>	Tom Yang		

**Antenna Polarity & Test Distance : Horizontal at 3 m**

No	Frequency (MHz)	Emission Level (dBuV/m)	Limit (dBuV/m)	Margin (dB)	Antenna Height (m)	Table Angle (Degree)	Raw Value (dBuV)	Correction Factor (dB/m)
1	#13050.00	42.9 PK	88.2	-45.3	2.31 H	330	32.2	10.7
2	#13050.00	30.2 AV	68.2	-38.0	2.31 H	330	19.5	10.7
3	19575.00	44.0 PK	74.0	-30.0	1.75 H	141	50.0	-6.0
4	19575.00	33.0 AV	54.0	-21.0	1.75 H	141	39.0	-6.0
5	#26100.00	44.2 PK	88.2	-44.0	2.71 H	200	45.0	-0.8
6	#26100.00	33.9 AV	68.2	-34.3	2.71 H	200	34.7	-0.8

**Antenna Polarity & Test Distance : Vertical at 3 m**

No	Frequency (MHz)	Emission Level (dBuV/m)	Limit (dBuV/m)	Margin (dB)	Antenna Height (m)	Table Angle (Degree)	Raw Value (dBuV)	Correction Factor (dB/m)
1	#13050.00	43.7 PK	88.2	-44.5	1.34 V	155	33.0	10.7
2	#13050.00	30.6 AV	68.2	-37.6	1.34 V	155	19.9	10.7
3	19575.00	42.0 PK	74.0	-32.0	1.73 V	279	48.0	-6.0
4	19575.00	30.2 AV	54.0	-23.8	1.73 V	279	36.2	-6.0
5	#26100.00	42.7 PK	88.2	-45.5	2.17 V	331	43.5	-0.8
6	#26100.00	32.6 AV	68.2	-35.6	2.17 V	331	33.4	-0.8

**Remarks:**

1. Emission Level(dBuV/m) = Raw Value(dBuV) + Correction Factor(dB/m)
2. Correction Factor(dB/m) = Antenna Factor(dB/m) + Cable Factor(dB) – Pre-Amplifier Factor(dB)
3. Margin value = Emission Level – Limit value
4. The other emission levels were very low against the limit.
5. "#": The radiated frequency is out of the restricted band.

<b>RF Mode</b>	TX 802.11be (EHT40)	<b>Channel</b>	CH 123 : 6565 MHz
<b>Frequency Range</b>	1 GHz ~ 40 GHz	<b>Detector Function &amp; Bandwidth</b>	(PK) RB = 1 MHz, VB = 3 MHz (AV) RB = 1 MHz, VB = 300 Hz
<b>Input Power (System)</b>	120Vac, 60Hz	<b>Environmental Conditions</b>	25°C, 68% RH
<b>Tested By</b>	Tom Yang		

**Antenna Polarity & Test Distance : Horizontal at 3 m**

No	Frequency (MHz)	Emission Level (dBuV/m)	Limit (dBuV/m)	Margin (dB)	Antenna Height (m)	Table Angle (Degree)	Raw Value (dBuV)	Correction Factor (dB/m)
1	#13130.00	42.4 PK	88.2	-45.8	2.28 H	345	31.2	11.2
2	#13130.00	29.8 AV	68.2	-38.4	2.28 H	345	18.6	11.2
3	19695.00	43.7 PK	74.0	-30.3	1.75 H	145	49.7	-6.0
4	19695.00	32.7 AV	54.0	-21.3	1.75 H	145	38.7	-6.0
5	#26260.00	44.2 PK	88.2	-44.0	2.76 H	203	45.3	-1.1
6	#26260.00	34.0 AV	68.2	-34.2	2.76 H	203	35.1	-1.1

**Antenna Polarity & Test Distance : Vertical at 3 m**

No	Frequency (MHz)	Emission Level (dBuV/m)	Limit (dBuV/m)	Margin (dB)	Antenna Height (m)	Table Angle (Degree)	Raw Value (dBuV)	Correction Factor (dB/m)
1	#13130.00	44.1 PK	88.2	-44.1	1.12 V	172	32.9	11.2
2	#13130.00	30.5 AV	68.2	-37.7	1.12 V	172	19.3	11.2
3	19695.00	42.9 PK	74.0	-31.1	1.90 V	233	48.9	-6.0
4	19695.00	31.5 AV	54.0	-22.5	1.90 V	233	37.5	-6.0
5	#26260.00	44.2 PK	88.2	-44.0	2.25 V	320	45.3	-1.1
6	#26260.00	34.0 AV	68.2	-34.2	2.25 V	320	35.1	-1.1

**Remarks:**

1. Emission Level(dBuV/m) = Raw Value(dBuV) + Correction Factor(dB/m)
2. Correction Factor(dB/m) = Antenna Factor(dB/m) + Cable Factor(dB) – Pre-Amplifier Factor(dB)
3. Margin value = Emission Level – Limit value
4. The other emission levels were very low against the limit.
5. "#": The radiated frequency is out of the restricted band.



<b>RF Mode</b>	TX 802.11be (EHT40)	<b>Channel</b>	CH 155 : 6725 MHz
<b>Frequency Range</b>	1 GHz ~ 40 GHz	<b>Detector Function &amp; Bandwidth</b>	(PK) RB = 1 MHz, VB = 3 MHz (AV) RB = 1 MHz, VB = 300 Hz
<b>Input Power (System)</b>	120Vac, 60Hz	<b>Environmental Conditions</b>	25°C, 68% RH
<b>Tested By</b>	Tom Yang		

**Antenna Polarity & Test Distance : Horizontal at 3 m**

No	Frequency (MHz)	Emission Level (dBuV/m)	Limit (dBuV/m)	Margin (dB)	Antenna Height (m)	Table Angle (Degree)	Raw Value (dBuV)	Correction Factor (dB/m)
1	#13450.00	42.1 PK	88.2	-46.1	2.34 H	352	29.9	12.2
2	#13450.00	29.6 AV	68.2	-38.6	2.34 H	352	17.4	12.2
3	20175.00	44.0 PK	74.0	-30.0	1.77 H	133	49.5	-5.5
4	20175.00	32.9 AV	54.0	-21.1	1.77 H	133	38.4	-5.5
5	#26900.00	43.7 PK	88.2	-44.5	2.78 H	195	44.5	-0.8
6	#26900.00	33.6 AV	68.2	-34.6	2.78 H	195	34.4	-0.8

**Antenna Polarity & Test Distance : Vertical at 3 m**

No	Frequency (MHz)	Emission Level (dBuV/m)	Limit (dBuV/m)	Margin (dB)	Antenna Height (m)	Table Angle (Degree)	Raw Value (dBuV)	Correction Factor (dB/m)
1	#13450.00	43.5 PK	88.2	-44.7	1.30 V	146	31.3	12.2
2	#13450.00	30.2 AV	68.2	-38.0	1.30 V	146	18.0	12.2
3	20175.00	42.0 PK	74.0	-32.0	1.70 V	269	47.5	-5.5
4	20175.00	30.2 AV	54.0	-23.8	1.70 V	269	35.7	-5.5
5	#26900.00	43.2 PK	88.2	-45.0	2.15 V	319	44.0	-0.8
6	#26900.00	32.9 AV	68.2	-35.3	2.15 V	319	33.7	-0.8

**Remarks:**

1. Emission Level(dBuV/m) = Raw Value(dBuV) + Correction Factor(dB/m)
2. Correction Factor(dB/m) = Antenna Factor(dB/m) + Cable Factor(dB) – Pre-Amplifier Factor(dB)
3. Margin value = Emission Level – Limit value
4. The other emission levels were very low against the limit.
5. "#": The radiated frequency is out of the restricted band.

<b>RF Mode</b>	TX 802.11be (EHT40)	<b>Channel</b>	CH 179 : 6845 MHz
<b>Frequency Range</b>	1 GHz ~ 40 GHz	<b>Detector Function &amp; Bandwidth</b>	(PK) RB = 1 MHz, VB = 3 MHz (AV) RB = 1 MHz, VB = 300 Hz
<b>Input Power (System)</b>	120Vac, 60Hz	<b>Environmental Conditions</b>	25°C, 68% RH
<b>Tested By</b>	Tom Yang		

**Antenna Polarity & Test Distance : Horizontal at 3 m**

No	Frequency (MHz)	Emission Level (dBuV/m)	Limit (dBuV/m)	Margin (dB)	Antenna Height (m)	Table Angle (Degree)	Raw Value (dBuV)	Correction Factor (dB/m)
1	#13690.00	42.4 PK	88.2	-45.8	2.32 H	343	29.5	12.9
2	#13690.00	29.8 AV	68.2	-38.4	2.32 H	343	16.9	12.9
3	20535.00	43.3 PK	74.0	-30.7	1.70 H	134	48.0	-4.7
4	20535.00	32.4 AV	54.0	-21.6	1.70 H	134	37.1	-4.7
5	#27380.00	44.6 PK	88.2	-43.6	2.72 H	206	45.5	-0.9
6	#27380.00	34.2 AV	68.2	-34.0	2.72 H	206	35.1	-0.9

**Antenna Polarity & Test Distance : Vertical at 3 m**

No	Frequency (MHz)	Emission Level (dBuV/m)	Limit (dBuV/m)	Margin (dB)	Antenna Height (m)	Table Angle (Degree)	Raw Value (dBuV)	Correction Factor (dB/m)
1	#13690.00	43.4 PK	88.2	-44.8	1.19 V	163	30.5	12.9
2	#13690.00	30.3 AV	68.2	-37.9	1.19 V	163	17.4	12.9
3	20535.00	43.3 PK	74.0	-30.7	1.79 V	231	48.0	-4.7
4	20535.00	32.0 AV	54.0	-22.0	1.79 V	231	36.7	-4.7
5	#27380.00	43.4 PK	88.2	-44.8	2.21 V	323	44.3	-0.9
6	#27380.00	33.9 AV	68.2	-34.3	2.21 V	323	34.8	-0.9

**Remarks:**

1. Emission Level(dBuV/m) = Raw Value(dBuV) + Correction Factor(dB/m)
2. Correction Factor(dB/m) = Antenna Factor(dB/m) + Cable Factor(dB) – Pre-Amplifier Factor(dB)
3. Margin value = Emission Level – Limit value
4. The other emission levels were very low against the limit.
5. "#": The radiated frequency is out of the restricted band.

<b>RF Mode</b>	TX 802.11be (EHT40)	<b>Channel</b>	CH 187 : 6885 MHz
<b>Frequency Range</b>	1 GHz ~ 40 GHz	<b>Detector Function &amp; Bandwidth</b>	(PK) RB = 1 MHz, VB = 3 MHz (AV) RB = 1 MHz, VB = 300 Hz
<b>Input Power (System)</b>	120Vac, 60Hz	<b>Environmental Conditions</b>	25°C, 68% RH
<b>Tested By</b>	Tom Yang		

**Antenna Polarity & Test Distance : Horizontal at 3 m**

No	Frequency (MHz)	Emission Level (dBuV/m)	Limit (dBuV/m)	Margin (dB)	Antenna Height (m)	Table Angle (Degree)	Raw Value (dBuV)	Correction Factor (dB/m)
1	#13770.00	42.9 PK	88.2	-45.3	2.29 H	334	30.0	12.9
2	#13770.00	30.3 AV	68.2	-37.9	2.29 H	334	17.4	12.9
3	20655.00	44.3 PK	74.0	-29.7	1.77 H	129	49.0	-4.7
4	20655.00	33.3 AV	54.0	-20.7	1.77 H	129	38.0	-4.7
5	#27540.00	44.2 PK	88.2	-44.0	2.73 H	196	45.3	-1.1
6	#27540.00	34.1 AV	68.2	-34.1	2.73 H	196	35.2	-1.1

**Antenna Polarity & Test Distance : Vertical at 3 m**

No	Frequency (MHz)	Emission Level (dBuV/m)	Limit (dBuV/m)	Margin (dB)	Antenna Height (m)	Table Angle (Degree)	Raw Value (dBuV)	Correction Factor (dB/m)
1	#13770.00	44.7 PK	88.2	-43.5	1.11 V	179	31.8	12.9
2	#13770.00	30.9 AV	68.2	-37.3	1.11 V	179	18.0	12.9
3	20655.00	43.3 PK	74.0	-30.7	1.88 V	234	48.0	-4.7
4	20655.00	31.8 AV	54.0	-22.2	1.88 V	234	36.5	-4.7
5	#27540.00	44.4 PK	88.2	-43.8	2.30 V	318	45.5	-1.1
6	#27540.00	34.0 AV	68.2	-34.2	2.30 V	318	35.1	-1.1

**Remarks:**

1. Emission Level(dBuV/m) = Raw Value(dBuV) + Correction Factor(dB/m)
2. Correction Factor(dB/m) = Antenna Factor(dB/m) + Cable Factor(dB) – Pre-Amplifier Factor(dB)
3. Margin value = Emission Level – Limit value
4. The other emission levels were very low against the limit.
5. "#": The radiated frequency is out of the restricted band.

<b>RF Mode</b>	TX 802.11be (EHT40)	<b>Channel</b>	CH 211 : 7005 MHz
<b>Frequency Range</b>	1 GHz ~ 40 GHz	<b>Detector Function &amp; Bandwidth</b>	(PK) RB = 1 MHz, VB = 3 MHz (AV) RB = 1 MHz, VB = 300 Hz
<b>Input Power (System)</b>	120Vac, 60Hz	<b>Environmental Conditions</b>	25°C, 68% RH
<b>Tested By</b>	Tom Yang		

**Antenna Polarity & Test Distance : Horizontal at 3 m**

No	Frequency (MHz)	Emission Level (dBuV/m)	Limit (dBuV/m)	Margin (dB)	Antenna Height (m)	Table Angle (Degree)	Raw Value (dBuV)	Correction Factor (dB/m)
1	#14010.00	42.8 PK	88.2	-45.4	2.36 H	343	29.8	13.0
2	#14010.00	29.9 AV	68.2	-38.3	2.36 H	343	16.9	13.0
3	21015.00	43.4 PK	74.0	-30.6	1.78 H	133	47.4	-4.0
4	21015.00	32.6 AV	54.0	-21.4	1.78 H	133	36.6	-4.0
5	#28020.00	44.2 PK	88.2	-44.0	2.66 H	213	45.4	-1.2
6	#28020.00	34.1 AV	68.2	-34.1	2.66 H	213	35.3	-1.2

**Antenna Polarity & Test Distance : Vertical at 3 m**

No	Frequency (MHz)	Emission Level (dBuV/m)	Limit (dBuV/m)	Margin (dB)	Antenna Height (m)	Table Angle (Degree)	Raw Value (dBuV)	Correction Factor (dB/m)
1	#14010.00	43.7 PK	88.2	-44.5	1.31 V	158	30.7	13.0
2	#14010.00	30.4 AV	68.2	-37.8	1.31 V	158	17.4	13.0
3	21015.00	41.6 PK	74.0	-32.4	1.66 V	283	45.6	-4.0
4	21015.00	29.8 AV	54.0	-24.2	1.66 V	283	33.8	-4.0
5	#28020.00	43.3 PK	88.2	-44.9	2.18 V	327	44.5	-1.2
6	#28020.00	33.2 AV	68.2	-35.0	2.18 V	327	34.4	-1.2

**Remarks:**

1. Emission Level(dBuV/m) = Raw Value(dBuV) + Correction Factor(dB/m)
2. Correction Factor(dB/m) = Antenna Factor(dB/m) + Cable Factor(dB) – Pre-Amplifier Factor(dB)
3. Margin value = Emission Level – Limit value
4. The other emission levels were very low against the limit.
5. "#": The radiated frequency is out of the restricted band.

<b>RF Mode</b>	TX 802.11be (EHT40)	<b>Channel</b>	CH 227 : 7085 MHz
<b>Frequency Range</b>	1 GHz ~ 40 GHz	<b>Detector Function &amp; Bandwidth</b>	(PK) RB = 1 MHz, VB = 3 MHz (AV) RB = 1 MHz, VB = 300 Hz
<b>Input Power (System)</b>	120Vac, 60Hz	<b>Environmental Conditions</b>	25°C, 68% RH
<b>Tested By</b>	Tom Yang		

**Antenna Polarity & Test Distance : Horizontal at 3 m**

No	Frequency (MHz)	Emission Level (dBuV/m)	Limit (dBuV/m)	Margin (dB)	Antenna Height (m)	Table Angle (Degree)	Raw Value (dBuV)	Correction Factor (dB/m)
1	#14170.00	42.4 PK	88.2	-45.8	2.35 H	335	28.9	13.5
2	#14170.00	29.9 AV	68.2	-38.3	2.35 H	335	16.4	13.5
3	21255.00	43.0 PK	74.0	-31.0	1.66 H	131	47.0	-4.0
4	21255.00	32.3 AV	54.0	-21.7	1.66 H	131	36.3	-4.0
5	#28340.00	44.1 PK	88.2	-44.1	2.69 H	217	45.2	-1.1
6	#28340.00	33.9 AV	68.2	-34.3	2.69 H	217	35.0	-1.1

**Antenna Polarity & Test Distance : Vertical at 3 m**

No	Frequency (MHz)	Emission Level (dBuV/m)	Limit (dBuV/m)	Margin (dB)	Antenna Height (m)	Table Angle (Degree)	Raw Value (dBuV)	Correction Factor (dB/m)
1	#14170.00	43.1 PK	88.2	-45.1	1.21 V	164	29.6	13.5
2	#14170.00	30.0 AV	68.2	-38.2	1.21 V	164	16.5	13.5
3	21255.00	43.2 PK	74.0	-30.8	1.79 V	235	47.2	-4.0
4	21255.00	32.2 AV	54.0	-21.8	1.79 V	235	36.2	-4.0
5	#28340.00	43.1 PK	88.2	-45.1	2.27 V	314	44.2	-1.1
6	#28340.00	33.7 AV	68.2	-34.5	2.27 V	314	34.8	-1.1

**Remarks:**

1. Emission Level(dBuV/m) = Raw Value(dBuV) + Correction Factor(dB/m)
2. Correction Factor(dB/m) = Antenna Factor(dB/m) + Cable Factor(dB) – Pre-Amplifier Factor(dB)
3. Margin value = Emission Level – Limit value
4. The other emission levels were very low against the limit.
5. "#": The radiated frequency is out of the restricted band.

<b>RF Mode</b>	TX 802.11be (EHT80)	<b>Channel</b>	CH 7 : 5985 MHz
<b>Frequency Range</b>	1 GHz ~ 40 GHz	<b>Detector Function &amp; Bandwidth</b>	(PK) RB = 1 MHz, VB = 3 MHz (AV) RB = 1 MHz, VB = 510 Hz
<b>Input Power (System)</b>	120Vac, 60Hz	<b>Environmental Conditions</b>	25°C, 68% RH
<b>Tested By</b>	Tom Yang		

**Antenna Polarity & Test Distance : Horizontal at 3 m**

No	Frequency (MHz)	Emission Level (dBuV/m)	Limit (dBuV/m)	Margin (dB)	Antenna Height (m)	Table Angle (Degree)	Raw Value (dBuV)	Correction Factor (dB/m)
1	11970.00	42.2 PK	74.0	-31.8	2.34 H	341	31.4	10.8
2	11970.00	29.5 AV	54.0	-24.5	2.34 H	341	18.7	10.8
3	17955.00	43.8 PK	74.0	-30.2	1.67 H	134	20.3	23.5
4	17955.00	32.7 AV	54.0	-21.3	1.67 H	134	9.2	23.5
5	23940.00	44.8 PK	74.0	-29.2	2.76 H	207	47.0	-2.2
6	23940.00	34.5 AV	54.0	-19.5	2.76 H	207	36.7	-2.2

**Antenna Polarity & Test Distance : Vertical at 3 m**

No	Frequency (MHz)	Emission Level (dBuV/m)	Limit (dBuV/m)	Margin (dB)	Antenna Height (m)	Table Angle (Degree)	Raw Value (dBuV)	Correction Factor (dB/m)
1	11970.00	44.5 PK	74.0	-29.5	1.08 V	170	33.7	10.8
2	11970.00	30.8 AV	54.0	-23.2	1.08 V	170	20.0	10.8
3	17955.00	43.9 PK	74.0	-30.1	1.88 V	224	20.4	23.5
4	17955.00	32.3 AV	54.0	-21.7	1.88 V	224	8.8	23.5
5	23940.00	44.2 PK	74.0	-29.8	2.34 V	319	46.4	-2.2
6	23940.00	33.6 AV	54.0	-20.4	2.34 V	319	35.8	-2.2

**Remarks:**

1. Emission Level(dBuV/m) = Raw Value(dBuV) + Correction Factor(dB/m)
2. Correction Factor(dB/m) = Antenna Factor(dB/m) + Cable Factor(dB) – Pre-Amplifier Factor(dB)
3. Margin value = Emission Level – Limit value
4. The other emission levels were very low against the limit.

<b>RF Mode</b>	TX 802.11be (EHT80)	<b>Channel</b>	CH 39 : 6145 MHz
<b>Frequency Range</b>	1 GHz ~ 40 GHz	<b>Detector Function &amp; Bandwidth</b>	(PK) RB = 1 MHz, VB = 3 MHz (AV) RB = 1 MHz, VB = 510 Hz
<b>Input Power (System)</b>	120Vac, 60Hz	<b>Environmental Conditions</b>	25°C, 68% RH
<b>Tested By</b>	Tom Yang		

**Antenna Polarity & Test Distance : Horizontal at 3 m**

No	Frequency (MHz)	Emission Level (dBuV/m)	Limit (dBuV/m)	Margin (dB)	Antenna Height (m)	Table Angle (Degree)	Raw Value (dBuV)	Correction Factor (dB/m)
1	12290.00	42.2 PK	74.0	-31.8	2.33 H	343	32.1	10.1
2	12290.00	29.8 AV	54.0	-24.2	2.33 H	343	19.7	10.1
3	18435.00	43.3 PK	74.0	-30.7	1.64 H	128	50.5	-7.2
4	18435.00	32.6 AV	54.0	-21.4	1.64 H	128	39.8	-7.2
5	#24580.00	44.3 PK	88.2	-43.9	2.64 H	207	46.2	-1.9
6	#24580.00	34.0 AV	68.2	-34.2	2.64 H	207	35.9	-1.9

**Antenna Polarity & Test Distance : Vertical at 3 m**

No	Frequency (MHz)	Emission Level (dBuV/m)	Limit (dBuV/m)	Margin (dB)	Antenna Height (m)	Table Angle (Degree)	Raw Value (dBuV)	Correction Factor (dB/m)
1	12290.00	44.2 PK	74.0	-29.8	1.34 V	161	34.1	10.1
2	12290.00	30.7 AV	54.0	-23.3	1.34 V	161	20.6	10.1
3	18435.00	41.9 PK	74.0	-32.1	1.65 V	275	49.1	-7.2
4	18435.00	30.0 AV	54.0	-24.0	1.65 V	275	37.2	-7.2
5	#24580.00	43.4 PK	88.2	-44.8	2.13 V	337	45.3	-1.9
6	#24580.00	33.2 AV	68.2	-35.0	2.13 V	337	35.1	-1.9

**Remarks:**

1. Emission Level(dBuV/m) = Raw Value(dBuV) + Correction Factor(dB/m)
2. Correction Factor(dB/m) = Antenna Factor(dB/m) + Cable Factor(dB) – Pre-Amplifier Factor(dB)
3. Margin value = Emission Level – Limit value
4. The other emission levels were very low against the limit.
5. "#": The radiated frequency is out of the restricted band.

<b>RF Mode</b>	TX 802.11be (EHT80)	<b>Channel</b>	CH 87 : 6385 MHz
<b>Frequency Range</b>	1 GHz ~ 40 GHz	<b>Detector Function &amp; Bandwidth</b>	(PK) RB = 1 MHz, VB = 3 MHz (AV) RB = 1 MHz, VB = 510 Hz
<b>Input Power (System)</b>	120Vac, 60Hz	<b>Environmental Conditions</b>	25°C, 68% RH
<b>Tested By</b>	Tom Yang		

**Antenna Polarity & Test Distance : Horizontal at 3 m**

No	Frequency (MHz)	Emission Level (dBuV/m)	Limit (dBuV/m)	Margin (dB)	Antenna Height (m)	Table Angle (Degree)	Raw Value (dBuV)	Correction Factor (dB/m)
1	#12770.00	42.6 PK	88.2	-45.6	2.35 H	334	32.2	10.4
2	#12770.00	29.8 AV	68.2	-38.4	2.35 H	334	19.4	10.4
3	19155.00	43.6 PK	74.0	-30.4	1.62 H	128	50.0	-6.4
4	19155.00	32.3 AV	54.0	-21.7	1.62 H	128	38.7	-6.4
5	#25540.00	44.7 PK	88.2	-43.5	2.72 H	202	46.1	-1.4
6	#25540.00	34.4 AV	68.2	-33.8	2.72 H	202	35.8	-1.4

**Antenna Polarity & Test Distance : Vertical at 3 m**

No	Frequency (MHz)	Emission Level (dBuV/m)	Limit (dBuV/m)	Margin (dB)	Antenna Height (m)	Table Angle (Degree)	Raw Value (dBuV)	Correction Factor (dB/m)
1	#12770.00	43.6 PK	88.2	-44.6	1.12 V	140	33.2	10.4
2	#12770.00	30.5 AV	68.2	-37.7	1.12 V	140	20.1	10.4
3	19155.00	42.9 PK	74.0	-31.1	1.84 V	235	49.3	-6.4
4	19155.00	31.8 AV	54.0	-22.2	1.84 V	235	38.2	-6.4
5	#25540.00	42.9 PK	88.2	-45.3	2.13 V	313	44.3	-1.4
6	#25540.00	33.2 AV	68.2	-35.0	2.13 V	313	34.6	-1.4

**Remarks:**

1. Emission Level(dBuV/m) = Raw Value(dBuV) + Correction Factor(dB/m)
2. Correction Factor(dB/m) = Antenna Factor(dB/m) + Cable Factor(dB) – Pre-Amplifier Factor(dB)
3. Margin value = Emission Level – Limit value
4. The other emission levels were very low against the limit.
5. "#": The radiated frequency is out of the restricted band.



<b>RF Mode</b>	TX 802.11be (EHT80)	<b>Channel</b>	CH 103 : 6465 MHz
<b>Frequency Range</b>	1 GHz ~ 40 GHz	<b>Detector Function &amp; Bandwidth</b>	(PK) RB = 1 MHz, VB = 3 MHz (AV) RB = 1 MHz, VB = 510 Hz
<b>Input Power (System)</b>	120Vac, 60Hz	<b>Environmental Conditions</b>	25°C, 68% RH
<b>Tested By</b>	Tom Yang		

**Antenna Polarity & Test Distance : Horizontal at 3 m**

No	Frequency (MHz)	Emission Level (dBuV/m)	Limit (dBuV/m)	Margin (dB)	Antenna Height (m)	Table Angle (Degree)	Raw Value (dBuV)	Correction Factor (dB/m)
1	#12930.00	42.4 PK	88.2	-45.8	2.37 H	341	31.9	10.5
2	#12930.00	30.1 AV	68.2	-38.1	2.37 H	341	19.6	10.5
3	19395.00	43.2 PK	74.0	-30.8	1.71 H	128	49.9	-6.7
4	19395.00	32.6 AV	54.0	-21.4	1.71 H	128	39.3	-6.7
5	#25860.00	44.5 PK	88.2	-43.7	2.68 H	212	45.6	-1.1
6	#25860.00	34.2 AV	68.2	-34.0	2.68 H	212	35.3	-1.1

**Antenna Polarity & Test Distance : Vertical at 3 m**

No	Frequency (MHz)	Emission Level (dBuV/m)	Limit (dBuV/m)	Margin (dB)	Antenna Height (m)	Table Angle (Degree)	Raw Value (dBuV)	Correction Factor (dB/m)
1	#12930.00	43.3 PK	88.2	-44.9	1.17 V	147	32.8	10.5
2	#12930.00	30.1 AV	68.2	-38.1	1.17 V	147	19.6	10.5
3	19395.00	42.3 PK	74.0	-31.7	1.75 V	235	49.0	-6.7
4	19395.00	31.2 AV	54.0	-22.8	1.75 V	235	37.9	-6.7
5	#25860.00	42.5 PK	88.2	-45.7	2.16 V	326	43.6	-1.1
6	#25860.00	33.2 AV	68.2	-35.0	2.16 V	326	34.3	-1.1

**Remarks:**

1. Emission Level(dBuV/m) = Raw Value(dBuV) + Correction Factor(dB/m)
2. Correction Factor(dB/m) = Antenna Factor(dB/m) + Cable Factor(dB) – Pre-Amplifier Factor(dB)
3. Margin value = Emission Level – Limit value
4. The other emission levels were very low against the limit.
5. "#": The radiated frequency is out of the restricted band.

<b>RF Mode</b>	TX 802.11be (EHT80)	<b>Channel</b>	CH 119 : 6545 MHz
<b>Frequency Range</b>	1 GHz ~ 40 GHz	<b>Detector Function &amp; Bandwidth</b>	(PK) RB = 1 MHz, VB = 3 MHz (AV) RB = 1 MHz, VB = 510 Hz
<b>Input Power (System)</b>	120Vac, 60Hz	<b>Environmental Conditions</b>	25°C, 68% RH
<b>Tested By</b>	Tom Yang		

**Antenna Polarity & Test Distance : Horizontal at 3 m**

No	Frequency (MHz)	Emission Level (dBuV/m)	Limit (dBuV/m)	Margin (dB)	Antenna Height (m)	Table Angle (Degree)	Raw Value (dBuV)	Correction Factor (dB/m)
1	#13090.00	42.4 PK	88.2	-45.8	2.38 H	353	31.4	11.0
2	#13090.00	29.7 AV	68.2	-38.5	2.38 H	353	18.7	11.0
3	19635.00	43.1 PK	74.0	-30.9	1.65 H	138	49.1	-6.0
4	19635.00	32.4 AV	54.0	-21.6	1.65 H	138	38.4	-6.0
5	#26180.00	44.5 PK	88.2	-43.7	2.66 H	190	45.5	-1.0
6	#26180.00	34.0 AV	68.2	-34.2	2.66 H	190	35.0	-1.0

**Antenna Polarity & Test Distance : Vertical at 3 m**

No	Frequency (MHz)	Emission Level (dBuV/m)	Limit (dBuV/m)	Margin (dB)	Antenna Height (m)	Table Angle (Degree)	Raw Value (dBuV)	Correction Factor (dB/m)
1	#13090.00	43.9 PK	88.2	-44.3	1.15 V	140	32.9	11.0
2	#13090.00	30.8 AV	68.2	-37.4	1.15 V	140	19.8	11.0
3	19635.00	43.3 PK	74.0	-30.7	1.88 V	230	49.3	-6.0
4	19635.00	32.2 AV	54.0	-21.8	1.88 V	230	38.2	-6.0
5	#26180.00	43.5 PK	88.2	-44.7	2.10 V	325	44.5	-1.0
6	#26180.00	33.5 AV	68.2	-34.7	2.10 V	325	34.5	-1.0

**Remarks:**

1. Emission Level(dBuV/m) = Raw Value(dBuV) + Correction Factor(dB/m)
2. Correction Factor(dB/m) = Antenna Factor(dB/m) + Cable Factor(dB) – Pre-Amplifier Factor(dB)
3. Margin value = Emission Level – Limit value
4. The other emission levels were very low against the limit.
5. " # ": The radiated frequency is out of the restricted band.

<b>RF Mode</b>	TX 802.11be (EHT80)	<b>Channel</b>	CH 135 : 6625 MHz
<b>Frequency Range</b>	1 GHz ~ 40 GHz	<b>Detector Function &amp; Bandwidth</b>	(PK) RB = 1 MHz, VB = 3 MHz (AV) RB = 1 MHz, VB = 510 Hz
<b>Input Power (System)</b>	120Vac, 60Hz	<b>Environmental Conditions</b>	25°C, 68% RH
<b>Tested By</b>	Tom Yang		

**Antenna Polarity & Test Distance : Horizontal at 3 m**

No	Frequency (MHz)	Emission Level (dBuV/m)	Limit (dBuV/m)	Margin (dB)	Antenna Height (m)	Table Angle (Degree)	Raw Value (dBuV)	Correction Factor (dB/m)
1	13250.00	42.5 PK	74.0	-31.5	2.31 H	349	31.0	11.5
2	13250.00	29.4 AV	54.0	-24.6	2.31 H	349	17.9	11.5
3	19875.00	43.4 PK	74.0	-30.6	1.60 H	121	49.4	-6.0
4	19875.00	31.9 AV	54.0	-22.1	1.60 H	121	37.9	-6.0
5	#26500.00	44.3 PK	88.2	-43.9	2.67 H	205	45.1	-0.8
6	#26500.00	34.0 AV	68.2	-34.2	2.67 H	205	34.8	-0.8

**Antenna Polarity & Test Distance : Vertical at 3 m**

No	Frequency (MHz)	Emission Level (dBuV/m)	Limit (dBuV/m)	Margin (dB)	Antenna Height (m)	Table Angle (Degree)	Raw Value (dBuV)	Correction Factor (dB/m)
1	13250.00	43.9 PK	74.0	-30.1	1.13 V	173	32.4	11.5
2	13250.00	30.5 AV	54.0	-23.5	1.13 V	173	19.0	11.5
3	19875.00	44.1 PK	74.0	-29.9	1.84 V	224	50.1	-6.0
4	19875.00	32.2 AV	54.0	-21.8	1.84 V	224	38.2	-6.0
5	#26500.00	43.6 PK	88.2	-44.6	2.37 V	329	44.4	-0.8
6	#26500.00	33.2 AV	68.2	-35.0	2.37 V	329	34.0	-0.8

**Remarks:**

1. Emission Level(dBuV/m) = Raw Value(dBuV) + Correction Factor(dB/m)
2. Correction Factor(dB/m) = Antenna Factor(dB/m) + Cable Factor(dB) – Pre-Amplifier Factor(dB)
3. Margin value = Emission Level – Limit value
4. The other emission levels were very low against the limit.
5. " # ": The radiated frequency is out of the restricted band.

<b>RF Mode</b>	TX 802.11be (EHT80)	<b>Channel</b>	CH 151 : 6705 MHz
<b>Frequency Range</b>	1 GHz ~ 40 GHz	<b>Detector Function &amp; Bandwidth</b>	(PK) RB = 1 MHz, VB = 3 MHz (AV) RB = 1 MHz, VB = 510 Hz
<b>Input Power (System)</b>	120Vac, 60Hz	<b>Environmental Conditions</b>	25°C, 68% RH
<b>Tested By</b>	Tom Yang		

**Antenna Polarity & Test Distance : Horizontal at 3 m**

No	Frequency (MHz)	Emission Level (dBuV/m)	Limit (dBuV/m)	Margin (dB)	Antenna Height (m)	Table Angle (Degree)	Raw Value (dBuV)	Correction Factor (dB/m)
1	#13410.00	42.4 PK	88.2	-45.8	2.32 H	346	30.4	12.0
2	#13410.00	30.2 AV	68.2	-38.0	2.32 H	346	18.2	12.0
3	20115.00	43.3 PK	74.0	-30.7	1.66 H	124	48.8	-5.5
4	20115.00	32.5 AV	54.0	-21.5	1.66 H	124	38.0	-5.5
5	#26820.00	44.8 PK	88.2	-43.4	2.71 H	222	45.6	-0.8
6	#26820.00	34.3 AV	68.2	-33.9	2.71 H	222	35.1	-0.8

**Antenna Polarity & Test Distance : Vertical at 3 m**

No	Frequency (MHz)	Emission Level (dBuV/m)	Limit (dBuV/m)	Margin (dB)	Antenna Height (m)	Table Angle (Degree)	Raw Value (dBuV)	Correction Factor (dB/m)
1	#13410.00	43.4 PK	88.2	-44.8	1.10 V	141	31.4	12.0
2	#13410.00	30.1 AV	68.2	-38.1	1.10 V	141	18.1	12.0
3	20115.00	42.4 PK	74.0	-31.6	1.86 V	250	47.9	-5.5
4	20115.00	31.5 AV	54.0	-22.5	1.86 V	250	37.0	-5.5
5	#26820.00	43.4 PK	88.2	-44.8	2.12 V	329	44.2	-0.8
6	#26820.00	33.6 AV	68.2	-34.6	2.12 V	329	34.4	-0.8

**Remarks:**

1. Emission Level(dBuV/m) = Raw Value(dBuV) + Correction Factor(dB/m)
2. Correction Factor(dB/m) = Antenna Factor(dB/m) + Cable Factor(dB) – Pre-Amplifier Factor(dB)
3. Margin value = Emission Level – Limit value
4. The other emission levels were very low against the limit.
5. " # ": The radiated frequency is out of the restricted band.

<b>RF Mode</b>	TX 802.11be (EHT80)	<b>Channel</b>	CH 167 : 6785 MHz
<b>Frequency Range</b>	1 GHz ~ 40 GHz	<b>Detector Function &amp; Bandwidth</b>	(PK) RB = 1 MHz, VB = 3 MHz (AV) RB = 1 MHz, VB = 510 Hz
<b>Input Power (System)</b>	120Vac, 60Hz	<b>Environmental Conditions</b>	25°C, 68% RH
<b>Tested By</b>	Tom Yang		

**Antenna Polarity & Test Distance : Horizontal at 3 m**

No	Frequency (MHz)	Emission Level (dBuV/m)	Limit (dBuV/m)	Margin (dB)	Antenna Height (m)	Table Angle (Degree)	Raw Value (dBuV)	Correction Factor (dB/m)
1	#13570.00	42.6 PK	88.2	-45.6	2.34 H	332	29.9	12.7
2	#13570.00	30.3 AV	68.2	-37.9	2.34 H	332	17.6	12.7
3	20355.00	43.6 PK	74.0	-30.4	1.65 H	121	48.9	-5.3
4	20355.00	32.9 AV	54.0	-21.1	1.65 H	121	38.2	-5.3
5	#27140.00	44.6 PK	88.2	-43.6	2.70 H	208	45.6	-1.0
6	#27140.00	34.5 AV	68.2	-33.7	2.70 H	208	35.5	-1.0

**Antenna Polarity & Test Distance : Vertical at 3 m**

No	Frequency (MHz)	Emission Level (dBuV/m)	Limit (dBuV/m)	Margin (dB)	Antenna Height (m)	Table Angle (Degree)	Raw Value (dBuV)	Correction Factor (dB/m)
1	#13570.00	43.6 PK	88.2	-44.6	1.11 V	158	30.9	12.7
2	#13570.00	30.2 AV	68.2	-38.0	1.11 V	158	17.5	12.7
3	20355.00	42.3 PK	74.0	-31.7	1.75 V	243	47.6	-5.3
4	20355.00	31.0 AV	54.0	-23.0	1.75 V	243	36.3	-5.3
5	#27140.00	42.3 PK	88.2	-45.9	2.16 V	330	43.3	-1.0
6	#27140.00	33.1 AV	68.2	-35.1	2.16 V	330	34.1	-1.0

**Remarks:**

1. Emission Level(dBuV/m) = Raw Value(dBuV) + Correction Factor(dB/m)
2. Correction Factor(dB/m) = Antenna Factor(dB/m) + Cable Factor(dB) – Pre-Amplifier Factor(dB)
3. Margin value = Emission Level – Limit value
4. The other emission levels were very low against the limit.
5. "#": The radiated frequency is out of the restricted band.

<b>RF Mode</b>	TX 802.11be (EHT80)	<b>Channel</b>	CH 183 : 6865 MHz
<b>Frequency Range</b>	1 GHz ~ 40 GHz	<b>Detector Function &amp; Bandwidth</b>	(PK) RB = 1 MHz, VB = 3 MHz (AV) RB = 1 MHz, VB = 510 Hz
<b>Input Power (System)</b>	120Vac, 60Hz	<b>Environmental Conditions</b>	25°C, 68% RH
<b>Tested By</b>	Tom Yang		

**Antenna Polarity & Test Distance : Horizontal at 3 m**

No	Frequency (MHz)	Emission Level (dBuV/m)	Limit (dBuV/m)	Margin (dB)	Antenna Height (m)	Table Angle (Degree)	Raw Value (dBuV)	Correction Factor (dB/m)
1	#13730.00	42.3 PK	88.2	-45.9	2.42 H	358	29.4	12.9
2	#13730.00	29.9 AV	68.2	-38.3	2.42 H	358	17.0	12.9
3	20595.00	42.7 PK	74.0	-31.3	1.63 H	141	47.4	-4.7
4	20595.00	32.0 AV	54.0	-22.0	1.63 H	141	36.7	-4.7
5	#27460.00	44.3 PK	88.2	-43.9	2.71 H	196	45.2	-0.9
6	#27460.00	33.7 AV	68.2	-34.5	2.71 H	196	34.6	-0.9

**Antenna Polarity & Test Distance : Vertical at 3 m**

No	Frequency (MHz)	Emission Level (dBuV/m)	Limit (dBuV/m)	Margin (dB)	Antenna Height (m)	Table Angle (Degree)	Raw Value (dBuV)	Correction Factor (dB/m)
1	#13730.00	44.1 PK	88.2	-44.1	1.10 V	180	31.2	12.9
2	#13730.00	30.6 AV	68.2	-37.6	1.10 V	180	17.7	12.9
3	20595.00	43.8 PK	74.0	-30.2	1.83 V	227	48.5	-4.7
4	20595.00	31.9 AV	54.0	-22.1	1.83 V	227	36.6	-4.7
5	#27460.00	43.3 PK	88.2	-44.9	2.43 V	345	44.2	-0.9
6	#27460.00	32.9 AV	68.2	-35.3	2.43 V	345	33.8	-0.9

**Remarks:**

1. Emission Level(dBuV/m) = Raw Value(dBuV) + Correction Factor(dB/m)
2. Correction Factor(dB/m) = Antenna Factor(dB/m) + Cable Factor(dB) – Pre-Amplifier Factor(dB)
3. Margin value = Emission Level – Limit value
4. The other emission levels were very low against the limit.
5. "#": The radiated frequency is out of the restricted band.

<b>RF Mode</b>	TX 802.11be (EHT80)	<b>Channel</b>	CH 199 : 6945 MHz
<b>Frequency Range</b>	1 GHz ~ 40 GHz	<b>Detector Function &amp; Bandwidth</b>	(PK) RB = 1 MHz, VB = 3 MHz (AV) RB = 1 MHz, VB = 510 Hz
<b>Input Power (System)</b>	120Vac, 60Hz	<b>Environmental Conditions</b>	25°C, 68% RH
<b>Tested By</b>	Tom Yang		

**Antenna Polarity & Test Distance : Horizontal at 3 m**

No	Frequency (MHz)	Emission Level (dBuV/m)	Limit (dBuV/m)	Margin (dB)	Antenna Height (m)	Table Angle (Degree)	Raw Value (dBuV)	Correction Factor (dB/m)
1	#13890.00	41.9 PK	88.2	-46.3	2.34 H	337	28.9	13.0
2	#13890.00	29.8 AV	68.2	-38.4	2.34 H	337	16.8	13.0
3	20835.00	43.4 PK	74.0	-30.6	1.60 H	130	47.8	-4.4
4	20835.00	32.6 AV	54.0	-21.4	1.60 H	130	37.0	-4.4
5	#27780.00	44.6 PK	88.2	-43.6	2.69 H	204	45.8	-1.2
6	#27780.00	34.6 AV	68.2	-33.6	2.69 H	204	35.8	-1.2

**Antenna Polarity & Test Distance : Vertical at 3 m**

No	Frequency (MHz)	Emission Level (dBuV/m)	Limit (dBuV/m)	Margin (dB)	Antenna Height (m)	Table Angle (Degree)	Raw Value (dBuV)	Correction Factor (dB/m)
1	#13890.00	43.8 PK	88.2	-44.4	1.12 V	176	30.8	13.0
2	#13890.00	30.3 AV	68.2	-37.9	1.12 V	176	17.3	13.0
3	20835.00	44.3 PK	74.0	-29.7	1.89 V	224	48.7	-4.4
4	20835.00	32.3 AV	54.0	-21.7	1.89 V	224	36.7	-4.4
5	#27780.00	43.6 PK	88.2	-44.6	2.41 V	335	44.8	-1.2
6	#27780.00	33.3 AV	68.2	-34.9	2.41 V	335	34.5	-1.2

**Remarks:**

1. Emission Level(dBuV/m) = Raw Value(dBuV) + Correction Factor(dB/m)
2. Correction Factor(dB/m) = Antenna Factor(dB/m) + Cable Factor(dB) – Pre-Amplifier Factor(dB)
3. Margin value = Emission Level – Limit value
4. The other emission levels were very low against the limit.
5. "#": The radiated frequency is out of the restricted band.

<b>RF Mode</b>	TX 802.11be (EHT80)	<b>Channel</b>	CH 215 : 7025 MHz
<b>Frequency Range</b>	1 GHz ~ 40 GHz	<b>Detector Function &amp; Bandwidth</b>	(PK) RB = 1 MHz, VB = 3 MHz (AV) RB = 1 MHz, VB = 510 Hz
<b>Input Power (System)</b>	120Vac, 60Hz	<b>Environmental Conditions</b>	25°C, 68% RH
<b>Tested By</b>	Tom Yang		

**Antenna Polarity & Test Distance : Horizontal at 3 m**

No	Frequency (MHz)	Emission Level (dBuV/m)	Limit (dBuV/m)	Margin (dB)	Antenna Height (m)	Table Angle (Degree)	Raw Value (dBuV)	Correction Factor (dB/m)
1	#14050.00	42.1 PK	88.2	-46.1	2.31 H	342	28.9	13.2
2	#14050.00	30.0 AV	68.2	-38.2	2.31 H	342	16.8	13.2
3	21075.00	43.0 PK	74.0	-31.0	1.64 H	135	47.1	-4.1
4	21075.00	32.2 AV	54.0	-21.8	1.64 H	135	36.3	-4.1
5	#28100.00	45.1 PK	88.2	-43.1	2.63 H	213	46.3	-1.2
6	#28100.00	34.9 AV	68.2	-33.3	2.63 H	213	36.1	-1.2

**Antenna Polarity & Test Distance : Vertical at 3 m**

No	Frequency (MHz)	Emission Level (dBuV/m)	Limit (dBuV/m)	Margin (dB)	Antenna Height (m)	Table Angle (Degree)	Raw Value (dBuV)	Correction Factor (dB/m)
1	#14050.00	43.5 PK	88.2	-44.7	1.05 V	151	30.3	13.2
2	#14050.00	30.3 AV	68.2	-37.9	1.05 V	151	17.1	13.2
3	21075.00	43.1 PK	74.0	-30.9	1.83 V	239	47.2	-4.1
4	21075.00	31.9 AV	54.0	-22.1	1.83 V	239	36.0	-4.1
5	#28100.00	43.2 PK	88.2	-45.0	2.15 V	316	44.4	-1.2
6	#28100.00	33.1 AV	68.2	-35.1	2.15 V	316	34.3	-1.2

**Remarks:**

1. Emission Level(dBuV/m) = Raw Value(dBuV) + Correction Factor(dB/m)
2. Correction Factor(dB/m) = Antenna Factor(dB/m) + Cable Factor(dB) – Pre-Amplifier Factor(dB)
3. Margin value = Emission Level – Limit value
4. The other emission levels were very low against the limit.
5. "#": The radiated frequency is out of the restricted band.



<b>RF Mode</b>	TX 802.11be (EHT160)	<b>Channel</b>	CH 15 : 6025 MHz
<b>Frequency Range</b>	1 GHz ~ 40 GHz	<b>Detector Function &amp; Bandwidth</b>	(PK) RB = 1 MHz, VB = 3 MHz (AV) RB = 1 MHz, VB = 1 kHz
<b>Input Power (System)</b>	120Vac, 60Hz	<b>Environmental Conditions</b>	25°C, 68% RH
<b>Tested By</b>	Tom Yang		

**Antenna Polarity & Test Distance : Horizontal at 3 m**

No	Frequency (MHz)	Emission Level (dBuV/m)	Limit (dBuV/m)	Margin (dB)	Antenna Height (m)	Table Angle (Degree)	Raw Value (dBuV)	Correction Factor (dB/m)
1	12050.00	43.1 PK	74.0	-30.9	2.37 H	316	32.2	10.9
2	12050.00	30.8 AV	54.0	-23.2	2.37 H	316	19.9	10.9
3	18075.00	43.6 PK	74.0	-30.4	1.64 H	117	37.8	5.8
4	18075.00	33.1 AV	54.0	-20.9	1.64 H	117	27.3	5.8
5	#24100.00	44.3 PK	88.2	-43.9	2.72 H	207	46.5	-2.2
6	#24100.00	34.4 AV	68.2	-33.8	2.72 H	207	36.6	-2.2

**Antenna Polarity & Test Distance : Vertical at 3 m**

No	Frequency (MHz)	Emission Level (dBuV/m)	Limit (dBuV/m)	Margin (dB)	Antenna Height (m)	Table Angle (Degree)	Raw Value (dBuV)	Correction Factor (dB/m)
1	12050.00	43.3 PK	74.0	-30.7	1.16 V	151	32.4	10.9
2	12050.00	30.2 AV	54.0	-23.8	1.16 V	151	19.3	10.9
3	18075.00	42.7 PK	74.0	-31.3	1.70 V	233	36.9	5.8
4	18075.00	31.3 AV	54.0	-22.7	1.70 V	233	25.5	5.8
5	#24100.00	42.8 PK	88.2	-45.4	2.17 V	315	45.0	-2.2
6	#24100.00	33.5 AV	68.2	-34.7	2.17 V	315	35.7	-2.2

**Remarks:**

1. Emission Level(dBuV/m) = Raw Value(dBuV) + Correction Factor(dB/m)
2. Correction Factor(dB/m) = Antenna Factor(dB/m) + Cable Factor(dB) – Pre-Amplifier Factor(dB)
3. Margin value = Emission Level – Limit value
4. The other emission levels were very low against the limit.
5. " # ": The radiated frequency is out of the restricted band.

<b>RF Mode</b>	TX 802.11be (EHT160)	<b>Channel</b>	CH 47 : 6185 MHz
<b>Frequency Range</b>	1 GHz ~ 40 GHz	<b>Detector Function &amp; Bandwidth</b>	(PK) RB = 1 MHz, VB = 3 MHz (AV) RB = 1 MHz, VB = 1 kHz
<b>Input Power (System)</b>	120Vac, 60Hz	<b>Environmental Conditions</b>	25°C, 68% RH
<b>Tested By</b>	Tom Yang		

**Antenna Polarity & Test Distance : Horizontal at 3 m**

No	Frequency (MHz)	Emission Level (dBuV/m)	Limit (dBuV/m)	Margin (dB)	Antenna Height (m)	Table Angle (Degree)	Raw Value (dBuV)	Correction Factor (dB/m)
1	12370.00	42.2 PK	74.0	-31.8	2.31 H	338	32.2	10.0
2	12370.00	30.0 AV	54.0	-24.0	2.31 H	338	20.0	10.0
3	18555.00	43.4 PK	74.0	-30.6	1.60 H	109	50.4	-7.0
4	18555.00	32.7 AV	54.0	-21.3	1.60 H	109	39.7	-7.0
5	#24740.00	44.7 PK	88.2	-43.5	2.66 H	208	46.2	-1.5
6	#24740.00	34.0 AV	68.2	-34.2	2.66 H	208	35.5	-1.5

**Antenna Polarity & Test Distance : Vertical at 3 m**

No	Frequency (MHz)	Emission Level (dBuV/m)	Limit (dBuV/m)	Margin (dB)	Antenna Height (m)	Table Angle (Degree)	Raw Value (dBuV)	Correction Factor (dB/m)
1	12370.00	43.7 PK	74.0	-30.3	1.08 V	181	33.7	10.0
2	12370.00	30.0 AV	54.0	-24.0	1.08 V	181	20.0	10.0
3	18555.00	44.4 PK	74.0	-29.6	1.85 V	226	51.4	-7.0
4	18555.00	32.6 AV	54.0	-21.4	1.85 V	226	39.6	-7.0
5	#24740.00	43.9 PK	88.2	-44.3	2.36 V	334	45.4	-1.5
6	#24740.00	33.7 AV	68.2	-34.5	2.36 V	334	35.2	-1.5

**Remarks:**

1. Emission Level(dBuV/m) = Raw Value(dBuV) + Correction Factor(dB/m)
2. Correction Factor(dB/m) = Antenna Factor(dB/m) + Cable Factor(dB) – Pre-Amplifier Factor(dB)
3. Margin value = Emission Level – Limit value
4. The other emission levels were very low against the limit.
5. " # ": The radiated frequency is out of the restricted band.

<b>RF Mode</b>	TX 802.11be (EHT160)	<b>Channel</b>	CH 79 : 6345 MHz
<b>Frequency Range</b>	1 GHz ~ 40 GHz	<b>Detector Function &amp; Bandwidth</b>	(PK) RB = 1 MHz, VB = 3 MHz (AV) RB = 1 MHz, VB = 1 kHz
<b>Input Power (System)</b>	120Vac, 60Hz	<b>Environmental Conditions</b>	25°C, 68% RH
<b>Tested By</b>	Tom Yang		

**Antenna Polarity & Test Distance : Horizontal at 3 m**

No	Frequency (MHz)	Emission Level (dBuV/m)	Limit (dBuV/m)	Margin (dB)	Antenna Height (m)	Table Angle (Degree)	Raw Value (dBuV)	Correction Factor (dB/m)
1	12690.00	43.0 PK	74.0	-31.0	2.34 H	359	32.7	10.3
2	12690.00	30.6 AV	54.0	-23.4	2.34 H	359	20.3	10.3
3	19035.00	43.7 PK	74.0	-30.3	1.66 H	136	50.3	-6.6
4	19035.00	32.9 AV	54.0	-21.1	1.66 H	136	39.5	-6.6
5	#25380.00	45.0 PK	88.2	-43.2	2.72 H	213	46.4	-1.4
6	#25380.00	34.5 AV	68.2	-33.7	2.72 H	213	35.9	-1.4

**Antenna Polarity & Test Distance : Vertical at 3 m**

No	Frequency (MHz)	Emission Level (dBuV/m)	Limit (dBuV/m)	Margin (dB)	Antenna Height (m)	Table Angle (Degree)	Raw Value (dBuV)	Correction Factor (dB/m)
1	12690.00	43.4 PK	74.0	-30.6	1.03 V	162	33.1	10.3
2	12690.00	30.1 AV	54.0	-23.9	1.03 V	162	19.8	10.3
3	19035.00	43.0 PK	74.0	-31.0	1.87 V	248	49.6	-6.6
4	19035.00	32.1 AV	54.0	-21.9	1.87 V	248	38.7	-6.6
5	#25380.00	43.0 PK	88.2	-45.2	2.12 V	325	44.4	-1.4
6	#25380.00	33.2 AV	68.2	-35.0	2.12 V	325	34.6	-1.4

**Remarks:**

1. Emission Level(dBuV/m) = Raw Value(dBuV) + Correction Factor(dB/m)
2. Correction Factor(dB/m) = Antenna Factor(dB/m) + Cable Factor(dB) – Pre-Amplifier Factor(dB)
3. Margin value = Emission Level – Limit value
4. The other emission levels were very low against the limit.
5. " # ": The radiated frequency is out of the restricted band.

<b>RF Mode</b>	TX 802.11be (EHT160)	<b>Channel</b>	CH 111 : 6505 MHz
<b>Frequency Range</b>	1 GHz ~ 40 GHz	<b>Detector Function &amp; Bandwidth</b>	(PK) RB = 1 MHz, VB = 3 MHz (AV) RB = 1 MHz, VB = 1 kHz
<b>Input Power (System)</b>	120Vac, 60Hz	<b>Environmental Conditions</b>	25°C, 68% RH
<b>Tested By</b>	Tom Yang		

**Antenna Polarity & Test Distance : Horizontal at 3 m**

No	Frequency (MHz)	Emission Level (dBuV/m)	Limit (dBuV/m)	Margin (dB)	Antenna Height (m)	Table Angle (Degree)	Raw Value (dBuV)	Correction Factor (dB/m)
1	#13010.00	42.9 PK	88.2	-45.3	2.41 H	332	32.3	10.6
2	#13010.00	30.6 AV	68.2	-37.6	2.41 H	332	20.0	10.6
3	19515.00	44.0 PK	74.0	-30.0	1.59 H	105	50.2	-6.2
4	19515.00	33.3 AV	54.0	-20.7	1.59 H	105	39.5	-6.2
5	#26020.00	43.9 PK	88.2	-44.3	2.76 H	210	44.9	-1.0
6	#26020.00	34.3 AV	68.2	-33.9	2.76 H	210	35.3	-1.0

**Antenna Polarity & Test Distance : Vertical at 3 m**

No	Frequency (MHz)	Emission Level (dBuV/m)	Limit (dBuV/m)	Margin (dB)	Antenna Height (m)	Table Angle (Degree)	Raw Value (dBuV)	Correction Factor (dB/m)
1	#13010.00	43.1 PK	88.2	-45.1	1.20 V	152	32.5	10.6
2	#13010.00	29.9 AV	68.2	-38.3	1.20 V	152	19.3	10.6
3	19515.00	41.6 PK	74.0	-32.4	1.74 V	245	47.8	-6.2
4	19515.00	30.8 AV	54.0	-23.2	1.74 V	245	37.0	-6.2
5	#26020.00	42.5 PK	88.2	-45.7	2.13 V	312	43.5	-1.0
6	#26020.00	33.2 AV	68.2	-35.0	2.13 V	312	34.2	-1.0

**Remarks:**

1. Emission Level(dBuV/m) = Raw Value(dBuV) + Correction Factor(dB/m)
2. Correction Factor(dB/m) = Antenna Factor(dB/m) + Cable Factor(dB) – Pre-Amplifier Factor(dB)
3. Margin value = Emission Level – Limit value
4. The other emission levels were very low against the limit.
5. " # ": The radiated frequency is out of the restricted band.

<b>RF Mode</b>	TX 802.11be (EHT160)	<b>Channel</b>	CH 143 : 6665 MHz
<b>Frequency Range</b>	1 GHz ~ 40 GHz	<b>Detector Function &amp; Bandwidth</b>	(PK) RB = 1 MHz, VB = 3 MHz (AV) RB = 1 MHz, VB = 1 kHz
<b>Input Power (System)</b>	120Vac, 60Hz	<b>Environmental Conditions</b>	25°C, 68% RH
<b>Tested By</b>	Tom Yang		

**Antenna Polarity & Test Distance : Horizontal at 3 m**

No	Frequency (MHz)	Emission Level (dBuV/m)	Limit (dBuV/m)	Margin (dB)	Antenna Height (m)	Table Angle (Degree)	Raw Value (dBuV)	Correction Factor (dB/m)
1	13330.00	42.1 PK	74.0	-31.9	2.35 H	329	30.4	11.7
2	13330.00	29.7 AV	54.0	-24.3	2.35 H	329	18.0	11.7
3	19995.00	43.8 PK	74.0	-30.2	1.58 H	102	49.4	-5.6
4	19995.00	32.9 AV	54.0	-21.1	1.58 H	102	38.5	-5.6
5	#26660.00	45.5 PK	88.2	-42.7	2.62 H	211	46.2	-0.7
6	#26660.00	34.5 AV	68.2	-33.7	2.62 H	211	35.2	-0.7

**Antenna Polarity & Test Distance : Vertical at 3 m**

No	Frequency (MHz)	Emission Level (dBuV/m)	Limit (dBuV/m)	Margin (dB)	Antenna Height (m)	Table Angle (Degree)	Raw Value (dBuV)	Correction Factor (dB/m)
1	13330.00	44.1 PK	74.0	-29.9	1.03 V	185	32.4	11.7
2	13330.00	30.4 AV	54.0	-23.6	1.03 V	185	18.7	11.7
3	19995.00	44.6 PK	74.0	-29.4	1.87 V	220	50.2	-5.6
4	19995.00	33.0 AV	54.0	-21.0	1.87 V	220	38.6	-5.6
5	#26660.00	44.0 PK	88.2	-44.2	2.32 V	345	44.7	-0.7
6	#26660.00	33.7 AV	68.2	-34.5	2.32 V	345	34.4	-0.7

**Remarks:**

1. Emission Level(dBuV/m) = Raw Value(dBuV) + Correction Factor(dB/m)
2. Correction Factor(dB/m) = Antenna Factor(dB/m) + Cable Factor(dB) – Pre-Amplifier Factor(dB)
3. Margin value = Emission Level – Limit value
4. The other emission levels were very low against the limit.
5. " # ": The radiated frequency is out of the restricted band.

<b>RF Mode</b>	TX 802.11be (EHT160)	<b>Channel</b>	CH 175 : 6825 MHz
<b>Frequency Range</b>	1 GHz ~ 40 GHz	<b>Detector Function &amp; Bandwidth</b>	(PK) RB = 1 MHz, VB = 3 MHz (AV) RB = 1 MHz, VB = 1 kHz
<b>Input Power (System)</b>	120Vac, 60Hz	<b>Environmental Conditions</b>	25°C, 68% RH
<b>Tested By</b>	Tom Yang		

**Antenna Polarity & Test Distance : Horizontal at 3 m**

No	Frequency (MHz)	Emission Level (dBuV/m)	Limit (dBuV/m)	Margin (dB)	Antenna Height (m)	Table Angle (Degree)	Raw Value (dBuV)	Correction Factor (dB/m)
1	#13650.00	42.6 PK	88.2	-45.6	2.34 H	337	29.7	12.9
2	#13650.00	30.4 AV	68.2	-37.8	2.34 H	337	17.5	12.9
3	20475.00	43.8 PK	74.0	-30.2	1.55 H	109	48.6	-4.8
4	20475.00	32.9 AV	54.0	-21.1	1.55 H	109	37.7	-4.8
5	#27300.00	44.3 PK	88.2	-43.9	2.63 H	214	45.3	-1.0
6	#27300.00	33.7 AV	68.2	-34.5	2.63 H	214	34.7	-1.0

**Antenna Polarity & Test Distance : Vertical at 3 m**

No	Frequency (MHz)	Emission Level (dBuV/m)	Limit (dBuV/m)	Margin (dB)	Antenna Height (m)	Table Angle (Degree)	Raw Value (dBuV)	Correction Factor (dB/m)
1	#13650.00	42.6 PK	88.2	-45.6	1.02 V	163	29.7	12.9
2	#13650.00	29.6 AV	68.2	-38.6	1.02 V	163	16.7	12.9
3	20475.00	43.2 PK	74.0	-30.8	1.88 V	248	48.0	-4.8
4	20475.00	32.1 AV	54.0	-21.9	1.88 V	248	36.9	-4.8
5	#27300.00	42.9 PK	88.2	-45.3	2.16 V	310	43.9	-1.0
6	#27300.00	33.2 AV	68.2	-35.0	2.16 V	310	34.2	-1.0

**Remarks:**

1. Emission Level(dBuV/m) = Raw Value(dBuV) + Correction Factor(dB/m)
2. Correction Factor(dB/m) = Antenna Factor(dB/m) + Cable Factor(dB) – Pre-Amplifier Factor(dB)
3. Margin value = Emission Level – Limit value
4. The other emission levels were very low against the limit.
5. "#": The radiated frequency is out of the restricted band.

<b>RF Mode</b>	TX 802.11be (EHT160)	<b>Channel</b>	CH 207 : 6985 MHz
<b>Frequency Range</b>	1 GHz ~ 40 GHz	<b>Detector Function &amp; Bandwidth</b>	(PK) RB = 1 MHz, VB = 3 MHz (AV) RB = 1 MHz, VB = 1 kHz
<b>Input Power (System)</b>	120Vac, 60Hz	<b>Environmental Conditions</b>	25°C, 68% RH
<b>Tested By</b>	Tom Yang		

**Antenna Polarity & Test Distance : Horizontal at 3 m**

No	Frequency (MHz)	Emission Level (dBuV/m)	Limit (dBuV/m)	Margin (dB)	Antenna Height (m)	Table Angle (Degree)	Raw Value (dBuV)	Correction Factor (dB/m)
1	#13970.00	42.0 PK	88.2	-46.2	2.36 H	328	28.9	13.1
2	#13970.00	29.9 AV	68.2	-38.3	2.36 H	328	16.8	13.1
3	20955.00	43.0 PK	74.0	-31.0	1.60 H	101	47.1	-4.1
4	20955.00	32.5 AV	54.0	-21.5	1.60 H	101	36.6	-4.1
5	#27940.00	45.1 PK	88.2	-43.1	2.64 H	195	46.2	-1.1
6	#27940.00	34.4 AV	68.2	-33.8	2.64 H	195	35.5	-1.1

**Antenna Polarity & Test Distance : Vertical at 3 m**

No	Frequency (MHz)	Emission Level (dBuV/m)	Limit (dBuV/m)	Margin (dB)	Antenna Height (m)	Table Angle (Degree)	Raw Value (dBuV)	Correction Factor (dB/m)
1	#13970.00	43.6 PK	88.2	-44.6	1.11 V	149	30.5	13.1
2	#13970.00	30.3 AV	68.2	-37.9	1.11 V	149	17.2	13.1
3	20955.00	42.6 PK	74.0	-31.4	1.66 V	221	46.7	-4.1
4	20955.00	31.1 AV	54.0	-22.9	1.66 V	221	35.2	-4.1
5	#27940.00	43.1 PK	88.2	-45.1	2.12 V	317	44.2	-1.1
6	#27940.00	34.0 AV	68.2	-34.2	2.12 V	317	35.1	-1.1

**Remarks:**

1. Emission Level(dBuV/m) = Raw Value(dBuV) + Correction Factor(dB/m)
2. Correction Factor(dB/m) = Antenna Factor(dB/m) + Cable Factor(dB) – Pre-Amplifier Factor(dB)
3. Margin value = Emission Level – Limit value
4. The other emission levels were very low against the limit.
5. "#": The radiated frequency is out of the restricted band.

<b>RF Mode</b>	TX 802.11be (EHT320)	<b>Channel</b>	CH 31 : 6105 MHz
<b>Frequency Range</b>	1 GHz ~ 40 GHz	<b>Detector Function &amp; Bandwidth</b>	(PK) RB = 1 MHz, VB = 3 MHz (AV) RB = 1 MHz, VB = 2 kHz
<b>Input Power (System)</b>	120Vac, 60Hz	<b>Environmental Conditions</b>	25°C, 68% RH
<b>Tested By</b>	Tom Yang		

**Antenna Polarity & Test Distance : Horizontal at 3 m**

No	Frequency (MHz)	Emission Level (dBuV/m)	Limit (dBuV/m)	Margin (dB)	Antenna Height (m)	Table Angle (Degree)	Raw Value (dBuV)	Correction Factor (dB/m)
1	12210.00	42.3 PK	74.0	-31.7	2.45 H	346	31.9	10.4
2	12210.00	30.2 AV	54.0	-23.8	2.45 H	346	19.8	10.4
3	18315.00	43.9 PK	74.0	-30.1	1.54 H	98	51.0	-7.1
4	18315.00	33.3 AV	54.0	-20.7	1.54 H	98	40.4	-7.1
5	#24420.00	43.9 PK	88.2	-44.3	2.82 H	220	45.7	-1.8
6	#24420.00	34.3 AV	68.2	-33.9	2.82 H	220	36.1	-1.8

**Antenna Polarity & Test Distance : Vertical at 3 m**

No	Frequency (MHz)	Emission Level (dBuV/m)	Limit (dBuV/m)	Margin (dB)	Antenna Height (m)	Table Angle (Degree)	Raw Value (dBuV)	Correction Factor (dB/m)
1	12210.00	44.6 PK	74.0	-29.4	1.01 V	197	34.2	10.4
2	12210.00	30.9 AV	54.0	-23.1	1.01 V	197	20.5	10.4
3	18315.00	45.0 PK	74.0	-29.0	1.84 V	221	52.1	-7.1
4	18315.00	33.2 AV	54.0	-20.8	1.84 V	221	40.3	-7.1
5	#24420.00	43.5 PK	88.2	-44.7	2.29 V	332	45.3	-1.8
6	#24420.00	33.3 AV	68.2	-34.9	2.29 V	332	35.1	-1.8

**Remarks:**

1. Emission Level(dBuV/m) = Raw Value(dBuV) + Correction Factor(dB/m)
2. Correction Factor(dB/m) = Antenna Factor(dB/m) + Cable Factor(dB) – Pre-Amplifier Factor(dB)
3. Margin value = Emission Level – Limit value
4. The other emission levels were very low against the limit.
5. " # ": The radiated frequency is out of the restricted band.



<b>RF Mode</b>	TX 802.11be (EHT320)	<b>Channel</b>	CH 63 : 6265 MHz
<b>Frequency Range</b>	1 GHz ~ 40 GHz	<b>Detector Function &amp; Bandwidth</b>	(PK) RB = 1 MHz, VB = 3 MHz (AV) RB = 1 MHz, VB = 2 kHz
<b>Input Power (System)</b>	120Vac, 60Hz	<b>Environmental Conditions</b>	25°C, 68% RH
<b>Tested By</b>	Tom Yang		

**Antenna Polarity & Test Distance : Horizontal at 3 m**

No	Frequency (MHz)	Emission Level (dBuV/m)	Limit (dBuV/m)	Margin (dB)	Antenna Height (m)	Table Angle (Degree)	Raw Value (dBuV)	Correction Factor (dB/m)
1	12530.00	42.4 PK	74.0	-31.6	2.42 H	344	32.5	9.9
2	12530.00	30.2 AV	54.0	-23.8	2.42 H	344	20.3	9.9
3	18795.00	43.7 PK	74.0	-30.3	1.58 H	118	50.6	-6.9
4	18795.00	33.0 AV	54.0	-21.0	1.58 H	118	39.9	-6.9
5	#25060.00	43.7 PK	88.2	-44.5	2.75 H	206	45.2	-1.5
6	#25060.00	34.2 AV	68.2	-34.0	2.75 H	206	35.7	-1.5

**Antenna Polarity & Test Distance : Vertical at 3 m**

No	Frequency (MHz)	Emission Level (dBuV/m)	Limit (dBuV/m)	Margin (dB)	Antenna Height (m)	Table Angle (Degree)	Raw Value (dBuV)	Correction Factor (dB/m)
1	12530.00	42.6 PK	74.0	-31.4	1.04 V	174	32.7	9.9
2	12530.00	29.6 AV	54.0	-24.4	1.04 V	174	19.7	9.9
3	18795.00	43.2 PK	74.0	-30.8	1.91 V	253	50.1	-6.9
4	18795.00	32.1 AV	54.0	-21.9	1.91 V	253	39.0	-6.9
5	#25060.00	42.5 PK	88.2	-45.7	2.19 V	294	44.0	-1.5
6	#25060.00	32.9 AV	68.2	-35.3	2.19 V	294	34.4	-1.5

**Remarks:**

1. Emission Level(dBuV/m) = Raw Value(dBuV) + Correction Factor(dB/m)
2. Correction Factor(dB/m) = Antenna Factor(dB/m) + Cable Factor(dB) – Pre-Amplifier Factor(dB)
3. Margin value = Emission Level – Limit value
4. The other emission levels were very low against the limit.
5. " # ": The radiated frequency is out of the restricted band.

<b>RF Mode</b>	TX 802.11be (EHT320)	<b>Channel</b>	CH 95 : 6425 MHz
<b>Frequency Range</b>	1 GHz ~ 40 GHz	<b>Detector Function &amp; Bandwidth</b>	(PK) RB = 1 MHz, VB = 3 MHz (AV) RB = 1 MHz, VB = 2 kHz
<b>Input Power (System)</b>	120Vac, 60Hz	<b>Environmental Conditions</b>	25°C, 68% RH
<b>Tested By</b>	Tom Yang		

**Antenna Polarity & Test Distance : Horizontal at 3 m**

No	Frequency (MHz)	Emission Level (dBuV/m)	Limit (dBuV/m)	Margin (dB)	Antenna Height (m)	Table Angle (Degree)	Raw Value (dBuV)	Correction Factor (dB/m)
1	#12850.00	42.0 PK	88.2	-46.2	2.30 H	339	31.5	10.5
2	#12850.00	30.0 AV	68.2	-38.2	2.30 H	339	19.5	10.5
3	19275.00	44.1 PK	74.0	-29.9	1.56 H	100	50.7	-6.6
4	19275.00	32.9 AV	54.0	-21.1	1.56 H	100	39.5	-6.6
5	#25700.00	44.4 PK	88.2	-43.8	2.64 H	227	45.6	-1.2
6	#25700.00	33.6 AV	68.2	-34.6	2.64 H	227	34.8	-1.2

**Antenna Polarity & Test Distance : Vertical at 3 m**

No	Frequency (MHz)	Emission Level (dBuV/m)	Limit (dBuV/m)	Margin (dB)	Antenna Height (m)	Table Angle (Degree)	Raw Value (dBuV)	Correction Factor (dB/m)
1	#12850.00	44.0 PK	88.2	-44.2	1.08 V	144	33.5	10.5
2	#12850.00	30.5 AV	68.2	-37.7	1.08 V	144	20.0	10.5
3	19275.00	42.7 PK	74.0	-31.3	1.69 V	212	49.3	-6.6
4	19275.00	31.1 AV	54.0	-22.9	1.69 V	212	37.7	-6.6
5	#25700.00	42.8 PK	88.2	-45.4	2.13 V	324	44.0	-1.2
6	#25700.00	33.7 AV	68.2	-34.5	2.13 V	324	34.9	-1.2

**Remarks:**

1. Emission Level(dBuV/m) = Raw Value(dBuV) + Correction Factor(dB/m)
2. Correction Factor(dB/m) = Antenna Factor(dB/m) + Cable Factor(dB) – Pre-Amplifier Factor(dB)
3. Margin value = Emission Level – Limit value
4. The other emission levels were very low against the limit.
5. "#": The radiated frequency is out of the restricted band.

<b>RF Mode</b>	TX 802.11be (EHT320)	<b>Channel</b>	CH 127 : 6585 MHz
<b>Frequency Range</b>	1 GHz ~ 40 GHz	<b>Detector Function &amp; Bandwidth</b>	(PK) RB = 1 MHz, VB = 3 MHz (AV) RB = 1 MHz, VB = 2 kHz
<b>Input Power (System)</b>	120Vac, 60Hz	<b>Environmental Conditions</b>	25°C, 68% RH
<b>Tested By</b>	Tom Yang		

**Antenna Polarity & Test Distance : Horizontal at 3 m**

No	Frequency (MHz)	Emission Level (dBuV/m)	Limit (dBuV/m)	Margin (dB)	Antenna Height (m)	Table Angle (Degree)	Raw Value (dBuV)	Correction Factor (dB/m)
1	#13170.00	42.5 PK	88.2	-45.7	2.40 H	337	31.2	11.3
2	#13170.00	30.1 AV	68.2	-38.1	2.40 H	337	18.8	11.3
3	19755.00	43.2 PK	74.0	-30.8	1.54 H	86	49.3	-6.1
4	19755.00	32.9 AV	54.0	-21.1	1.54 H	86	39.0	-6.1
5	#26340.00	44.5 PK	88.2	-43.7	2.82 H	227	45.4	-0.9
6	#26340.00	34.8 AV	68.2	-33.4	2.82 H	227	35.7	-0.9

**Antenna Polarity & Test Distance : Vertical at 3 m**

No	Frequency (MHz)	Emission Level (dBuV/m)	Limit (dBuV/m)	Margin (dB)	Antenna Height (m)	Table Angle (Degree)	Raw Value (dBuV)	Correction Factor (dB/m)
1	#13170.00	43.0 PK	88.2	-45.2	1.01 V	159	31.7	11.3
2	#13170.00	30.1 AV	68.2	-38.1	1.01 V	159	18.8	11.3
3	19755.00	43.4 PK	74.0	-30.6	1.85 V	233	49.5	-6.1
4	19755.00	32.2 AV	54.0	-21.8	1.85 V	233	38.3	-6.1
5	#26340.00	42.7 PK	88.2	-45.5	2.13 V	311	43.6	-0.9
6	#26340.00	33.0 AV	68.2	-35.2	2.13 V	311	33.9	-0.9

**Remarks:**

1. Emission Level(dBuV/m) = Raw Value(dBuV) + Correction Factor(dB/m)
2. Correction Factor(dB/m) = Antenna Factor(dB/m) + Cable Factor(dB) – Pre-Amplifier Factor(dB)
3. Margin value = Emission Level – Limit value
4. The other emission levels were very low against the limit.
5. "#": The radiated frequency is out of the restricted band.

<b>RF Mode</b>	TX 802.11be (EHT320)	<b>Channel</b>	CH 159 : 6745 MHz
<b>Frequency Range</b>	1 GHz ~ 40 GHz	<b>Detector Function &amp; Bandwidth</b>	(PK) RB = 1 MHz, VB = 3 MHz (AV) RB = 1 MHz, VB = 2 kHz
<b>Input Power (System)</b>	120Vac, 60Hz	<b>Environmental Conditions</b>	25°C, 68% RH
<b>Tested By</b>	Tom Yang		

**Antenna Polarity & Test Distance : Horizontal at 3 m**

No	Frequency (MHz)	Emission Level (dBuV/m)	Limit (dBuV/m)	Margin (dB)	Antenna Height (m)	Table Angle (Degree)	Raw Value (dBuV)	Correction Factor (dB/m)
1	#13490.00	42.1 PK	88.2	-46.1	2.43 H	333	29.7	12.4
2	#13490.00	30.1 AV	68.2	-38.1	2.43 H	333	17.7	12.4
3	20235.00	43.8 PK	74.0	-30.2	1.59 H	103	49.5	-5.7
4	20235.00	33.4 AV	54.0	-20.6	1.59 H	103	39.1	-5.7
5	#26980.00	43.7 PK	88.2	-44.5	2.72 H	201	44.4	-0.7
6	#26980.00	34.2 AV	68.2	-34.0	2.72 H	201	34.9	-0.7

**Antenna Polarity & Test Distance : Vertical at 3 m**

No	Frequency (MHz)	Emission Level (dBuV/m)	Limit (dBuV/m)	Margin (dB)	Antenna Height (m)	Table Angle (Degree)	Raw Value (dBuV)	Correction Factor (dB/m)
1	#13490.00	42.8 PK	88.2	-45.4	1.15 V	156	30.4	12.4
2	#13490.00	29.8 AV	68.2	-38.4	1.15 V	156	17.4	12.4
3	20235.00	41.8 PK	74.0	-32.2	1.75 V	249	47.5	-5.7
4	20235.00	31.3 AV	54.0	-22.7	1.75 V	249	37.0	-5.7
5	#26980.00	42.0 PK	88.2	-46.2	2.14 V	321	42.7	-0.7
6	#26980.00	32.9 AV	68.2	-35.3	2.14 V	321	33.6	-0.7

**Remarks:**

1. Emission Level(dBuV/m) = Raw Value(dBuV) + Correction Factor(dB/m)
2. Correction Factor(dB/m) = Antenna Factor(dB/m) + Cable Factor(dB) – Pre-Amplifier Factor(dB)
3. Margin value = Emission Level – Limit value
4. The other emission levels were very low against the limit.
5. "#": The radiated frequency is out of the restricted band.

<b>RF Mode</b>	TX 802.11be (EHT320)	<b>Channel</b>	CH 191 : 6905 MHz
<b>Frequency Range</b>	1 GHz ~ 40 GHz	<b>Detector Function &amp; Bandwidth</b>	(PK) RB = 1 MHz, VB = 3 MHz (AV) RB = 1 MHz, VB = 2 kHz
<b>Input Power (System)</b>	120Vac, 60Hz	<b>Environmental Conditions</b>	25°C, 68% RH
<b>Tested By</b>	Tom Yang		

**Antenna Polarity & Test Distance : Horizontal at 3 m**

No	Frequency (MHz)	Emission Level (dBuV/m)	Limit (dBuV/m)	Margin (dB)	Antenna Height (m)	Table Angle (Degree)	Raw Value (dBuV)	Correction Factor (dB/m)
1	#13810.00	42.7 PK	88.2	-45.5	2.43 H	358	29.7	13.0
2	#13810.00	30.6 AV	68.2	-37.6	2.43 H	358	17.6	13.0
3	20715.00	43.2 PK	74.0	-30.8	1.61 H	114	47.9	-4.7
4	20715.00	32.7 AV	54.0	-21.3	1.61 H	114	37.4	-4.7
5	#27620.00	43.9 PK	88.2	-44.3	2.76 H	192	45.1	-1.2
6	#27620.00	34.5 AV	68.2	-33.7	2.76 H	192	35.7	-1.2

**Antenna Polarity & Test Distance : Vertical at 3 m**

No	Frequency (MHz)	Emission Level (dBuV/m)	Limit (dBuV/m)	Margin (dB)	Antenna Height (m)	Table Angle (Degree)	Raw Value (dBuV)	Correction Factor (dB/m)
1	#13810.00	43.1 PK	88.2	-45.1	1.25 V	156	30.1	13.0
2	#13810.00	29.9 AV	68.2	-38.3	1.25 V	156	16.9	13.0
3	20715.00	41.6 PK	74.0	-32.4	1.78 V	245	46.3	-4.7
4	20715.00	30.7 AV	54.0	-23.3	1.78 V	245	35.4	-4.7
5	#27620.00	42.9 PK	88.2	-45.3	2.18 V	319	44.1	-1.2
6	#27620.00	33.5 AV	68.2	-34.7	2.18 V	319	34.7	-1.2

**Remarks:**

1. Emission Level(dBuV/m) = Raw Value(dBuV) + Correction Factor(dB/m)
2. Correction Factor(dB/m) = Antenna Factor(dB/m) + Cable Factor(dB) – Pre-Amplifier Factor(dB)
3. Margin value = Emission Level – Limit value
4. The other emission levels were very low against the limit.
5. "#": The radiated frequency is out of the restricted band.

### Below 1GHz Data:

<b>RF Mode</b>	TX 802.11be (EHT320)	<b>Channel</b>	CH 159 : 6745 MHz
<b>Frequency Range</b>	9 kHz ~ 1 GHz	<b>Detector Function &amp; Bandwidth</b>	(QP) RB = 120kHz
<b>Input Power (System)</b>	120Vac, 60Hz	<b>Environmental Conditions</b>	25°C, 66% RH
<b>Tested By</b>	Tom Yang		

#### Antenna Polarity & Test Distance : Horizontal at 3 m

No	Frequency (MHz)	Emission Level (dBuV/m)	Limit (dBuV/m)	Margin (dB)	Antenna Height (m)	Table Angle (Degree)	Raw Value (dBuV)	Correction Factor (dB/m)
1	142.04	40.5 QP	43.5	-3.0	1.50 H	96	52.3	-11.8
2	166.22	39.8 QP	43.5	-3.7	1.00 H	67	51.8	-12.0
3	299.96	42.9 QP	46.0	-3.1	1.00 H	210	53.3	-10.4
4	697.02	42.7 QP	46.0	-3.3	1.50 H	106	43.1	-0.4
5	720.40	42.7 QP	46.0	-3.3	2.00 H	29	42.8	-0.1
6	798.76	42.8 QP	46.0	-3.2	1.50 H	146	41.2	1.6

#### Remarks:

1. Emission Level(dBuV/m) = Raw Value(dBuV) + Correction Factor(dB/m)
2. Correction Factor(dB/m) = Antenna Factor(dB/m) + Cable Factor(dB) – Pre-Amplifier Factor(dB)
3. Margin value = Emission Level – Limit value
4. The other emission levels were very low against the limit of frequency range 30 MHz ~ 1 GHz.
5. The emission levels were very low against the limit of frequency range 9 kHz ~ 30 MHz: the amplitude of spurious emissions attenuated more than 20 dB below the permissible value to be report.

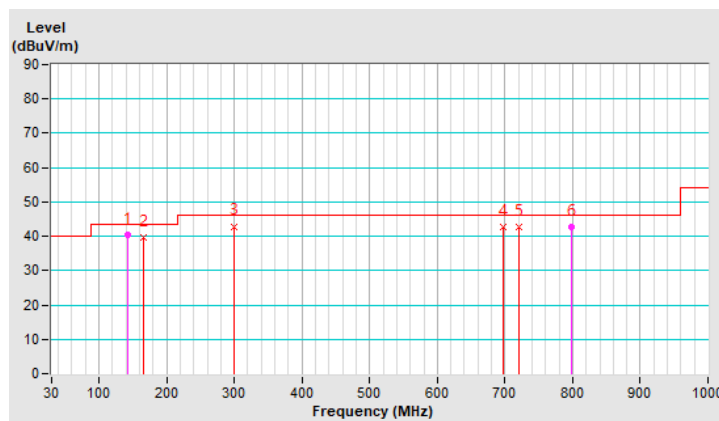

<b>RF Mode</b>	TX 802.11be (EHT320)	<b>Channel</b>	CH 159 : 6745 MHz
<b>Frequency Range</b>	9 kHz ~ 1 GHz	<b>Detector Function &amp; Bandwidth</b>	(QP) RB = 120kHz
<b>Input Power (System)</b>	120Vac, 60Hz	<b>Environmental Conditions</b>	25°C, 66% RH
<b>Tested By</b>	Tom Yang		

Antenna Polarity & Test Distance : Vertical at 3 m								
No	Frequency (MHz)	Emission Level (dBuV/m)	Limit (dBuV/m)	Margin (dB)	Antenna Height (m)	Table Angle (Degree)	Raw Value (dBuV)	Correction Factor (dB/m)
1	33.28	33.5 QP	40.0	-6.5	1.50 V	55	47.0	-13.5
2	99.50	28.0 QP	43.5	-15.5	1.00 V	86	44.4	-16.4
3	167.00	39.3 QP	43.5	-4.2	1.00 V	125	51.4	-12.1
4	240.03	36.9 QP	46.0	-9.1	2.00 V	104	49.8	-12.9
5	299.30	42.5 QP	46.0	-3.5	1.00 V	167	52.9	-10.4
6	720.01	41.4 QP	46.0	-4.6	1.50 V	115	41.5	-0.1

**Remarks:**

1. Emission Level(dBuV/m) = Raw Value(dBuV) + Correction Factor(dB/m)
2. Correction Factor(dB/m) = Antenna Factor(dB/m) + Cable Factor(dB) – Pre-Amplifier Factor(dB)
3. Margin value = Emission Level – Limit value
4. The other emission levels were very low against the limit of frequency range 30 MHz ~ 1 GHz.
5. The emission levels were very low against the limit of frequency range 9 kHz ~ 30 MHz: the amplitude of spurious emissions attenuated more than 20 dB below the permissible value to be report.

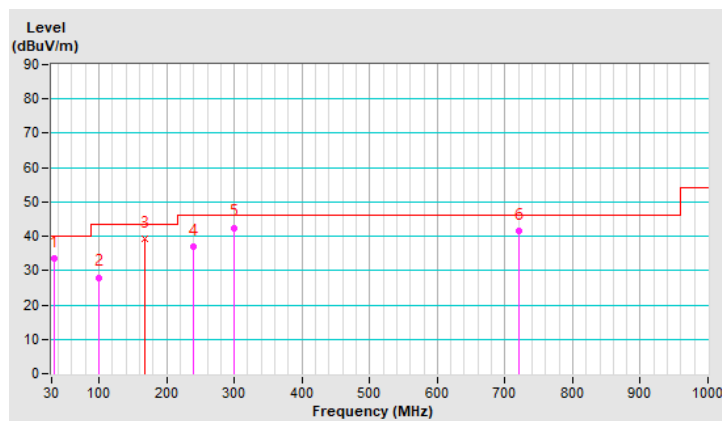

#### 4.1.7 Test Results (Conducted)

<b>Radiated versus Conducted Measurement</b>	
<input checked="" type="checkbox"/> Conducted measurement	<input type="checkbox"/> Radiated measurement
<p><u>For Radiated measurement:</u></p> <p>The level of unwanted emissions was measured when radiated by the cabinet or structure of the equipment with the antenna connector(s) terminated by a specified load (cabinet radiation)</p> <p><u>For Conducted measurement:</u></p> <p>The level of unwanted emissions was measured as their power in a specified load (conducted spurious emissions).</p>	

<b>Conducted Emission Convert Formula</b>
<p>a. Emission Level (dBuV/m) = EIRP Level (dBm) – 20log(d) + 104.8                d = measurement distance in 3 meters.</p> <p>b. EIRP Level (dBm) = Raw Value(dBm) + Correction Factor(dB)</p> <p>c. Correction Factor is directional gain, and the composite gain will be used when signal support the correlated signal</p> <p style="padding-left: 20px;">For the out of band spurious the gain for the specific band may have been used rather than the highest gain across all bands.</p> <p style="padding-left: 20px;">For the band edge the gain for the specific band may have been used.</p> <p>Notes:</p> <ol style="list-style-type: none"> <li>1. In restricted bands below 1000 MHz, add upper bound on ground plane reflection:              For f = 30 – 1000 MHz, add 4.7 dB.</li> <li>2. The conducted emission test was considered some factor to compute test result.</li> </ol>



#### 4.1.7.1 Test Results (Mode 1)

#### Above 1GHz Data 802.11a - Channel 1

#### Conducted spurious emission table

No.	Frequency (MHz)	Emission Level (dBuV/m)	Limit (dBuV/m)	Margin (dB)	Raw Value (dBm)	Correction Factor (dB)	EIRP Level (dBm)
1	11914.06	41.66 PK	74	-32.34	-58.36	4.76	-53.60
2	11903.12	30.32 AV	54	-23.68	-69.7	4.76	-64.94
3	17862.81	41.63 PK	74	-32.37	-58.39	4.76	-53.63
4	17861.37	31.16 AV	54	-22.84	-68.86	4.76	-64.10

#### Remarks:

1. Margin value = Emission Level – Limit value
2. The other emission levels were very low against the limit.

### Chain 0

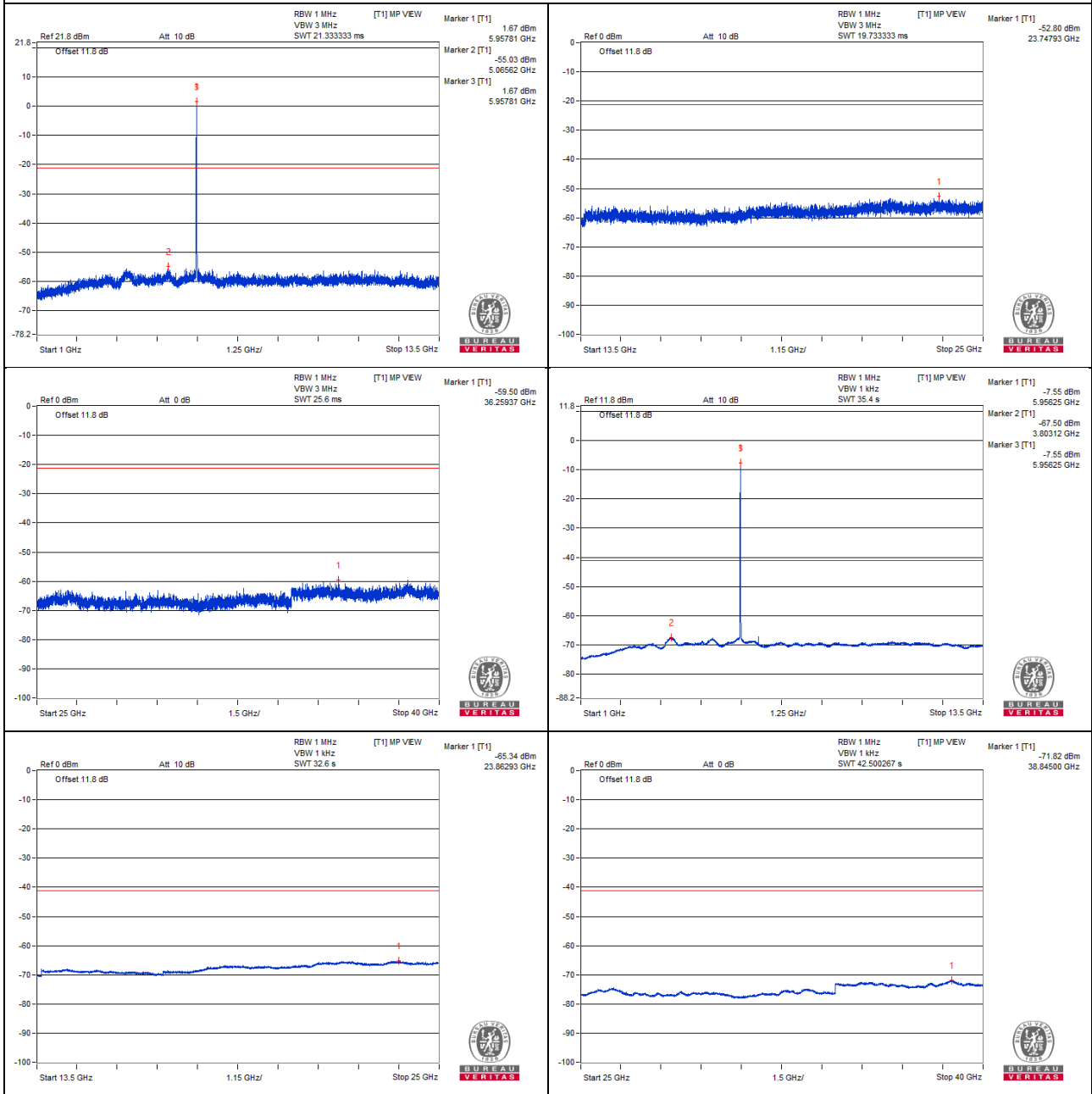

### Bandedge table

No.	Frequency (MHz)	Emission Level (dBuV/m)	Limit (dBuV/m)	Margin (dB)	Raw Value (dBm)	Correction Factor (dB)	EIRP Level (dBm)
1	#5862.1	43.96 PK	88.2	-44.24	-56.06	4.76	-51.30
2	#5924.3	32.68 AV	68.2	-35.52	-67.34	4.76	-62.58

#### Remarks:

1. Margin value = Emission Level – Limit value
2. The other emission levels were very low against the limit.
3. " # " : The frequency is out of the restricted band.

### Chain 0

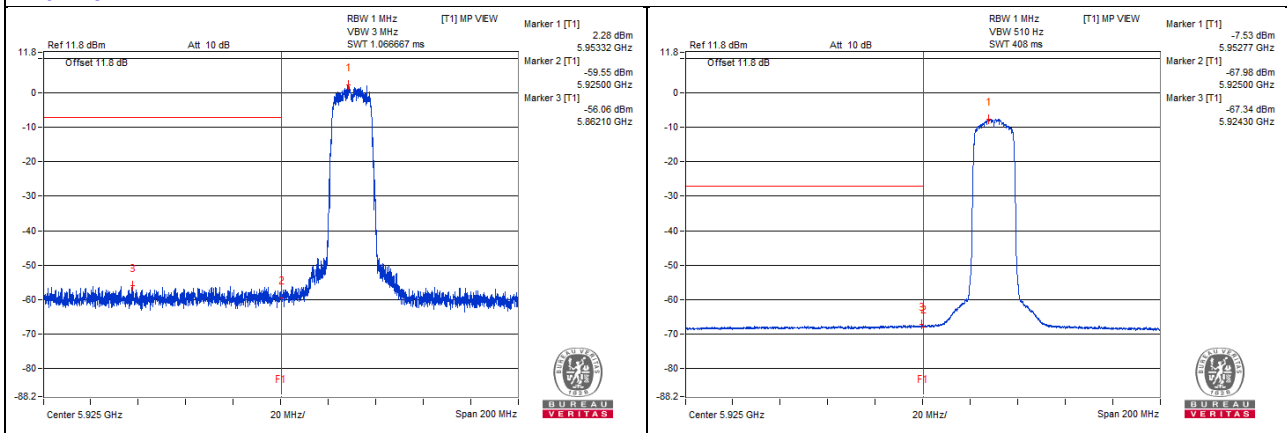

### 802.11a - Channel 45

#### Conducted spurious emission table

No.	Frequency (MHz)	Emission Level (dBuV/m)	Limit (dBuV/m)	Margin (dB)	Raw Value (dBm)	Correction Factor (dB)	EIRP Level (dBm)
1	12346.87	41.4 PK	74	-32.6	-58.62	4.76	-53.86
2	12353.12	30.48 AV	54	-23.52	-69.54	4.76	-64.78
3	18518.31	42.49 PK	74	-31.51	-57.53	4.76	-52.77
4	18516.87	32.42 AV	54	-21.58	-67.6	4.76	-62.84

#### Remarks:

1. Margin value = Emission Level – Limit value
2. The other emission levels were very low against the limit.

### Chain 0

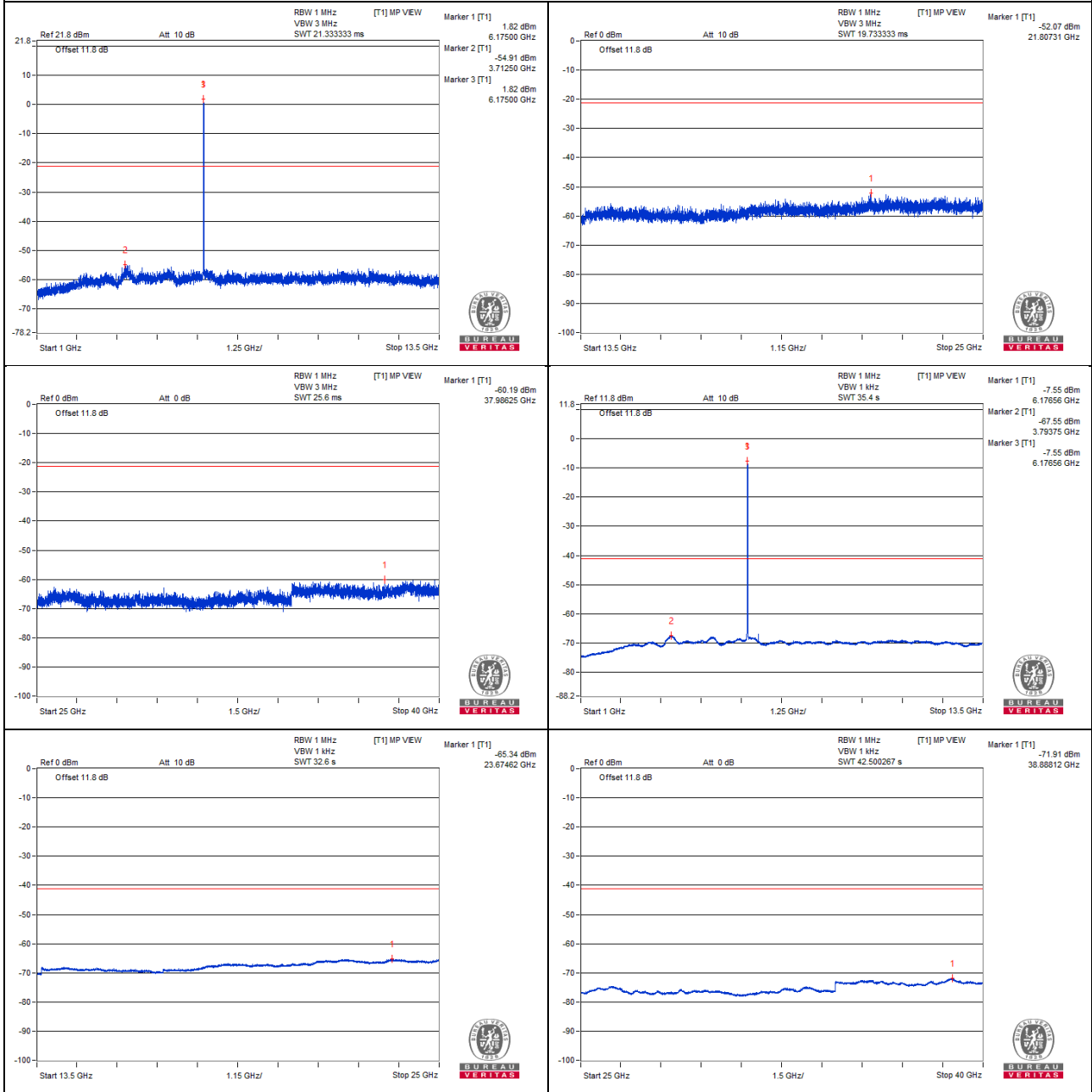

### 802.11a - Channel 93

#### Conducted spurious emission table

No.	Frequency (MHz)	Emission Level (dBuV/m)	Limit (dBuV/m)	Margin (dB)	Raw Value (dBm)	Correction Factor (dB)	EIRP Level (dBm)
1	#12834.37	40.9 PK	88.2	-47.3	-59.12	4.76	-54.36
2	#12825	29.73 AV	68.2	-38.47	-70.29	4.76	-65.53
3	19248.56	46.59 PK	74	-27.41	-53.43	4.76	-48.67
4	19247.12	32.82 AV	54	-21.18	-67.2	4.76	-62.44

#### Remarks:

1. Margin value = Emission Level – Limit value
2. The other emission levels were very low against the limit.
3. " # " : The frequency is out of the restricted band.

### Chain 0

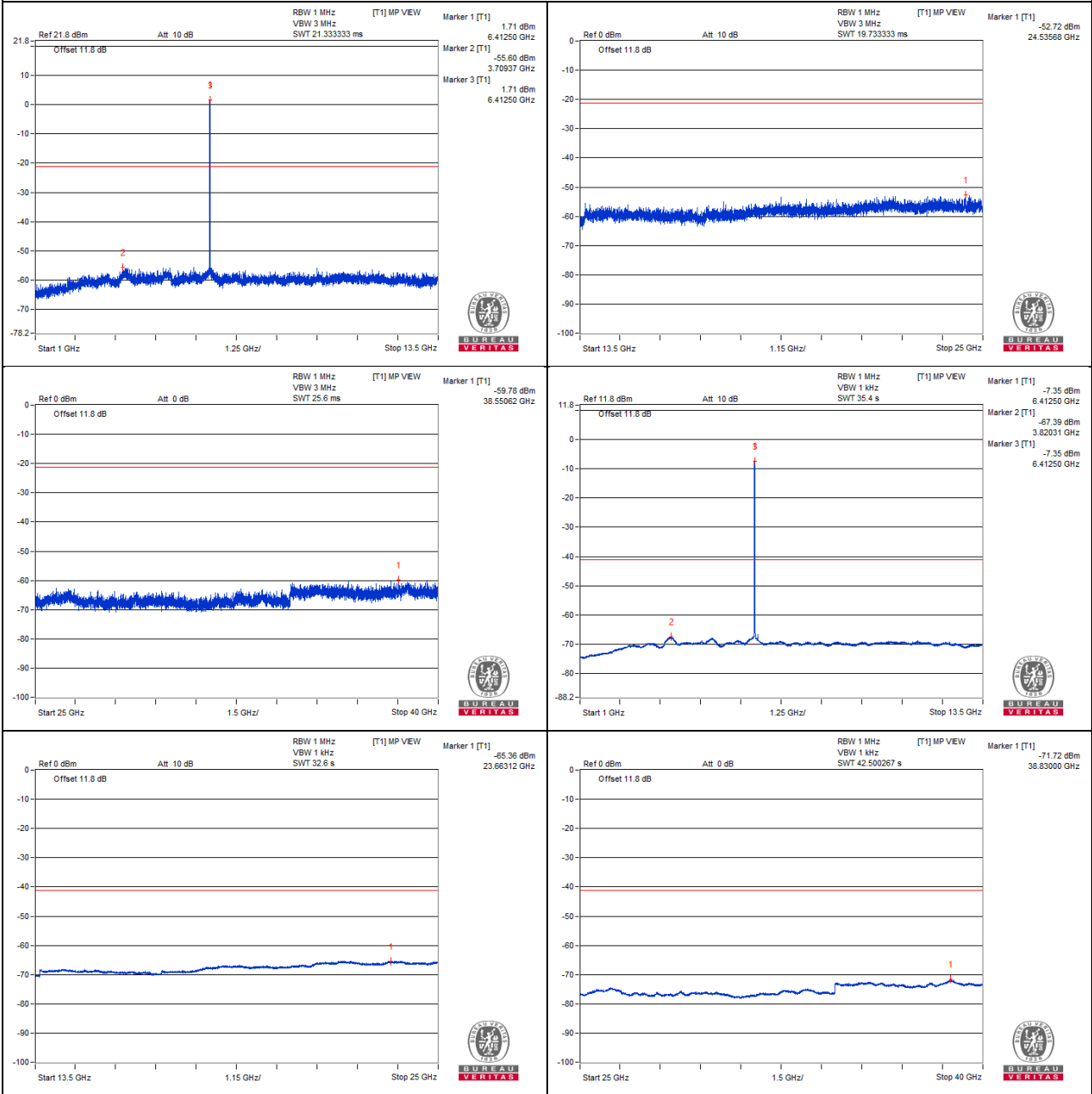

### 802.11a - Channel 97

#### Conducted spurious emission table

No.	Frequency (MHz)	Emission Level (dBuV/m)	Limit (dBuV/m)	Margin (dB)	Raw Value (dBm)	Correction Factor (dB)	EIRP Level (dBm)
1	#12879.68	40.78 PK	88.2	-47.42	-59.24	4.76	-54.48
2	#12875	29.41 AV	68.2	-38.79	-70.61	4.76	-65.85
3	19298.87	43.59 PK	74	-30.41	-56.43	4.76	-51.67
4	19314.68	33.04 AV	54	-20.96	-66.98	4.76	-62.22

#### Remarks:

1. Margin value = Emission Level – Limit value
2. The other emission levels were very low against the limit.
3. " # " : The frequency is out of the restricted band.



### Chain 0

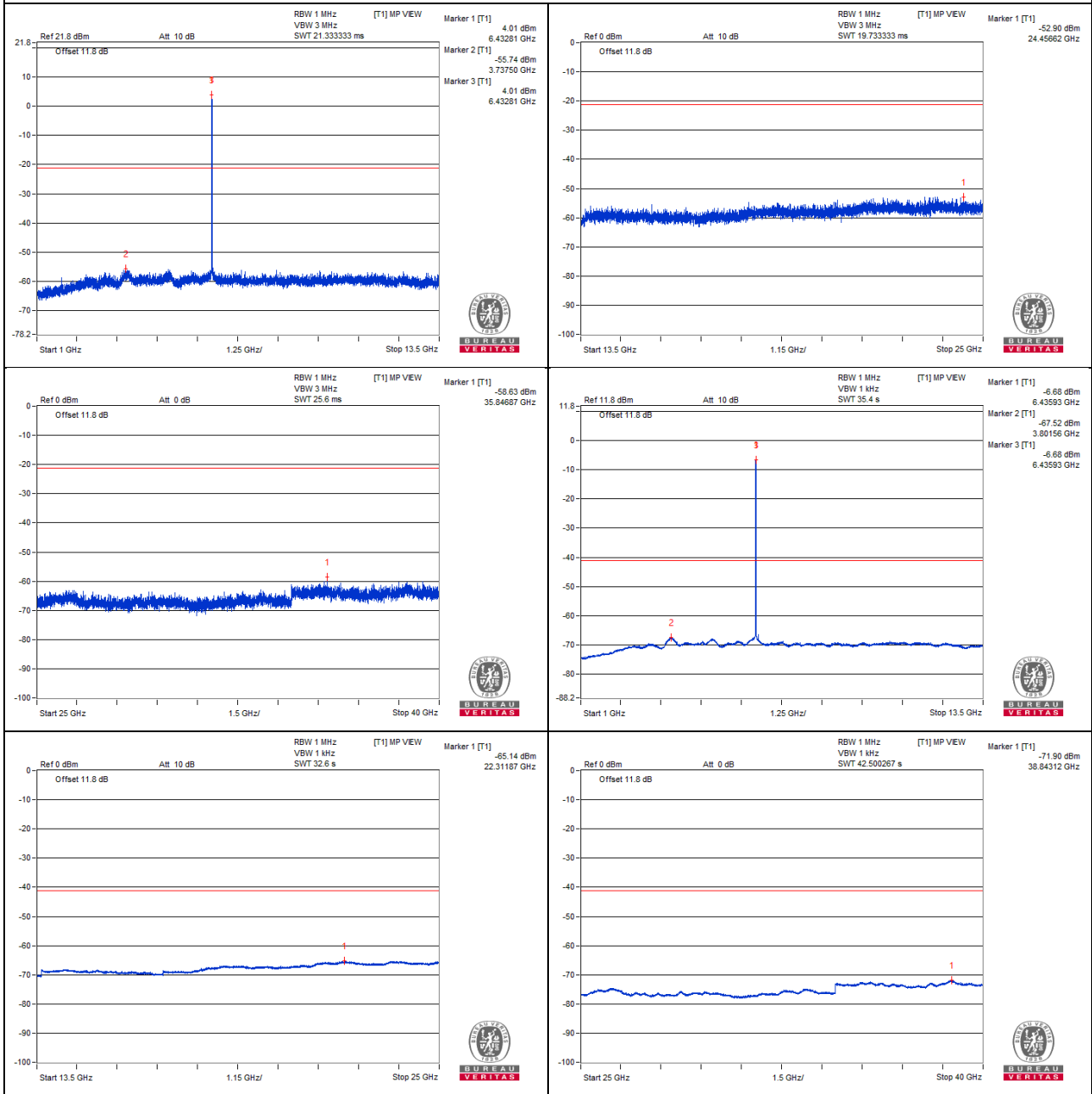

### 802.11a - Channel 105

#### Conducted spurious emission table

No.	Frequency (MHz)	Emission Level (dBuV/m)	Limit (dBuV/m)	Margin (dB)	Raw Value (dBm)	Correction Factor (dB)	EIRP Level (dBm)
1	#12954.68	41.38 PK	88.2	-46.82	-58.64	4.76	-53.88
2	#12940.62	29.16 AV	68.2	-39.04	-70.86	4.76	-66.10
3	19423.93	42.74 PK	74	-31.26	-57.28	4.76	-52.52
4	19422.5	32.87 AV	54	-21.13	-67.15	4.76	-62.39

#### Remarks:

1. Margin value = Emission Level – Limit value
2. The other emission levels were very low against the limit.
3. " # " : The frequency is out of the restricted band.

### Chain 0

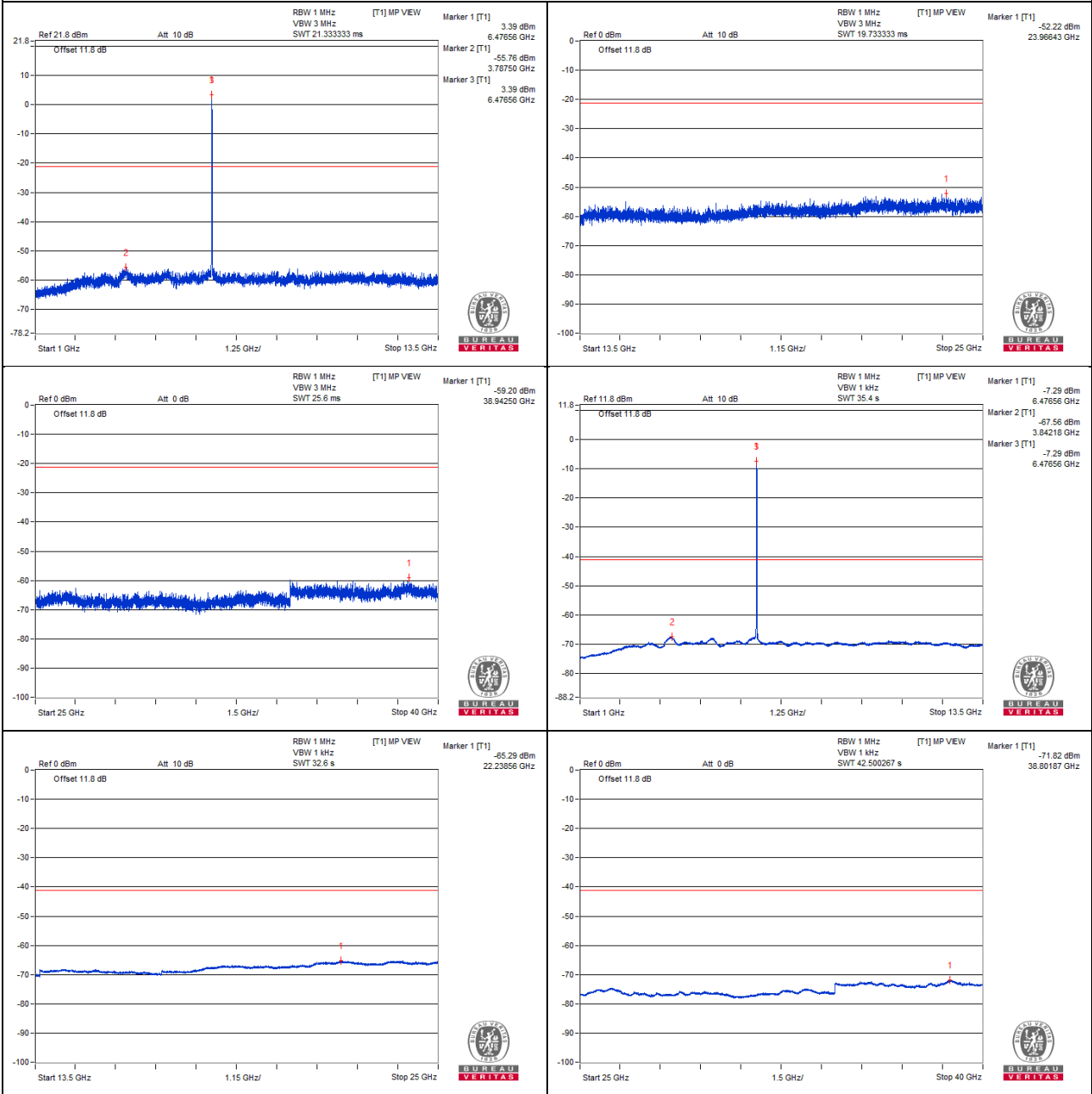

### 802.11a - Channel 113

#### Conducted spurious emission table

No.	Frequency (MHz)	Emission Level (dBuV/m)	Limit (dBuV/m)	Margin (dB)	Raw Value (dBm)	Correction Factor (dB)	EIRP Level (dBm)
1	#13028.12	41.32 PK	88.2	-46.88	-58.7	4.76	-53.94
2	#13023.43	29.08 AV	68.2	-39.12	-70.94	4.76	-66.18
3	19536.06	44.19 PK	74	-29.81	-55.83	4.76	-51.07
4	19541.81	32.52 AV	54	-21.48	-67.5	4.76	-62.74

#### Remarks:

1. Margin value = Emission Level – Limit value
2. The other emission levels were very low against the limit.
3. " # " : The frequency is out of the restricted band.

### Chain 0

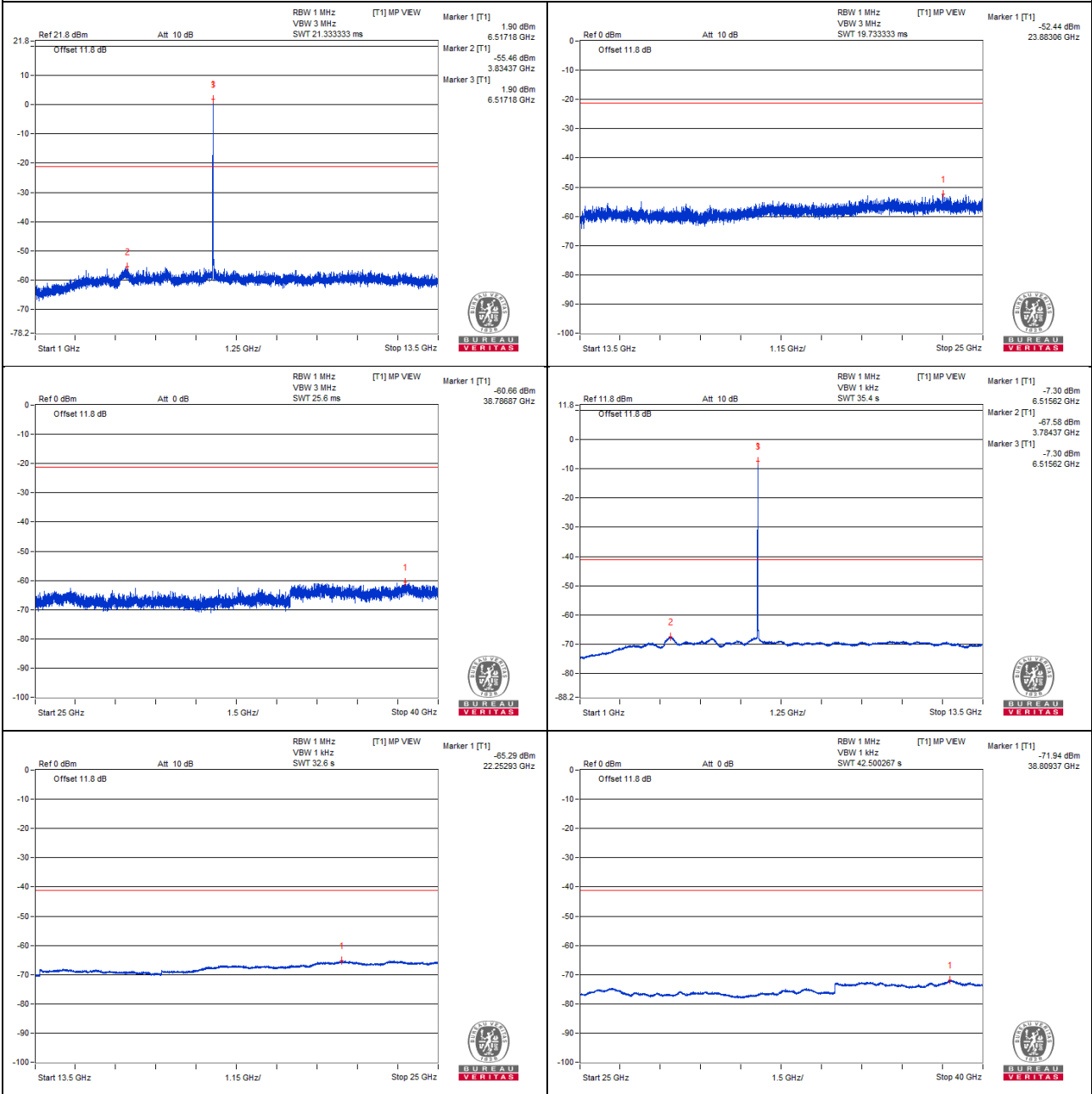

### 802.11a - Channel 117

#### Conducted spurious emission table

No.	Frequency (MHz)	Emission Level (dBuV/m)	Limit (dBuV/m)	Margin (dB)	Raw Value (dBm)	Correction Factor (dB)	EIRP Level (dBm)
1	#13064.06	39.79 PK	88.2	-48.41	-60.23	4.76	-55.47
2	#13065.62	29.36 AV	68.2	-38.84	-70.66	4.76	-65.90
3	19612.25	41.82 PK	74	-32.18	-58.2	4.76	-53.44
4	19607.93	32.56 AV	54	-21.44	-67.46	4.76	-62.70

#### Remarks:

1. Margin value = Emission Level – Limit value
2. The other emission levels were very low against the limit.
3. " # " : The frequency is out of the restricted band.

### Chain 0

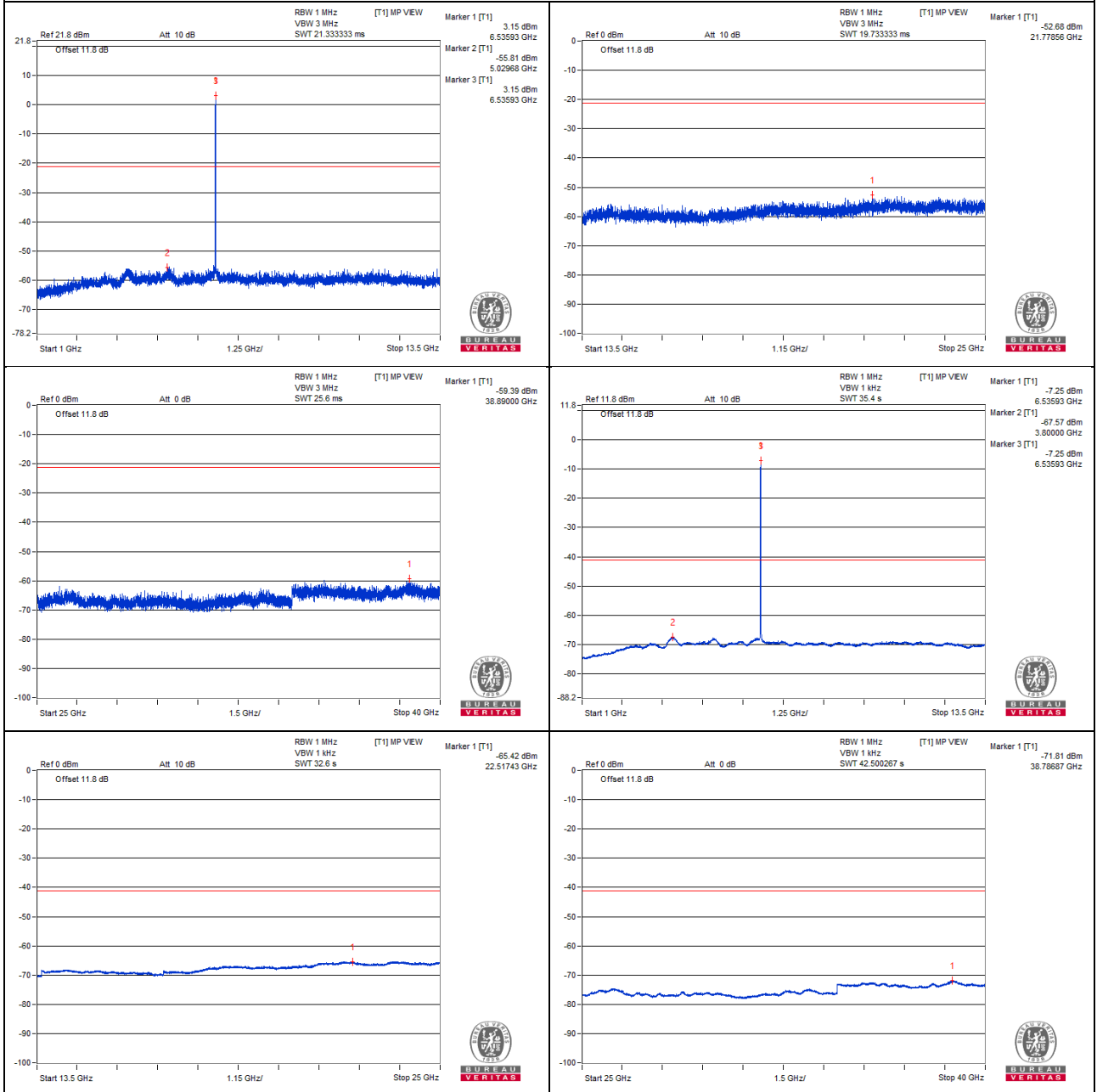

### 802.11a - Channel 153

#### Conducted spurious emission table

No.	Frequency (MHz)	Emission Level (dBuV/m)	Limit (dBuV/m)	Margin (dB)	Raw Value (dBm)	Correction Factor (dB)	EIRP Level (dBm)
1	#13435.93	41.27 PK	88.2	-46.93	-58.75	4.76	-53.99
2	#13426.56	29.74 AV	68.2	-38.46	-70.28	4.76	-65.52
3	20147	43.61 PK	74	-30.39	-56.41	4.76	-51.65
4	20141.25	32.75 AV	54	-21.25	-67.27	4.76	-62.51

#### Remarks:

1. Margin value = Emission Level – Limit value
2. The other emission levels were very low against the limit.
3. " # " : The frequency is out of the restricted band.



### Chain 0

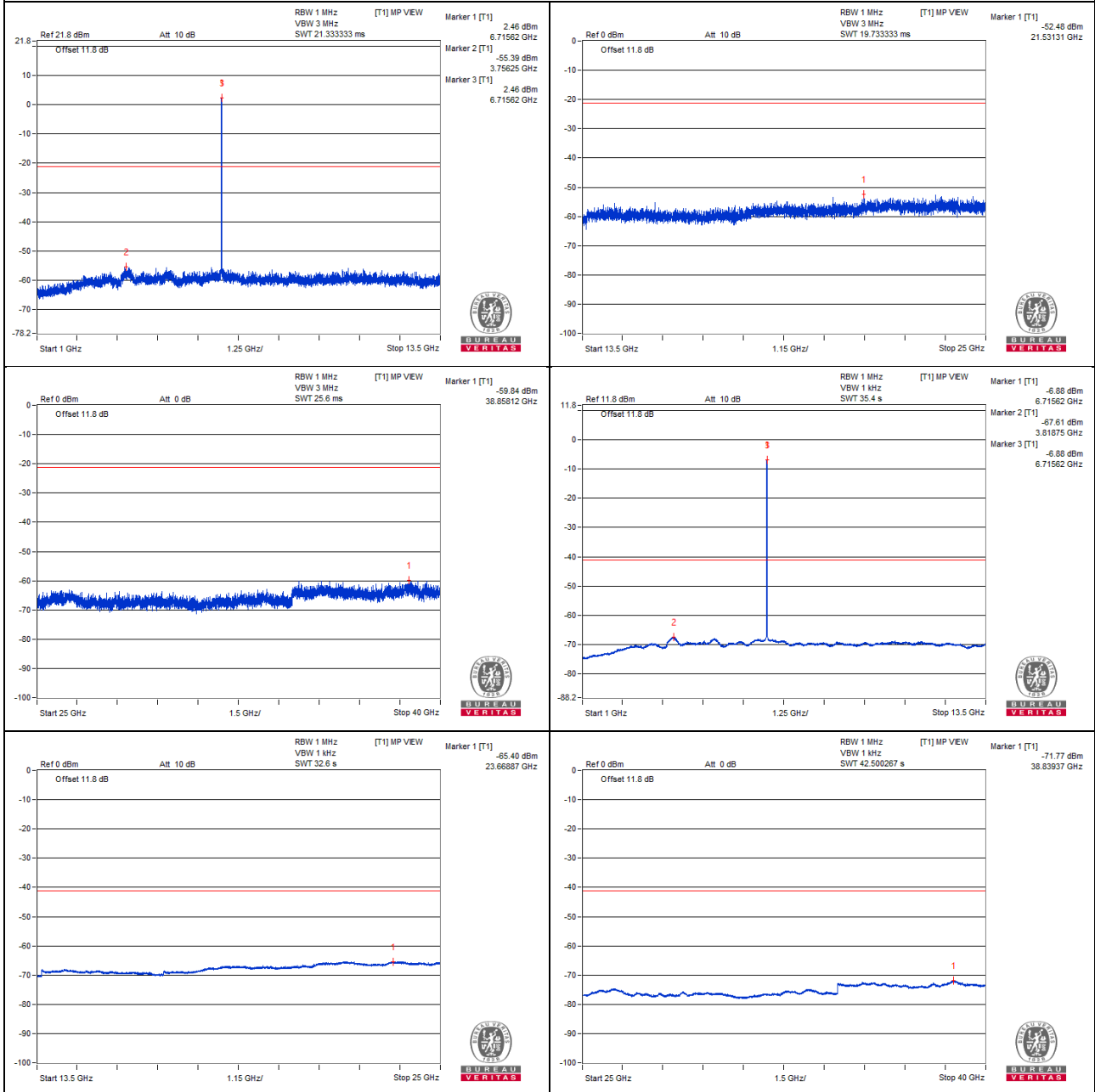

### 802.11a - Channel 181

#### Conducted spurious emission table

No.	Frequency (MHz)	Emission Level (dBuV/m)	Limit (dBuV/m)	Margin (dB)	Raw Value (dBm)	Correction Factor (dB)	EIRP Level (dBm)
1	#13701.25	42.94 PK	88.2	-45.26	-57.08	4.76	-52.32
2	#13718.5	31.38 AV	68.2	-36.82	-68.64	4.76	-63.88
3	20566.75	43.94 PK	74	-30.06	-56.08	4.76	-51.32
4	20556.68	32.87 AV	54	-21.13	-67.15	4.76	-62.39

#### Remarks:

1. Margin value = Emission Level – Limit value
2. The other emission levels were very low against the limit.
3. " # " : The frequency is out of the restricted band.

### Chain 0

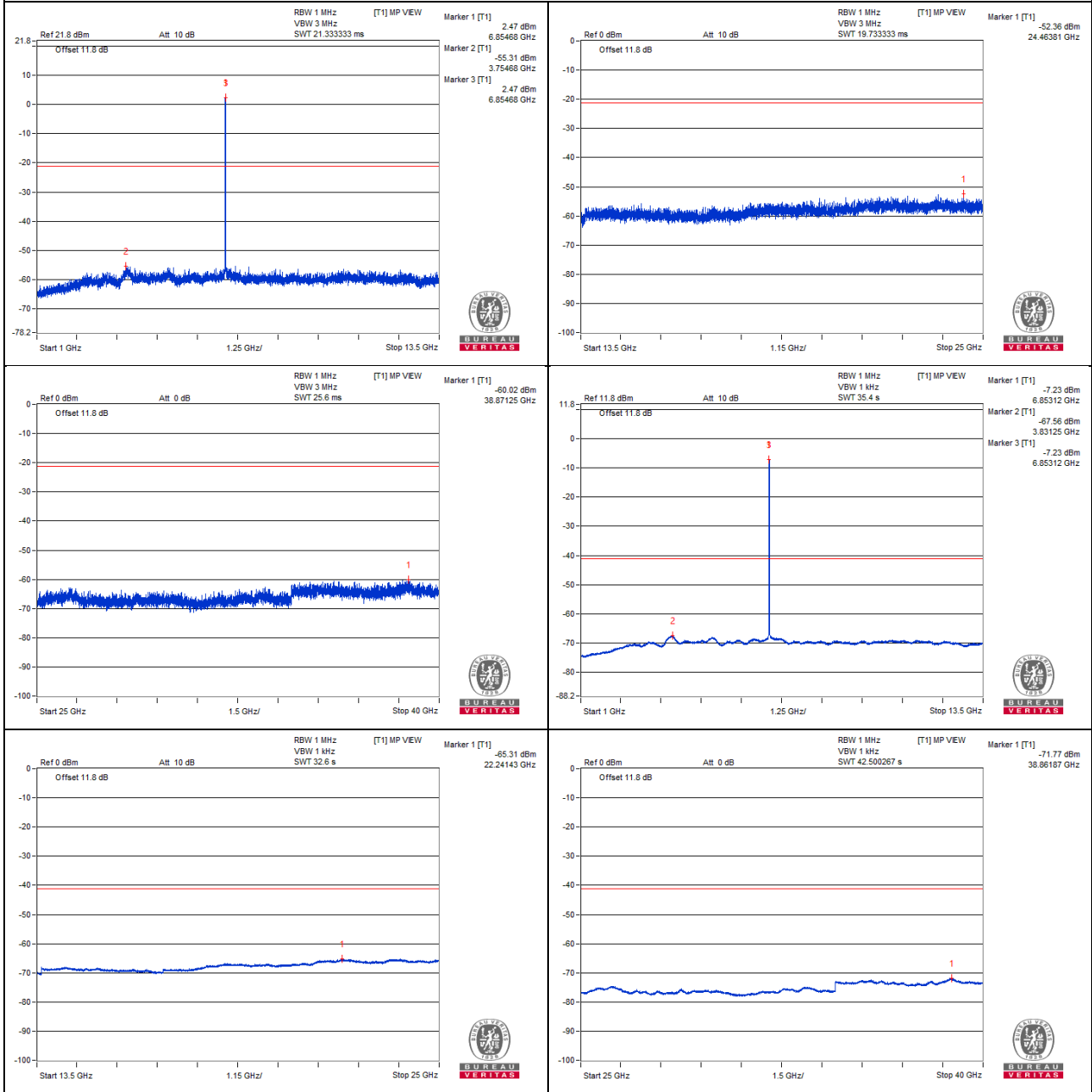

### 802.11a - Channel 185

#### Conducted spurious emission table

No.	Frequency (MHz)	Emission Level (dBuV/m)	Limit (dBuV/m)	Margin (dB)	Raw Value (dBm)	Correction Factor (dB)	EIRP Level (dBm)
1	#13751.56	43.01 PK	88.2	-45.19	-57.01	4.76	-52.25
2	#13753	31.19 AV	68.2	-37.01	-68.83	4.76	-64.07
3	20618.5	44 PK	74	-30	-56.02	4.76	-51.26
4	20615.62	32.61 AV	54	-21.39	-67.41	4.76	-62.65

#### Remarks:

1. Margin value = Emission Level – Limit value
2. The other emission levels were very low against the limit.
3. " # " : The frequency is out of the restricted band.

### Chain 0

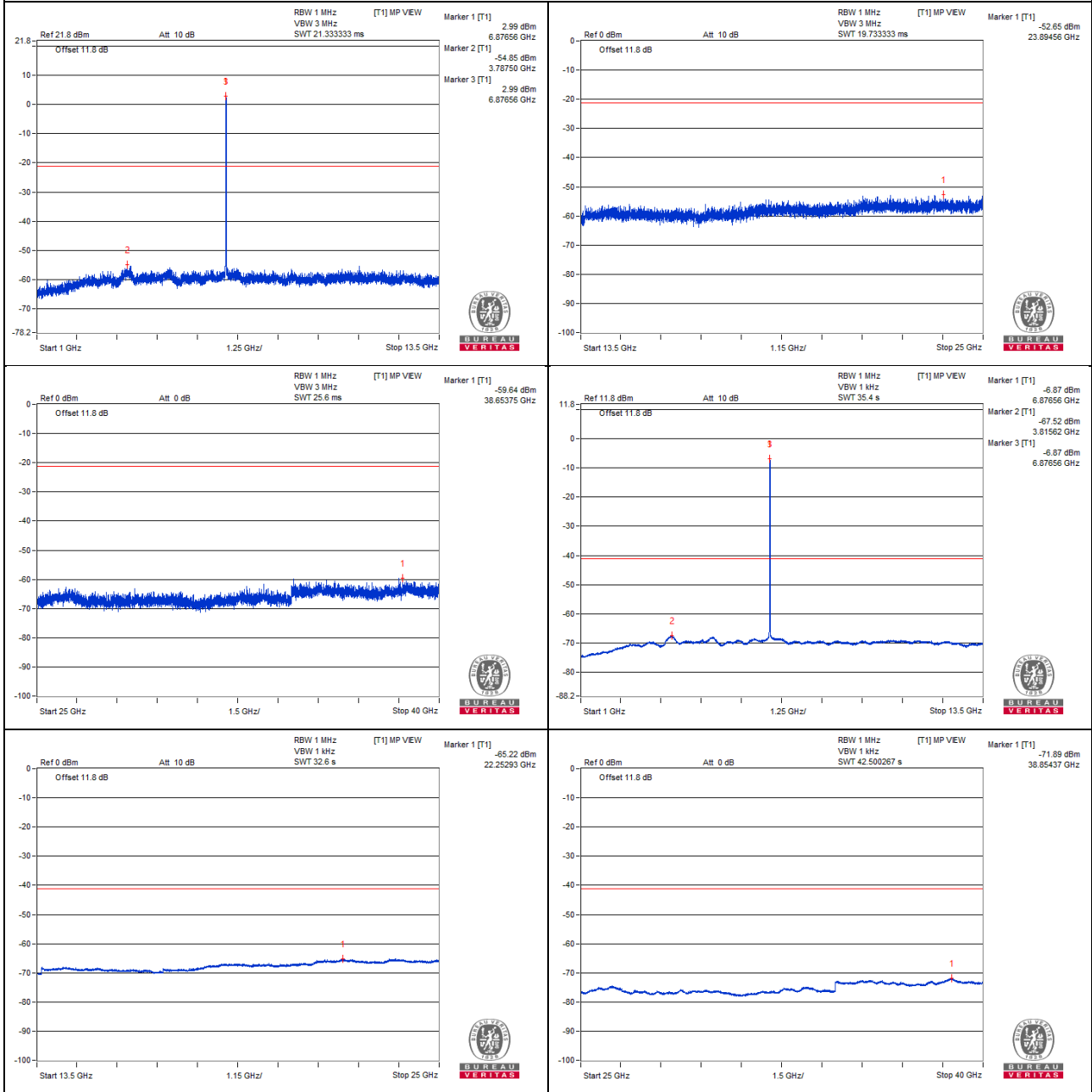

### 802.11a - Channel 213

#### Conducted spurious emission table

No.	Frequency (MHz)	Emission Level (dBuV/m)	Limit (dBuV/m)	Margin (dB)	Raw Value (dBm)	Correction Factor (dB)	EIRP Level (dBm)
1	#14034.75	41.71 PK	88.2	-46.49	-58.31	4.76	-53.55
2	#14033.31	31.44 AV	68.2	-36.76	-68.58	4.76	-63.82
3	21036.81	45.27 PK	74	-28.73	-54.75	4.76	-49.99
4	21041.12	33.12 AV	54	-20.88	-66.9	4.76	-62.14

#### Remarks:

1. Margin value = Emission Level – Limit value
2. The other emission levels were very low against the limit.
3. " # " : The frequency is out of the restricted band.

### Chain 0

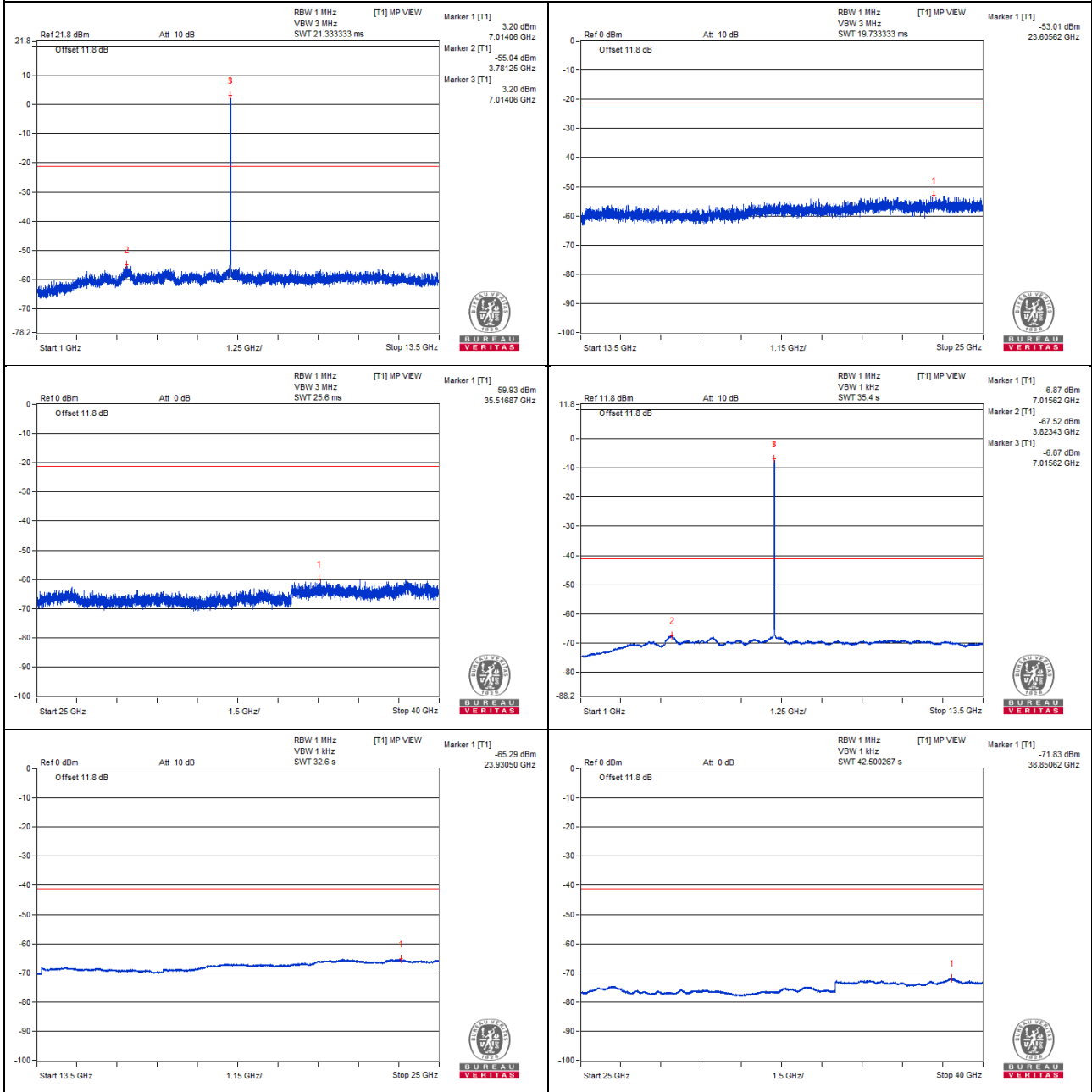

### 802.11a - Channel 233

#### Conducted spurious emission table

No.	Frequency (MHz)	Emission Level (dBuV/m)	Limit (dBuV/m)	Margin (dB)	Raw Value (dBm)	Correction Factor (dB)	EIRP Level (dBm)
1	#14227.37	43.31 PK	88.2	-44.89	-56.71	4.76	-51.95
2	#14234.56	31.72 AV	68.2	-36.48	-68.3	4.76	-63.54
3	21335.81	43.12 PK	74	-30.88	-56.9	4.76	-52.14
4	21354.5	33.03 AV	54	-20.97	-66.99	4.76	-62.23

#### Remarks:

1. Margin value = Emission Level – Limit value
2. The other emission levels were very low against the limit.
3. " # " : The frequency is out of the restricted band.



### Chain 0

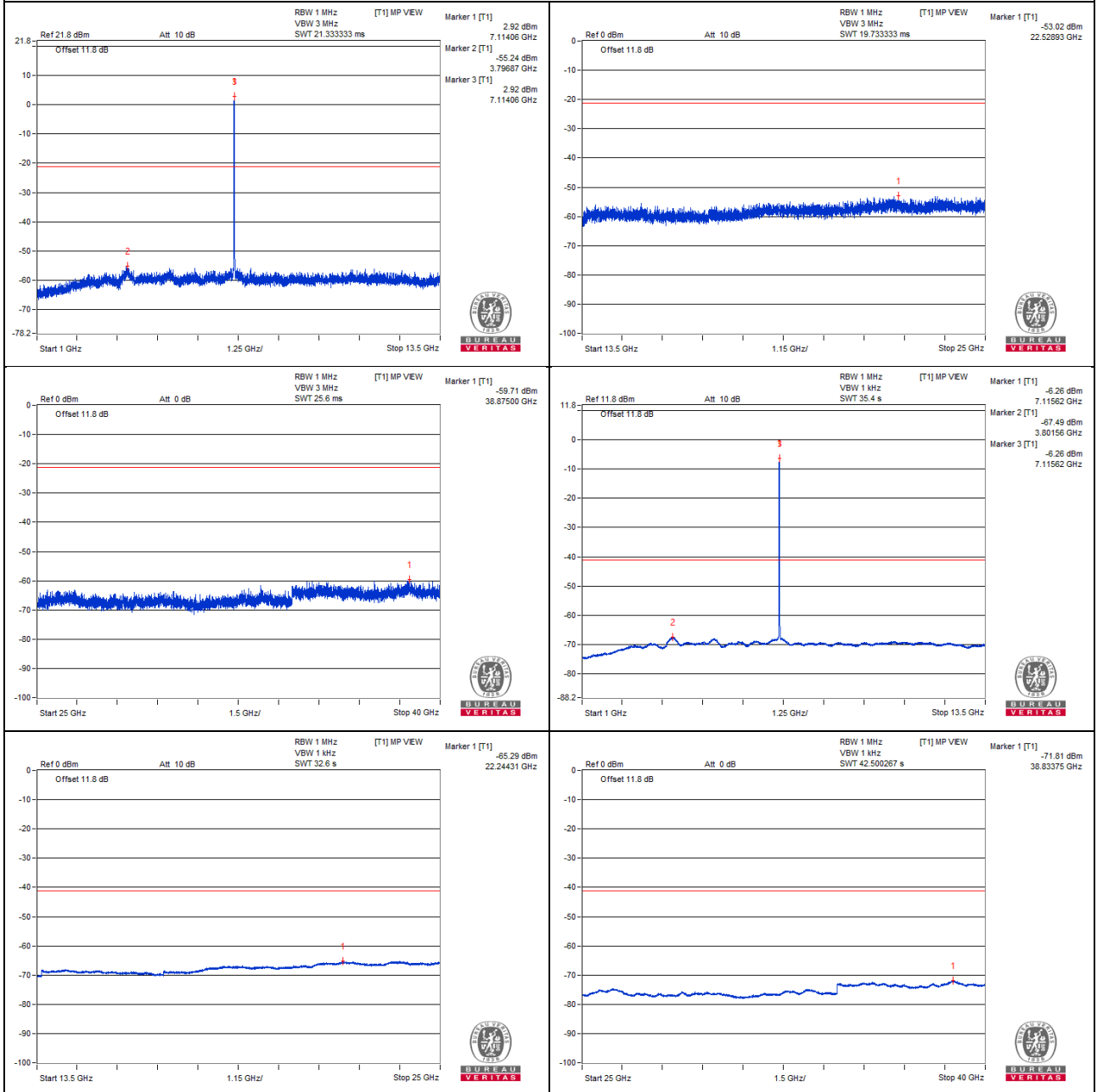

### Bandedge table

No.	Frequency (MHz)	Emission Level (dBuV/m)	Limit (dBuV/m)	Margin (dB)	Raw Value (dBm)	Correction Factor (dB)	EIRP Level (dBm)
1	#7125	63.79 PK	88.2	-24.41	-35.56	4.09	-31.47
2	#7125	46.95 AV	68.2	-21.25	-52.4	4.09	-48.31

### Remarks:

1. Margin value = Emission Level – Limit value
2. The other emission levels were very low against the limit.
3. " # " : The frequency is out of the restricted band.

### Chain 0

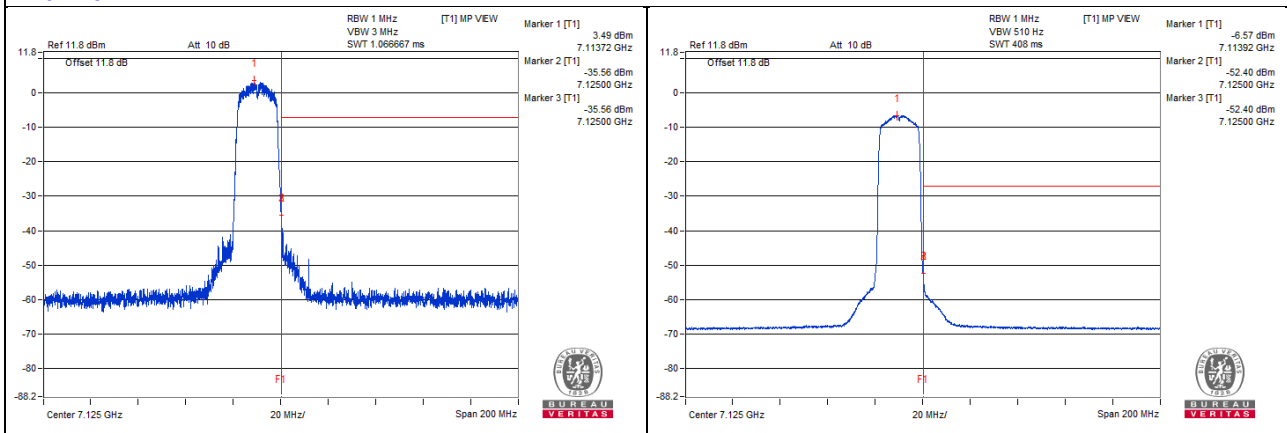

**802.11ax (HE20) - Channel 1****Conducted spurious emission table**

No.	Frequency (MHz)	Emission Level (dBuV/m)	Limit (dBuV/m)	Margin (dB)	Raw Value (dBm)	Correction Factor (dB)	EIRP Level (dBm)
1	11918.75	41.42 PK	74	-32.58	-58.6	4.76	-53.84
2	11909.37	30.21 AV	54	-23.79	-69.81	4.76	-65.05
3	17874.31	42.96 PK	74	-31.04	-57.06	4.76	-52.30
4	17859.93	31.26 AV	54	-22.74	-68.76	4.76	-64.00

## Remarks:

1. Margin value = Emission Level – Limit value
2. The other emission levels were very low against the limit.

### Chain 0

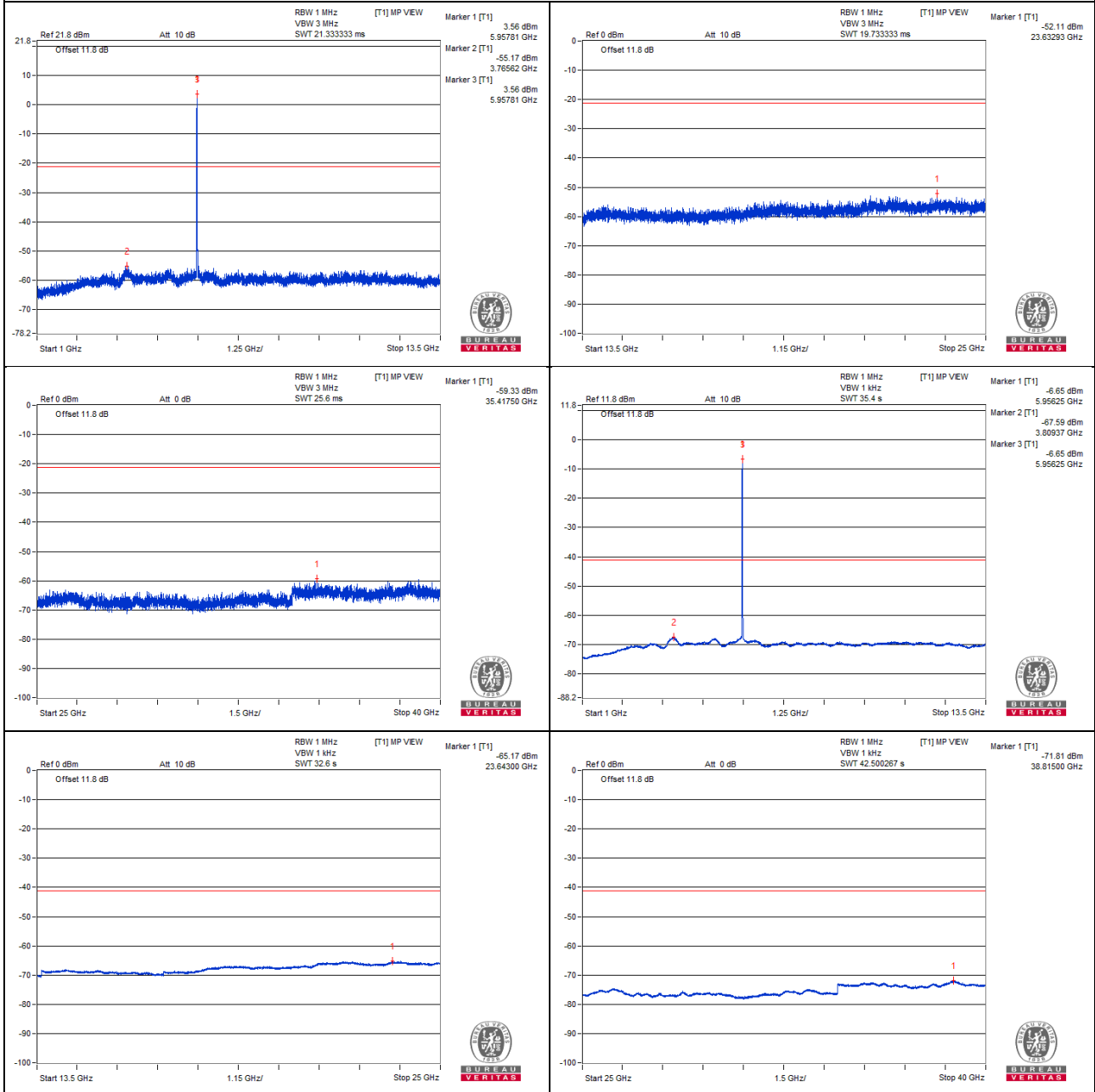

### Bandedge table

No.	Frequency (MHz)	Emission Level (dBuV/m)	Limit (dBuV/m)	Margin (dB)	Raw Value (dBm)	Correction Factor (dB)	EIRP Level (dBm)
1	#5852.8	44.62 PK	88.2	-43.58	-55.4	4.76	-50.64
2	#5924.92	32.42 AV	68.2	-35.78	-67.6	4.76	-62.84

Remarks:

1. Margin value = Emission Level – Limit value
2. The other emission levels were very low against the limit.
3. " # " : The frequency is out of the restricted band.

### Chain 0

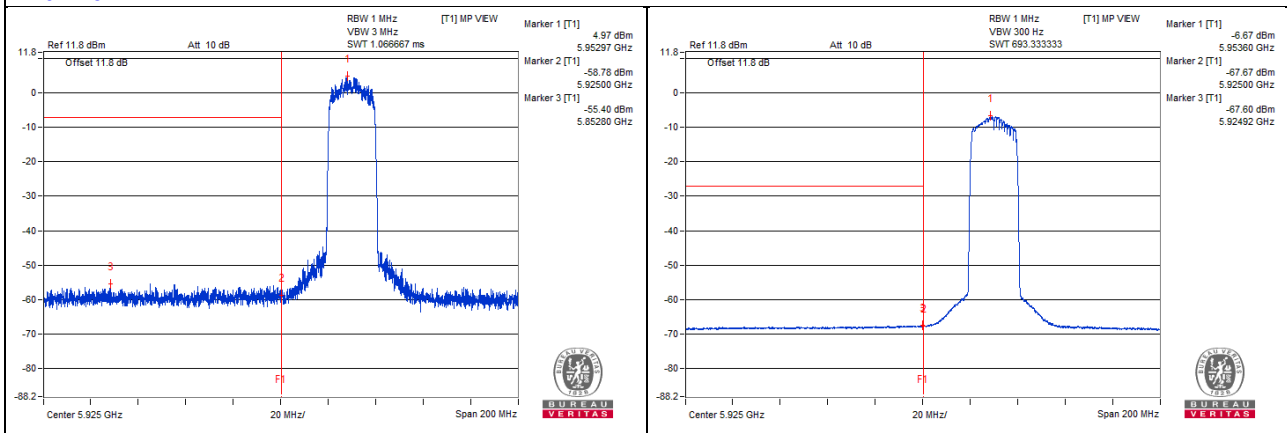

### 802.11ax (HE20) - Channel 233

#### Conducted spurious emission table

No.	Frequency (MHz)	Emission Level (dBuV/m)	Limit (dBuV/m)	Margin (dB)	Raw Value (dBm)	Correction Factor (dB)	EIRP Level (dBm)
1	#14248.93	43.22 PK	88.2	-44.98	-56.8	4.76	-52.04
2	#14228.81	31.77 AV	68.2	-36.43	-68.25	4.76	-63.49
3	21364.56	43.61 PK	74	-30.39	-56.41	4.76	-51.65
4	21363.12	33.05 AV	54	-20.95	-66.97	4.76	-62.21

#### Remarks:

1. Margin value = Emission Level – Limit value
2. The other emission levels were very low against the limit.
3. " # " : The frequency is out of the restricted band.

### Chain 0

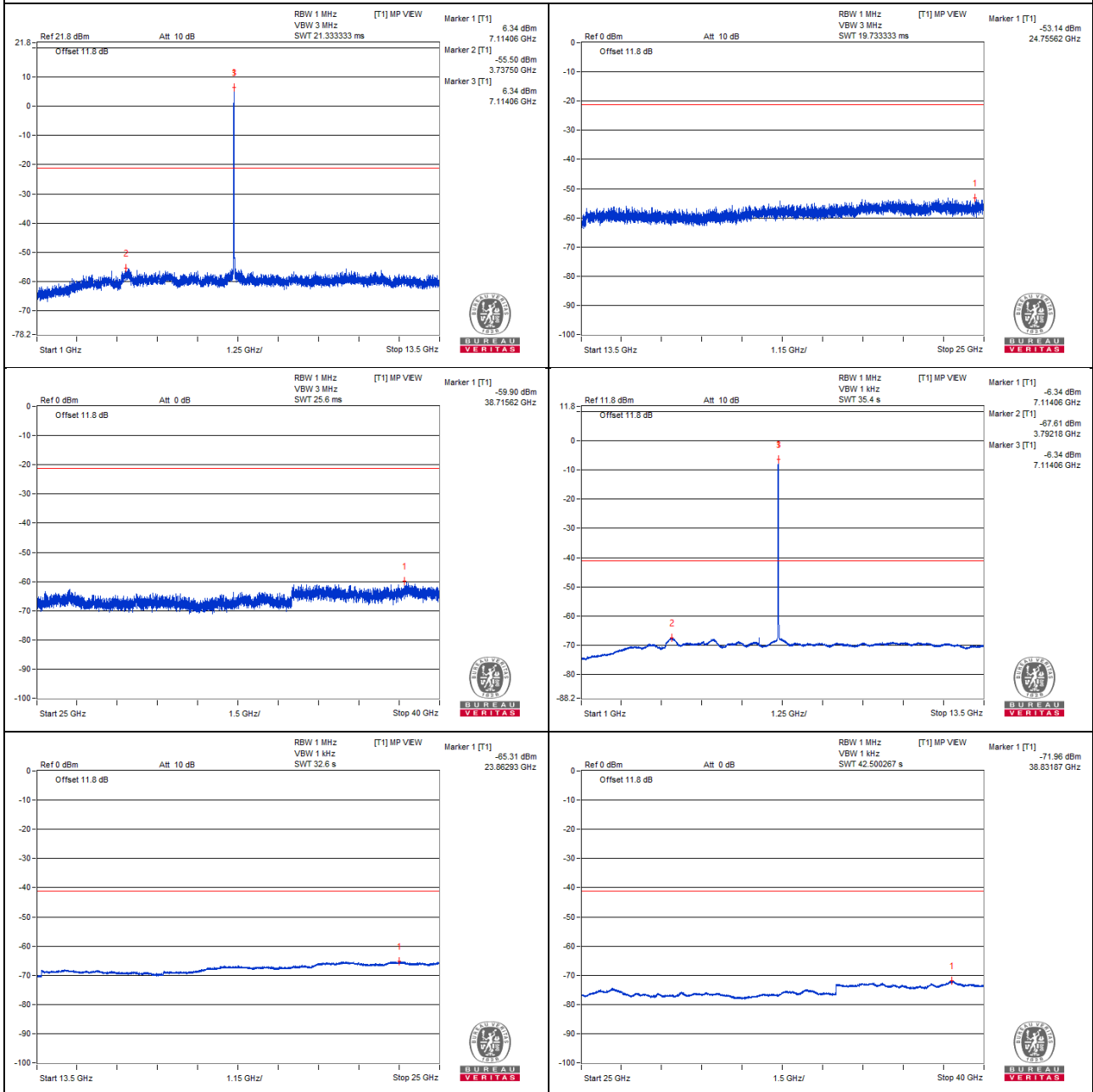

### Bandedge table

No.	Frequency (MHz)	Emission Level (dBuV/m)	Limit (dBuV/m)	Margin (dB)	Raw Value (dBm)	Correction Factor (dB)	EIRP Level (dBm)
1	#7125	56.09 PK	88.2	-32.11	-43.26	4.09	-39.17
2	#7125	49.48 AV	68.2	-18.72	-49.87	4.09	-45.78

#### Remarks:

1. Margin value = Emission Level – Limit value
2. The other emission levels were very low against the limit.
3. " # " : The frequency is out of the restricted band.
4. Follow ANSI C63.10 section 12.7.4.4.3 Integration method.

#### Chain 0

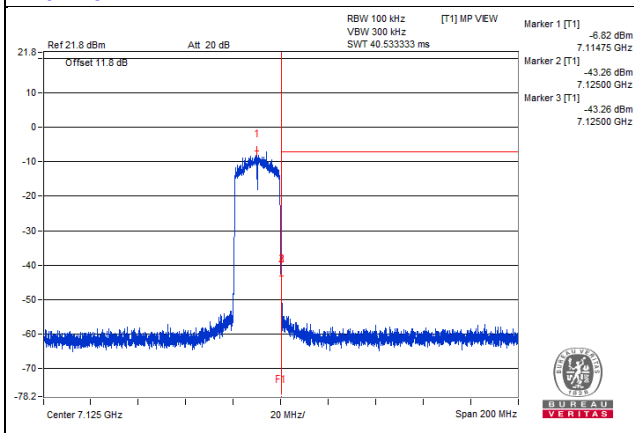

#### Chain 0

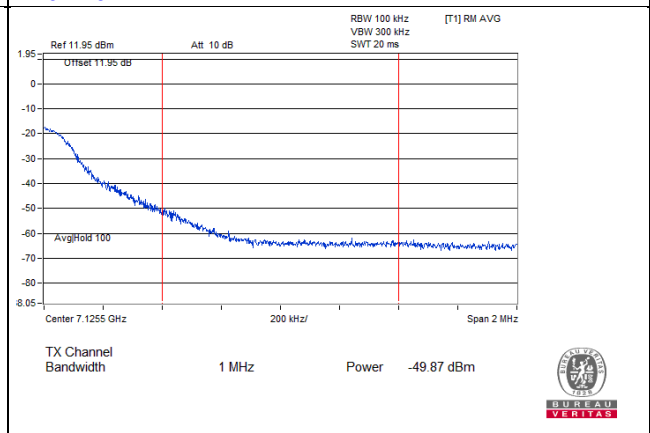



### 802.11ax (HE40) - Channel 3

#### Conducted spurious emission table

No.	Frequency (MHz)	Emission Level (dBuV/m)	Limit (dBuV/m)	Margin (dB)	Raw Value (dBm)	Correction Factor (dB)	EIRP Level (dBm)
1	11935.93	41.22 PK	74	-32.78	-58.8	4.76	-54.04
2	11926.56	30.1 AV	54	-23.9	-69.92	4.76	-65.16
3	17885.81	42.27 PK	74	-31.73	-57.75	4.76	-52.99
4	17901.62	31.02 AV	54	-22.98	-69	4.76	-64.24

#### Remarks:

1. Margin value = Emission Level – Limit value
2. The other emission levels were very low against the limit.

### Chain 0

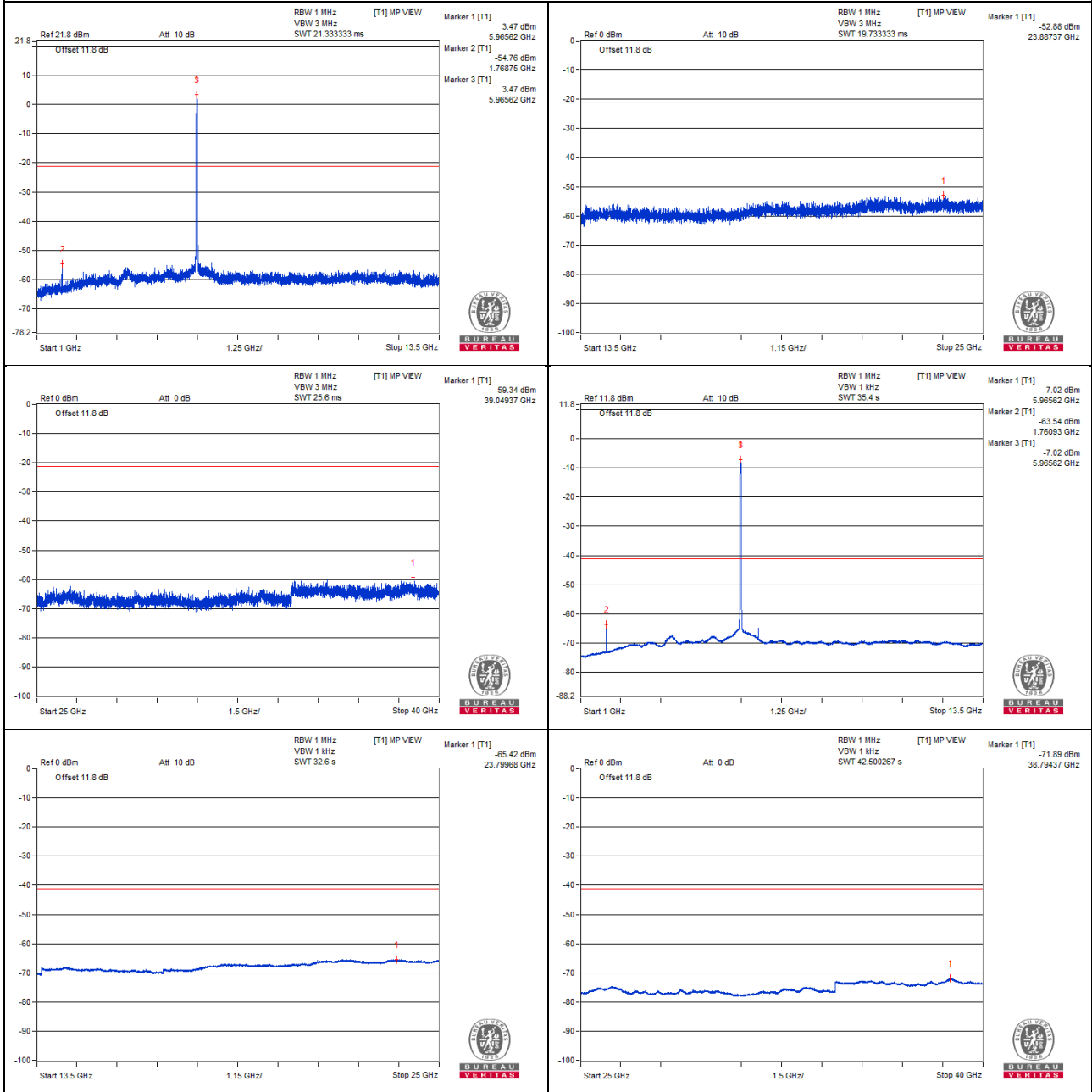

### Bandedge table

No.	Frequency (MHz)	Emission Level (dBuV/m)	Limit (dBuV/m)	Margin (dB)	Raw Value (dBm)	Correction Factor (dB)	EIRP Level (dBm)
1	#5924.67	49.49 PK	88.2	-38.71	-50.53	4.76	-45.77
2	#5924.7	37.72 AV	68.2	-30.48	-62.3	4.76	-57.54

### Remarks:

1. Margin value = Emission Level – Limit value
2. The other emission levels were very low against the limit.
3. " # " : The frequency is out of the restricted band.

### Chain 0

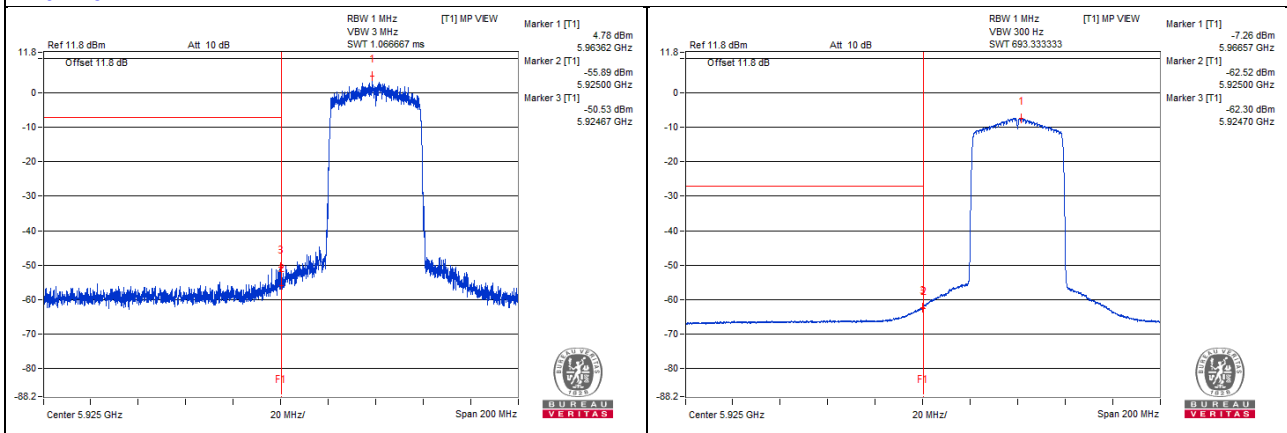

### 802.11ax (HE40) - Channel 227

#### Conducted spurious emission table

No.	Frequency (MHz)	Emission Level (dBuV/m)	Limit (dBuV/m)	Margin (dB)	Raw Value (dBm)	Correction Factor (dB)	EIRP Level (dBm)
1	#14165.56	41.52 PK	88.2	-46.68	-58.5	4.76	-53.74
2	#14174.18	31.56 AV	68.2	-36.64	-68.46	4.76	-63.70
3	21252.43	43.84 PK	74	-30.16	-56.18	4.76	-51.42
4	21256.75	33.02 AV	54	-20.98	-67	4.76	-62.24

#### Remarks:

1. Margin value = Emission Level – Limit value
2. The other emission levels were very low against the limit.
3. " # " : The frequency is out of the restricted band.

### Chain 0

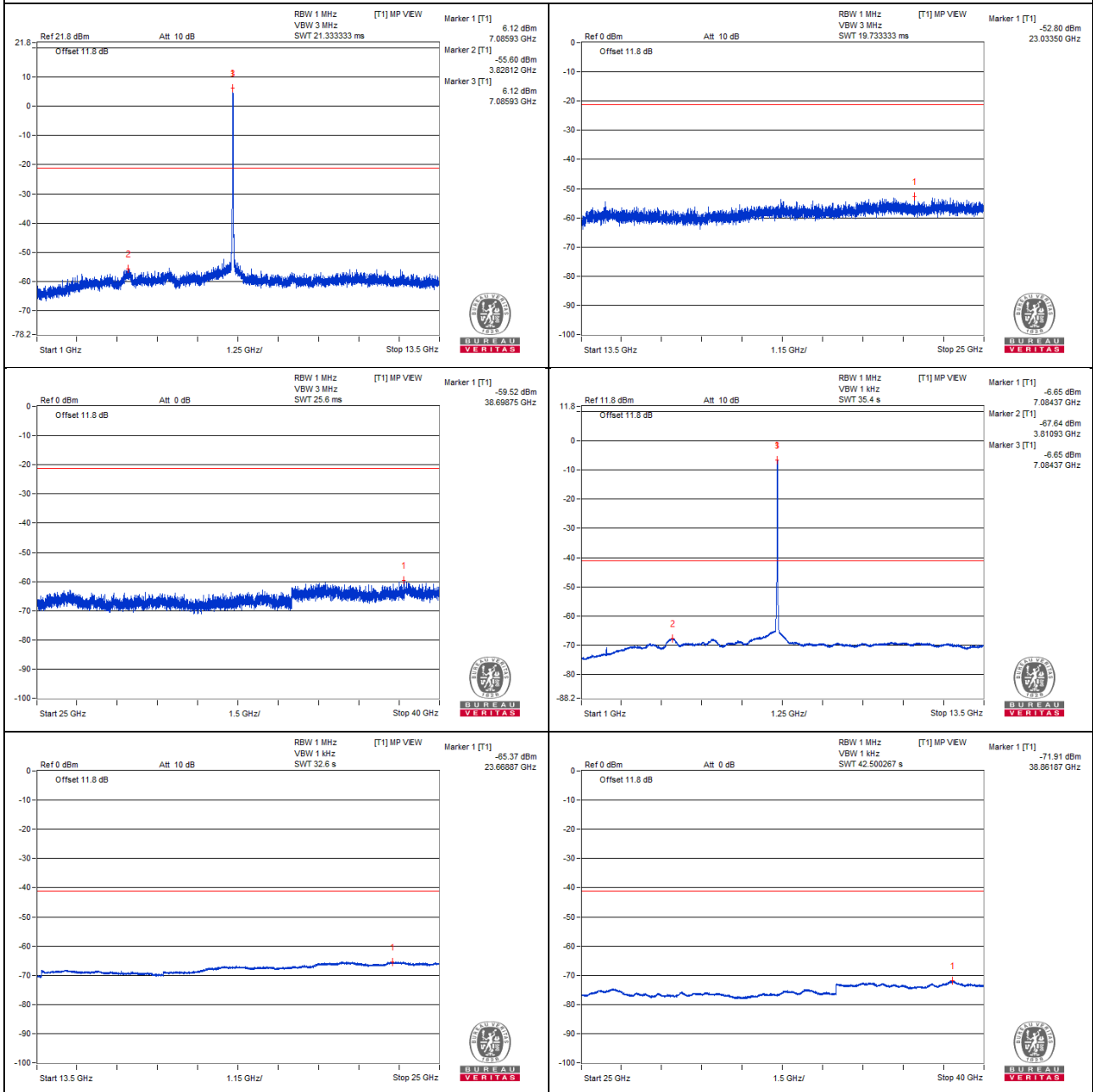

### Bandedge table

No.	Frequency (MHz)	Emission Level (dBuV/m)	Limit (dBuV/m)	Margin (dB)	Raw Value (dBm)	Correction Factor (dB)	EIRP Level (dBm)
1	#7126.07	47.7 PK	88.2	-40.5	-51.65	4.09	-47.56
2	#7125	36.66 AV	68.2	-31.54	-62.69	4.09	-58.60

#### Remarks:

1. Margin value = Emission Level – Limit value
2. The other emission levels were very low against the limit.
3. " # " : The frequency is out of the restricted band.

### Chain 0

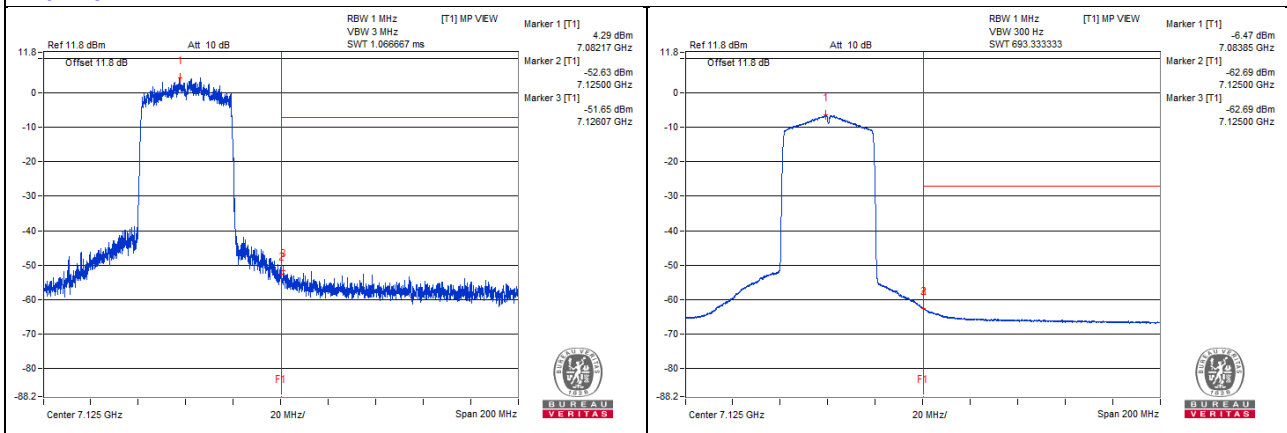

### 802.11ax (HE80) - Channel 7

#### Conducted spurious emission table

No.	Frequency (MHz)	Emission Level (dBuV/m)	Limit (dBuV/m)	Margin (dB)	Raw Value (dBm)	Correction Factor (dB)	EIRP Level (dBm)
1	11971.87	41.3 PK	74	-32.7	-58.72	4.76	-53.96
2	11968.75	30.32 AV	54	-23.68	-69.7	4.76	-64.94
3	17947.62	42.02 PK	74	-31.98	-58	4.76	-53.24
4	17962	31.29 AV	54	-22.71	-68.73	4.76	-63.97

#### Remarks:

1. Margin value = Emission Level – Limit value
2. The other emission levels were very low against the limit.
3. " # " : The frequency is out of the restricted band.

### Chain 0

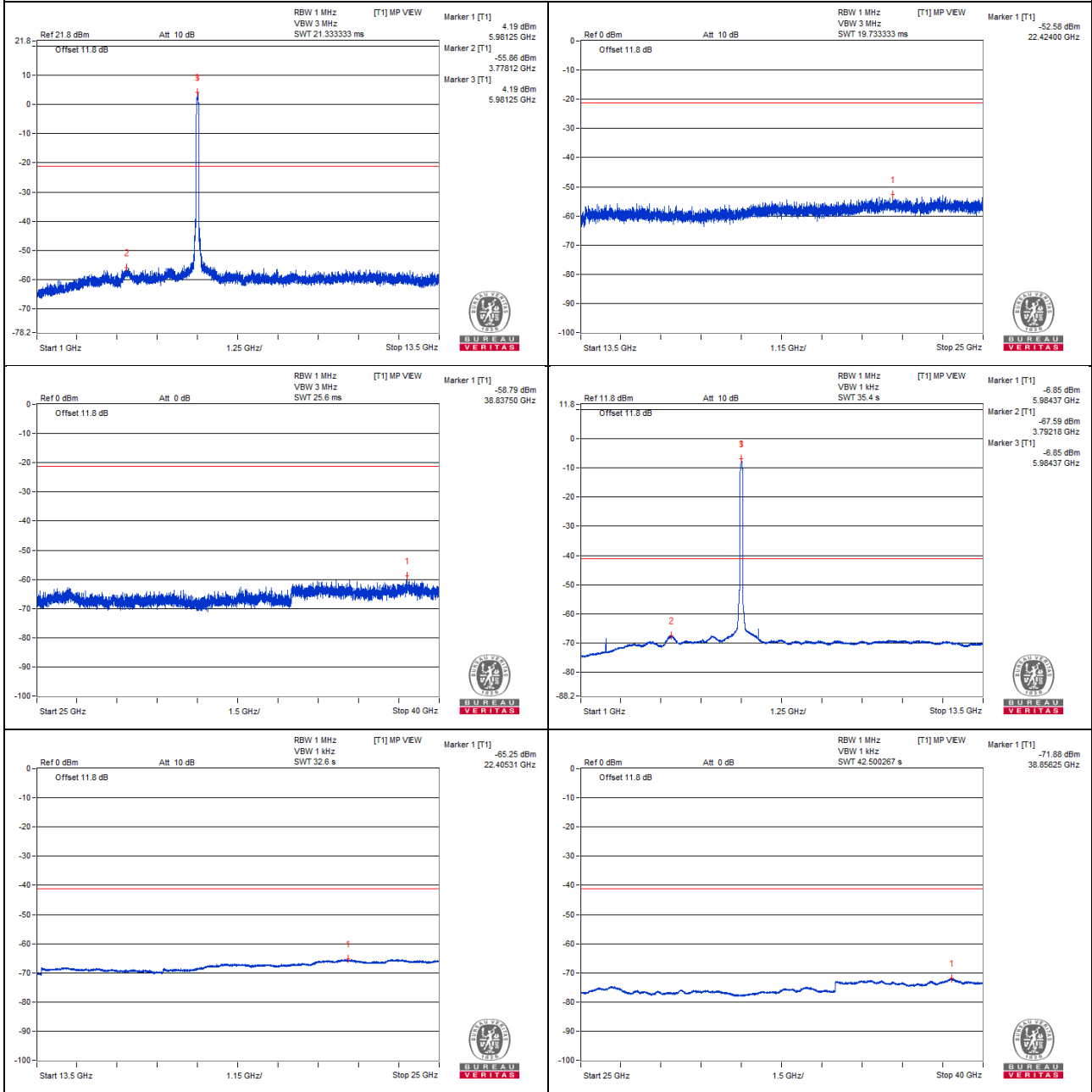



### Bandedge table

No.	Frequency (MHz)	Emission Level (dBuV/m)	Limit (dBuV/m)	Margin (dB)	Raw Value (dBm)	Correction Factor (dB)	EIRP Level (dBm)
1	#5923.87	62.68 PK	88.2	-25.52	-37.34	4.76	-32.58
2	#5923.12	49.35 AV	68.2	-18.85	-50.67	4.76	-45.91

### Remarks:

1. Margin value = Emission Level – Limit value
2. The other emission levels were very low against the limit.
3. " # " : The frequency is out of the restricted band.

### Chain 0

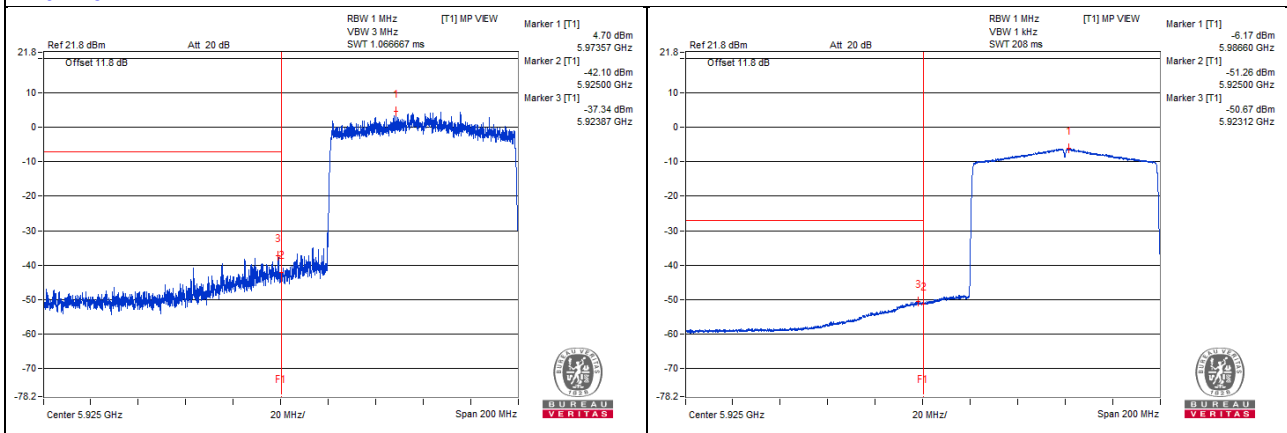

### 802.11ax (HE80) - Channel 215

#### Conducted spurious emission table

No.	Frequency (MHz)	Emission Level (dBuV/m)	Limit (dBuV/m)	Margin (dB)	Raw Value (dBm)	Correction Factor (dB)	EIRP Level (dBm)
1	#14056.31	42.83 PK	88.2	-45.37	-57.19	4.76	-52.43
2	#14057.75	31.57 AV	68.2	-36.63	-68.45	4.76	-63.69
3	21078.5	43.59 PK	74	-30.41	-56.43	4.76	-51.67
4	21078.5	33.09 AV	54	-20.91	-66.93	4.76	-62.17

#### Remarks:

1. Margin value = Emission Level – Limit value
2. The other emission levels were very low against the limit.

### Chain 0

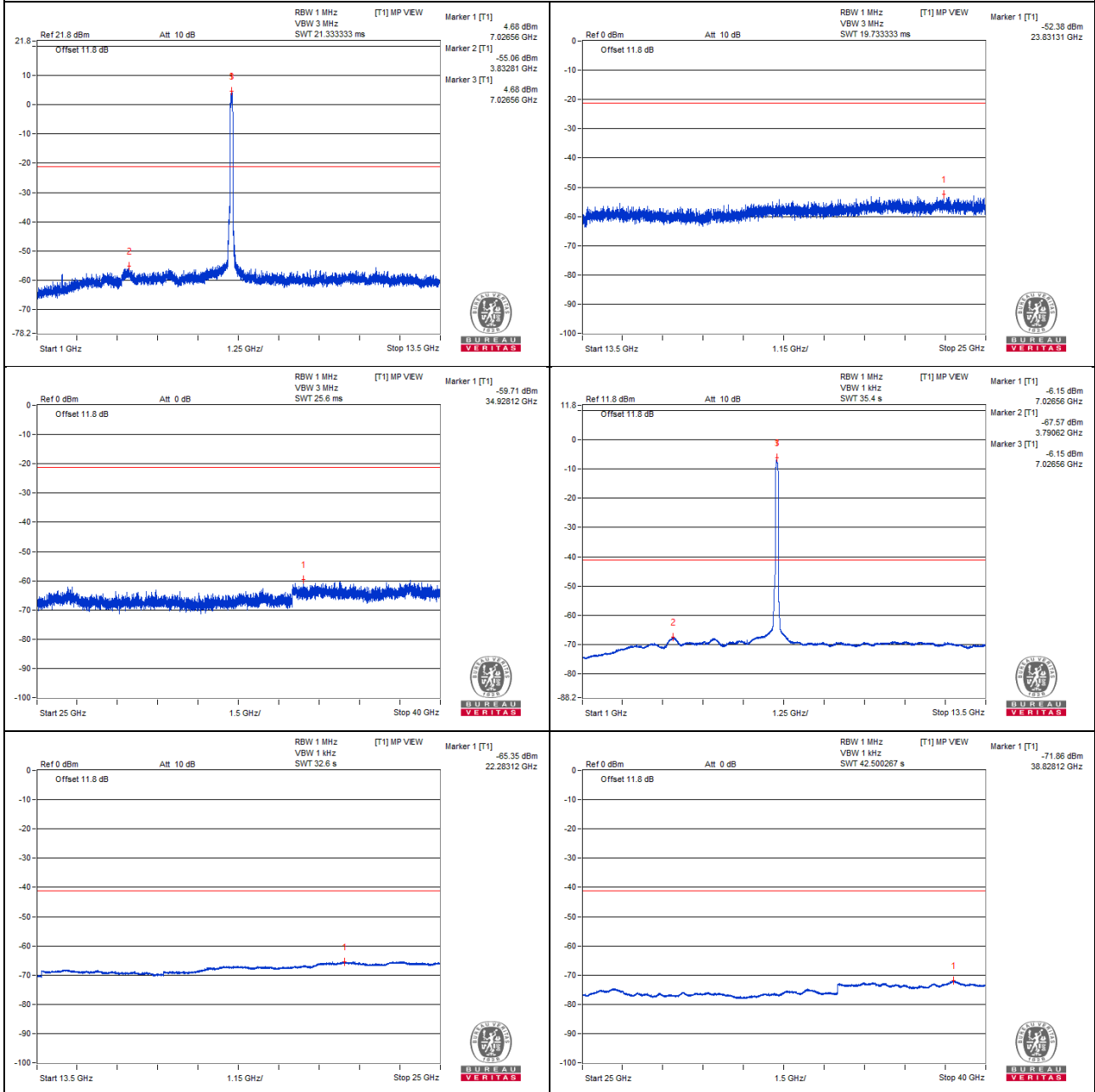

### Bandedge table

No.	Frequency (MHz)	Emission Level (dBuV/m)	Limit (dBuV/m)	Margin (dB)	Raw Value (dBm)	Correction Factor (dB)	EIRP Level (dBm)
1	#7157.4	52.01 PK	88.2	-36.19	-47.34	4.09	-43.25
2	#7126.4	40.83 AV	68.2	-27.37	-58.52	4.09	-54.43

#### Remarks:

1. Margin value = Emission Level – Limit value
2. The other emission levels were very low against the limit.
3. " # " : The frequency is out of the restricted band.

### Chain 0

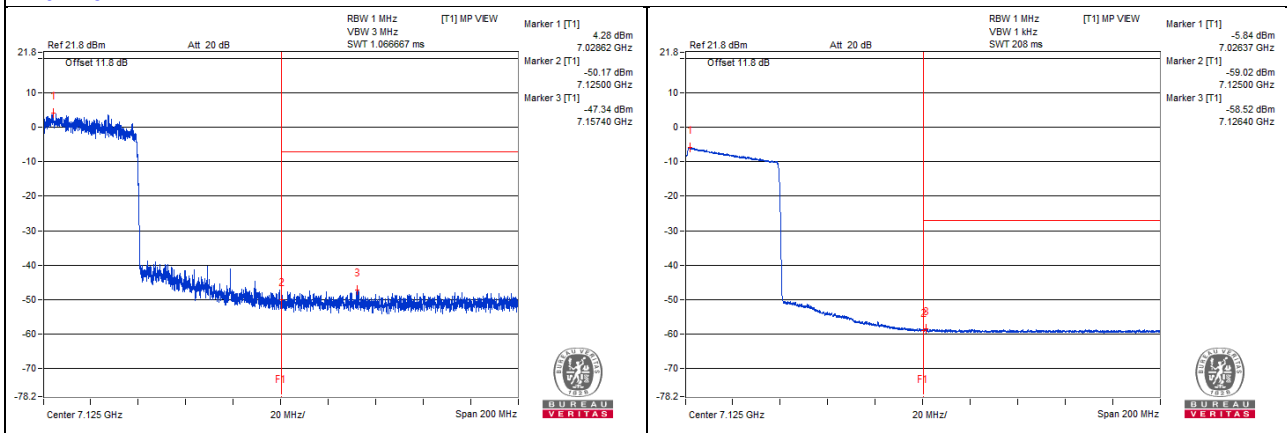

### 802.11ax (HE160) - Channel 15

#### Conducted spurious emission table

No.	Frequency (MHz)	Emission Level (dBuV/m)	Limit (dBuV/m)	Margin (dB)	Raw Value (dBm)	Correction Factor (dB)	EIRP Level (dBm)
1	12040.62	42.05 PK	74	-31.95	-57.97	4.76	-53.21
2	12053.12	29.94 AV	54	-24.06	-70.08	4.76	-65.32
3	18065.5	42.87 PK	74	-31.13	-57.15	4.76	-52.39
4	18084.18	31.62 AV	54	-22.38	-68.4	4.76	-63.64

#### Remarks:

1. Margin value = Emission Level – Limit value
2. The other emission levels were very low against the limit.

### Chain 0

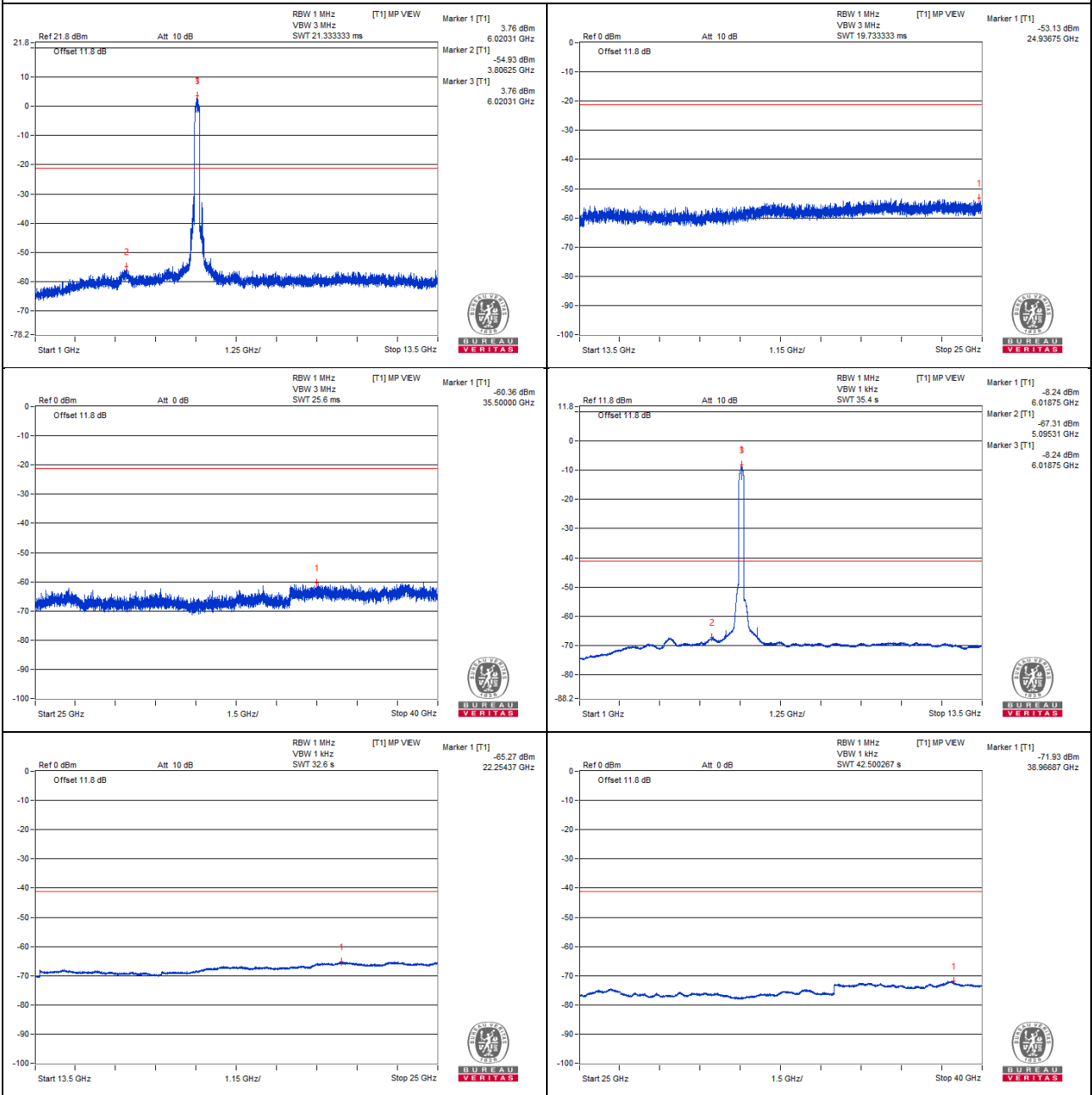

### Bandedge table

No.	Frequency (MHz)	Emission Level (dBuV/m)	Limit (dBuV/m)	Margin (dB)	Raw Value (dBm)	Correction Factor (dB)	EIRP Level (dBm)
1	#5922.05	68.69 PK	88.2	-19.51	-31.33	4.76	-26.57
2	#5923.9	51.69 AV	68.2	-16.51	-48.33	4.76	-43.57

#### Remarks:

1. Margin value = Emission Level – Limit value
2. The other emission levels were very low against the limit.
3. " # " : The frequency is out of the restricted band.

### Chain 0

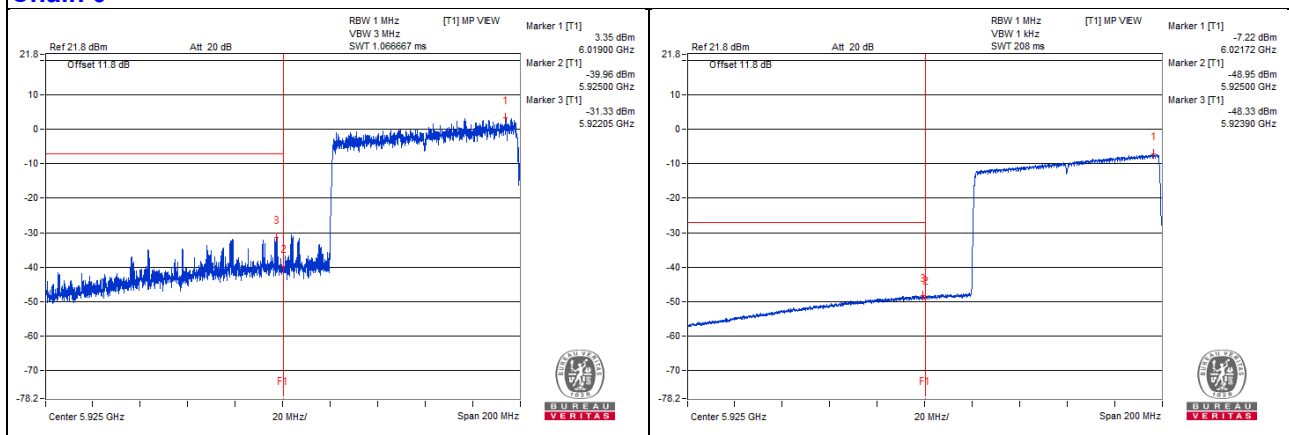

**802.11ax (HE160) - Channel 47****Conducted spurious emission table**

No.	Frequency (MHz)	Emission Level (dBuV/m)	Limit (dBuV/m)	Margin (dB)	Raw Value (dBm)	Correction Factor (dB)	EIRP Level (dBm)
1	12365.62	42.07 PK	74	-31.93	-57.95	4.76	-53.19
2	12365.62	30.46 AV	54	-23.54	-69.56	4.76	-64.80
3	18560	44.6 PK	74	-29.4	-55.42	4.76	-50.66
4	18562.87	32.32 AV	54	-21.68	-67.7	4.76	-62.94

## Remarks:

1. Margin value = Emission Level – Limit value
2. The other emission levels were very low against the limit.



### Chain 0

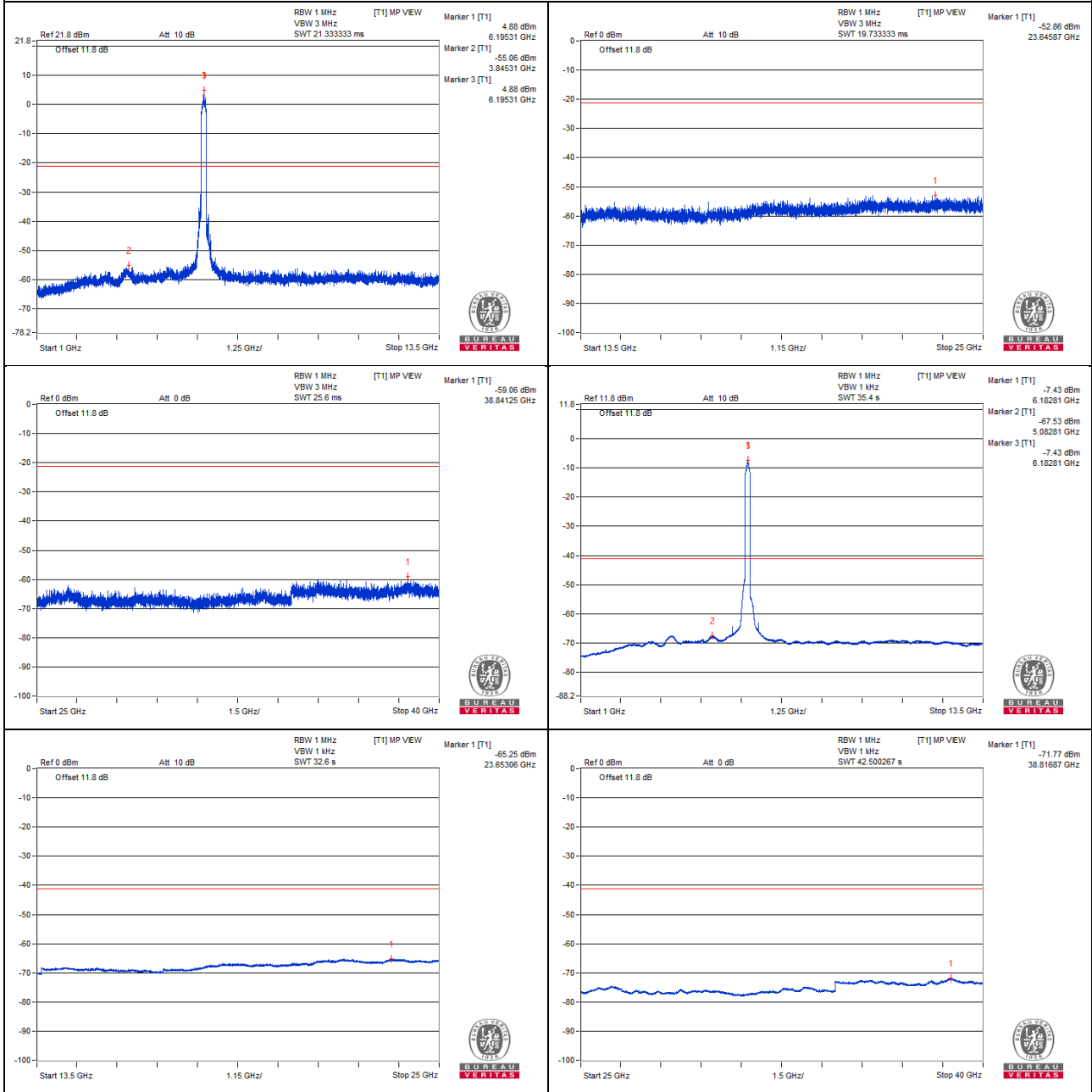

**802.11ax (HE160) - Channel 79****Conducted spurious emission table**

No.	Frequency (MHz)	Emission Level (dBuV/m)	Limit (dBuV/m)	Margin (dB)	Raw Value (dBm)	Correction Factor (dB)	EIRP Level (dBm)
1	12698.43	41.8 PK	74	-32.2	-58.22	4.76	-53.46
2	12700	30.23 AV	54	-23.77	-69.79	4.76	-65.03
3	19025.75	43.76 PK	74	-30.24	-56.26	4.76	-51.50
4	19037.25	32.82 AV	54	-21.18	-67.2	4.76	-62.44

## Remarks:

1. Margin value = Emission Level – Limit value
2. The other emission levels were very low against the limit.

### Chain 0

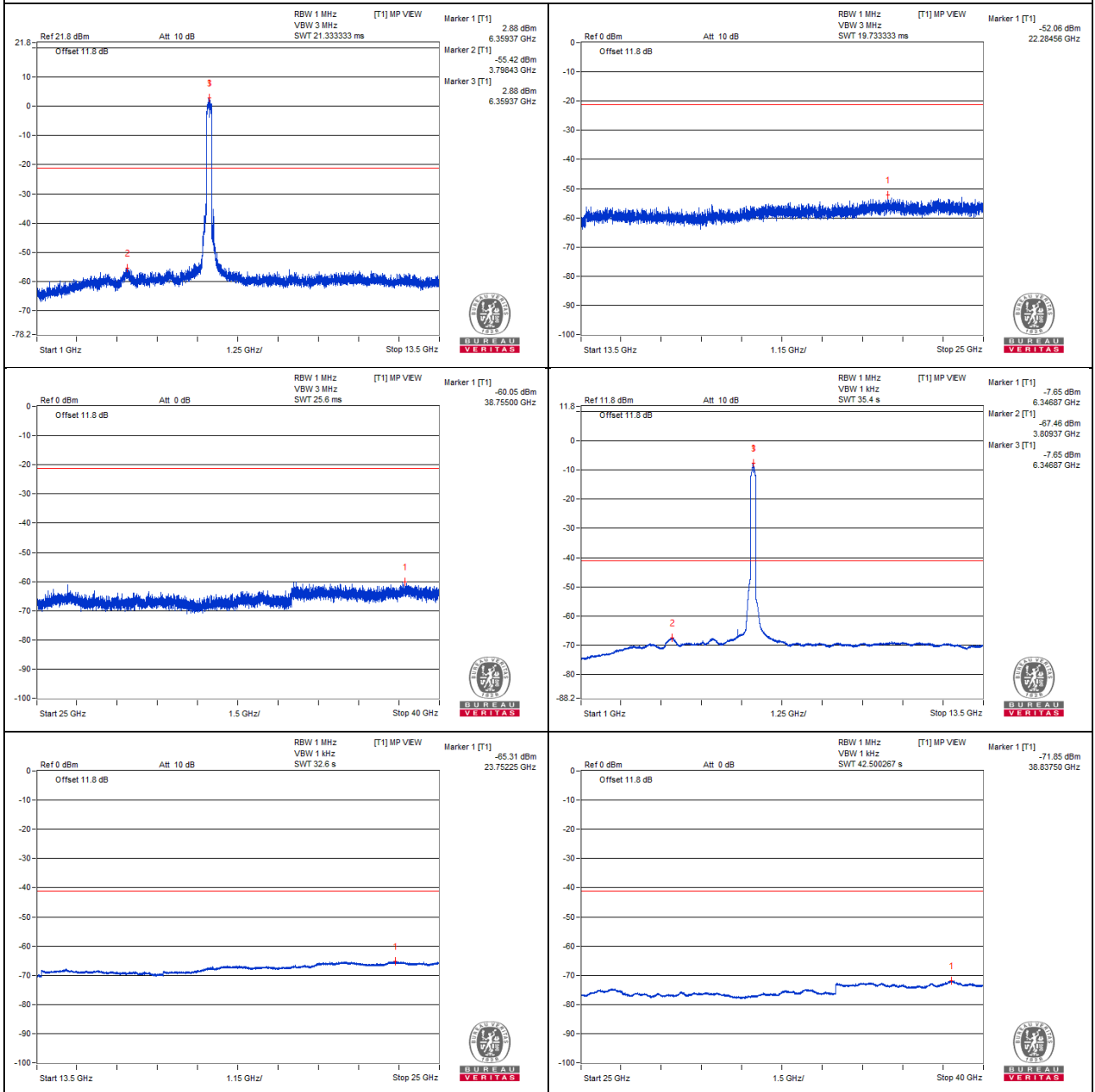

### 802.11ax (HE160) - Channel 111

#### Conducted spurious emission table

No.	Frequency (MHz)	Emission Level (dBuV/m)	Limit (dBuV/m)	Margin (dB)	Raw Value (dBm)	Correction Factor (dB)	EIRP Level (dBm)
1	#13018.75	40.09 PK	88.2	-48.11	-59.93	4.76	-55.17
2	#13017.18	29.18 AV	68.2	-39.02	-70.84	4.76	-66.08
3	19515.93	43.07 PK	74	-30.93	-56.95	4.76	-52.19
4	19514.5	32.81 AV	54	-21.19	-67.21	4.76	-62.45

#### Remarks:

1. Margin value = Emission Level – Limit value
2. The other emission levels were very low against the limit.
3. " # " : The frequency is out of the restricted band.

### Chain 0

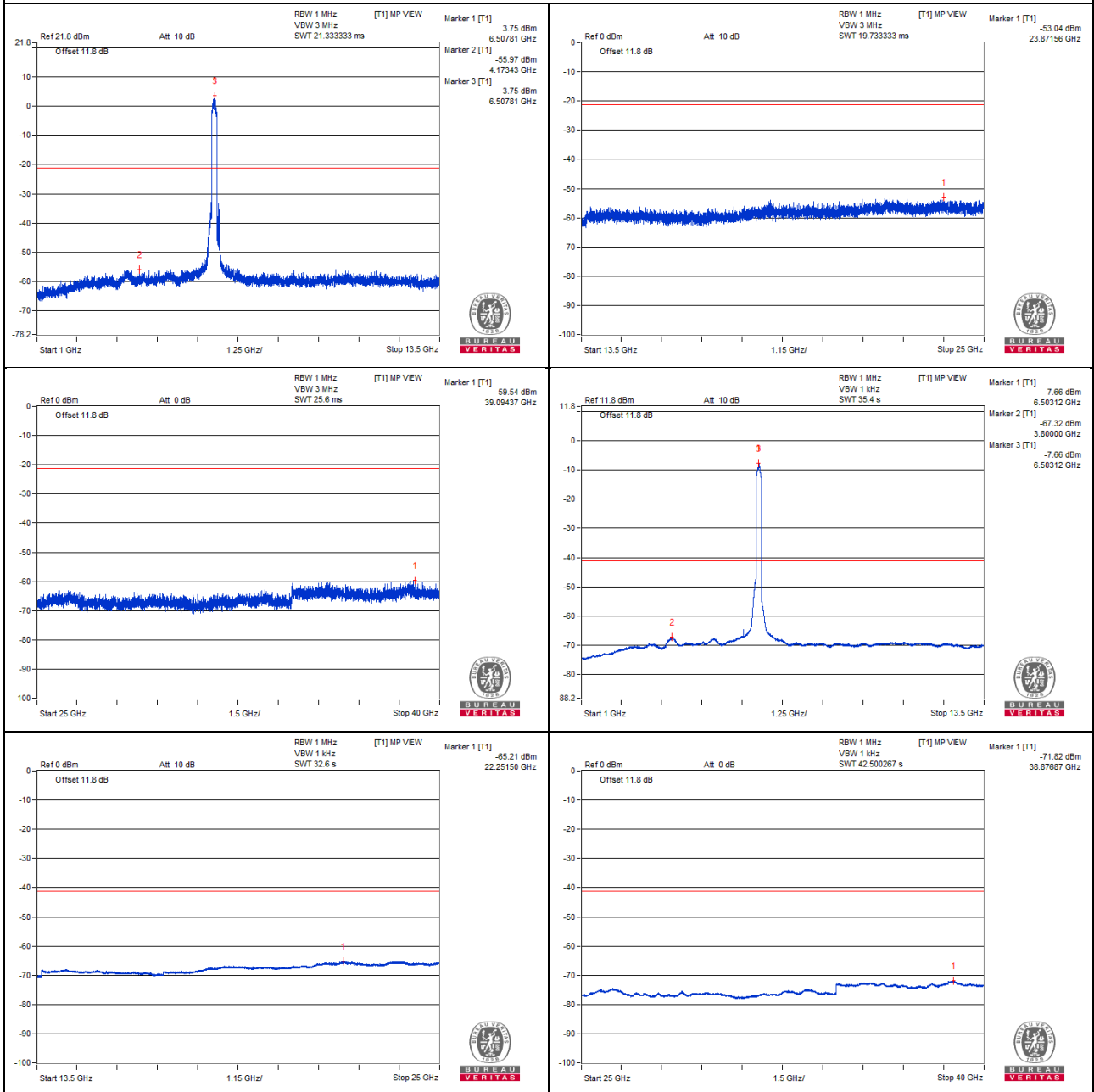

### 802.11ax (HE160) - Channel 143

#### Conducted spurious emission table

No.	Frequency (MHz)	Emission Level (dBuV/m)	Limit (dBuV/m)	Margin (dB)	Raw Value (dBm)	Correction Factor (dB)	EIRP Level (dBm)
1	13328.12	40.23 PK	74	-33.77	-59.79	4.76	-55.03
2	13321.87	29.67 AV	54	-24.33	-70.35	4.76	-65.59
3	19991.75	43.86 PK	74	-30.14	-56.16	4.76	-51.40
4	19997.5	32.74 AV	54	-21.26	-67.28	4.76	-62.52

#### Remarks:

1. Margin value = Emission Level – Limit value
2. The other emission levels were very low against the limit.

### Chain 0

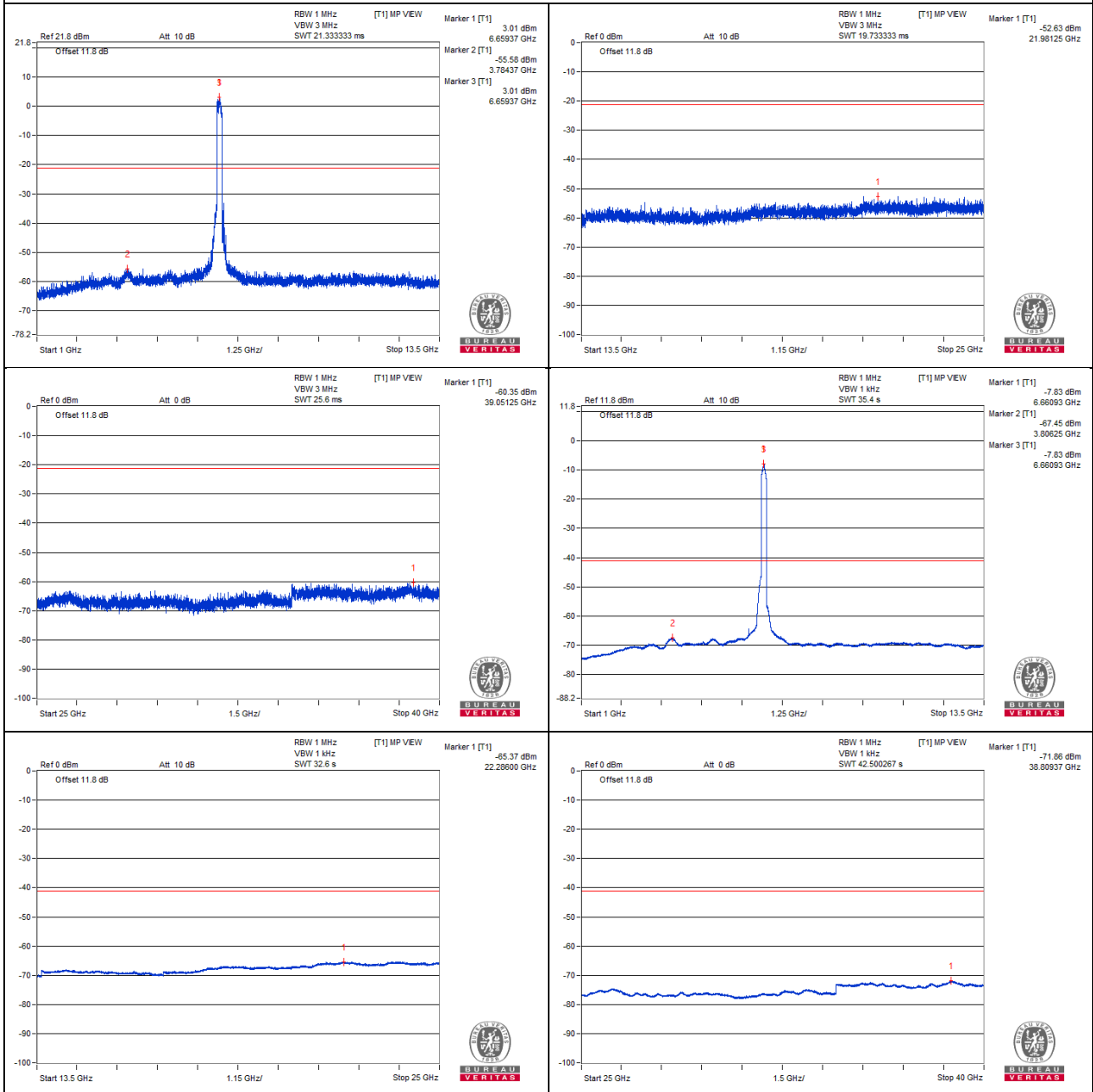

### 802.11ax (HE160) - Channel 175

#### Conducted spurious emission table

No.	Frequency (MHz)	Emission Level (dBuV/m)	Limit (dBuV/m)	Margin (dB)	Raw Value (dBm)	Correction Factor (dB)	EIRP Level (dBm)
1	#13653.81	42.39 PK	88.2	-45.81	-57.63	4.76	-52.87
2	#13648.06	31.68 AV	68.2	-36.52	-68.34	4.76	-63.58
3	20483.37	44.5 PK	74	-29.5	-55.52	4.76	-50.76
4	20476.18	32.76 AV	54	-21.24	-67.26	4.76	-62.50

#### Remarks:

1. Margin value = Emission Level – Limit value
2. The other emission levels were very low against the limit.
3. " # " : The frequency is out of the restricted band.



### Chain 0

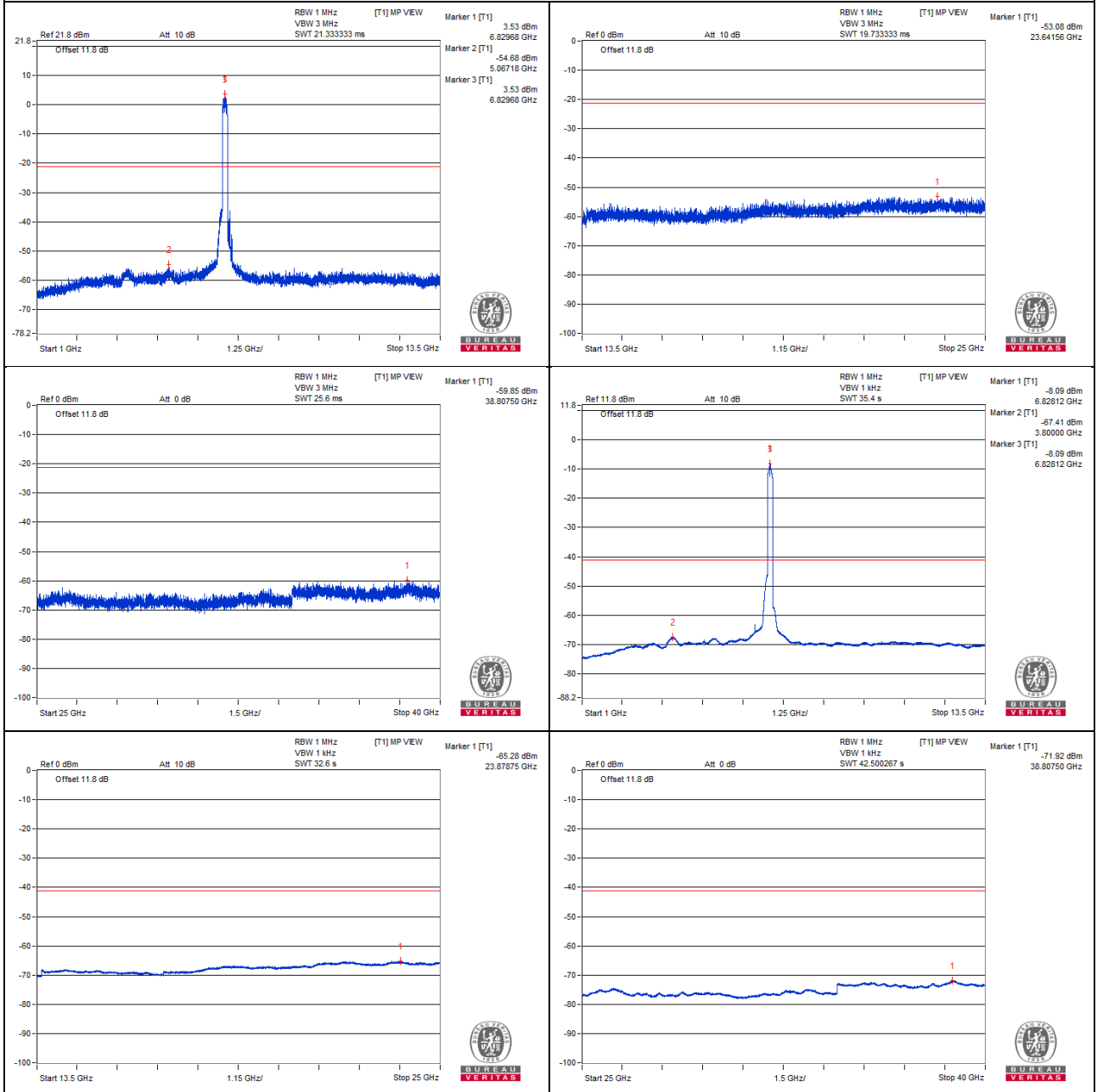

### 802.11ax (HE160) - Channel 207

#### Conducted spurious emission table

No.	Frequency (MHz)	Emission Level (dBuV/m)	Limit (dBuV/m)	Margin (dB)	Raw Value (dBm)	Correction Factor (dB)	EIRP Level (dBm)
1	#13972.93	42.51 PK	88.2	-45.69	-57.51	4.76	-52.75
2	#13961.43	31.48 AV	68.2	-36.72	-68.54	4.76	-63.78
3	20954.87	43 PK	74	-31	-57.02	4.76	-52.26
4	20947.68	32.97 AV	54	-21.03	-67.05	4.76	-62.29

#### Remarks:

1. Margin value = Emission Level – Limit value
2. The other emission levels were very low against the limit.
3. " # " : The frequency is out of the restricted band.

### Chain 0

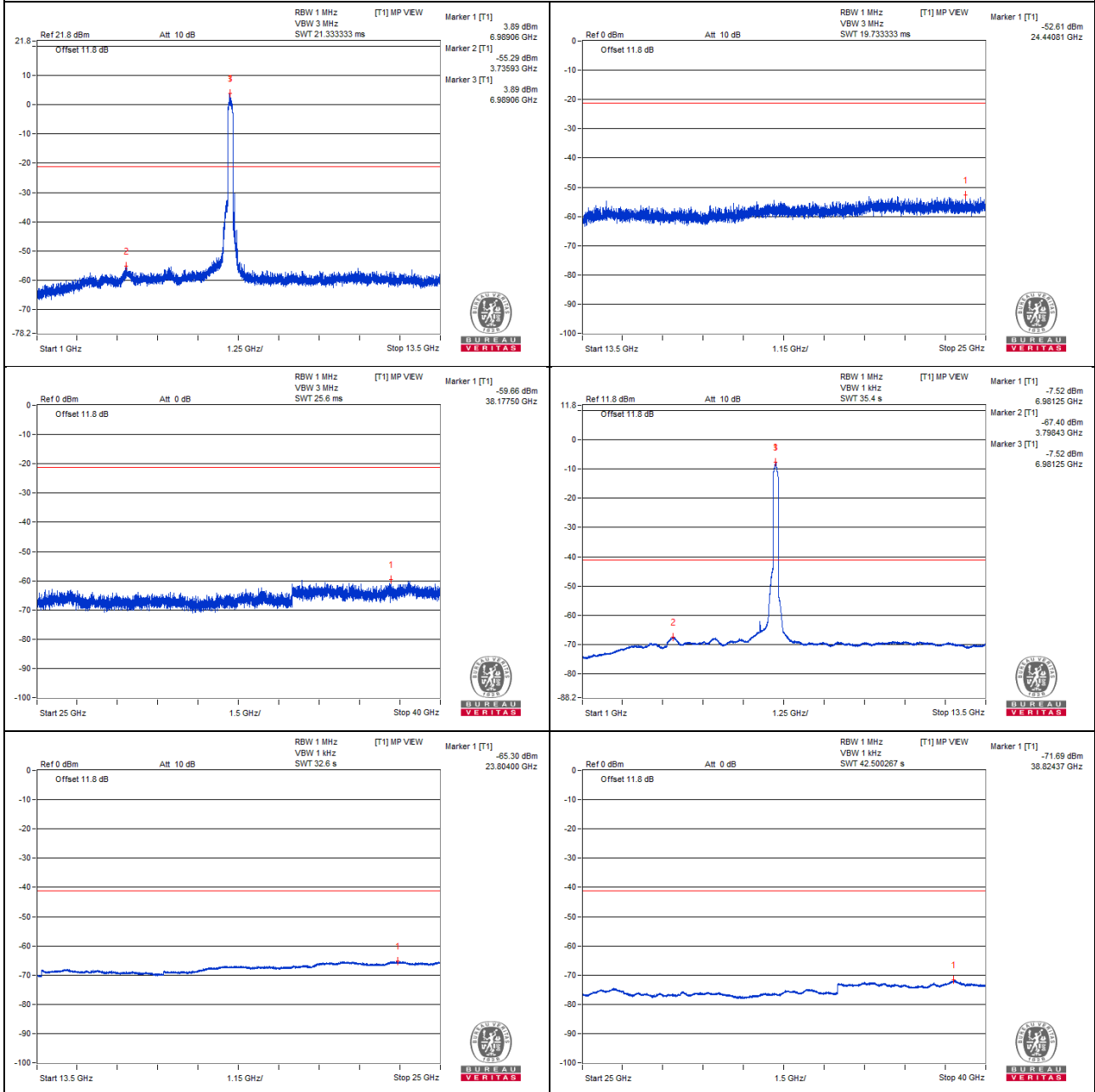

### Bandedge table

No.	Frequency (MHz)	Emission Level (dBuV/m)	Limit (dBuV/m)	Margin (dB)	Raw Value (dBm)	Correction Factor (dB)	EIRP Level (dBm)
1	#7127.27	67.37 PK	88.2	-20.83	-31.98	4.09	-27.89
2	#7126.3	45.04 AV	68.2	-23.16	-54.31	4.09	-50.22

#### Remarks:

1. Margin value = Emission Level – Limit value
2. The other emission levels were very low against the limit.
3. " # " : The frequency is out of the restricted band.

### Chain 0

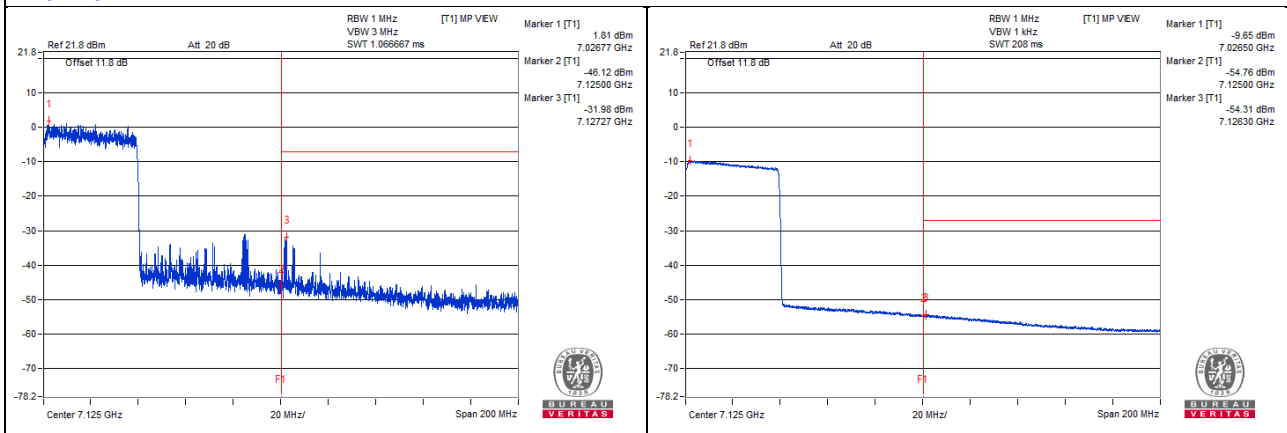

### 802.11be (EHT20) - Channel 1

#### Conducted spurious emission table

No.	Frequency (MHz)	Emission Level (dBuV/m)	Limit (dBuV/m)	Margin (dB)	Raw Value (dBm)	Correction Factor (dB)	EIRP Level (dBm)
1	11915.62	41.82 PK	74	-32.18	-58.2	4.76	-53.44
2	11909.37	30.34 AV	54	-23.66	-69.68	4.76	-64.92
3	17871.43	42.53 PK	74	-31.47	-57.49	4.76	-52.73
4	17871.43	31.21 AV	54	-22.79	-68.81	4.76	-64.05

#### Remarks:

1. Margin value = Emission Level – Limit value
2. The other emission levels were very low against the limit.

### Chain 0

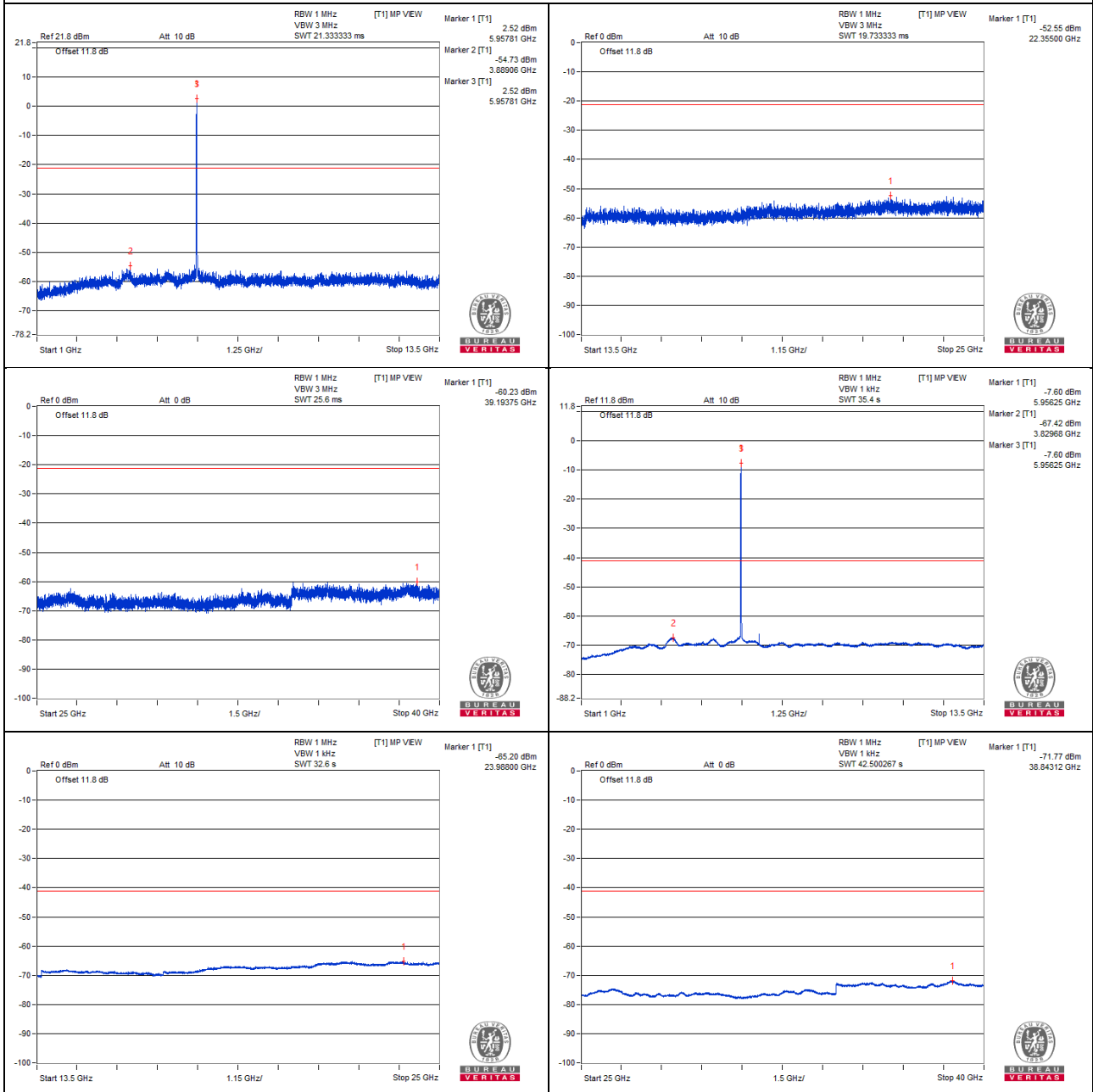

### Bandedge table

No.	Frequency (MHz)	Emission Level (dBuV/m)	Limit (dBuV/m)	Margin (dB)	Raw Value (dBm)	Correction Factor (dB)	EIRP Level (dBm)
1	#5915.07	53.22 PK	88.2	-34.98	-46.8	4.76	-42.04
2	#5914.9	40.62 AV	68.2	-27.58	-59.4	4.76	-54.64

#### Remarks:

1. Margin value = Emission Level – Limit value
2. The other emission levels were very low against the limit.
3. " # " : The frequency is out of the restricted band.

### Chain 0

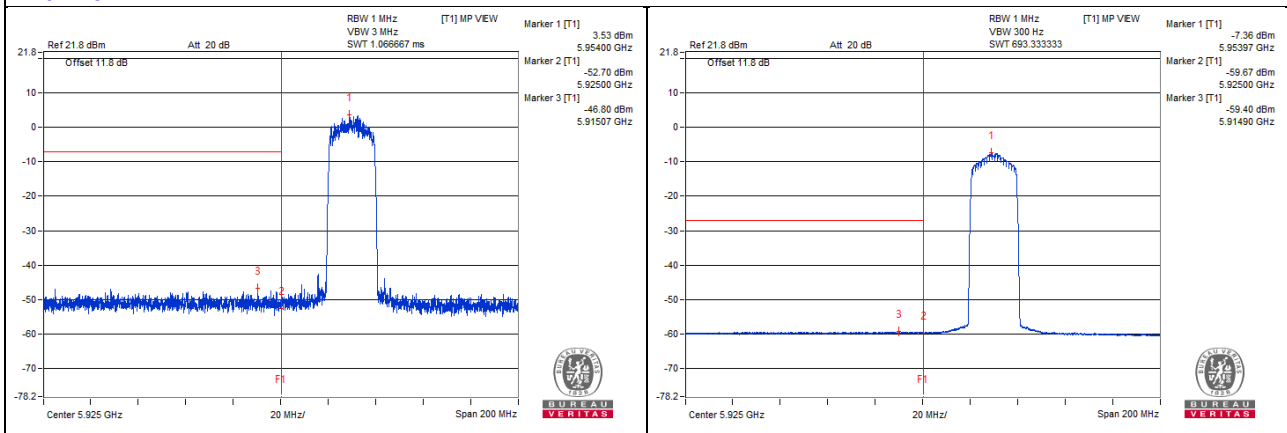

### 802.11be (EHT20) - Channel 45

#### Conducted spurious emission table

No.	Frequency (MHz)	Emission Level (dBuV/m)	Limit (dBuV/m)	Margin (dB)	Raw Value (dBm)	Correction Factor (dB)	EIRP Level (dBm)
1	12359.37	40.99 PK	74	-33.01	-59.03	4.76	-54.27
2	12350	30.39 AV	54	-23.61	-69.63	4.76	-64.87
3	18528.37	43.43 PK	74	-30.57	-56.59	4.76	-51.83
4	18516.87	32.39 AV	54	-21.61	-67.63	4.76	-62.87

#### Remarks:

1. Margin value = Emission Level – Limit value
2. The other emission levels were very low against the limit.



### Chain 0

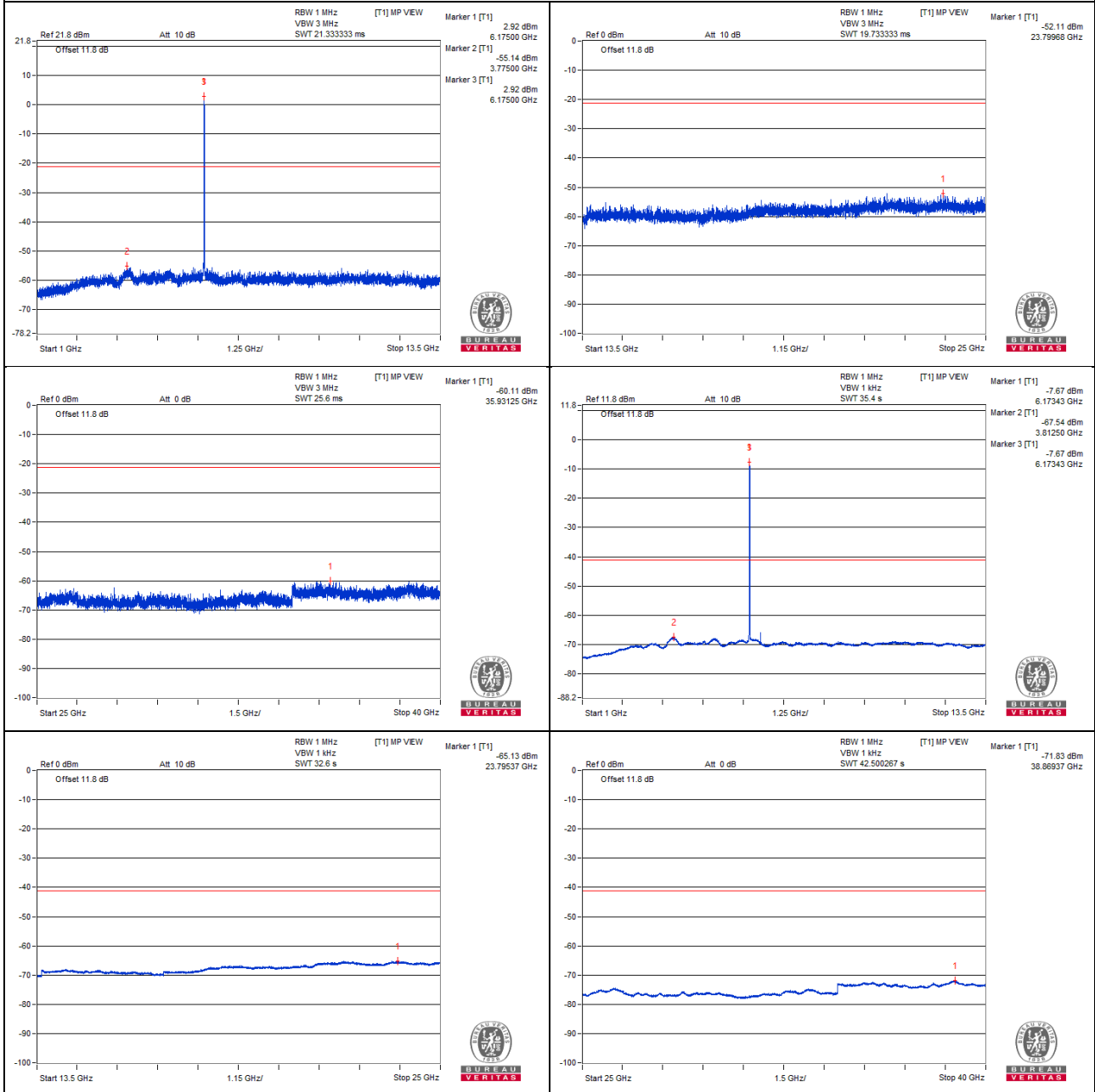

### 802.11be (EHT20) – Channel 93

#### Conducted spurious emission table

No.	Frequency (MHz)	Emission Level (dBuV/m)	Limit (dBuV/m)	Margin (dB)	Raw Value (dBm)	Correction Factor (dB)	EIRP Level (dBm)
1	#12826.56	40.49 PK	88.2	-47.71	-59.53	4.76	-54.77
2	#12821.87	29.81 AV	68.2	-38.39	-70.21	4.76	-65.45
3	19239.93	44.95 PK	74	-29.05	-55.07	4.76	-50.31
4	19251.43	32.98 AV	54	-21.02	-67.04	4.76	-62.28

#### Remarks:

1. Margin value = Emission Level – Limit value
2. The other emission levels were very low against the limit.
3. " # " : The frequency is out of the restricted band.

### Chain 0

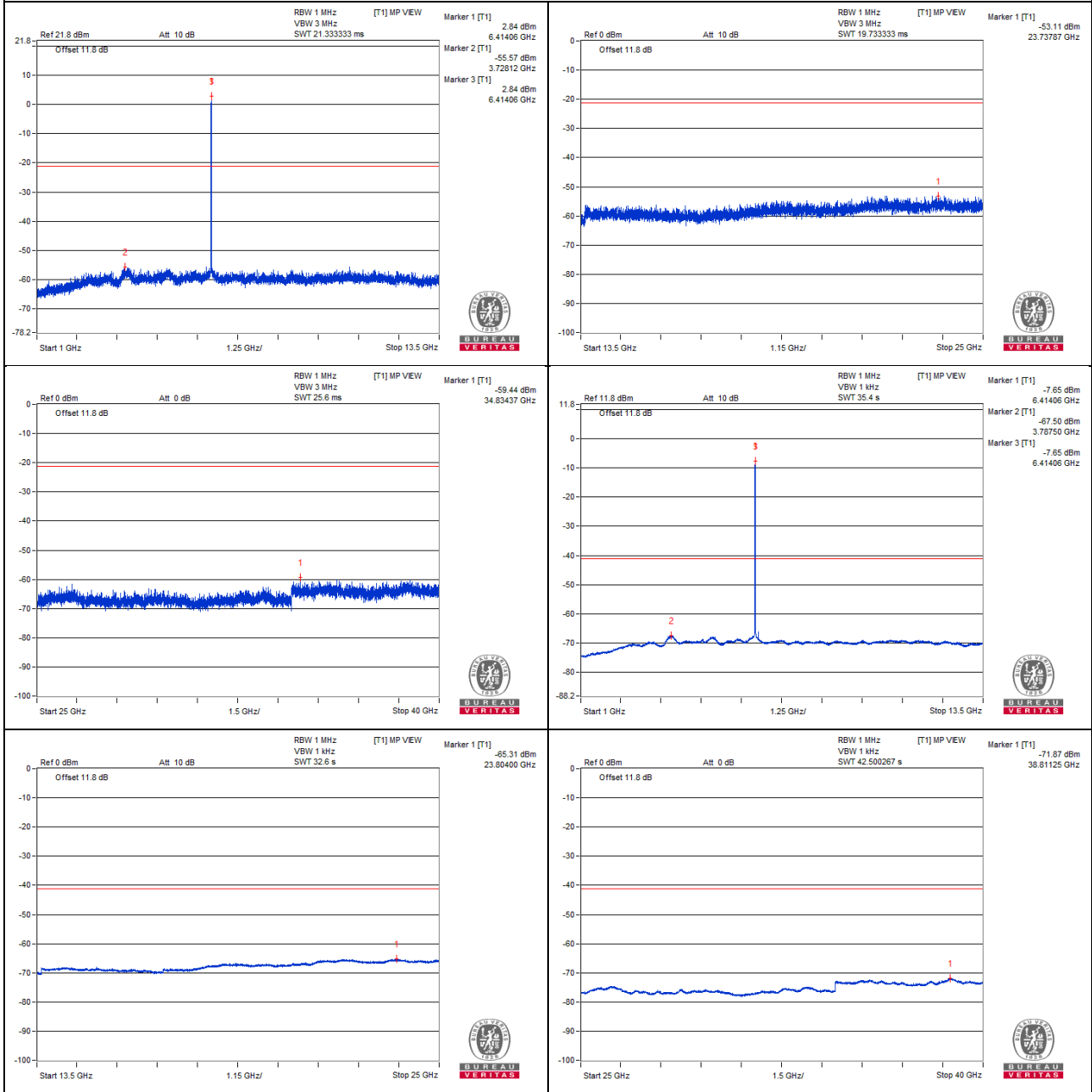

### 802.11be (EHT20) - Channel 97

#### Conducted spurious emission table

No.	Frequency (MHz)	Emission Level (dBuV/m)	Limit (dBuV/m)	Margin (dB)	Raw Value (dBm)	Correction Factor (dB)	EIRP Level (dBm)
1	#12878.12	41.96 PK	88.2	-46.24	-58.06	4.76	-53.30
2	#12870.31	29.58 AV	68.2	-38.62	-70.44	4.76	-65.68
3	19304.62	45.43 PK	74	-28.57	-54.59	4.76	-49.83
4	19301.75	33.01 AV	54	-20.99	-67.01	4.76	-62.25

#### Remarks:

1. Margin value = Emission Level – Limit value
2. The other emission levels were very low against the limit.
3. " # " : The frequency is out of the restricted band.

### Chain 0

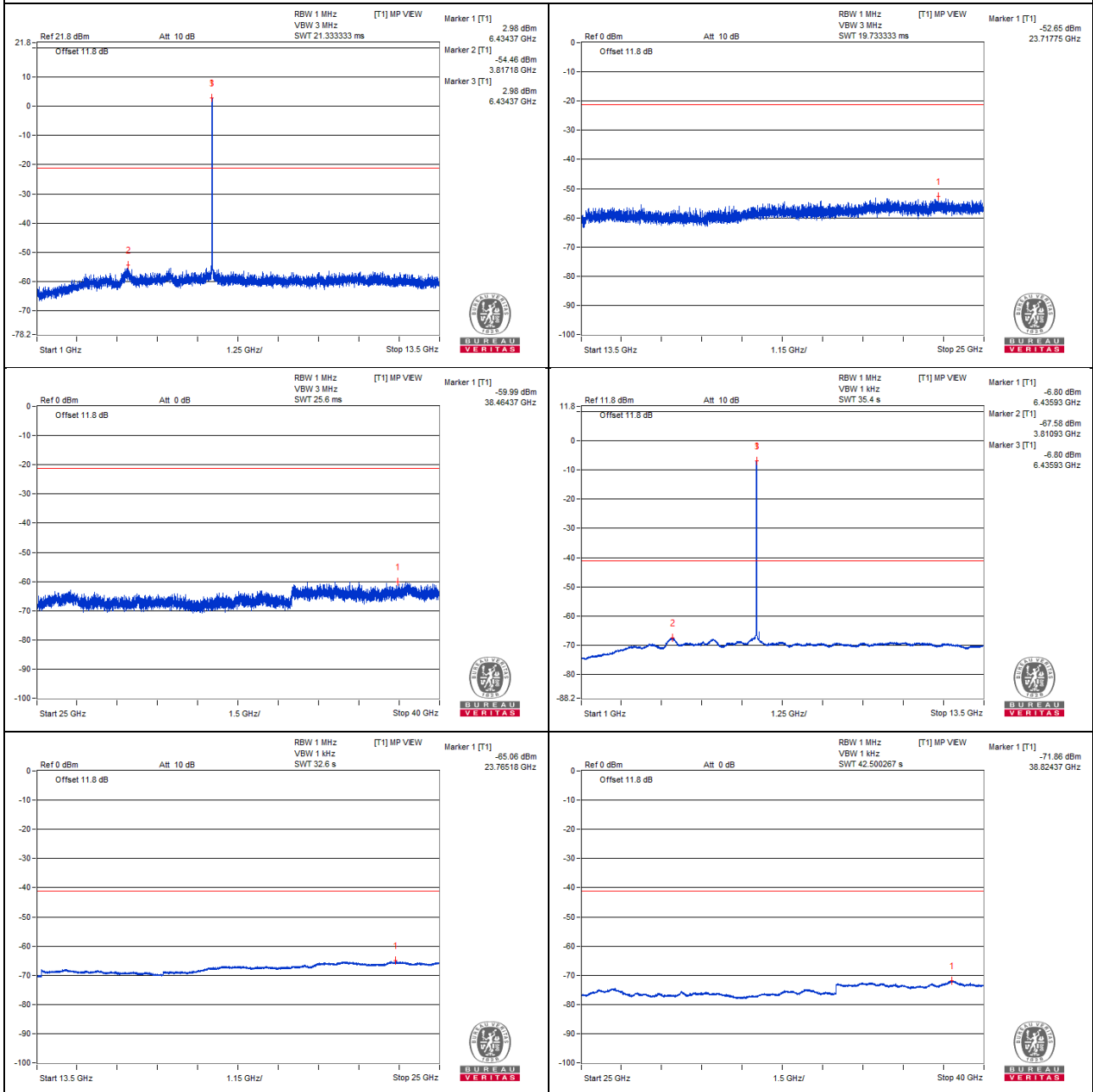

**802.11be (EHT20) - Channel 105**  
**Conducted spurious emission table**

No.	Frequency (MHz)	Emission Level (dBuV/m)	Limit (dBuV/m)	Margin (dB)	Raw Value (dBm)	Correction Factor (dB)	EIRP Level (dBm)
1	#12956.25	40.39 PK	88.2	-47.81	-59.63	4.76	-54.87
2	#12945.31	29.32 AV	68.2	-38.88	-70.7	4.76	-65.94
3	19418.18	44.17 PK	74	-29.83	-55.85	4.76	-51.09
4	19415.31	32.89 AV	54	-21.11	-67.13	4.76	-62.37

Remarks:

1. Margin value = Emission Level – Limit value
2. The other emission levels were very low against the limit.
3. " # " : The frequency is out of the restricted band.

### Chain 0

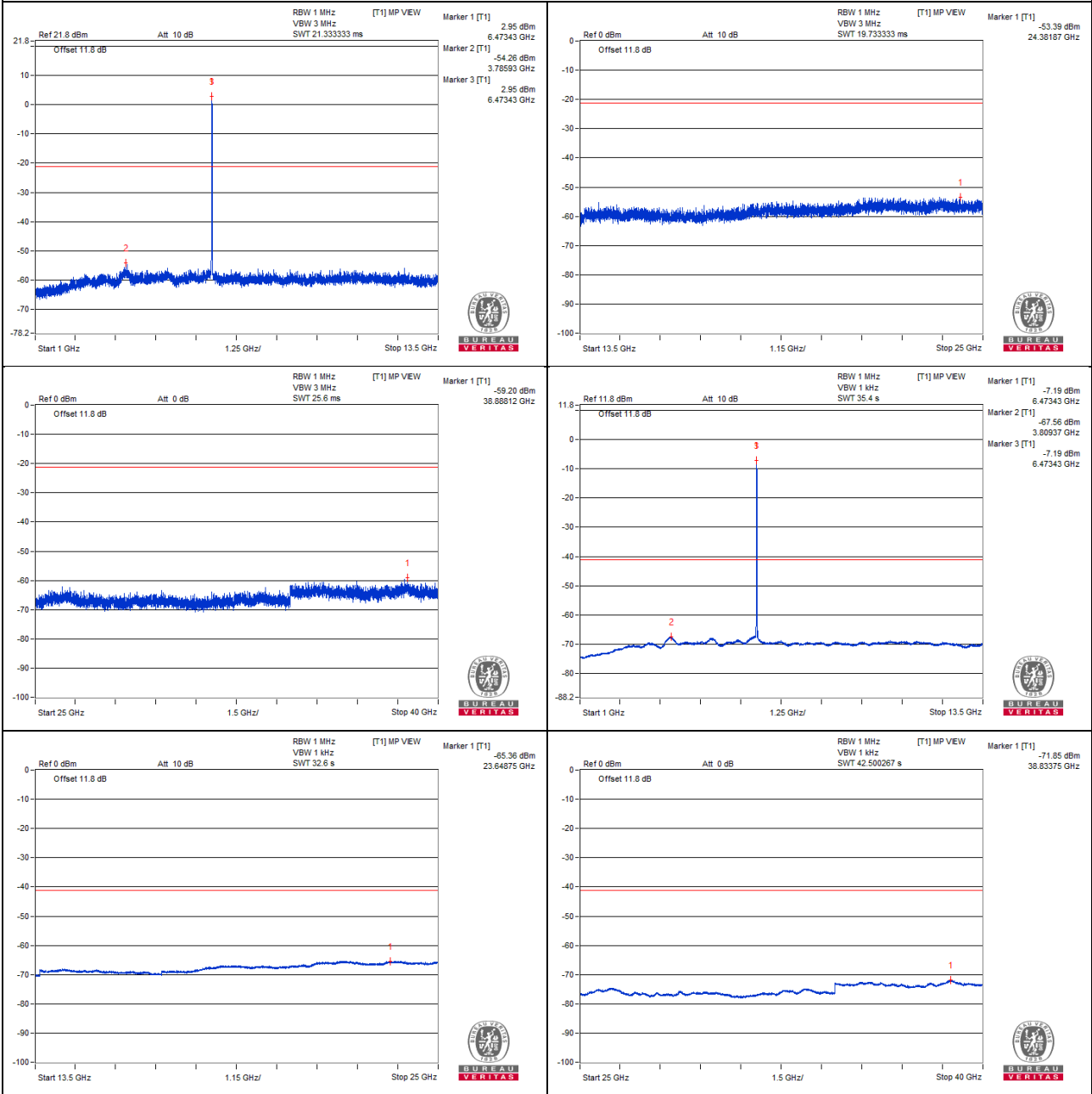

### 802.11be (EHT20) - Channel 113

#### Conducted spurious emission table

No.	Frequency (MHz)	Emission Level (dBuV/m)	Limit (dBuV/m)	Margin (dB)	Raw Value (dBm)	Correction Factor (dB)	EIRP Level (dBm)
1	#13028.12	40.56 PK	88.2	-47.64	-59.46	4.76	-54.70
2	#13034.37	29.17 AV	68.2	-39.03	-70.85	4.76	-66.09
3	19541.81	43.19 PK	74	-30.81	-56.83	4.76	-52.07
4	19549	32.57 AV	54	-21.43	-67.45	4.76	-62.69

#### Remarks:

1. Margin value = Emission Level – Limit value
2. The other emission levels were very low against the limit.



### Chain 0

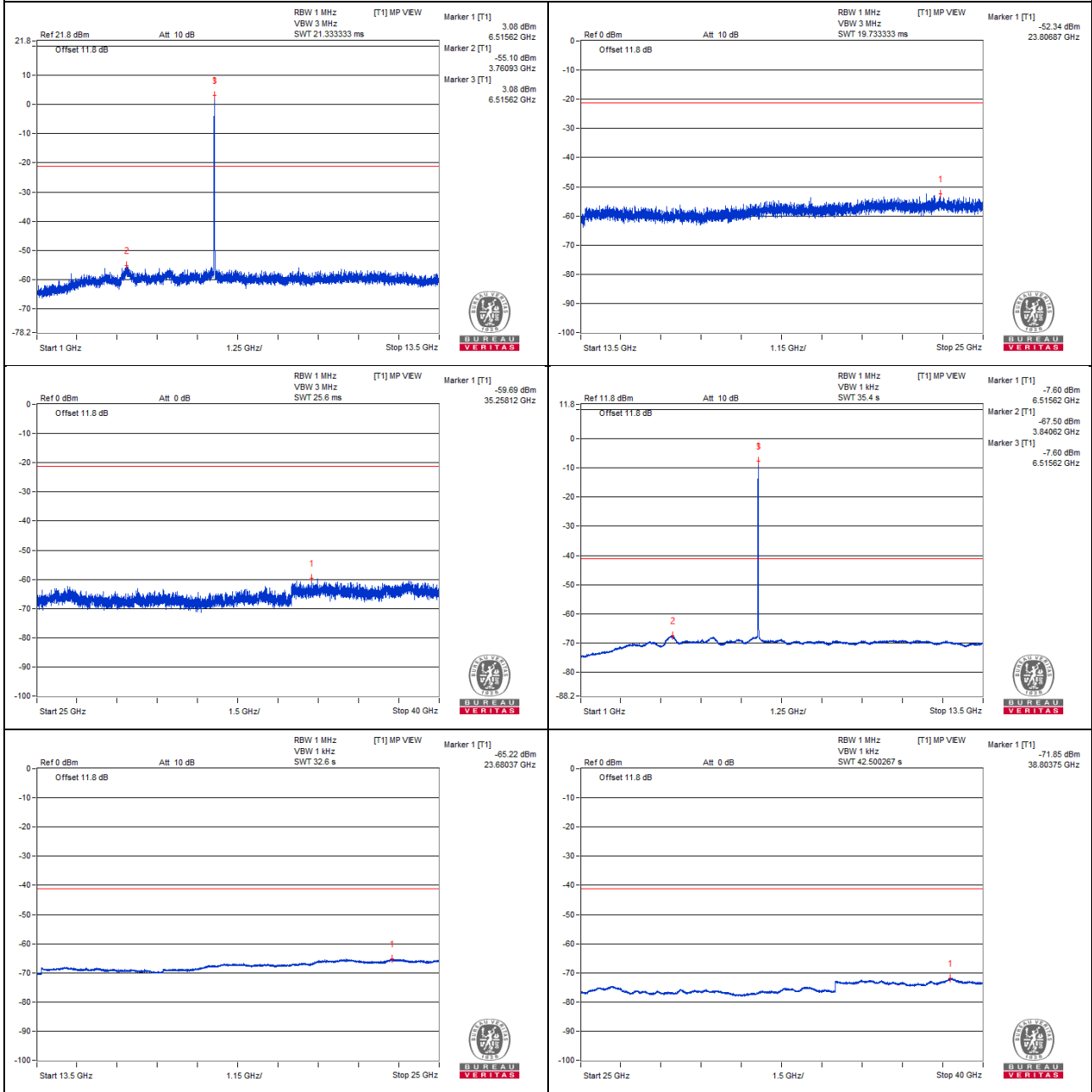

### 802.11be (EHT20) - Channel 117

#### Conducted spurious emission table

No.	Frequency (MHz)	Emission Level (dBuV/m)	Limit (dBuV/m)	Margin (dB)	Raw Value (dBm)	Correction Factor (dB)	EIRP Level (dBm)
1	#13060.93	40.93 PK	88.2	-47.27	-59.09	4.76	-54.33
2	#13078.12	29.53 AV	68.2	-38.67	-70.49	4.76	-65.73
3	19610.81	43.83 PK	74	-30.17	-56.19	4.76	-51.43
4	19595	32.54 AV	54	-21.46	-67.48	4.76	-62.72

#### Remarks:

1. Margin value = Emission Level – Limit value
2. The other emission levels were very low against the limit.

### Chain 0

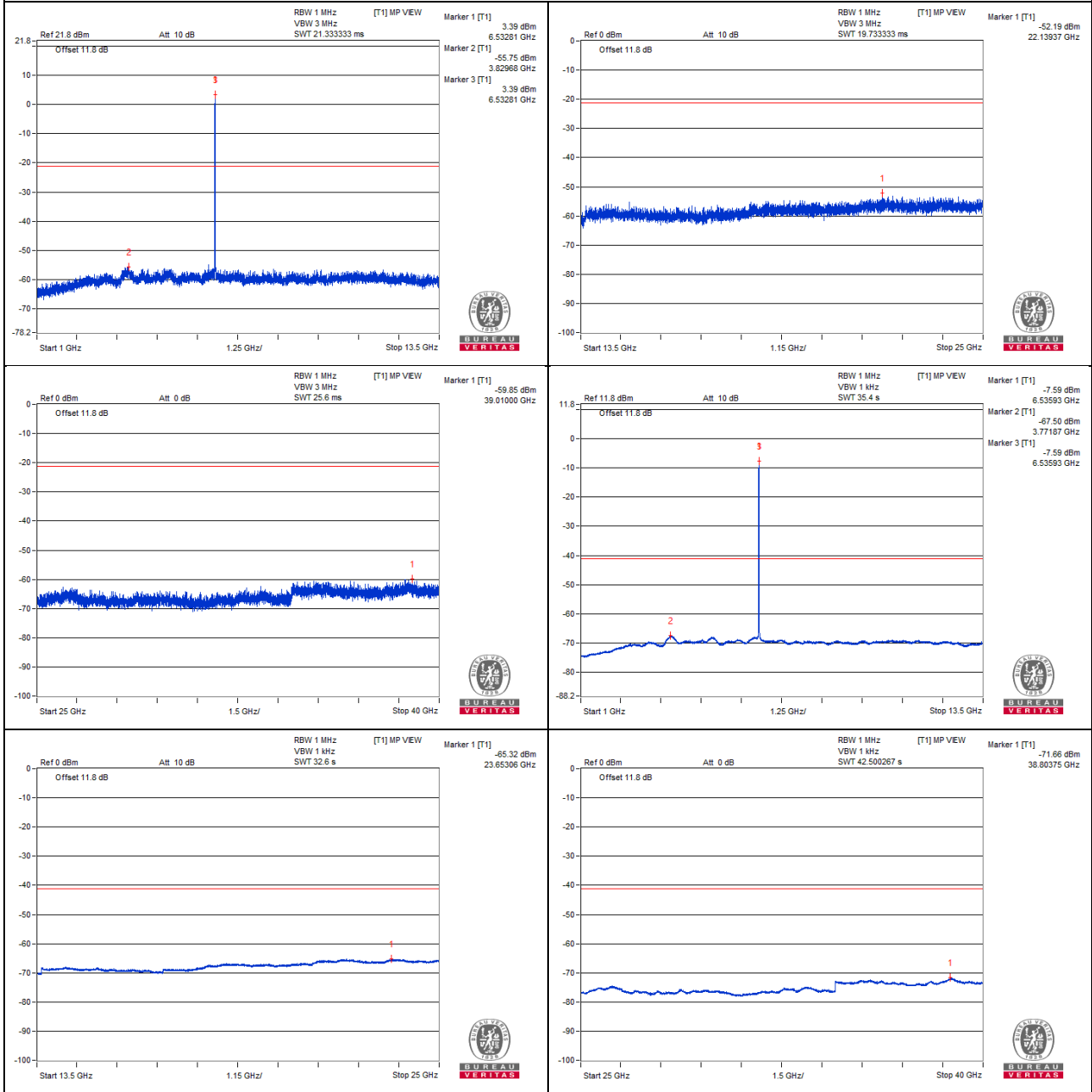

**802.11be (EHT20) - Channel 153**  
**Conducted spurious emission table**

No.	Frequency (MHz)	Emission Level (dBuV/m)	Limit (dBuV/m)	Margin (dB)	Raw Value (dBm)	Correction Factor (dB)	EIRP Level (dBm)
1	#13420.31	40.75 PK	88.2	-47.45	-59.27	4.76	-54.51
2	#13426.56	29.81 AV	68.2	-38.39	-70.21	4.76	-65.45
3	20152.75	42.83 PK	74	-31.17	-57.19	4.76	-52.43
4	20145.56	32.9 AV	54	-21.1	-67.12	4.76	-62.36

Remarks:

1. Margin value = Emission Level – Limit value
2. The other emission levels were very low against the limit.
3. " # " : The frequency is out of the restricted band.

### Chain 0

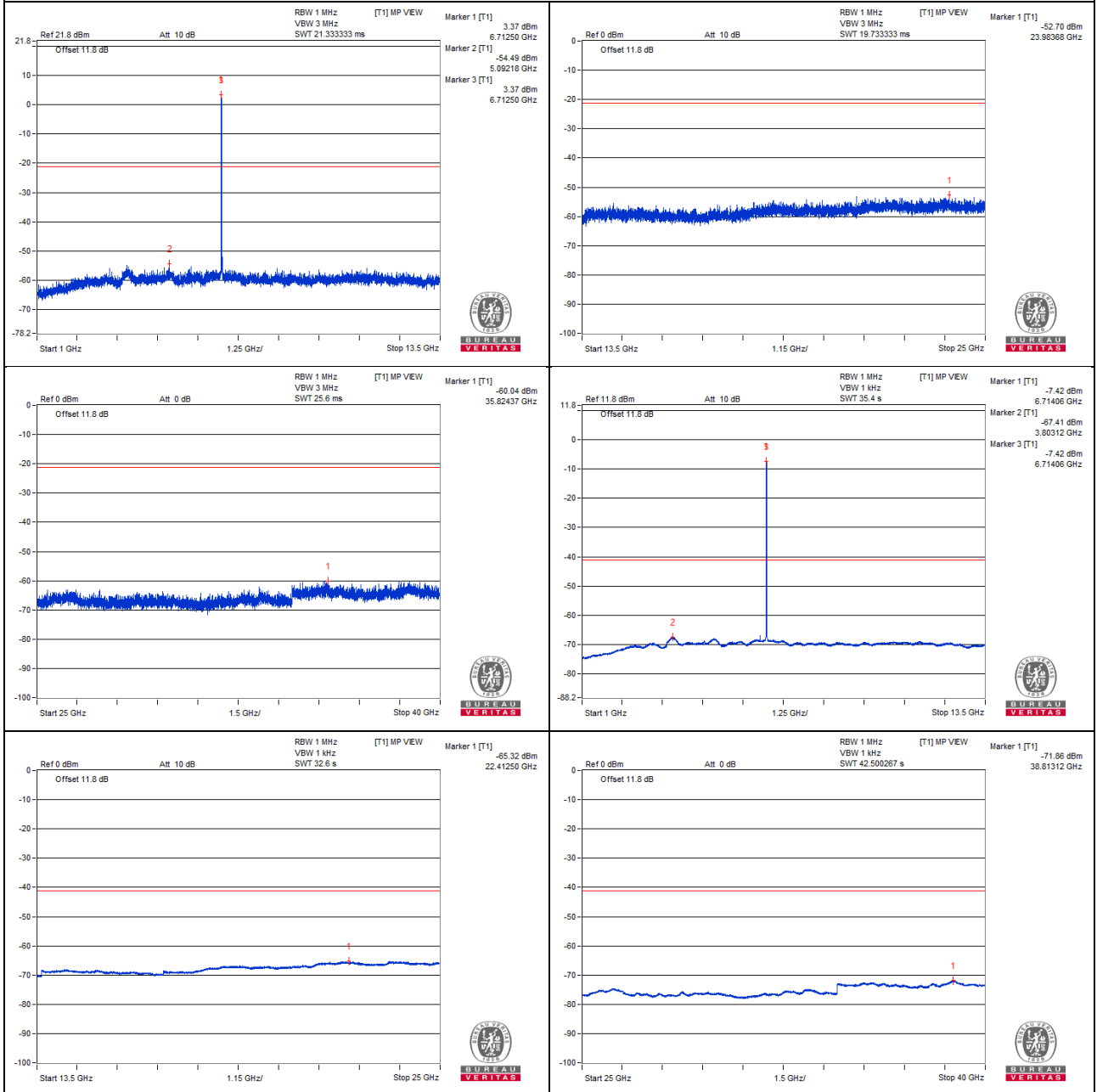

**802.11be (EHT20) - Channel 181**  
**Conducted spurious emission table**

No.	Frequency (MHz)	Emission Level (dBuV/m)	Limit (dBuV/m)	Margin (dB)	Raw Value (dBm)	Correction Factor (dB)	EIRP Level (dBm)
1	#13705.56	41.56 PK	88.2	-46.64	-58.46	4.76	-53.70
2	#13714.18	31.35 AV	68.2	-36.85	-68.67	4.76	-63.91
3	20573.93	43.25 PK	74	-30.75	-56.77	4.76	-52.01
4	20555.25	32.63 AV	54	-21.37	-67.39	4.76	-62.63

Remarks:

1. Margin value = Emission Level – Limit value
2. The other emission levels were very low against the limit.
3. " # " : The frequency is out of the restricted band.

### Chain 0

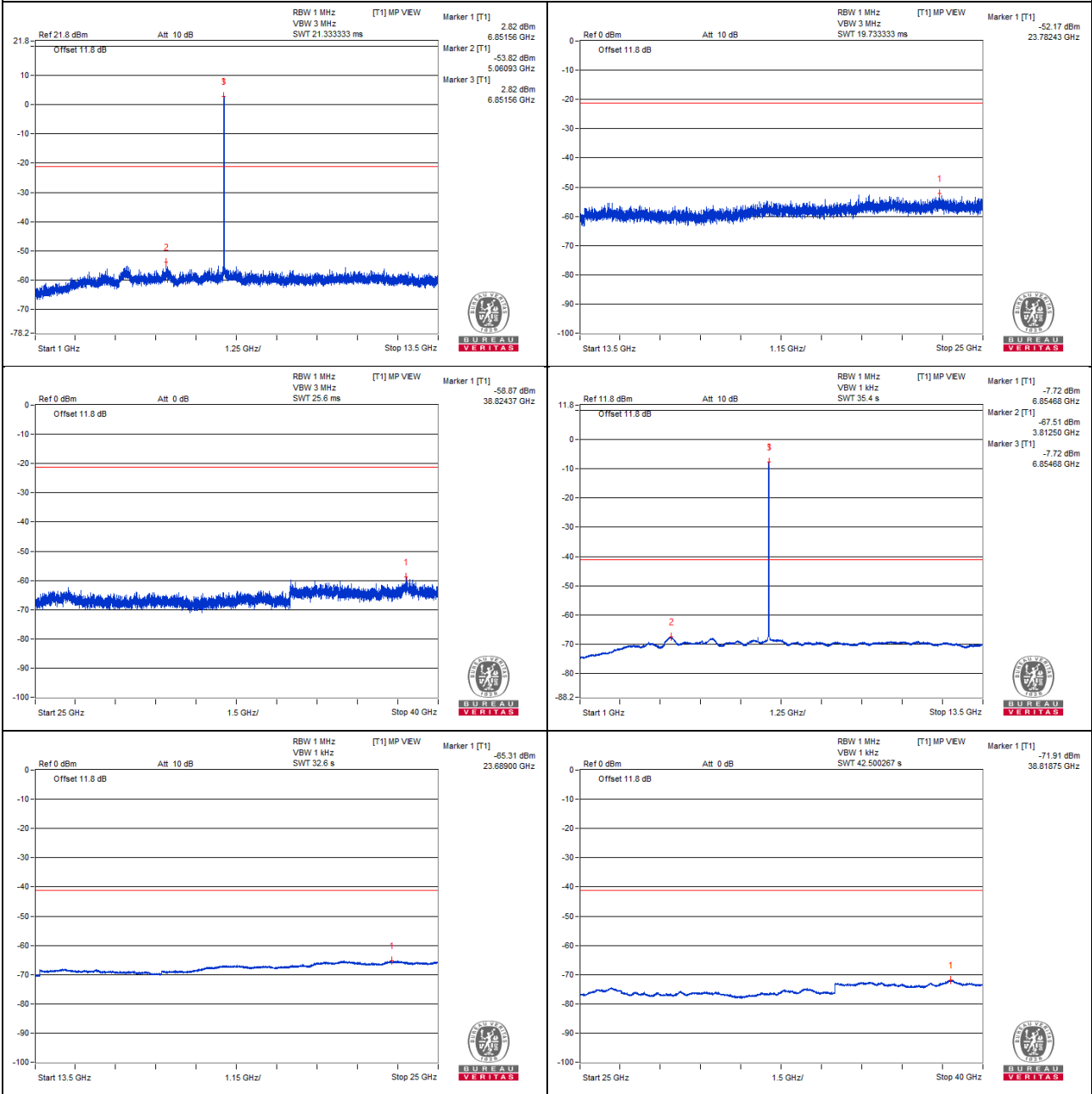

**802.11be (EHT20) - Channel 185**  
**Conducted spurious emission table**

No.	Frequency (MHz)	Emission Level (dBuV/m)	Limit (dBuV/m)	Margin (dB)	Raw Value (dBm)	Correction Factor (dB)	EIRP Level (dBm)
1	#13751.56	44.46 PK	88.2	-43.74	-55.56	4.76	-50.80
2	#13755.87	31.18 AV	68.2	-37.02	-68.84	4.76	-64.08
3	20622.81	43.3 PK	74	-30.7	-56.72	4.76	-51.96
4	20631.43	32.82 AV	54	-21.18	-67.2	4.76	-62.44

Remarks:

1. Margin value = Emission Level – Limit value
2. The other emission levels were very low against the limit.
3. " # " : The frequency is out of the restricted band.



### Chain 0

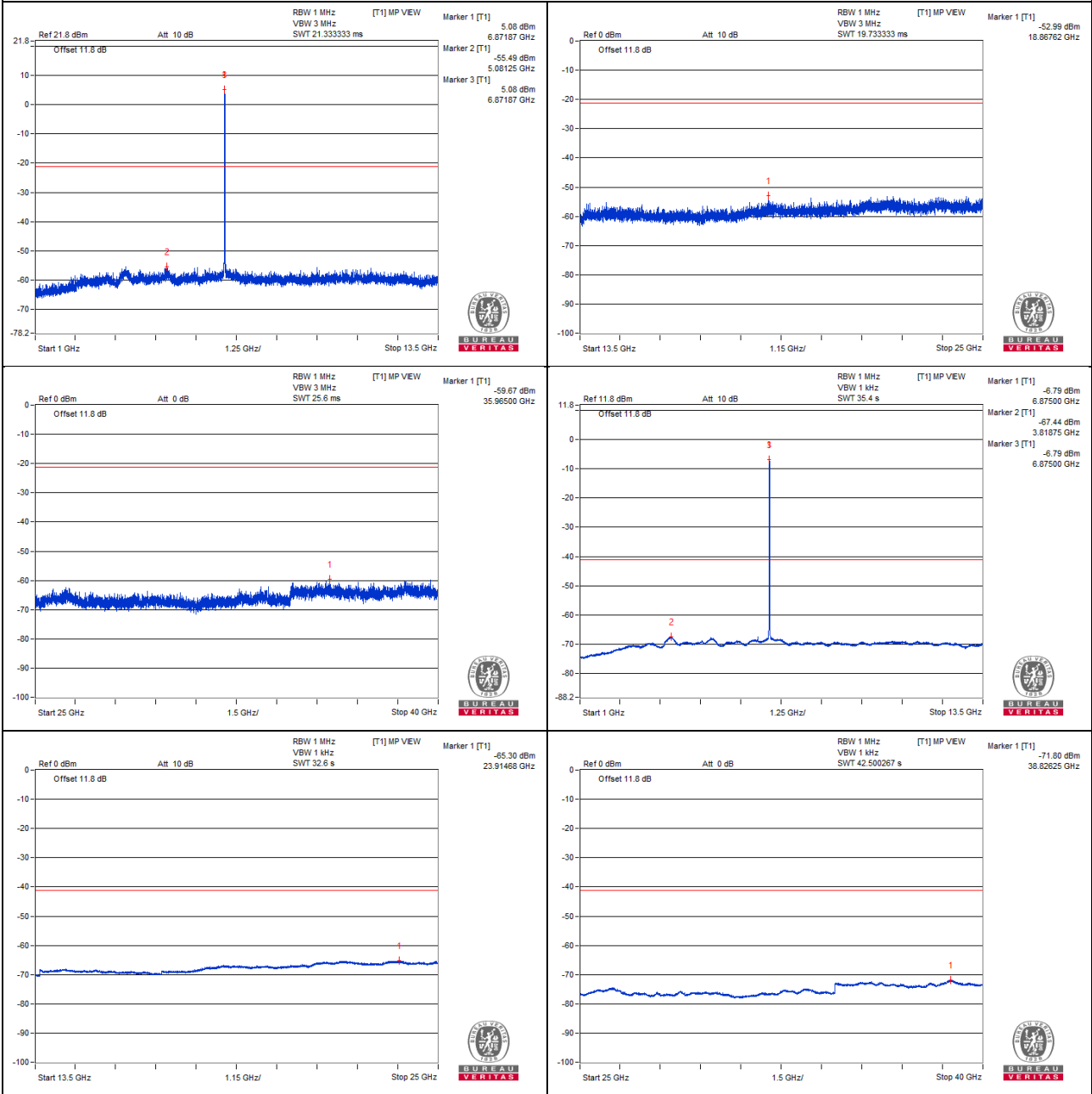

**802.11be (EHT20) - Channel 213**  
**Conducted spurious emission table**

No.	Frequency (MHz)	Emission Level (dBuV/m)	Limit (dBuV/m)	Margin (dB)	Raw Value (dBm)	Correction Factor (dB)	EIRP Level (dBm)
1	#14020.37	42.12 PK	88.2	-46.08	-57.9	4.76	-53.14
2	#14029	31.46 AV	68.2	-36.74	-68.56	4.76	-63.80
3	21051.18	45.56 PK	74	-28.44	-54.46	4.76	-49.70
4	21046.87	33.18 AV	54	-20.82	-66.84	4.76	-62.08

Remarks:

1. Margin value = Emission Level – Limit value
2. The other emission levels were very low against the limit.
3. " # " : The frequency is out of the restricted band.

### Chain 0

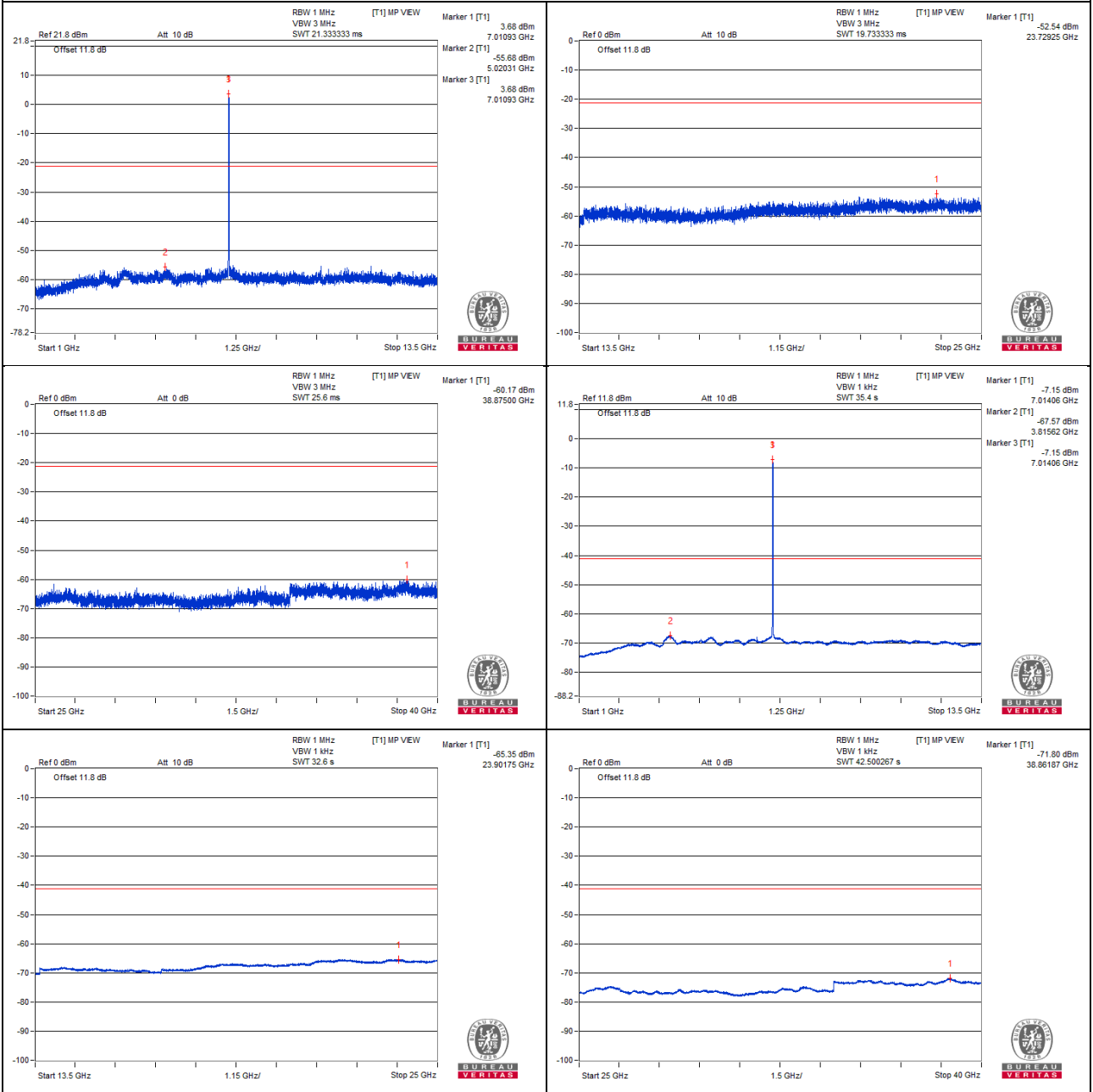

### 802.11be (EHT20) - Channel 233

#### Conducted spurious emission table

No.	Frequency (MHz)	Emission Level (dBuV/m)	Limit (dBuV/m)	Margin (dB)	Raw Value (dBm)	Correction Factor (dB)	EIRP Level (dBm)
1	#14236	42.21 PK	88.2	-45.99	-57.81	4.76	-53.05
2	#14227.37	31.75 AV	68.2	-36.45	-68.27	4.76	-63.51
3	21350.18	44.77 PK	74	-29.23	-55.25	4.76	-50.49
4	21335.81	33 AV	54	-21	-67.02	4.76	-62.26

#### Remarks:

1. Margin value = Emission Level – Limit value
2. The other emission levels were very low against the limit.
3. " # " : The frequency is out of the restricted band.

### Chain 0

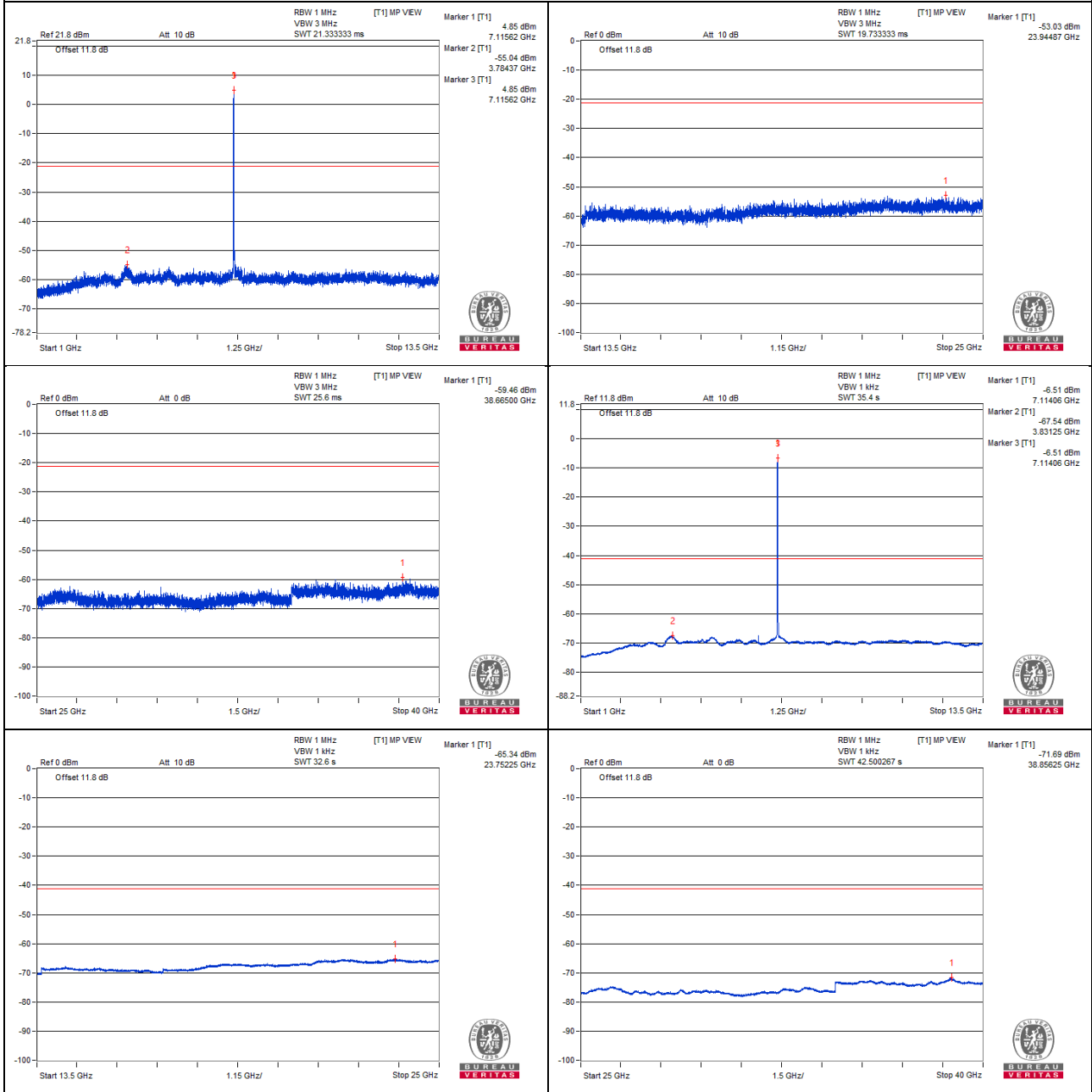

### Bandedge table

No.	Frequency (MHz)	Emission Level (dBuV/m)	Limit (dBuV/m)	Margin (dB)	Raw Value (dBm)	Correction Factor (dB)	EIRP Level (dBm)
1	#7125	56.37 PK	88.2	-31.83	-42.98	4.09	-38.89
2	#7125	49.25 AV	68.2	-18.95	-50.08	4.09	-46.01

#### Remarks:

1. Margin value = Emission Level – Limit value
2. The other emission levels were very low against the limit.
3. " # " : The frequency is out of the restricted band.
4. Follow ANSI C63.10 section 12.7.4.4.3 Integration method.

### Chain 0

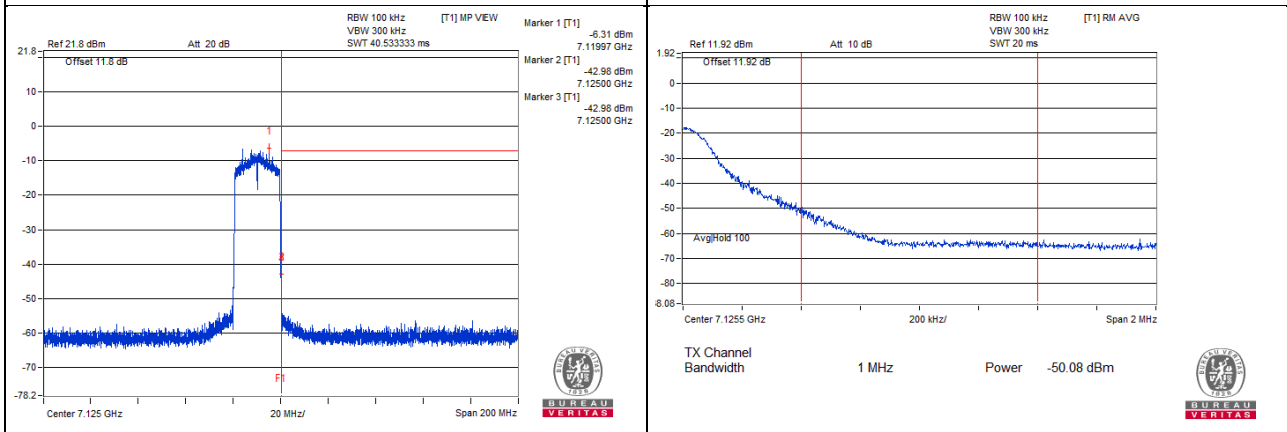

### 802.11be (EHT40) - Channel 3

#### Conducted spurious emission table

No.	Frequency (MHz)	Emission Level (dBuV/m)	Limit (dBuV/m)	Margin (dB)	Raw Value (dBm)	Correction Factor (dB)	EIRP Level (dBm)
1	11939.06	41.12 PK	74	-32.88	-58.9	4.76	-54.14
2	11928.12	30.15 AV	54	-23.85	-69.87	4.76	-65.11
3	17903.06	41.92 PK	74	-32.08	-58.1	4.76	-53.34
4	17894.43	31.08 AV	54	-22.92	-68.94	4.76	-64.18

#### Remarks:

1. Margin value = Emission Level – Limit value
2. The other emission levels were very low against the limit.

### Chain 0

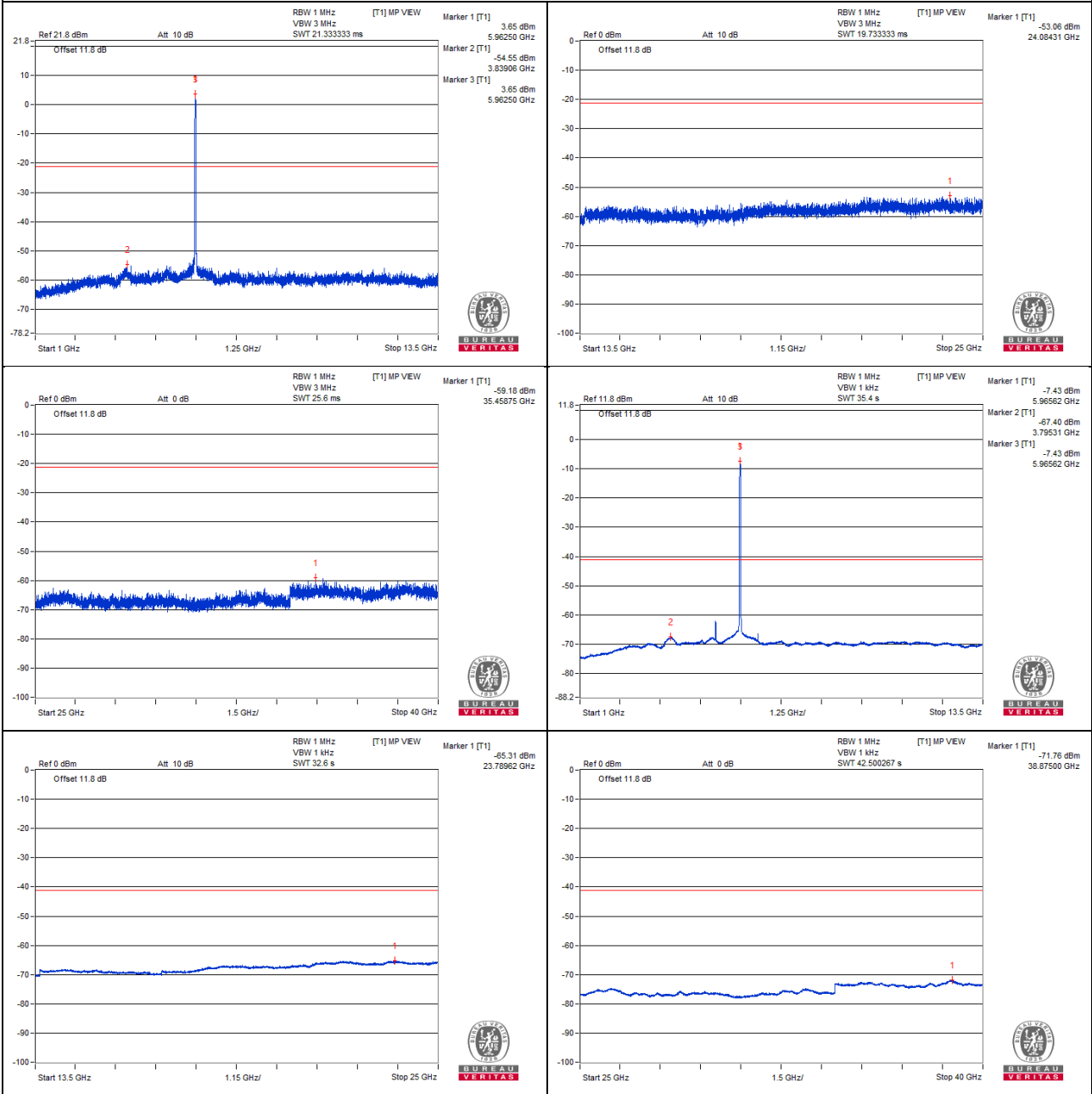



### Bandedge table

No.	Frequency (MHz)	Emission Level (dBuV/m)	Limit (dBuV/m)	Margin (dB)	Raw Value (dBm)	Correction Factor (dB)	EIRP Level (dBm)
1	#5842.9	52.96 PK	88.2	-35.24	-47.06	4.76	-42.30
2	#5923.37	40.93 AV	68.2	-27.27	-59.09	4.76	-54.33

#### Remarks:

1. Margin value = Emission Level – Limit value
2. The other emission levels were very low against the limit.
3. " # " : The frequency is out of the restricted band.

### Chain 0

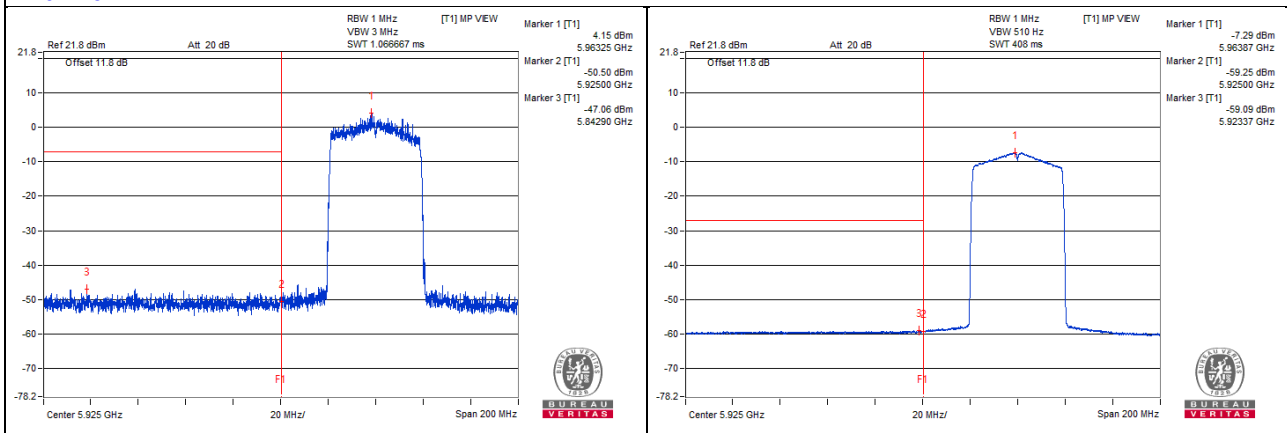

### 802.11be (EHT40) - Channel 43

#### Conducted spurious emission table

No.	Frequency (MHz)	Emission Level (dBuV/m)	Limit (dBuV/m)	Margin (dB)	Raw Value (dBm)	Correction Factor (dB)	EIRP Level (dBm)
1	12337.5	40.68 PK	74	-33.32	-59.34	4.76	-54.58
2	12326.56	30.32 AV	54	-23.68	-69.7	4.76	-64.94
3	18499.62	44.09 PK	74	-29.91	-55.93	4.76	-51.17
4	18485.25	32.4 AV	54	-21.6	-67.62	4.76	-62.86

#### Remarks:

1. Margin value = Emission Level – Limit value
2. The other emission levels were very low against the limit.

### Chain 0

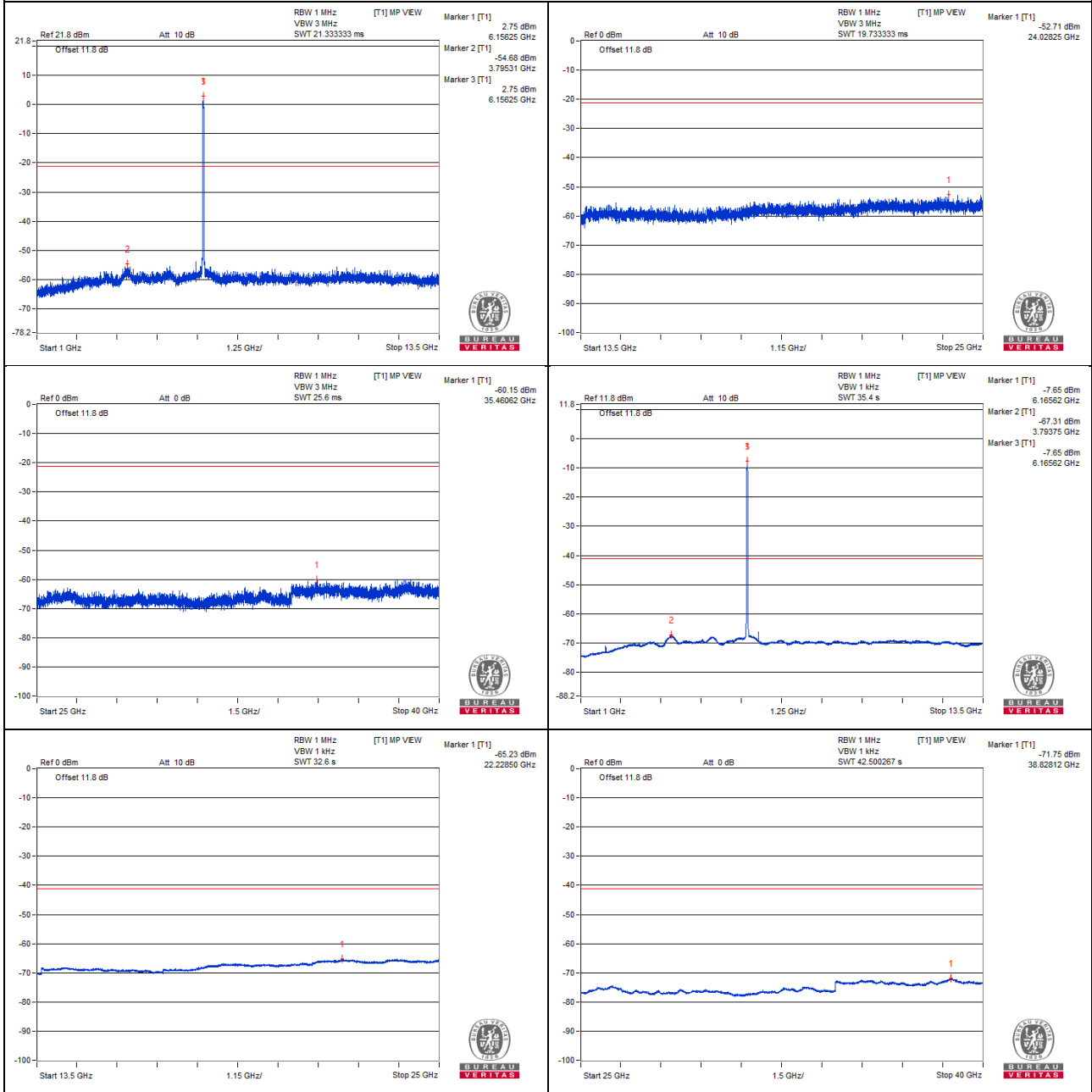

### 802.11be (EHT40) - Channel 91

#### Conducted spurious emission table

No.	Frequency (MHz)	Emission Level (dBuV/m)	Limit (dBuV/m)	Margin (dB)	Raw Value (dBm)	Correction Factor (dB)	EIRP Level (dBm)
1	#12803.12	40.57 PK	88.2	-47.63	-59.45	4.76	-54.69
2	#12807.81	29.88 AV	68.2	-38.32	-70.14	4.76	-65.38
3	19216.93	43.99 PK	74	-30.01	-56.03	4.76	-51.27
4	19206.87	32.98 AV	54	-21.02	-67.04	4.76	-62.28

#### Remarks:

1. Margin value = Emission Level – Limit value
2. The other emission levels were very low against the limit.
3. " # " : The frequency is out of the restricted band.

### Chain 0

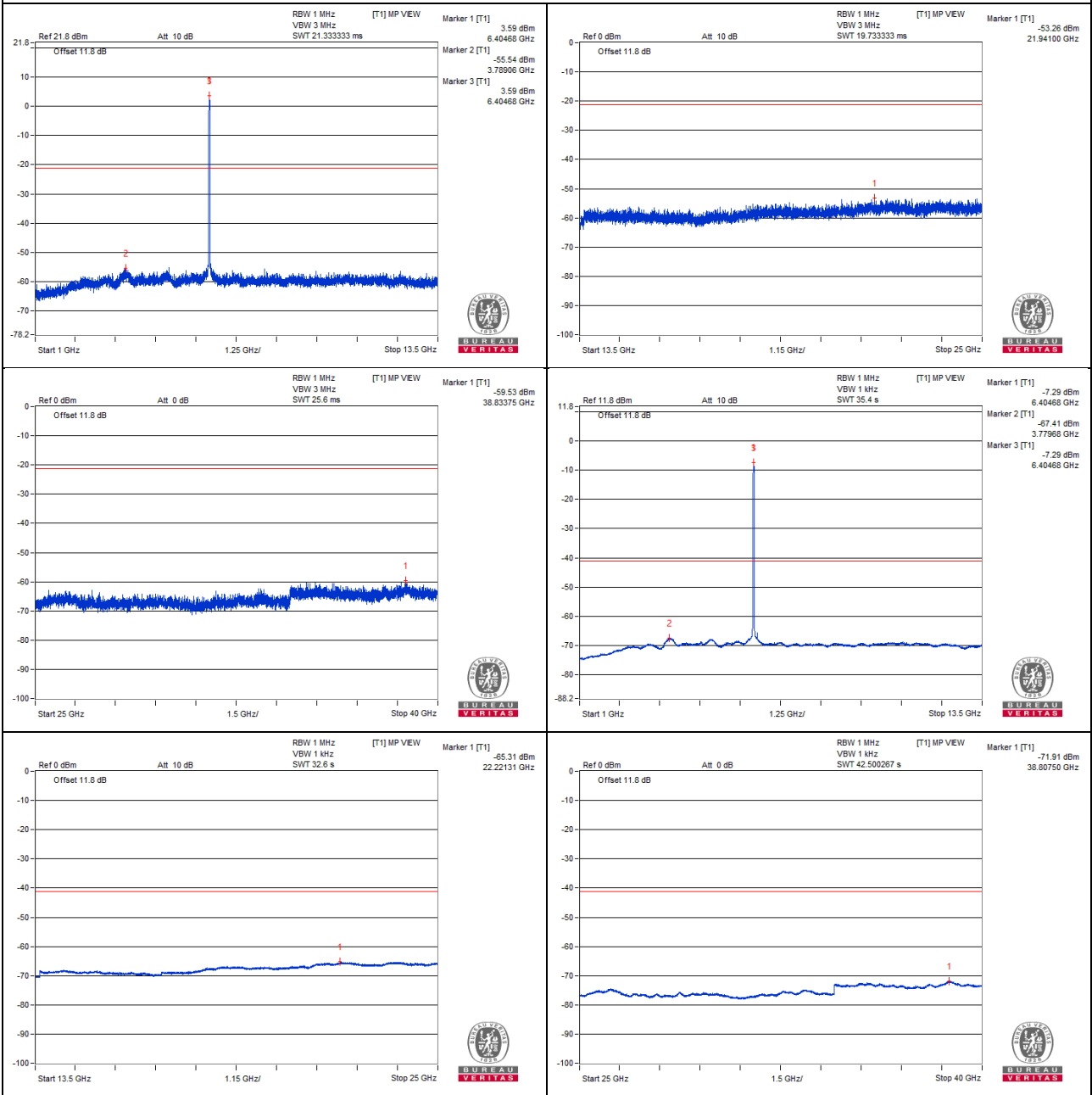

### 802.11be (EHT40) - Channel 99

#### Conducted spurious emission table

No.	Frequency (MHz)	Emission Level (dBuV/m)	Limit (dBuV/m)	Margin (dB)	Raw Value (dBm)	Correction Factor (dB)	EIRP Level (dBm)
1	#12889.06	40.29 PK	88.2	-47.91	-59.73	4.76	-54.97
2	#12889.06	29.45 AV	68.2	-38.75	-70.57	4.76	-65.81
3	19329.06	44.12 PK	74	-29.88	-55.9	4.76	-51.14
4	19326.18	33.3 AV	54	-20.7	-66.72	4.76	-61.96

#### Remarks:

1. Margin value = Emission Level – Limit value
2. The other emission levels were very low against the limit.
3. " # " : The frequency is out of the restricted band.

### Chain 0

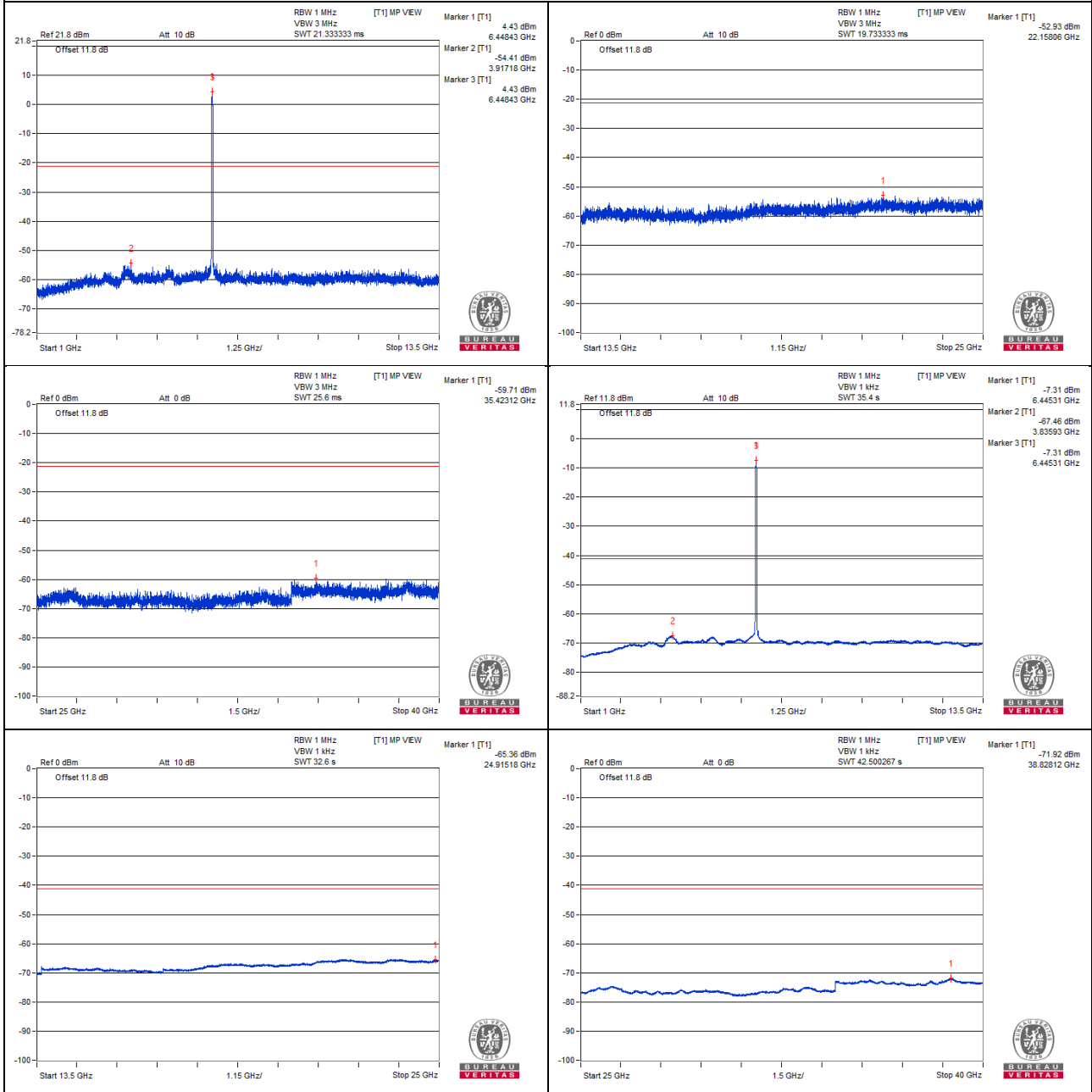

**802.11be (EHT40) - Channel 107**  
**Conducted spurious emission table**

No.	Frequency (MHz)	Emission Level (dBuV/m)	Limit (dBuV/m)	Margin (dB)	Raw Value (dBm)	Correction Factor (dB)	EIRP Level (dBm)
1	#12964.06	40.37 PK	88.2	-47.83	-59.65	4.76	-54.89
2	#12965.62	29.08 AV	68.2	-39.12	-70.94	4.76	-66.18
3	19452.68	42.45 PK	74	-31.55	-57.57	4.76	-52.81
4	19454.12	32.84 AV	54	-21.16	-67.18	4.76	-62.42

Remarks:

1. Margin value = Emission Level – Limit value
2. The other emission levels were very low against the limit.
3. " # " : The frequency is out of the restricted band.



### Chain 0

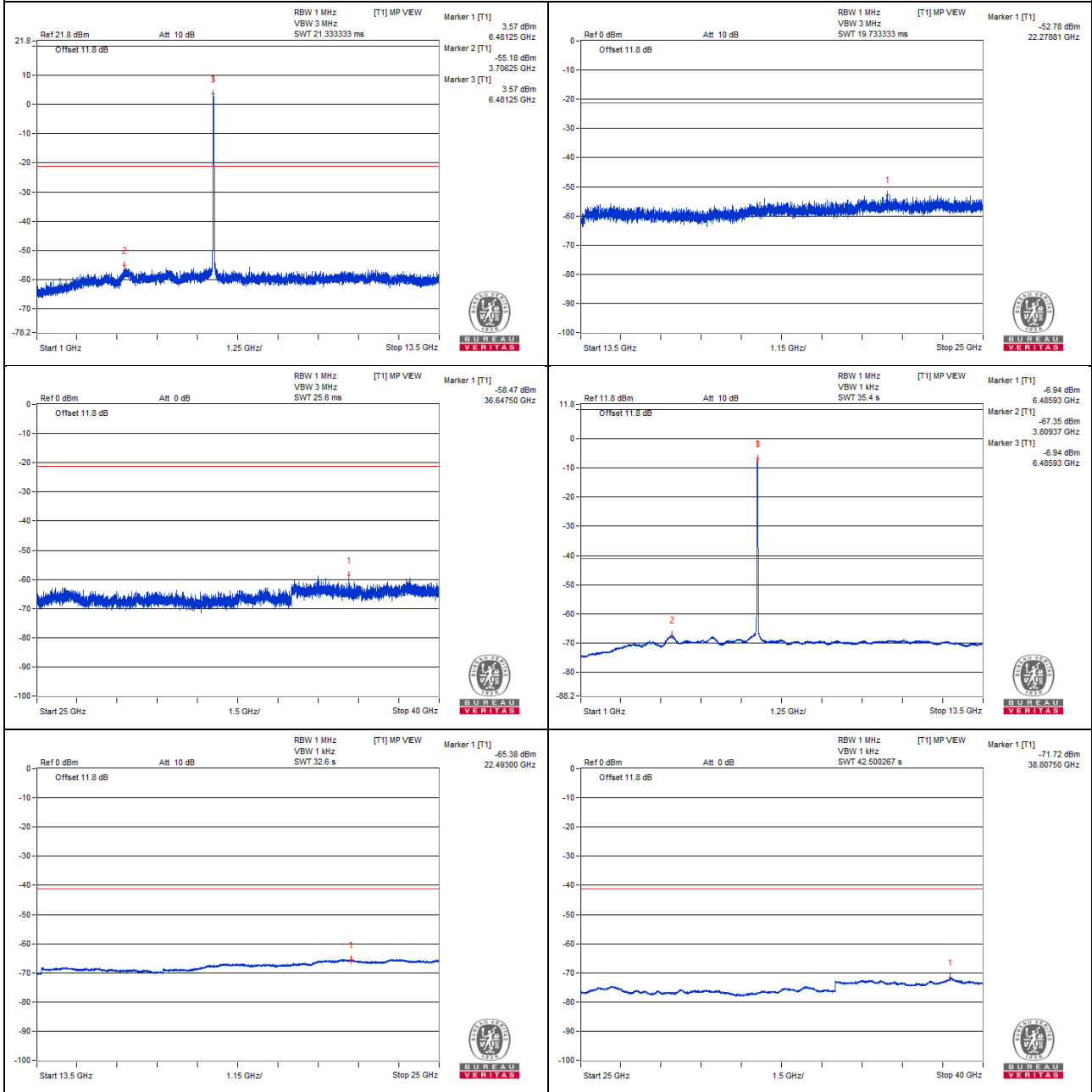

### 802.11be (EHT40) - Channel 115

#### Conducted spurious emission table

No.	Frequency (MHz)	Emission Level (dBuV/m)	Limit (dBuV/m)	Margin (dB)	Raw Value (dBm)	Correction Factor (dB)	EIRP Level (dBm)
1	#13059.37	40.77 PK	88.2	-47.43	-59.25	4.76	-54.49
2	#13054.68	29.45 AV	68.2	-38.75	-70.57	4.76	-65.81
3	19566.25	43.68 PK	74	-30.32	-56.34	4.76	-51.58
4	19584.93	32.55 AV	54	-21.45	-67.47	4.76	-62.71

#### Remarks:

1. Margin value = Emission Level – Limit value
2. The other emission levels were very low against the limit.
3. " # " : The frequency is out of the restricted band.

### Chain 0

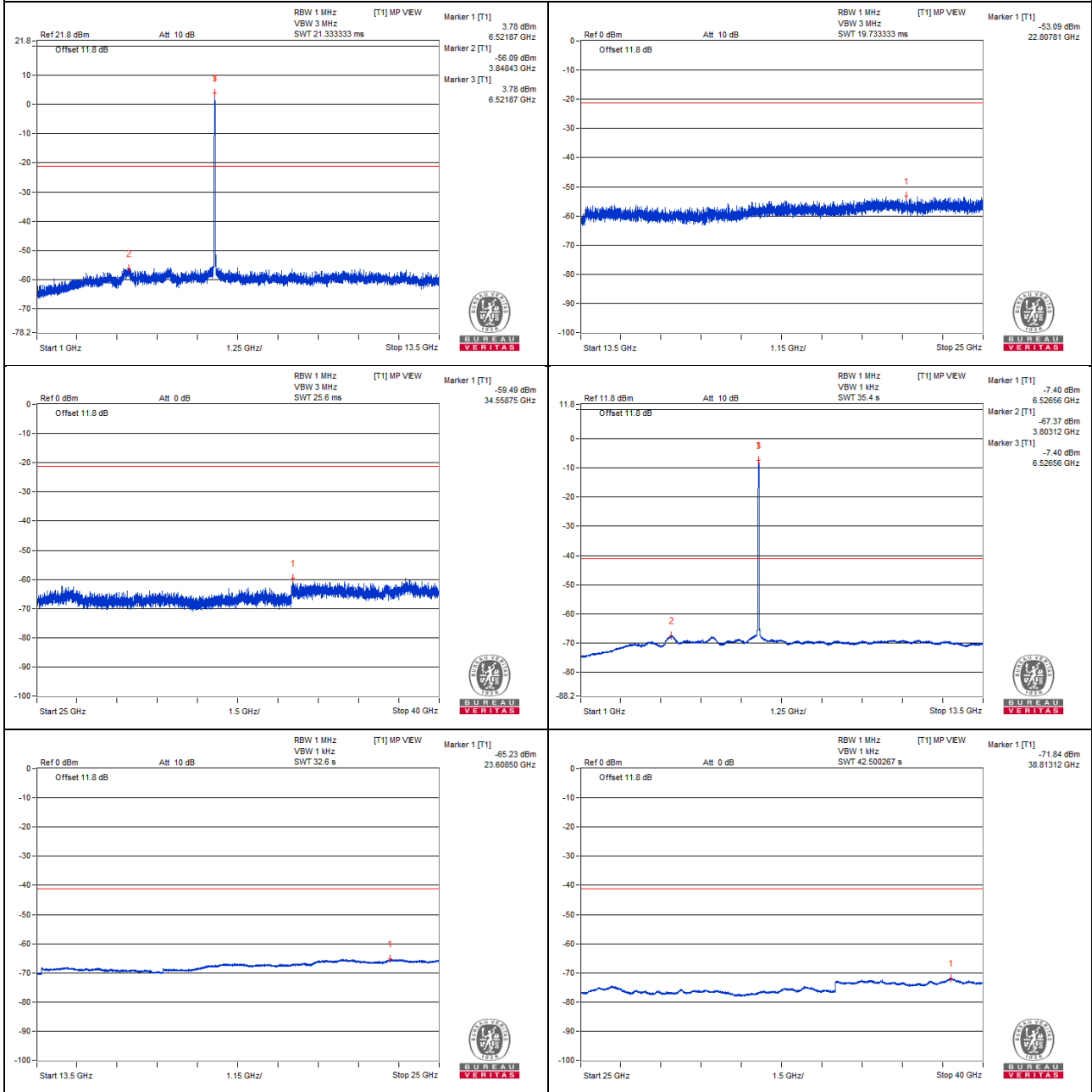

**802.11be (EHT40) - Channel 123**  
**Conducted spurious emission table**

No.	Frequency (MHz)	Emission Level (dBuV/m)	Limit (dBuV/m)	Margin (dB)	Raw Value (dBm)	Correction Factor (dB)	EIRP Level (dBm)
1	#13131.25	40.65 PK	88.2	-47.55	-59.37	4.76	-54.61
2	#13125	29.69 AV	68.2	-38.51	-70.33	4.76	-65.57
3	19687	42.33 PK	74	-31.67	-57.69	4.76	-52.93
4	19695.62	32.66 AV	54	-21.34	-67.36	4.76	-62.60

Remarks:

1. Margin value = Emission Level – Limit value
2. The other emission levels were very low against the limit.
3. " # " : The frequency is out of the restricted band.

### Chain 0

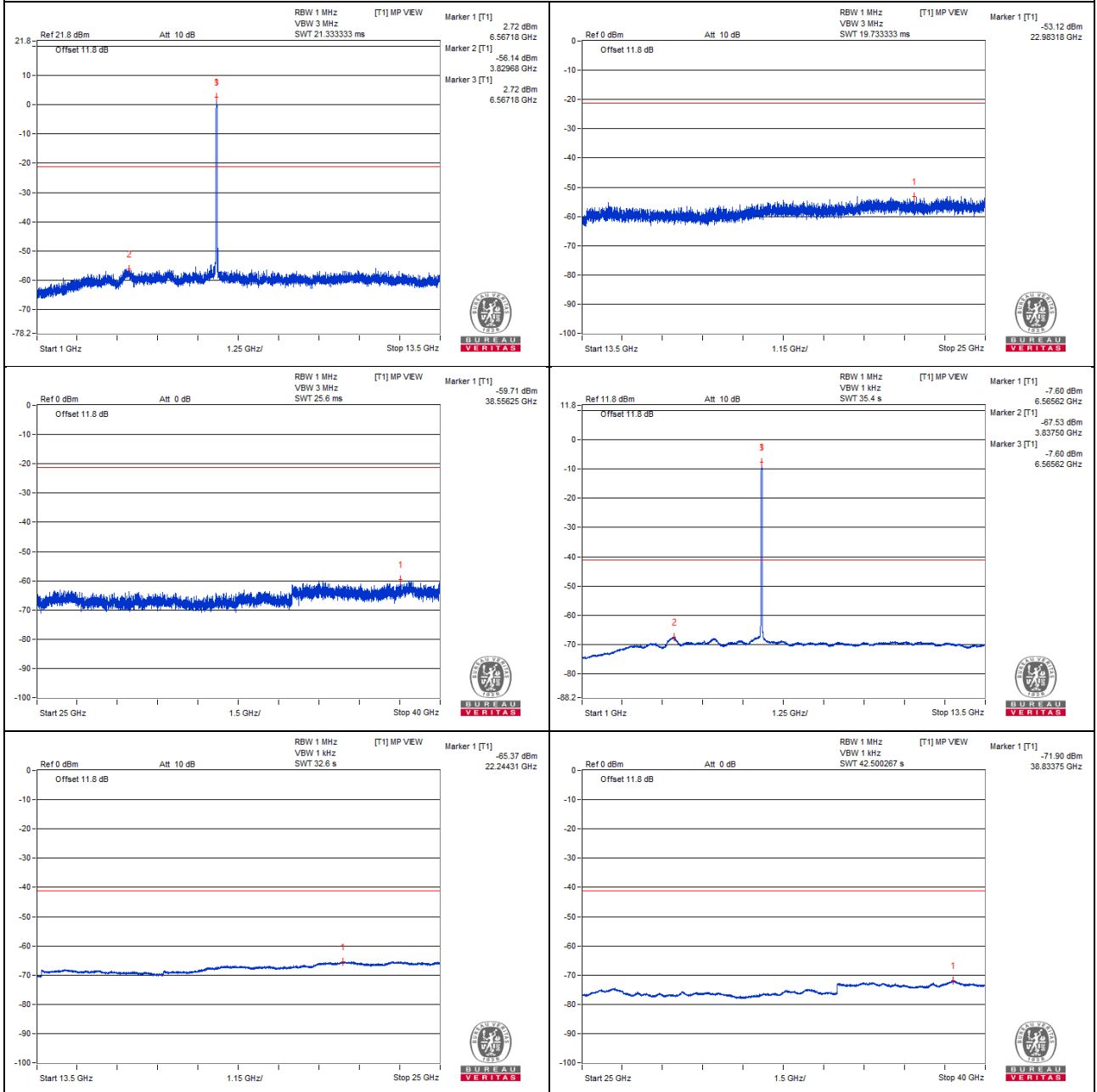

### 802.11be (EHT40) - Channel 155

#### Conducted spurious emission table

No.	Frequency (MHz)	Emission Level (dBuV/m)	Limit (dBuV/m)	Margin (dB)	Raw Value (dBm)	Correction Factor (dB)	EIRP Level (dBm)
1	#13443.75	41.21 PK	88.2	-46.99	-58.81	4.76	-54.05
2	#13457.81	29.86 AV	68.2	-38.34	-70.16	4.76	-65.40
3	20174.31	43.8 PK	74	-30.2	-56.22	4.76	-51.46
4	20181.5	32.74 AV	54	-21.26	-67.28	4.76	-62.52

#### Remarks:

1. Margin value = Emission Level – Limit value
2. The other emission levels were very low against the limit.

### Chain 0

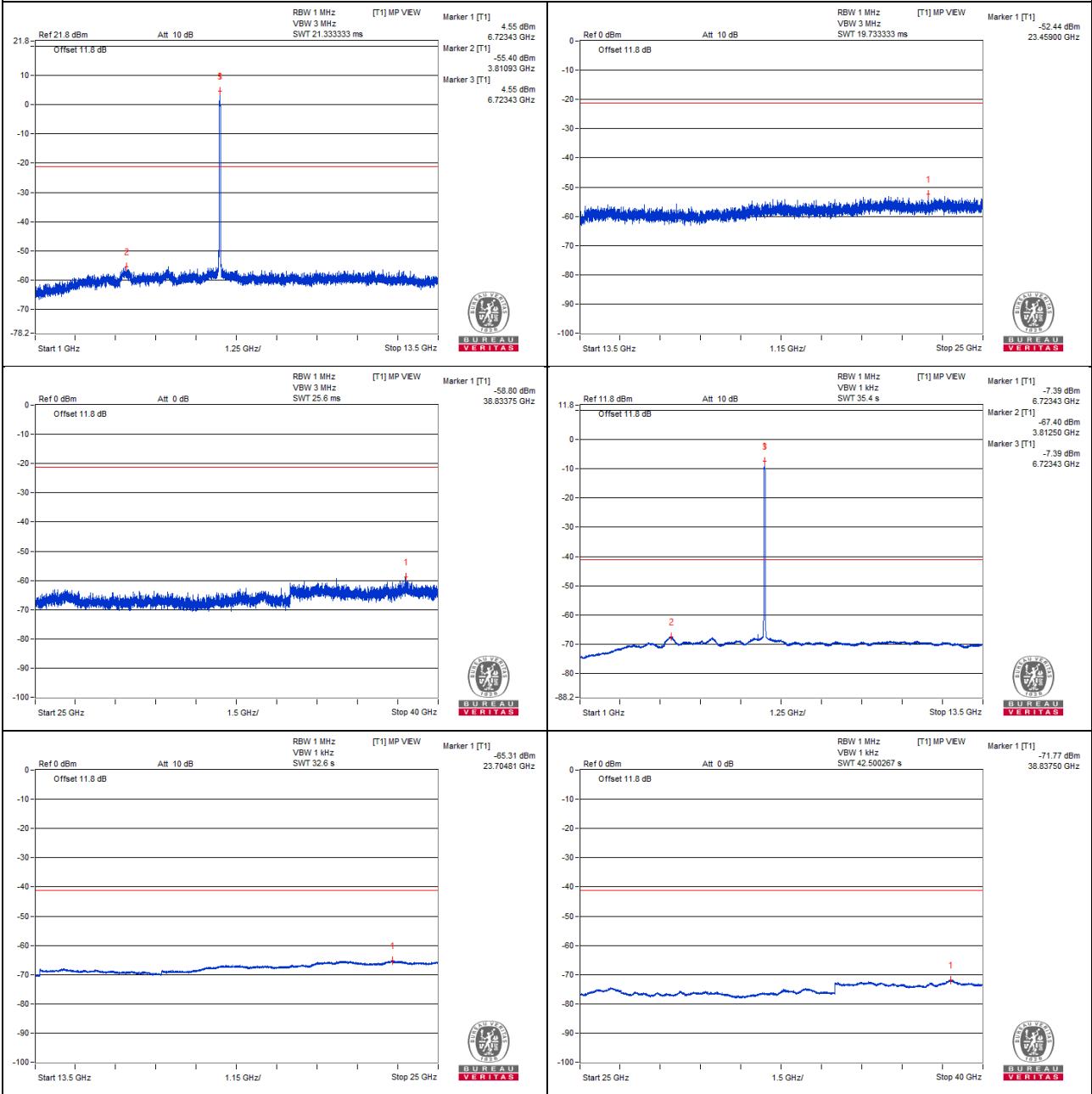

### 802.11be (EHT40) - Channel 179

#### Conducted spurious emission table

No.	Frequency (MHz)	Emission Level (dBuV/m)	Limit (dBuV/m)	Margin (dB)	Raw Value (dBm)	Correction Factor (dB)	EIRP Level (dBm)
1	#13699.81	42.21 PK	88.2	-45.99	-57.81	4.76	-53.05
2	#13681.12	31.26 AV	68.2	-36.94	-68.76	4.76	-64.00
3	20526.5	42.87 PK	74	-31.13	-57.15	4.76	-52.39
4	20525.06	32.61 AV	54	-21.39	-67.41	4.76	-62.65

#### Remarks:

1. Margin value = Emission Level – Limit value
2. The other emission levels were very low against the limit.
3. " # " : The frequency is out of the restricted band.



### Chain 0

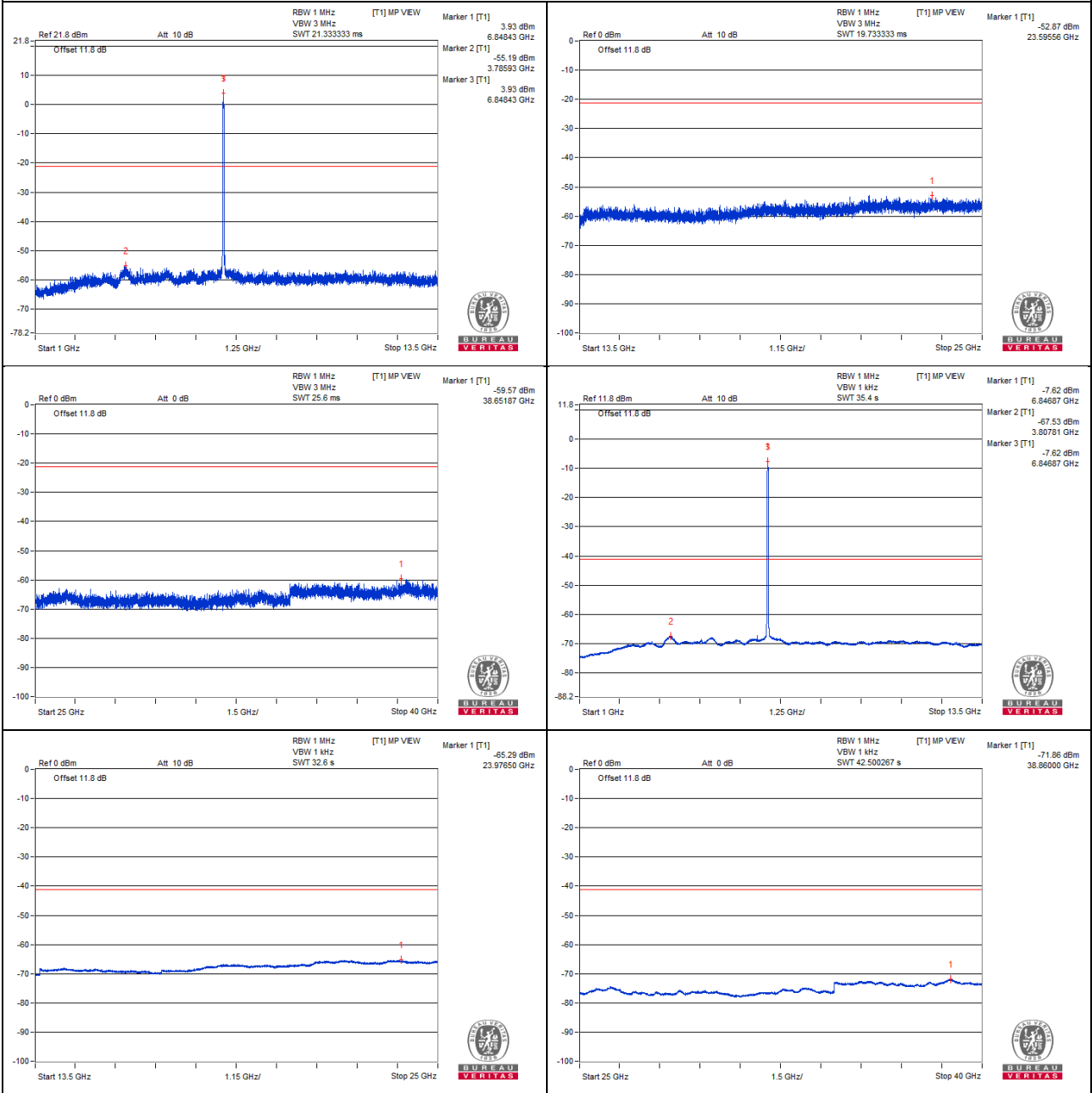

**802.11be (EHT40) - Channel 187**  
**Conducted spurious emission table**

No.	Frequency (MHz)	Emission Level (dBuV/m)	Limit (dBuV/m)	Margin (dB)	Raw Value (dBm)	Correction Factor (dB)	EIRP Level (dBm)
1	#13778.87	42.27 PK	88.2	-45.93	-57.75	4.76	-52.99
2	#13778.87	31.25 AV	68.2	-36.95	-68.77	4.76	-64.01
3	20657.31	43.22 PK	74	-30.78	-56.8	4.76	-52.04
4	20648.68	32.73 AV	54	-21.27	-67.29	4.76	-62.53

Remarks:

1. Margin value = Emission Level – Limit value
2. The other emission levels were very low against the limit.
3. " # " : The frequency is out of the restricted band.

### Chain 0

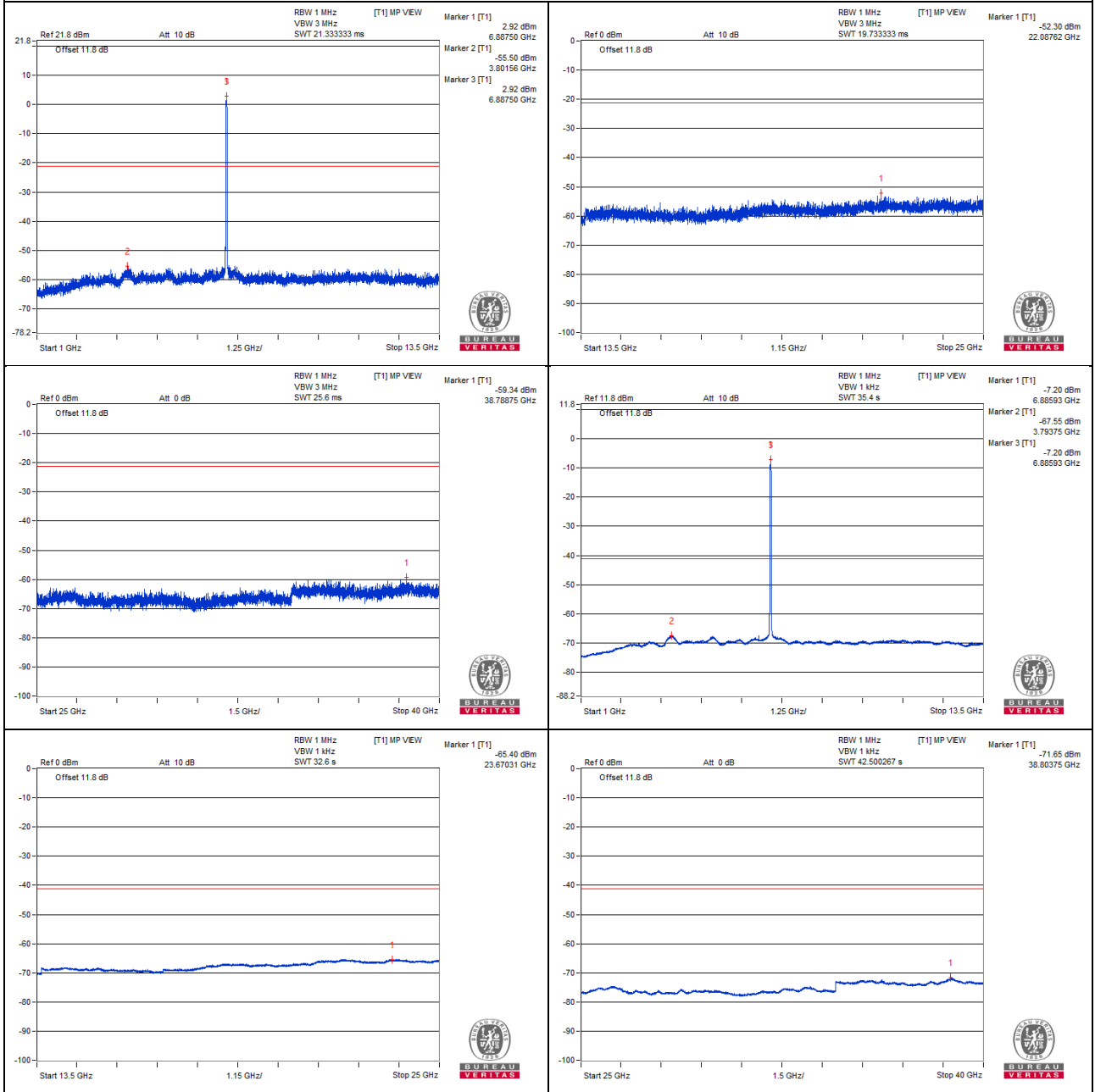

### 802.11be (EHT40) - Channel 211

#### Conducted spurious emission table

No.	Frequency (MHz)	Emission Level (dBuV/m)	Limit (dBuV/m)	Margin (dB)	Raw Value (dBm)	Correction Factor (dB)	EIRP Level (dBm)
1	#14007.43	43.33 PK	88.2	-44.87	-56.69	4.76	-51.93
2	#14008.87	31.41 AV	68.2	-36.79	-68.61	4.76	-63.85
3	21009.5	44.5 PK	74	-29.5	-55.52	4.76	-50.76
4	21013.81	32.94 AV	54	-21.06	-67.08	4.76	-62.32

#### Remarks:

1. Margin value = Emission Level – Limit value
2. The other emission levels were very low against the limit.
3. " # " : The frequency is out of the restricted band.

### Chain 0

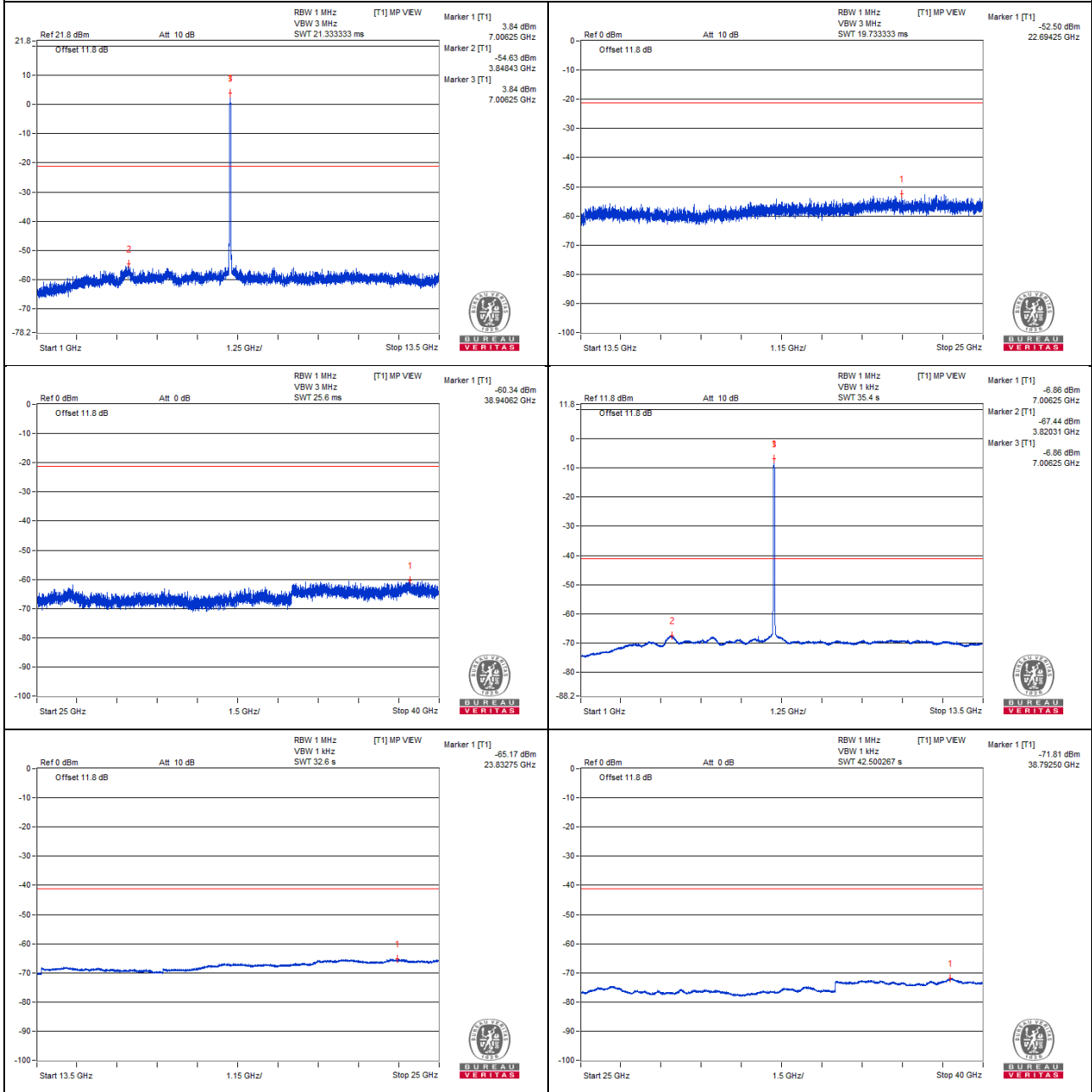

### 802.11be (EHT40) - Channel 227

#### Conducted spurious emission table

No.	Frequency (MHz)	Emission Level (dBuV/m)	Limit (dBuV/m)	Margin (dB)	Raw Value (dBm)	Correction Factor (dB)	EIRP Level (dBm)
1	#14169.87	41.84 PK	88.2	-46.36	-58.18	4.76	-53.42
2	#14179.93	31.43 AV	68.2	-36.77	-68.59	4.76	-63.83
3	21259.62	46.28 PK	74	-27.72	-53.74	4.76	-48.98
4	21263.93	33.17 AV	54	-20.83	-66.85	4.76	-62.09

#### Remarks:

1. Margin value = Emission Level – Limit value
2. The other emission levels were very low against the limit.
3. " # " : The frequency is out of the restricted band.

### Chain 0

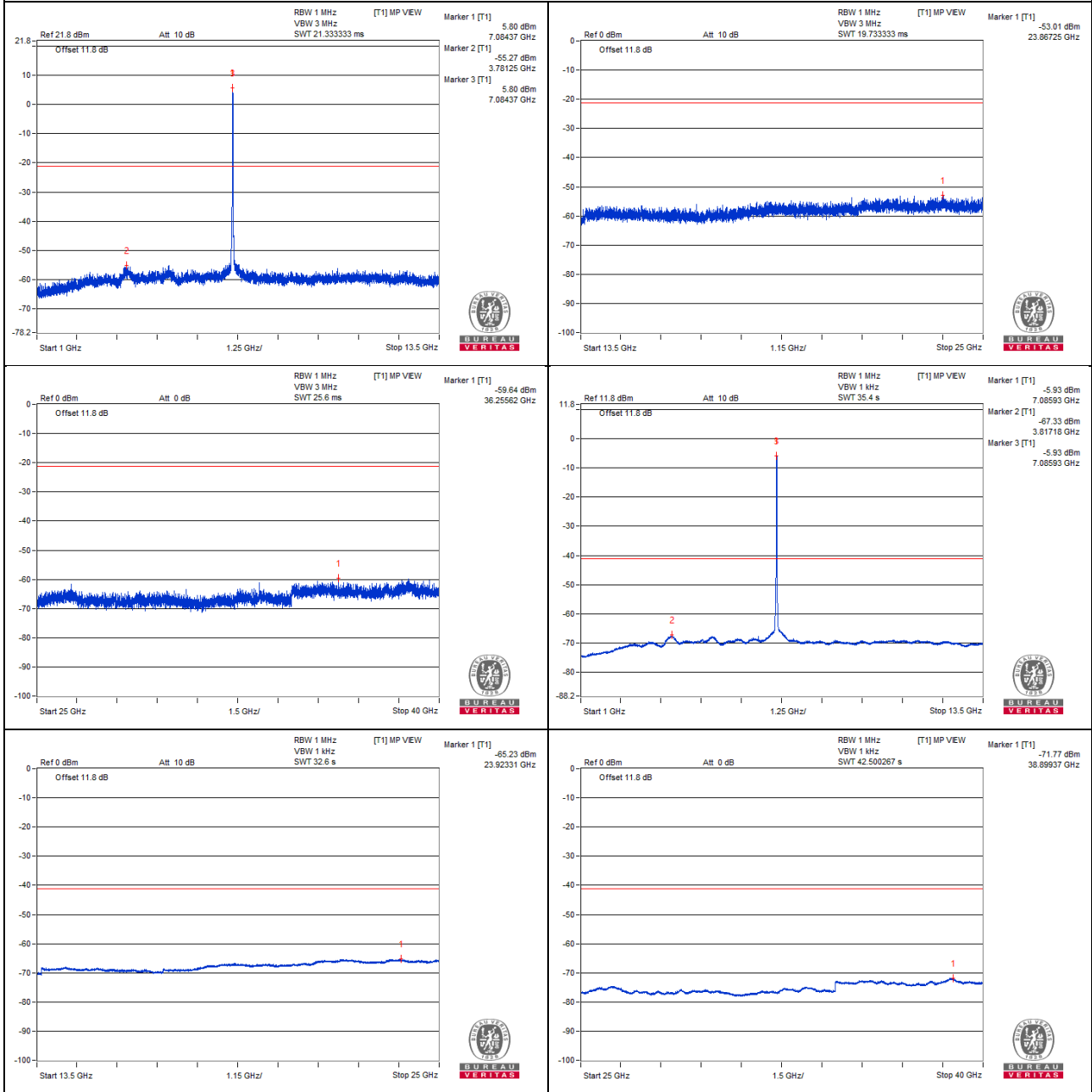

### Bandedge table

No.	Frequency (MHz)	Emission Level (dBuV/m)	Limit (dBuV/m)	Margin (dB)	Raw Value (dBm)	Correction Factor (dB)	EIRP Level (dBm)
1	#7148.32	52.53 PK	88.2	-35.67	-46.82	4.09	-42.73
2	#7125.45	41.05 AV	68.2	-27.15	-58.3	4.09	-54.21

#### Remarks:

1. Margin value = Emission Level – Limit value
2. The other emission levels were very low against the limit.
3. " # " : The frequency is out of the restricted band.

### Chain 0

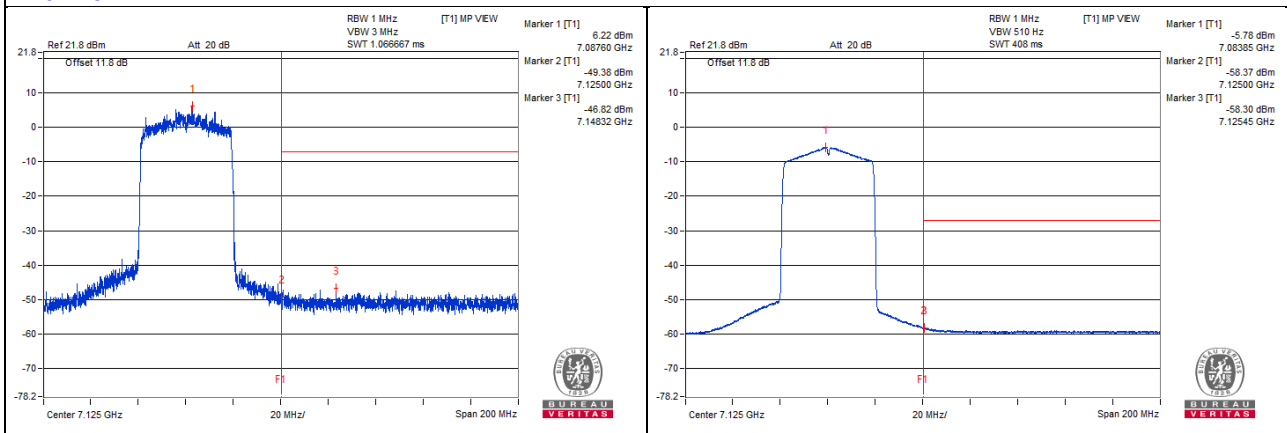



### 802.11be (EHT80) - Channel 7

#### Conducted spurious emission table

No.	Frequency (MHz)	Emission Level (dBuV/m)	Limit (dBuV/m)	Margin (dB)	Raw Value (dBm)	Correction Factor (dB)	EIRP Level (dBm)
1	11965.62	41.5 PK	74	-32.5	-58.52	4.76	-53.76
2	11965.62	30.04 AV	54	-23.96	-69.98	4.76	-65.22
3	17954.81	40.85 PK	74	-33.15	-59.17	4.76	-54.41
4	17962	31.12 AV	54	-22.88	-68.9	4.76	-64.14

#### Remarks:

1. Margin value = Emission Level – Limit value
2. The other emission levels were very low against the limit.

### Chain 0

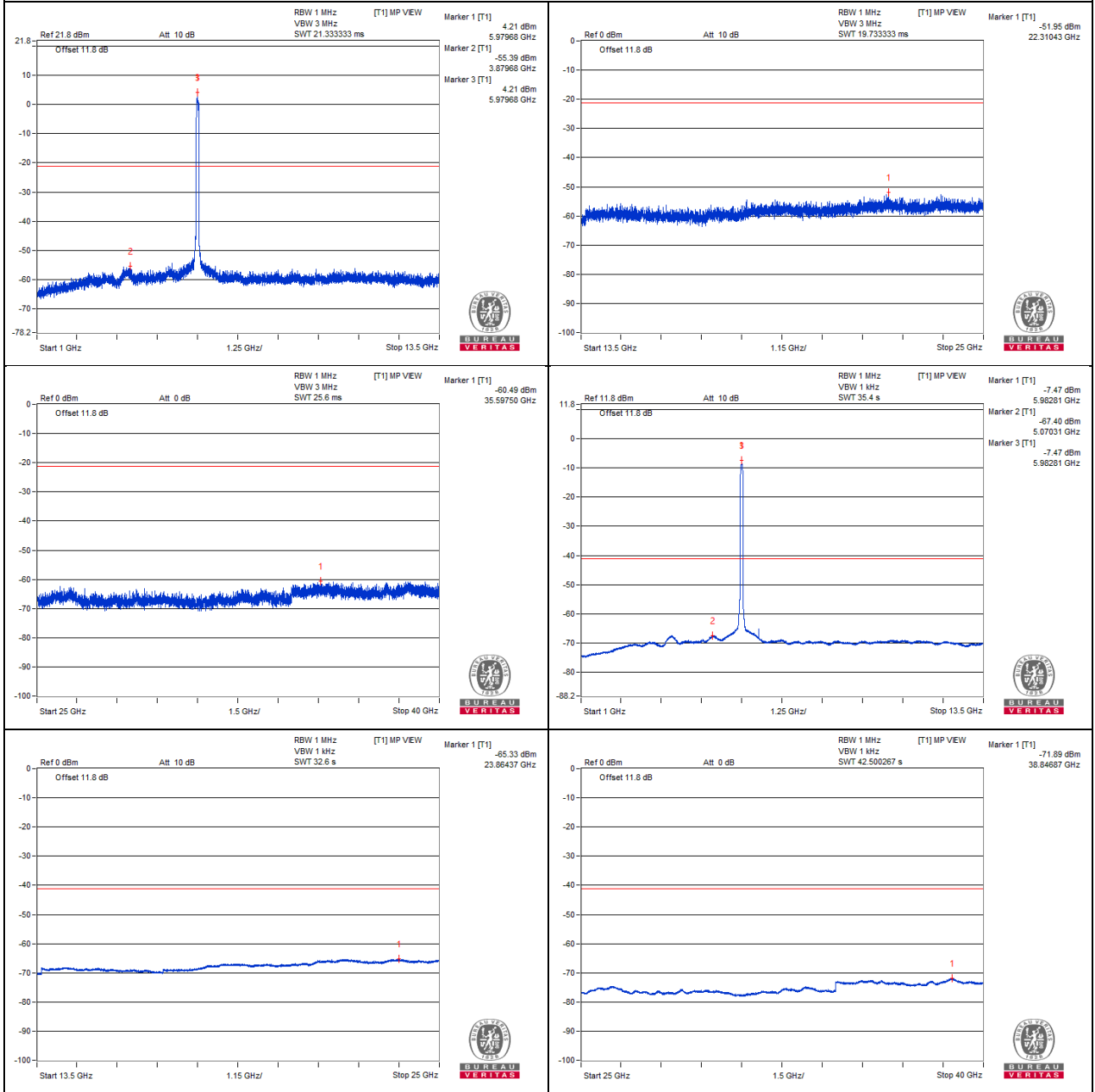

### Bandedge table

No.	Frequency (MHz)	Emission Level (dBuV/m)	Limit (dBuV/m)	Margin (dB)	Raw Value (dBm)	Correction Factor (dB)	EIRP Level (dBm)
1	#5924.95	59.37 PK	88.2	-28.83	-40.65	4.76	-35.89
2	#5924.85	46.44 AV	68.2	-21.76	-53.58	4.76	-48.82

#### Remarks:

1. Margin value = Emission Level – Limit value
2. The other emission levels were very low against the limit.
3. " # " : The frequency is out of the restricted band.

### Chain 0

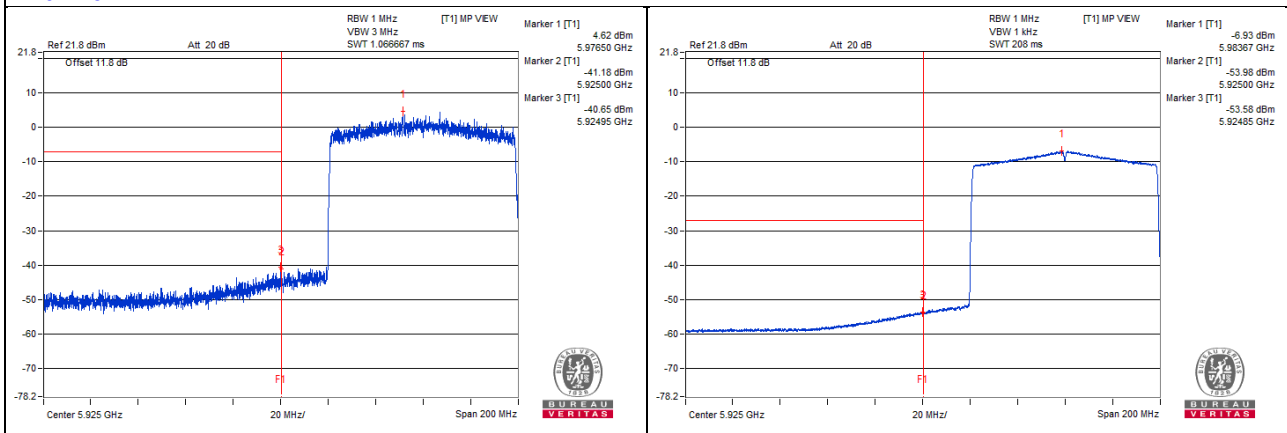

**802.11be (EHT80) - Channel 39****Conducted spurious emission table**

No.	Frequency (MHz)	Emission Level (dBuV/m)	Limit (dBuV/m)	Margin (dB)	Raw Value (dBm)	Correction Factor (dB)	EIRP Level (dBm)
1	12289.06	42.27 PK	74	-31.73	-57.75	4.76	-52.99
2	12293.75	30.43 AV	54	-23.57	-69.59	4.76	-64.83
3	18445	43.64 PK	74	-30.36	-56.38	4.76	-51.62
4	18432.06	32.46 AV	54	-21.54	-67.56	4.76	-62.80

## Remarks:

1. Margin value = Emission Level – Limit value
2. The other emission levels were very low against the limit.

### Chain 0

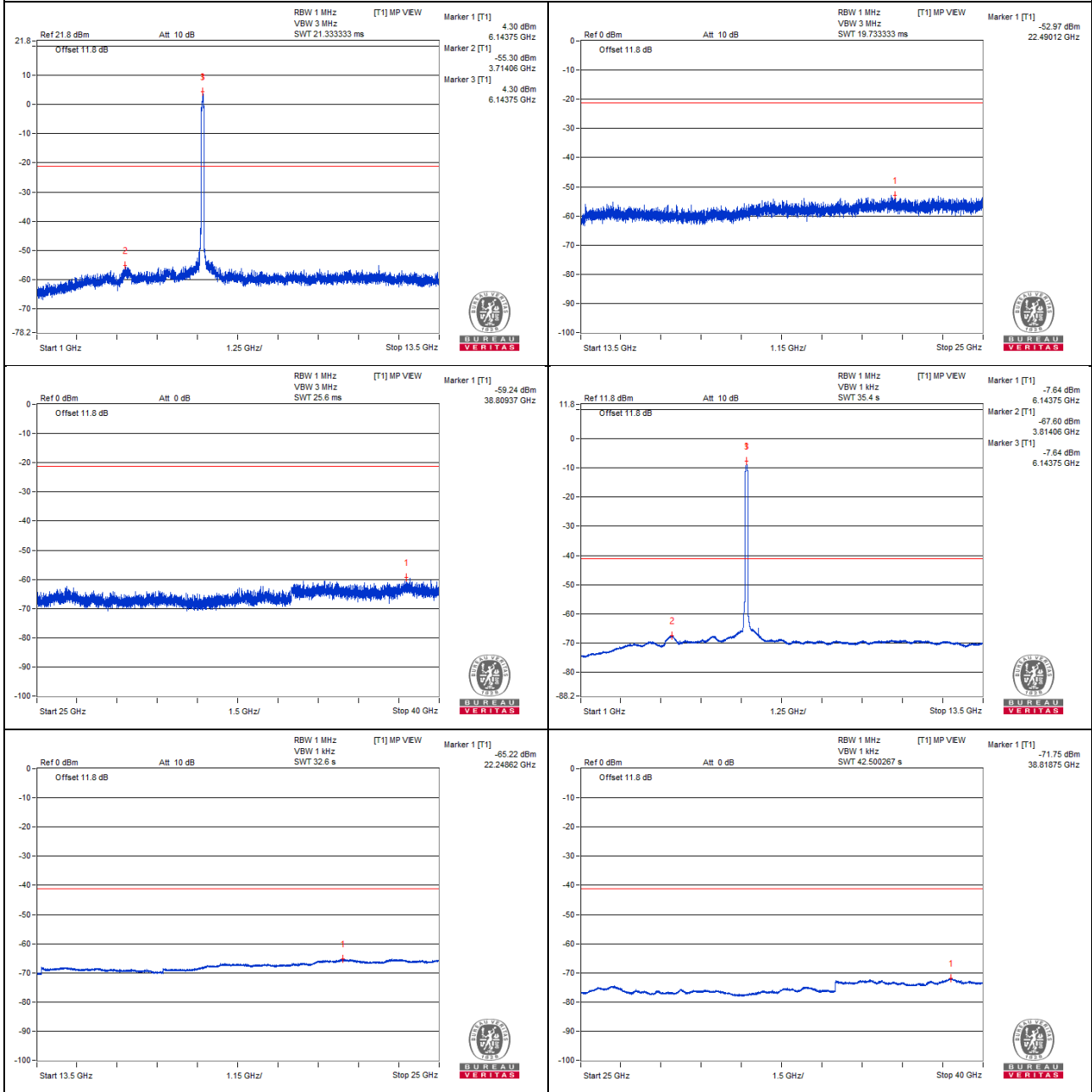

### 802.11be (EHT80) - Channel 87

#### Conducted spurious emission table

No.	Frequency (MHz)	Emission Level (dBuV/m)	Limit (dBuV/m)	Margin (dB)	Raw Value (dBm)	Correction Factor (dB)	EIRP Level (dBm)
1	#12762.5	41.81 PK	88.2	-46.39	-58.21	4.76	-53.45
2	#12764.06	30 AV	68.2	-38.2	-70.02	4.76	-65.26
3	19153.68	44.42 PK	74	-29.58	-55.6	4.76	-50.84
4	19158	33.31 AV	54	-20.69	-66.71	4.76	-61.95

#### Remarks:

1. Margin value = Emission Level – Limit value
2. The other emission levels were very low against the limit.
3. " # " : The frequency is out of the restricted band.

### Chain 0

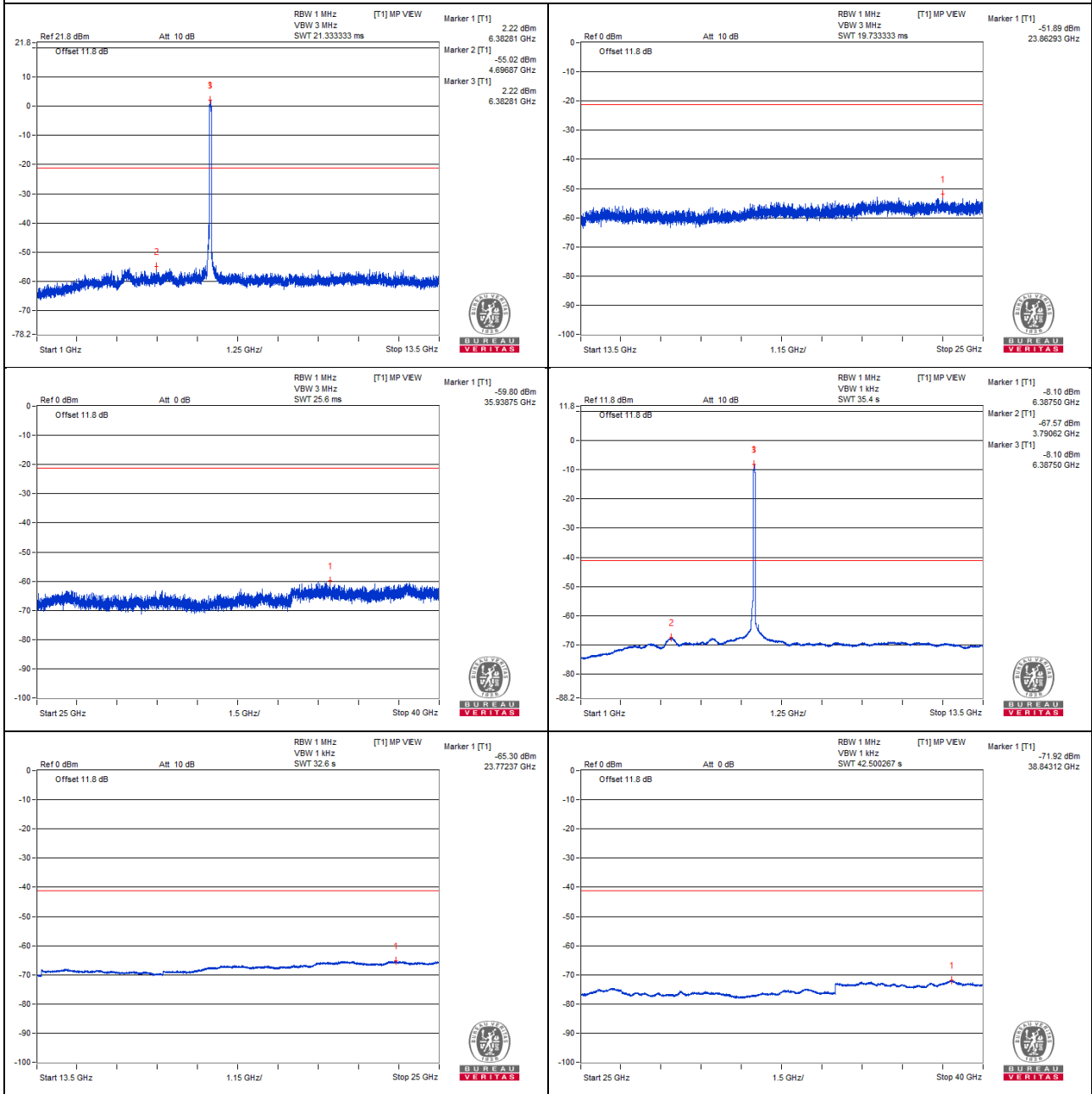

**802.11be (EHT80) - Channel 103**  
**Conducted spurious emission table**

No.	Frequency (MHz)	Emission Level (dBuV/m)	Limit (dBuV/m)	Margin (dB)	Raw Value (dBm)	Correction Factor (dB)	EIRP Level (dBm)
1	#12931.25	41.15 PK	88.2	-47.05	-58.87	4.76	-54.11
2	#12937.5	29.15 AV	68.2	-39.05	-70.87	4.76	-66.11
3	19390.87	44.77 PK	74	-29.23	-55.25	4.76	-50.49
4	19393.75	32.88 AV	54	-21.12	-67.14	4.76	-62.38

Remarks:

1. Margin value = Emission Level – Limit value
2. The other emission levels were very low against the limit.
3. " # " : The frequency is out of the restricted band.



### Chain 0

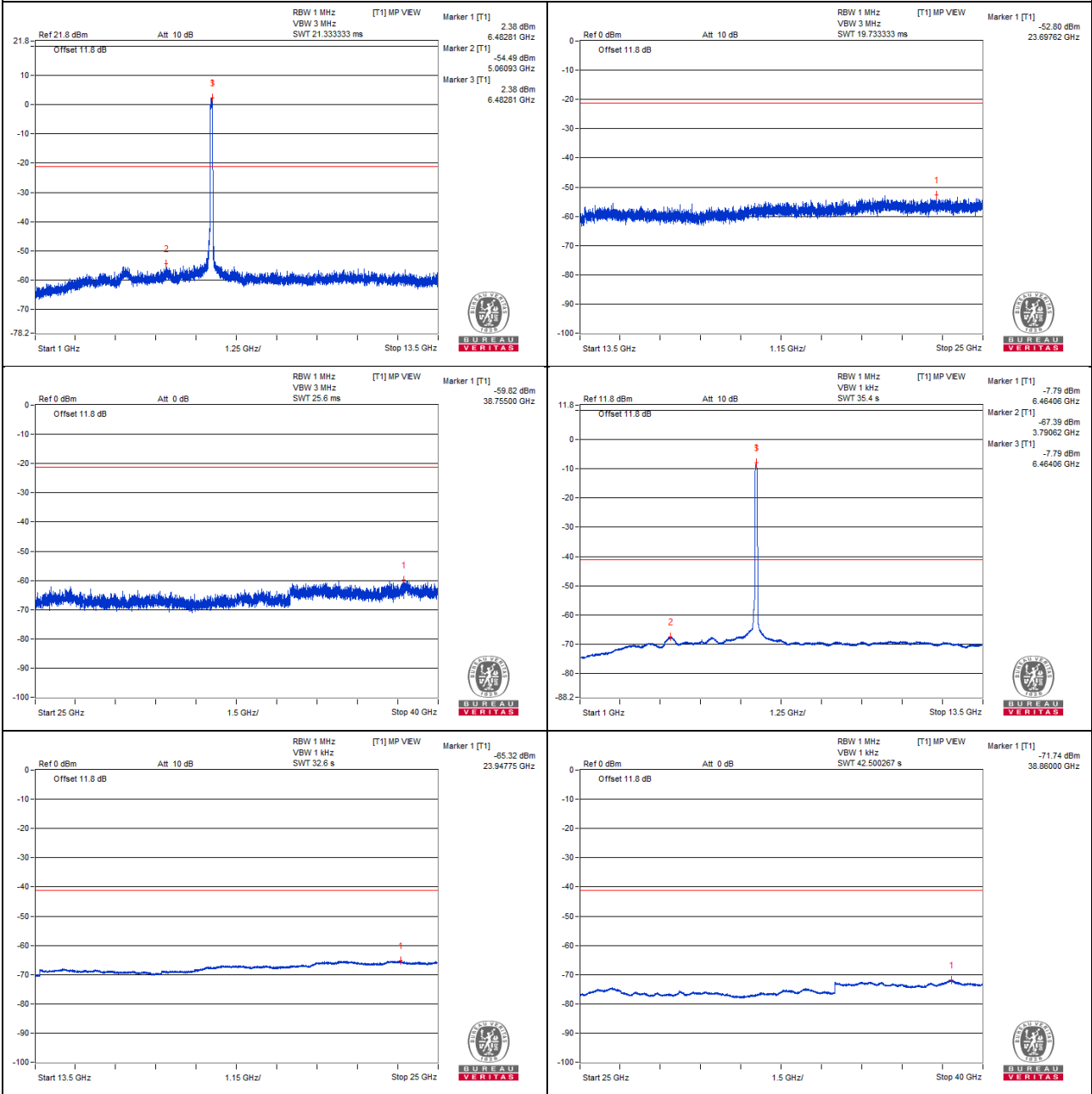

### 802.11be (EHT80) - Channel 119

#### Conducted spurious emission table

No.	Frequency (MHz)	Emission Level (dBuV/m)	Limit (dBuV/m)	Margin (dB)	Raw Value (dBm)	Correction Factor (dB)	EIRP Level (dBm)
1	#13092.18	41.03 PK	88.2	-47.17	-58.99	4.76	-54.23
2	#13087.5	29.59 AV	68.2	-38.61	-70.43	4.76	-65.67
3	19635.25	44.95 PK	74	-29.05	-55.07	4.76	-50.31
4	19629.5	32.62 AV	54	-21.38	-67.4	4.76	-62.64

#### Remarks:

1. Margin value = Emission Level – Limit value
2. The other emission levels were very low against the limit.
3. " # " : The frequency is out of the restricted band.

### Chain 0

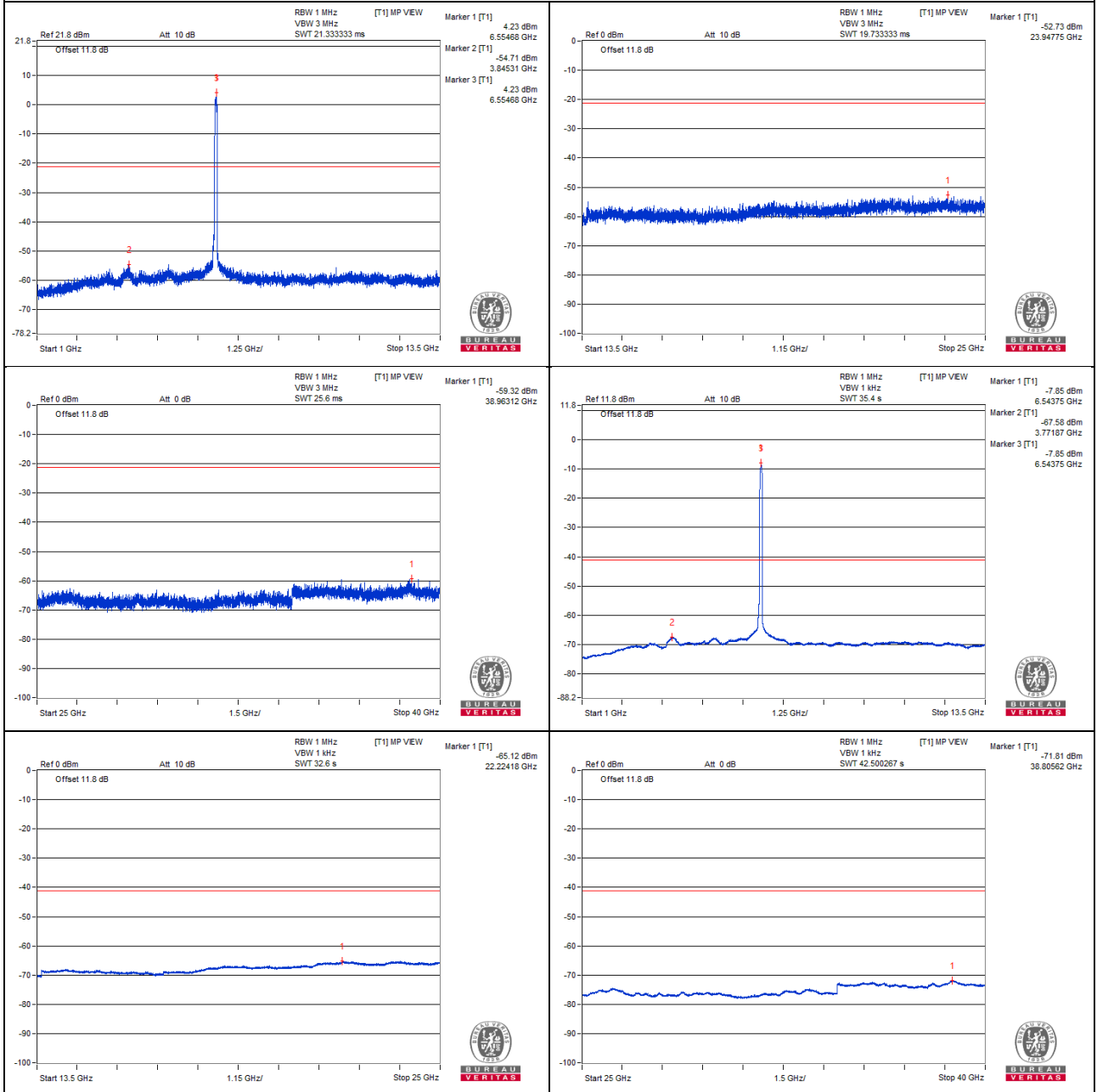

**802.11be (EHT80) - Channel 135**  
**Conducted spurious emission table**

No.	Frequency (MHz)	Emission Level (dBuV/m)	Limit (dBuV/m)	Margin (dB)	Raw Value (dBm)	Correction Factor (dB)	EIRP Level (dBm)
1	#13248.43	40.86 PK	88.2	-47.34	-59.16	4.76	-54.40
2	13248.43	29.79 AV	68.2	-38.41	-70.23	4.76	-65.47
3	19878.18	43 PK	74	-31	-57.02	4.76	-52.26
4	19881.06	32.69 AV	54	-21.31	-67.33	4.76	-62.57

Remarks:

1. Margin value = Emission Level – Limit value
2. The other emission levels were very low against the limit.
3. " # " : The frequency is out of the restricted band.

### Chain 0

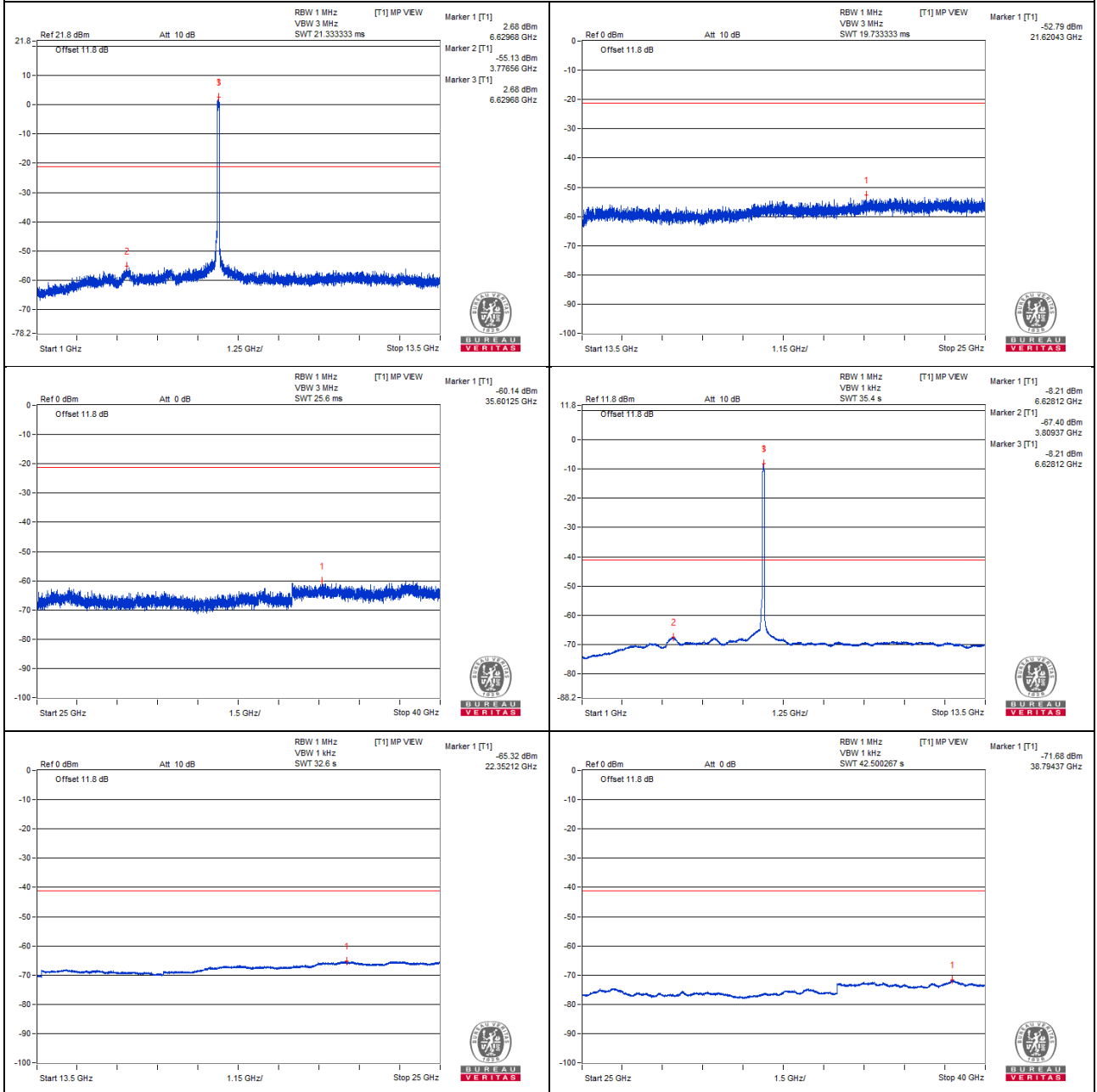

**802.11be (EHT80) - Channel 151**  
**Conducted spurious emission table**

No.	Frequency (MHz)	Emission Level (dBuV/m)	Limit (dBuV/m)	Margin (dB)	Raw Value (dBm)	Correction Factor (dB)	EIRP Level (dBm)
1	#13410.93	41.45 PK	88.2	-46.75	-58.57	4.76	-53.81
2	#13410.93	29.73 AV	68.2	-38.47	-70.29	4.76	-65.53
3	20122.56	43.53 PK	74	-30.47	-56.49	4.76	-51.73
4	20106.75	32.96 AV	54	-21.04	-67.06	4.76	-62.30

Remarks:

1. Margin value = Emission Level – Limit value
2. The other emission levels were very low against the limit.

### Chain 0

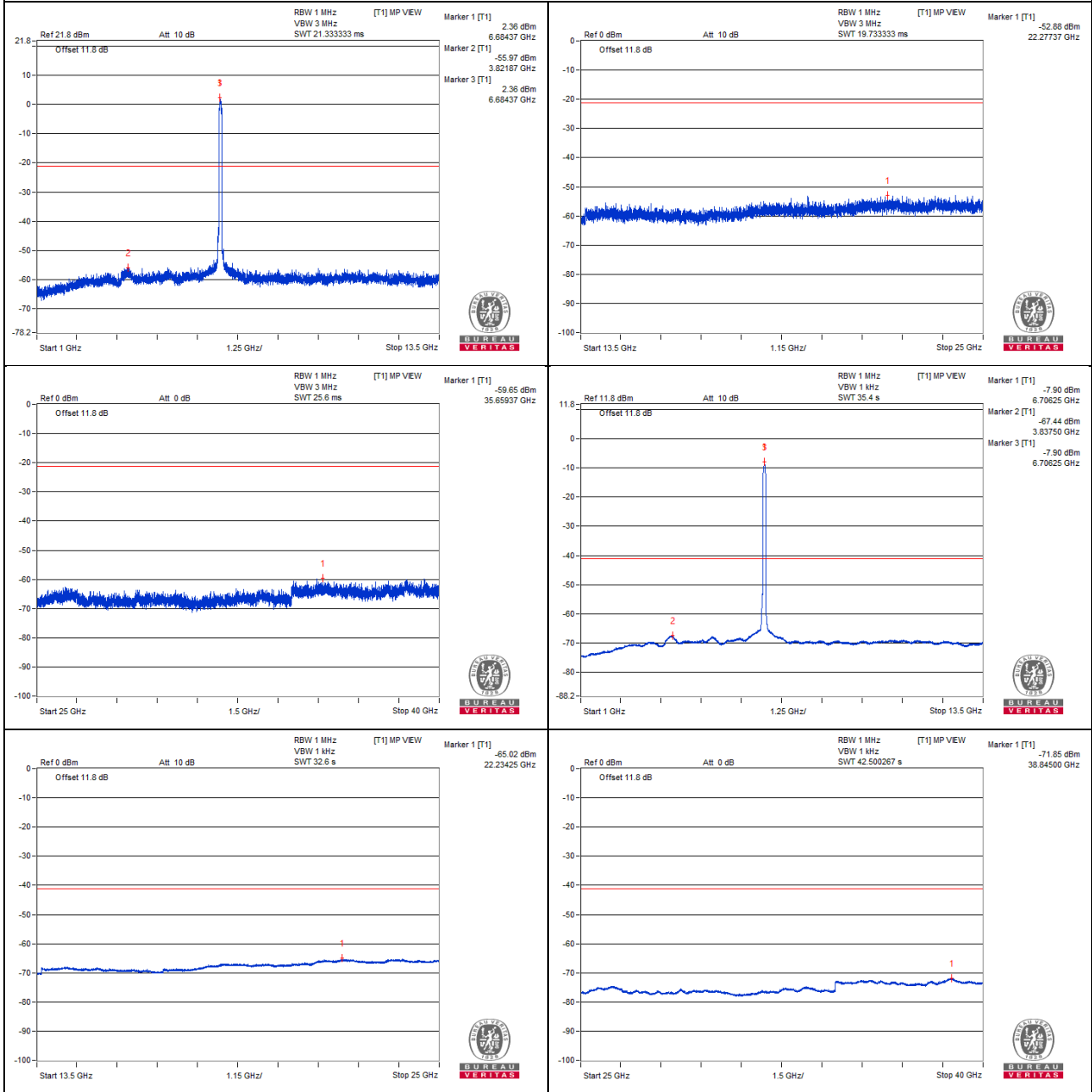

**802.11be (EHT80) - Channel 167**  
**Conducted spurious emission table**

No.	Frequency (MHz)	Emission Level (dBuV/m)	Limit (dBuV/m)	Margin (dB)	Raw Value (dBm)	Correction Factor (dB)	EIRP Level (dBm)
1	#13576.18	41.57 PK	88.2	-46.63	-58.45	4.76	-53.69
2	#13570.43	29.86 AV	68.2	-38.34	-70.16	4.76	-65.40
3	20359.75	43.34 PK	74	-30.66	-56.68	4.76	-51.92
4	20355.43	32.5 AV	54	-21.5	-67.52	4.76	-62.76

Remarks:

1. Margin value = Emission Level – Limit value
2. The other emission levels were very low against the limit.
3. " # " : The frequency is out of the restricted band.



### Chain 0

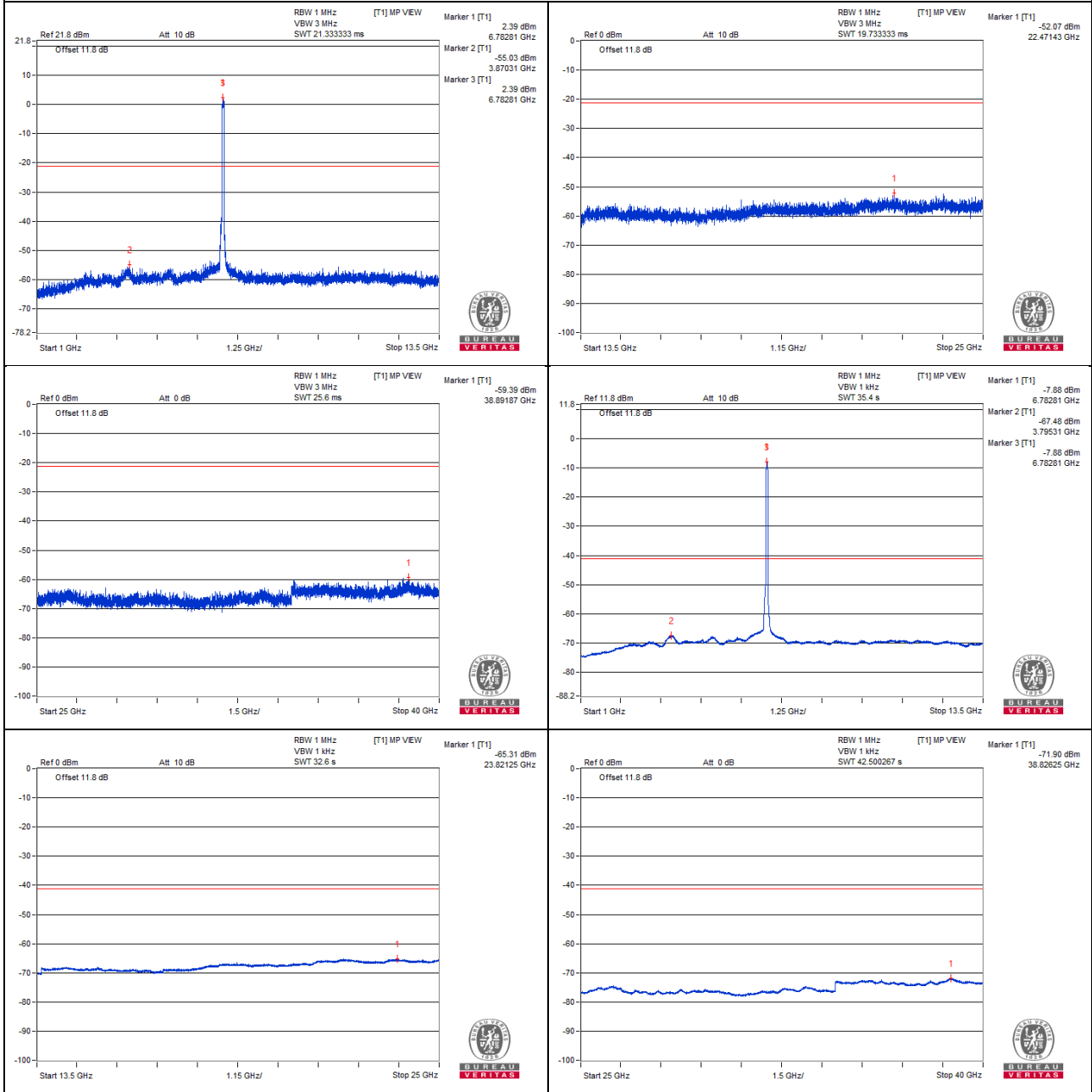

**802.11be (EHT80) - Channel 183**  
**Conducted spurious emission table**

No.	Frequency (MHz)	Emission Level (dBuV/m)	Limit (dBuV/m)	Margin (dB)	Raw Value (dBm)	Correction Factor (dB)	EIRP Level (dBm)
1	#13738.62	42.82 PK	88.2	-45.38	-57.2	4.76	-52.44
2	#13731.43	31.31 AV	68.2	-36.89	-68.71	4.76	-63.95
3	20591.18	42.82 PK	74	-31.18	-57.2	4.76	-52.44
4	20585.43	32.58 AV	54	-21.42	-67.44	4.76	-62.68

Remarks:

1. Margin value = Emission Level – Limit value
2. The other emission levels were very low against the limit.
3. " # " : The frequency is out of the restricted band.

### Chain 0

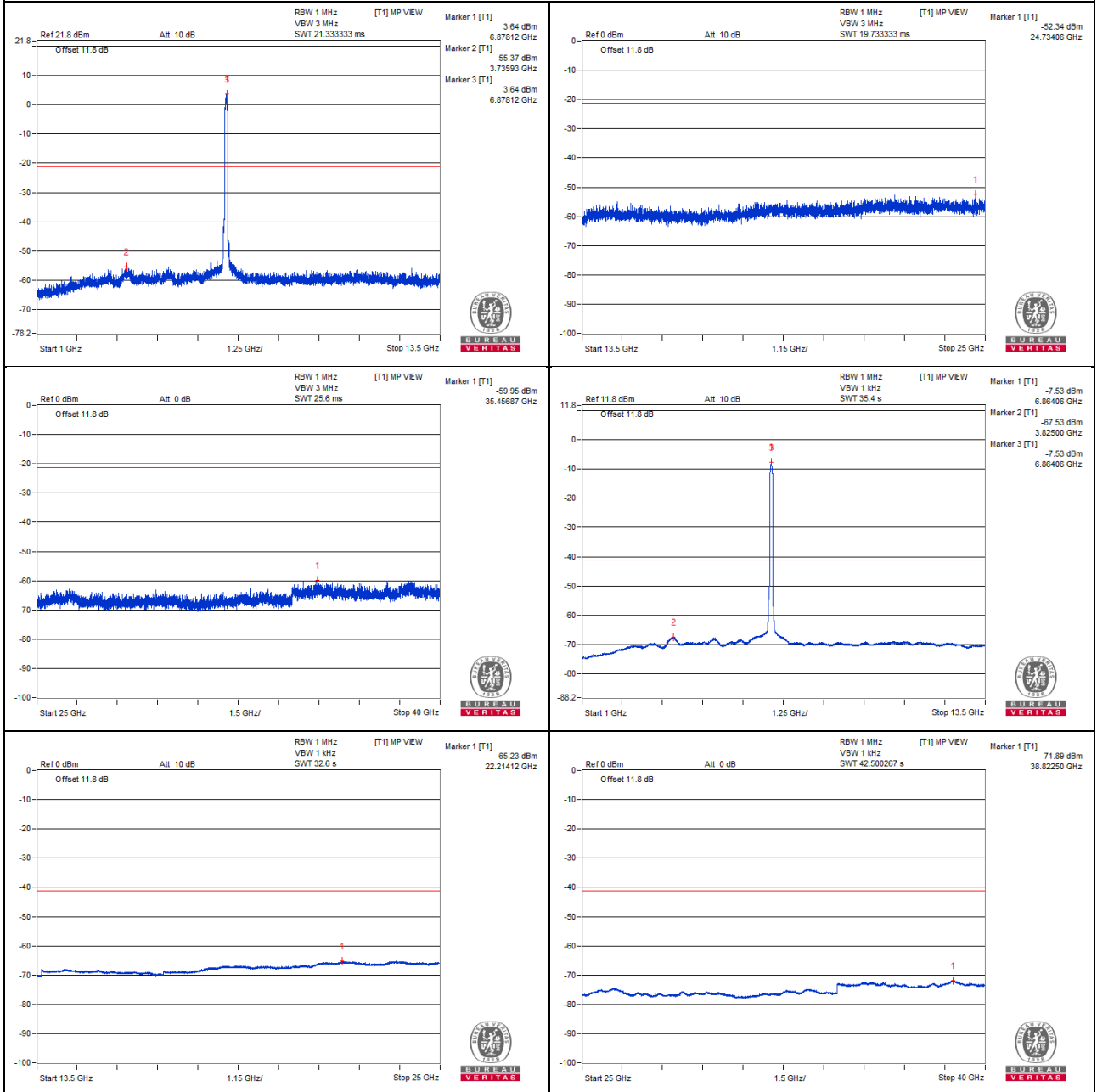

**802.11be (EHT80) - Channel 199**  
**Conducted spurious emission table**

No.	Frequency (MHz)	Emission Level (dBuV/m)	Limit (dBuV/m)	Margin (dB)	Raw Value (dBm)	Correction Factor (dB)	EIRP Level (dBm)
1	#13889.56	42.64 PK	88.2	-45.56	-57.38	4.76	-52.62
2	#13885.25	31.32 AV	68.2	-36.88	-68.7	4.76	-63.94
3	20841.31	43.1 PK	74	-30.9	-56.92	4.76	-52.16
4	20828.37	33.18 AV	54	-20.82	-66.84	4.76	-62.08

Remarks:

1. Margin value = Emission Level – Limit value
2. The other emission levels were very low against the limit.
3. " # " : The frequency is out of the restricted band.

### Chain 0

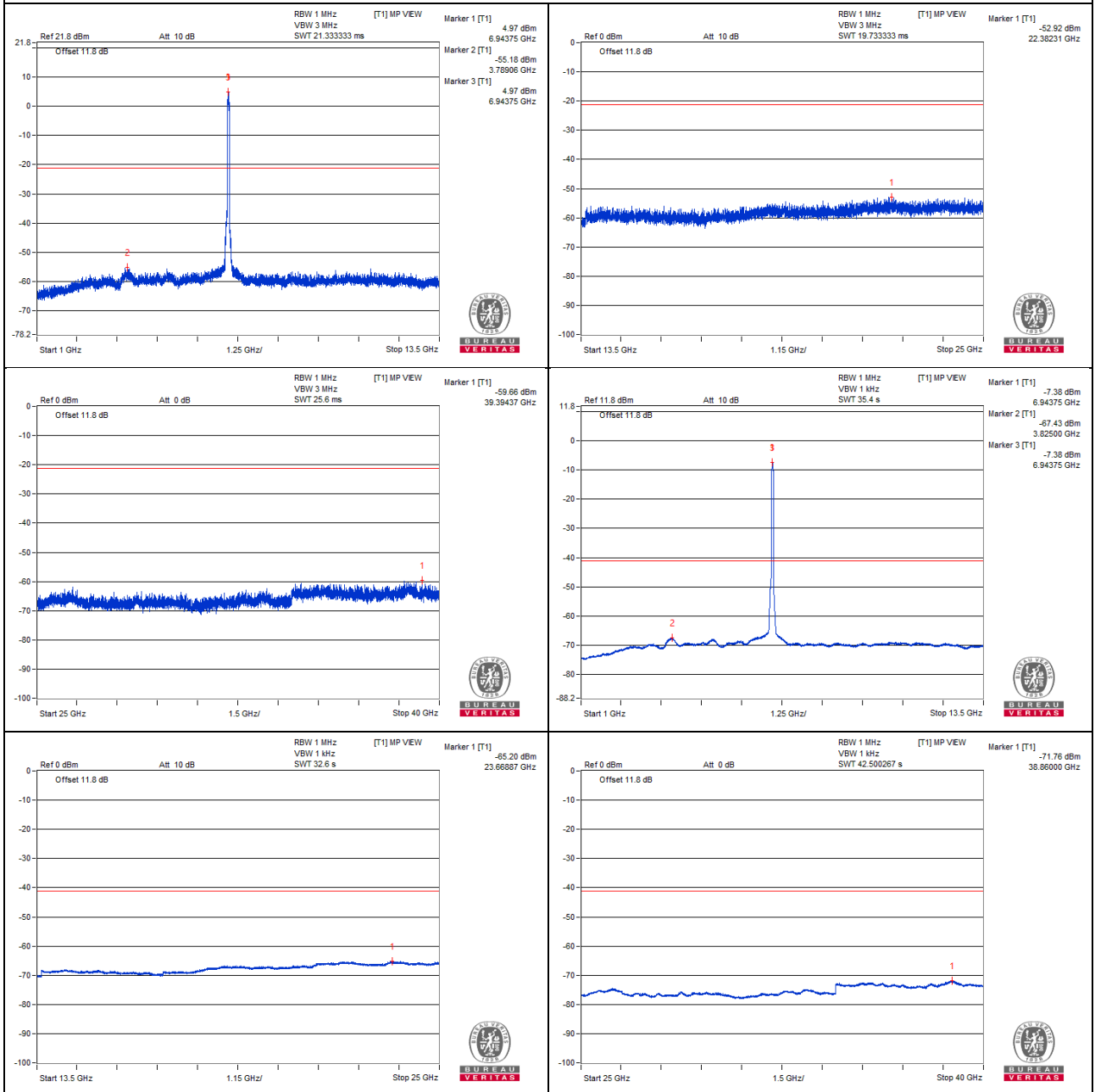

**802.11be (EHT80) - Channel 215**  
**Conducted spurious emission table**

No.	Frequency (MHz)	Emission Level (dBuV/m)	Limit (dBuV/m)	Margin (dB)	Raw Value (dBm)	Correction Factor (dB)	EIRP Level (dBm)
1	#14043.37	41.7 PK	88.2	-46.5	-58.32	4.76	-53.56
2	#14052	31.53 AV	68.2	-36.67	-68.49	4.76	-63.73
3	21079.93	44.37 PK	74	-29.63	-55.65	4.76	-50.89
4	21081.37	33.26 AV	54	-20.74	-66.76	4.76	-62.00

Remarks:

1. Margin value = Emission Level – Limit value
2. The other emission levels were very low against the limit.
3. " # " : The frequency is out of the restricted band.

### Chain 0

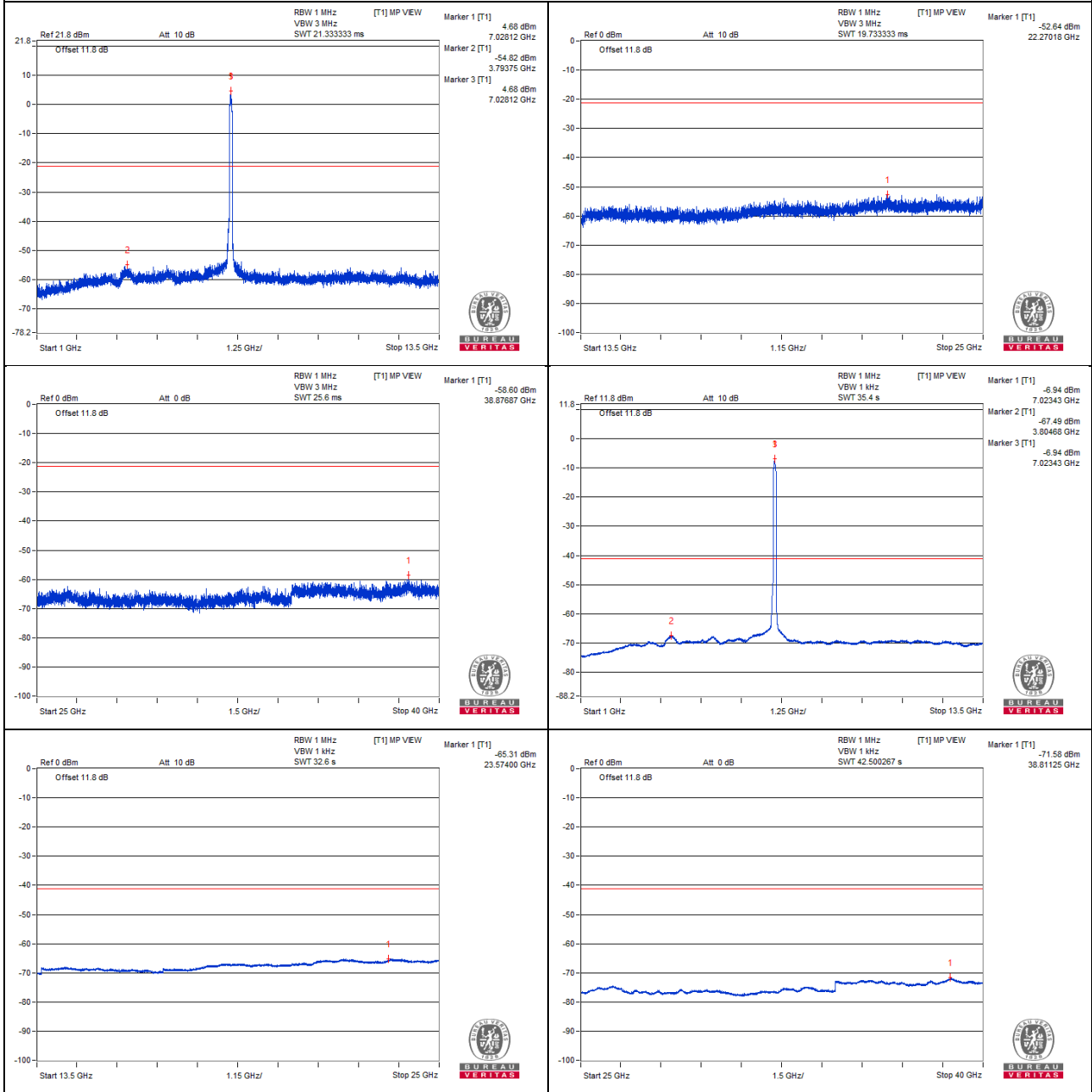

### Bandedge table

No.	Frequency (MHz)	Emission Level (dBuV/m)	Limit (dBuV/m)	Margin (dB)	Raw Value (dBm)	Correction Factor (dB)	EIRP Level (dBm)
1	#7169.97	52.57 PK	88.2	-35.63	-46.78	4.09	-42.69
2	#7166.52	40.97 AV	68.2	-27.23	-58.38	4.09	-54.29

#### Remarks:

1. Margin value = Emission Level – Limit value
2. The other emission levels were very low against the limit.
3. " # " : The frequency is out of the restricted band.

### Chain 0

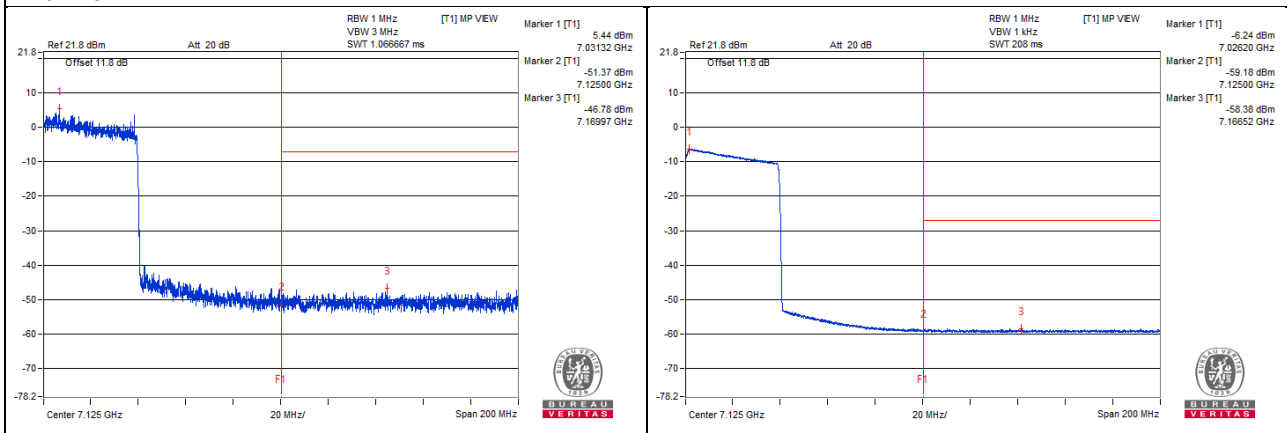



**802.11be (EHT160) - Channel 15**  
**Conducted spurious emission table**

No.	Frequency (MHz)	Emission Level (dBuV/m)	Limit (dBuV/m)	Margin (dB)	Raw Value (dBm)	Correction Factor (dB)	EIRP Level (dBm)
1	12045.31	40.79 PK	74	-33.21	-59.23	4.76	-54.47
2	12050	29.92 AV	54	-24.08	-70.1	4.76	-65.34
3	18075.56	42.25 PK	74	-31.75	-57.77	4.76	-53.01
4	18078.43	31.5 AV	54	-22.5	-68.52	4.76	-63.76

Remarks:

1. Margin value = Emission Level – Limit value
2. The other emission levels were very low against the limit.

### Chain 0

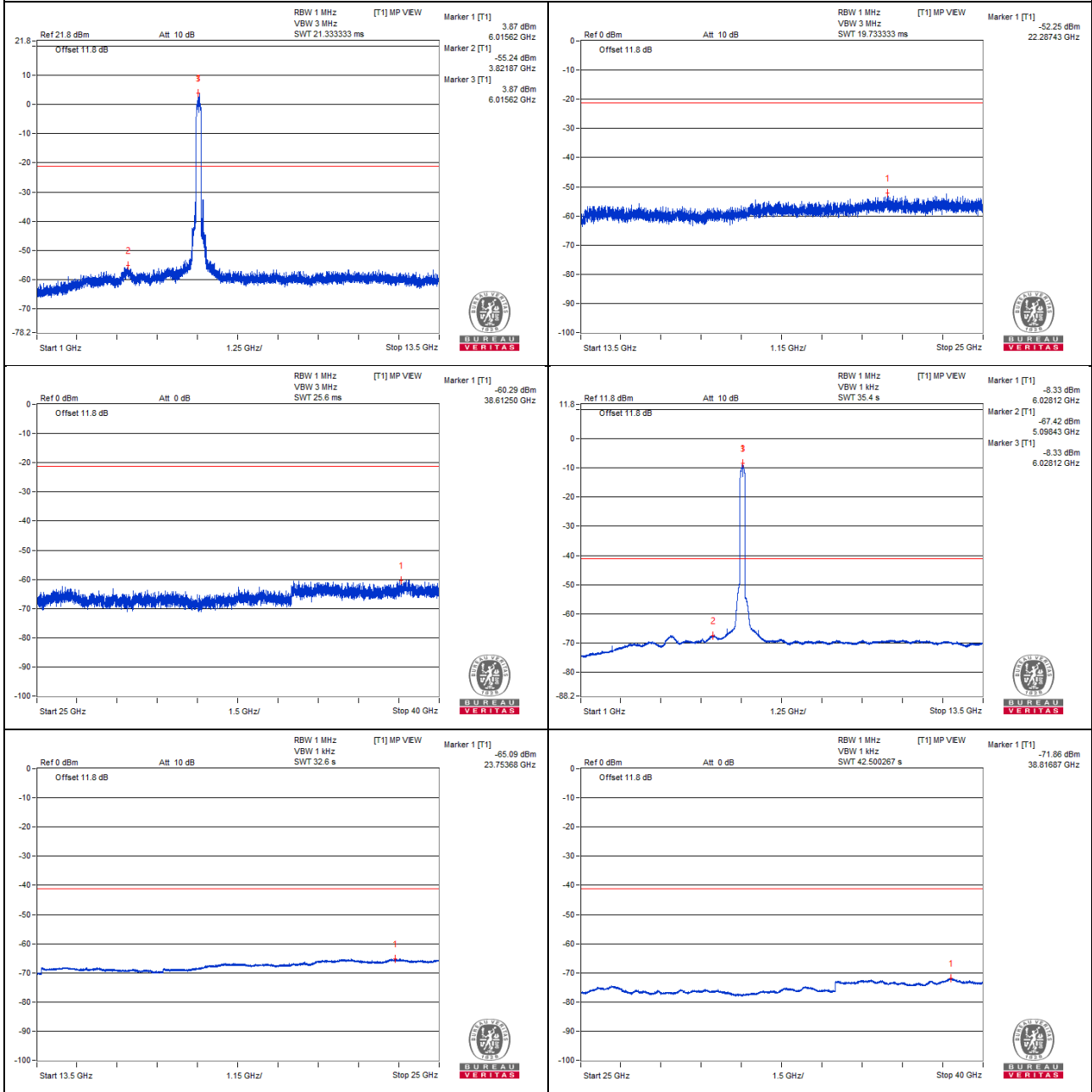

### Bandedge table

No.	Frequency (MHz)	Emission Level (dBuV/m)	Limit (dBuV/m)	Margin (dB)	Raw Value (dBm)	Correction Factor (dB)	EIRP Level (dBm)
1	#5909.45	69.42 PK	88.2	-18.78	-30.6	4.76	-25.84
2	#5923.25	51.25 AV	68.2	-16.95	-48.77	4.76	-44.01

### Remarks:

1. Margin value = Emission Level – Limit value
2. The other emission levels were very low against the limit.
3. " # " : The frequency is out of the restricted band.

### Chain 0

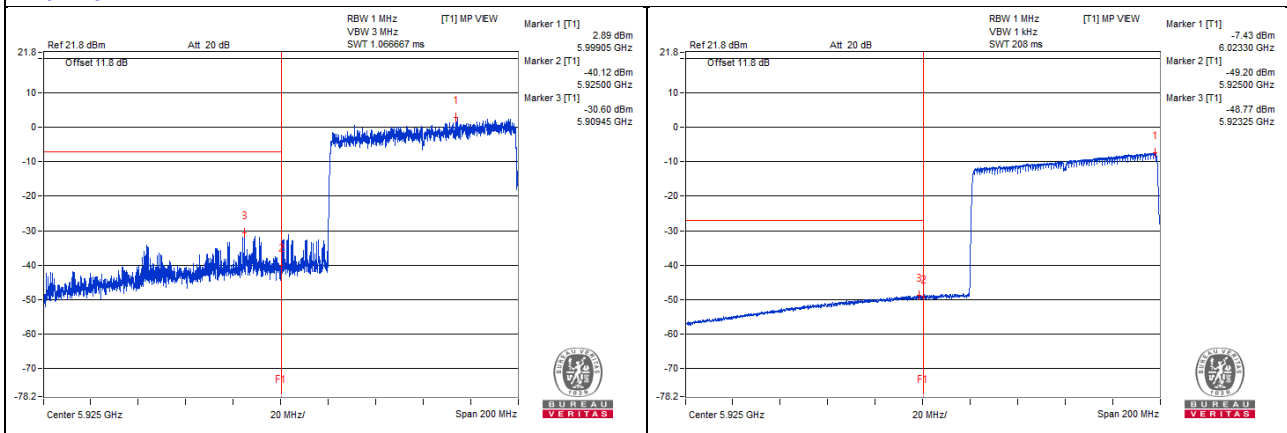

**802.11be (EHT160) - Channel 47**  
**Conducted spurious emission table**

No.	Frequency (MHz)	Emission Level (dBuV/m)	Limit (dBuV/m)	Margin (dB)	Raw Value (dBm)	Correction Factor (dB)	EIRP Level (dBm)
1	12375	42.33 PK	74	-31.67	-57.69	4.76	-52.93
2	12379.68	30.72 AV	54	-23.28	-69.3	4.76	-64.54
3	18545.62	43.68 PK	74	-30.32	-56.34	4.76	-51.58
4	18557.12	32.54 AV	54	-21.46	-67.48	4.76	-62.72

Remarks:

1. Margin value = Emission Level – Limit value
2. The other emission levels were very low against the limit.

### Chain 0

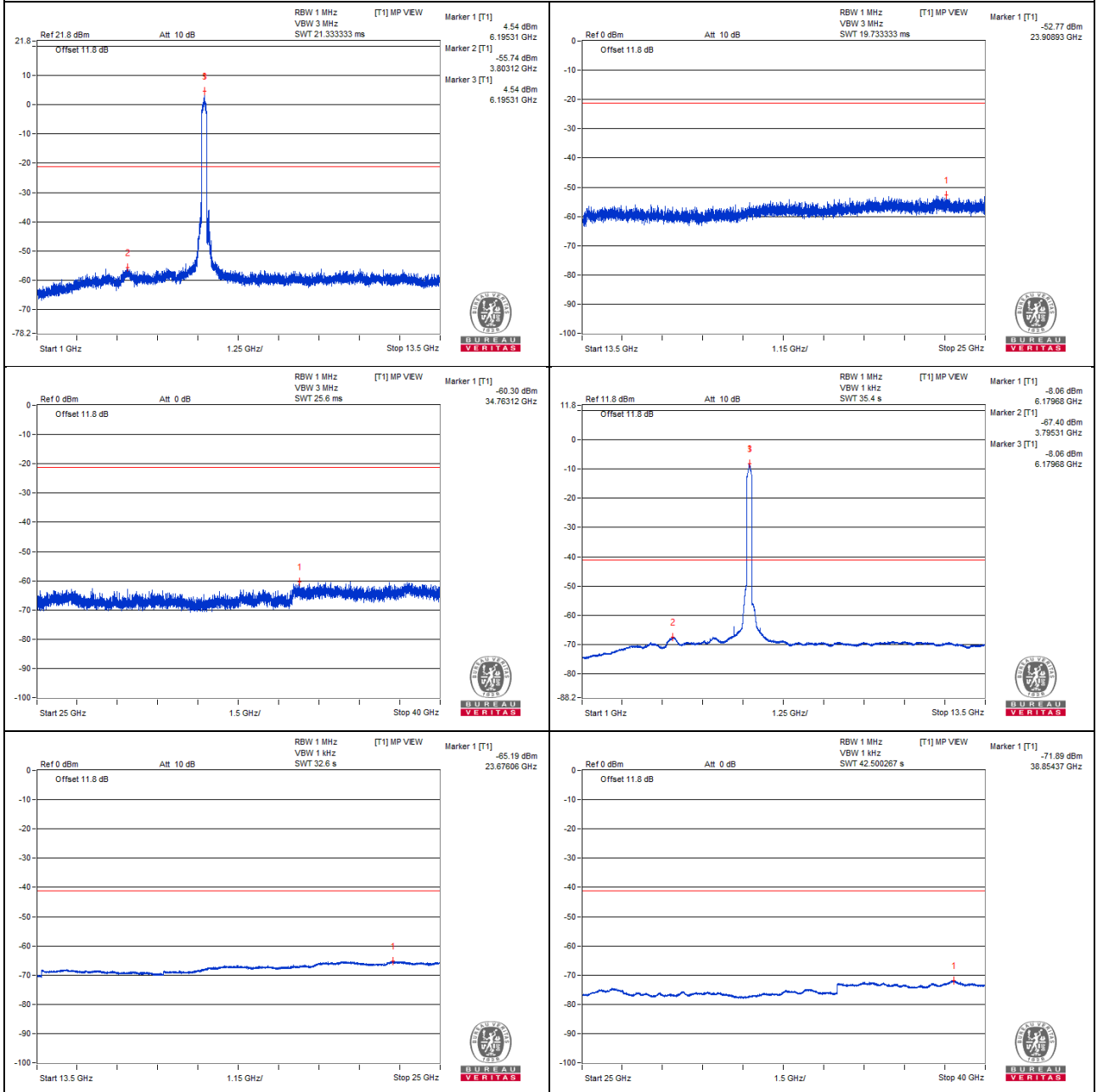

**802.11be (EHT160) - Channel 79**  
**Conducted spurious emission table**

No.	Frequency (MHz)	Emission Level (dBuV/m)	Limit (dBuV/m)	Margin (dB)	Raw Value (dBm)	Correction Factor (dB)	EIRP Level (dBm)
1	12693.75	41.12 PK	74	-32.88	-58.9	4.76	-54.14
2	12687.5	29.99 AV	54	-24.01	-70.03	4.76	-65.27
3	19032.93	43.02 PK	74	-30.98	-57	4.76	-52.24
4	19037.25	32.9 AV	54	-21.1	-67.12	4.76	-62.36

Remarks:

1. Margin value = Emission Level – Limit value
2. The other emission levels were very low against the limit.

### Chain 0

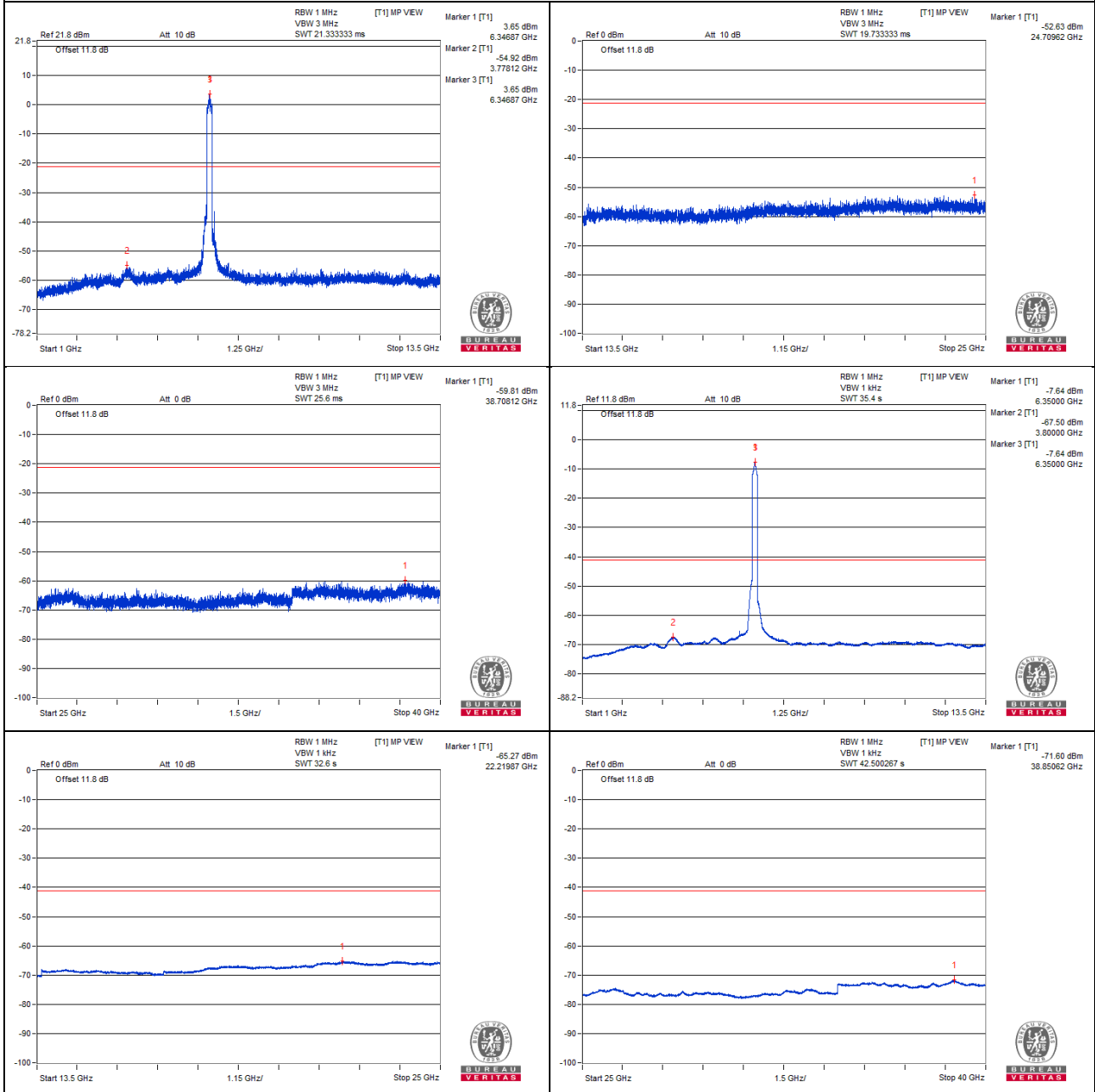

### 802.11be (EHT160) - Channel 111

#### Conducted spurious emission table

No.	Frequency (MHz)	Emission Level (dBuV/m)	Limit (dBuV/m)	Margin (dB)	Raw Value (dBm)	Correction Factor (dB)	EIRP Level (dBm)
1	#13015.62	40.81 PK	88.2	-47.39	-59.21	4.76	-54.45
2	#13012.5	29.17 AV	68.2	-39.03	-70.85	4.76	-66.09
3	19521.68	45.88 PK	74	-28.12	-54.14	4.76	-49.38
4	19505.87	32.79 AV	54	-21.21	-67.23	4.76	-62.47

#### Remarks:

1. Margin value = Emission Level – Limit value
2. The other emission levels were very low against the limit.
3. " # " : The frequency is out of the restricted band.



### Chain 0

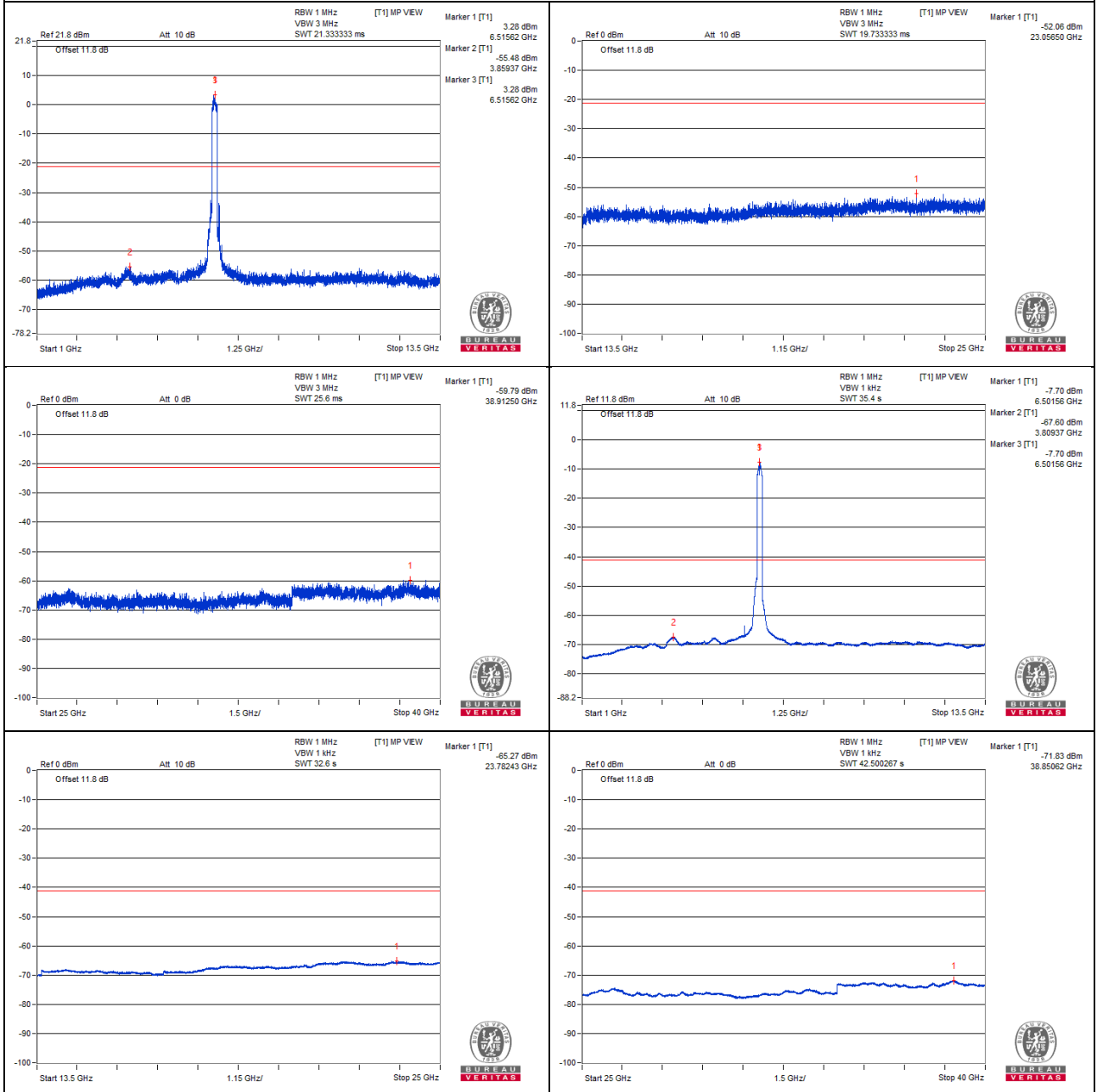

**802.11be (EHT160) - Channel 143**  
**Conducted spurious emission table**

No.	Frequency (MHz)	Emission Level (dBuV/m)	Limit (dBuV/m)	Margin (dB)	Raw Value (dBm)	Correction Factor (dB)	EIRP Level (dBm)
1	13337.5	41.15 PK	74	-32.85	-58.87	4.76	-54.11
2	13326.56	29.58 AV	54	-24.42	-70.44	4.76	-65.68
3	19986	42.99 PK	74	-31.01	-57.03	4.76	-52.27
4	19990.31	32.89 AV	54	-21.11	-67.13	4.76	-62.37

Remarks:

1. Margin value = Emission Level – Limit value
2. The other emission levels were very low against the limit.

### Chain 0

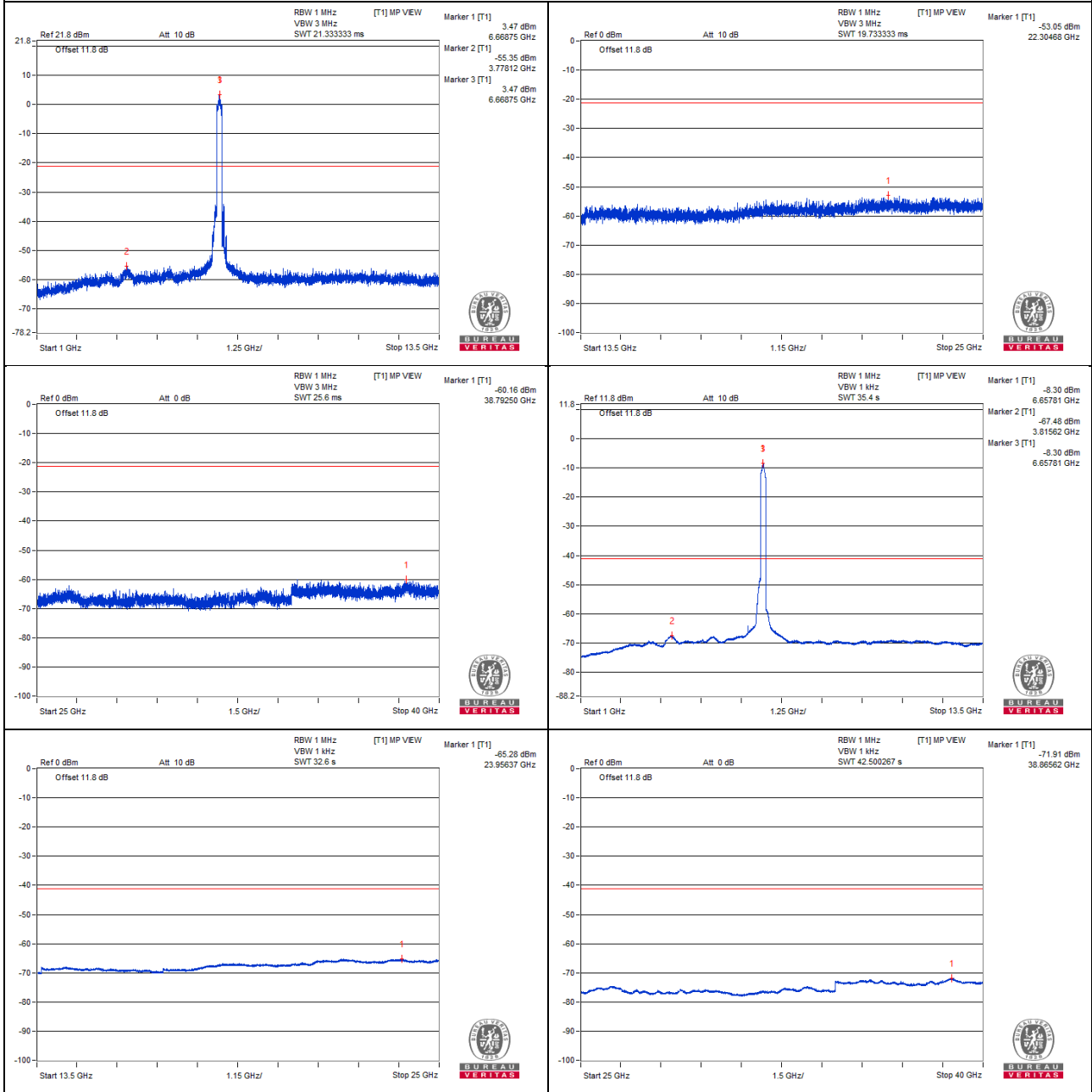

**802.11be (EHT160) - Channel 175**  
**Conducted spurious emission table**

No.	Frequency (MHz)	Emission Level (dBuV/m)	Limit (dBuV/m)	Margin (dB)	Raw Value (dBm)	Correction Factor (dB)	EIRP Level (dBm)
1	#13659.56	43.16 PK	88.2	-45.04	-56.86	4.76	-52.10
2	#13652.37	31.81 AV	68.2	-36.39	-68.21	4.76	-63.45
3	20474.75	42.65 PK	74	-31.35	-57.37	4.76	-52.61
4	20483.37	32.86 AV	54	-21.14	-67.16	4.76	-62.40

Remarks:

1. Margin value = Emission Level – Limit value
2. The other emission levels were very low against the limit.
3. " # " : The frequency is out of the restricted band.

### Chain 0

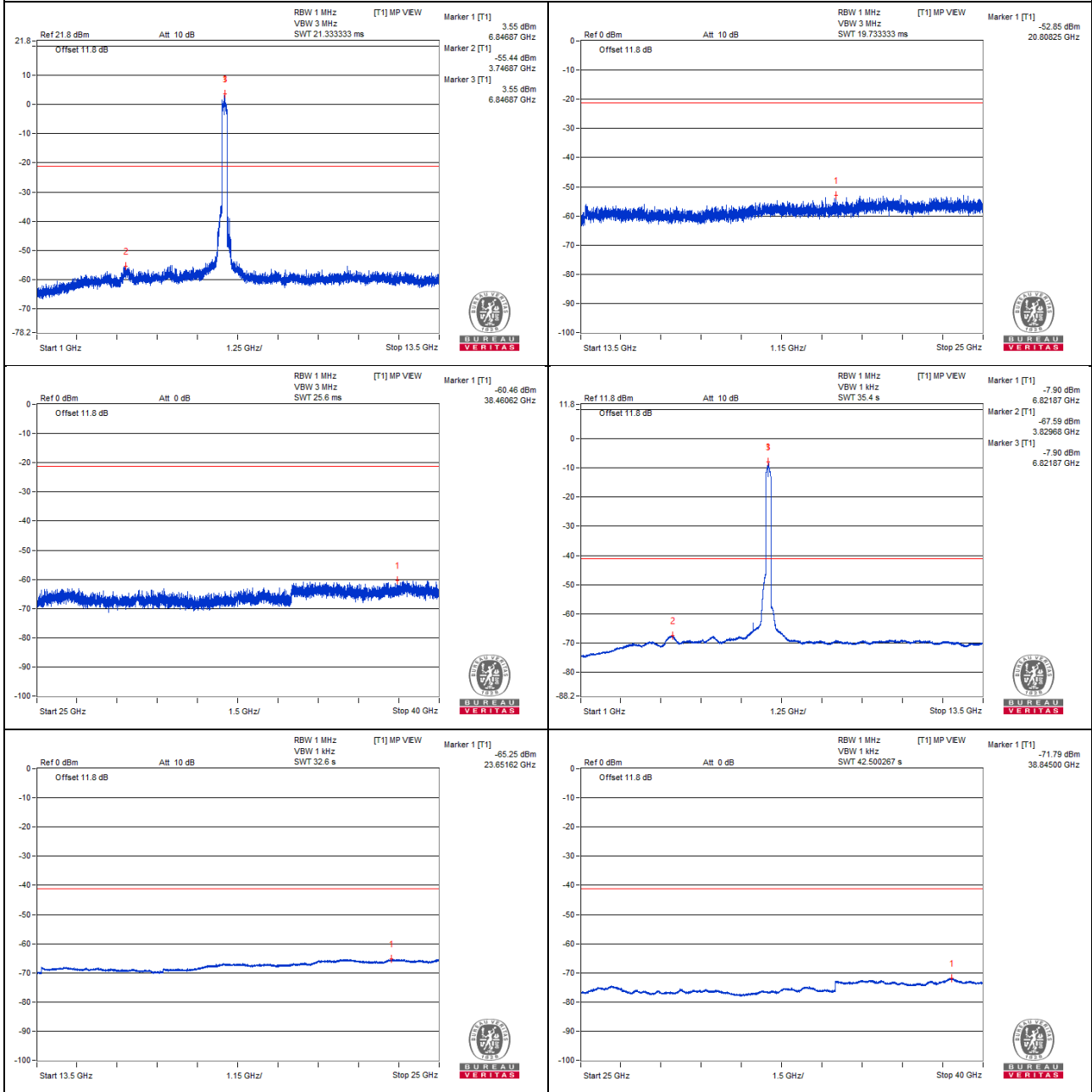

**802.11be (EHT160) - Channel 207**  
**Conducted spurious emission table**

No.	Frequency (MHz)	Emission Level (dBuV/m)	Limit (dBuV/m)	Margin (dB)	Raw Value (dBm)	Correction Factor (dB)	EIRP Level (dBm)
1	#13977.25	43.89 PK	88.2	-44.31	-56.13	4.76	-51.37
2	#13971.5	31.6 AV	68.2	-36.6	-68.42	4.76	-63.66
3	20962.06	43.01 PK	74	-30.99	-57.01	4.76	-52.25
4	20956.31	33 AV	54	-21	-67.02	4.76	-62.26

Remarks:

1. Margin value = Emission Level – Limit value
2. The other emission levels were very low against the limit.
3. " # " : The frequency is out of the restricted band.

### Chain 0

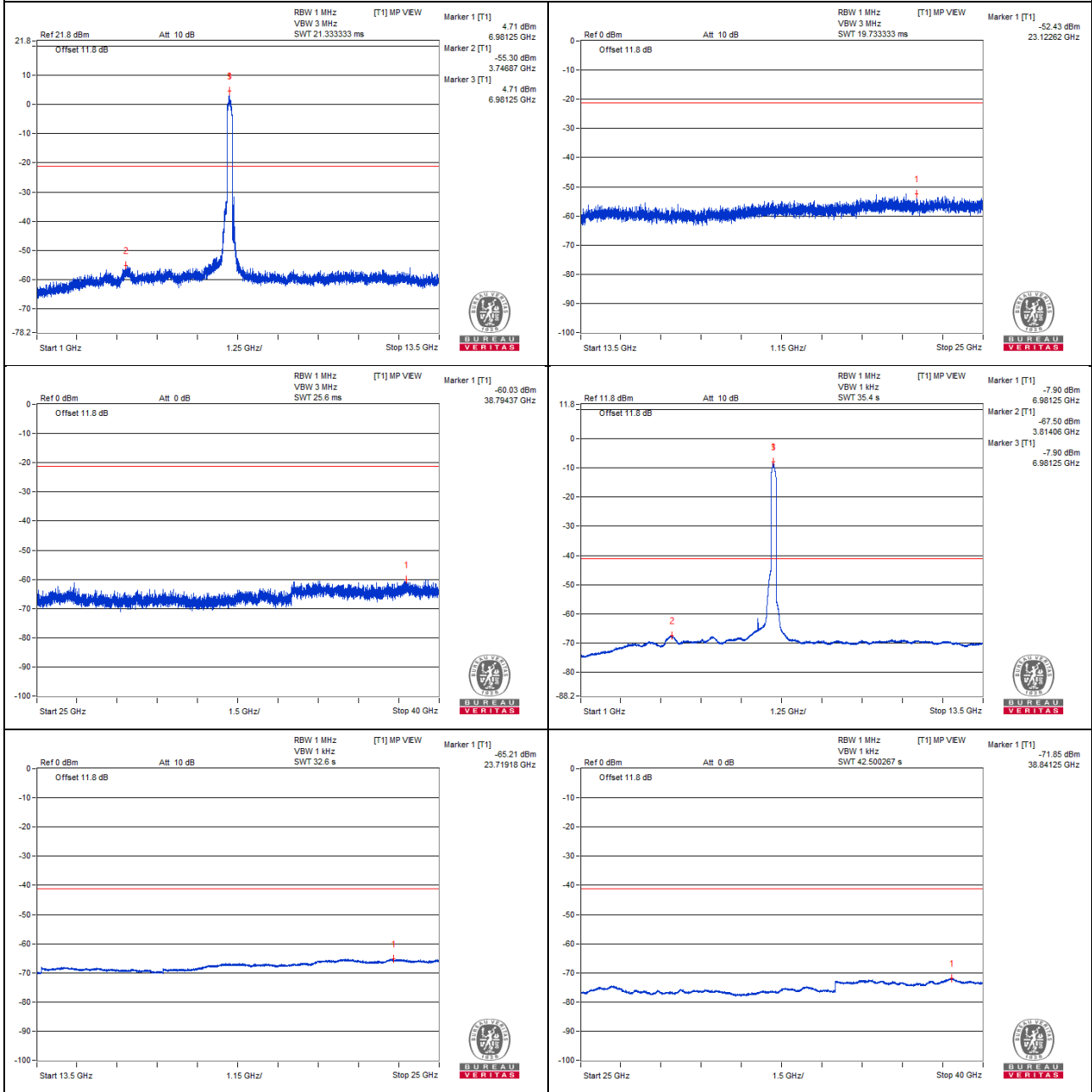

### Bandedge table

No.	Frequency (MHz)	Emission Level (dBuV/m)	Limit (dBuV/m)	Margin (dB)	Raw Value (dBm)	Correction Factor (dB)	EIRP Level (dBm)
1	#7128.05	67.03 PK	88.2	-21.17	-32.32	4.09	-28.23
2	#7126.5	44.09 AV	68.2	-24.11	-55.26	4.09	-51.17

#### Remarks:

1. Margin value = Emission Level – Limit value
2. The other emission levels were very low against the limit.
3. " # " : The frequency is out of the restricted band.

### Chain 0

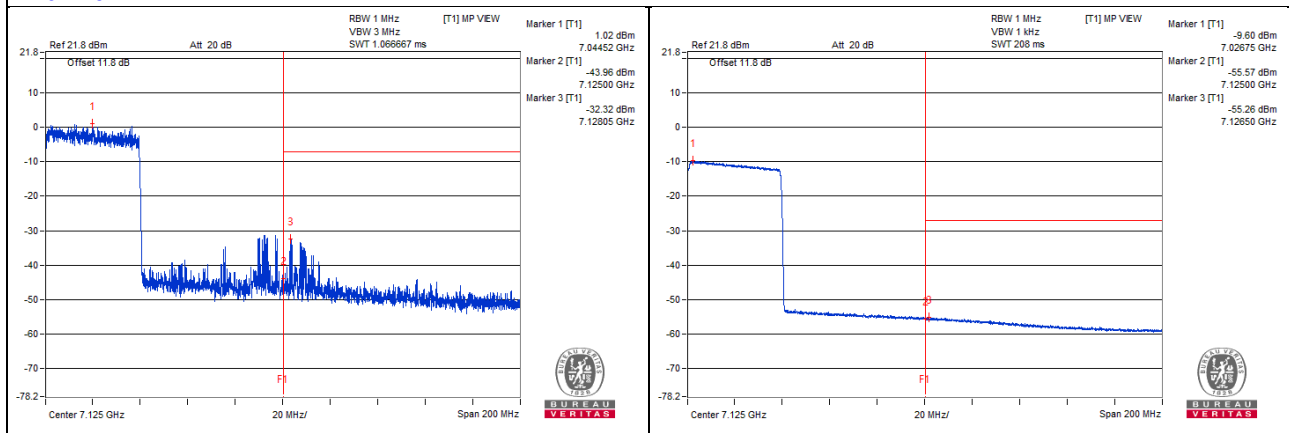



### 802.11be (EHT320) - Channel 31

#### Conducted spurious emission table

No.	Frequency (MHz)	Emission Level (dBuV/m)	Limit (dBuV/m)	Margin (dB)	Raw Value (dBm)	Correction Factor (dB)	EIRP Level (dBm)
1	12210.93	40.94 PK	74	-33.06	-59.08	4.76	-54.32
2	12204.68	30.84 AV	54	-23.16	-69.18	4.76	-64.42
3	18315.62	43.67 PK	74	-30.33	-56.35	4.76	-51.59
4	18322.81	32.76 AV	54	-21.24	-67.26	4.76	-62.50

#### Remarks:

1. Margin value = Emission Level – Limit value
2. The other emission levels were very low against the limit.

### Chain 0

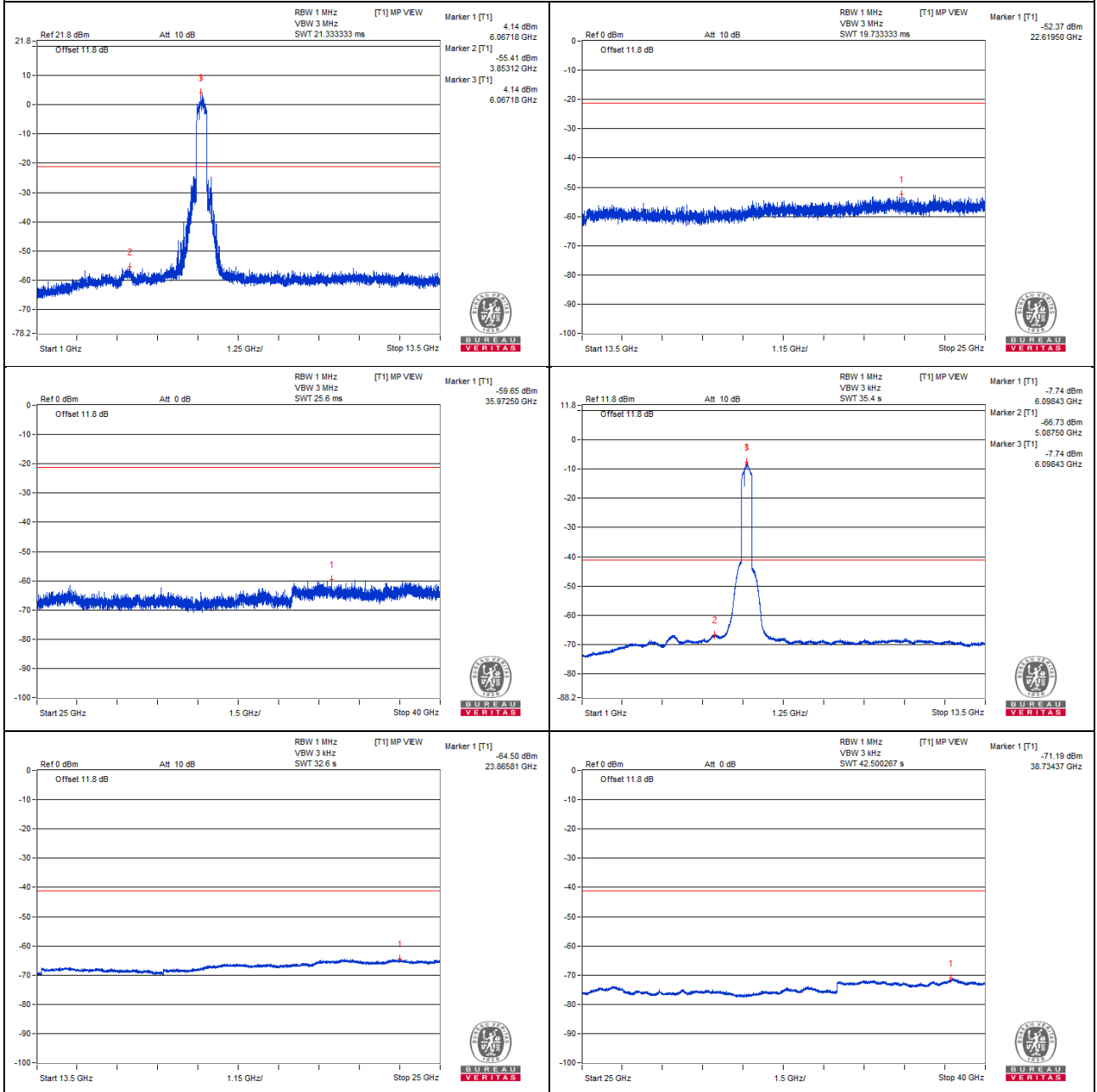

### Bandedge table

No.	Frequency (MHz)	Emission Level (dBuV/m)	Limit (dBuV/m)	Margin (dB)	Raw Value (dBm)	Correction Factor (dB)	EIRP Level (dBm)
1	#5841.87	79.97 PK	88.2	-8.23	-20.05	4.76	-15.29
2	#5909.9	58.9 AV	68.2	-9.3	-41.12	4.76	-36.36

#### Remarks:

1. Margin value = Emission Level – Limit value
2. The other emission levels were very low against the limit.
3. " # " : The frequency is out of the restricted band.

### Chain 0

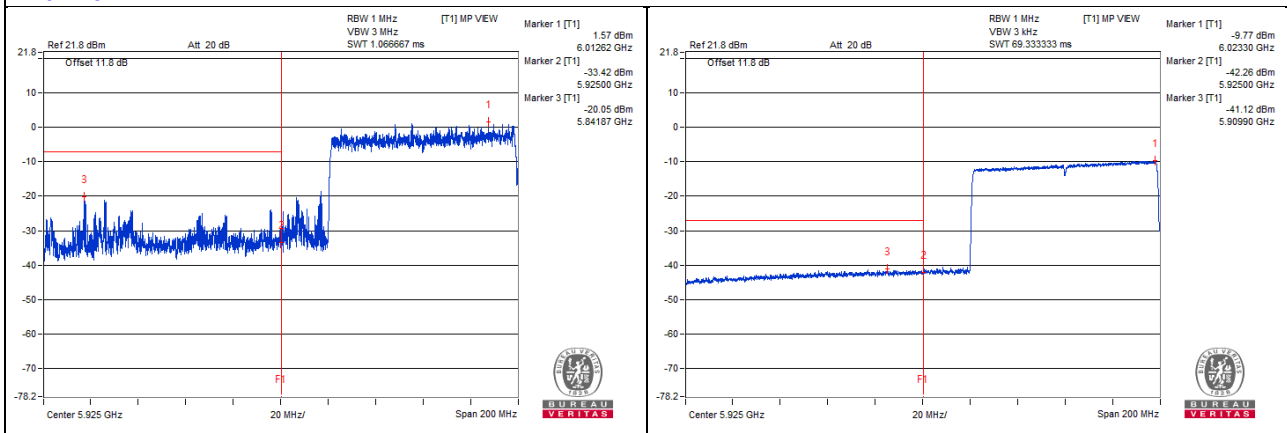

**802.11be (EHT160) - Channel 63**  
**Conducted spurious emission table**

No.	Frequency (MHz)	Emission Level (dBuV/m)	Limit (dBuV/m)	Margin (dB)	Raw Value (dBm)	Correction Factor (dB)	EIRP Level (dBm)
1	12537.5	41.17 PK	74	-32.83	-58.85	4.76	-54.09
2	12528.12	30.86 AV	54	-23.14	-69.16	4.76	-64.40
3	18788.56	44.55 PK	74	-29.45	-55.47	4.76	-50.71
4	18787.12	33.52 AV	54	-20.48	-66.5	4.76	-61.74

Remarks:

1. Margin value = Emission Level – Limit value
2. The other emission levels were very low against the limit.

### Chain 0

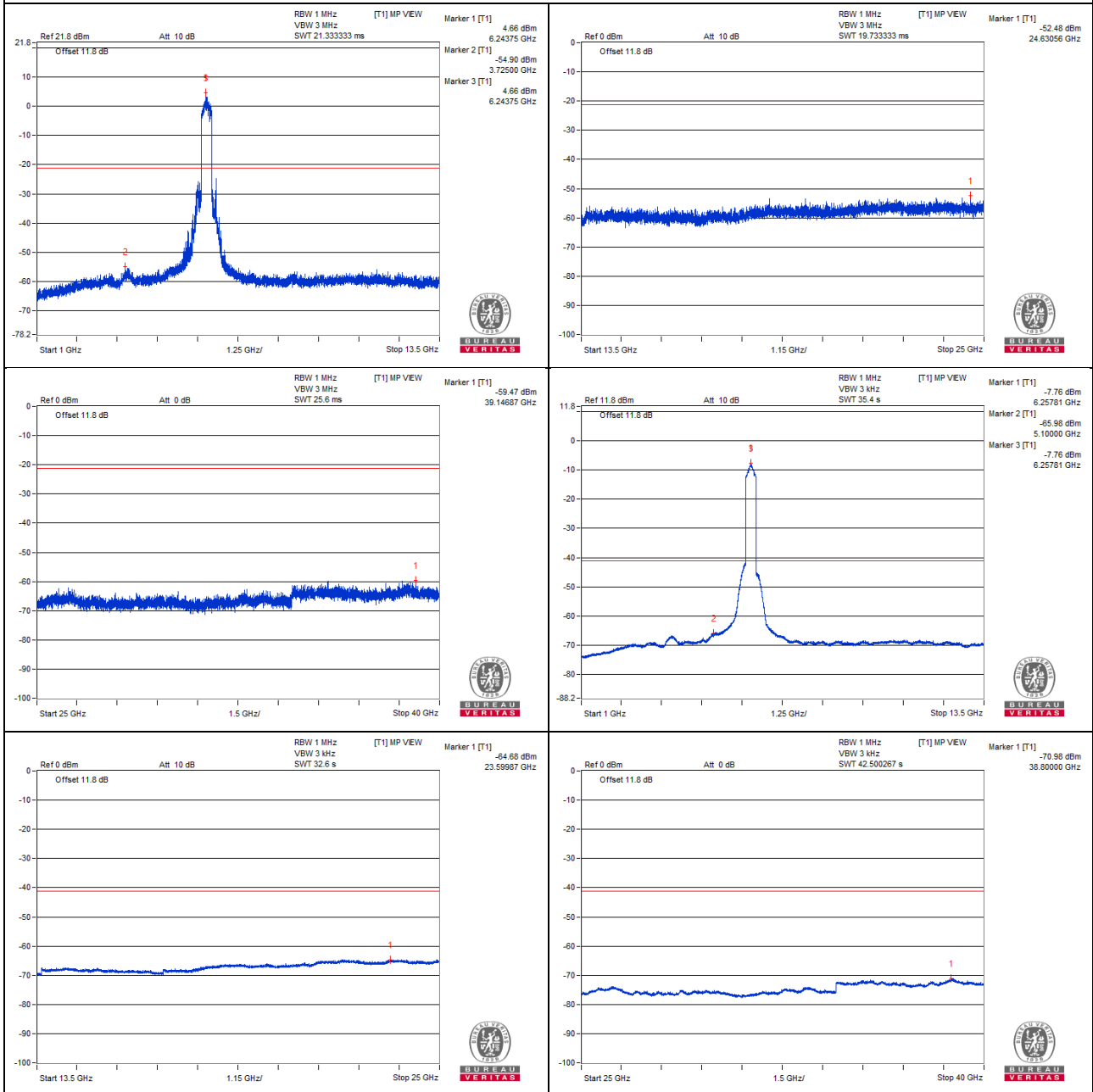

### 802.11be (EHT160) - Channel 95

#### Conducted spurious emission table

No.	Frequency (MHz)	Emission Level (dBuV/m)	Limit (dBuV/m)	Margin (dB)	Raw Value (dBm)	Correction Factor (dB)	EIRP Level (dBm)
1	#12840.62	40.94 PK	88.2	-47.26	-59.08	4.76	-54.32
2	#12848.43	30.1 AV	68.2	-38.1	-69.92	4.76	-65.16
3	19283.06	43.29 PK	74	-30.71	-56.73	4.76	-51.97
4	19268.68	33.42 AV	54	-20.58	-66.6	4.76	-61.84

#### Remarks:

1. Margin value = Emission Level – Limit value
2. The other emission levels were very low against the limit.
3. " # " : The frequency is out of the restricted band.

### Chain 0

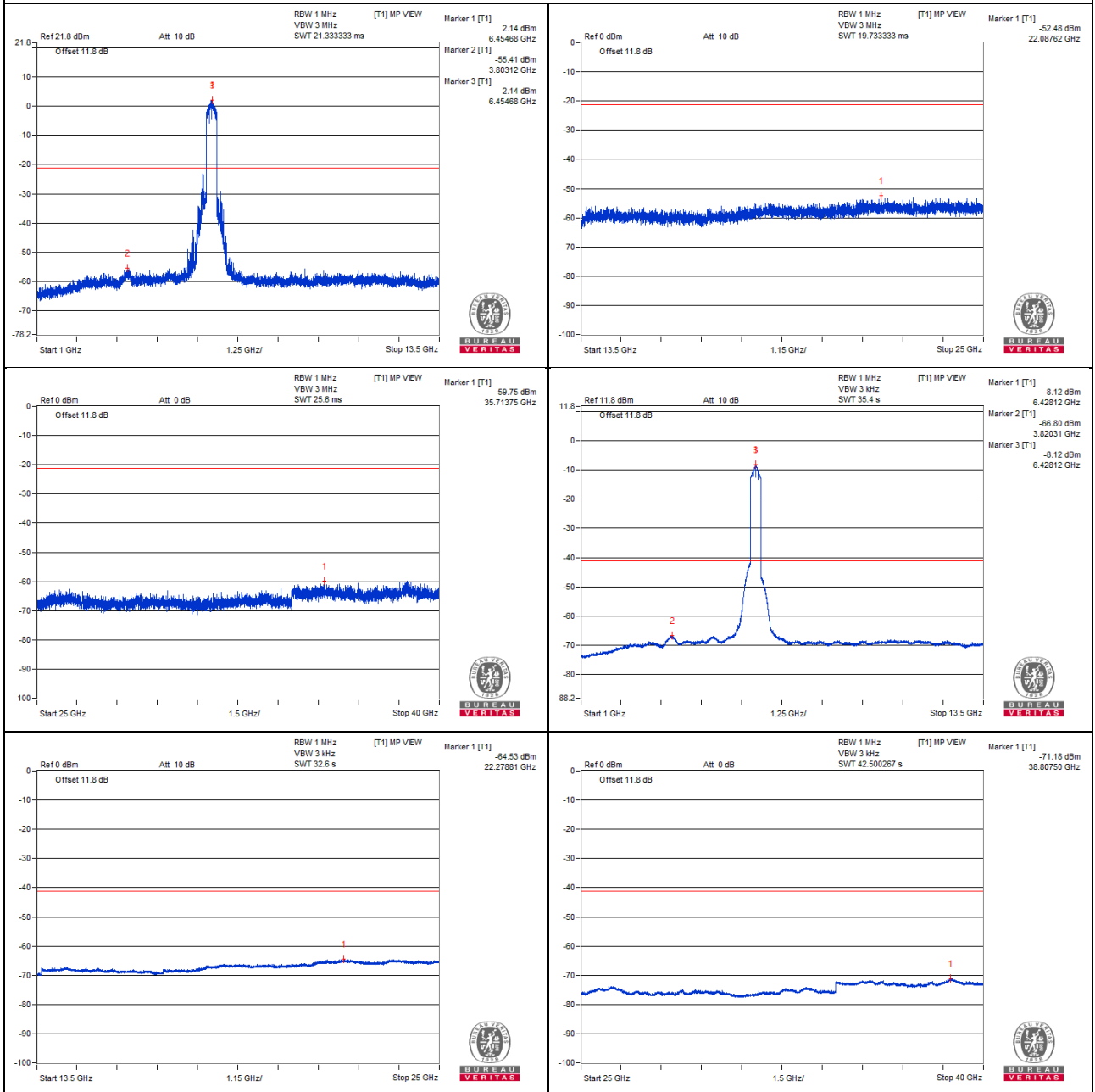

**802.11be (EHT160) - Channel 127**  
**Conducted spurious emission table**

No.	Frequency (MHz)	Emission Level (dBuV/m)	Limit (dBuV/m)	Margin (dB)	Raw Value (dBm)	Correction Factor (dB)	EIRP Level (dBm)
1	#13171.87	41.58 PK	88.2	-46.62	-58.44	4.76	-53.68
2	#13170.31	30.73 AV	68.2	-37.47	-69.29	4.76	-64.53
3	19753.12	43.64 PK	74	-30.36	-56.38	4.76	-51.62
4	19764.62	33.28 AV	54	-20.72	-66.74	4.76	-61.98

Remarks:

1. Margin value = Emission Level – Limit value
2. The other emission levels were very low against the limit.
3. " # " : The frequency is out of the restricted band.



### Chain 0

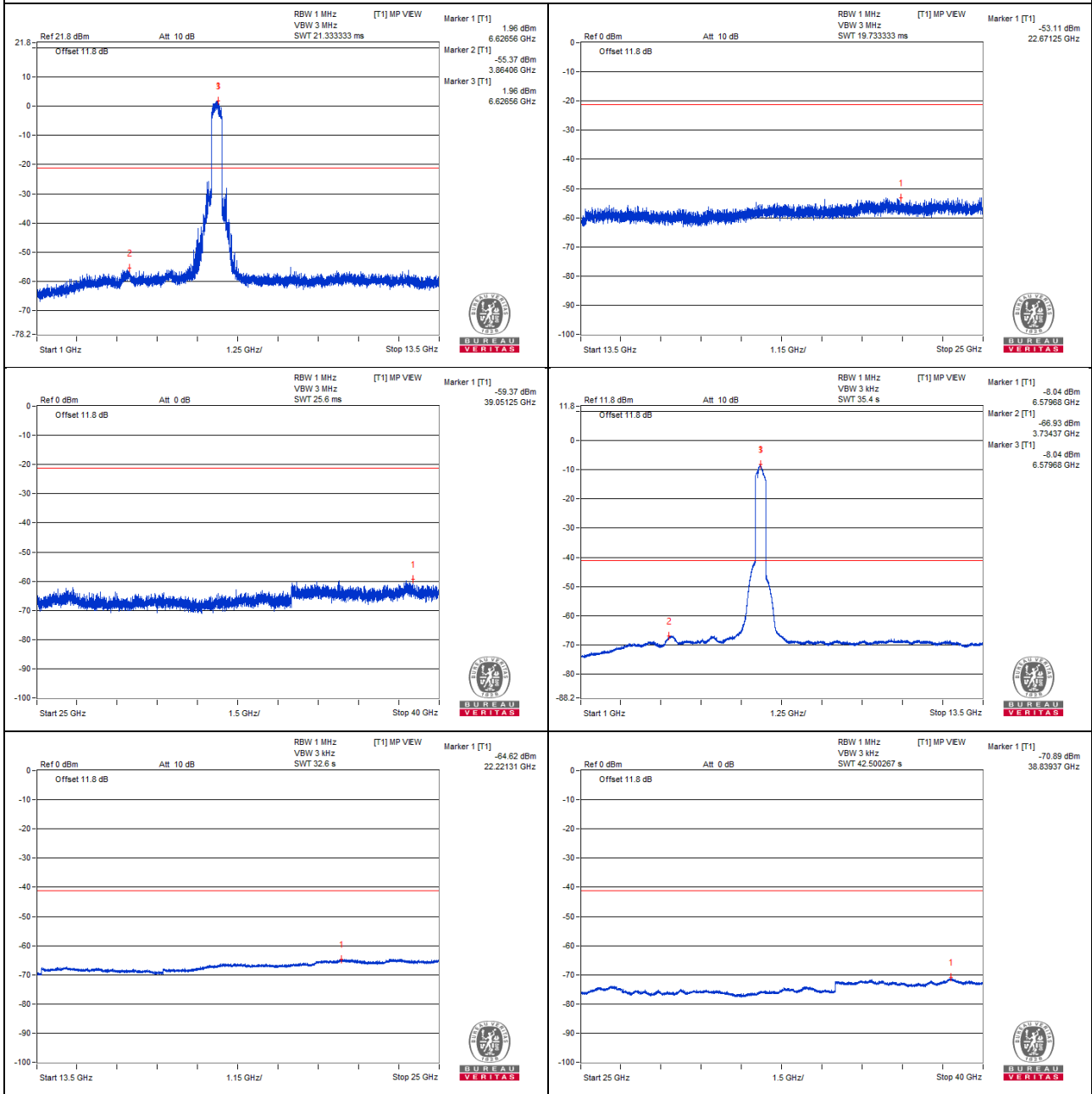

**802.11be (EHT160) - Channel 159**  
**Conducted spurious emission table**

No.	Frequency (MHz)	Emission Level (dBuV/m)	Limit (dBuV/m)	Margin (dB)	Raw Value (dBm)	Correction Factor (dB)	EIRP Level (dBm)
1	#13489.06	42.42 PK	88.2	-45.78	-57.6	4.76	-52.84
2	#13481.25	30.76 AV	68.2	-37.44	-69.26	4.76	-64.50
3	20227.5	42.84 PK	74	-31.16	-57.18	4.76	-52.42
4	20237.56	33.42 AV	54	-20.58	-66.6	4.76	-61.84

Remarks:

1. Margin value = Emission Level – Limit value
2. The other emission levels were very low against the limit.
3. " # " : The frequency is out of the restricted band.

### Chain 0

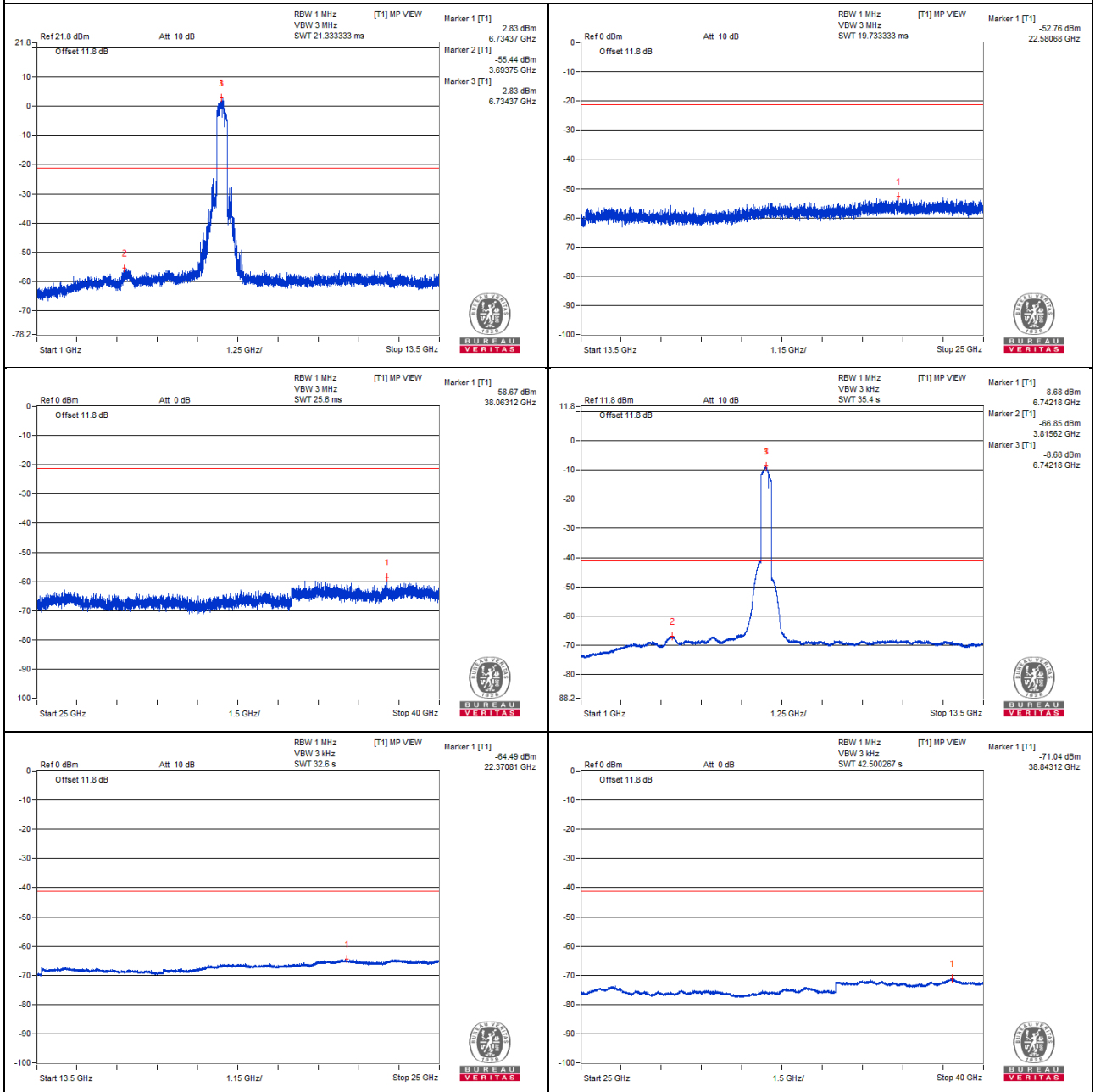

**802.11be (EHT160) - Channel 191**  
**Conducted spurious emission table**

No.	Frequency (MHz)	Emission Level (dBuV/m)	Limit (dBuV/m)	Margin (dB)	Raw Value (dBm)	Correction Factor (dB)	EIRP Level (dBm)
1	#13819.12	41.75 PK	88.2	-46.45	-58.27	4.76	-53.51
2	#13806.18	32.54 AV	68.2	-35.66	-67.48	4.76	-62.72
3	20711.93	43.35 PK	74	-30.65	-56.67	4.76	-51.91
4	20717.68	33.18 AV	54	-20.82	-66.84	4.76	-62.08

Remarks:

1. Margin value = Emission Level – Limit value
2. The other emission levels were very low against the limit.
3. " # " : The frequency is out of the restricted band.

### Chain 0

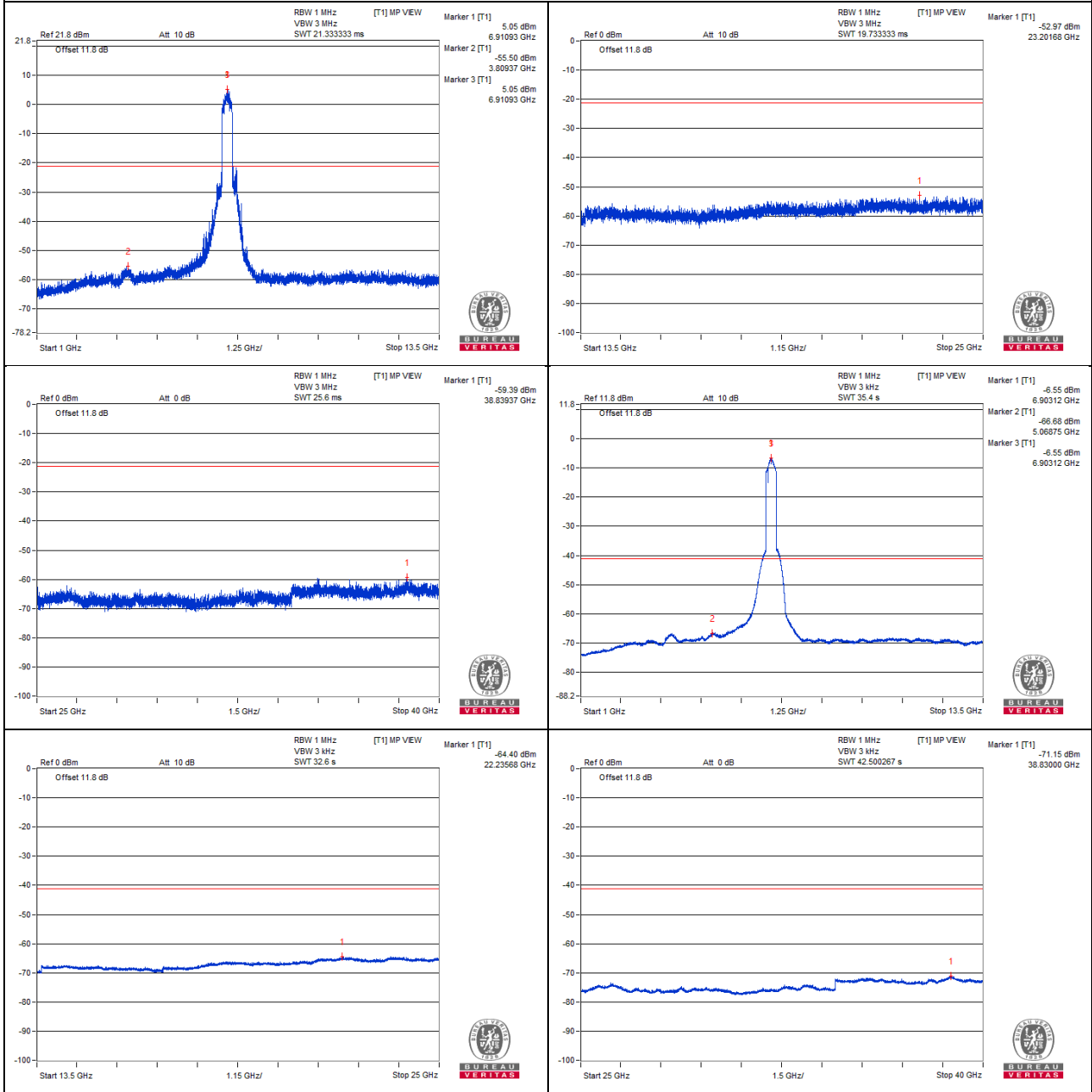

### Bandedge table

No.	Frequency (MHz)	Emission Level (dBuV/m)	Limit (dBuV/m)	Margin (dB)	Raw Value (dBm)	Correction Factor (dB)	EIRP Level (dBm)
1	#7181.97	81.11 PK	88.2	-7.09	-18.24	4.09	-14.15
2	#7127.75	61.02 AV	68.2	-7.18	-38.33	4.09	-34.24

#### Remarks:

1. Margin value = Emission Level – Limit value
2. The other emission levels were very low against the limit.
3. " # " : The frequency is out of the restricted band.

### Chain 0

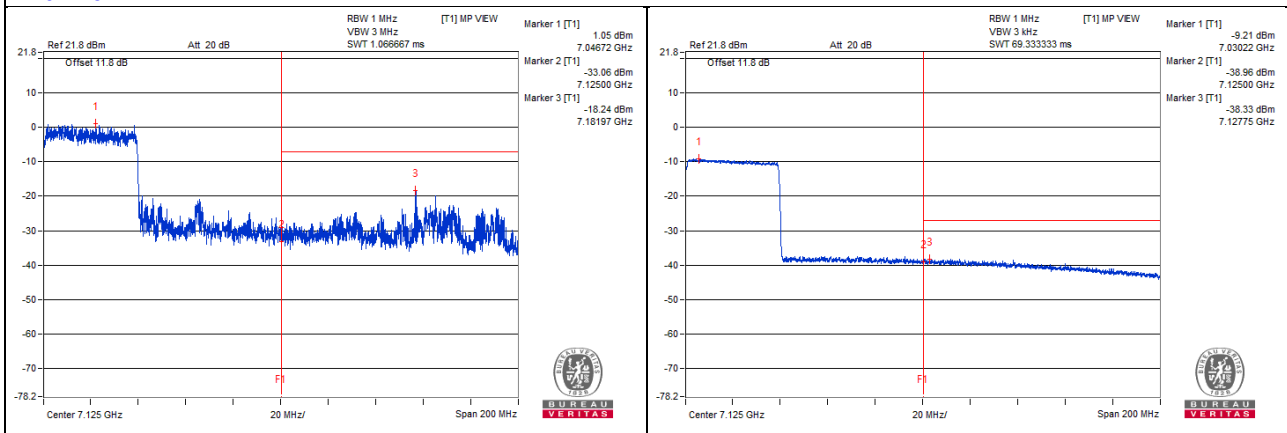

**Below 1GHz Data:**

**802.11be (EHT320) – Channel 159**

**Conducted spurious emission table**

No.	Frequency (MHz)	Emission Level (dBuV/m)	Limit (dBuV/m)	Margin (dB)	Raw Value (dBm)	Correction Factor (dB)	EIRP Level (dBm)
1	66.98	20.39	40	-19.61	-79.63	4.76	-74.87
2	196.59	20.99	43.5	-22.51	-79.03	4.76	-74.27
3	316.75	20.86	46	-25.14	-79.16	4.76	-74.40
4	595.14	22.85	46	-23.15	-77.17	4.76	-72.41
5	765.38	22.22	46	-23.78	-77.8	4.76	-73.04
6	984.11	22.78	54	-31.22	-77.24	4.76	-72.48

**Remarks:**

1. Margin value = Emission Level – Limit value
2. The other emission levels were very low against the limit.

**Chain 0**

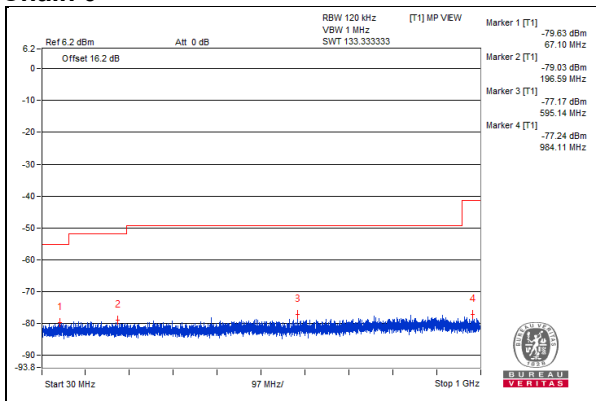

#### 4.1.7.2 Test Results (Mode 2)

##### Above 1GHz Data

##### 802.11a - Channel 1

##### Conducted spurious emission table

No.	Frequency (MHz)	Emission Level (dBuV/m)	Limit (dBuV/m)	Margin (dB)	Raw Value (dBm)		Correction Factor (dB)	EIRP Level (dBm)
					Chain0	Chain1		
1	11915.62	46.6 PK	74	-27.4	-58.47	-60.7	7.77	-48.66
2	11915.62	36.23 AV	54	-17.77	-69.78	-69.84	7.77	-59.03
3	17872.87	47.26 PK	74	-26.74	-58.58	-59	7.77	-48.00
4	17865.68	37.1 AV	54	-16.9	-68.88	-69	7.77	-58.16

##### Remarks:

1. Margin value = Emission Level – Limit value
2. The other emission levels were very low against the limit.



### Chain 0

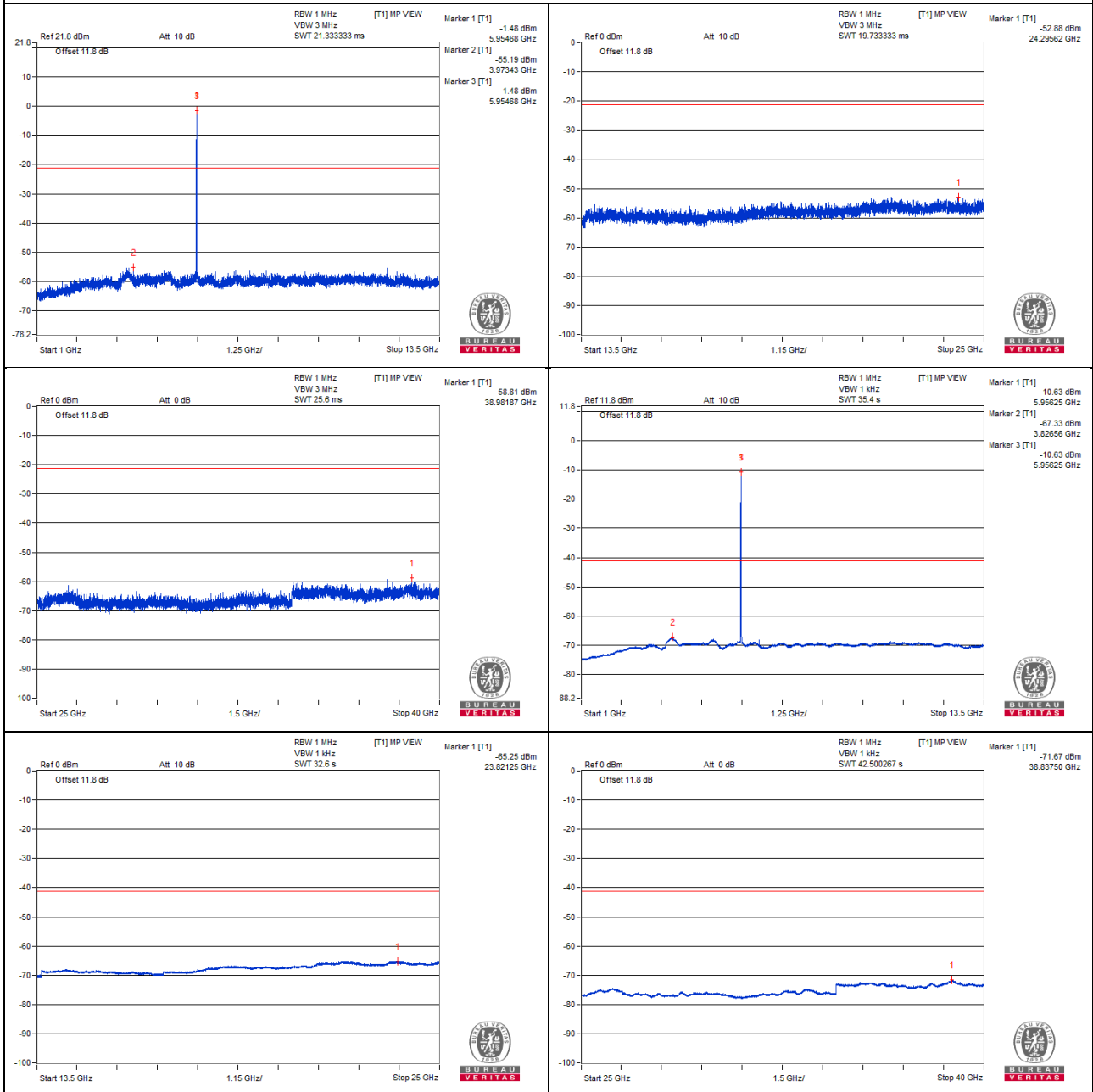

### Chain 1

