



# EMC Test Report

**Product Name: HUAWEI MediaPad T1 8.0**

**Model Number: S8-702u**

**Report No: SYBH(Z-EMC)110042014-2**

**FCC ID: QISS8-702U**

**Reliability Laboratory of Huawei Technologies Co., Ltd.**

Administration Building, Headquarters of Huawei Technologies Co., Ltd., Bantian, Longgang District,  
Shenzhen, 518129, P.R.C

Tel: +86 755 28780808 Fax: +86 755 89652518

## Notice

1. The laboratory has obtained the accreditation of China National Accreditation Service for Conformity Assessment (CNAS), and accreditation number: L0310.
2. The laboratory has passed the accreditation by The American Association for Laboratory Accreditation (A2LA). The accreditation number is 2174.01.
3. The laboratory has been listed on the US Federal Communications Commission list of test facilities recognized to perform electromagnetic emissions measurements. The site recognition number is 97456.
4. The laboratory has been listed by industry Canada to perform electromagnetic emission measurement. The site recognition number is 6369A-2.
5. The test report is invalid if not marked with "exclusive stamp for the test report".
6. The test report is invalid if not marked with the stamps or the signatures of the persons responsible for performing, revising and approving the test report.
7. The test report is invalid if there is any evidence of erasure and/or falsification.
8. If there is any dissidence for the test report, please file objection to the test centre within 15 days from the date of receiving the test report.
9. Normally, the test report is only responsible for the samples that have undergone the test.
10. Context of the test report cannot be used partially or in full for publicity and/or promotional purposes without previous written approval of the laboratory.

**Applicant:** Huawei Technologies Co., Ltd.  
**Address:** Administration Building, Headquarters of Huawei Technologies Co., Ltd., Bantian, Longgang District, Shenzhen, 518129, P.R.C

**Date of Receipt Test Item:** Apr.29, 2014  
**Start Date of Test:** May.08, 2014  
**End Date of Test:** Jun.13, 2014

**Test Result:** Pass

**Approved By  
(Lab Manager)**

<b>2014-06-13</b>	<b>Liuchunlin</b>	
<b>Date</b>	<b>Name</b>	<b>Signature</b>

**Operator  
(Test Engineer)**

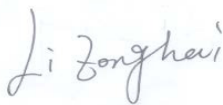
<b>2014-06-13</b>	<b>Lizonghai</b>	
<b>Date</b>	<b>Name</b>	<b>Signature</b>

**Modification Record**





No.	Last Report No.	Modification Description
1	NA	First report





## TABLE OF CONTENT

1	General Information .....	6
1.1	EUT Description .....	6
1.2	Test Site Information .....	8
1.3	Applied Standards .....	8
2	Summary of Results.....	9
3	System Configuration during EMC Test.....	10
3.1	Test Mode .....	10
3.2	Test System Configuration.....	10
3.3	Cables Used during Test.....	11
3.4	Associated Equipment Used during Test .....	11
4	Electromagnetic Interference (EMI).....	12
4.1	Radiated Disturbance 30MHz to 18GHz .....	12
4.2	Conducted Disturbance 0.15 MHz to 30MHz.....	14
5	Main Test Instruments.....	15
6	System Measurement Uncertainty .....	16
7	Test Data and Graph.....	17
7.1	Radiated Disturbance .....	17
7.2	Conducted Disturbance.....	19

## 1 General Information

### 1.1 EUT Description

EUT Description	
Product Name	HUAWEI MediaPad T1 8.0
Model Number	S8-702u
Serials Number	X6B0114406000083
Working Voltage	5Vdc
TX Frequency	Bluetooth:2402MHz To 2480MHz WIFI:2412MHz To 2462MHz GSM850:824MHz To 849MHz GSM1900:1850MHz To 1910MHz WCDMA850:824MHz To 849MHz WCDMA1900:1850MHz To 1910MHz
RX Frequency	Bluetooth: 2402MHz To 2480MHz WIFI: 2412MHz To 2462MHz GPS: 1570MHz To 1580 MHz GSM850: 869MHz To 894MHz GSM1900:1930MHz To 1990MHz WCDMA850: 869MHz To 894MHz WCDMA1900: 1930MHz To 1990MHz
HW Version	S8-702u V100
SW Version	S8-702u V100R001C001B005
EUT Accessory	
Data cable	Data Cable USB A Male to Micro USB Male
Adapter	BRAND: HUAWEI Model: HW-050200E3W Input voltage: ~100V-240V 50/60Hz,0.5A Output voltage: 5V  2A S/N: HWHKAADA2419837
Adapter	BRAND: HUAWEI Model: HW-050200B3W Input voltage: ~100V-240V 50/60Hz,0.5A Output voltage: 5V  2A S/N: HWHKAADA1005652
Adapter	BRAND: HUAWEI Model: HW-050200A3W Input voltage: ~100V-240V 50/60Hz,0.5A Output voltage: 5V  2A S/N: HWHKAADA1000068
Adapter	BRAND: HUAWEI Model: HW-050200U3W Input voltage: ~100V-240V 50/60Hz,0.5A Output voltage: 5V  2A S/N: HWHKAAD92600324
Adapter	BRAND: HUAWEI Model: HW-050100E3W Input voltage: ~100V-240V 50/60Hz,0.5A Output voltage: 5V  1A

	S/N: HWHKACDC0700752
Adapter	BRAND: HUAWEI Model: HW-050100B3W Input voltage: ~100V-240V 50/60Hz,0.5A Output voltage: 5V  1A S/N: HWHKACDC1621868
Adapter	BRAND: HUAWEI Model: HW-050100A3W Input voltage: ~100V-240V 50/60Hz,0.5A Output voltage: 5V  1A S/N: HWHKACE11480077
Adapter	BRAND: HUAWEI Model: HW-050100U3W Input voltage: ~100V-240V 50/60Hz,0.5A Output voltage: 5V  1A S/N: HWHKACDC0805119
Rechargeable Li-ion	BRAND: HUAWEI Battery Model: HB3080G1EBC Rated capacity:4800 mAh Nominal Voltage:  +3.8V Charging Voltage:  +4.35V

Remark: The information of the EUT is declared by the manufacturer. Please refer to the specifications or user manual for details.

## 1.2 Test Site Information

Test Site 1:	RELIABILITY LABORATORY OF HUAWEI TECHNOLOGIES CO., LTD.
Test Site Location:	Administration Building, Headquarters of Huawei Technologies Co., Ltd., Bantian, Longgang District, Shenzhen, 518129, P.R.C

## 1.3 Applied Standards

APPLIED STANDARD

47 CFR FCC Part 15:2012, Subpart B

## 2 Summary of Results

Summary of Results				
Test Items	Test Mode	Performance Class & Required Performance Criteria	Result	Site
<u>Radiated Emissions</u> Enclosure Port	Mode2 Mode3	CLASS B	Pass	Site1
<u>Conducted Emissions</u> <input checked="" type="checkbox"/> DC Power Port <input checked="" type="checkbox"/> AC Power Port <input type="checkbox"/> Telecommunication Ports	Mode1 Mode2	CLASS B	Pass	Site1
Note: 1, Measurement taken is within the uncertainty of test system. 2, <input checked="" type="checkbox"/> The item has been tested; <input type="checkbox"/> The item has not been tested.				

During the measurement, the environmental conditions complied with the range listed as below.

Item	Required
Ambient temperature	15°C ~ 35°C
Relative humidity	25% ~ 75%
Atmospheric pressure	86kPa ~ 106kPa

### 3 System Configuration during EMC Test

#### 3.1 Test Mode

The EUT was configured, installed, arranged and operated in a manner consistent with typical application; the following mode(s) were applied during the compliance test.

Test Mode	
Mode 1:	Adapter (charge) + TF Card + earphone + Camera on +wireless service traffic mode
Mode 2:	Adapter (charge) + TF Card + earphone + Camera on +wireless service IDLE mode
Mode 3:	PC (Power supply and USB copy) + TF card + earphone + wireless service IDLE mode

Remark: If there is more than one adapter, each one should be applied throughout the compliance test respectively, however, only the worst case will be recorded in this report.

Traffic Mode:

State of EUT when switched on and with Radio Resource Control (RRC) connection established

IDLE Mode:

State of EUT when switched on but with no Radio Resource Control (RRC) connection

#### 3.2 Test System Configuration

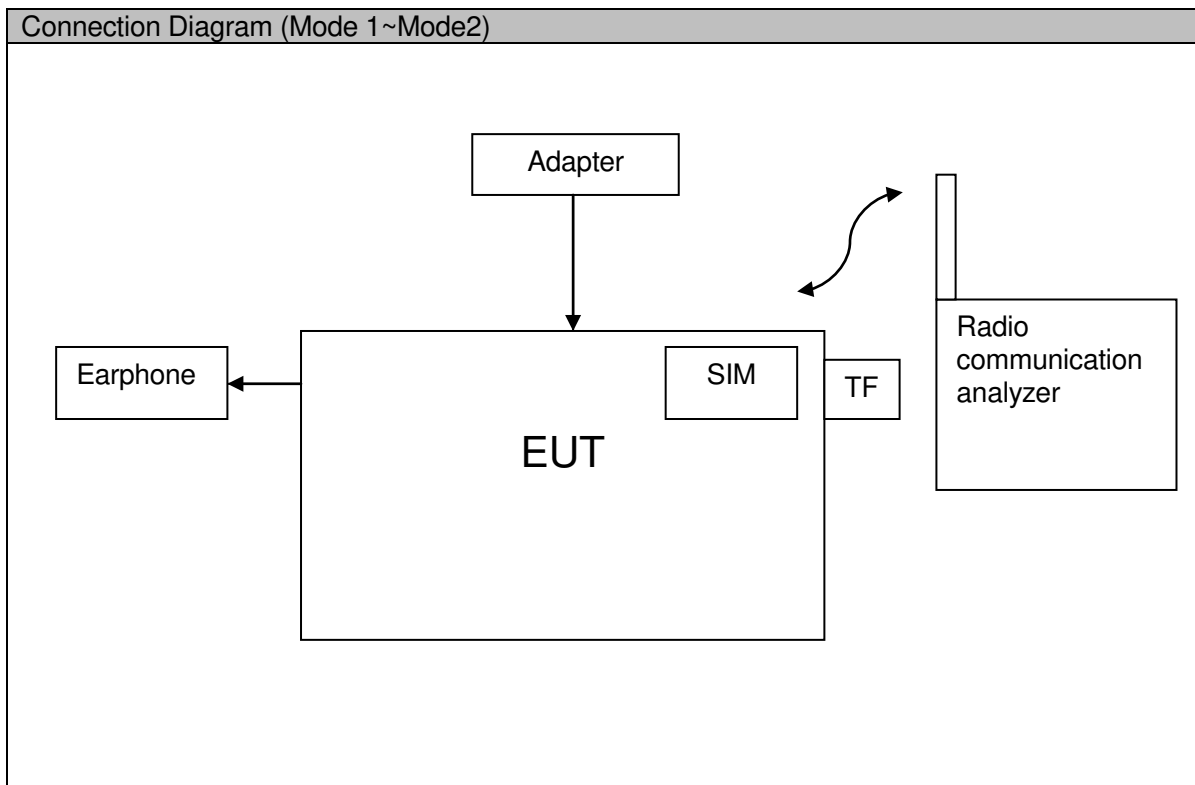

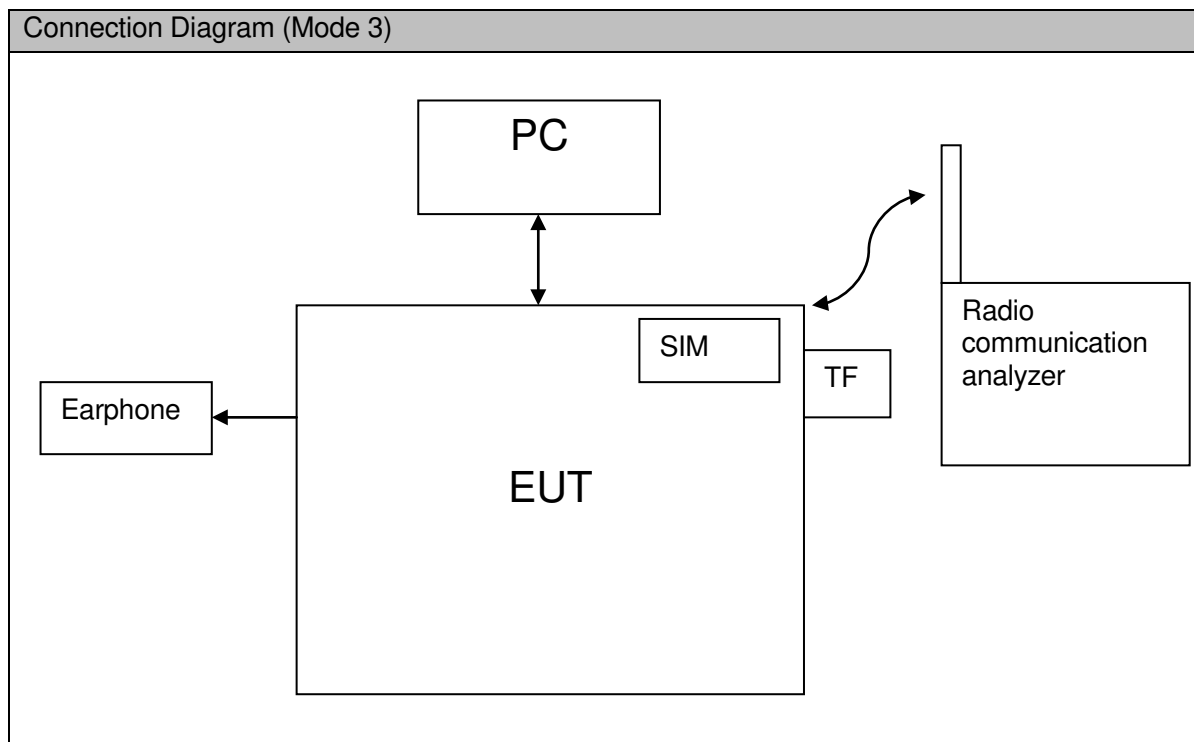

### 3.3 Cables Used during Test

Cable	Quantity	Length	Type of Cable
USB	1	<3m	shielded
Earphone	1	<3m	unshielded

### 3.4 Associated Equipment Used during Test

Name	Model	Manufacturer	S/N	Calibrated dateline	Cal interval (month)
Radio Communication Tester	CMU200	R&S	117057	2014-10-28	12
PC	X200	Lenovo	3108052581	/	/
TF Card	2G	Kingston	1040RE5672k	/	/

## 4 Electromagnetic Interference (EMI)

### 4.1 Radiated Disturbance 30MHz to 18GHz

#### 4.1.1 Test Procedure

The test site semi-anechoic chamber has met the requirement of NSA tolerance 4dB according to the standards: ANSI C63.4-2009. The test distance was 3m. The set-up and test methods were according to ANSI C63.4-2009.

A preliminary scan and a final scan of the emissions were made from 30 MHz to 18 GHz by using test script of software; The emissions were measured using Quasi-Peak Detector (30MHz~1GHz) and AV/PK detector (above 1GHz). The maximal emission value was acquired by adjusting the antenna height, polarisation and turntable azimuth in accordance with the software setup. Normally, the height range of antenna was 1m to 4m. The azimuth range of turntable was 0° to 360°. The receiving antenna has two polarizations V and H.

Measurement bandwidth (RBW) for 30MHz to 1000 MHz: 120 kHz;

Measurement bandwidth (RBW) for 1000MHz to 18000 MHz: 1MHz;

EUT was configured in idle mode and the test performed at worst emission state.

#### 4.1.2 Test setup

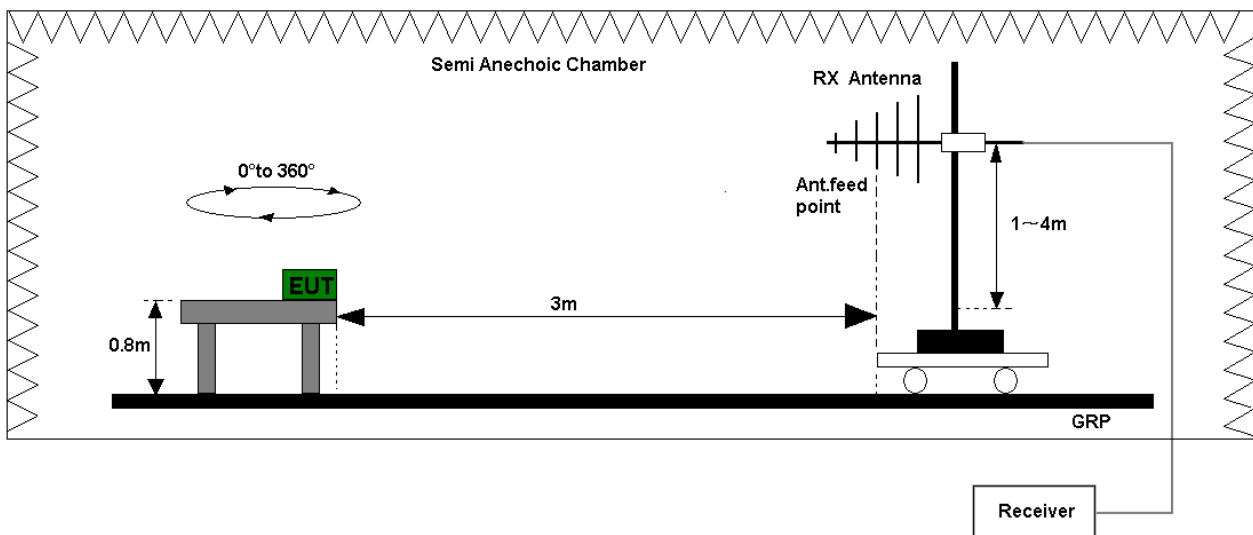

Figure 1. Test set-up of radiated disturbance(30MHz-1GHz)

Figure 2.

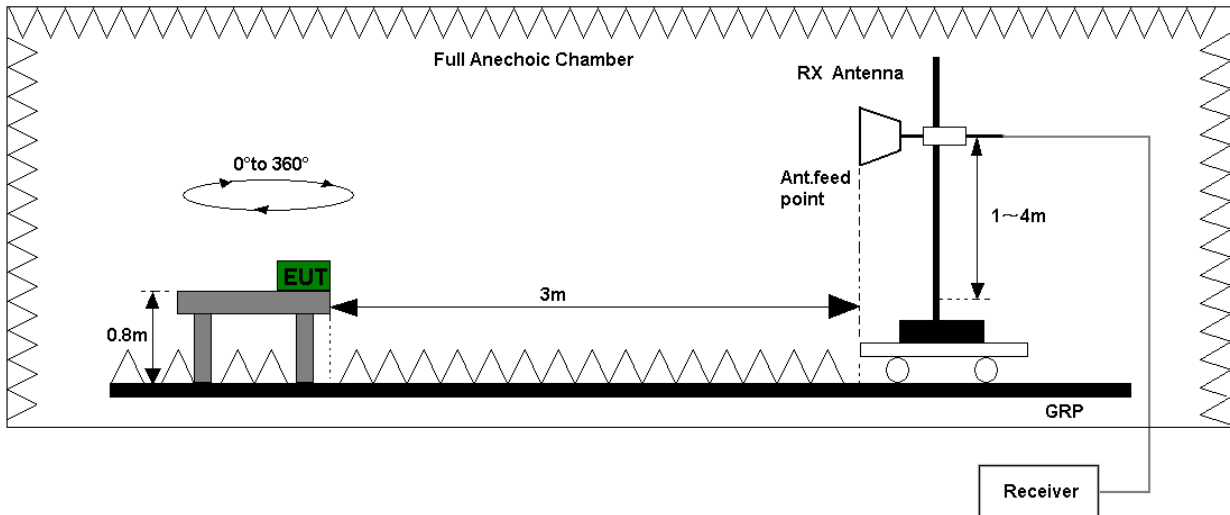

Figure 3. Test set-up of radiated disturbance(above 1GHz)

### 4.1.3 Test Results

The EUT has met the requirements for Radiated Emission of enclosure port. Refer to the section 7.1 of this report for test data.

Test Limits (Class B)				
Frequency of Emission (MHz)	Radiated Limit			
	Unit( $\mu\text{V}/\text{m}$ )		Unit( $\text{dB}\mu\text{V}/\text{m}$ )	
30-88	100		40	
88-216	150		43.5	
216-960	200		46	
Above 960	500		54	
Above 1000	AV	PK	AV	PK
	500	5000	54	74

## 4.2 Conducted Disturbance 0.15 MHz to 30MHz

### 4.2.1 Test Procedure

The Table-top EUT was placed upon a non-metallic table 0.8 m above the horizontal metal reference ground plane. EUT was connected to LISN and LISN was connected to reference Ground Plane. EUT was 80cm away from LISN. The set-up and test methods were according to ANSI C63.4-2009. Conducted Disturbance at AC Port measurements were undertaken on the L and N Lines. The emissions were measured using a Quasi-Peak Detector and Average Detector. EUT was communicated with the simulator through Air interface, the simulator controls the EUT to transmitter the maximum power which defined in specification of product. The EUT operated on the typical channel.

Measurement bandwidth (RBW) for 150 kHz to 30 MHz: 9 kHz;

The EUT was set in the shielded chamber and operated under nominal conditions.

### 4.2.2 Test Setup

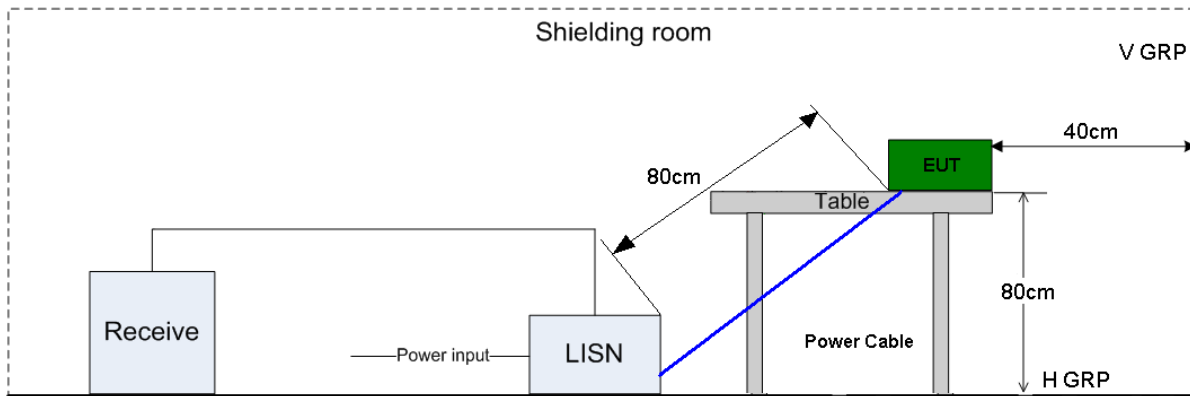

Figure 4. Test Set-up of conducted disturbance

### 4.2.3 Test Results

The EUT has met requirements for Conducted disturbance of power lines.

Refer to the section 7.2 of this report for test data.

Test Limit of AC Power Port		
Frequency range	150kHz ~ 30MHz	
Frequency	Voltage limits	
	QP (dB $\mu$ V)	AV (dB $\mu$ V)
0.15MHz~0.5MHz	66-56	56-46
0.5MHz-5MHz	56	46
5MHz~30MHz	60	50

## 5 Main Test Instruments

Main Test Equipments						
Test item	Test Instrument	Model	S/N	Manufacturer	Calibrated Deadline	Cal interval
RE	EMI Test receiver	ESU26	100387	R&S	Jun.05, 2014	12
	Broadband Antenna	VULB 9163	9163-491	SCHWARZ BECK	Feb.01, 2015	24
	Horn Antenna	HF907	10305	R&S	Feb.01,2015	24
CE	EMI Test receiver	ESCI	101163	R&S	Dec.23, 2014	12
	Artificial Mains Network	ENV216	100382	R&S	Dec.23, 2014	12
Software Information						
Test Item	Software Name	Manufacturer		Version		
RE	EMC 32	R&S		V8.40.0		
CE	EMC 32	R&S		V8.40.0		

## 6 System Measurement Uncertainty

For a 95% confidence level, the measurement expanded uncertainties for defined systems, in accordance with the recommendations of ISO 17025 were:

System Measurement Uncertainty		
Items		Extended Uncertainty
RE(30MHz-1GHz)	Field strength (dB $\mu$ V/m)	U=4.2dB; k=2
RE(1GHz-18GHz)	Field strength (dB $\mu$ V/m)	U=5.3dB; k=2
CE	Disturbance Voltage (dB $\mu$ V)	U=2.6dB; k=2

## 7 Test Data and Graph

Only the worst test results were shown

### 7.1 Radiated Disturbance

#### 7.1.1 30MHz~1GHz

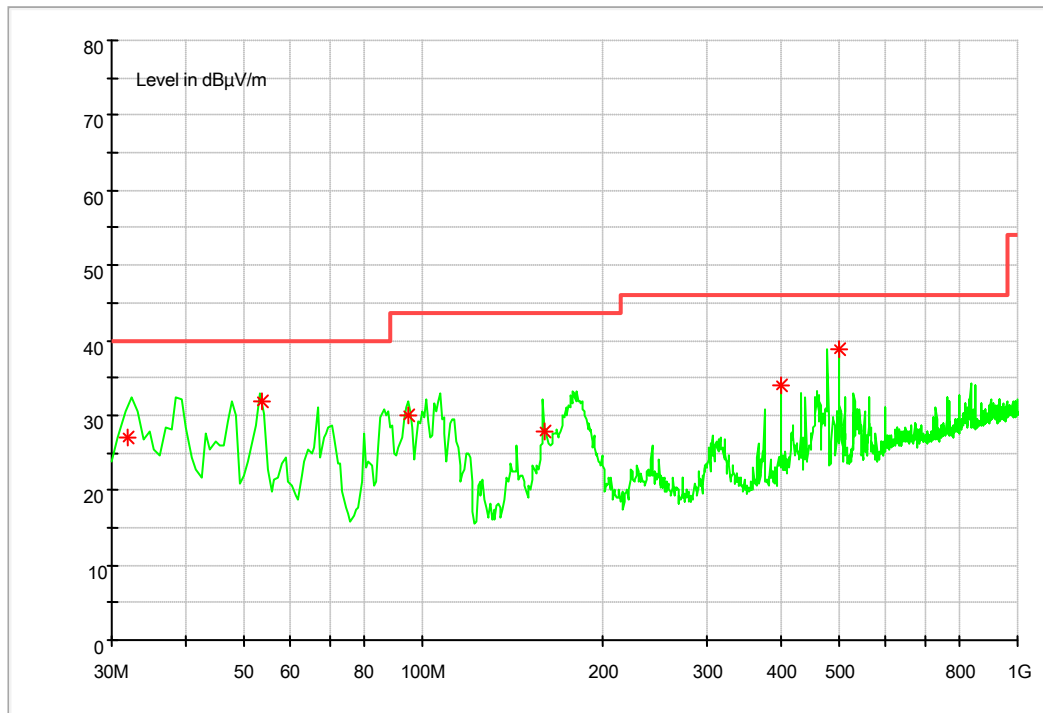

#### MEASUREMENT RESULT: QP Detector

Frequency MHz	Level dBμV/m	Transducer dB	Limit dBμV/m	Margin dB	Height cm	Azimuth deg	Polarisation
32.020800	27.1	14.1	40.0	12.9	100.0	295.0	VERTICAL
53.569920	31.7	14.7	40.0	8.3	400.0	176.0	HORIZONTAL
94.384960	29.9	12.7	43.5	13.6	386.0	307.0	HORIZONTAL
160.014400	27.9	10.8	43.5	15.6	114.0	96.0	VERTICAL
400.027200	34.1	18.0	46.0	11.9	400.0	258.0	VERTICAL
500.039040	38.8	19.8	46.0	7.2	187.0	102.0	HORIZONTAL

Note:

Level = Reading level by receiver + Transd (Antenna factor + cable loss – preamplifier gain)

The reading level is calculated by software which is not shown in the sheet.

## 7.1.2 1GHz~18GHz

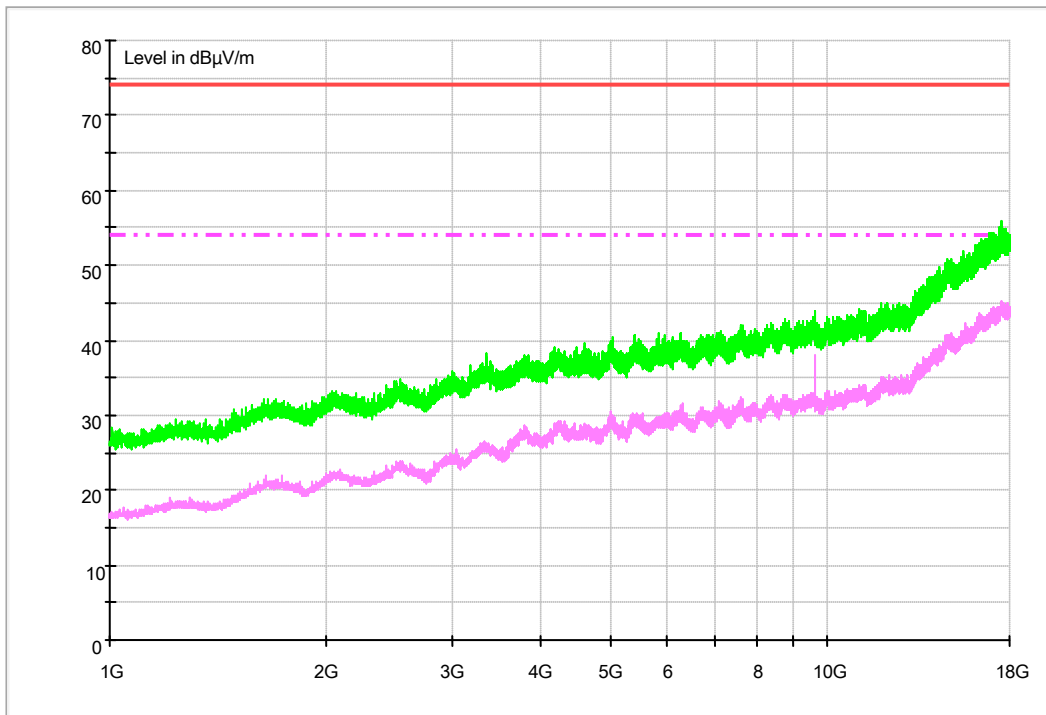

Note:

Level = Reading level by receiver + Transd (Antenna factor + cable loss – preamplifier gain)

The reading level is calculated by software which is not shown in the sheet.

## 7.2 Conducted Disturbance

### 7.2.1 AC Port Test Data

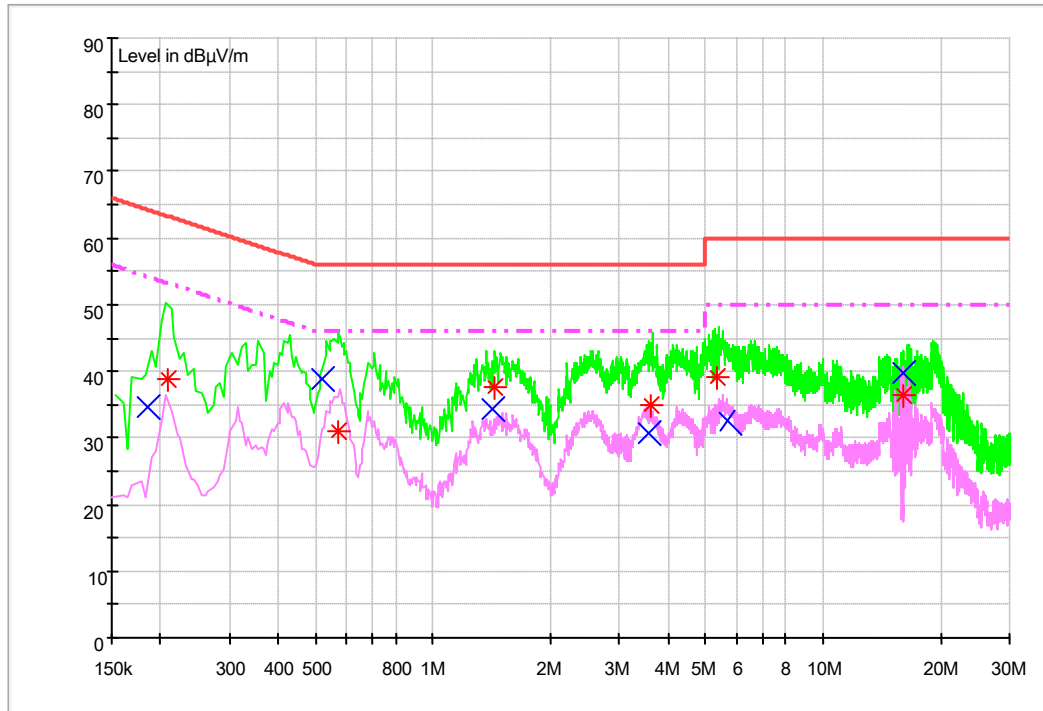

#### MEASUREMENT RESULT: QP Detector

Frequency MHz	Level dBµV	Transducer dB	Limit dBµV	Margin dB	Line	PE
0.208479	38.9	9.7	63.3	24.4	N	FLO
0.570506	31.0	9.7	56.0	25.0	L1	FLO
1.435069	37.6	9.7	56.0	18.4	L1	FLO
3.602164	34.9	9.8	56.0	21.1	L1	FLO
5.358150	39.1	9.8	60.0	20.9	L1	FLO
15.970714	36.5	10.0	60.0	23.5	L1	FLO

#### MEASUREMENT RESULT: AV Detector

Frequency MHz	Level dBµV	Transducer dB	Limit dBµV	Margin dB	Line	PE
0.186219	34.7	9.7	54.2	19.5	L1	FLO
0.333322	31.0	9.7	49.4	18.4	L1	FLO
0.516547	39.0	9.7	46.0	7.0	L1	FLO
1.416199	34.3	9.7	46.0	11.7	L1	FLO
3.549622	30.6	9.8	46.0	15.4	L1	FLO
15.966975	39.6	10.0	50.0	10.4	L1	FLO

Note:

Level= Reading level+ Transd (cable loss + correction factor)

The reading level is calculated by software which is not shown in the sheet.

-----**END**-----