

FCC DFS Test Report

FCC ID: QISS8-302L

This report concerns (check one): Original Grant Class II Change

Project No. : 1406C083
Equipment : HUAWEI MediaPad M1 8.0
Model Name : S8-302L
Applicant : Huawei Technologies Co.,Ltd.
Address : Administration Building, Headquarters of
Huawei Technologies Co., Ltd., Bantian,

Tested by: BTL Inc. EMC Laboratory

Date of Receipt: Jun. 12, 2014

Date of Test: Jun. 12, 2014 ~ Jun. 18, 2014

Issued Date: Jun. 19, 2014

Testing Engineer : David Mao
(David Mao)

Technical Manager : Leo Hung
(Leo Hung)

Authorized Signatory : Steven Lu
(Steven Lu)

BTL INC.

No.3,Jinshagang 1st Road, ShiXia,
Dalang Town, Dong Guan, China.

TEL: 0769-8318-3000

FAX: 0769-8319-6000

Declaration

BTL represents to the client that testing is done in accordance with standard procedures as applicable and that test instruments used has been calibrated with the standards traceable to National Measurement Laboratory (**NML**) of **R.O.C.**, or National Institute of Standards and Technology (**NIST**) of **U.S.A.**

BTL's reports apply only to the specific samples tested under conditions. It is manufacture's responsibility to ensure that additional production units of this model are manufactured with the identical electrical and mechanical components. **BTL** shall have no liability for any declarations, inferences or generalizations drawn by the client or others from **BTL** issued reports.

BTL's reports must not be used by the client to claim product endorsement by the authorities or any agency of the Government.

This report is the confidential property of the client. As a mutual protection to the clients, the public and **BTL-self**, extracts from the test report shall not be reproduced except in full with **BTL's** authorized written approval.

BTL's laboratory quality assurance procedures are in compliance with the **ISO Guide 17025** requirements, and accredited by the conformity assessment authorities listed in this test report.

Limitation

For the use of the authority's logo is limited unless the Test Standard(s)/Scope(s)/Item(s) mentioned in this test report is (are) included in the conformity assessment authorities acceptance respective.

Table of Contents	Page
1 . CERTIFICATION	5
2 . EUT INFORMATION	6
2.1 EUT SPECIFICATION TABLE	6
2.4 EUT MAXIMUM AND MINIMUM E.I.R.P. POWER	8
3 . U-NII DFS RULE REQUIREMENTS	9
3.1 WORKING MODES AND REQUIRED TEST ITEMS	9
3.2 TEST LIMITS AND RADAR SIGNAL PARAMETERS	10
4 . TEST INSTRUMENTS	12
5 . EMC EMISSION TEST	13
5.1 DFS MEASUREMENT SYSTEM:	13
5.2 CALIBRATION OF DFS DETECTION THRESHOLD LEVEL:	15
5.3 DEVIATION FROM TEST STANDARD	15
6 . TEST RESULTS	16
6.1 SUMMARY OF TEST RESULT	16
6.2 DELETED TEST RESULTS	17
6.2.1 TEST MODE: DEVICE OPERATING IN MASTER MODE.	17
6.2.2 DFS DETECTION THRESHOLD	17
6.2.4 CHANNEL CLOSING TRANSMISSION AND CHANNEL MOVE TIME WLAN TRAFFIC	21
6.2.5 NON- OCCUPANCY PERIOD	47



REPORT ISSUED HISTORY

Issued No.	Description	Issued Date
NEI-FCCP-3-1406C083	Original Issue.	Jun. 19, 2014

1. CERTIFICATION

Equipment : HUAWEI MediaPad M1 8.0
Trade Name : HUAWEI
Model Name. : S8-302L
Applicant : Huawei Technologies Co.,Ltd.
Manufacturer : Huawei Technologies Co.,Ltd.
Address : Administration Building, Huawei Base, Bantian, Longgang District ,Shenzhen 518129, P.R.China
Factory : Huawei Technologies Co.,Ltd.
Address : Huawei Base, Bantian, Longgang District, Shenzhen 518129, P.R.China
Date of Test: : Jun. 12, 2014 ~ Jun. 18, 2014
Test Item : ENGINEERING SAMPLE
Standard(s) : FCC Part 15, Subpart E (Section 15.407) FCC 06-96

The above equipment has been tested and found compliance with the requirement of the relative standards by BTL Inc. EMC Laboratory.

The test data, data evaluation, and equipment configuration contained in our test report (Ref No. NEI-FCCP-3-1406C083) were obtained utilizing the test procedures, test instruments, test sites that has been accredited by the Authority of TAF according to the ISO-17025 quality assessment standard and technical standard(s).



2. EUT INFORMATION

2.1 EUT SPECIFICATION TABLE

Table 1: Specification of EUT

Product name	HUAWEI MediaPad M1 8.0
Brand Name	HUAWEI
Model	S8-302L
FCC ID	QISS8-302L
Operational Mode	Slave
Operating Frequency Range	5150MHz~5350MHz&5470MHz~5725MHz
Modulation	OFDM

Note: This device was functioned as a Master Slave device during the DFS

2.2 DESCRIPTION OF AVAILABLE ANTENNAS TO THE EUT

Table 2: Antenna list.

Ant.	Brand	Model Name	Antenna Type	Connector	Gain (dBi)	Note
1	SkyCross.inc, Shanghai. Branch	N/A	Monopole Antenna	N/A	2.55	TX/RX



2.3 CONDUCTED OUTPUT POWER AND EIRP POWER

TABLE 3: THE CONDUCTED OUTPUT POWER LIST

TX (11a)

FREQUENCY BAND (MHz)	MAX. POWER	
	OUTPUT POWER(dBm)	OUTPUT POWER(mW)
5150~5250	12.89	19.4536
5250~5350	12.97	19.8153
5470~5725	12.98	19.8609

TX (11n 20MHz)

FREQUENCY BAND (MHz)	MAX. POWER	
	OUTPUT POWER(dBm)	OUTPUT POWER(mW)
5150~5250	12.69	18.5780
5250~5350	12.74	18.7932
5470~5725	12.85	19.2752



2.4 EUT MAXIMUM AND MINIMUM E.I.R.P. POWER

TABLE 4: THE MAX EIRP LIST

TX (11a)

FREQUENCY BAND (MHz)	MAX. POWER	
	OUTPUT POWER(dBm)	OUTPUT POWER(mW)
5150~5250	15.44	34.9945
5250~5350	15.52	35.6451
5470~5725	15.53	35.7273

TX (11n 20MHz)

FREQUENCY BAND (MHz)	MAX. POWER	
	OUTPUT POWER(dBm)	OUTPUT POWER(mW)
5150~5250	15.24	33.4195
5250~5350	15.29	33.8065
5470~5725	15.40	34.6737



3. U-NII DFS RULE REQUIREMENTS

3.1 WORKING MODES AND REQUIRED TEST ITEMS

The manufacturer shall state whether the UUT is capable of operating as a Master and/or a Client. If the UUT is capable of operating in more than one operating mode then each operating mode shall be tested separately. See tables 1 and 2 for the applicability of DFS requirements for each of the operational modes.

Table 5: Applicability of DFS requirements prior to use a channel

Requirement	Operational Mode		
	Master	Client without radar detection	Client with radar detection
Non-Occupancy Period	✓	Not required	✓
DFS Detection Threshold	✓	Not required	✓
Channel Availability Check Time	✓	Not required	Not required
Uniform Spreading	✓	Not required	Not required
U-NII Detection Bandwidth	✓	Not required	✓

Table 6: Applicability of DFS requirements during normal operation.

Requirement	Operational Mode		
	Master	Client without radar detection	Client with radar detection
DFS Detection Threshold	✓	Not required	✓
Channel Closing Transmission Time	✓	✓	✓
Channel Move Time	✓	✓	✓
U-NII Detection Bandwidth	✓	Not required	✓



3.2 TEST LIMITS AND RADAR SIGNAL PARAMETERS

DETECTION THRESHOLD VALUES

Table 7: DFS Detection Thresholds for Master Devices and Client Devices With Radar Detection.

Maximum Transmit Power	Value (See Notes 1 and 2)
≥ 200 milliwatt	-64 dBm
< 200 milliwatt	-62 dBm

Note 1: This is the level at the input of the receiver assuming a 0 dBi receive antenna.

Note 2: Throughout these test procedures an additional 1 dB has been added to the amplitude of the test transmission waveforms to account for variations in measurement equipment. This will ensure that the test signal is at or above the detection threshold level to trigger a DFS response.

Table 8: DFS Response Requirement Values

Parameter	Value
Non-occupancy period	Minimum 30 minutes
Channel Availability Check Time	60 seconds
Channel Move Time	10 seconds See Note 1.
Channel Closing Transmission Time	200 milliseconds + an aggregate of 60 milliseconds over remaining 10 second period. See Notes 1 and 2.
U-NII Detection Bandwidth	Minimum 80% of the UNII 99% transmission power bandwidth. See Note 3.

Note 1: The instant that the Channel Move Time and the Channel Closing Transmission Time begins is as follows:

- For the Short Pulse Radar Test Signals this instant is the end of the Burst.
- For the Frequency Hopping radar Test Signal, this instant is the end of the last radar Burst generated.
- For the Long Pulse Radar Test Signal this instant is the end of the 12 second period defining the Radar Waveform.

Note 2: The Channel Closing Transmission Time is comprised of 200 milliseconds starting at the beginning of the Channel Move Time plus any additional intermittent control signals required to facilitate a Channel move (an aggregate of 60 milliseconds) during the remainder of the 10 second period. The aggregate duration of control signals will not count quiet periods in between transmissions.

Note 3: During the U-NII Detection Bandwidth detection test, radar type 1 is used and for each frequency step the minimum percentage of detection is 90 percent. Measurements are performed with no data traffic.



PARAMETERS OF DFS TEST SIGNALS

Step intervals of 0.1 microsecond for Pulse Width, 1 microsecond for PRI, 1 MHz for chirp width and 1 for the number of pulses will be utilized for the random determination of specific test waveforms.

Table 9: Short Pulse Radar Test Waveforms.

Radar Type	Pulse Width (μsec)	PRI (μsec)	Number of Pulses	Minimum Percentage of Successful Detection	Minimum Number of Trials
1	1	1428	18	60%	30
2	1-5	150-230	23-29	60%	30
3	6-10	200-500	16-18	60%	30
4	11-20	200-500	12-16	60%	30
Aggregate (Radar Types 1-4)				80%	120

Table 10: Long Pulse Radar Test Waveform

Radar Type	Pulse Width (μsec)	Chirp Width (MHz)	PRI (μsec)	Number of Pulses per Burst	Number of Bursts	Minimum Percentage of Successful Detection	Minimum Number of Trials
5	50-100	5-20	1000-2000	1-3	8-20	80%	30

Table 11: Frequency Hopping Radar Test Waveform

Radar Type	Pulse Width (μsec)	Chirp Width (MHz)	PRI (μsec)	Number of Pulses per Burst	Number of Bursts	Minimum Percentage of Successful Detection	Minimum Number of Trials
6	1	333	9	0.333	300	70%	30



4. TEST INSTRUMENTS

Table 1: Test instruments list.

DESCRIPTION	MANUFACTURER	MODEL NO.	Serial No	Calibration Until
EXA Spectrum Analyzer	Agilent	N9010A	MY50520044	Mar. 29, 2015
Signal Generator	Agilent	E4438C	MY49071316	Mar. 29, 2015
POWER SPLITTER	Mini-Circuits	ZFRSC-123-S+	331000910-1	Mar. 29, 2015
POWER SPLITTER	Mini-Circuits	ZN4PD1-63-S+	SF9335D1045-1	Mar. 29, 2015
Attenuator	WOKEN	6SM3502	VAS1214NL	Mar. 29, 2015
Spectrum Analyzer	R&S	FSL 6	100423	Nov. 11, 2014

Note: Calibration interval of instruments listed above is one year.

5. EMC EMISSION TEST

5.1 DFS MEASUREMENT SYSTEM:

CONDUCTED METHOD SYSTEM BLOCK DIAGRAM

Master Conducted Measurement

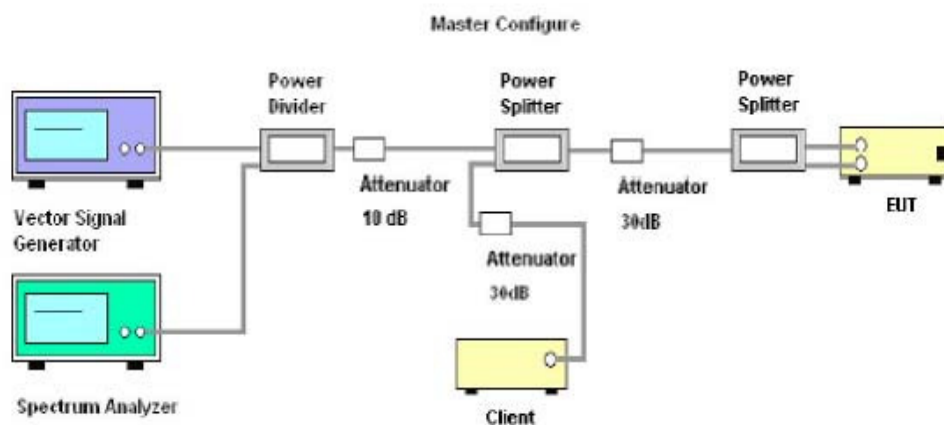

Slave without Radar Detection Conducted Measurement

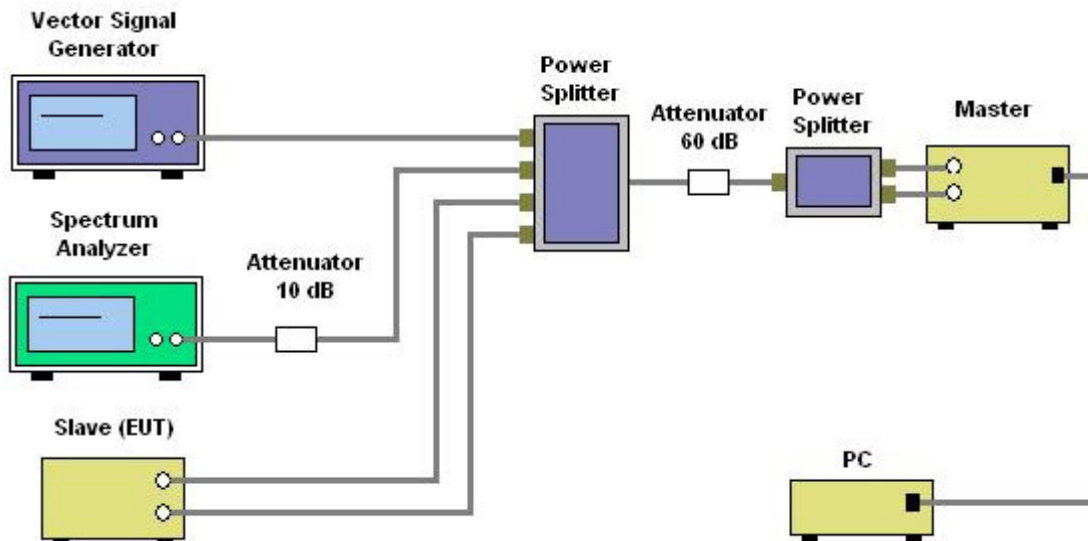

SYSTEM OVERVIEW

The short pulse and long pulse signal generating system utilizes the NTIA software. The Vector Signal Generator has been validated by the NTIA. The hopping signal generating system utilizes the CCS simulated hopping method and system, which has been validated by the DoD, FCC and NTIA. The software selects waveform parameters from within the bounds of the signal type on a random basis using uniform distribution.

The short pulse types 2, 3 and 4, and the long pulse type 5 parameters are randomized at run-time.



The hopping type 6 pulse parameters are fixed while the hopping sequence is based on the August 2005 NTIA Hopping Frequency List. The initial starting point randomized at run-time and each subsequent starting point is incremented by 475. Each frequency in the 100-length segment is compared to the boundaries of the EUT Detection Bandwidth and the software creates a hopping burst pattern in accordance with Section 7.4.1.3 Method #2 Simulated Frequency Hopping Radar Waveform Generating Subsystem of FCC 06-96. The frequency of the signal generator is incremented in 1 MHz steps from FL to FH for each successive trial. This incremental sequence is repeated as required to generate a minimum of 30 total trials and to maintain a uniform frequency distribution over the entire Detection Bandwidth.

The signal monitoring equipment consists of a spectrum analyzer set to display 8001 bins on the horizontal axis. The time-domain resolution is 2 msec / bin with a 16 second sweep time, meeting the 10 second short pulse reporting criteria. The aggregate ON time is calculated by multiplying the number of bins above a threshold during a particular observation period by the dwell time per bin, with the analyzer set to peak detection and max hold.

Should multiple RF ports be utilized for the Master and/or Slave devices (for example, for diversity or MIMO implementations), additional combiner/dividers are inserted between the Master Combiner/Divider and the pad connected to the Master Device (and/or between the Slave Combiner/Divider and the pad connected to the Slave Device). Additional pads are utilized such that there is one pad at each RF port on each EUT.



5.2 CALIBRATION OF DFS DETECTION THRESHOLD LEVEL:

A 50 ohm load is connected in place of the spectrum analyzer, and the spectrum analyzer is connected in place of the master device and the signal generator is set to CW mode. The amplitude of the signal generator is adjusted to yield a level of -62 dBm as measured on the spectrum analyzer.

Without changing any of the instrument settings, the spectrum analyzer is reconnected to the Common port of the Spectrum Analyzer Combiner/Divider. Measure the amplitude and calculate the difference from -62 dBm. Adjust the Reference Level Offset of the spectrum analyzer to this difference.

The spectrum analyzer displays the level of the signal generator as received at the antenna ports of the Master Device. The interference detection threshold may be varied from the calibrated value of -62 dBm and the spectrum analyzer will still indicate the level as received by the Master Device.

Set the signal generator to produce a radar waveform, trigger a burst manually and measure the level on the spectrum analyzer. Readjust the amplitude of the signal generator as required so that the peak level of the waveform is at a displayed level equal to the required or desired interference detection threshold. Separate signal generator amplitude settings are determined as required for each radar type.

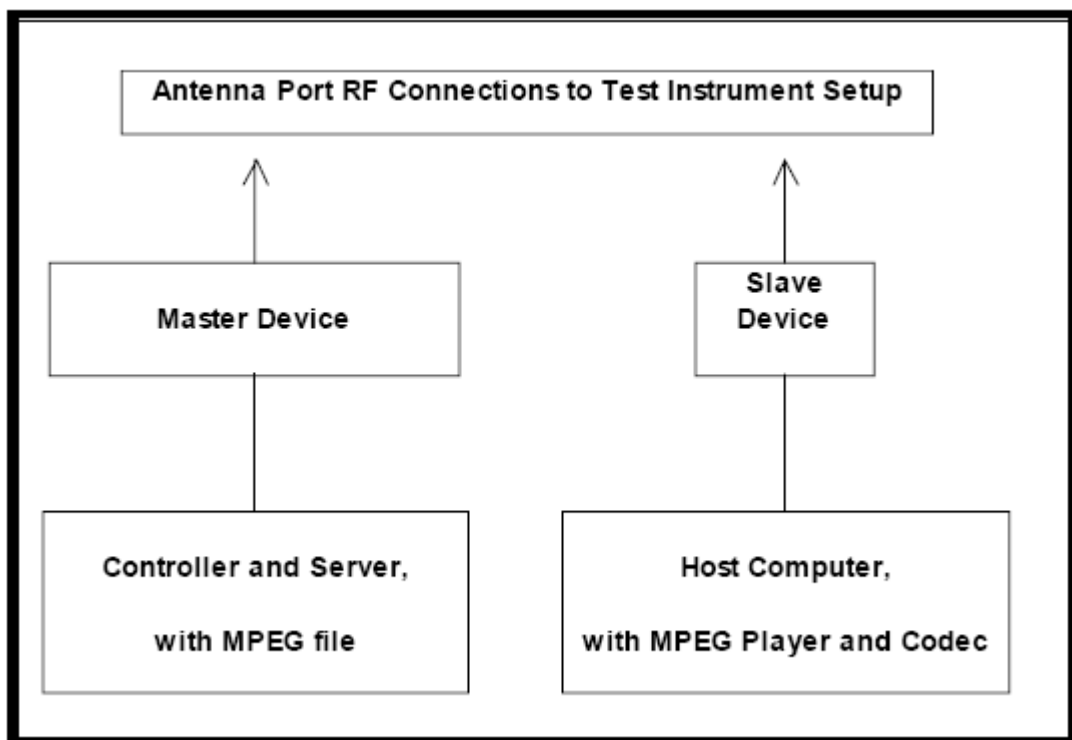

5.3 DEVIATION FROM TEST STANDARD

No deviation.



6. TEST RESULTS

6.1 SUMMARY OF TEST RESULT

Clause	Test Parameter	Remarks	Pass/Fail
15.407	DFS Detection Threshold	No Applicable	N/A
15.407	Channel Availability Check Time	Not Applicable	N/A
15.407	Channel Move Time	Applicable	Pass
15.407	Channel Closing Transmission Time	Applicable	Pass
15.407	Non- Occupancy Period	Applicable	Pass
15.407	Uniform Spreading	Not Applicable	N/A
15.407	U-NII Detection Bandwidth	Not Applicable	N/A



6.2 DETELED TEST RESULTS

Clause	Test Parameter	Remarks	Pass/Fail
15.407	DFS Detection Threshold	No Applicable	N/A
15.407	Channel Availability Check Time	Not Applicable	N/A
15.407	Channel Move Time	Applicable	Pass
15.407	Channel Closing Transmission Time	Applicable	Pass
15.407	Non- Occupancy Period	Applicable	Pass
15.407	Uniform Spreading	Not Applicable	N/A
15.407	U-NII Detection Bandwidth	Not Applicable	N/A

6.2.1 TEST MODE: DEVICE OPERATING IN MASTER MODE.

The EUT is slave equipment, it need a master device when testing.
 Master with injection at the Master. (Radar Test Waveforms are injected into the Master)

6.2.2 DFS DETECTION THRESHOLD

Calibration:

The EUT is slave equipment and it with a max gain is 2.55dBi
 For a detection threshold level of -62dBm and the master antenna gain is 3dBi, required detection threshold is -59dBm (= -62+3).

Note: Maximum Transmit Power is less than 200 milliwatt in this report, so detection threshold level is -62dBm (please refer to Table 7 [page 8]).



Radar Signal 1

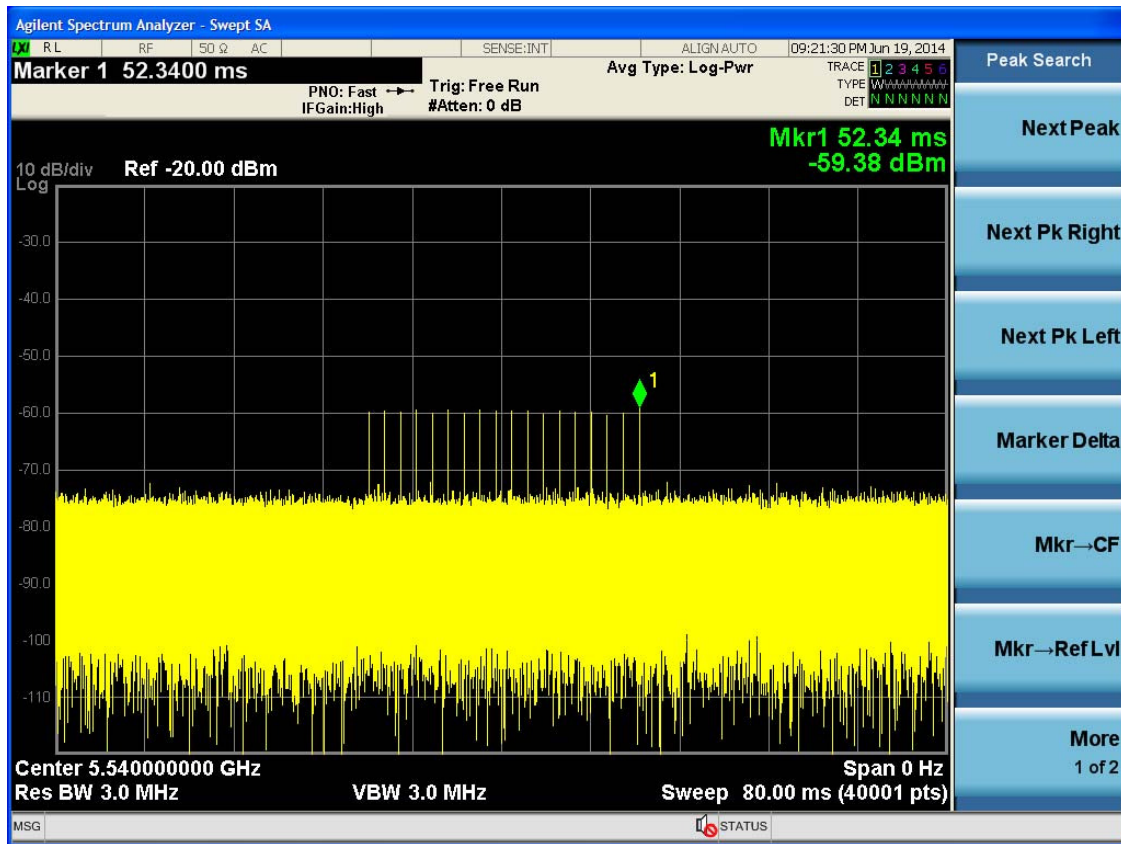

Radar Signal 2

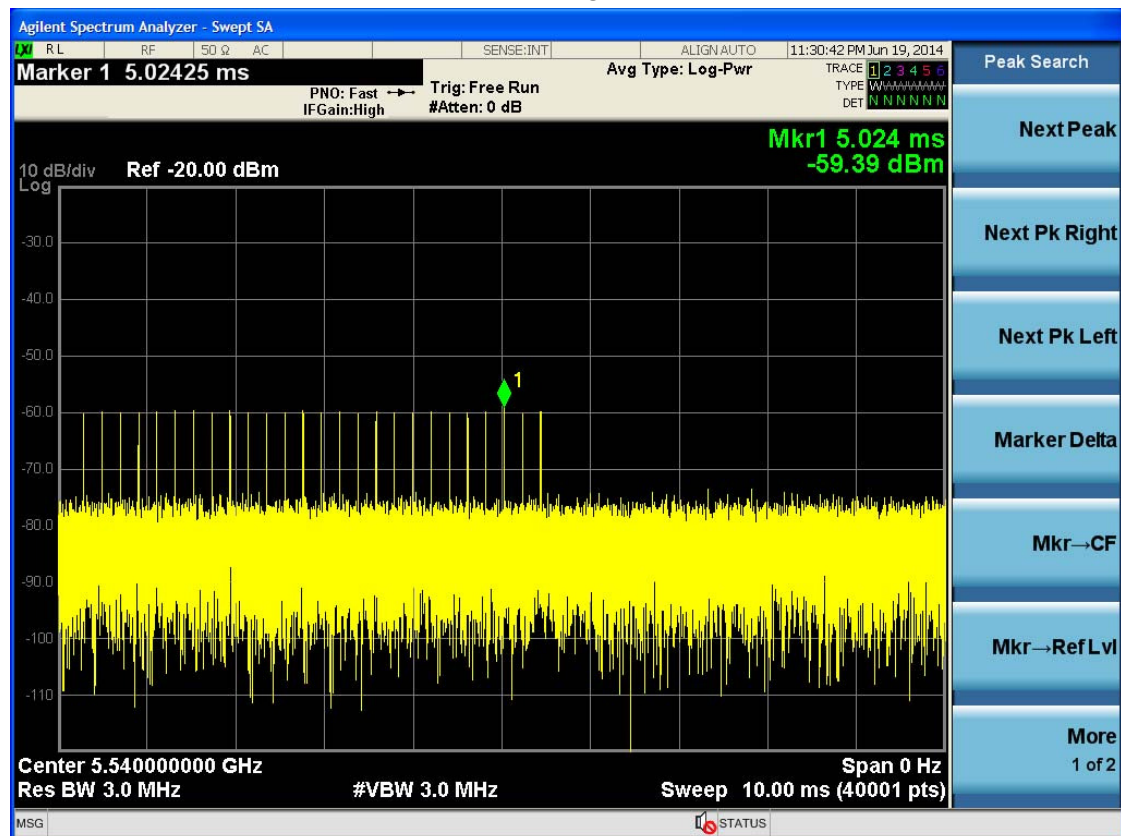



Radar Signal 5

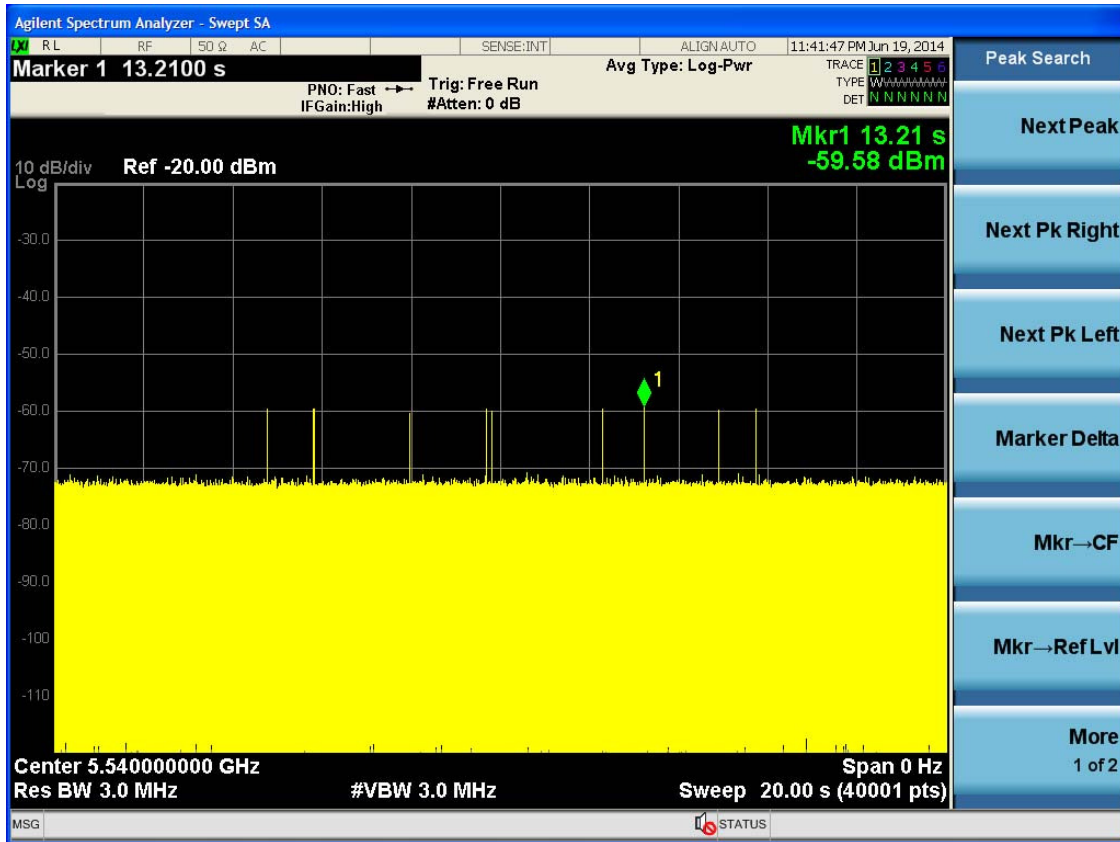

Radar Signal 6

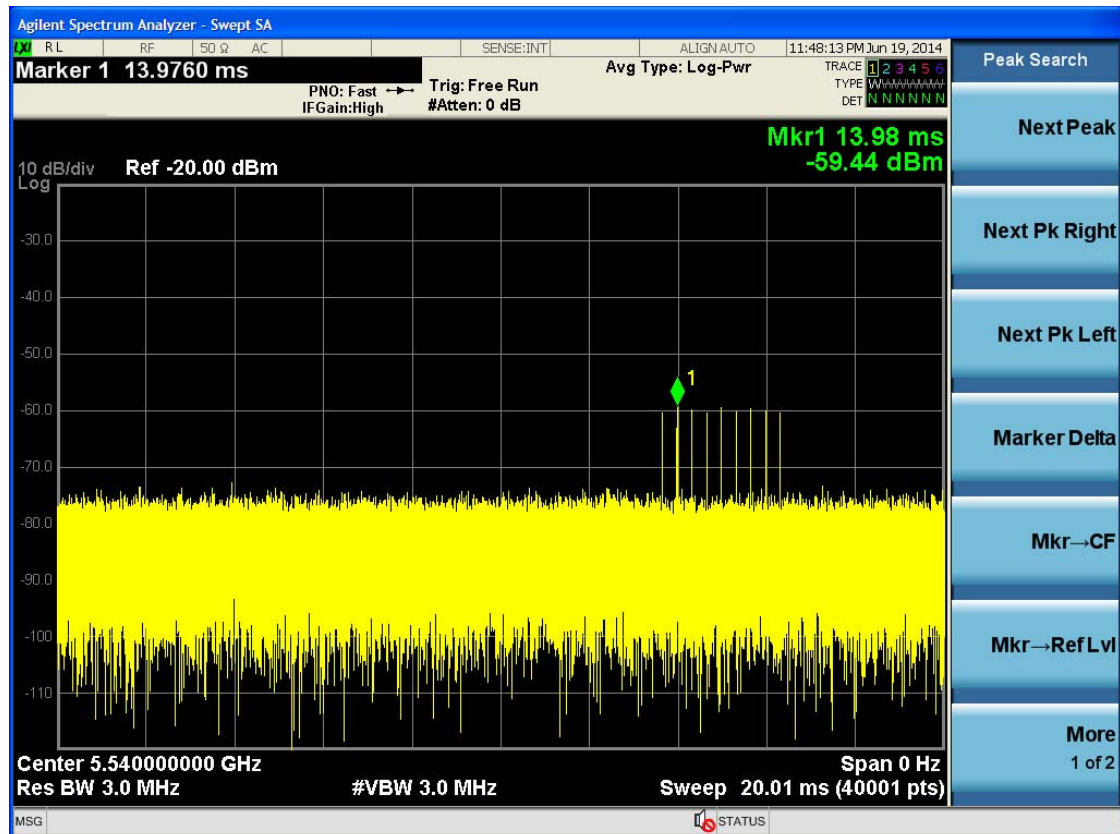



6.2.4 CHANNEL CLOSING TRANSMISSION AND CHANNEL MOVE TIME WLAN TRAFFIC

TX (11a Mode)

Table 1: Short Pulse Radar Test Waveforms.

Radar Type	Pulse Width (µsec)	PRI (µsec)	Number of Pulses	Pass times	Fail times	Percentage of Successful Detection (%)
1	1	1428	18	28	2	93%
2	1-5	150-230	23-29	29	1	97%
3	6-10	200-500	16-18	27	3	90%
4	11-20	200-500	12-16	27	3	90%
Aggregate (Radar Types 1-4)			-	111	9	93%

Table 2: Long Pulse Radar Test Waveform

Radar Type	Pulse Width (µsec)	Chirp Width (MHz)	PRI (µsec)	Number of Pulses Per Burst	Number of Bursts	Pass times	Fail times	Percentage of Successful Detection (%)
5	50-100	5-20	1000-2000	1-3	8-20	29	1	97%

Table 3: Frequency Hopping Radar Test Waveform

Radar Type	Pulse Width (µsec)	PRI (µsec)	Pulses per Hop	Hopping Rate (kHz)	Hopping Sequence Length (msec)	Pass times	Fail times	Percentage of Successful Detection (%)
6	1	333	9	0.333	300	27	3	90%



TX (11a Mode)

Radar signal 2

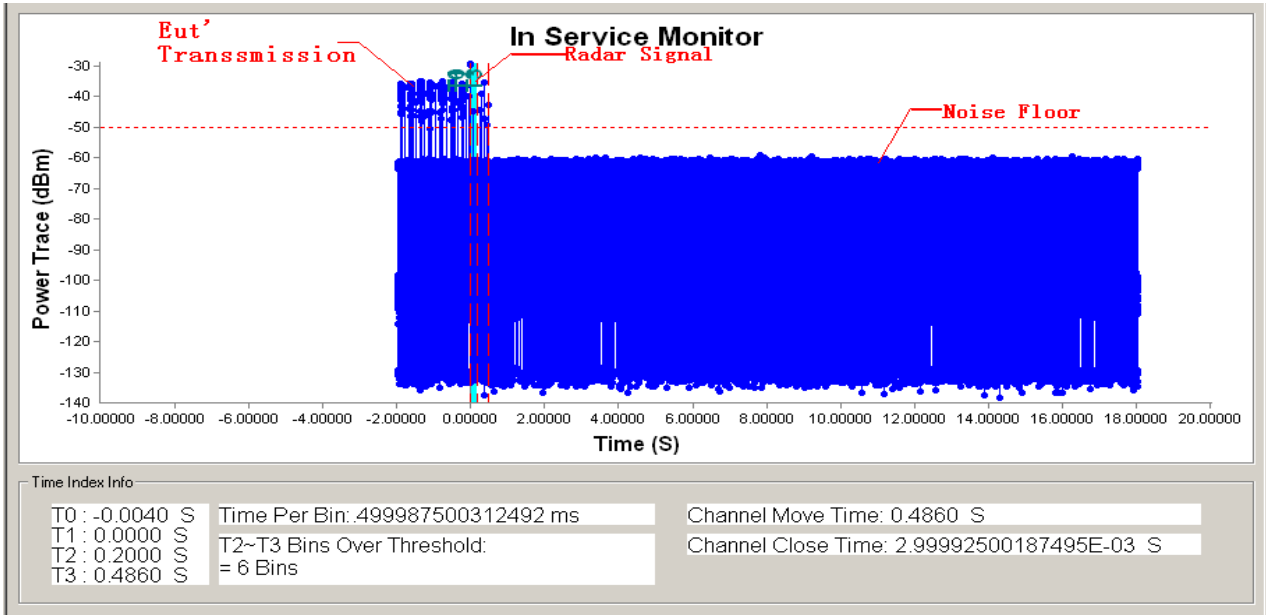

Note: T1 denotes the start of Channel Move Time upon the end of the last Radar burst.
 T2 denotes the data transmission time of 200ms from T1.
 T3 denotes the end of Channel Move Time.
 T4 denotes the 10 second from T1 to observe the aggregate duration of transmissions.

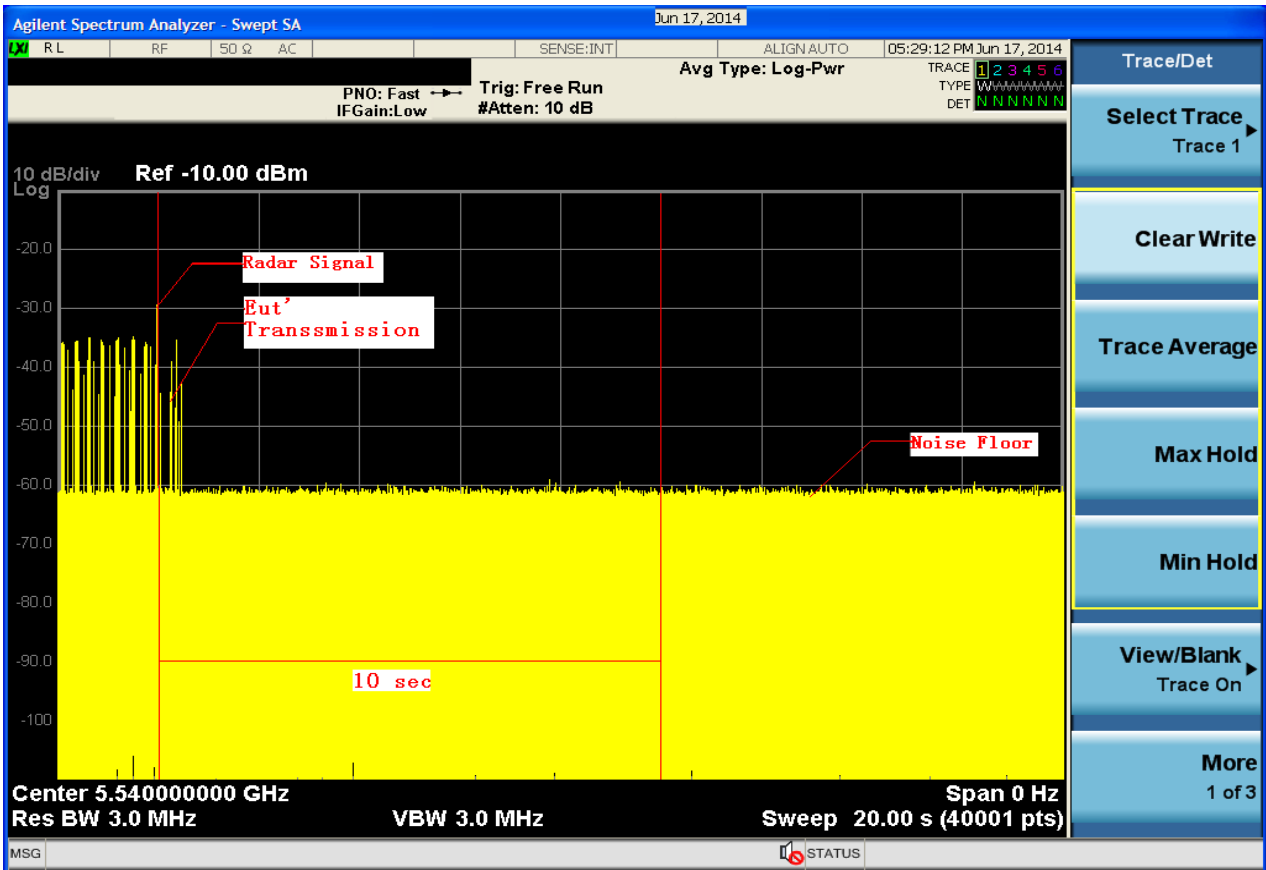

Note: An expanded plot for the device vacates the channel in the required 500ms



TX (11a Mode)

Radarsignal 3

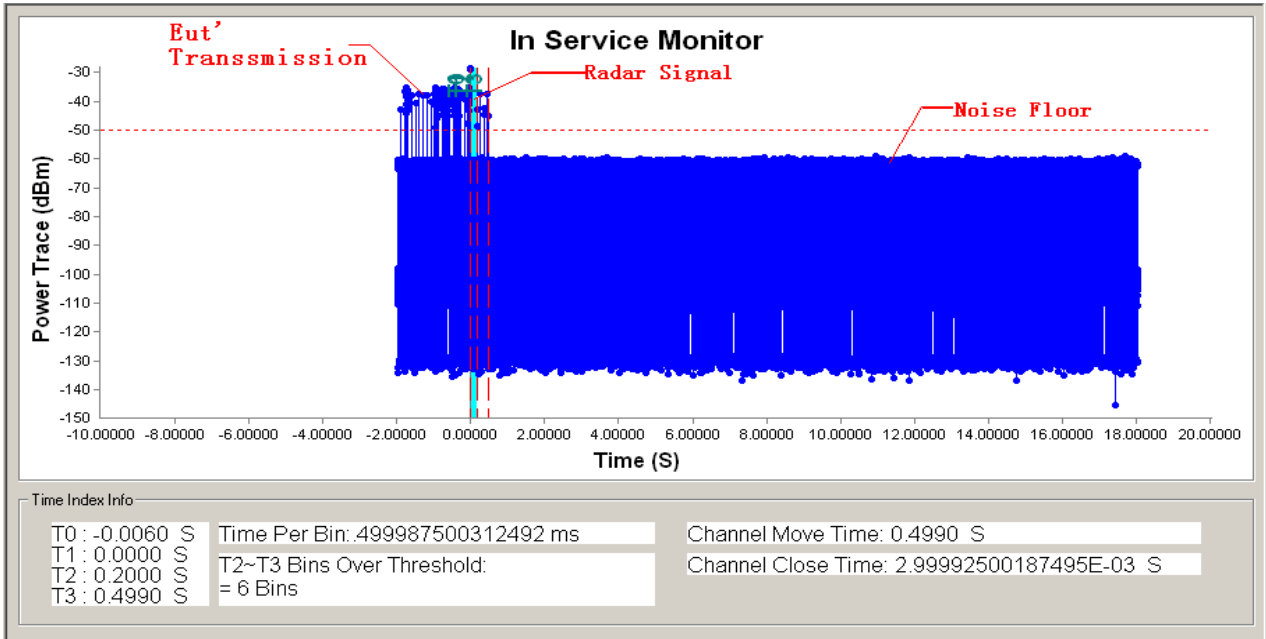

Note: T1 denotes the start of Channel Move Time upon the end of the last Radar burst.
 T2 denotes the data transmission time of 200ms from T1.
 T3 denotes the end of Channel Move Time.
 T4 denotes the 10 second from T1 to observe the aggregate duration of transmissions.

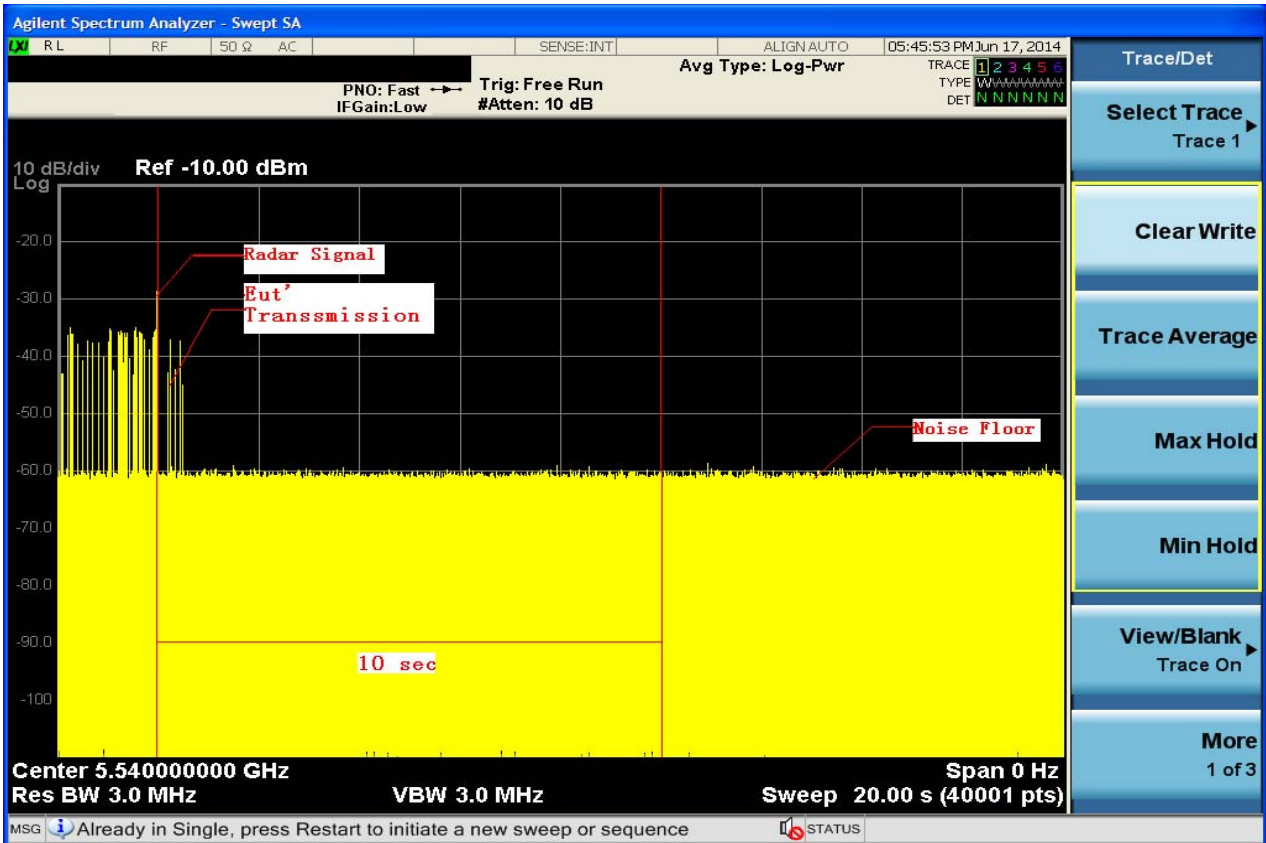

Note: An expanded plot for the device vacates the channel in the required 500ms



TX (11a Mode)

Radarsignal 5

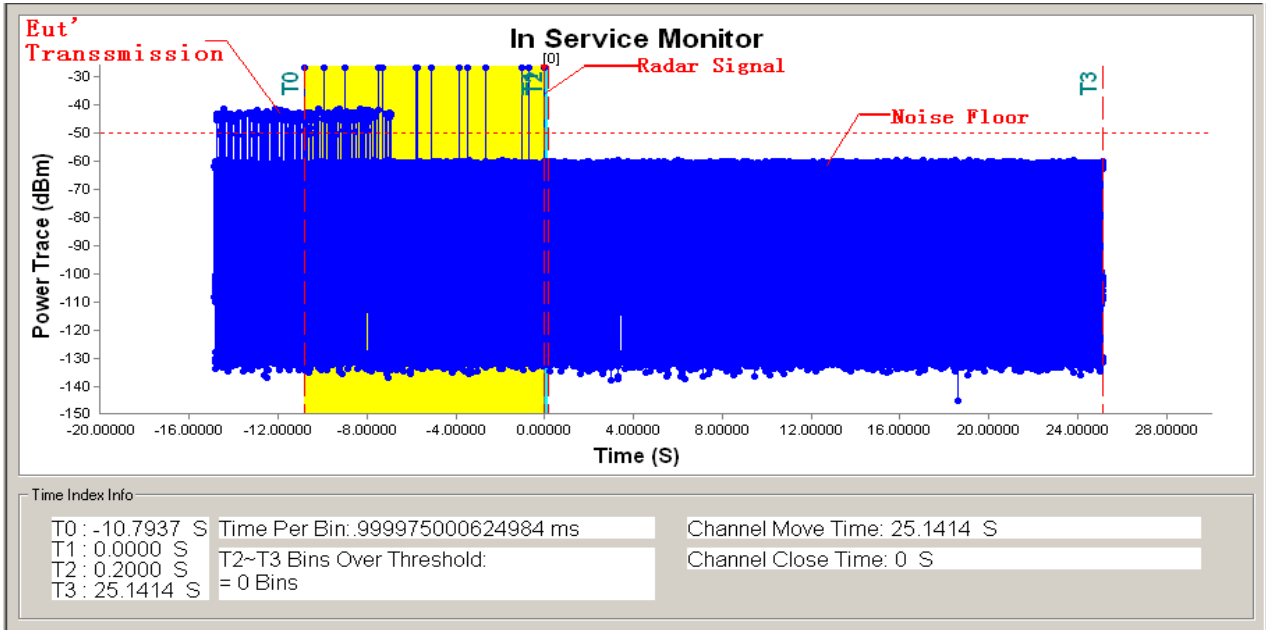

Note: T1 denotes the start of Channel Move Time upon the end of the last Radar burst.
 T2 denotes the data transmission time of 200ms from T1.
 T3 denotes the end of Channel Move Time.
 T4 denotes the 10 second from T1 to observe the aggregate duration of transmissions.

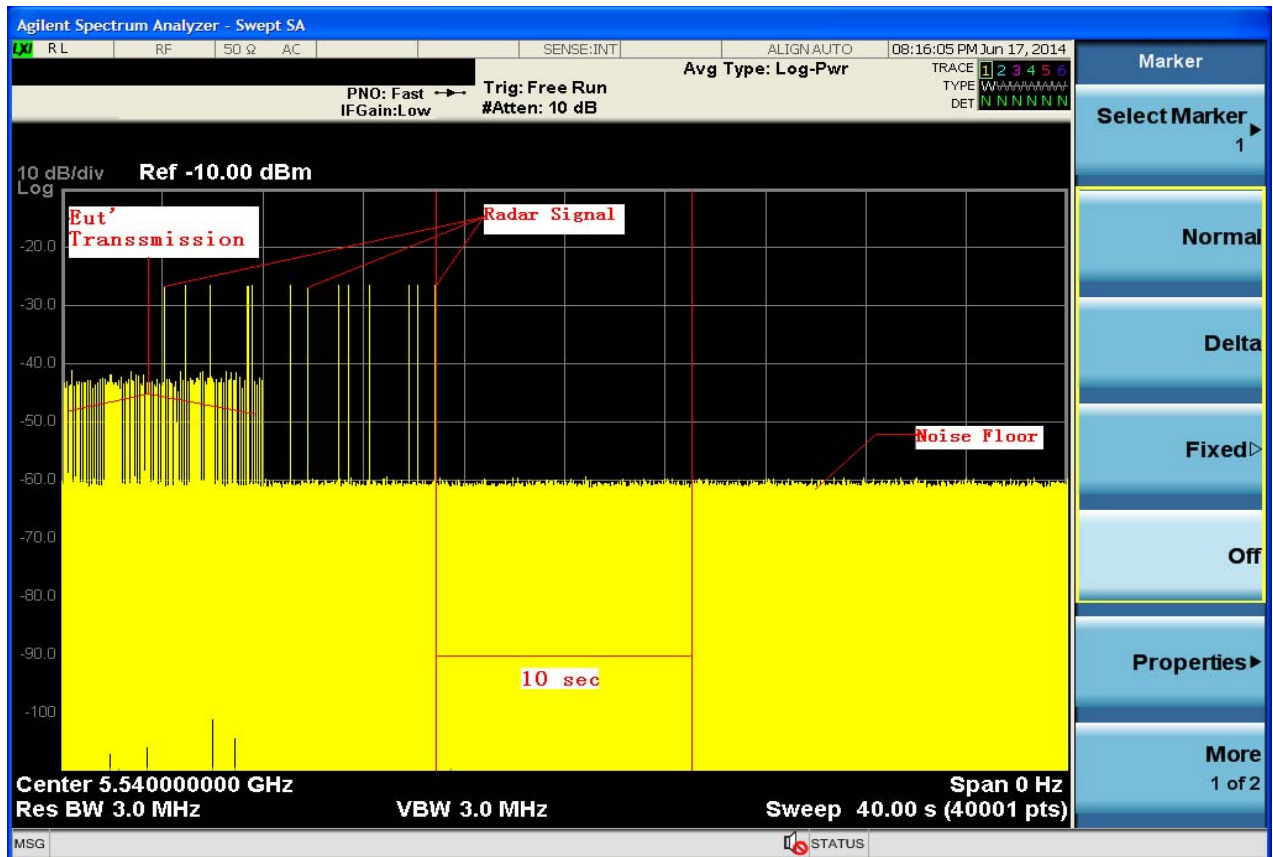

Note: An expanded plot for the device vacates the channel in the required 500ms



TX (11a Mode)

Radar signal 6

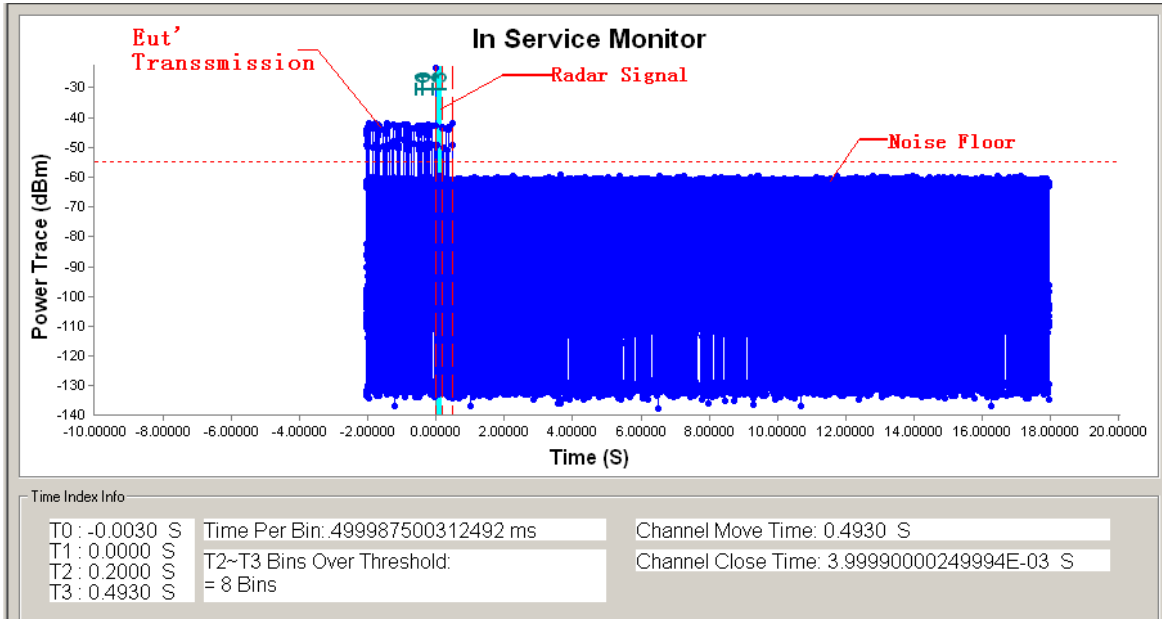

Note: T1 denotes the start of Channel Move Time upon the end of the last Radar burst.
 T2 denotes the data transmission time of 200ms from T1.
 T3 denotes the end of Channel Move Time.
 T4 denotes the 10 second from T1 to observe the aggregate duration of transmissions.

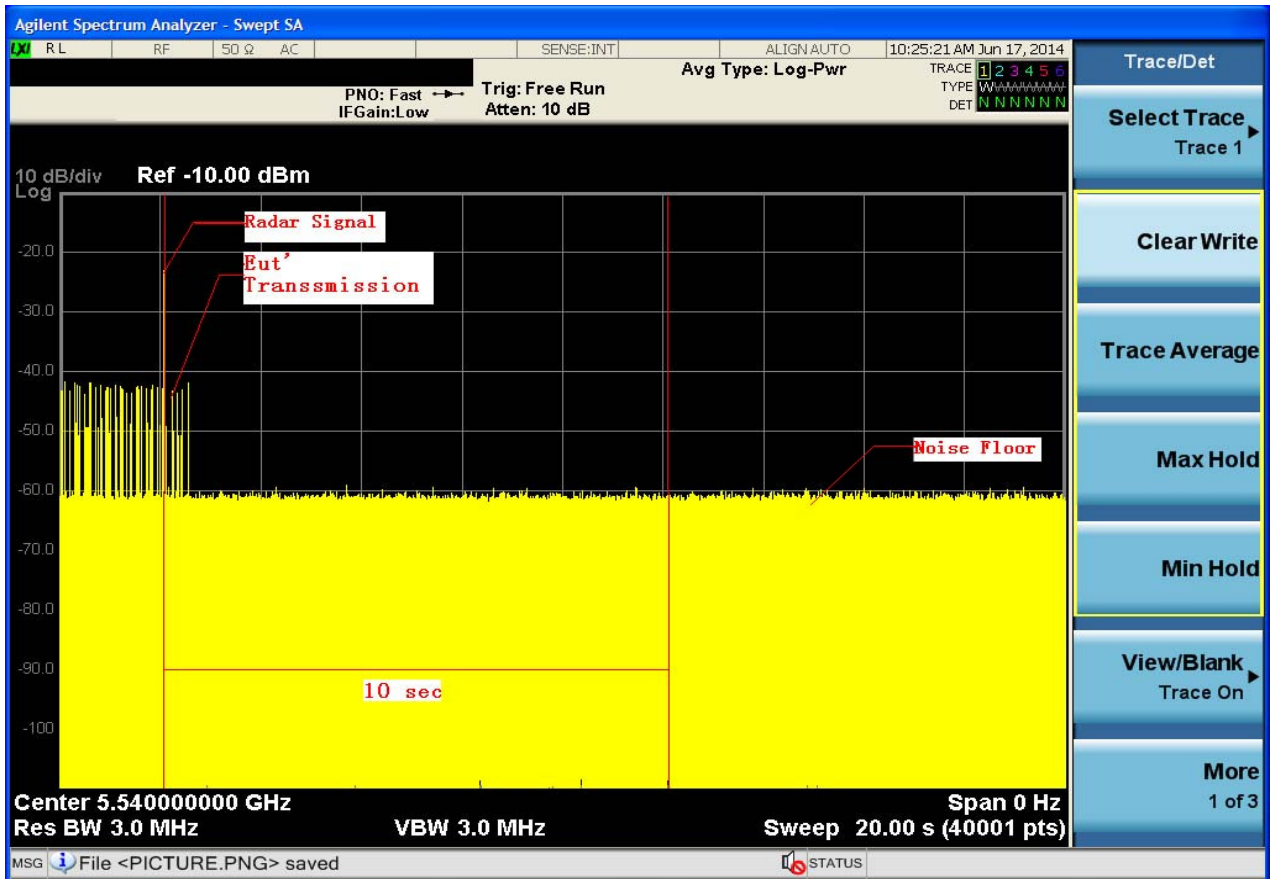

Note: An expanded plot for the device vacates the channel in the required 500ms



TX (11a Mode)

Radar1 Statical Performances				
Trial #	Pluse per Burst	Pluse Width(us)	PRI(us)	Detection(Yes / No)
1	18	1.0u	1.428	YES
2	18	1.0u	1.428	YES
3	18	1.0u	1.428	YES
4	18	1.0u	1.428	YES
5	18	1.0u	1.428	YES
6	18	1.0u	1.428	YES
7	18	1.0u	1.428	YES
8	18	1.0u	1.428	YES
9	18	1.0u	1.428	YES
10	18	1.0u	1.428	YES
11	18	1.0u	1.428	YES
12	18	1.0u	1.428	NO
13	18	1.0u	1.428	YES
14	18	1.0u	1.428	YES
15	18	1.0u	1.428	YES
16	18	1.0u	1.428	YES
17	18	1.0u	1.428	YES
18	18	1.0u	1.428	YES
19	18	1.0u	1.428	YES
20	18	1.0u	1.428	YES
21	18	1.0u	1.428	YES
22	18	1.0u	1.428	YES
23	18	1.0u	1.428	YES
24	18	1.0u	1.428	YES
25	18	1.0u	1.428	NO
26	18	1.0u	1.428	YES
27	18	1.0u	1.428	YES
28	18	1.0u	1.428	YES
29	18	1.0u	1.428	YES
30	18	1.0u	1.428	YES
Detection Rate 93%				



Radar2 Statical Performances				
Trial #	Pluse per Burst	Pluse Width(us)	PRI(us)	Detection(Yes / No)
1	28	4.3u	208	YES
2	28	2.8u	160	YES
3	26	2.9u	184	YES
4	24	2.7u	190	YES
5	28	3.4u	172	NO
6	28	4.0u	170	YES
7	27	1.3u	220	YES
8	28	1.4u	168	YES
9	25	4.5u	209	YES
10	24	3.3u	204	YES
11	26	2.4u	229	YES
12	27	3.8u	224	YES
13	23	2.7u	207	YES
14	24	3.3u	204	YES
15	26	2.4u	229	YES
16	27	3.8u	224	YES
17	29	2.7u	226	YES
18	29	2.9u	210	YES
19	27	1.8u	190	YES
20	26	2.0u	198	YES
21	23	1.2u	151	YES
22	25	1.4u	168	YES
23	25	1.5u	193	YES
24	27	2.6u	228	YES
25	26	1.7u	216	YES
26	23	4.8u	225	YES
27	28	1.9u	221	YES
28	26	4.1u	227	YES
29	26	3.1u	169	YES
30	27	2.2u	208	YES
Detection Rate 97%				



Radar3 Statical Performances				
Trial #	Pluse per Burst	Pluse Width(us)	PRI(us)	Detection(Yes / No)
1	18	8.6u	405	YES
2	18	8.4u	410	YES
3	16	9.3u	398	NO
4	16	8.0u	364	YES
5	17	9.6u	366	YES
6	18	8.0u	258	YES
7	16	9.3u	268	YES
8	16	8.2u	477	YES
9	18	8.7u	206	YES
10	18	9.0u	213	YES
11	16	9.8u	482	YES
12	17	7.9u	436	YES
13	17	7.0u	447	YES
14	16	7.6u	410	YES
15	16	8.2u	300	YES
16	18	7.4u	336	YES
17	16	9.3u	492	YES
18	17	7.5u	471	YES
19	17	7.9u	481	NO
20	18	8.0u	492	YES
21	16	9.9u	463	YES
22	17	8.5u	445	YES
23	17	8.0u	250	YES
24	16	8.0u	364	YES
25	17	7.2u	435	YES
26	18	6.5u	336	YES
27	18	6.8u	480	YES
28	17	7.2u	435	NO
29	18	6.5u	336	YES
30	18	6.8u	480	YES
Detection Rate 90%				



Radar4 Statical Performances				
Trial #	Pluse per Burst	Pluse Width(us)	PRI(us)	Detection(Yes / No)
1	13	13.8u	482	YES
2	15	14.9u	436	YES
3	15	15.8u	447	YES
4	15	14.6u	410	YES
5	14	13.9u	481	YES
6	14	16.0u	492	YES
7	15	17.0u	463	YES
8	12	17.5u	445	YES
9	12	16.0u	442	YES
10	13	13.6u	405	YES
11	16	14.4u	440	NO
12	16	15.3u	398	YES
13	13	14.0u	364	YES
14	16	13.2u	477	YES
15	12	12.7u	206	YES
16	13	12.0u	213	YES
17	15	19.0u	300	YES
18	13	11.4u	336	YES
19	16	12.5u	330	YES
20	13	16.6u	463	YES
21	13	18.8u	445	NO
22	15	19.0u	442	YES
23	15	14.8u	405	YES
24	15	18.6u	409	YES
25	15	18.2u	441	YES
26	12	20.0u	332	YES
27	14	14.8u	478	YES
28	13	15.6u	367	YES
29	14	17.0u	258	NO
30	15	19.3u	270	YES
Detection Rate 90%				



Radar5 Statical Performances		
Trial #	Test Signal name	Detection(Yes / No)
1	LP_Signal_01	Yes
2	LP_Signal_02	Yes
3	LP_Signal_03	Yes
4	LP_Signal_04	no
5	LP_Signal_05	Yes
6	LP_Signal_06	Yes
7	LP_Signal_07	Yes
8	LP_Signal_08	Yes
9	LP_Signal_09	Yes
10	LP_Signal_10	Yes
11	LP_Signal_11	Yes
12	LP_Signal_12	Yes
13	LP_Signal_13	Yes
14	LP_Signal_14	Yes
15	LP_Signal_15	Yes
16	LP_Signal_16	Yes
17	LP_Signal_17	Yes
18	LP_Signal_18	Yes
19	LP_Signal_19	Yes
20	LP_Signal_20	Yes
21	LP_Signal_21	Yes
22	LP_Signal_22	Yes
23	LP_Signal_23	Yes
24	LP_Signal_24	Yes
25	LP_Signal_25	Yes
26	LP_Signal_26	Yes
27	LP_Signal_27	Yes
28	LP_Signal_28	Yes
29	LP_Signal_29	Yes
30	LP_Signal_30	Yes
Detection Rate		97%



Radar6 Statical Performances		
Trial #	Hoping Frequency Sequence Name	Detection(Yes / No)
1	HOP_FREQ_SEQ_01	Yes
2	HOP_FREQ_SEQ_02	Yes
3	HOP_FREQ_SEQ_03	Yes
4	HOP_FREQ_SEQ_04	Yes
5	HOP_FREQ_SEQ_05	Yes
6	HOP_FREQ_SEQ_06	no
7	HOP_FREQ_SEQ_07	Yes
8	HOP_FREQ_SEQ_08	Yes
9	HOP_FREQ_SEQ_09	Yes
10	HOP_FREQ_SEQ_10	Yes
11	HOP_FREQ_SEQ_11	Yes
12	HOP_FREQ_SEQ_12	NO
13	HOP_FREQ_SEQ_13	Yes
14	HOP_FREQ_SEQ_14	Yes
15	HOP_FREQ_SEQ_15	Yes
16	HOP_FREQ_SEQ_16	Yes
17	HOP_FREQ_SEQ_17	Yes
18	HOP_FREQ_SEQ_18	Yes
19	HOP_FREQ_SEQ_19	NO
20	HOP_FREQ_SEQ_20	Yes
21	HOP_FREQ_SEQ_21	Yes
22	HOP_FREQ_SEQ_22	Yes
23	HOP_FREQ_SEQ_23	Yes
24	HOP_FREQ_SEQ_24	Yes
25	HOP_FREQ_SEQ_25	Yes
26	HOP_FREQ_SEQ_26	Yes
27	HOP_FREQ_SEQ_27	Yes
28	HOP_FREQ_SEQ_28	Yes
29	HOP_FREQ_SEQ_29	Yes
30	HOP_FREQ_SEQ_30	Yes
Detection Rate		90%



TX (11n 20MHz Mode)

Table 1: Short Pulse Radar Test Waveforms.

Radar Type	Pulse Width (µsec)	PRI (µsec)	Number of Pulses	Pass times	Fail times	Percentage of Successful Detection (%)
1	1	1428	18	28	2	93%
2	1-5	150-230	23-29	27	3	90%
3	6-10	200-500	16-18	29	1	97%
4	11-20	200-500	12-16	28	2	93%
Aggregate (Radar Types 1-4)			-	112	8	93%

Table 2: Long Pulse Radar Test Waveform

Radar Type	Pulse Width (µsec)	Chirp Width (MHz)	PRI (µsec)	Number of Pulses Per Burst	Number of Bursts	Pass times	Fail times	Percentage of Successful Detection (%)
5	50-100	5-20	1000-2000	1-3	8-20	29	1	97%

Table 3: Frequency Hopping Radar Test Waveform

Radar Type	Pulse Width (µsec)	PRI (µsec)	Pulses per Hop	Hopping Rate (kHz)	Hopping Sequence Length (msec)	Pass times	Fail times	Percentage of Successful Detection (%)
6	1	333	9	0.333	300	27	3	90%



TX (11n 20MHz Mode)

Radarsignal 1

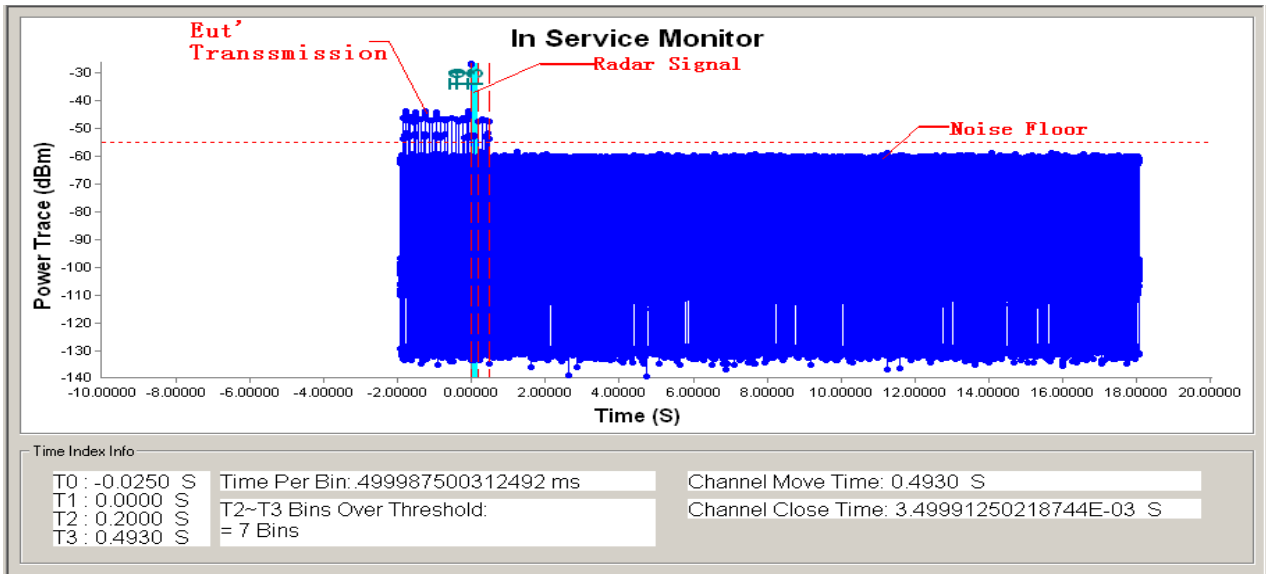

Note: T1 denotes the start of Channel Move Time upon the end of the last Radar burst.
 T2 denotes the data transmission time of 200ms from T1.
 T3 denotes the end of Channel Move Time.
 T4 denotes the 10 second from T1 to observe the aggregate duration of transmissions.

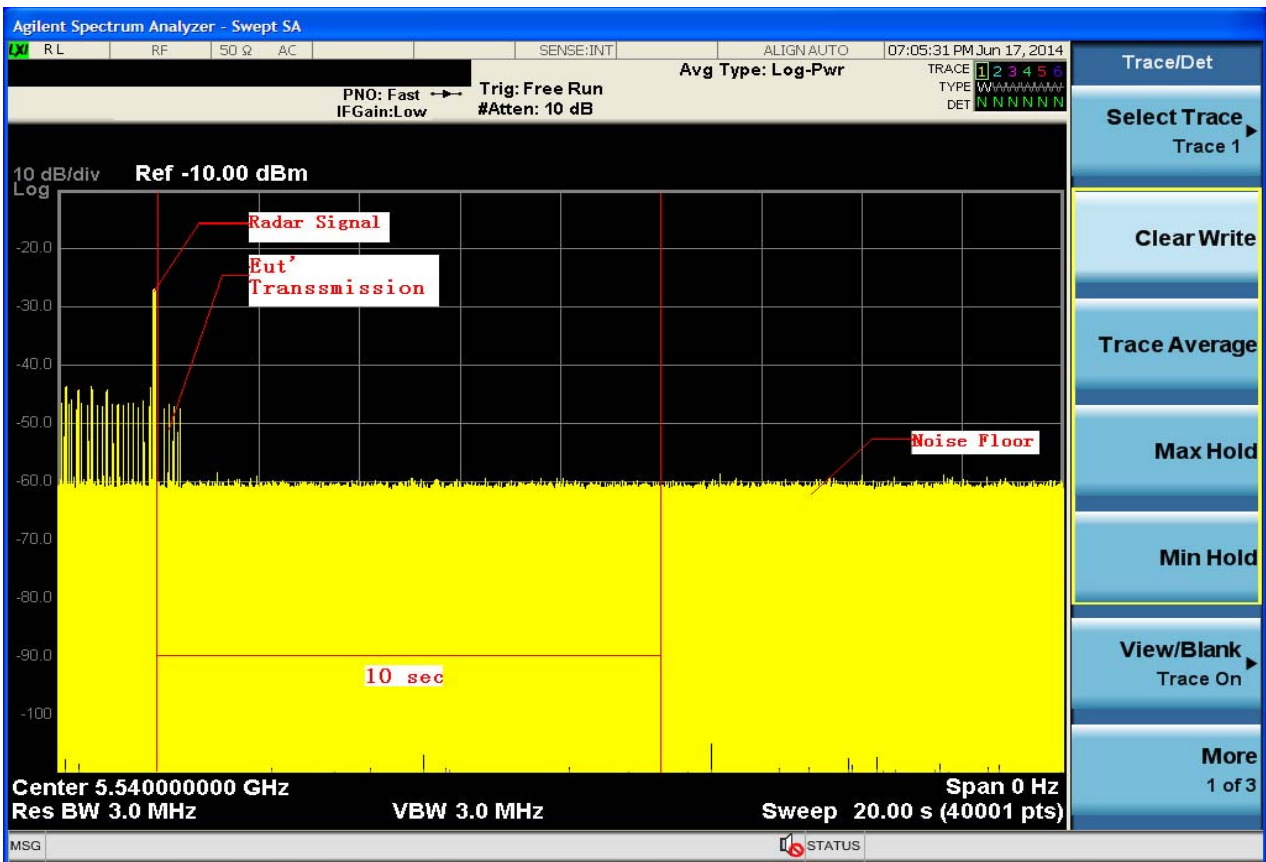

Note: An expanded plot for the device vacates the channel in the required 500ms



TX (11n 20MHz Mode)

Radar signal 2

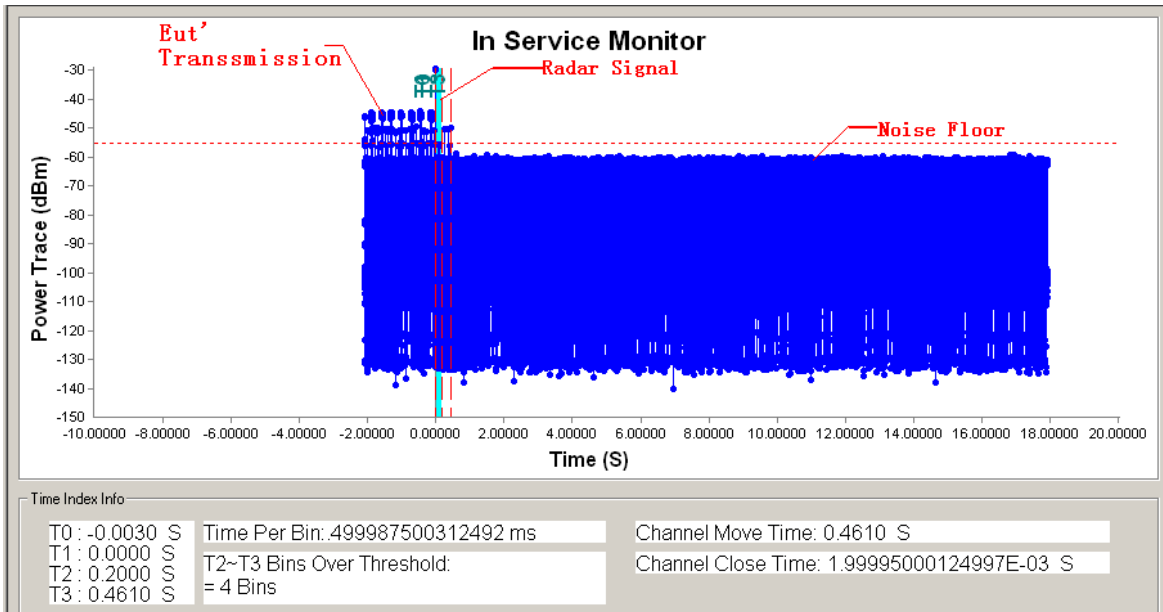

Note: T1 denotes the start of Channel Move Time upon the end of the last Radar burst.
 T2 denotes the data transmission time of 200ms from T1.
 T3 denotes the end of Channel Move Time.
 T4 denotes the 10 second from T1 to observe the aggregate duration of transmissions.



Note: An expanded plot for the device vacates the channel in the required 500ms



TX (11n 20MHz Mode)

Radarsignal 3

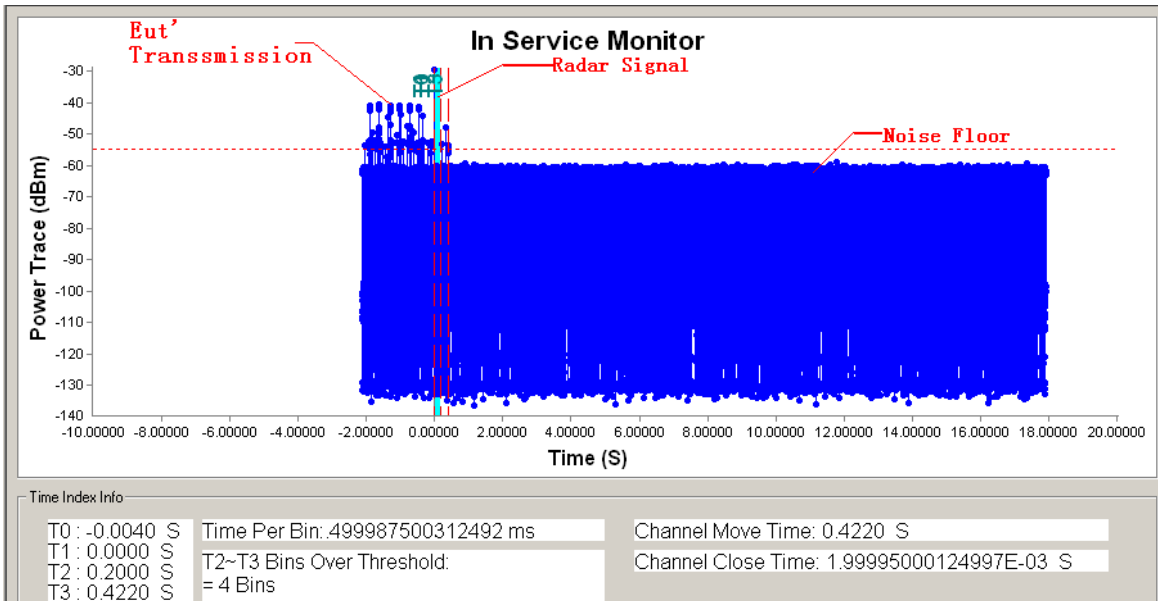

Note: T1 denotes the start of Channel Move Time upon the end of the last Radar burst.
 T2 denotes the data transmission time of 200ms from T1.
 T3 denotes the end of Channel Move Time.
 T4 denotes the 10 second from T1 to observe the aggregate duration of transmissions.

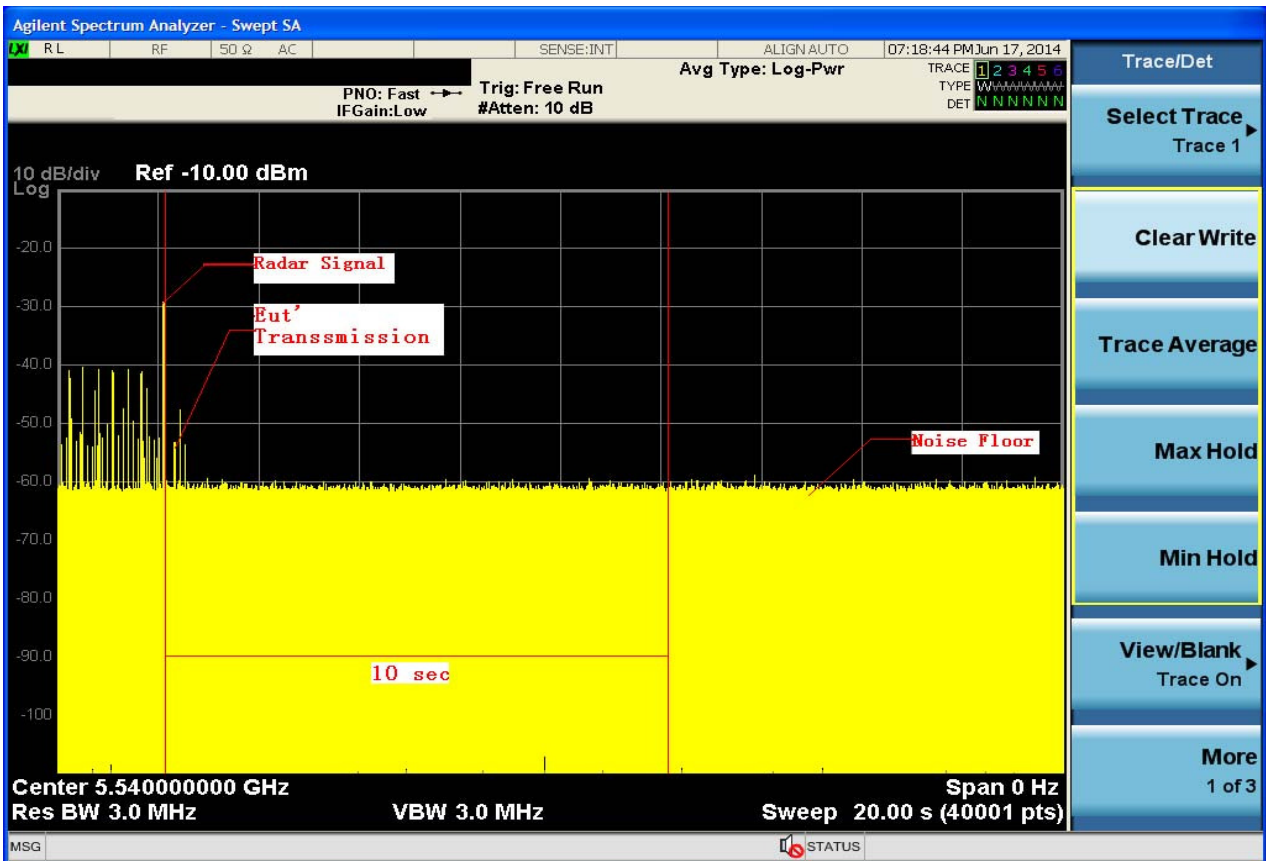

Note: An expanded plot for the device vacates the channel in the required 500ms



TX (11n 20MHz Mode)

Radarsignal 4

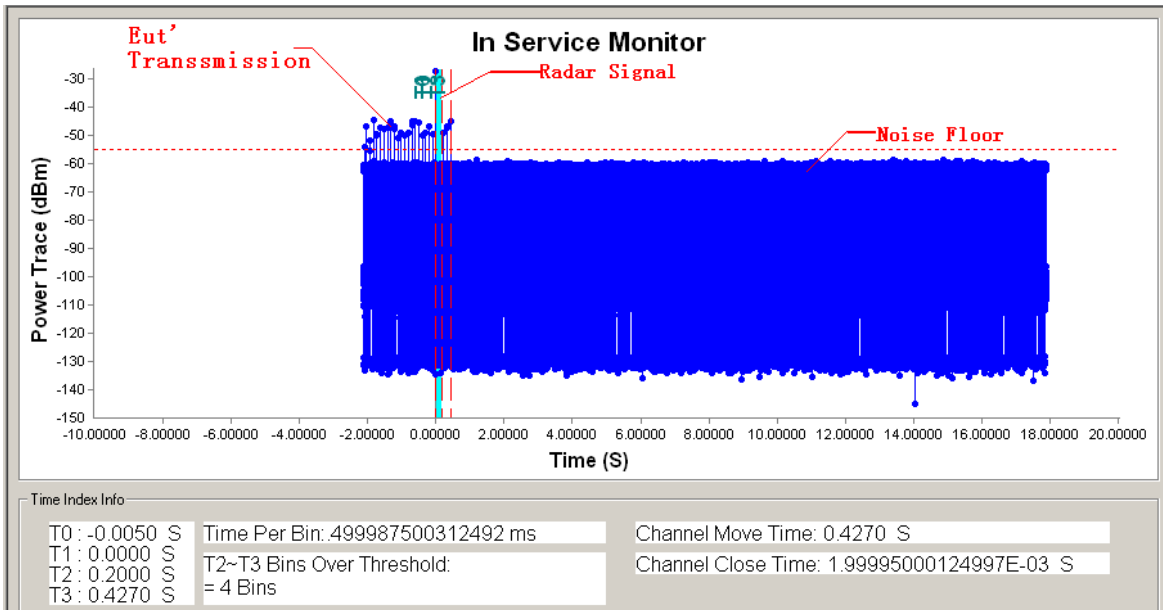

Note: T1 denotes the start of Channel Move Time upon the end of the last Radar burst.
 T2 denotes the data transmission time of 200ms from T1.
 T3 denotes the end of Channel Move Time.
 T4 denotes the 10 second from T1 to observe the aggregate duration of transmissions.

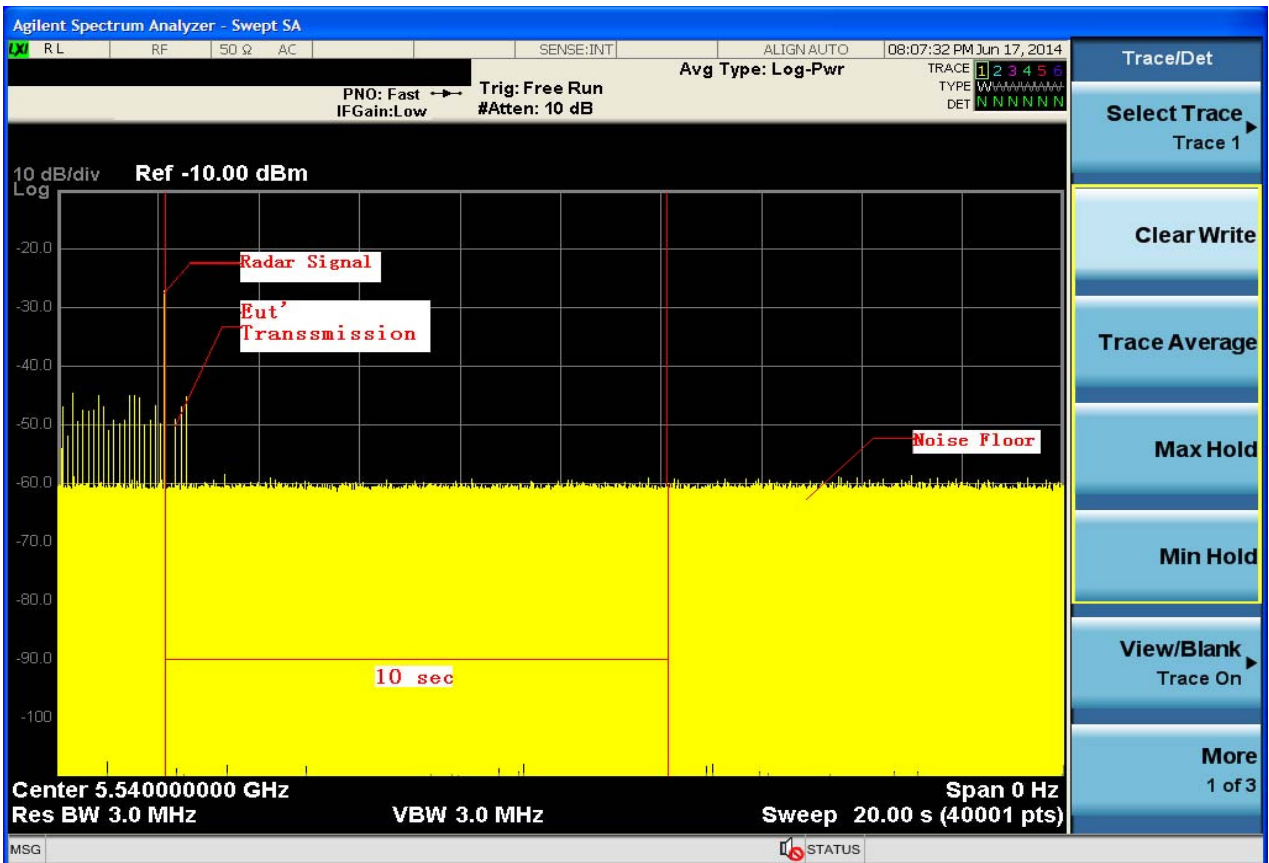

Note: An expanded plot for the device vacates the channel in the required 500ms



TX (11n 20MHz Mode)

Radar signal 5

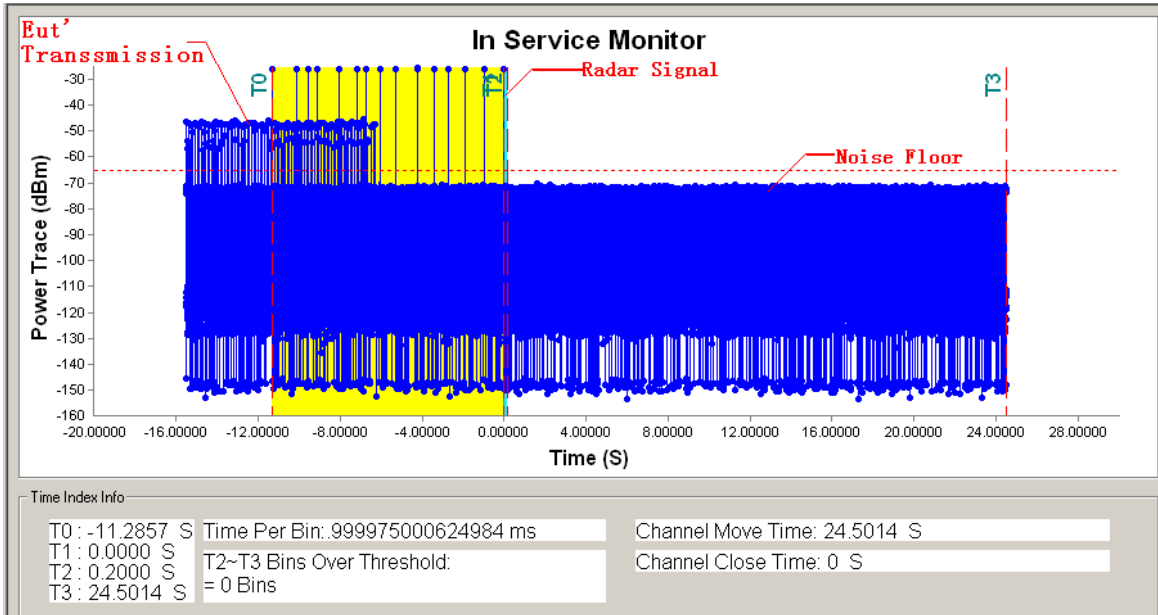

Note: T1 denotes the start of Channel Move Time upon the end of the last Radar burst.
 T2 denotes the data transmission time of 200ms from T1.
 T3 denotes the end of Channel Move Time.
 T4 denotes the 10 second from T1 to observe the aggregate duration of transmissions.

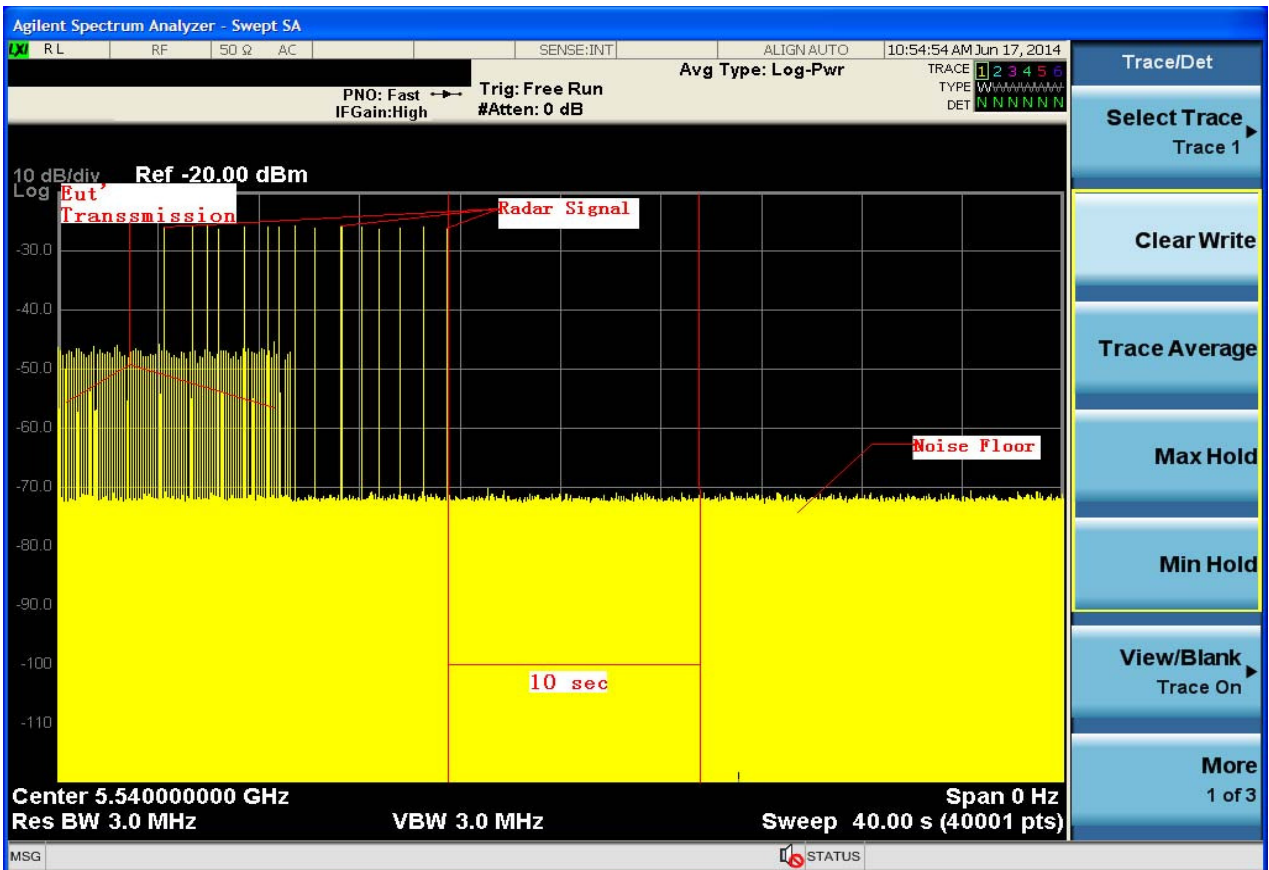

Note: An expanded plot for the device vacates the channel in the required 500ms



TX (11n 20MHz Mode)

Radarsignal 6

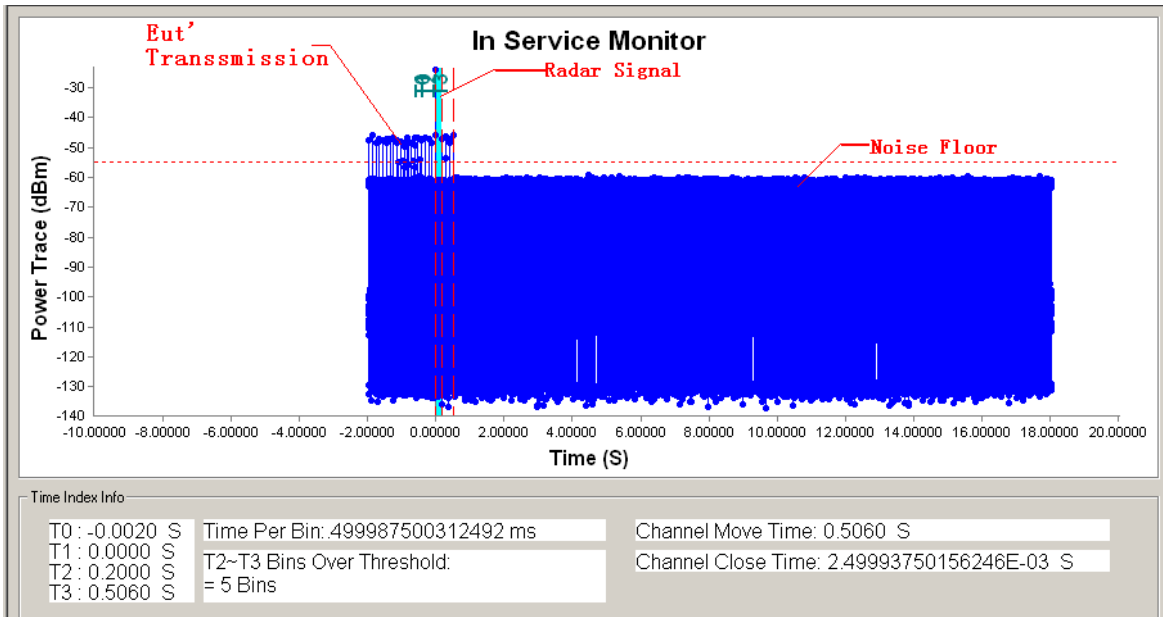

Note: T1 denotes the start of Channel Move Time upon the end of the last Radar burst.
 T2 denotes the data transmission time of 200ms from T1.
 T3 denotes the end of Channel Move Time.
 T4 denotes the 10 second from T1 to observe the aggregate duration of transmissions.

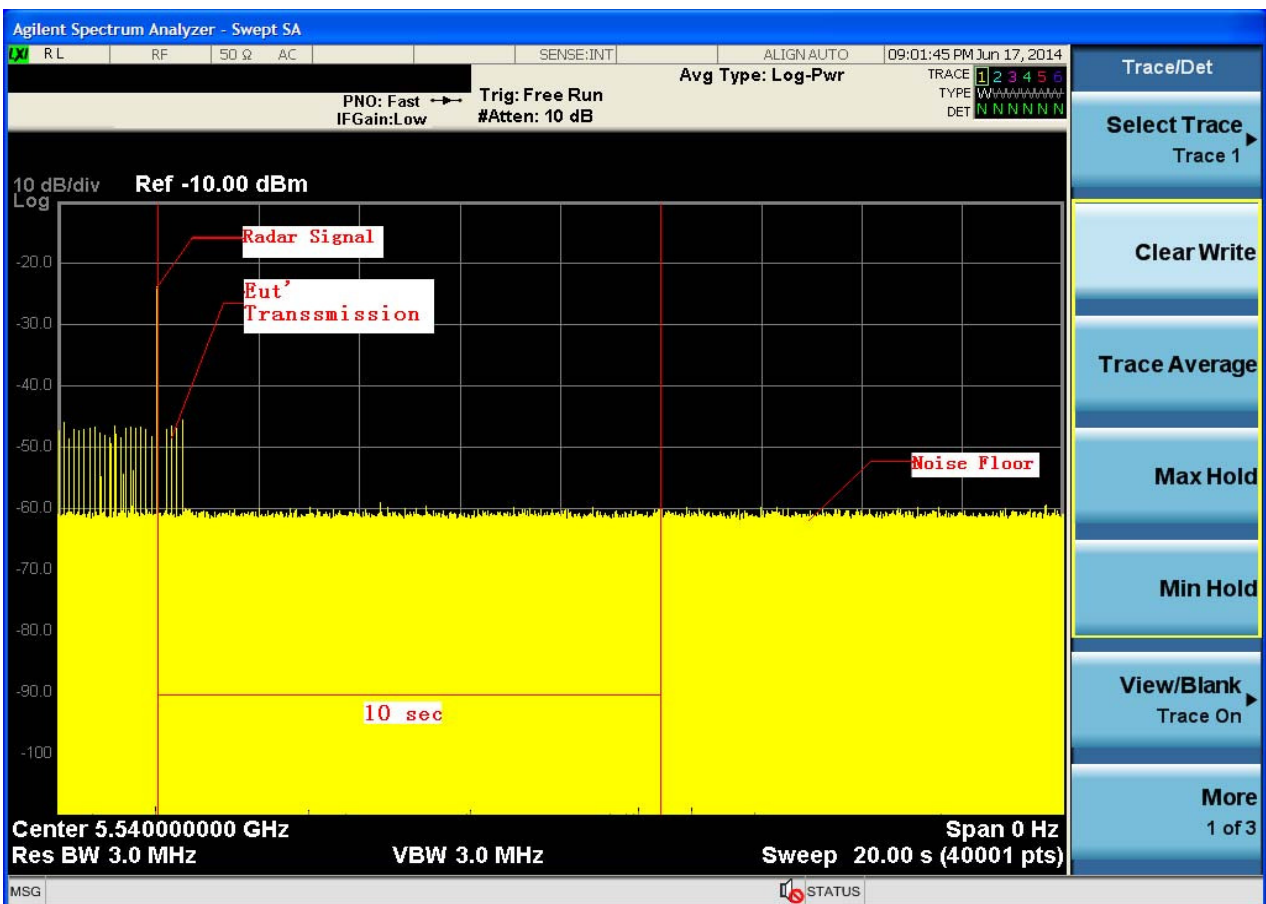

Note: An expanded plot for the device vacates the channel in the required 500ms



TX (11n 20MHz Mode)

Radar1 Statical Performances				
Trial #	Pluse per Burst	Pluse Width(us)	PRI(us)	Detection(Yes / No)
1	18	1.0u	1.428	YES
2	18	1.0u	1.428	YES
3	18	1.0u	1.428	YES
4	18	1.0u	1.428	YES
5	18	1.0u	1.428	YES
6	18	1.0u	1.428	YES
7	18	1.0u	1.428	YES
8	18	1.0u	1.428	YES
9	18	1.0u	1.428	YES
10	18	1.0u	1.428	YES
11	18	1.0u	1.428	YES
12	18	1.0u	1.428	NO
13	18	1.0u	1.428	YES
14	18	1.0u	1.428	YES
15	18	1.0u	1.428	YES
16	18	1.0u	1.428	YES
17	18	1.0u	1.428	YES
18	18	1.0u	1.428	YES
19	18	1.0u	1.428	YES
20	18	1.0u	1.428	YES
21	18	1.0u	1.428	YES
22	18	1.0u	1.428	YES
23	18	1.0u	1.428	YES
24	18	1.0u	1.428	YES
25	18	1.0u	1.428	NO
26	18	1.0u	1.428	YES
27	18	1.0u	1.428	YES
28	18	1.0u	1.428	YES
29	18	1.0u	1.428	YES
30	18	1.0u	1.428	YES
Detection Rate 93%				



Radar2 Statical Performances				
Trial #	Pluse per Burst	Pluse Width(s)	PRI(us)	Detection(Yes / No)
1	25	4.0u	208	YES
2	25	3.9u	160	YES
3	24	2.4u	218	YES
4	24	3.8u	220	YES
5	27	1.4u	168	YES
6	23	4.5u	209	YES
7	27	3.3u	190	YES
8	26	2.4u	198	NO
9	26	3.8u	224	YES
10	25	3.2u	207	YES
11	27	1.1u	158	YES
12	26	3.0u	157	YES
13	25	1.9u	168	NO
14	24	1.8u	192	YES
15	27	2.8u	228	YES
16	23	3.8u	216	YES
17	25	2.7u	228	YES
18	26	3.2u	221	YES
19	24	4.3u	227	YES
20	27	3.1u	186	YES
21	28	2.2u	172	YES
22	23	1.3u	170	NO
23	29	1.4u	166	YES
24	25	4.5u	221	YES
25	25	2.5u	135	YES
26	25	4.9u	220	YES
27	29	2.7u	204	YES
28	27	2.9u	229	YES
29	24	2.8u	220	YES
30	29	2.6u	198	YES
Detection Rate 90%				



Radar3 Statical Performances				
Trial #	Pluse per Burst	Pluse Width(s)	PRI(us)	Detection(Yes / No)
1	18	9.5u	269	YES
2	16	9.8u	431	YES
3	16	8.5u	436	YES
4	18	9.9u	447	YES
5	16	8.5u	477	YES
6	17	8.0u	206	YES
7	16	6.5u	477	YES
8	18	8.2u	206	YES
9	18	8.7u	218	NO
10	18	9.5u	482	YES
11	16	6.0u	436	YES
12	18	7.0u	463	YES
13	17	9.5u	492	YES
14	16	9.8u	463	YES
15	18	8.0u	431	YES
16	18	9.6u	330	YES
17	18	6.0u	230	YES
18	18	9.5u	269	YES
19	16	9.8u	431	YES
20	16	8.5u	436	YES
21	18	9.9u	447	YES
22	16	8.5u	477	YES
23	17	8.0u	206	YES
24	16	8.6u	440	YES
25	18	9.9u	442	YES
26	16	8.5u	405	YES
27	17	8.0u	364	YES
28	18	6.0u	366	YES
29	16	9.5u	364	YES
30	16	6.0u	366	YES
Detection Rate 97%				



Radar4 Statical Performances				
Trial #	Pluse per Burst	Pluse Width(us)	PRI(us)	Detection(Yes / No)
1	16	15.8u	482	YES
2	16	14.6u	436	YES
3	14	13.9u	447	YES
4	14	16.5u	258	YES
5	13	14.0u	270	YES
6	16	15.6u	482	YES
7	15	17.0u	330	YES
8	16	19.3u	335	YES
9	14	18.2u	328	YES
10	14	15.3u	445	YES
11	14	19.0u	442	YES
12	15	13.8u	332	YES
13	16	14.9u	478	YES
14	12	15.8u	442	YES
15	15	19.6u	405	YES
16	16	13.9u	409	YES
17	16	16.0u	463	YES
18	12	11.5u	490	NO
19	14	12.0u	442	YES
20	15	13.8u	405	YES
21	15	14.9u	370	YES
22	13	19.8u	470	YES
23	15	14.6u	320	YES
24	13	13.9u	485	YES
25	14	18.0u	414	NO
26	12	13.2u	409	YES
27	15	12.0u	477	YES
28	16	12.0u	206	YES
29	12	13.8u	216	YES
30	13	15.0u	213	YES
Detection Rate 93%				



Radar5 Statical Performances		
Trial #	Test Signal name	Detection(Yes / No)
1	LP_Signal_01	Yes
2	LP_Signal_02	Yes
3	LP_Signal_03	Yes
4	LP_Signal_04	Yes
5	LP_Signal_05	Yes
6	LP_Signal_06	Yes
7	LP_Signal_07	Yes
8	LP_Signal_08	Yes
9	LP_Signal_09	Yes
10	LP_Signal_10	Yes
11	LP_Signal_11	Yes
12	LP_Signal_12	Yes
13	LP_Signal_13	Yes
14	LP_Signal_14	Yes
15	LP_Signal_15	Yes
16	LP_Signal_16	NO
17	LP_Signal_17	Yes
18	LP_Signal_18	Yes
19	LP_Signal_19	Yes
20	LP_Signal_20	Yes
21	LP_Signal_21	Yes
22	LP_Signal_22	Yes
23	LP_Signal_23	Yes
24	LP_Signal_24	Yes
25	LP_Signal_25	Yes
26	LP_Signal_26	Yes
27	LP_Signal_27	Yes
28	LP_Signal_28	Yes
29	LP_Signal_29	Yes
30	LP_Signal_30	Yes
Detection Rate		97%



Radar6 Statical Performances		
Trial #	Hoping Frequency Sequence Name	Detection(Yes / No)
1	HOP_FREQ_SEQ_01	Yes
2	HOP_FREQ_SEQ_02	Yes
3	HOP_FREQ_SEQ_03	Yes
4	HOP_FREQ_SEQ_04	Yes
5	HOP_FREQ_SEQ_05	Yes
6	HOP_FREQ_SEQ_06	Yes
7	HOP_FREQ_SEQ_07	NO
8	HOP_FREQ_SEQ_08	Yes
9	HOP_FREQ_SEQ_09	Yes
10	HOP_FREQ_SEQ_10	Yes
11	HOP_FREQ_SEQ_11	Yes
12	HOP_FREQ_SEQ_12	Yes
13	HOP_FREQ_SEQ_13	Yes
14	HOP_FREQ_SEQ_14	Yes
15	HOP_FREQ_SEQ_15	NO
16	HOP_FREQ_SEQ_16	Yes
17	HOP_FREQ_SEQ_17	Yes
18	HOP_FREQ_SEQ_18	Yes
19	HOP_FREQ_SEQ_19	Yes
20	HOP_FREQ_SEQ_20	NO
21	HOP_FREQ_SEQ_21	Yes
22	HOP_FREQ_SEQ_22	Yes
23	HOP_FREQ_SEQ_23	Yes
24	HOP_FREQ_SEQ_24	Yes
25	HOP_FREQ_SEQ_25	Yes
26	HOP_FREQ_SEQ_26	Yes
27	HOP_FREQ_SEQ_27	Yes
28	HOP_FREQ_SEQ_28	Yes
29	HOP_FREQ_SEQ_29	Yes
30	HOP_FREQ_SEQ_30	Yes
Detection Rate		90%



6.2.5 NON- OCCUPANCY PERIOD

During the 30 minutes observation time, UUT did not make any transmissions on a channel after a radar signal was detected on that channel by either the Channel Availability Check or the In-Service Monitoring.

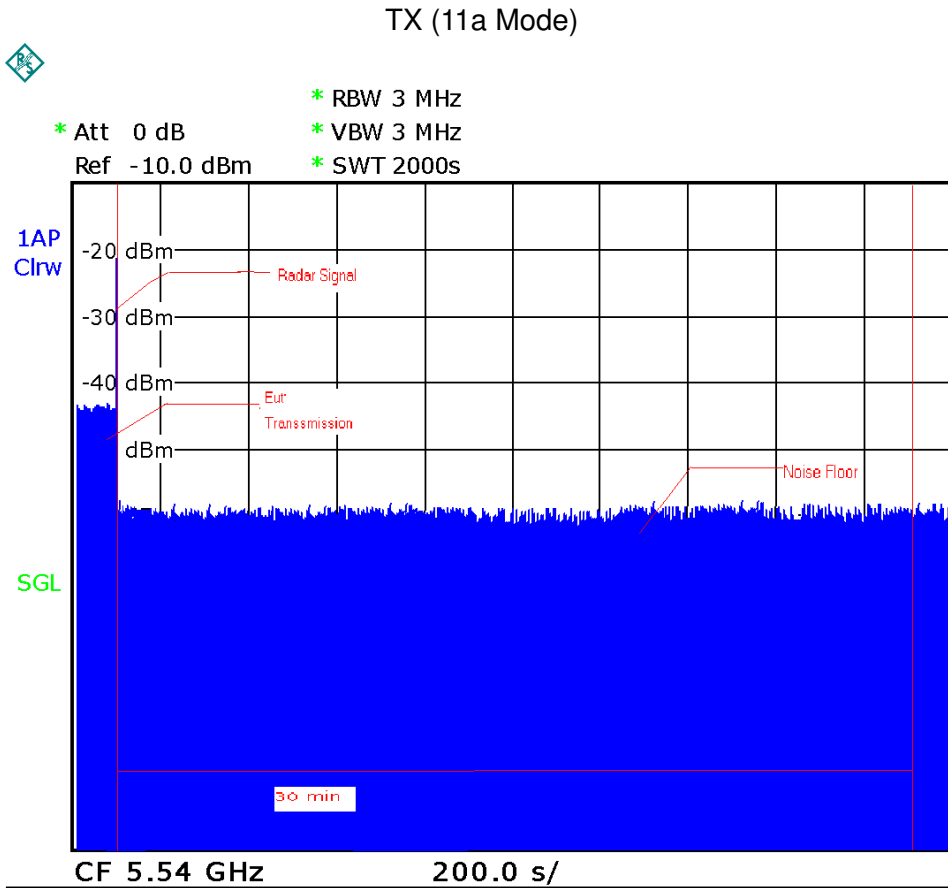

Date: 7.MAY.2014 20:53:43

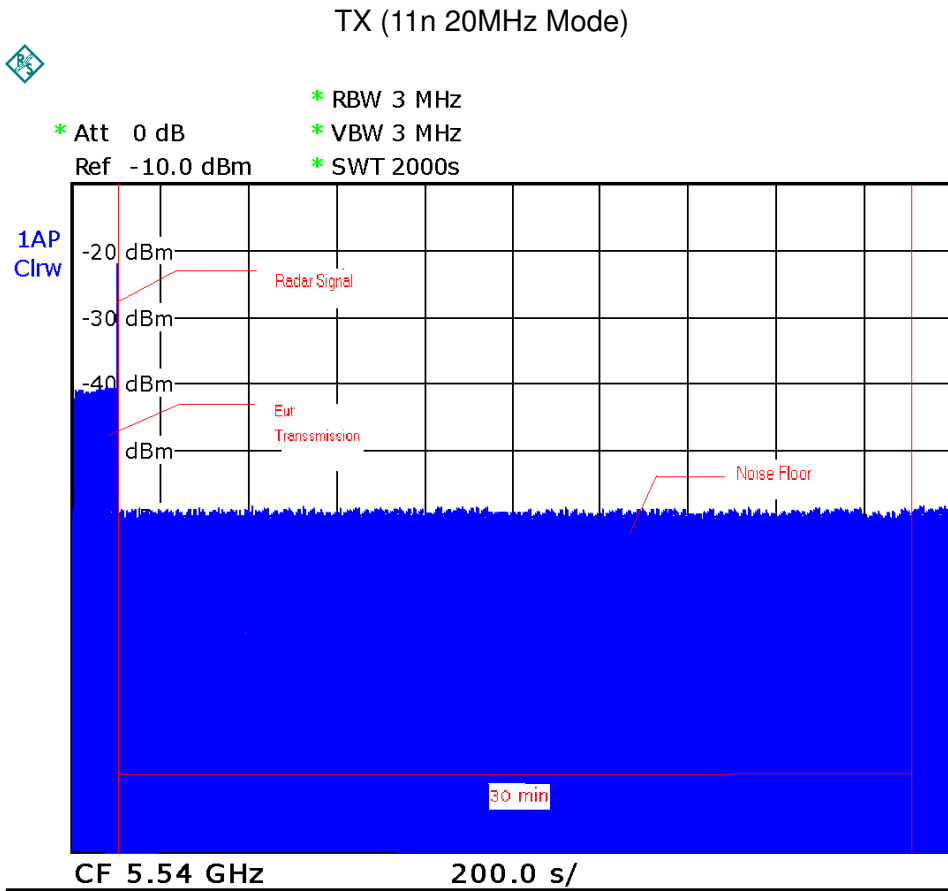

Date: 7.MAY.2014 10:35:40