

TEST REPORT

| | |
|------------------------|--|
| EUT Description | Wireless Module installed in Convertible PC |
| Brand Name | Intel® Wi-Fi 6E AX411 |
| Model Name | AX411NGW |
| FCC ID | PD9AX211NG |
| Date of Test Start/End | 2022-02-21 / 2022-02-23 |
| Features | 802.11ax, Tri Band, 2x2 Wi-Fi 6E + Bluetooth® 5.2 + CDB (Concurrent Dual Band simultaneous Wi-Fi connection) (see section 5) |
| Description | Platform: HP TPN-C155 +INPAQ antenna |

| | |
|----------------|---|
| Applicant | Intel Mobile Communications |
| Address | 100 Center Point Circle, Suite 200 / Columbia, SC 29210 / United States |
| Contact Person | Steven Hackett |
| Email | steven.c.hackett@intel.com |

| | | |
|--------------------------------------|---|---|
| Reference Standards | FCC 47 CFR Part §2.1093 (see section 1) | |
| RF Exposure Environment | Portable devices - General population/uncontrolled exposure | |
| | Testing Result | Limit |
| Maximum Power Density Result & Limit | 2.60 W/m ² (4cm ²) | 10 W/m ² (4cm ²) |
| Maximum SAR Result & Limit | 0.32 W/kg (1g) | 1.6 W/kg (1g) |
| Min. test separation distance | 0mm to phantom, 3.30mm to antenna edge (SAR), 2.5mm to probe tip (PD) | |

| | |
|----------------------------|--|
| Test Report identification | 220124-02.TR02 |
| Revision Control | Rev. 00 This test report revision replaces any previous test report revision (see section 8) |

The test results relate only to the samples tested.

Issued by _____

Reviewed by _____

Adel Lounes
(Test Engineer)

Cheiel IN
(Technical Manager Deputy)

Intel Corporation S.A.S – WRF Lab
425 rue de Goa – Le Cargo B6 - 06600 Antibes, France
Tel. +33493001400 / Fax +33493001401

Table of Contents

| | |
|--|-----------|
| 1. Standards, reference documents and applicable test methods | 4 |
| 2. General conditions, competences and guarantees | 4 |
| 3. Environmental Conditions | 5 |
| 4. Test samples | 5 |
| 5. EUT Features | 6 |
| 6. Remarks and comments | 9 |
| 7. Test Verdicts summary | 9 |
| 8. Document Revision History | 9 |
| Annex A. PD Test & System Description | 10 |
| A.1 POWER DENSITY DEFINITION | 10 |
| A.2 FREE SPACE MEASUREMENT SYSTEM | 10 |
| A.2.1 Measurement Setup | 10 |
| A.2.2 E-Field Measurement Probe | 11 |
| A.2.3 Worst Case Linearization Error | 12 |
| A.2.4 Data Evaluation | 12 |
| A.3 SYSTEM CHECK | 13 |
| A.4 TEST EQUIPMENT LIST | 14 |
| A.5 MEASUREMENT UNCERTAINTY EVALUATION | 15 |
| A.6 RF EXPOSURE LIMITS | 16 |
| Annex B. SAR Test & System Description | 17 |
| B.1 SAR DEFINITION | 17 |
| B.2 SAR MEASUREMENT SYSTEM | 18 |
| B.2.1 SAR Measurement Setup | 18 |
| B.2.2 E-Field Measurement Probe | 19 |
| B.2.3 Flat Phantom | 19 |
| B.2.4 Device Positioner | 20 |
| B.3 DATA EVALUATION | 21 |
| B.4 SYSTEM AND LIQUID CHECK | 23 |
| B.4.1 System Check | 23 |
| B.4.2 Liquid Check | 24 |
| B.5 TEST EQUIPMENT LIST | 25 |
| B.5.1 Tissue Simulant Liquid | 25 |
| B.6 MEASUREMENT UNCERTAINTY EVALUATION | 26 |
| B.7 RF EXPOSURE LIMITS | 27 |
| Annex C. Test Results | 28 |
| C.1 TEST CONDITIONS | 28 |
| C.1.1 Test positions relative to the phantom | 28 |
| C.1.2 Test signal, Output power and Test Frequencies | 28 |
| C.1.3 Evaluation Exclusion and Test Reductions | 29 |
| C.2 CONDUCTED POWER MEASUREMENTS | 30 |
| C.2.1 WLAN 6-7GHz (U-NII) | 30 |
| C.3 TISSUE PARAMETERS MEASUREMENT | 32 |
| C.4 SYSTEM CHECK MEASUREMENTS | 32 |
| C.4.1 E-Field | 32 |
| C.4.2 H-Field | 32 |
| C.4.3 Local Power Density | 32 |

| | | |
|---------------------------------------|---|-----------|
| C.4.4 | Averaged Power Density | 32 |
| C.4.5 | SAR | 33 |
| C.5 | TEST RESULTS | 34 |
| C.5.1 | SAR - 802.11ax – 6.2 GHz – U-NII-5..... | 34 |
| C.5.1 | SAR - 802.11ax – 6.5 GHz – U-NII-6..... | 34 |
| C.5.1 | SAR - 802.11ax – 6.7 GHz – U-NII-7..... | 35 |
| C.5.1 | SAR - 802.11ax – 7.0 GHz – U-NII-8..... | 35 |
| C.5.2 | Power Density - 802.11ax – U-NII-5, UNII-6, UNII-7, UNII-8..... | 36 |
| C.5.3 | Measurement Variability | 37 |
| C.5.4 | Simultaneous Transmission Evaluation – SAR..... | 38 |
| Annex D. | Test System Plots..... | 39 |
| TSL Dielectric Parameters..... | | 52 |
| D.1 | HEAD LIQUID WiFi 6E | 52 |
| Annex E. | Calibration Certificates | 53 |
| Annex F. | Photographs | 54 |
| F.1 | TEST SAMPLE | 54 |
| | SAR TEST POSITION | 55 |
| F.2 | PD TEST POSITION..... | 56 |
| F.3 | ANTENNA HOST PLATFORM LOCATION AND ADJACENT EDGE POSITIONS RELATIVE TO THE BODY | 57 |
| F.4 | PHANTOM LIQUID LEVEL DURING MEASUREMENTS | 58 |

1. Standards, reference documents and applicable test methods

| | |
|-----|--|
| FCC | <ol style="list-style-type: none"> 1. FCC 47 CFR Part §2.1093 – Radiofrequency radiation exposure evaluation: portable devices. Edition October 2019 2. FCC 47 CFR Part §1.1310 – Radiofrequency radiation exposure limits. Edition October 2019 3. FCC OET KDB 248227 D01 v02r02 - SAR guidance for IEEE 802.11 (Wi-Fi) transmitters. 4. FCC OET KDB 447498 D01 v06 -RF Exposure Procedures and Equipment Authorization Policies for Mobile and Portable Devices. 5. FCC OET KDB 616217 D04 v01r02 - SAR Evaluation Considerations for Laptop, Notebook, Netbook and Tablet Computers. 6. FCC OET KDB 865664 D01 v01r04 - SAR Measurement Requirements for 100 MHz to 6 GHz. 7. FCC OET KDB 865664 D02 v01r02 - RF Exposure Compliance Reporting and Documentation Considerations. 8. IEEE Std 1528-2013 - IEEE Recommended Practice Determining the Peak Spatial-Average Specific Absorption Rate (SAR) in the Human Head from Wireless Communication Devices: Measurement Techniques... 9. RF Exposure Policies and Procedures: TCB Workshop – October 2020 10. IEC/IEEE 62209-1528:2020 Measurement procedure for the assessment of specific absorption rate of human exposure to radio frequency fields from hand-held and body-mounted wireless communication devices – Part 1528: Human models, instrumentation, and procedures (Frequency range of 4 MHz to 10 GHz) 11. SPEAG Application Note – 5G Compliance Testing with DASY6 (5GModule V1.0Beta) |
|-----|--|

2. General conditions, competences and guarantees

- ✓ Intel WRF Lab declines any responsibility with respect to the identified information provided by the customer and that may affect the validity of results.
- ✓ Intel WRF Lab only provides testing services and is committed to providing reliable, unbiased test results and interpretations.
- ✓ Intel WRF Lab is liable to the client for the maintenance of the confidentiality of all information related to the item under test and the results of the test.
- ✓ Intel WRF Lab has developed calibration and proficiency programs for its measurement equipment to ensure correlated and reliable results to its customers.
- ✓ This report is only referred to the item that has undergone the test.
- ✓ This report does not imply an approval of the product by the Certification Bodies or competent Authorities.
- ✓ Complete or partial reproduction of the report cannot be made without written permission of Intel WRF Lab.

3. Environmental Conditions

✓ At the site where the measurements were performed the following limits were not exceeded during the tests:

| | |
|--------------------|----------------|
| Temperature | 24.1°C ± 1.1°C |
| Humidity | 31.1% ± 7.5% |
| Liquid Temperature | 19.9°C ± 1.1°C |

4. Test samples

| Sample | Control # | Description | Model | Serial # | Date of receipt | Note |
|--------|---------------|---|-------------|------------|-----------------|---------------|
| #01 | 220124-02.S01 | Wireless Module installed in Convertible PC | HP TPN-C155 | HPA4001385 | 02/01/2022 | INPAQ antenna |

5. EUT Features

The herein information is provided by the customer

| | | | |
|--|--|--|-----------------------------------|
| Brand Name | Intel® Wi-Fi 6E AX411 | | |
| Model Name | AX411NGW | | |
| Software Version | 22.210100.0.0-OEM.DRTU.00125.22.100.0 | | |
| Driver Version | 22.100.1.1 | | |
| Prototype / Production | Production | | |
| Host Identification | HP TPN-C155 | | |
| Supported Radios | 802.11b/g/n/ax | 2.4GHz (2400.0 – 2483.5 MHz) | |
| | 802.11a/n/ac/ax | 5.2GHz (5150.0 – 5250.0 MHz) 5.3GHz (5250.0 – 5350.0 MHz) 5.6GHz (5470.0 – 5725.0 MHz) 5.8GHz (5725.0 – 5850.0 MHz) | |
| | 802.11ax | 6.0GHz (5925.0 – 7125.0 MHz)* | |
| | Bluetooth | 2.4GHz (2400.0 – 2483.5 MHz) | |
| Antenna Information | Transmitter | Main/ Chain 2 | Aux/Chain 1 |
| | Manufacturer | INPAQ | INPAQ |
| | Antenna type | PIFA | PIFA |
| | Part number | DC33002K3C0 (WA-P-LBLB-02-130) | DC33002K3C0 (WA-P-LBLB-02-130) |
| See Annex F for more details on antennas location. | | | |
| Simultaneous Transmission Configurations | Mode | Main/ Chain 2 | Aux/Chain 1 |
| | Single Band Mode 2.4GHz | | |
| | 2.4GHz MIMO | WLAN 2.4GHz | WLAN 2.4GHz |
| | 2.4GHz SISO / Co-run | WLAN 2.4GHz | BT |
| | Single Band Mode 5GHz | | |
| | 5GHz MIMO | 5GHz MIMO | 5GHz MIMO |
| | 5GHz + BT Co-run | 5GHz + BT Co-run | 5GHz + BT Co-run |
| | 5GHz MIMO + BT Co-run | 5GHz MIMO + BT Co-run | 5GHz MIMO + BT Co-run |
| | Single Band Mode 6.5GHz | | |
| | 6.5GHz MIMO | 6.5GHz MIMO | 6.5GHz MIMO |
| | 6.5GHz + BT Co-run | 6.5GHz + BT Co-run | 6.5GHz + BT Co-run |
| | 6.5GHz MIMO + BT Co-run | 6.5GHz MIMO + BT Co-run | 6.5GHz MIMO + BT Co-run |
| | CDB Mode | | |
| | BT Co-run – CDB SISO | WLAN 2.4GHz + WLAN 6.5GHz | BT |
| CDB only SISO | WLAN 2.4GHz + WLAN 6.5GHz | - | |
| CDB only SISO | - | WLAN 2.4GHz + WLAN 6.5GHz | |
| CDB only MIMO | WLAN 2.4GHz + WLAN 6.5GHz | WLAN 2.4GHz + WLAN 6.5GHz | |
| BT Co-run (CDB SISO) | WLAN 2.4GHz | WLAN 6.5GHz + BT | |
| Additional Information | No WWAN transmitter is considered in this report | | |
| | 5.60-5.65 GHz band (TDWR) is supported by the device | | |
| | Band gap is supported by the device | | |

*Only these bands are treated on this document since this report is limited to WiFi 6E capabilities

Radios

| Mode | Duty Cycle | Modulation | Band | UL Freq Range (MHz) | Measured Max. Conducted Power (dBm) |
|----------|------------|--|--------|---------------------|-------------------------------------|
| 802.11ax | 100% | BPSK QPSK 16QAM 64QAM 256QAM | 6.2GHz | 5955-6415 | 13.45 |
| 802.11ax | 100% | BPSK QPSK 16QAM 64QAM 256QAM | 6.5GHz | 6435-6515 | 13.40 |
| 802.11ax | 100% | BPSK QPSK 16QAM 64QAM 256QAM | 6.7GHz | 6535-6855 | 12.75 |
| 802.11ax | 100% | BPSK QPSK 16QAM 64QAM 256QAM | 7.0GHz | 6875-7125 | 12.75 |

| Maximum Output power specification + Tune up tolerance limit, specified by the client | | | SISO mode | |
|---|----------|----------|----------------|---------------|
| Equipment Class | Mode | BW (MHz) | Main/Tx2 (dBm) | Aux/Tx1 (dBm) |
| U-NII-5 | 802.11ax | 20 | 5.00 | 5.00 |
| | | 40 | 8.25 | 8.25 |
| | | 80 | 10.75 | 10.75 |
| | | 160 | 13.50 | 13.50 |
| U-NII-6 | 802.11ax | 20 | 5.00 | 5.00 |
| | | 40 | 8.25 | 8.25 |
| | | 80 | 10.75 | 10.75 |
| | | 160 | 13.50 | 13.50 |
| U-NII-7 | 802.11ax | 20 | 4.00 | 4.00 |
| | | 40 | 7.50 | 7.50 |
| | | 80 | 10.00 | 10.00 |
| | | 160 | 12.75 | 12.75 |
| U-NII-8 | 802.11ax | 20 | 4.00 | 4.00 |
| | | 40 | 7.50 | 7.50 |
| | | 80 | 10.00 | 10.00 |
| | | 160 | 12.75 | 12.75 |

6. Remarks and comments

1. This report is limited to WiFi 6E capabilities. For all the modes on sub 6GHz bands, DTS, UNII-1, UNII-2A, UNII-2C, UNII-3 and BT refer to:
[1] 220124-02.TR01_FCC_WIFI_SAR_WLAN_HP_TPN-C155_wAX411NGW
2. The conducted values are obtained by applying the available power table identified in this report to the AX411NGW Intel module installed in the HP TPN-C155, as requested by the customer
3. Variability and simultaneous transmission results shown in this report are based on the highest SAR value obtained among all antenna manufacturers.
4. Only the plots for the test positions with the highest measured SAR/PD per band/mode are included in Annex C

7. Test Verdicts summary

The statement of conformity to applicable standards in the table below are based on the measured values, without taking into account the measurement uncertainties.

| Standard | Band | Highest Reported SAR [W/kg] | Verdict |
|----------|--------|-----------------------------|---------|
| 802.11ax | 6.2GHz | 0.32 | P |
| 802.11ax | 6.5GHz | 0.23 | P |
| 802.11ax | 6.7GHz | 0.20 | P |
| 802.11ax | 7.0GHz | 0.20 | P |

| Standard | Band | Highest Reported PS _{tot} avg [W/m ²] 4cm ² | Verdict |
|----------|--------|---|---------|
| 802.11ax | 6.2GHz | 2.60 | P |
| 802.11ax | 6.5GHz | 1.48 | P |
| 802.11ax | 6.7GHz | 0.98 | P |
| 802.11ax | 7.0GHz | 1.26 | P |

P: Pass
 F: Fail
 NM: Not Measured
 NA: Not Applicable

According to the FCC OET KDB 690783 D01, this is the summary of the values for the Grant Listing:

| Highest Reported SAR (1g) (W/kg) | | | |
|----------------------------------|-----------------|--------------|---------------|
| Exposure Condition | Equipment Class | | |
| | DSS | DTS | U-NII |
| Body Worn | 0.00 | 0.15 | 0.32 |
| Simultaneous Tx | Sum-SAR: 0.55 | Sum-SAR:0.79 | Sum-SAR: 0.79 |

Considering the results of the performed test according to FCC 47CFR Part 2.1093 the item under test is IN COMPLIANCE with the requested specifications specified in Section1. Standards, reference documents and applicable test methods

8. Document Revision History

| Revision # | Modified by | Revision Details |
|------------|-------------|------------------|
| Rev. 00 | Y.HADDAD | First Issue |

Annex A. PD Test & System Description

A.1 Power Density Definition

The power density for an electromagnetic field represents the rate of energy transfer per unit area.

The local power density (i.e. Poynting vector) at a given spatial point is deduced from electromagnetic fields by the following formula:

$$\vec{P}_{local} = \frac{1}{2} \text{Re} (\vec{E} \times \vec{H}^*)$$

Where \vec{E} is the complex electric field peak phasor and \vec{H}^* is the complex conjugate magnetic field peak phasor.

This power density is also called “single-point” or “spot power density”.

Considering that the FCC’s Maximum Permissible Exposure (MPE) limit is applicable on the average power density inside 1cm² area, the single point power densities in the evaluation plane should be averaged inside the 1cm² area.

A.2 Free space Measurement System

A.2.1 Measurement Setup

The DASY6 system for performing compliance tests consists of the following items:

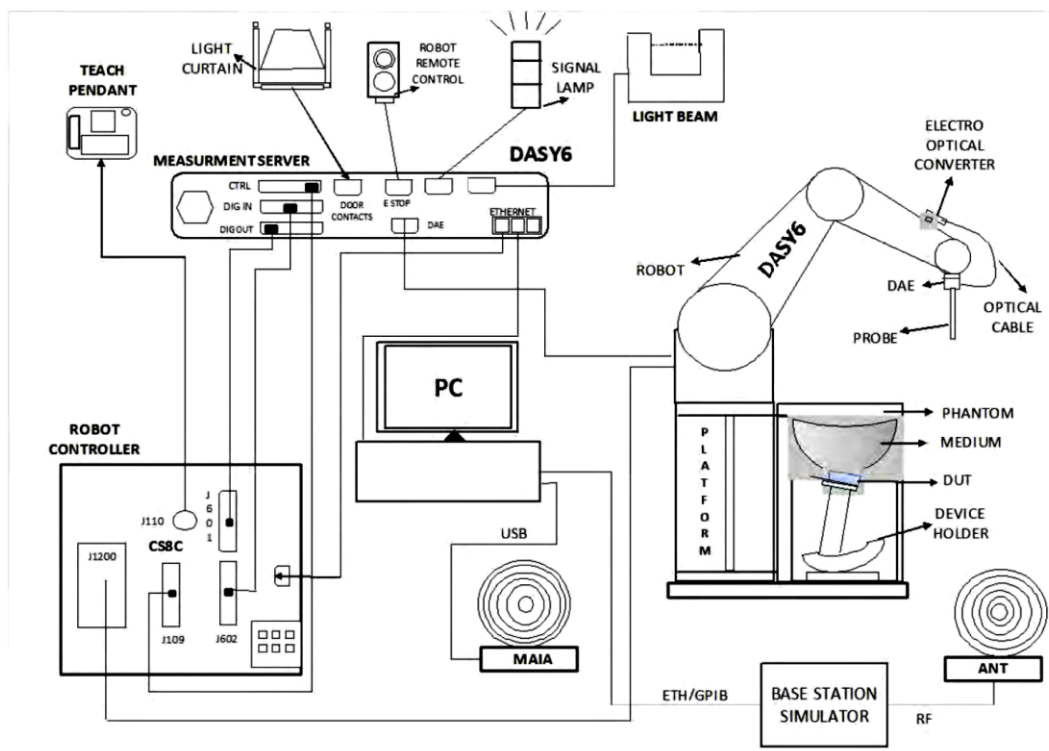

- ✓ A standard high precision 6-axis robot (Stäubli TX/RX family) with controller, teach pendant and software. It includes an arm extension for accommodating the data acquisition electronics (DAE)
- ✓ An mm-wave E-field probe optimized and calibrated for the targeted measurements.
- ✓ A data acquisition electronics (DAE) which performs the signal amplification, signal multiplexing, AD-conversion, offset measurements, mechanical surface detection, collision detection, etc. The unit is battery powered with standard or rechargeable batteries. The signal is optically transmitted to the EOC.
- ✓ The Electro-optical Converter (EOC) performs the conversion from optical to electrical signals for the digital communication to the DAE. The EOC signal is transmitted to the measurement server.
- ✓ The function of the measurement server is to perform the time critical tasks such as signal filtering, control of the robot operation and fast movements interrupts.
- ✓ The Light Beam used is for probe alignment. This improves the (absolute) accuracy of the probe positioning.
- ✓ A computer running Win7 professional operating system and the cDASY6 software.
- ✓ Remote control and teach pendant as well as additional circuitry for robot safety such as warning lamps, etc.

A.2.2 E-Field Measurement Probe

The probe consists of two dipoles (0.8 mm length) optimally arranged with different angles (γ_1 and γ_2) to obtain pseudo-vector information, printed on glass substrate protected by high density foam that allows low perturbation of the measured field.

Three or more measurements are taken for different probe rotational angles, deriving the amplitude and polarization information.

The probe's characteristics are:

| | |
|---|--|
| Frequency Range | 750 MHz – 110 GHz |
| Length | 320 mm |
| Probe tip external diameter | 8 mm |
| Probe's two dipoles length | 0.9mm – Diode loaded |
| Probe's substrate | Quartz 0.9 x 20 x 0.18mm ($\epsilon_r=3.8$) |
| Distance between diode sensors and probe's tip | 1.5 mm |
| Axial Isotropy | ± 0.6 dB |
| Maximum operating E-field | 3000 V/m |
| Lower E-field detection threshold | 5 V/m @ 60 GHz |
| Minimum Mechanical separation between probe tip and a Surface | 0.5mm |
| Calibration reference point | Diode Sensor |

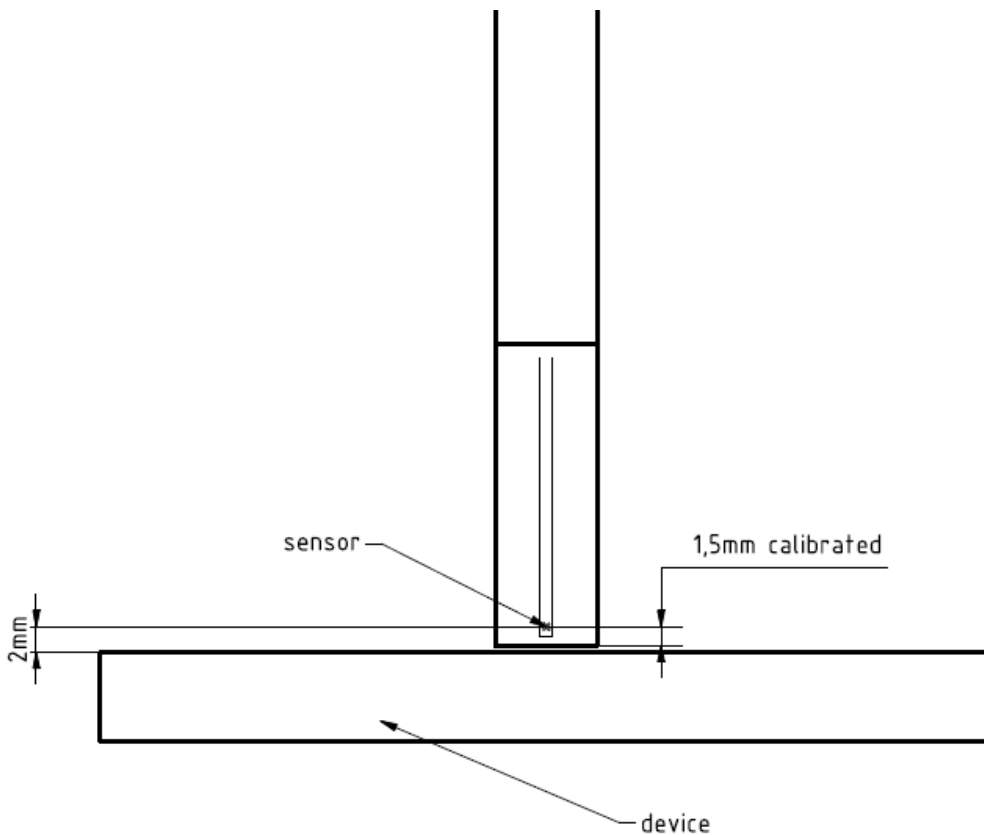
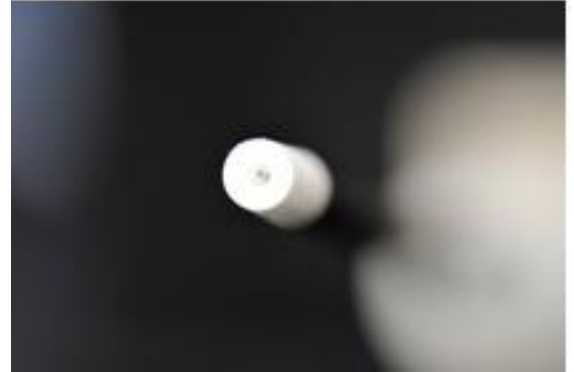

A.2.3 Worst Case Linearization Error

For continuously transmitting signals (100% duty cycle), the worst case linearization error is given by the difference between non linearized voltage and linearized voltage using CW parameters. The error is increasing with the voltage levels. In our particular case, the measured voltages averaged over the signal period are below 1mV. We use 1mV in the below calculation to have the worst case condition. The signal PAR (Peak to Average Ratio) is 6dB and the diode compression point 100mV.

The maximum voltage through the diode is given by:

$$v_{peak} = v_{meas\ avg} \times PAR_{linear}$$

$$v_{peak} = 1 * 4 = 4\ mV$$

The linearized voltage using CW parameter is given by:

$$v_{lin\ peak} = v_{peak} + \frac{v_{peak}^2}{diode\ compression\ point}$$

$$v_{lin\ peak} = 4 + \frac{4^2}{100} = 4.16\ mV$$

The worst case linearization error is:

$$lin\ error = \frac{v_{lin\ peak} - v_{peak}}{v_{peak}} = \frac{4.16 - 4}{4} = 1.04 = 4\%$$

A.2.4 Data Evaluation

A.2.4.1 Scan

The scan involves the measurement of two planes with three different probe rotations. The grid steps are optimized by the software based on the test frequency. The location of the lowest measurement plane is defined by the distance of first measurement layer from device under test (DUT) entered by the user. The DUT location settings can be used to offset the center of the grid.

A.2.4.2 Total Field and Power Flux Density Reconstruction

Computation of the power density in general requires knowledge of the electric (E-) and magnetic (H-) field amplitudes and phases in the plane of incidence. Reconstruction of these quantities from pseudo-vector E-field measurements is feasible, as they are constrained by Maxwell's equations.

The reconstruction algorithm developed by the system manufacturer, together with the ability of the probe to measure extremely close to the source without perturbing the field, permits reconstruction of the E- and H-fields, as well as of the power density, on measurement planes located as near as 0.5mm away in the frequency band of 60 GHz.

The average of the reconstructed power density is evaluated over a circular area in each measurement plane. The area of the circle is defined by the user; the default is 1 cm².

A.3 System Check

The system performance check verifies that the system operates within its specifications. It is recommended that the system performance check be performed prior to any usage of the system in order to guarantee reproducible results. The system performance check uses normal E-field measurements in a simplified setup with a well characterized source. This setup was selected to give a high sensitivity to all parameters that might fail or vary over time. The system check does not intend to replace the calibration of the components, but indicates situations where the system uncertainty is exceeded due to drift or failure.

In the simplified setup for system check, the EUT is replaced by a calibrated source and the power source is replaced by a controlled continuous wave generated by a signal generator. The calibrated source must be placed at the correct distance from the E-field probe according to the calibration certificate.



First, the power meter is connected to the output of the signal generator to measure the forward power at the location of the connector to the system check source. The signal generator is adjusted for the desired forward power to match the system check source calibration setup at the connector as read by power meter. Then the power meter is replaced by the system check source.

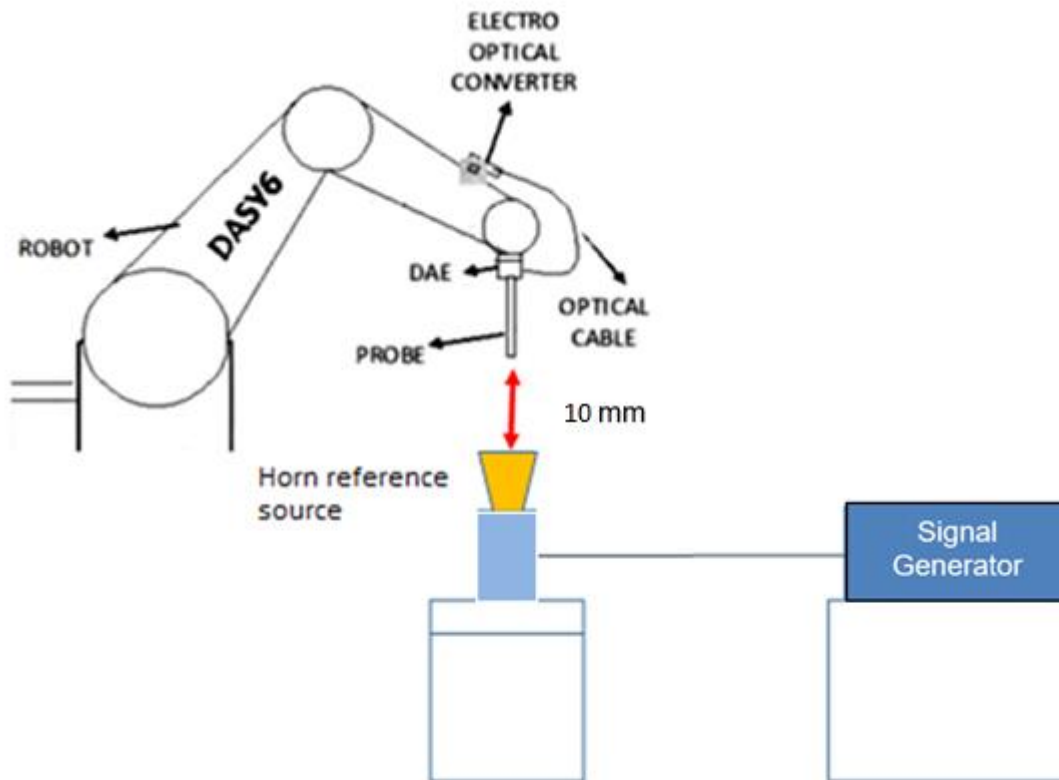

The output power on the reference source is set to 10.0 dBm (10 mW) and the measurement results E, H and Avg PD are compared with the Numerical modeling.

A.4 Test Equipment List

SAR system #3

| ID # | Device | Type/Model | Serial Number | Manufacturer | Cal. Date | Cal. Due Date |
|---------|------------------------------|-----------------------|-----------------|--------------|------------|---------------|
| 003-000 | 6-Axis Robot | TX60 Lspeag | F17/59RCB1/A/01 | STAÜBLI | NA | NA |
| 003-001 | Robot Controller | CS8C | F17/59RCB1/C/01 | STAÜBLI | NA | NA |
| 003-002 | 5G Phantom | mmWave | NA | SPEAG | NA | NA |
| 003-003 | Light Beam Unit | SE UKS 030 AA | 1170 | Di-soric | NA | NA |
| 003-004 | Measurement Server | DASY6 | 1547 | SPEAG | NA | NA |
| 003-005 | Electro Optical Converter | EOC60 | 1104 | SPEAG | NA | NA |
| 003-006 | Measurement Software | DASY mmWave v2.4.0.55 | 9-5ED1AC01 | SPEAG | NA | NA |
| 002-013 | Data Acquisition Electronics | DAE4 | 1658 | SPEAG | 2021-08-04 | 2022-08-04 |
| 003-009 | Laptop Holder | N/A | N/A | SPEAG | NA | NA |
| 088-000 | E-Field probe 750MHz-110GHz | EUmmWV3 | 9366 | SPEAG | 2021-05-20 | 2022-05-20 |

Shared equipment

| ID # | Device | Type/Model | Serial Number | Manufacturer | Cal. Date | Cal. Due Date |
|---------|-------------------------|--------------------|---------------|----------------|------------|---------------|
| 123-000 | USB Power Sensor | NRP-Z81 | 102278 | R&S | 2021-04-13 | 2023-04-13 |
| 124-000 | USB Power Sensor | NRP-Z81 | 102279 | R&S | 2021-04-13 | 2023-04-13 |
| 078-000 | RF Cable | ST-18/SMAm/SMAm/48 | - | Huber & Suhner | 2022-02-01 | 2022-08-01 |
| 079-000 | RF Cable | ST-18/SMAm/SMAm/48 | - | Huber & Suhner | 2022-02-01 | 2022-08-01 |
| 141-000 | USB Power Sensor | NRP-Z81 | 104381 | R&S | 2020-06-03 | 2022-06-03 |
| 327-000 | Temp & Humidity Logger | RA32E-TH1-RAS | RA32-F0DED9 | AVTECH | 2021-03-09 | 2023-03-09 |
| 098-000 | Vector Signal Generator | SMW200A 20GHz | 103732 | R&S | 2020-07-20 | 2022-07-20 |
| 198-000 | 0.8-21GHz RF amplifier | TVA-82-213A+ | 2004003 | Mini-Circuits | 2022-02-01 | 2022-08-01 |
| 014-023 | Horn reference source | PE9859/SF-15 | -- | Pasternack | NA | NA |

A.5 Measurement Uncertainty Evaluation

The system uncertainty evaluation is shown in the table below with a coverage factor of $k = 2$ to indicate a 95% level of confidence:

| DASY6 Uncertainty Budget According to draft of the IEC/IEEE 63159 750 MHz – 110 GHz | | | | | | |
|---|-------------------------|--------------------------|------------|--------------|-----------------|------------------------|
| Error Description | Uncertainty Value (±dB) | Probability Distribution | Div. | (α) | Std. Unc. (±dB) | (v_i) v_{eff} |
| Measurement System | | | | | | |
| Probe calibration | 0.49 | N | 1 | 1 | 0.98 | ∞ |
| Hemispherical Isotropy | 0.50 | R | $\sqrt{3}$ | 1 | 0.29 | ∞ |
| Linearity | 0.20 | R | $\sqrt{3}$ | 1 | 0.12 | ∞ |
| System Detection Limits | 0.04 | R | $\sqrt{3}$ | 1 | 0.02 | ∞ |
| Data acquisition | 0.03 | N | 1 | 1 | 0.03 | ∞ |
| Field reconstruction | 0.60 | R | $\sqrt{3}$ | 0.3 | 0.35 | ∞ |
| Probe Positioning Repeatability | 0.04 | R | $\sqrt{3}$ | 1 | 0.02 | ∞ |
| Probe Positioning offset | 0.30 | R | $\sqrt{3}$ | 1 | 0.17 | ∞ |
| Amplitude and Phase Noise | 0.04 | R | $\sqrt{3}$ | 1 | 0.02 | ∞ |
| Spatial Averaging | 0.1 | R | $\sqrt{3}$ | 1 | 0.06 | ∞ |
| Frequency Response | 0.2 | R | $\sqrt{3}$ | 1 | 0.12 | ∞ |
| Test Sample Related | | | | | | |
| Power Drift | 0.21 | R | $\sqrt{3}$ | 1 | 0.12 | ∞ |
| Modulation response | 0.40 | R | $\sqrt{3}$ | 1 | 0.23 | ∞ |
| Device holder influence | 0.1 | R | $\sqrt{3}$ | 1 | 0.06 | ∞ |
| RF Ambient Noise | 0.04 | R | $\sqrt{3}$ | 1 | 0.02 | ∞ |
| RF Ambient Reflections | 0.04 | R | $\sqrt{3}$ | 1 | 0.02 | ∞ |
| Combined Std. Uncertainty | | | | | 0.76 dB | ∞ |
| Expanded Std. Uncertainty 95% | | | | | 1.53 dB | |

A.6 RF Exposure Limits

Power density assessments have been made in line with the requirements of FCC 47CFR Part 2.1093, in particular chapter 1.1310 specifying the MPE limits, on the limitation of exposure of the general population / uncontrolled exposure for portable devices.

| Exposure Type | Power density (S) |
|--|-----------------------------|
| Limits for Occupational/Controlled Exposure. 1.5GHz – 100GHz | 50.0 W/m² |
| Limits for General Population/ Uncontrolled Exposure. 1.5GHz – 100GHz | 10.0 W/m² |

Annex B. SAR Test & System Description

B.1 SAR Definition

Specific Absorption rate is defined as the time derivative of the incremental energy (dW) absorbed by (dissipated in) and incremental mass (dm) contained in a volume element (dV) of a given density (ρ).

$$SAR = \frac{d}{dt} \cdot \left(\frac{dW}{dm} \right) = \frac{d}{dt} \cdot \left(\frac{dW}{\rho \cdot dV} \right)$$

SAR is expressed in units of watts per kilogram (W/kg). SAR can be related to the electric field at a point by

$$SAR = \frac{\sigma |E|^2}{\rho}$$

Where:

σ = Conductivity of the tissue (S/m)

ρ = Mass density of the tissue (kg/m³)

E = RMS electric field strength (V/m)

B.2 SAR Measurement System

B.2.1 SAR Measurement Setup

The DASY6 system for performing compliance tests consists of the following items:

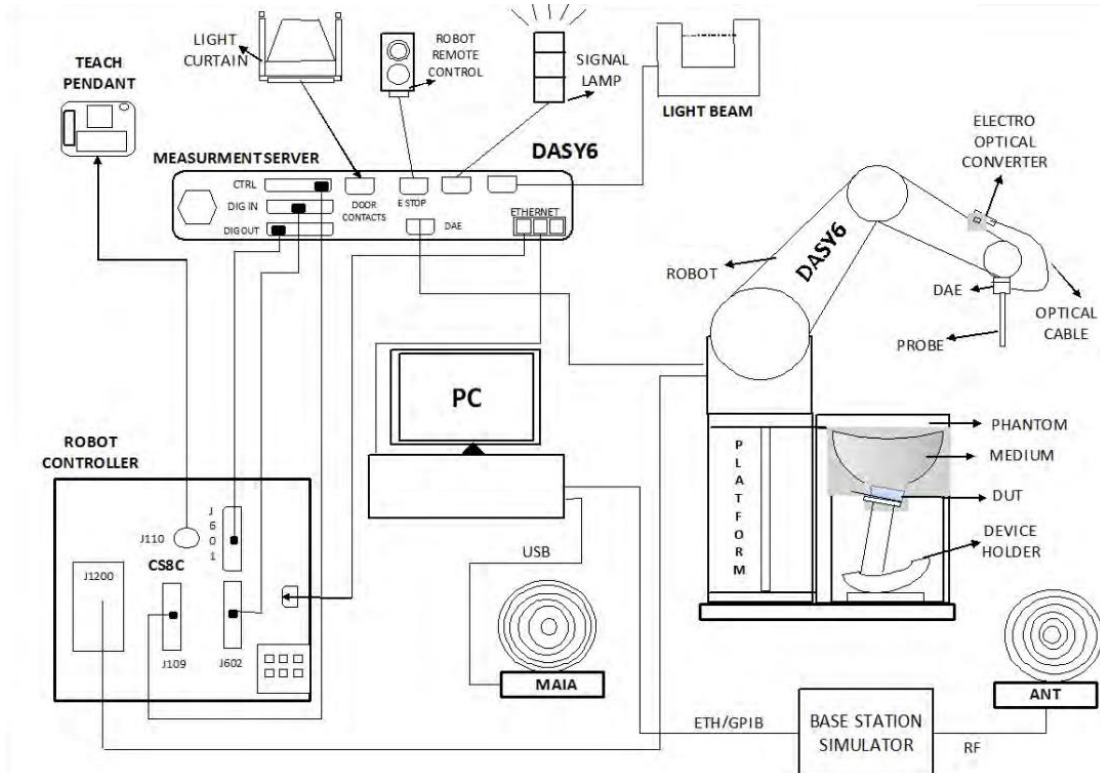

- ✓ A standard high precision 6-axis robot (Stäubli TX/RX family) with controller, teach pendant and software. It includes an arm extension for accommodating the data acquisition electronics (DAE)
- ✓ An isotropic field probe optimized and calibrated for the targeted measurements.
- ✓ A data acquisition electronics (DAE) which performs the signal amplification, signal multiplexing, AD-conversion, offset measurements, mechanical surface detection, collision detection, etc. The unit is battery powered with standard or rechargeable batteries. The signal is optically transmitted to the EOC.
- ✓ The Electro-optical Converter (EOC) performs the conversion from optical to electrical signals for the digital communication to the DAE. The EOC signal is transmitted to the measurement server.
- ✓ The function of the measurement server is to perform the time critical tasks such as signal filtering, control of the robot operation and fast movements interrupts.
- ✓ The Light Beam used is for probe alignment. This improves the (absolute) accuracy of the probe positioning.
- ✓ A computer running Win7 professional operating system and the DASY6 software.
- ✓ Remote control and teach pendant as well as additional circuitry for robot safety such as warning lamps, etc.
- ✓ The phantom, the device holder and other accessories according to the targeted measurement.
- ✓ MAIA is a hardware interface (Antenna) used to evaluate the modulation and audio interference characteristics of RF signals.
- ✓ ANT is an ultra-wideband antenna for use with the base station simulators over 698 MHz to 6GHz for SAR cellular testing (not used for WLAN testing).
- ✓ The base station simulator is an equipment used for SAR cellular tests in order to emulate the cellular signals characteristics and behavior between a regular base station and the equipment under test.
- ✓ Tissue simulating liquid.
- ✓ System Validation dipoles.
- ✓ Network emulator or RF test tool

B.2.2 E-Field Measurement Probe

The probe is constructed using three orthogonal dipole sensors arranged on an interlocking, triangular prism core. The probe has built-in shielding against static charges and is contained within a PEEK cylindrical enclosure material at the tip.



The probe's characteristics are:

| | |
|--|---------------|
| Frequency Range | 30MHz – 10GHz |
| Length | 337 mm |
| Probe tip external diameter | 2.5 mm |
| Typical distance between dipoles and the probe tip | 1 mm |
| Axial Isotropy (in human-equivalent liquids) | ±0.3 dB |
| Hemispherical Isotropy (in human-equivalent liquids) | ±0.5 dB |
| Linearity | ±0.2 dB |
| Maximum operating SAR | 100 W/kg |
| Lower SAR detection threshold | 0.001 W/kg |

B.2.3 Flat Phantom

Phantom for compliance testing of handheld and body-mounted wireless devices in the frequency range of 30 MHz to 6 GHz. ELI is fully compatible with the IEC 62209-2 standard and all known tissue simulating liquids. ELI has been optimized regarding its performance and can be integrated into our standard phantom tables. A cover prevents evaporation of the liquid. Reference markings on the phantom allow installation of the complete setup, including all predefined phantom positions and measurement grids, by teaching three points. The phantom is compatible with all SPEAG dosimetric probes and dipoles.

The phantom's characteristics are:

| | |
|-----------------|--|
| Material | Vinylester, glass fiber reinforced (VE-GF) |
| Shell thickness | 2 mm ± 0.2 mm |
| Filling volume | 30 Liters approx. |
| Dimensions | Major axis: 600mm / Minor axis: 400mm |

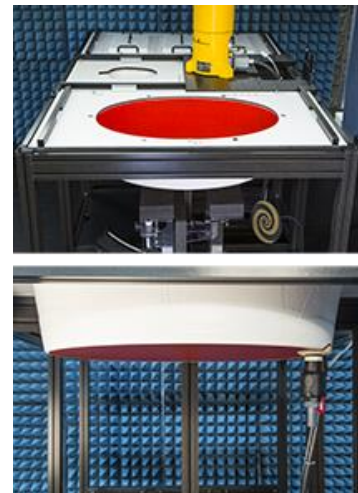

B.2.4 Device Positioner

The SAR in the phantom is approximately inversely proportional to the square of the distance between the source and the liquid surface. For a source at 5 mm distance, a positioning uncertainty of 0.5 mm would produce a SAR uncertainty of 20%. Accurate device positioning is therefore crucial for accurate and repeatable measurements. The positions in which the devices must be measured are defined by the standards.



The DASY device holder is designed to cope with the different positions given in the standard. It has two scales for device rotation (with respect to the body axis) and device inclination (with respect to the line between the ear reference points). The rotation center for both scales is the ear reference point (ERP). Thus the device needs no repositioning when changing the angles.

The DASY device holder is constructed of low-loss POM material having the following dielectric parameters: relative permittivity $\epsilon=3$ and loss tangent $\delta=0.02$. The amount of dielectric material has been reduced in the closest vicinity of the device, since measurements have suggested that the influence of the clamp on the test results could thus be lowered.

A simple but effective and easy-to-use extension for the Mounting Device; facilitates testing of larger devices according to IEC 62209-2 (e.g., laptops, cameras, etc.); lightweight and fits easily on the upper part of the Mounting Device in place of the phone positioner. The extension is fully compatible with the Twin SAM, ELI and other Flat Phantoms.



B.3 Data Evaluation

- **Power Reference measurement**

The robot measures the E field in a specified reference position that can be either the selected section's grid reference point or a user point in this section at 4mm of the inner surface of the phantom, 2mm for frequencies above 3GHz.

- **Area Scan**

Measurement procedures for evaluating SAR from wireless handsets typically start with a coarse measurement grid to determine the approximate location of the local peak SAR values. This is known as the area-scan procedure. The SAR distribution is scanned along the inside surface of one side of the phantom head, at least for an area larger than the projection of the handset and antenna. The distance between the measured points and phantom surface should be less than 8 mm, and should remain constant (with variation less than ± 1 mm) during the entire scan in order to determine the locations of the local peak SAR with sufficient accuracy. The angle between the probe axis and the surface normal line is recommended but not required to be less than 30° . If this angle is larger than 30° and the closest point on the probe-tip housing to the phantom surface is closer than a probe diameter, the boundary effect may become larger and polarization dependent. This additional uncertainty needs to be analyzed and accounted for. To achieve this, modified test procedures and additional uncertainty analyses not described in this recommended practice may be required. The measurement and interpolation point spacing should be chosen such as to allow identification of the local peak locations to within one-half of the linear dimension of a side of the zoom-scan volume. Because a local peak having specific amplitude and steep gradients may produce a lower peak spatial-average SAR compared to peaks with slightly lower amplitude and less steep gradients, it is necessary to evaluate these other peaks as well. However, since the spatial gradients of local SAR peaks are a function of the wavelength inside the tissue-equivalent liquid and the incident magnetic field strength, it is not necessary to evaluate local peaks that are less than 2 dB or more below the global maximum peak. Two-dimensional spline algorithms (Brishoual et al. 2001; Press et al., 1996) are typically used to determine the peaks and gradients within the scanned area. If a peak is found at a distance from the scan border of less than one-half the edge dimension of the desired 1 g or 10 g cube, the measurement area should be enlarged if possible.

- **Zoom Scan**

To evaluate the peak spatial-average SAR values for 1 g or 10 g cubes, fine resolution volume scans, called zoom scans, are performed at the peak SAR locations identified during the area scan. The minimum zoom scan volume size should extend at least 1.5 times the edge dimension of a 1 g cube in all directions from the center of the scan volume, for both 1 g and 10 g peak spatial-average SAR evaluations. Along the phantom curved surfaces, the front face of the volume facing the tissue/liquid interface conforms to the curved boundary, to ensure that all SAR peaks are captured. The back face should be equally distorted to maintain the correct averaging mass. The flatness and orientation of the four side faces are unchanged from that of a cube whose orientation is within $\pm 30^\circ$ of the line normal to the phantom at the center of the cube face next to the phantom surface. The peak local SAR locations that were determined in the area scan (interpolated values) should be used for the centers of the zoom scans. If a scan volume cannot be centered due to proximity of a phantom shape feature, the probe should be tilted to allow scan volume enlargement. If probe tilt is not feasible, the zoom-scan origin may be shifted, but not by more than half of the 1 g or 10 g cube edge dimension.

After the zoom-scan measurement, extrapolations from the closest measured points to the surface, for example along lines parallel to the zoom-scan centerline, and interpolations to a finer resolution between all measured and extrapolated points are performed. Extrapolation algorithm considerations are described in 6.5.3, and 3-D spline methods (Brishoual et al., 2001; Kreyszig, 1983; Press et al., 1996) can be used for interpolation. The peak spatial-average SAR is finally determined by a numerical averaging of the local SAR values in the interpolation grid, using for example a trapezoidal algorithm for the integration (averaging).

In some areas of the phantom, such as the jaw and upper head regions, the angle of the probe with respect to the line normal to the surface may be relatively large, e.g., greater than $\pm 30^\circ$, which could increase the boundary effect error to a larger level. In these cases, during the zoom scan a change in the orientation of the probe, the phantom, or both is recommended but not required for the duration of the zoom scan, so that the angle between the probe axis and the line normal to the surface is within 30° for all measurement points.

- **Power Drift measurement**

The robot re-measures the E-Field in the same reference location measured at the Power Reference. The drift measurement gives the field difference in dB from the first to the last reference reading. This allows a user to monitor the power drift of the device under test that must remain within a maximum variation of $\pm 5\%$.

- **Post-processing**

The procedure for spatial peak SAR evaluation has been implemented according to the IEEE1528 and IEC 62209-1/2 standards. It can be conducted for 1g and 10g.

The software allows evaluations that combine measured data and robot positions, such as:

- ✓ Maximum search
- ✓ Extrapolation
- ✓ Boundary correction
- ✓ Peak search for averaged SAR

Interpolation between the measured points is performed when the resolution of the grid is not fine enough to compute the average SAR over a given mass.

Extrapolation routines are used to obtain SAR values between the lowest measurement points and the inner phantom surface. The extrapolation is determined by the surface detection distance and the probe sensor offset. Several measurements at different distances are necessary for the extrapolation.

B.4 System and Liquid Check

B.4.1 System Check

The system performance check verifies that the system operates within its specifications. System and operator errors can be detected and corrected. It is recommended that the system performance check be performed prior to any usage of the system in order to guarantee reproducible results.

The system performance check uses normal SAR measurements in a simplified setup with a well characterized source. This setup was selected to give a high sensitivity to all parameters that might fail or vary over time. The system check does not intend to replace the calibration of the components, but indicates situations where the system uncertainty is exceeded due to drift or failure.

In the simplified setup for system check, the EUT is replaced by a calibrated dipole and the power source is replaced by a controlled continuous wave generated by a signal generator. The calibrated dipole must be placed beneath the flat phantom section of the phantom at the correct distance.

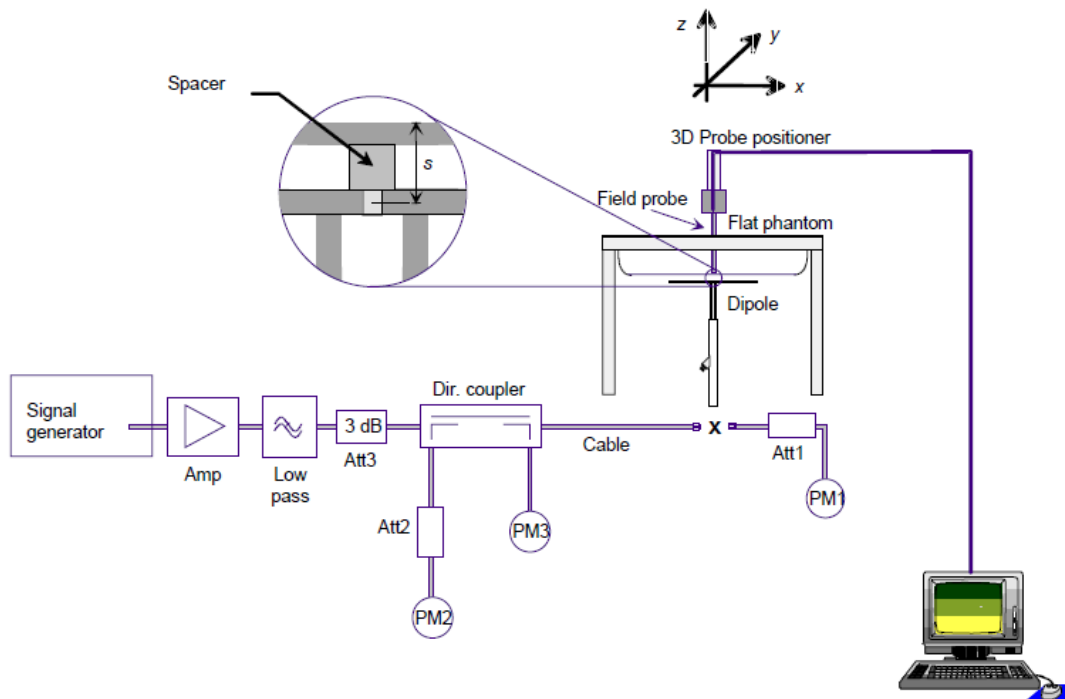

The equipment setup is shown below:

- ✓ Signal Generator
- ✓ Amplifier
- ✓ Directional coupler
- ✓ Power meter
- ✓ Calibrated dipole

First, the power meter PM1 (including attenuator Att1) is connected to the cable to measure the forward power at the location of the connector (x) to the system check source. The signal generator is adjusted for the desired forward power at the connector as read by power meter PM1 after attenuation Att1 and also as coupled through Att2 to PM2. After connecting the cable to the source, the signal generator is readjusted for the same reading at power meter PM2.

SAR results are normalized to a forward power of 1W to compare the values with the calibration reports results as described at IEEE 1528 and IEC 62209 standards.

B.4.2 Liquid Check

The dielectric parameters check is done prior to the use of the tissue simulating liquid. The verification is made by comparing the relative permittivity and conductivity to the values recommended by the applicable standards.

The liquid verification was performed using the following test setup:

- ✓ VNA (Vector Network Analyzer)
- ✓ Open-Short-Load calibration kit
- ✓ RF Cable
- ✓ Open-Ended Coaxial probe
- ✓ DAK software tool
- ✓ SAR Liquid
- ✓ De-ionized water
- ✓ Thermometer

These are the target dielectric properties of the tissue-equivalent liquid material according to the manufacturer's datasheet:

| Frequency (MHz) | Head Tissue Simulating Medium | |
|--------------------|----------------------------------|----------------|
| | ϵ_r (F/m) | σ (S/m) |
| 6000 | 35.07 | 5.48 |
| 6500 | 34.46 | 6.07 |
| 7000 | 33.88 | 6.65 |

(ϵ_r = relative permittivity, σ = conductivity and $\rho = 1000 \text{ kg/m}^3$)

The measurement system implement a SAR error compensation algorithm as documented in IEEE Std 1528-2013 (equivalent to draft standard IEEE P1528-2011) to automatically compensate the measured SAR results for deviations between the measured and required tissue dielectric parameters (applied to only scale up the measured SAR, and not downward) so, according to FCC OET KDB 865664 D01, the tolerance for ϵ_r and σ may be relaxed to $\pm 10\%$.

B.5 Test Equipment List

SAR system #3

| ID # | Device | Type/Model | Serial Number | Manufacturer | Cal. Date | Cal. Due Date |
|---------|------------------------------|-------------------|-----------------|--------------|------------|---------------|
| 003-000 | 6-Axis Robot | TX60L speag | F17/59RCB1/A/01 | STAÜBLI | NA | NA |
| 003-001 | Robot Controller | CS8C | F17/59RCB1/C/01 | STAÜBLI | NA | NA |
| 003-002 | Oval Flat Phantom | ELI V5.0 | 1260 | SPEAG | NA | NA |
| 003-003 | Light Beam Unit | SE UKS 030 AA | 1170 | Di-soric | NA | NA |
| 003-004 | Measurement Server | DASY6 | 1547 | SPEAG | NA | NA |
| 003-005 | Electro Optical Converter | EOC60 | 1104 | SPEAG | NA | NA |
| 003-006 | Measurement Software | DASY6 V16.0.0.116 | 9-5ED1AC01 | SPEAG | NA | NA |
| 002-013 | Data Acquisition Electronics | DAE4 | 1658 | SPEAG | 2021-08-04 | 2022-08-04 |
| 003-009 | Laptop Holder | N/A | N/A | SPEAG | NA | NA |
| 003-007 | Dosimetric E-field Probe | EX3DV4 | 7465 | SPEAG | 2021-07-23 | 2022-07-23 |

Shared equipment

| ID # | Device | Type/Model | Serial Number | Manufacturer | Cal. Date | Cal. Due Date |
|---------|----------------------------------|-----------------------------|---------------|----------------------|------------|---------------|
| 123-000 | USB Power Sensor | NRP-Z81 | 102278 | R&S | 2021-04-13 | 2023-04-13 |
| 124-000 | USB Power Sensor | NRP-Z81 | 102279 | R&S | 2021-04-13 | 2023-04-13 |
| 099-000 | Liquid measurement SW | DAK-3.5 V2.6.0.5 | 9-2687B491 | SPEAG | NA | NA |
| 369-000 | Dielectric Probe Kit | DAK-3.5 | 1309 | SPEAG | 2021-03-10 | 2023-03-10 |
| 089-000 | Vector Reflectometer | R140 1-Port 14 GHz Analyzer | 0190616 | Copper Mountain tech | 2021-09-02 | 2023-09-02 |
| 077-000 | Coupler | CD0.5-8-20-30 | 1251-002 | Amd-group | 2022-02-01 | 2022-08-01 |
| 078-000 | RF Cable | ST-18/SMAm/SMAm/48 | - | Huber & Suhner | 2022-02-01 | 2022-08-01 |
| 079-000 | RF Cable | ST-18/SMAm/SMAm/48 | - | Huber & Suhner | 2022-02-01 | 2022-08-01 |
| 126-000 | Vector Signal Generator | ESG E4438C | MY45092885 | Agilent | 2021-05-27 | 2023-05-27 |
| 327-000 | Temp & Humidity Logger | RA32E-TH1-RAS | RA32-F0DED9 | AVTECH | 2021-03-09 | 2023-03-09 |
| 398-000 | Thermometer | TESTO 922 | 33622932/208 | Testo | 2021-11-09 | 2023-11-09 |
| 098-000 | Vector Signal Generator | SMW200A 20GHz | 103732 | R&S | 2020-07-20 | 2022-07-20 |
| 198-000 | Power Amplifier | TVA-82-213A+ | 2004003 | Mini-circuits | 2022-02-01 | 2022-08-01 |
| 096-000 | System Validation Dipole 6500MHz | D6.5GHzV2 | 1013 | SPEAG | 2020-09-25 | 2022-09-25 |

B.5.1 Tissue Simulant Liquid

| TSL | Manufacturer / Model | Freq Range (MHz) | Main Ingredients |
|---------------|--------------------------------------|------------------|--|
| Head WideBand | SPEAG HBBL600-10000V6 Batch 210331-1 | 600-10000 | Ethanediol, Sodium petroleum sulfonate, Hexylene Glycol / 2-Methyl-pentane-2.4-diol, Alkoxylated alcohol |

B.6 Measurement Uncertainty Evaluation

The system uncertainty evaluation is shown in the table below with a coverage factor of $k = 2$ to indicate a 95% level of confidence:

| SPEAG DASY6 Uncertainty Budget According to IEC/IEEE 62209-1528 (6 GHz - 10 GHz) | | | | | | | | |
|---|-------------------------------------|---------------|-------------|------|---------|----------|----------------|----------------|
| Symbol | Error Description | Uncert. Value | Prob. Dist. | Div. | (ci) 1g | (ci) 10g | Std Unc. (1g) | Std Unc. (10g) |
| Measurement System Errors | | | | | | | | |
| CF | Probe Calibration | ±18.6 % | N | 2 | 1 | 1 | ±9.3 % | ±9.3 % |
| CF _{drift} | Probe Calibration Drift | ±1.0 % | N | 1 | 1 | 1 | ±1.0 % | ±1.0 % |
| LIN | Probe Linearity | ±4.7 % | R | √3 | 1 | 1 | ±2.7 % | ±2.7 % |
| BBS | Broadband Signal | ±3.0 % | N | 2 | 1 | 1 | ±1.5 % | ±1.5 % |
| ISO | Axial Isotropy | ±4.7 % | R | √3 | 0.5 | 0.5 | ±1.4 % | ±1.4 % |
| ISO | Hemispherical Isotropy | ±9.6 % | R | √3 | 0.5 | 0.5 | ±2.8 % | ±2.8 % |
| DAE | Data Acquisition | ±0.3 % | N | 1 | 1 | 1 | ±0.3 % | ±0.3 % |
| AMB | RF Ambient | ±1.8 % | N | 1 | 1 | 1 | ±1.8 % | ±1.8 % |
| Δ _{sys} | Probe Positioning | ±0.2 % | N | 1 | 0.33 | 0.33 | ±0.1 % | ±0.1 % |
| DAT | Data Processing | ±3.5 % | N | 1 | 1 | 1 | ±3.5 % | ±3.5 % |
| Phantom and Device Errors | | | | | | | | |
| LIQ(σ) | Conductivity (meas.) _{DAK} | ±2.5 % | N | 1 | 0.78 | 0.71 | ±2.0 % | ±1.8 % |
| LIQ(Tσ) | Conductivity (temp.) _{BB} | ±2.4 % | R | √3 | 0.78 | 0.71 | ±1.1 % | ±1.0 % |
| EPS | Phantom Permittivity | ±14.0 % | R | √3 | 0.5 | 0.5 | ±4.0 % | ±4.0 % |
| DAS | Distance DUT - TSL | ±2.0 % | N | 1 | 2 | 2 | ±4.0 % | ±4.0 % |
| H | Device Holder | ±3.6 % | N | 1 | 1 | 1 | ±3.6 % | ±3.6 % |
| MOD | DUT Modulation _m | ±2.4 % | R | √3 | 1 | 1 | ±1.4 % | ±1.4 % |
| TAS | Time-average SAR | ±2.6 % | R | √3 | 1 | 1 | ±1.5 % | ±1.5 % |
| RF _{drift} | DUT drift | ±5.0 % | N | 1 | 1 | 1 | ±2.9 % | ±2.9 % |
| Correction to the SAR results | | | | | | | | |
| C(ε, σ) | Deviation to Target | ±1.9 % | N | 1 | 1 | 0.84 | ±1.9 % | ±1.6 % |
| C(R) | SAR scaling _p | ±0 % | R | √3 | 1 | 1 | ±0 % | ±0 % |
| Combined Std. Uncertainty | | | | | | | ±13.7 % | ±13.7 % |
| Expanded STD Uncertainty | | | | | | | ±27.5 % | ±27.3 % |

B.7 RF Exposure Limits

SAR assessments have been made in line with the requirements of FCC 47CFR Part 2.1093 on the limitation of exposure of the general population / uncontrolled exposure for portable devices.

| Exposure Type | General Population / Uncontrolled Environment |
|--|--|
| Peak spatial-average SAR (averaged over any 1 gram of tissue) | 1.6 W/kg |
| Whole body average SAR | 0.08 W/kg |
| Peak spatial-average SAR (extremities) (averaged over any 10 grams of tissue) | 4.0 W/kg |

Annex C. Test Results

The herein test results were performed by:

| | |
|-----------------------------------|----------------|
| Test case measurement | Test Personnel |
| Conducted measurement | F. Heurtematte |
| SAR measurement PD measurement | Y.Haddad |

C.1 Test Conditions

C.1.1 Test positions relative to the phantom

The device under test was an Intel® Wi-Fi 6E AX411 card inside convertible host platform (HP TPN-C155) using a set of PIFA antenna. The card was operated utilizing proprietary software (DRTU version 22.210100.0.0-OEM.DRTU.00125.22.100.0) and each channel was measured using a broadband power meter to determine the maximum average power.

According to FCC OET KDB 616217 D04, laptop position should be tested for SAR compliance with the display screen opened at an angle of 90° to the keyboard compartment and the notebook bottom surface must be touching the phantom.

According to FCC OET KDB 616217 D04, adjacent edges of the tablet should be tested for SAR compliance with the tablet touching the phantom. The SAR Test Exclusion Threshold in FCC OET KDB 447498 D01 can be applied to determine SAR test exclusion for adjacent edge configurations. (See section for power specifications)

| Antenna | Main/Tx2 | Aux/Tx1 |
|----------|--|--|
| Position | <ul style="list-style-type: none"> • Bottom Edge • Back Face • Laptop | <ul style="list-style-type: none"> • Bottom Edge • Back Face • Laptop |

As per the Interim Procedures for UNII 6-7GHz RF Exposure, explained in *RF Exposure Policies and Procedures: TCB Workshop – October 2020*, the testing has been performed on SAR following IEC/IEEE 62209-1528:2020 and then on Power Density for the highest SAR test configurations.

The test configuration (antenna transmitter and test position) which has the worst case *reported SAR 1g (W/kg)* result over uninterrupted UNII 5 - 8 bands per antenna manufacturer was chosen to carry out the power density measurement in each UNII 6-7GHz sub band. Due to constraints on the power density method, the testing at 0mm distance from the DUT could not be performed. The closest distance, without damaging the test system was chosen to be 2.5mm.

See Section G.2 for more information on the tested positions

C.1.2 Test signal, Output power and Test Frequencies

For 802.11 transmission modes the device was put into operation by using an own control software to program the test mode required to select the continuous transmission with 100% duty cycle.

The output power of the device was set to transmit at maximum power for all tests.

C.1.3 Evaluation Exclusion and Test Reductions

C.1.3.1 SAR evaluation exclusion

The SAR Test Exclusion Threshold in FCC OET KDB 447498 D01 v06 can be applied to determine SAR test exclusion for adjacent edge configurations. For 100MHz to 6GHz and test separation distances ≤50mm, the 1-g and 10-g SAR test exclusion thresholds are determined by the following formula:

$$[(\text{max. power of channel, including tune – up tolerance, mW}) / (\text{min. test separation distance, mm})] \cdot \left[\sqrt{f(\text{GHz})} \right] \leq 3.0 \text{ for } 1\text{g SAR, and } \leq 7.5 \text{ for } 10\text{g extremity SAR} \tag{1}$$

Where:

- f(GHz) is the RF channel transmit frequency in GHz
- Power and distance are rounded to the nearest mW and mm before calculation
- The result is rounded to one decimal place for comparison
- The values 3.0 and 7.5 are referred to as numeric thresholds

The test exclusions are applicable only when the minimum test separation distance is ≤ 50 mm, and for transmission frequencies between 100 MHz and 6 GHz. When the minimum test separation distance is < 5 mm, a distance of 5 mm is applied to determine SAR test exclusion.

For test separation distances > 50 mm, the 1-g and 10-g SAR test exclusion thresholds are determined using the following formulas:

$$((\text{Power allowed at numeric threshold for } 50 \text{ mm in (1)}) + (\text{test separation distance} - 50 \text{ mm}) \cdot (f_{\text{MHz}}/150))\text{mW}, \tag{2}$$

for 100MHz to 1500MHz

$$((\text{Power allowed at numeric threshold for } 50 \text{ mm in (1)}) + (\text{test separation distance} - 50 \text{ mm}) \cdot 10)\text{mW}, \tag{3}$$

for 1500MHz and ≤ 6GHz

| LAN Antenna | Band Name | Output power | | Bottom Edge | Back Face | Laptop | Bottom Edge | Back Face | Laptop |
|-------------|-----------|--------------|-------|-------------|-----------|--------|-------------|-----------|--------|
| | | dBm | mW | | | | | | |
| WLAN Main | U-NII-5 | 13.50 | 22.39 | <50 | <50 | <50 | T | T | T |
| | U-NII-6 | 13.05 | 22.39 | <50 | <50 | <50 | T | T | T |
| | U-NII-7 | 12.75 | 18.84 | <50 | <50 | <50 | T | T | T |
| | U-NII-8 | 12.75 | 18.84 | <50 | <50 | <50 | T | T | T |
| WLAN Aux | U-NII-5 | 13.50 | 22.39 | <50 | <50 | <50 | T | T | T |
| | U-NII-6 | 13.50 | 22.39 | <50 | <50 | <50 | T | T | T |
| | U-NII-7 | 12.75 | 18.84 | <50 | <50 | <50 | T | T | T |
| | U-NII-8 | 12.75 | 18.84 | <50 | <50 | <50 | T | T | T |

T: Tested position
R: Reduced

See Annex F for a more detailed explanation of the separation distance related to the platform.

C.2 Conducted Power Measurements

C.2.1 WLAN 6-7GHz (U-NII)

C.2.1.1 6.2GHz (U-NII-5)

| Band | Mode Data Rate | BW | Ch # | Freq (MHz) | Main | | Aux | | SAR Test? |
|---------|----------------|-----|------|------------|-------|-------------------|-------|-------------------|-----------|
| | | | | | INPAQ | Tune-up Pwr (dBm) | INPAQ | Tune-up Pwr (dBm) | |
| U-NII-5 | 802.11ax HE0 | 20 | 1 | 5955 | NR | 5.00 | NR | 5.00 | No |
| | 802.11ax HE0 | 20 | 45 | 6175 | | 5.00 | | 5.00 | |
| | 802.11ax HE0 | 20 | 93 | 6415 | | 5.00 | | 5.00 | |
| | 802.11ax HE0 | 40 | 3 | 5965 | | 8.25 | | 8.25 | |
| | 802.11ax HE0 | 40 | 43 | 6165 | | 8.25 | | 8.25 | |
| | 802.11ax HE0 | 40 | 91 | 6405 | | 8.25 | | 8.25 | |
| | 802.11ax HE0 | 80 | 7 | 5985 | | 10.75 | | 10.75 | |
| | 802.11ax HE0 | 80 | 39 | 6145 | | 10.75 | | 10.75 | |
| | 802.11ax HE0 | 80 | 87 | 6385 | | 10.75 | | 10.75 | |
| | 802.11ax HE0 | 160 | 15 | 6025 | 13.35 | 13.50 | 13.45 | 13.50 | Yes |
| | 802.11ax HE0 | 160 | 47 | 6185 | 13.45 | 13.50 | 13.36 | 13.50 | No |
| | 802.11ax HE0 | 160 | 79 | 6345 | 13.22 | 13.50 | 13.10 | 13.50 | Yes |

Initial test configuration

1. NR: Not Required

C.2.1.2 6.5GHz (U-NII-6)

| Band | Mode Data Rate | BW | Ch # | Freq (MHz) | Main | | Aux | | SAR Test? |
|---------|----------------|-----|------|------------|-------|-------------------|-------|-------------------|-----------|
| | | | | | INPAQ | Tune-up Pwr (dBm) | INPAQ | Tune-up Pwr (dBm) | |
| U-NII-6 | 802.11ax HE0 | 20 | 97 | 6435 | NR | 5.00 | NR | 5.00 | No |
| | | 20 | 105 | 6475 | | 5.00 | | 5.00 | |
| | | 20 | 113 | 6515 | | 5.00 | | 5.00 | |
| | 802.11ax HE0 | 40 | 99 | 6445 | | 8.25 | | 8.25 | |
| | | 40 | 107 | 6485 | | 8.25 | | 8.25 | |
| | 802.11ax HE0 | 80 | 103 | 6465 | | 10.75 | | 10.75 | |
| | | 80 | 119 | 6545 | 10.75 | 10.75 | | | |
| | 802.11ax HE0 | 160 | 111 | 6505 | 13.27 | 13.50 | 13.40 | 13.50 | Yes |

Initial test configuration

1. NR: Not Required

C.2.1.3 6.7GHz (U-NII-7)

| Band | Mode | Data Rate | BW | Ch # | Freq (MHz) | Main | | Aux | | SAR Test? | | | |
|-----------|--------------|-----------|-----|------|------------|-------|-------------------|-------|-------------------|-----------|-------|-------|-----|
| | | | | | | INPAQ | Tune-up Pwr (dBm) | INPAQ | Tune-up Pwr (dBm) | | | | |
| 7-U-NII-7 | 802.11ax HE0 | 20 | 117 | 6535 | NR | | 4.00 | NR | 4.00 | No | | | |
| | | 20 | 149 | 6695 | | | 4.00 | | 4.00 | | | | |
| | | 20 | 181 | 6855 | | | 4.00 | | 4.00 | | | | |
| | 802.11ax HE0 | 40 | 115 | 6525 | | | 7.50 | | 7.50 | | | | |
| | | 40 | 147 | 6685 | | | 7.50 | | 7.50 | | | | |
| | | 40 | 179 | 6845 | | | 7.50 | | 7.50 | | | | |
| | 802.11ax HE0 | 80 | 135 | 6625 | | | 10.00 | | 10.00 | | | | |
| | | 80 | 151 | 6705 | | | 10.00 | | 10.00 | | | | |
| | | 80 | 167 | 6785 | | | 10.00 | | 10.00 | | | | |
| | 802.11ax HE0 | 160 | 143 | 6665 | | | 12.75 | | 12.75 | | 12.67 | 12.75 | Yes |
| | | 160 | 175 | 6825 | | | 12.60 | | 12.75 | | 12.53 | 12.75 | |

Initial test configuration

- 1. NR: Not Required

C.2.1.4 7.0GHz (U-NII-8)

| Band | Mode | Data Rate | Ch # | Freq (MHz) | Main | | Aux | | SAR Test? | | | | |
|-----------|--------------|-----------|------|------------|-------|-------------------|-------|-------------------|-----------|----|-------|-------|-----|
| | | | | | INPAQ | Tune-up Pwr (dBm) | INPAQ | Tune-up Pwr (dBm) | | | | | |
| 8-U-NII-8 | 802.11ax HE0 | 20 | 185 | 6875 | NR | | 4.00 | NR | 4.00 | No | | | |
| | | 20 | 209 | 6995 | | | 4.00 | | 4.00 | | | | |
| | | 20 | 233 | 7115 | | | 4.00 | | 4.00 | | | | |
| | 802.11ax HE0 | 40 | 187 | 6885 | | | 7.50 | | 7.50 | | | | |
| | | 40 | 227 | 7085 | | | 7.50 | | 7.50 | | | | |
| | 802.11ax HE0 | 80 | 183 | 6865 | | | 10.00 | | 10.00 | | | | |
| | | 80 | 199 | 6945 | | | 10.00 | | 10.00 | | | | |
| | | 80 | 215 | 7025 | | | 10.00 | | 10.00 | | | | |
| | 802.11ax HE0 | 160 | 207 | 6985 | | | 12.75 | | 12.75 | | 12.72 | 12.75 | Yes |

Initial test configuration

- 1. NR: Not Required

C.3 Tissue Parameters Measurement

Head TSL

| Freq. (MHz) | Target Parameters | | Measured TSL Parameters | | Deviation (%) | | Date |
|----------------|-------------------|----------------|----------------------------|----------------|---------------|----------|------------|
| | ϵ' (F/m) | σ (S/m) | ϵ' (F/m) | σ (S/m) | ϵ' | σ | |
| 6500 | 34.46 | 6.07 | 32.35 | 6.19 | -6.12 | 1.98 | 2022-02-21 |

See Annex D for more details.

C.4 System Check Measurements

C.4.1 E-Field

| Frequency | Signal Type | Target E-field (V/m) | Measured E-field (V/m) | Deviation (%) | Date |
|-----------|--------------------|----------------------------|------------------------------|------------------|------------|
| 6.5GHz | Continuous Wave | 60.60 | 61.74 | 1.88 | 2022-02-23 |

The E-fields presented in the System Check Measurements table are Peak values. The target E-field value is obtained by simulation. The maximum target E-field value at 10 mm with 10 dBm (10 mW) source power is 60.60 V/m. The maximum measured E-field value at 10 mm with 10 dBm (10 mW) is 61.74V/m.

C.4.2 H-Field

| Frequency | Signal Type | Target H-field (A/m) | Measured H-field (A/m) | Deviation (%) | Date |
|-----------|--------------------|----------------------------|------------------------------|------------------|------------|
| 6.5GHz | Continuous Wave | 0.17 | 0.16 | -5.88 | 2022-02-23 |

The H-fields presented in the System Check Measurements table are Peak values. The target H-field value is obtained by simulation. The maximum target H-field value at 10 mm with 10 dBm (10 mW) source power is 0.17 A/m. The maximum measured E-field value at 10 mm with 10 dBm (10 mW) is 0.16A/m.

C.4.3 Local Power Density

| Frequency | Signal Type | Target Local Power Density (W/m ²) | Measured Local Power Density (W/m ²) | Deviation (%) | Date |
|-----------|--------------------|--|--|------------------|------------|
| 6.5GHz | Continuous Wave | 5.12 | 4.83 | -5.66 | 2022-02-23 |

The Local Power Density presented in the System Check Measurements table are Peak values. The target Local Power Density value is obtained by simulation. The maximum target Local Power Density value at 10 mm with 10 dBm (10 mW) source power is 5.12 W/m². The maximum measured E-field value at 10 mm with 10 dBm (10 mW) is 4.83 W/m².

C.4.4 Averaged Power Density

| Frequency | Signal Type | Target Spatially Averaged Power Density (W/m ²) | Measured Spatially Averaged Power Density (W/m ²) | Deviation (%) | Date |
|-----------|--------------------|--|--|------------------|------------|
| 6.5GHz | Continuous Wave | 4.93 | 4.61 | -6.49 | 2022-02-23 |

The Spatially Averaged Power Density presented in the System Check Measurements table are Peak values. The target Spatially Averaged Power Density value is obtained by simulation. The maximum target Spatially Averaged Power Density value at 10 mm with 10 dBm (10 mW) source power is 4.93 W/m². The maximum measured Spatially Averaged Power Density value at 10 mm with 10 dBm (10 mW) is 4.61 W/m².

See Annex D for more details.

C.4.5 SAR

Head Measurements

| Frequency (MHz) | Average | Target SAR (W/Kg) | Measured SAR (W/Kg) | Deviation to target (%) | Limit (%) | Date |
|-----------------|---------|-------------------|---------------------|-------------------------|-----------|------------|
| 6500 | 1g | 291.0 | 268.13 | -7.86 | 10.00 | 2022-02-21 |
| | 10g | 53.8 | 50.60 | -5.95 | | |

C.5 Test Results

C.5.1 SAR - 802.11ax – 6.2 GHz – U-NII-5

| Antenna Manufacturer | Mode Data Rate | BW (MHz) | Channel Number | Freq (MHz) | Test position mode | Ant | Scaling Factor (dB). | Measured SAR 1g. (W/kg) | Reported SAR 1g (W/Kg) | Estimated epithelial PD (W/m ²)* | | No Plot | | |
|----------------------|----------------|----------|----------------|------------|--------------------|------|----------------------|-------------------------|------------------------|--|------------------|---------|--|--|
| | | | | | | | | | | 1cm ² | 4cm ² | | | |
| INPAQ | 802.11ax HE0 | 160 | 15 | 6025 | Back Face | MAIN | 0.15 | 0.04 | 0.05 | | | 1 | | |
| | | | | | Bottom Edge | | | | | 3.11 | 1.99 | | | |
| | | | | | Laptop | | | | | | | | | |
| | | | 79 | 6345 | Back Face | | 0.28 | 0.03 | 0.03 | | | | | |
| | | | | | Bottom Edge | | | | | 0.28 | 0.15 | 0.16 | | |
| | | | | | Laptop | | | | | 0.28 | 0.02 | 0.02 | | |
| | | | 15 | 6025 | Back Face | | 0.05 | 0.04 | 0.04 | | | | | |
| | | | | | Bottom Edge | | | | | 0.05 | 0.19 | 0.19 | | |
| | | | | | Laptop | | | | | 0.05 | 0.02 | 0.02 | | |
| | | | 78 | 6345 | Back Face | 0.40 | 0.02 | 0.02 | | | | | | |
| | | | | | Bottom Edge | | | | 0.40 | 0.12 | 0.13 | | | |
| | | | | | Laptop | | | | 0.40 | 0.01 | 0.02 | | | |

* For reference purposes only, not specifically for compliance, the estimated absorbed (epithelial) power density derived from the measured SAR is shown

C.5.1 SAR - 802.11ax – 6.5 GHz – U-NII-6

| Antenna Manufacturer | Mode Data Rate | BW (MHz) | Channel Number | Freq (MHz) | Test position mode | Ant | Scaling Factor (dB). | Measured SAR 1g. (W/kg) | Reported SAR 1g (W/Kg) | Estimated epithelial PD (W/m ²)* | | No Plot | |
|----------------------|----------------|----------|----------------|------------|--------------------|------|----------------------|-------------------------|------------------------|--|------------------|---------|--|
| | | | | | | | | | | 1cm ² | 4cm ² | | |
| INPAQ | 802.11 ax HE0 | 160 | 111 | 6505 | Back Face | MAIN | 0.23 | 0.03 | 0.03 | | | 2 | |
| | | | | | Bottom Edge | | | | | 2.15 | 1.43 | | |
| | | | | | Laptop | | | | | | | | |
| | | | | | Back Face | AUX | 0.10 | 0.05 | 0.05 | | | | |
| | | | | | Bottom Edge | | | | | 0.10 | 0.22 | 0.23 | |
| | | | | | Laptop | | | | | 0.10 | 0.03 | 0.03 | |

* For reference purposes only, not specifically for compliance, the estimated absorbed (epithelial) power density derived from the measured SAR is shown

C.5.1 SAR - 802.11ax – 6.7 GHz – U-NII-7

| Antenna Manufacturer | Mode | BW (MHz) | Channel Number | Freq (MHz) | Test position mode | Ant | Scaling Factor (dB). | Measured SAR 1g. (W/kg) | Reported SAR 1g (W/Kg) | Estimated epithelial PD (W/m ²) | | No Plot |
|----------------------|---------------|----------|----------------|------------|--------------------|------|----------------------|-------------------------|------------------------|---|------------------|---------|
| | | | | | | | | | | 1cm ² | 4cm ² | |
| INPAQ | 802.11 ax HE0 | 160 | 143 | 6665 | Back Face | MAIN | 0.00 | 0.02 | 0.02 | | | |
| | | | | | Bottom Edge | | 0.00 | 0.12 | 0.12 | | | |
| | | | | | Laptop | | 0.00 | 0.02 | 0.02 | | | |
| | | | | | Back Face | AUX | 0.08 | 0.03 | 0.03 | | | |
| | | | | | Bottom Edge | | 0.08 | 0.20 | 0.20 | 2.01 | 1.14 | 3 |
| | | | | | Laptop | | 0.08 | 0.03 | 0.03 | | | |

* For reference purposes only, not specifically for compliance, the estimated absorbed (epithelial) power density derived from the measured SAR is shown

C.5.1 SAR - 802.11ax – 7.0 GHz – U-NII-8

| Antenna Manufacturer | Mode | BW (MHz) | Channel Number | Freq (MHz) | Test position mode | Ant | Scaling Factor (dB). | Measured SAR 1g. (W/kg) | Reported SAR 1g (W/Kg) | Estimated epithelial PD (W/m ²) | | No Plot |
|----------------------|---------------|----------|----------------|------------|--------------------|------|----------------------|-------------------------|------------------------|---|------------------|---------|
| | | | | | | | | | | 1cm ² | 4cm ² | |
| INPAQ | 802.11 ax HE0 | 160 | 207 | 6985 | Back Face | MAIN | 0.00 | 0.02 | 0.02 | | | |
| | | | | | Bottom Edge | | 0.00 | 0.20 | 0.20 | 1.98 | 1.29 | 4 |
| | | | | | Laptop | | 0.00 | 0.02 | 0.02 | | | |
| | | | | | Back Face | AUX | 0.03 | 0.03 | 0.03 | | | |
| | | | | | Bottom Edge | | 0.03 | 0.12 | 0.12 | | | |
| | | | | | Laptop | | 0.03 | 0.02 | 0.02 | | | |

* For reference purposes only, not specifically for compliance, the estimated absorbed (epithelial) power density derived from the measured SAR is shown

C.5.2 Power Density - 802.11ax – U-NII-5, UNII-6, UNII-7, UNII-8

| Ant. | Transmitter | Mode Data rate | BW (MHz) | Ch # | Freq (MHz) | Position | PStot avg [W/m ²] 1cm ² | PStot avg [W/m ²] 4cm ² | EM E [V/m] | EM H [A/m] | Plot # |
|-------|-------------|----------------|----------|------|------------|-------------|--|--|------------|------------|--------|
| INPAQ | Main | 802.11ax HE0 | 160 | 15 | 6025 | Bottom Edge | 4.18 | 2.60 | 66.70 | 0.21 | 5 |
| | | | | 79 | 6345 | | 2.92 | 1.83 | 53.50 | 0.17 | |

| Ant. | Transmitter | Mode Data Rate | BW (MHz) | Ch # | Freq (MHz) | Position | PStot avg [W/m ²] 1cm ² | PStot avg [W/m ²] 4cm ² | EM E [V/m] | EM H [A/m] | Plot # |
|-------|-------------|----------------|----------|------|------------|-------------|--|--|------------|------------|----------|
| INPAQ | Main | 802.11ax HE0 | 160 | 111 | 6505 | Bottom Edge | 2.49 | 1.48 | 58.40 | 0.19 | 6 |

| Ant. | Transmitter | Mode Data Rate | BW (MHz) | Ch # | Freq (MHz) | Position | PStot avg [W/m ²] 1cm ² | PStot avg [W/m ²] 4cm ² | EM E [V/m] | EM H [A/m] | Plot # |
|-------|-------------|----------------|----------|------|------------|-------------|--|--|------------|------------|----------|
| INPAQ | Main | 802.11ax HE0 | 160 | 143 | 6665 | Bottom Edge | 1.31 | 0.98 | 39.60 | 0.15 | 7 |

| Ant. | Transmitter | Mode Data rate | BW (MHz) | Ch # | Freq (MHz) | Position | PStot avg [W/m ²] 1cm ² | PStot avg [W/m ²] 4cm ² | EM E [V/m] | EM H [A/m] | Plot # |
|-------|-------------|----------------|----------|------|------------|-------------|--|--|------------|------------|----------|
| INPAQ | Main | 802.11ax HE0 | 160 | 207 | 6985 | Bottom Edge | 1.46 | 1.26 | 40.80 | 0.13 | 8 |

C.5.3 Measurement Variability

According to FCC OET KDB 865664, SAR Measurement variability is assessed when the maximum initial measured SAR is ≥ 0.8 W/kg for a certain band/mode. Considering that all the measured values are < 0.8 W/kg, no variability is required.

C.5.4 Simultaneous Transmission Evaluation – SAR

According to FCC OET KDB 447498 D01, when the sum of 1g SAR for all simultaneously transmitting antennas in an operating mode and exposure condition combination is within the SAR limit, SAR test exclusion applies to that simultaneous transmission configuration.

All the values stated in the table below are the worst case found for standalone measurement with disregard of the transmission mode or channel where the worst case was found

| Antenna | Position | Highest Reported SAR (1g) (W/Kg) | | |
|---------|-------------|----------------------------------|-------------|------------|
| | | WLAN 2.4GHz* | WLAN 6.0GHz | Bluetooth* |
| Aux | Bottom Edge | 0.09 | 0.23 | 0.00 |
| Main | | 0.15 | 0.32 | |

* For WLAN 2.4GHz and Bluetooth values refer to test report 220124-02.TR01_FCC_WIFI_SAR_WLAN_HP TPN-C155_wAX411NGW

| Position | Simultaneous Tx Antenna Combination | | Σ SAR 1g (W/kg) | Limit (W/kg) |
|-------------|-------------------------------------|--------------------|-----------------|--------------|
| | Aux | Main | | |
| Bottom Edge | WLAN 6GHz + BT | WLAN 6GHz | 0.55 | 1.6 |
| | WLAN 2.4GHz | WLAN 2.4GHz | 0.24 | |
| | BT | WLAN 2.4GHz | 0.15 | |
| | WLAN 2.4GHz | WLAN 6GHz + BT | 0.41 | |
| | WLAN 6GHz + BT | WLAN 2.4GHz | 0.38 | |
| | BT | WLAN 2.4GHz + 6GHz | 0.47 | |
| | - | WLAN 2.4GHz + 6GHz | 0.47 | |
| | WLAN 2.4GHz + 6GHz | - | 0.32 | |
| | WLAN 2.4GHz + 6GHz | WLAN 2.4GHz + 6GHz | 0.79 | |

Considering the results described above and according to the simultaneous transmission evaluation exclusions described in FCC OET KDB 447498 D01, no enlarged zoom scan measurements are required

Annex D. Test System Plots

| | |
|---|----|
| 1. U-NII-5 - 802.11ax, CH15, INPAQ Antenna, Main Transmitter – Bottom Edge (SAR) | 40 |
| 2. U-NII-6 - 802.11ax, CH111, INPAQ Antenna, Main Transmitter – Bottom Edge (SAR) | 41 |
| 3. U-NII-7 - 802.11ax, CH143, INPAQ Antenna, Aux Transmitter – Bottom Edge (SAR) | 42 |
| 4. U-NII-8 - 802.11ax, CH207, INPAQ Antenna, Main Transmitter – Bottom Edge (SAR) | 43 |
| 5. U-NII-5 - 802.11ax, CH15, INPAQ Antenna, Main Transmitter – Bottom Edge (PD)..... | 44 |
| 6. U-NII-6 - 802.11ax, CH111, INPAQ Antenna, Main Transmitter – Bottom Edge (PD)..... | 45 |
| 7. U-NII-7 - 802.11ax, CH143, INPAQ Antenna, Main Transmitter – Bottom Edge (PD)..... | 46 |
| 8. U-NII-8 - 802.11ax, CH207, INPAQ Antenna, Main Transmitter – Bottom Edge PD)..... | 47 |
| 9. Power Density System Check From 6500MHz..... | 48 |
| 10. SAR System Check 6500MHz – 2022-02-21 | 51 |

1. U-NII-5 - 802.11ax, CH15, INPAQ Antenna, Main Transmitter – Bottom Edge (SAR)

Device under Test Properties

| Model, Manufacturer | Dimensions [mm] | IMEI | DUT Type |
|---------------------|-----------------|------------|-------------|
| HP TPN-C155 | 300x200x17 | HPA4001385 | Convertible |

Exposure Conditions

| Phantom Section, TSL | Position, Test Distance [mm] | Band | Group, UID | Frequency [MHz], Channel Number | Conversion Factor | TSL Conductivity [S/m] | TSL Permittivity |
|----------------------|------------------------------|-------------|------------|---------------------------------|-------------------|------------------------|------------------|
| Flat, HSL | Bottom Edge 0.00 | Custom Band | CW, 0-- | 6025.0, 15 | 5.6 | 5.57 | 33.0 |

Hardware Setup

| Phantom | TSL, Measured Date | Probe, Calibration Date | DAE, Calibration Date |
|-----------------------------|------------------------------|-----------------------------|---------------------------|
| ELI V8.0 (20deg probe tilt) | HBBL-600-10000, 2022- Feb-21 | EX3DV4 - SN7465, 2021-07-23 | DAE4ip Sn1658, 2021-08-04 |

Scan Setup

| | Area Scan | Zoom Scan |
|---------------------|-------------------|--------------------|
| Grid Extents [mm] | 102.0 x 102.0 | 22.0 x 22.0 x 22.0 |
| Grid Steps [mm] | 8.5 x 8.5 | 3.4 x 3.4 x 1.4 |
| Sensor Surface [mm] | 3.0 | 1.4 |
| Graded Grid | Yes | Yes |
| Grading Ratio | 1.5 | 1.4 |
| MAIA | Confirmed by MAIA | Confirmed by MAIA |
| Surface Detection | VMS + 6p | VMS + 6p |
| Scan Method | Measured | Measured |

Measurement Results

| | Area Scan | Zoom Scan |
|---------------------|-------------------|-------------------|
| Date | 2022-02-21, 14:18 | 2022-02-21, 14:28 |
| psSAR1g [W/kg] | 0.266 | 0.311 |
| psSAR10g [W/kg] | 0.080 | 0.086 |
| Power Drift [dB] | 0.05 | -0.12 |
| Power Scaling | Disabled | Disabled |
| Scaling Factor [dB] | | |
| TSL Correction | Positive Only | Positive Only |
| M2/M1 [%] | | 56.1 |
| Dist3dBPeak[mm] | | 10.9 |

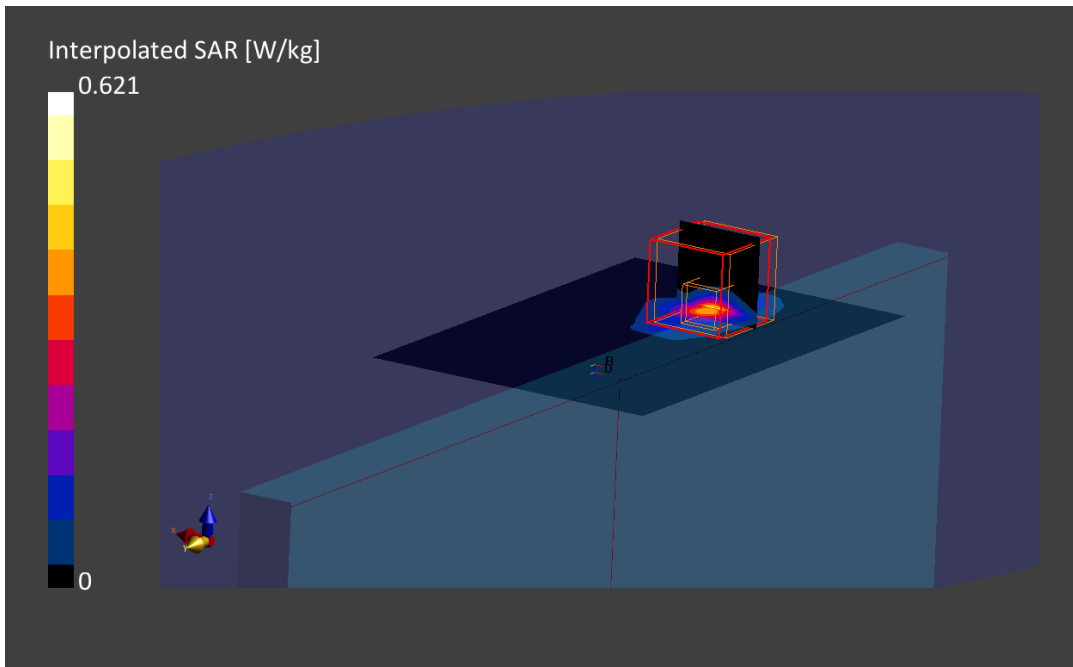

2. U-NII-6 - 802.11ax, CH111, INPAQ Antenna, Main Transmitter – Bottom Edge (SAR)

Device under Test Properties

| Model, Manufacturer | Dimensions [mm] | IMEI | DUT Type |
|---------------------|-----------------|------------|-------------|
| HP TPN-C155 | 300x200x17 | HPA4001385 | Convertible |

Exposure Conditions

| Phantom Section, TSL | Position, Test Distance [mm] | Band | Group, UID | Frequency [MHz], Channel Number | Conversion Factor | TSL Conductivity [S/m] | TSL Permittivity |
|----------------------|------------------------------|-------------|------------|---------------------------------|-------------------|------------------------|------------------|
| Flat, HSL | Bottom Edge 0.00 | Custom Band | CW, 0-- | 6505.0, 6505000 | 5.6 | 6.20 | 32.3 |

Hardware Setup

| Phantom | TSL, Measured Date | Probe, Calibration Date | DAE, Calibration Date |
|-----------------------------|-------------------------------|-----------------------------|---------------------------|
| ELI V8.0 (20deg probe tilt) | HBBL-600-10000 , 2022- Feb-21 | EX3DV4 - SN7465, 2021-07-23 | DAE4ip Sn1658, 2021-08-04 |

Scan Setup

| | Area Scan | Zoom Scan |
|---------------------|-------------------|--------------------|
| Grid Extents [mm] | 102.0 x 102.0 | 22.0 x 22.0 x 22.0 |
| Grid Steps [mm] | 8.5 x 8.5 | 3.4 x 3.4 x 1.4 |
| Sensor Surface [mm] | 3.0 | 1.4 |
| Graded Grid | Yes | Yes |
| Grading Ratio | 1.5 | 1.4 |
| MAIA | Confirmed by MAIA | Confirmed by MAIA |
| Surface Detection | VMS + 6p | VMS + 6p |
| Scan Method | Measured | Measured |

Measurement Results

| | Area Scan | Zoom Scan |
|---------------------|-------------------|-------------------|
| Date | 2022-02-21, 14:52 | 2022-02-21, 15:05 |
| psSAR1g [W/kg] | 0.190 | 0.215 |
| psSAR10g [W/kg] | 0.064 | 0.062 |
| Power Drift [dB] | -0.06 | 0.10 |
| Power Scaling | Disabled | Disabled |
| Scaling Factor [dB] | | |
| TSL Correction | Positive Only | Positive Only |
| M2/M1 [%] | | 51.5 |
| Dist3dBPeak[mm] | | 9.9 |

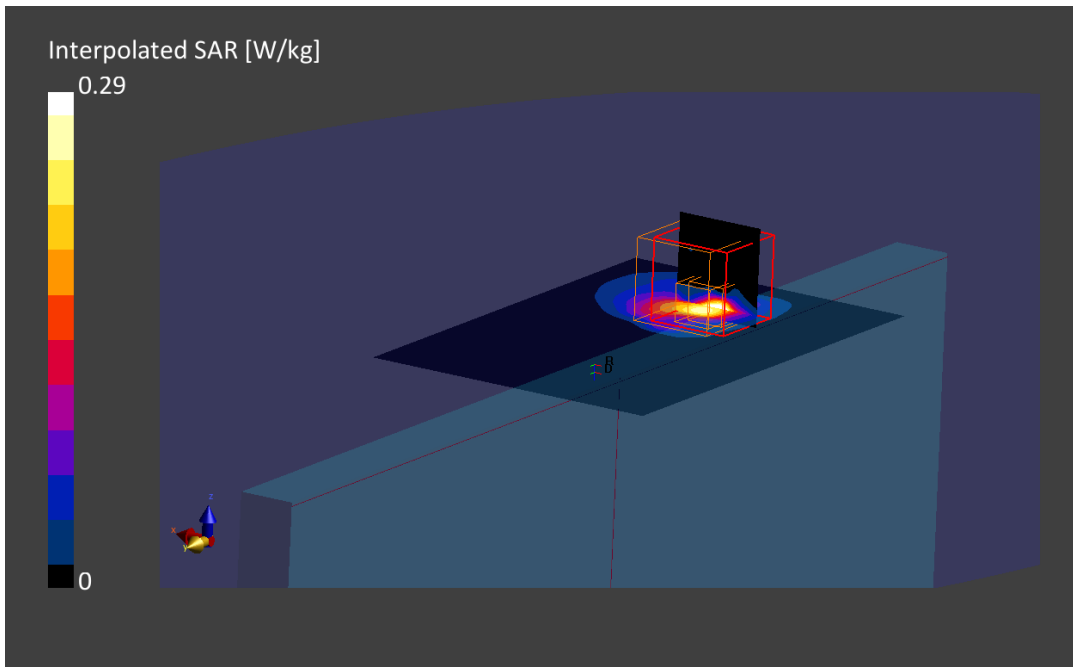

3. U-NII-7 - 802.11ax, CH143, INPAQ Antenna, Aux Transmitter – Bottom Edge (SAR)

Device under Test Properties

| Model, Manufacturer | Dimensions [mm] | IMEI | DUT Type |
|---------------------|-----------------|------------|-------------|
| HP TPN-C155 | 300x200x17 | HPA4001385 | Convertible |

Exposure Conditions

| Phantom Section, TSL | Position, Test Distance [mm] | Band | Group, UID | Frequency [MHz], Channel Number | Conversion Factor | TSL Conductivity [S/m] | TSL Permittivity |
|----------------------|------------------------------|-------------|------------|---------------------------------|-------------------|------------------------|------------------|
| Flat, HSL | Bottom Edge 0.00 | Custom Band | CW, 0-- | 6665.0, 143 | 5.6 | 6.42 | 31.9 |

Hardware Setup

| Phantom | TSL, Measured Date | Probe, Calibration Date | DAE, Calibration Date |
|-----------------------------|------------------------------|-----------------------------|---------------------------|
| ELI V8.0 (20deg probe tilt) | HBBL-600-10000, 2022- Feb-21 | EX3DV4 - SN7465, 2021-07-23 | DAE4ip Sn1658, 2021-08-04 |

Scan Setup

| | Area Scan | Zoom Scan |
|---------------------|-------------------|--------------------|
| Grid Extents [mm] | 102.0 x 102.0 | 22.0 x 22.0 x 22.0 |
| Grid Steps [mm] | 8.5 x 8.5 | 3.4 x 3.4 x 1.4 |
| Sensor Surface [mm] | 3.0 | 1.4 |
| Graded Grid | Yes | Yes |
| Grading Ratio | 1.5 | 1.4 |
| MAIA | Confirmed by MAIA | Confirmed by MAIA |
| Surface Detection | VMS + 6p | VMS + 6p |
| Scan Method | Measured | Measured |

Measurement Results

| | Area Scan | Zoom Scan |
|---------------------|-------------------|-------------------|
| Date | 2022-02-21, 13:39 | 2022-02-21, 13:49 |
| psSAR1g [W/kg] | 0.171 | 0.201 |
| psSAR10g [W/kg] | 0.044 | 0.048 |
| Power Drift [dB] | 0.19 | -0.14 |
| Power Scaling | Disabled | Disabled |
| Scaling Factor [dB] | | |
| TSL Correction | Positive Only | Positive Only |
| M2/M1 [%] | | 54.9 |
| Dist3dBPeak[mm] | | 10.2 |

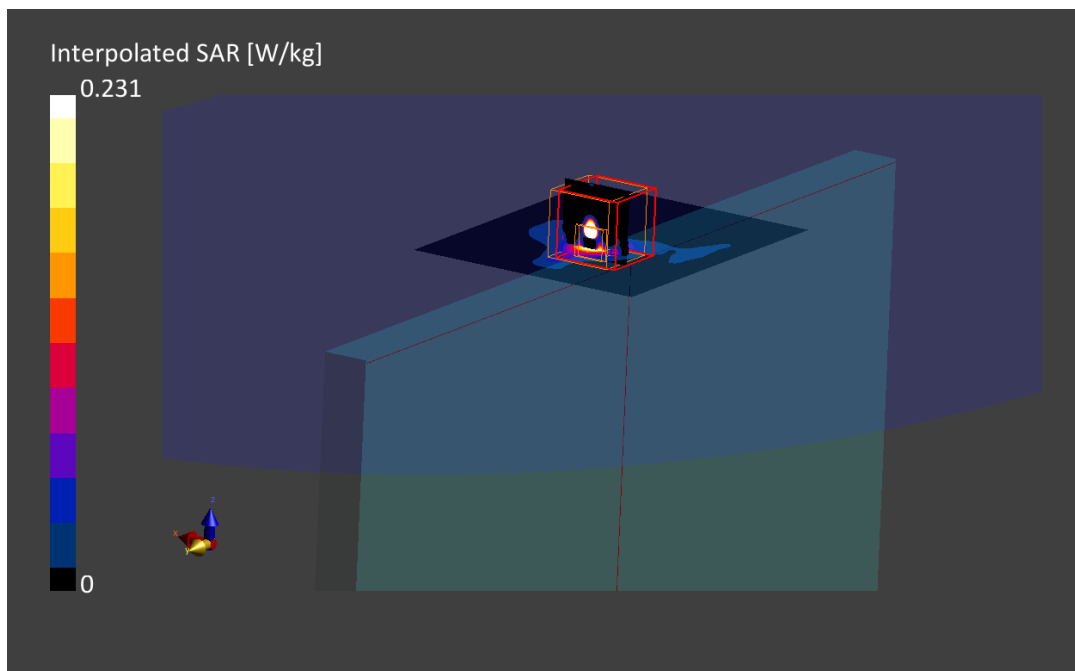

4. U-NII-8 - 802.11ax, CH207, INPAQ Antenna, Main Transmitter – Bottom Edge (SAR)

Device under Test Properties

| Model, Manufacturer | Dimensions [mm] | IMEI | DUT Type |
|---------------------|-----------------|------------|-------------|
| HP TPN-C155 | 300x200x17 | HPA4001385 | Convertible |

Exposure Conditions

| Phantom Section, TSL | Position, Test Distance [mm] | Band | Group, UID | Frequency [MHz], Channel Number | Conversion Factor | TSL Conductivity [S/m] | TSL Permittivity |
|----------------------|------------------------------|-------------|------------|---------------------------------|-------------------|------------------------|------------------|
| Flat, HSL | Bottom Edge 0.00 | Custom Band | CW, 0-- | 6985.0, 207 | 5.6 | 6.72 | 31.6 |

Hardware Setup

| Phantom | TSL, Measured Date | Probe, Calibration Date | DAE, Calibration Date |
|-----------------------------|------------------------------|-----------------------------|---------------------------|
| ELI V8.0 (20deg probe tilt) | HBBL-600-10000, 2022- Feb-21 | EX3DV4 - SN7465, 2021-07-23 | DAE4ip Sn1658, 2021-08-04 |

Scan Setup

| | Area Scan | Zoom Scan |
|---------------------|-------------------|--------------------|
| Grid Extents [mm] | 102.0 x 102.0 | 22.0 x 22.0 x 22.0 |
| Grid Steps [mm] | 8.5 x 8.5 | 3.4 x 3.4 x 1.4 |
| Sensor Surface [mm] | 3.0 | 1.4 |
| Graded Grid | Yes | Yes |
| Grading Ratio | 1.5 | 1.4 |
| MAIA | Confirmed by MAIA | Confirmed by MAIA |
| Surface Detection | VMS + 6p | VMS + 6p |
| Scan Method | Measured | Measured |

Measurement Results

| | Area Scan | Zoom Scan |
|------------------|-------------------|-------------------|
| Date | 2022-02-21, 15:28 | 2022-02-21, 15:39 |
| psSAR1g [W/kg] | 0.188 | 0.198 |
| psSAR10g [W/kg] | 0.066 | 0.057 |
| Power Drift [dB] | -0.16 | 0.05 |
| Power Scaling | Disabled | Disabled |
| Scaling Factor | | |
| TSL Correction | Positive Only | Positive Only |
| M2/M1 [%] | | 48.3 |
| Dist3dBPeak[mm] | | 8.9 |

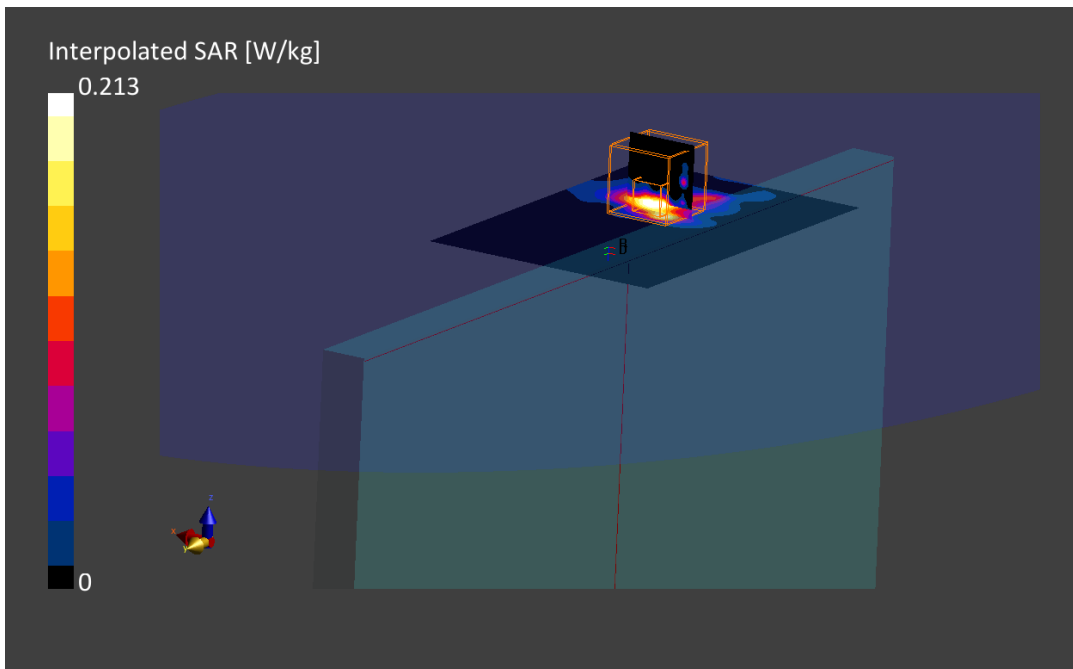

5. U-NII-5 - 802.11ax, CH15, INPAQ Antenna, Main Transmitter – Bottom Edge (PD)

DUT: HP TPN-C155+ AX411NGW Module; Type: INPAQ, DC33002K3C0 (WA-P-LBLB-02-130)

Signal Source: modulation Custom Channel for 802.11ax, level 13.50 dBm.

Medium parameters used: $\sigma = 0$ S/m, $\epsilon_r = 1$; $\rho = 0$ kg/m³

Phantom section: Table Section

Measurement Standard: DASY6 (IEEE/IEC/ANSI C63.19-2011)

DASY Configuration:

- Probe: EUmmW - SN9366; ConvF(1, 1, 1); Calibrated: 2021-05-2;
 - Modulation Compensation:
- Sensor-Surface : 0mm (Fix Surface), z = 2.5 mm
- Electronics: DAE4 Sn1658; Calibrated: 2021-08-04;
- Phantom: Cover; Type: SPEAG Phantom Cover;
- cDASY6 5G Module v2.4.0.55
- Test Date: 2022-02-22

Distance-2.5mm:

Measurement Resolution = $\lambda/16$ mm

Measurement Scan area = 120 mm x 120 mm

The plots below show the average PStot (1cm²), PStot (4cm²) the E-field and the H Field

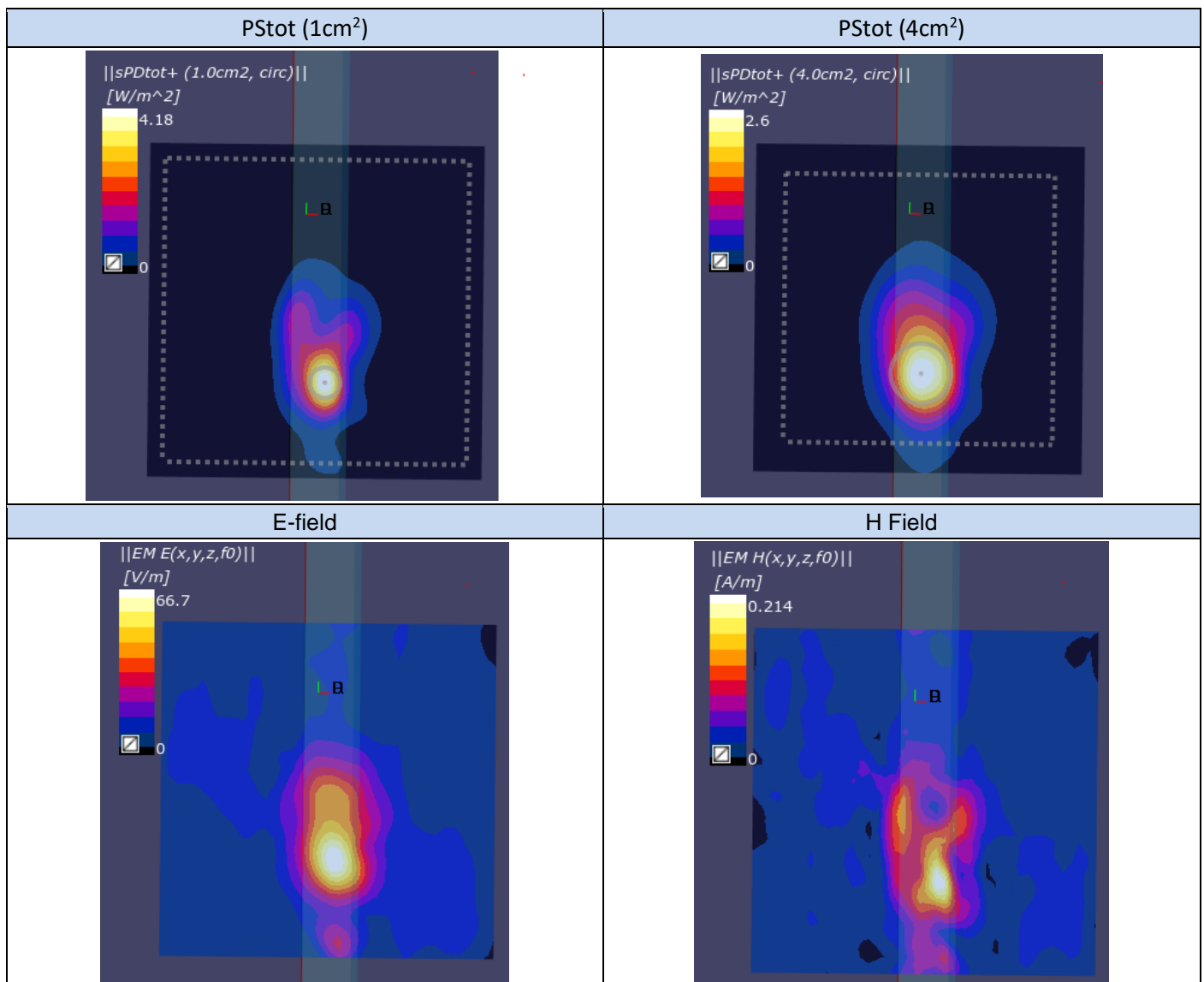

6. U-NII-6 - 802.11ax, CH111, INPAQ Antenna, Main Transmitter – Bottom Edge (PD)

DUT: HP TPN-C155+ AX411NGW Module; Type: INPAQ, DC33002K3C0 (WA-P-LBLB-02-130)
Signal Source: modulation Custom Channel for 802.11ax, level 13.50 dBm.

Medium parameters used: $\sigma = 0$ S/m, $\epsilon_r = 1$; $\rho = 0$ kg/m³
 Phantom section: Table Section
 Measurement Standard: DASY6 (IEEE/IEC/ANSI C63.19-2011)

DASY Configuration:

- Probe: EUmmW - SN9366; ConvF(1, 1, 1); Calibrated: 2021-05-20;
 - Modulation Compensation:
- Sensor-Surface : 0mm (Fix Surface), z = 2.5 mm
- Electronics: DAE4 Sn1658; Calibrated: 2021-08-04;
- Phantom: Cover; Type: SPEAG Phantom Cover;
- cDASY6 5G Module v2.4.0.55
- Test Date: 2022-02-23

Distance-2.5mm:

Measurement Resolution = $\lambda/16$ mm

Measurement Scan area = 120 mm x 120 mm

The plots below show the average PStot (1cm²), PStot (4cm²) the E-field and the H Field

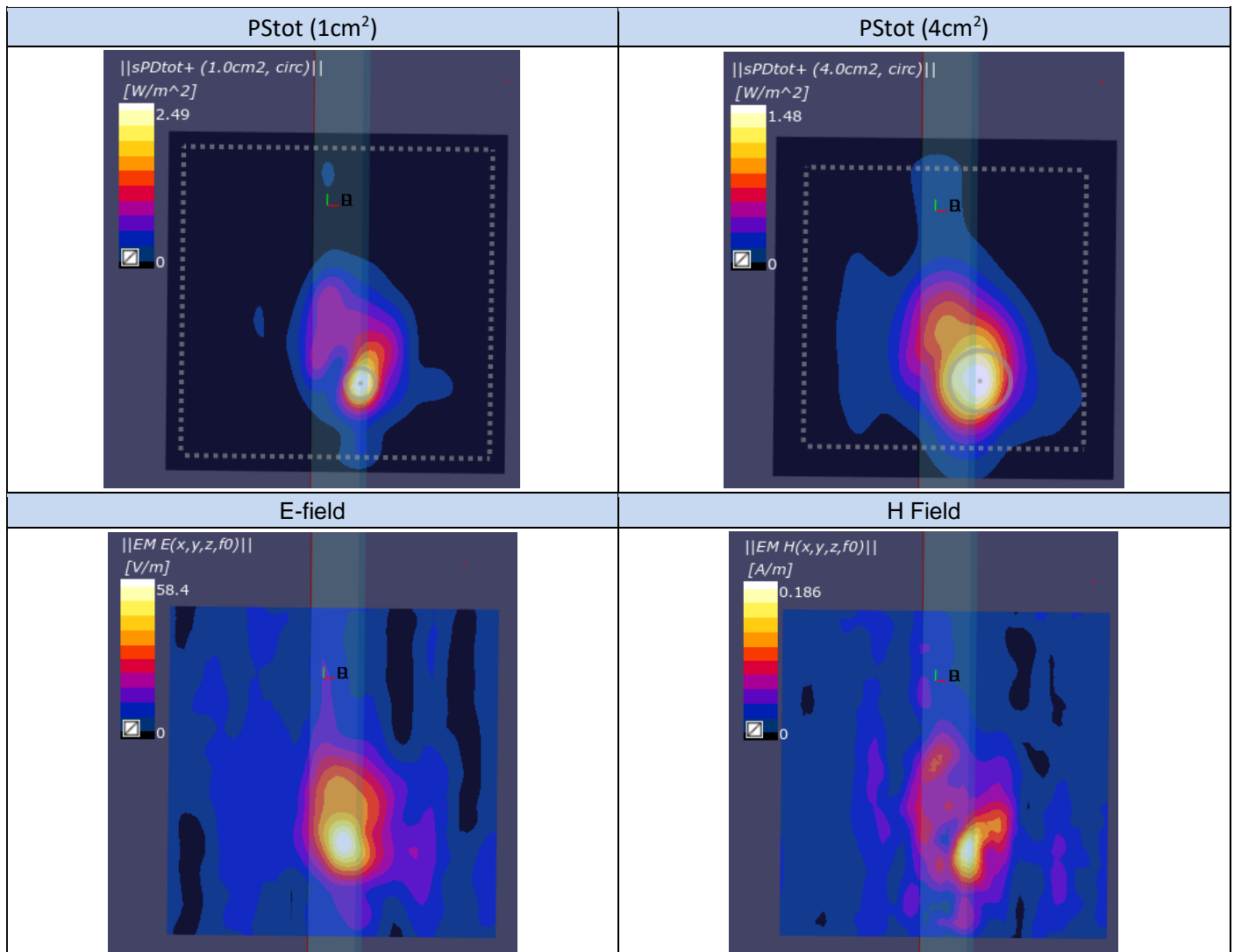

7. U-NII-7 - 802.11ax, CH143, INPAQ Antenna, Main Transmitter – Bottom Edge (PD)

DUT: HP TPN-C155+ AX411NGW Module; Type: INPAQ, DC33002K3C0 (WA-P-LBLB-02-130)

Signal Source: modulation Custom Channel for 802.11ax, level 12.75 dBm.

Medium parameters used: $\sigma = 0$ S/m, $\epsilon_r = 1$; $\rho = 0$ kg/m³

Phantom section: Table Section

Measurement Standard: DASy6 (IEEE/IEC/ANSI C63.19-2011)

DASY Configuration:

- Probe: EUmmW - SN9366; ConvF(1, 1, 1); Calibrated: 2021-05-20;
 - Modulation Compensation:
- Sensor-Surface : 0mm (Fix Surface), z = 2.5 mm
- Electronics: DAE4 Sn1658; Calibrated: 2021-08-04;
- Phantom: Cover; Type: SPEAG Phantom Cover;
- cDASY6 5G Module v2.4.0.55
- Test Date: 2022-02-23

Distance-2.5mm:

Measurement Resolution = $\lambda/16$ mm

Measurement Scan area = 120 mm x 120 mm

The plots below show the average PStot (1cm²), PStot (4cm²) the E-field and the H Field

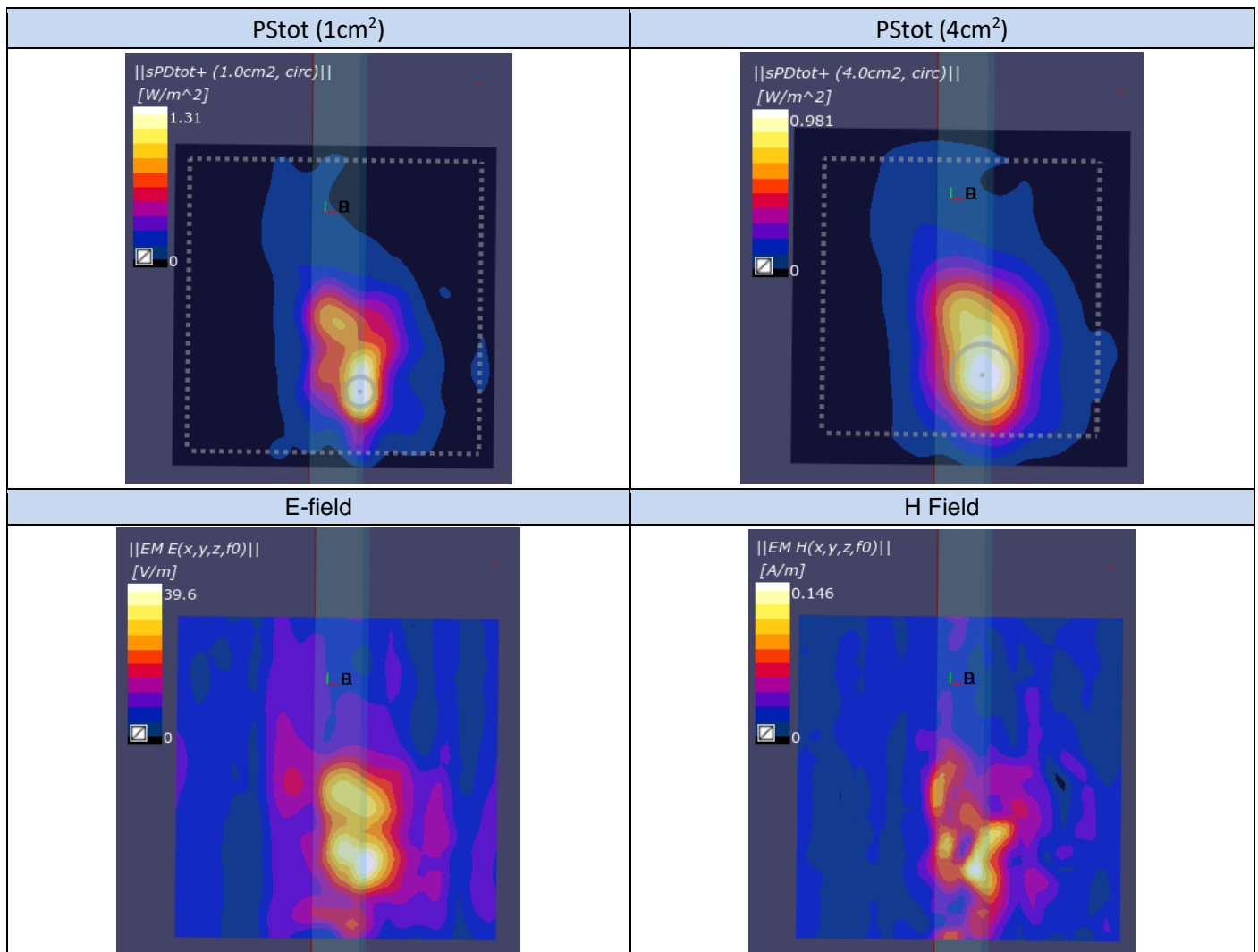

8. U-NII-8 - 802.11ax, CH207, INPAQ Antenna, Main Transmitter – Bottom Edge PD)

DUT: HP TPN-C155+ AX411NGW Module; **Type:** INPAQ, DC33002K3C0 (WA-P-LBLB-02-130)

Signal Source: modulation Custom Channel for 802.11ax, level 12.75 dBm.

Medium parameters used: $\sigma = 0$ S/m, $\epsilon_r = 1$; $\rho = 0$ kg/m³

Phantom section: Table Section

Measurement Standard: DASY6 (IEEE/IEC/ANSI C63.19-2011)

DASY Configuration:

- Probe: EUmmW - SN9366; ConvF(1, 1, 1); Calibrated: 2021-05-20;
 - Modulation Compensation:
- Sensor-Surface : 0mm (Fix Surface), z = 2.5 mm
- Electronics: DAE4 Sn1658; Calibrated: 2021-08-04;
- Phantom: Cover; Type: SPEAG Phantom Cover;
- cDASY6 5G Module v2.4.0.55
- Test Date: 2022-02-23

Distance-2.5mm:

Measurement Resolution = $\lambda/16$ mm

Measurement Scan area = 120 mm x 120 mm

The plots below show the average PStot (1cm²), PStot (4cm²) the E-field and the H Field

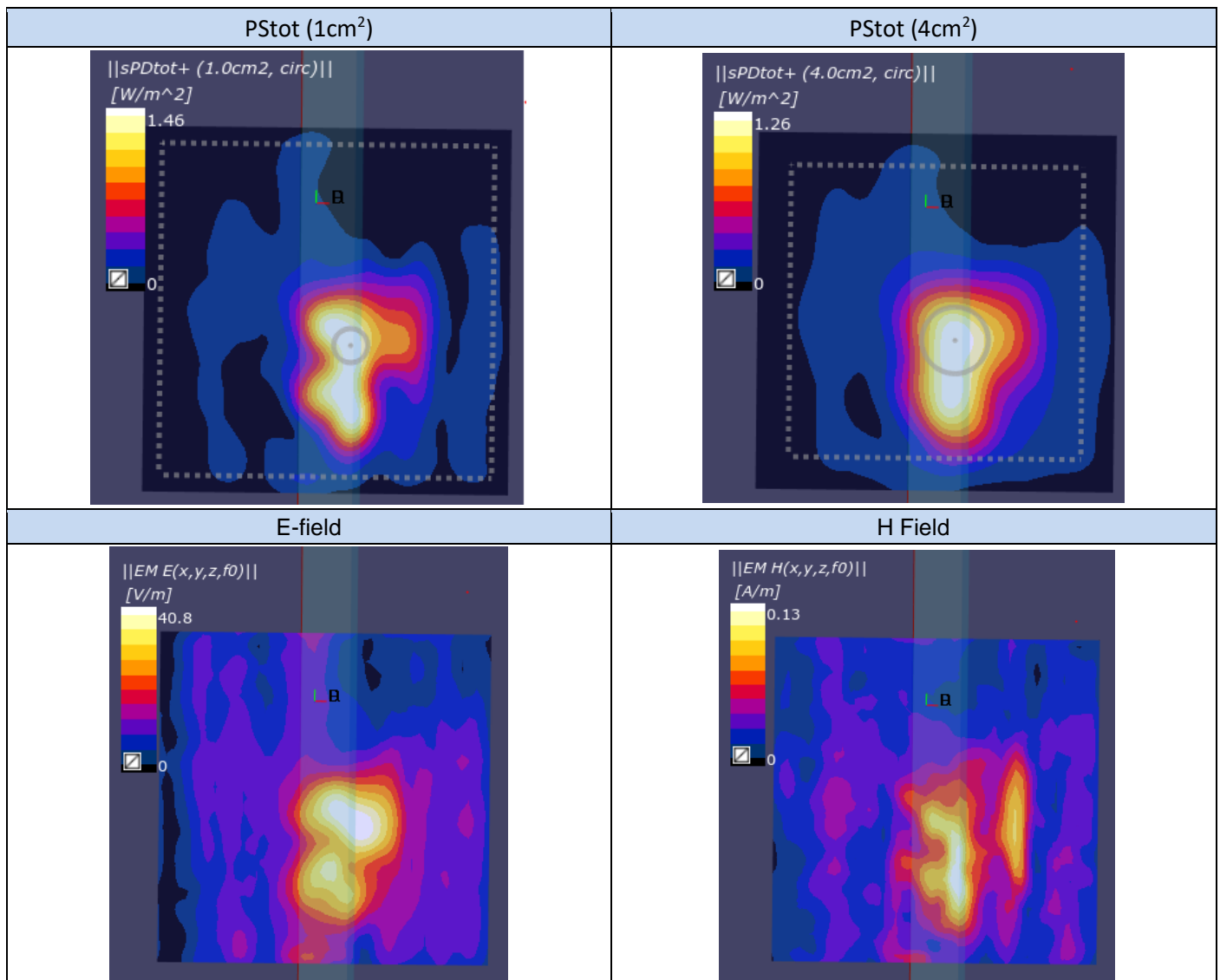

9. Power Density System Check From 6500MHz

DUT: Horn reference source; Type: PE9859/SF-15;

Signal Source: modulation CW, level 10 dBm.

Medium parameters used: $\sigma = 0$ S/m, $\epsilon_r = 1$; $\rho = 0$ kg/m³

Phantom section: Table Section

Measurement Standard: DASYS6 (IEEE/IEC/ANSI C63.19-2011)

DASY Configuration:

- Probe: EUmmW - SN9366; ConvF(1, 1, 1); Calibrated: 2021-05-20;
 - Modulation Compensation:
- Sensor-Surface : 0mm (Fix Surface), z = 10 mm
- Electronics: DAE4 Sn1658; Calibrated: 2021-08-04;
- Phantom: Cover; Type: SPEAG Phantom Cover;
- cDASY6 5G Module v2.4.0.55;
- Test Date: 2022-02-23

Distance-10mm/Measure Horn reference source (86.9x63.5):

Measurement Resolution = $\lambda/4$ mm

Measurement Scan area = 200 mm x 200 mm

The plots below show the comparison between the Numerical Modeling results and the system check measurement results in terms of E-field, H Field, single point power density and Avg Power density 1cm².

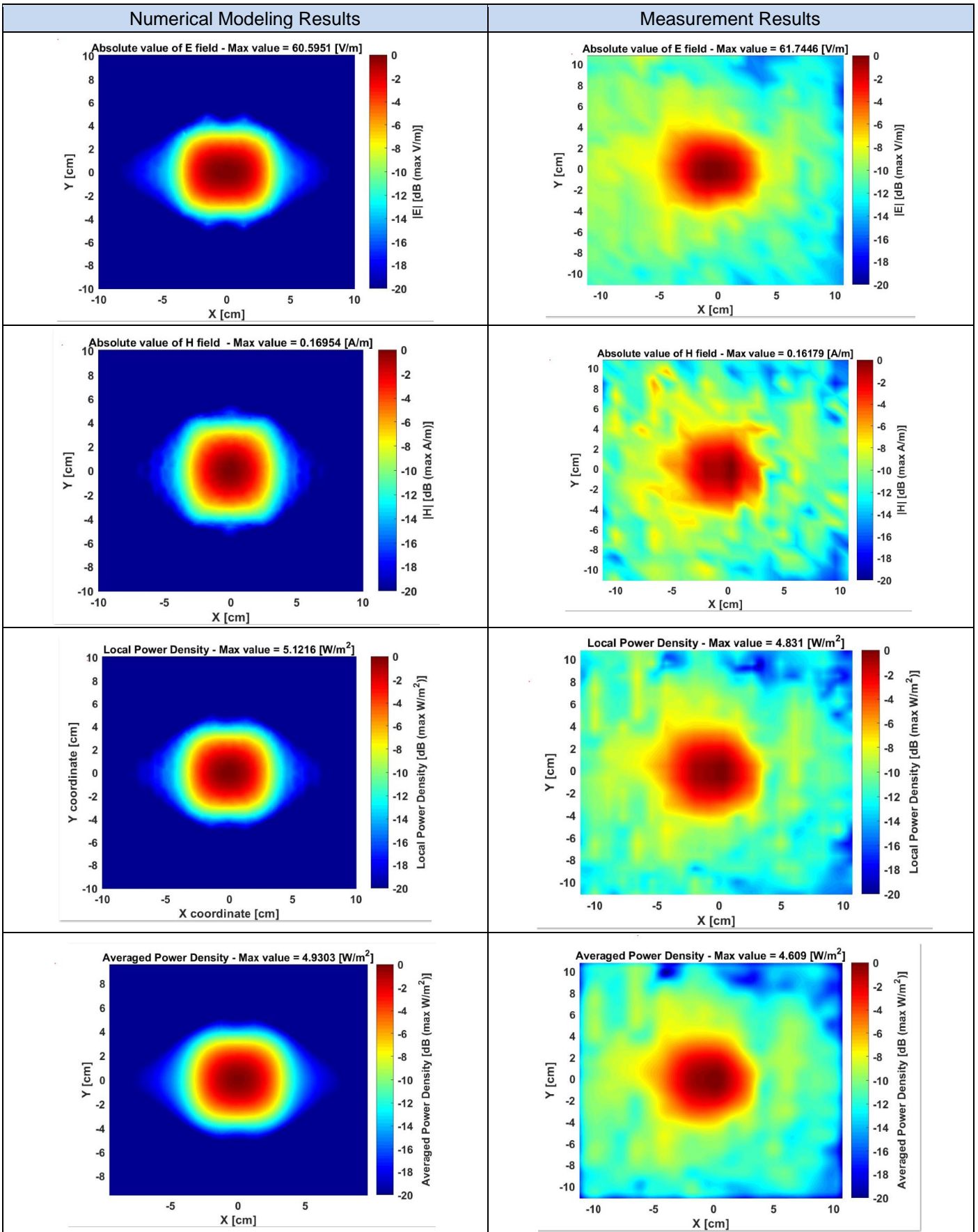

The plots below show the comparison between the numerical modeling and the system check results in terms of normalized E-field distribution and the 1D variation along the two axis of the maximum.

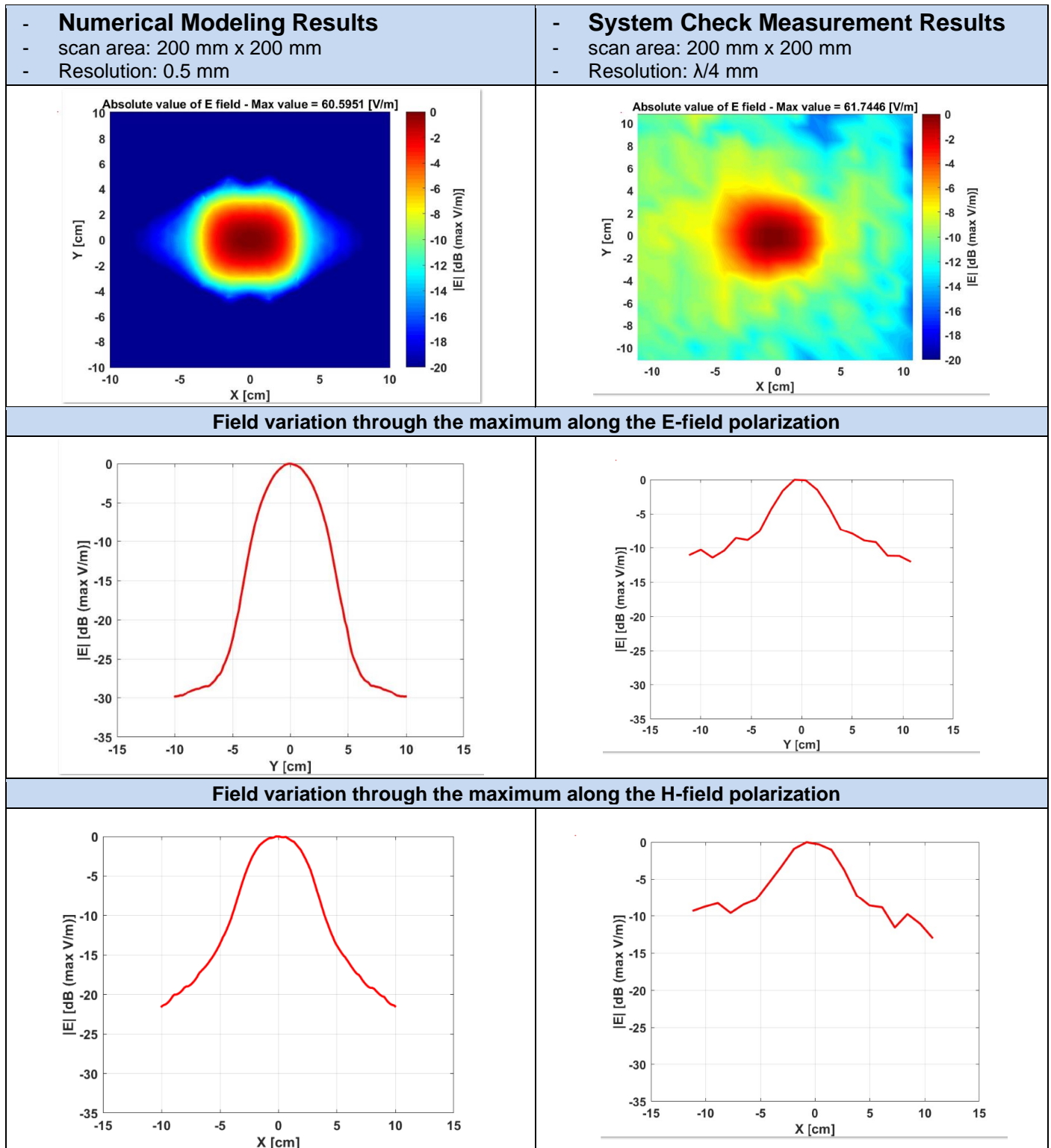

10. SAR System Check 6500MHz – 2022-02-21

Device under Test Properties

| Name, Manufacturer | Dimensions [mm] | IMEI | DUT Type |
|--------------------|--------------------|------|-------------------|
| D6.5GHzV2, Speag | 50.0 x 10.0 x 20.0 | 1013 | Validation Dipole |

Exposure Conditions

| Phantom Section, TSL | Position, Test Distance [mm] | Band | Group, UID | Frequency [MHz], Channel Number | Conversion Factor | TSL Conductivity [S/m] | TSL Permittivity |
|----------------------|------------------------------|------|------------|---------------------------------|-------------------|------------------------|------------------|
| Flat, HSL | Laptop, 0.00 | | , 0-- | 6500.0, 0 | 5.6 | 6.19 | 32.3 |

Hardware Setup

| Phantom | TSL, Measured Date | Probe, Calibration Date | DAE, Calibration Date |
|-----------------------------|------------------------|-----------------------------|---------------------------|
| ELI V8.0 (20deg probe tilt) | HBBL-600-10000, Feb-21 | EX3DV4 - SN7465, 2021-07-23 | DAE4ip Sn1658, 2021-08-04 |

Scan Setup

| | Area Scan | Zoom Scan |
|---------------------|-------------|--------------------|
| Grid Extents [mm] | 51.0 x 85.0 | 22.0 x 22.0 x 22.0 |
| Grid Steps [mm] | 8.5 x 8.5 | 3.4 x 3.4 x 1.4 |
| Sensor Surface [mm] | 3.0 | 1.4 |
| Graded Grid | Yes | Yes |
| Grading Ratio | 1.5 | 1.4 |
| MAIA | N/A | N/A |
| Surface Detection | VMS + 6p | VMS + 6p |
| Scan Method | Measured | Measured |

Measurement Results

| | Area Scan | Zoom Scan |
|---------------------|-------------------|-------------------|
| Date | 2022-02-21, 15:48 | 2022-02-21, 15:56 |
| psSAR1g [W/kg] | 6.29 | 6.73 |
| psSAR10g [W/kg] | 1.21 | 1.27 |
| Power Drift [dB] | -0.05 | -0.09 |
| Power Scaling | Disabled | Disabled |
| Scaling Factor [dB] | | |
| TSL Correction | Positive Only | Positive Only |
| M2/M1 [%] | | 51.2 |
| Dist3dBPeak[mm] | | 4.8 |

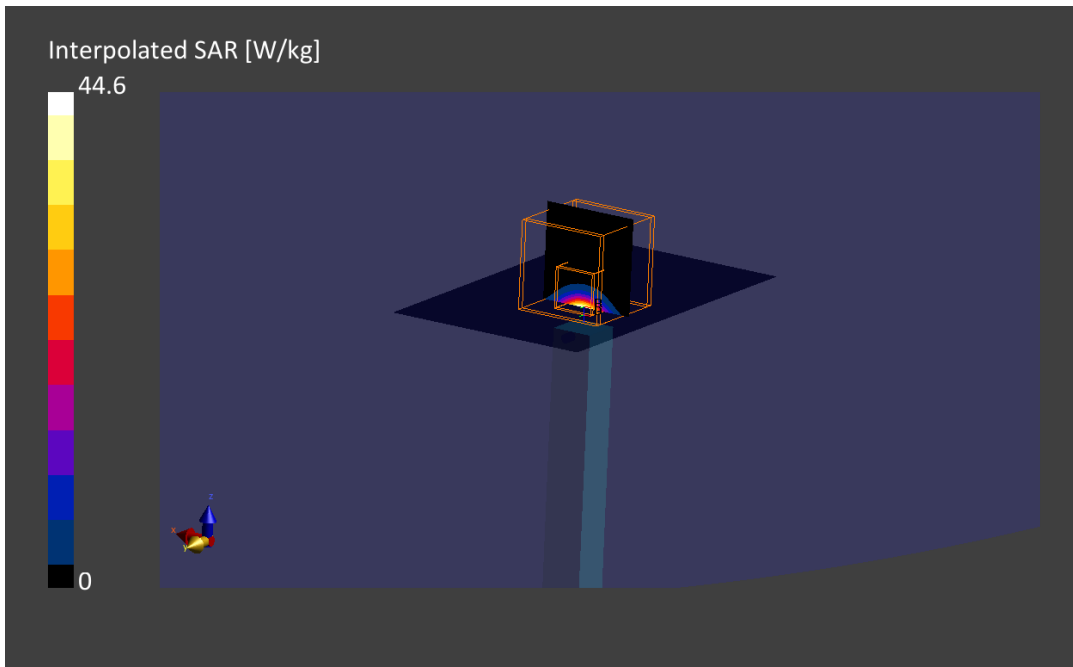

TSL Dielectric Parameters

D.1 Head Liquid WiFi 6E

| | | | 2022-02-21 | |
|------------|-------------------|----------------|--------------------|-----------------|
| Freq.(MHz) | Target | | Measured | |
| | ϵ' (F/m) | σ (S/m) | $\epsilon'1$ (F/m) | $\sigma1$ (S/m) |
| 6000.0 | 35.07 | 5.48 | 33.01 | 5.55 |
| 6050.0 | 35.01 | 5.54 | 32.97 | 5.60 |
| 6100.0 | 34.95 | 5.59 | 32.94 | 5.66 |
| 6150.0 | 34.89 | 5.65 | 32.93 | 5.72 |
| 6200.0 | 34.83 | 5.71 | 32.93 | 5.78 |
| 6250.0 | 34.77 | 5.77 | 32.93 | 5.84 |
| 6300.0 | 34.70 | 5.83 | 32.91 | 5.91 |
| 6350.0 | 34.64 | 5.89 | 32.83 | 5.99 |
| 6400.0 | 34.58 | 5.95 | 32.72 | 6.06 |
| 6450.0 | 34.52 | 6.01 | 32.54 | 6.13 |
| 6500.0 | 34.46 | 6.07 | 32.35 | 6.19 |
| 6550.0 | 34.40 | 6.13 | 32.17 | 6.26 |
| 6600.0 | 34.34 | 6.19 | 32.03 | 6.33 |
| 6650.0 | 34.29 | 6.25 | 31.92 | 6.40 |
| 6700.0 | 34.23 | 6.30 | 31.86 | 6.47 |
| 6750.0 | 34.17 | 6.36 | 31.82 | 6.54 |
| 6800.0 | 34.11 | 6.42 | 31.80 | 6.59 |
| 6850.0 | 34.05 | 6.48 | 31.75 | 6.62 |
| 6900.0 | 33.99 | 6.53 | 31.69 | 6.65 |
| 6950.0 | 33.94 | 6.59 | 31.61 | 6.68 |
| 7000.0 | 33.88 | 6.65 | 31.52 | 6.74 |

