

Regulatory WLAN Antenna Information (Template)

English Language Required for Intel Regulatory Review / Approval

(OEM/ODM or antenna vendor is required to complete this document with platform antenna information.

Remove Intel references and make this your own document)

Platform information										
Brand	ODM	****End product model name	Intel platform (ex: Yes, No or NA)	Platform type (ex: regular NB, convertible PC, AIO...etc)	*SAR minimum separation (mm)					
DELL	Wistron	P125F	YES	Regular NB	2.03					
****Please fill in exact product model name and make sure the model name is visible on product cover or any parts for end users recognize for authority inspection.										
Antenna information										
Vendor	Type			Antenna Part number (Main)	Antenna Part number (Aux)					
Advanced Wireless & Antenna INC.	PIFA			Antenna P/N: AYF6Y-100214 Wistron P/N: 025.9025N.0011	Antenna P/N: AYF6Y-100215 Wistron P/N: 025.9025O.0011					
Peak gain w/ cable loss (dBi)*										
	2.4GHz 2400-2483.5 MHz	5.2GHz 5150-5250MHz	5.3GHz 5250-5350MHz	5.6GHz 5470-5725MHz	5.8GHz 5725-5850MHz	6.2GHz 5925-6425MHz	6.5GHz 6425-6525MHz	6.7GHz 6525-6875MHz	7.0 GHz 6875-7125MHz	
Main	1.86	2.83	2.98	3.99	4.09	4.64	3.48	4.43	4.08	
Aux	1.37	3.00	3.00	3.86	4.15	4.55	4.04	4.22	1.87	
Intel Reference Gain/Type/ Separation distance										
Antenna Type	Antenna Peak gain (In dBi)*									Distance to the end user (mm)
	2.4GHz 2400-2483.5 MHz	5.2GHz 5150-5250MHz	5.3GHz 5250-5350MHz	5.6GHz 5470-5725MHz	5.8GHz 5725-5850MHz	6.2GHz 5925-6425MHz	6.5GHz 6425-6525MHz	6.7GHz 6525-6875MHz	7.0GHz 6875-7125MHz	
Design	3.00	5.00	5.00	5.00	5.00	5.00	5.00	5.00	5.00	Generic: refer to modular FCC SAR report Mid-power: ≥ 8 mm Low power: ≥ 5 mm
PIFA	3.24	3.64	3.73	4.77	4.97	4.83	4.30	5.37	5.59	
Dipole	2.89	2.92	3.19	4.41	4.22	4.83	4.30	4.49	5.34	
Notes (marked with *)										
* SAR minimum separation (mm)										
- Regular NB: Minimum antenna-to-body (from antenna bottom to the bottom of the device)										
- Tablet / Convertible PC: Minimum antenna-to-edge (5 sides of the device)										
- Mini-tablet: Minimum antenna-to-edge (6 sides of the device)										
* 3D Peak Antenna gain should be equal or greater than -2 dBi										
- If a host integrator plans to use a lower gain antenna of the same type, additional CBP(FCC)/EDT(EU) testing need to be performed while the module is installed in the host.										

Table of contents

1. Applicable test method
2. Test & System Description
 - a. Test setup
 - b. Equipment list
3. Setup photo

[Section 1. Antenna Assembly Specifications](#)

[Section 2. Dimensioned Photos or Drawings of Antennas](#)

[Section 3. Radiation characteristics of antenna loaded in Host Platform](#)

[Section 4. Antenna Host Platform Location Information](#)

[Section 5. Antenna dimensional information for SAR evaluation](#)

[Section 6. Diagram Example of Co-Location Antenna Separation](#)

1. **Applicable test methods**

<insert test description here for test method>

This test report is prepared for host antenna testing under a Full Anechoic Chamber.

2. **Test & System Description**

a. Test setup

<insert test diagram here for test site utilized>

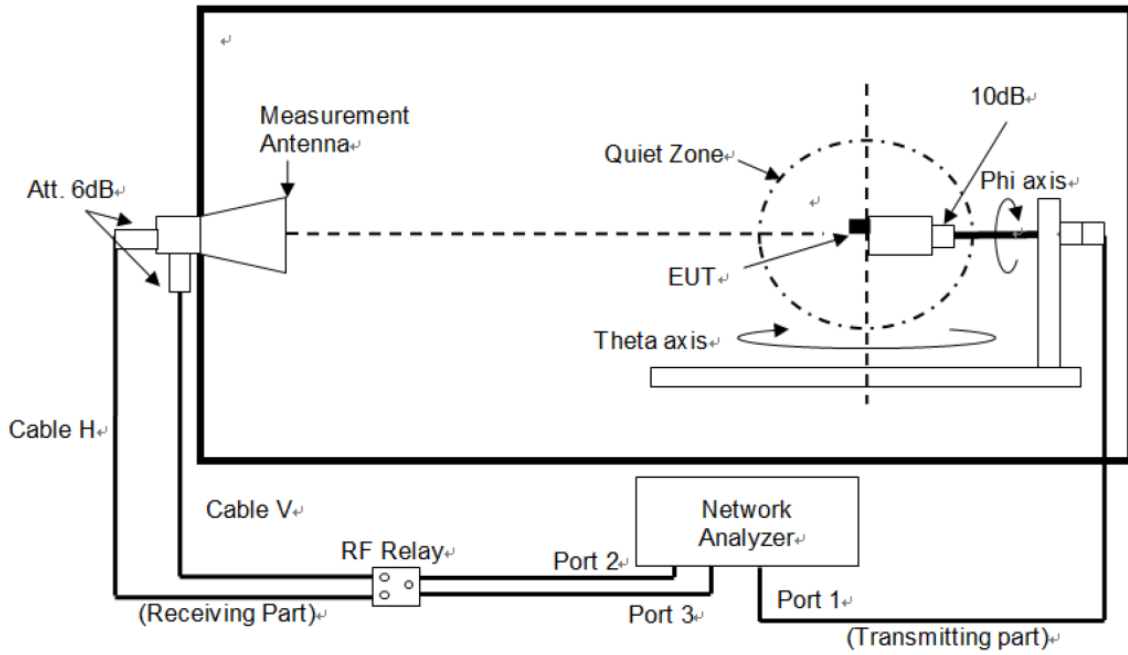

b. Equipment list

<insert test diagram here for test site utilized>

Name	Manufacturer	Type/Model	Serial Number	Calibration	
				Last Cal.	Due Date
ENA Series Network Analyzer	Keysight	E5071C	MY46900218	2021/8/4	2022/8/3
RF Switch	N/A	N/A	N/A	NCR	NCR
Multi-Axis Positioner Controller	ETS-Lindgren	2090	N/A	NCR	NCR
Medium-Duty Positioner	ETS-Lindgren	2110	N/A	NCR	NCR
Measurement Horn Antenna	EMCO	Aug-64	N/A	NCR	NCR

Antenna Information

Section 1. Antenna Assembly Specifications

1A Antenna Part Number	1B Manufacturer	1C Antenna Type	1D Cable Assembly Part Number and Information	Freq Range MHz	1E * Peak Gain W/ Cable loss (dBi)	1F Peak Gain w/o Cable Loss (dBi)	1G Max VSWR	1H Cable Loss (dB)
Main Antenna Wistron P/N 025.9025N.0011 AWAN P/N AYF6Y-100214	Advanced Wireless & Antenna INC.	PIFA	50 ohm Coaxial length:285mm Diameter: 1.13mm Connector : IPEX	2400-2483.5	1.86	2.51	2.5	0.65
				5150-5250	2.83	3.81	2.5	0.98
				5250-5350	2.98	3.98	2.5	1
				5470-5725	3.99	5.02	2.5	1.03
				5725-5850	4.09	5.14	2.5	1.05
				5925-6425	4.64	5.73	2.5	1.09
				6425-6525	3.48	4.58	2.5	1.1
				6525-6875	4.43	5.57	2.5	1.14
				6875-7125	4.08	5.23	2.5	1.15
Aux Antenna Wistron P/N 025.9025O.0011 AWAN P/N AYF6Y-100215	Advanced Wireless & Antenna INC.	PIFA	50 ohm Coaxial length: 280mm Diameter: 1.13mm Connector : IPEX	2400-2483.5	1.37	2.01	2.5	0.64
				5150-5250	3.00	3.97	2.5	0.97
				5250-5350	3.00	3.99	2.5	0.99
				5470-5725	3.86	4.87	2.5	1.01
				5725-5850	4.15	5.18	2.5	1.03
				5925-6425	4.55	5.62	2.5	1.07
				6425-6525	4.04	5.12	2.5	1.08
				6525-6875	4.22	5.34	2.5	1.12
				6875-7125	1.87	3	2.5	1.13

- 3D Antenna Peak Gain required being test in system basis.

Section 3. Radiation characteristics of antenna loaded in Host Platform

Main Antenna

Max Antenna 3D Radiation Pattern 2400 – 2483.5 MHz

Frequency (MHz)	Peak Gain w/ Cable Loss (dBi)
2400-2483.5	1.86

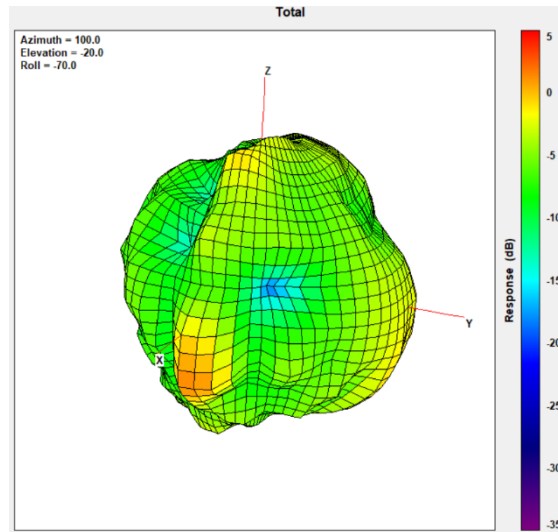

Max Antenna 3D Radiation Pattern 5150-5250 MHz

Frequency (MHz)	Peak Gain w/ Cable Loss (dBi)
5150-5250	2.83

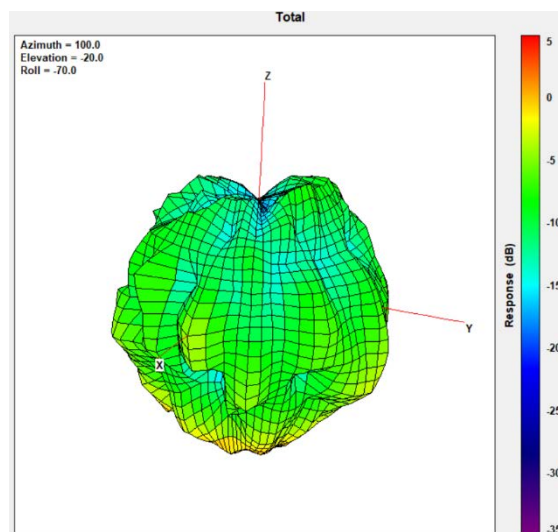

Max Antenna 3D Radiation Pattern 5250-5350 MHz

Frequency (MHz)	Peak Gain w/ Cable Loss (dBi)
5250-5350	2.98

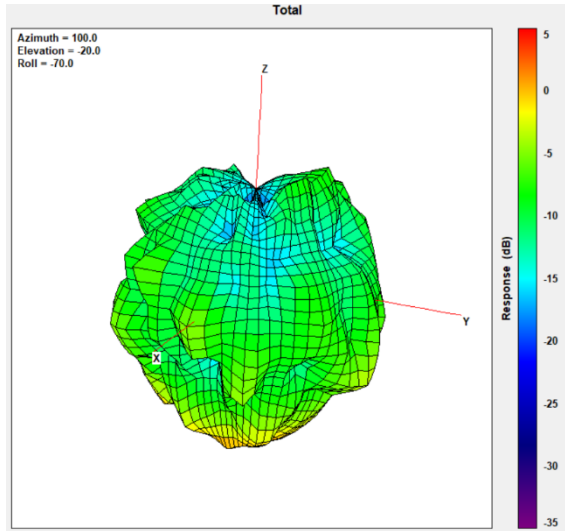

Max Antenna 3D Radiation Pattern 5470-5725 MHz

Frequency (MHz)	Peak Gain w/ Cable Loss (dBi)
5470-5725	3.99

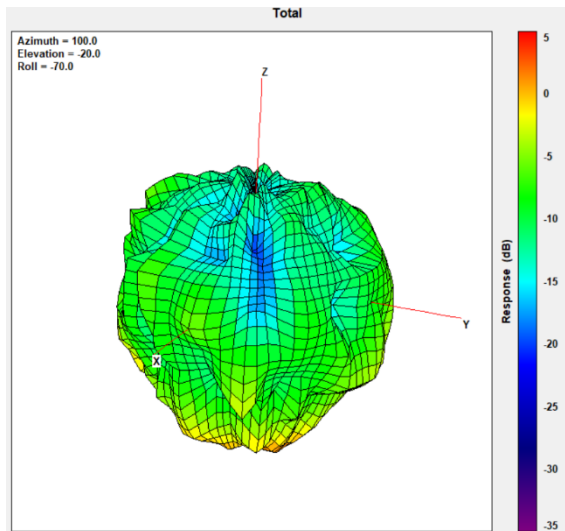

Max Antenna 3D Radiation Pattern 5725-5850 MHz

Frequency (MHz)	Peak Gain w/ Cable Loss (dBi)
5725-5850	4.09

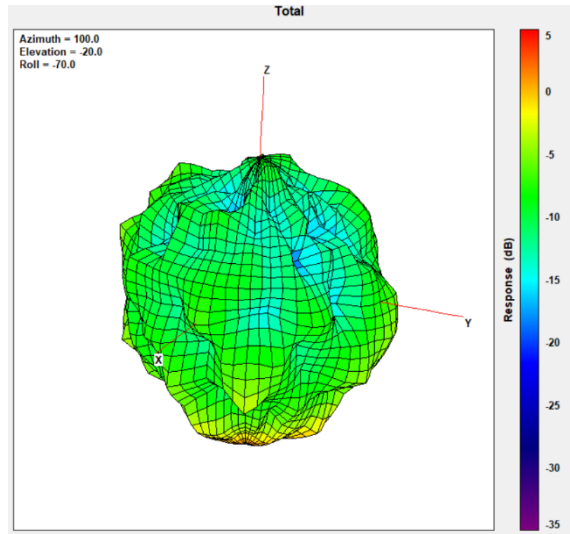

Max Antenna 3D Radiation Pattern 5925-6425 MHz

Frequency (MHz)	Peak Gain w/ Cable Loss (dBi)
5925-6425	4.64

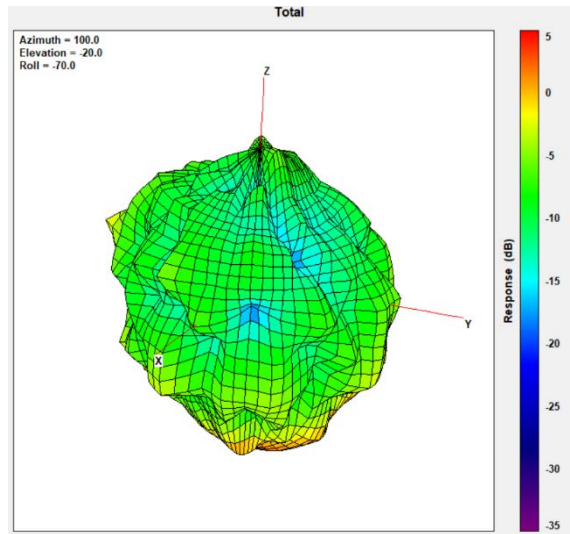

Max Antenna 3D Radiation Pattern 6425-6525 MHz

Frequency (MHz)	Peak Gain w/ Cable Loss (dBi)
6425-6525	3.48

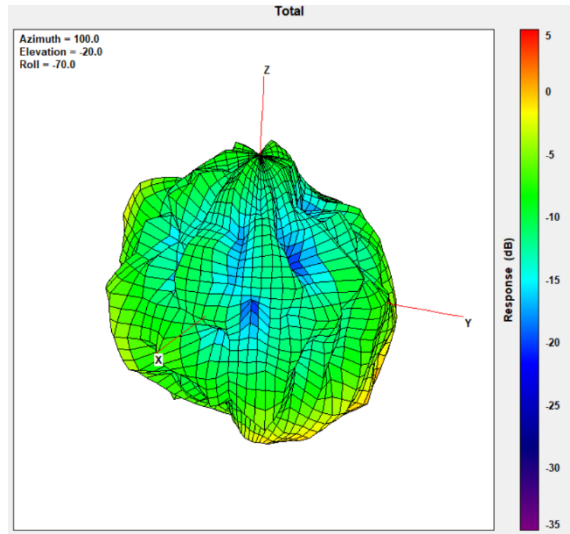

Max Antenna 3D Radiation Pattern 6525-6875 MHz

Frequency (MHz)	Peak Gain w/ Cable Loss (dBi)
6525-6875	4.43

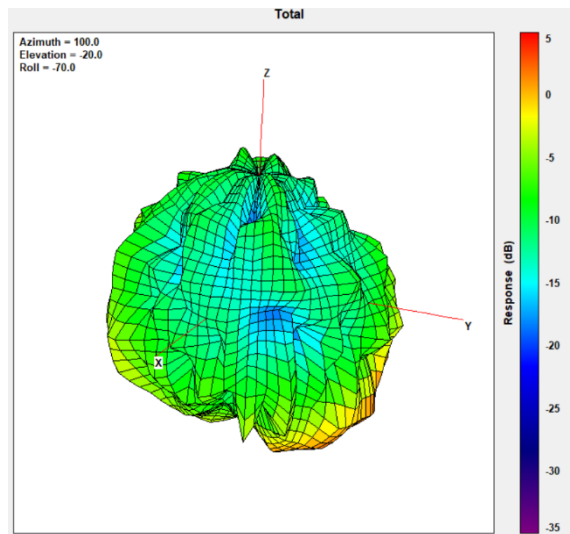

Max Antenna 3D Radiation Pattern 6875-7125 MHz

Frequency (MHz)	Peak Gain w/ Cable Loss (dBi)
6875-7125	4.08

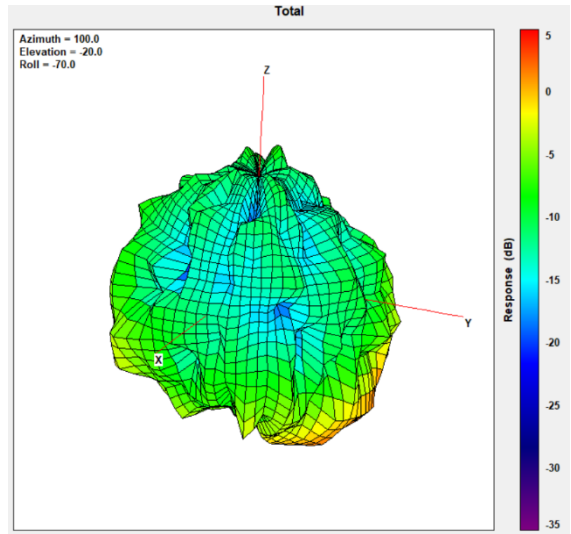

Auxiliary Antenna

Max Antenna 3D Radiation Pattern 2400 – 2483.5 MHz

Frequency (MHz)	Peak Gain w/ Cable Loss (dBi)
2400-2483.5	1.37

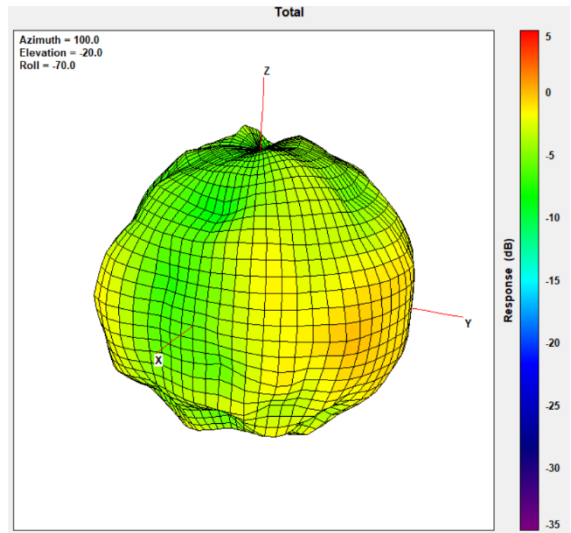

Max Antenna 3D Radiation Pattern 5150-5250 MHz

Frequency (MHz)	Peak Gain w/ Cable Loss (dBi)
5150-5250	3.00

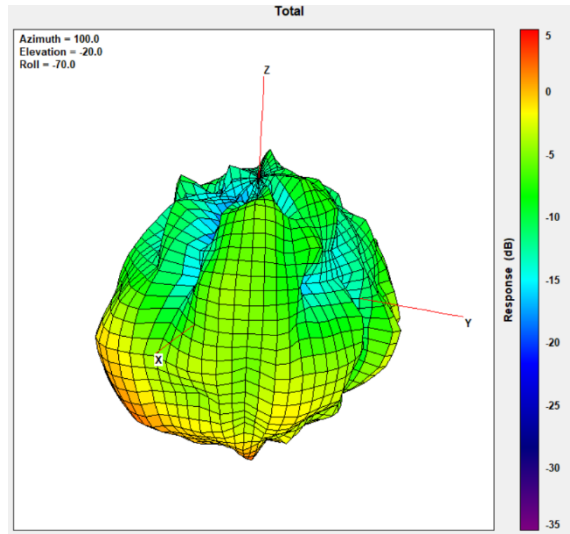

Max Antenna 3D Radiation Pattern 5250-5350 MHz

Frequency (MHz)	Peak Gain w/ Cable Loss (dBi)
5250-5350	3.00

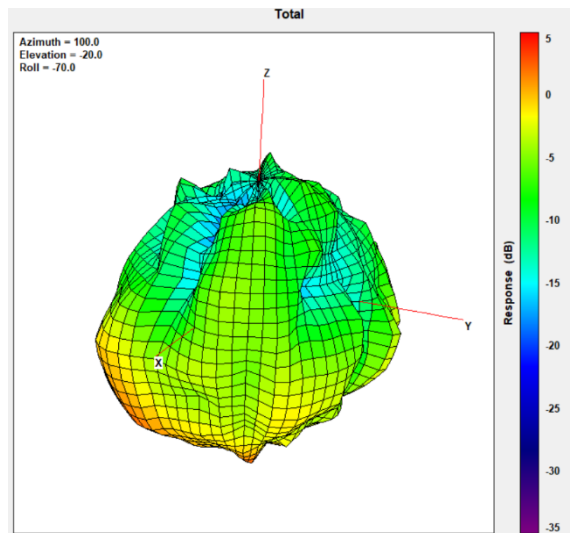

Max Antenna 3D Radiation Pattern 5470-5725 MHz

Frequency (MHz)	Peak Gain w/ Cable Loss (dBi)
5470-5725	3.86

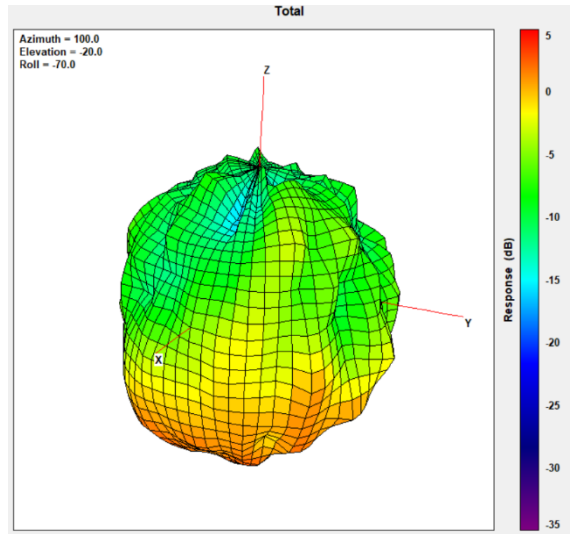

Max Antenna 3D Radiation Pattern 5725-5850 MHz

Frequency (MHz)	Peak Gain w/ Cable Loss (dBi)
5725-5850	4.15

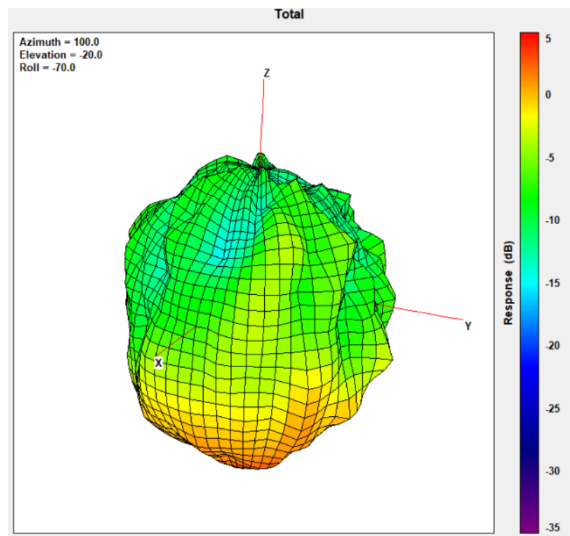

Max Antenna 3D Radiation Pattern 5925-6425 MHz

Frequency (MHz)	Peak Gain w/ Cable Loss (dBi)
5925-6425	4.55

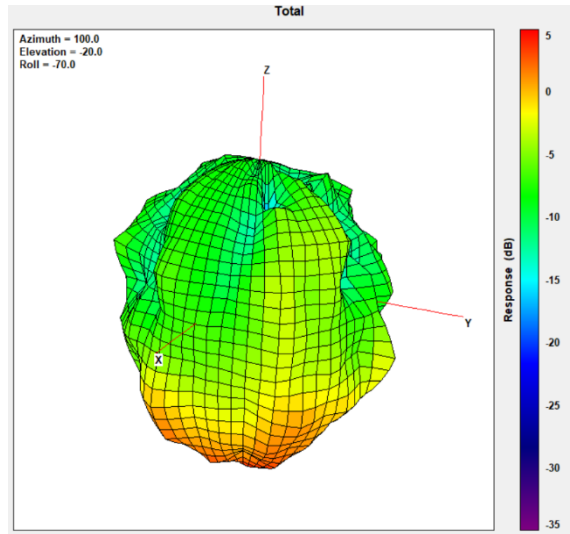

Max Antenna 3D Radiation Pattern 6425-6525 MHz

Frequency (MHz)	Peak Gain w/ Cable Loss (dBi)
6425-6525	4.04

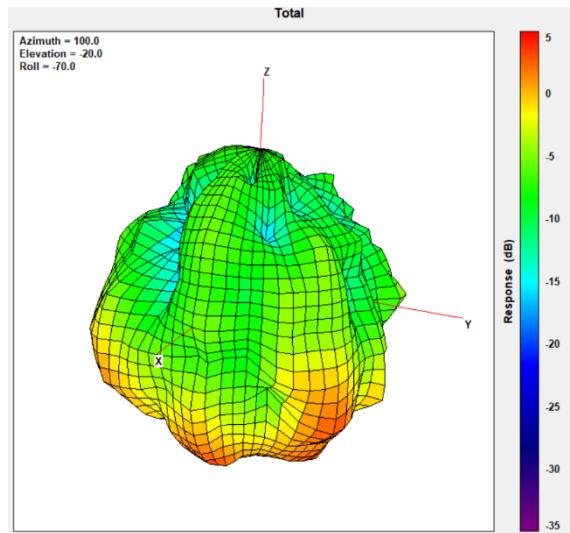

Max Antenna 3D Radiation Pattern 6525-6875 MHz

Frequency (MHz)	Peak Gain w/ Cable Loss (dBi)
6525-6875	4.22

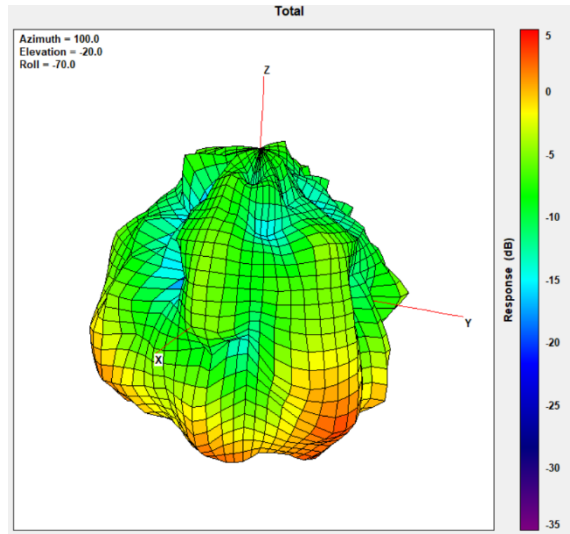

Max Antenna 3D Radiation Pattern 6875-7125 MHz

Frequency (MHz)	Peak Gain w/ Cable Loss (dBi)
6875-7125	1.87

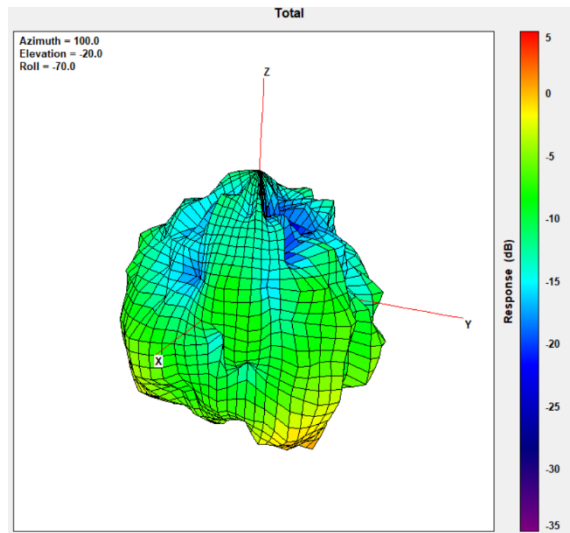

Section 4. Antenna Host Platform Location Information

Include a **dimensioned photo(s) or dimensioned drawing(s)** of Main and Aux antenna placements (measurements are not required for receive-only antenna).

Any antenna that transmits must show dimensions to bottom of laptop. Provide a description of the materials that are used for supporting or surrounding transmit antennas; for example, non-conductive plastics vs. conductive coated plastic or metallic materials.

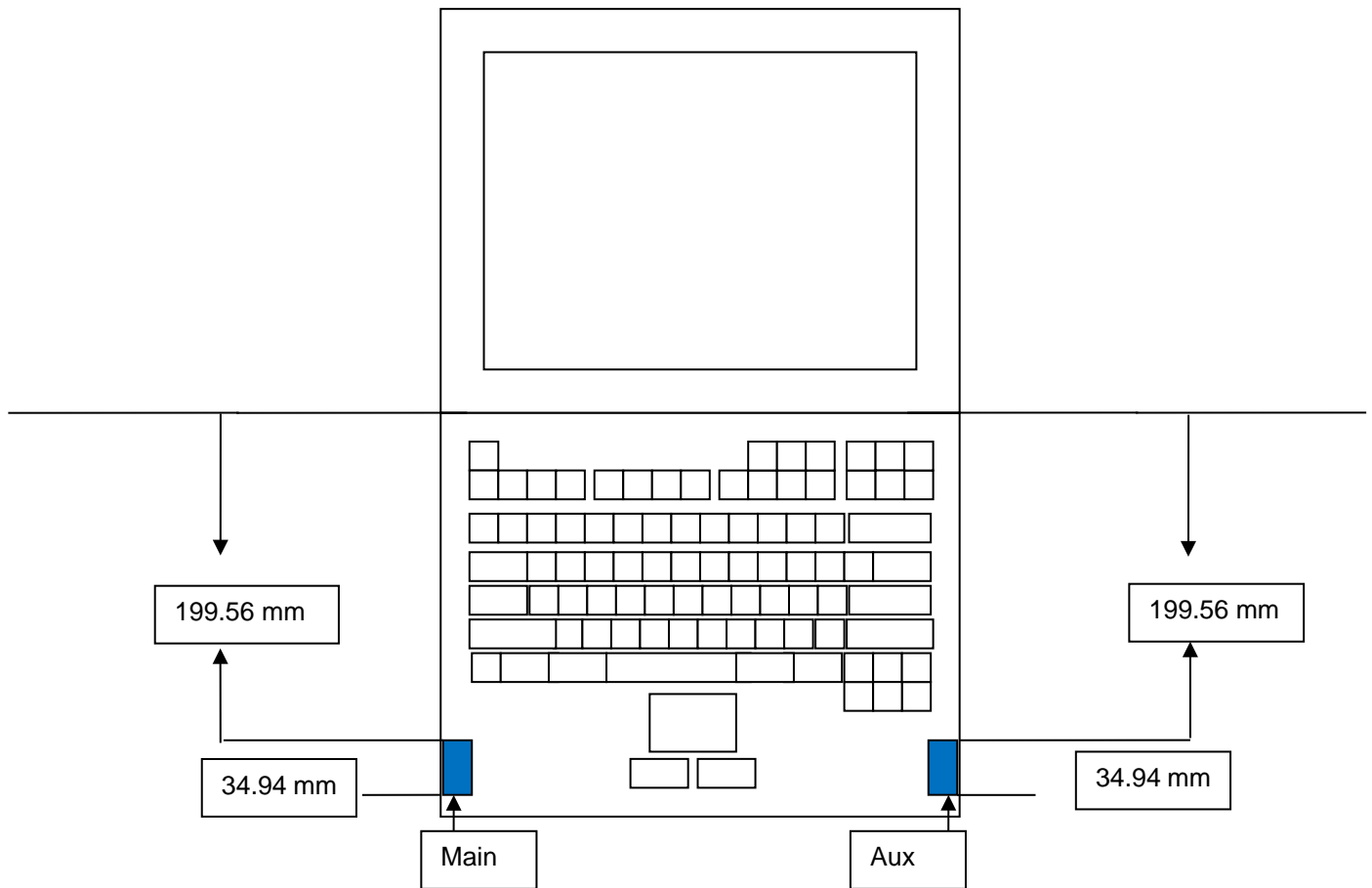

Section 5. Antenna dimensional information for SAR evaluation

Include a **dimensioned photo(s) or dimensioned drawing(s)** showing the distance (mm) between the transmit antennas and the user. For notebook/laptop hosts show lapheld position (example below). For tablet hosts show all orientations including lapheld, primary & secondary portrait, primary & secondary landscape positions. Include a description of any proximity sensors or power throttling implementations that limit or exclude use of any host orientation.

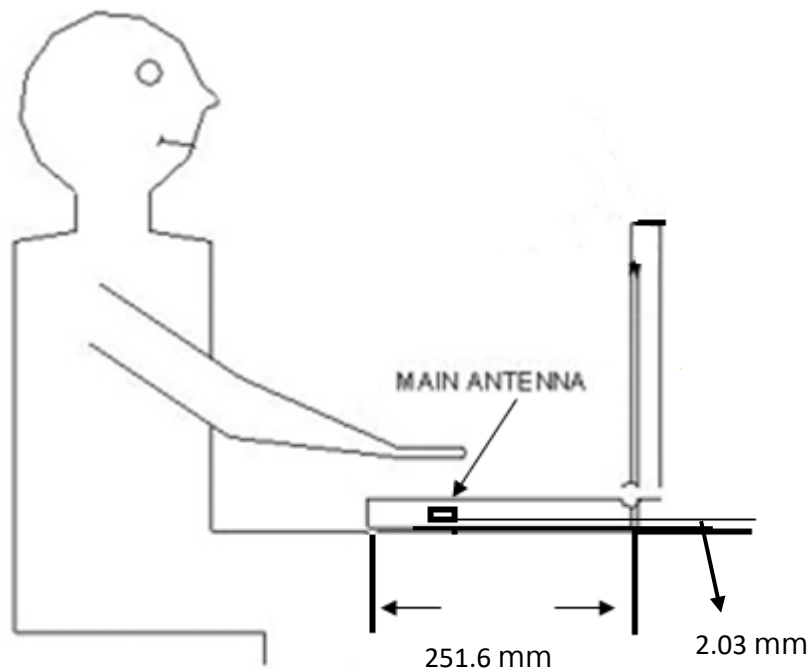

Section 6. Diagram Example of Co-Location Antenna Separation

Include a **dimensioned photo or dimensioned drawing** showing the distance (mm) between **all WLAN transmit antennas** and other co-located radiator transmit antenna such as Bluetooth, WWAN,..

(Note: Due to the evolving rules regarding co-location, each platform will need to be reviewed on a case by case basis)

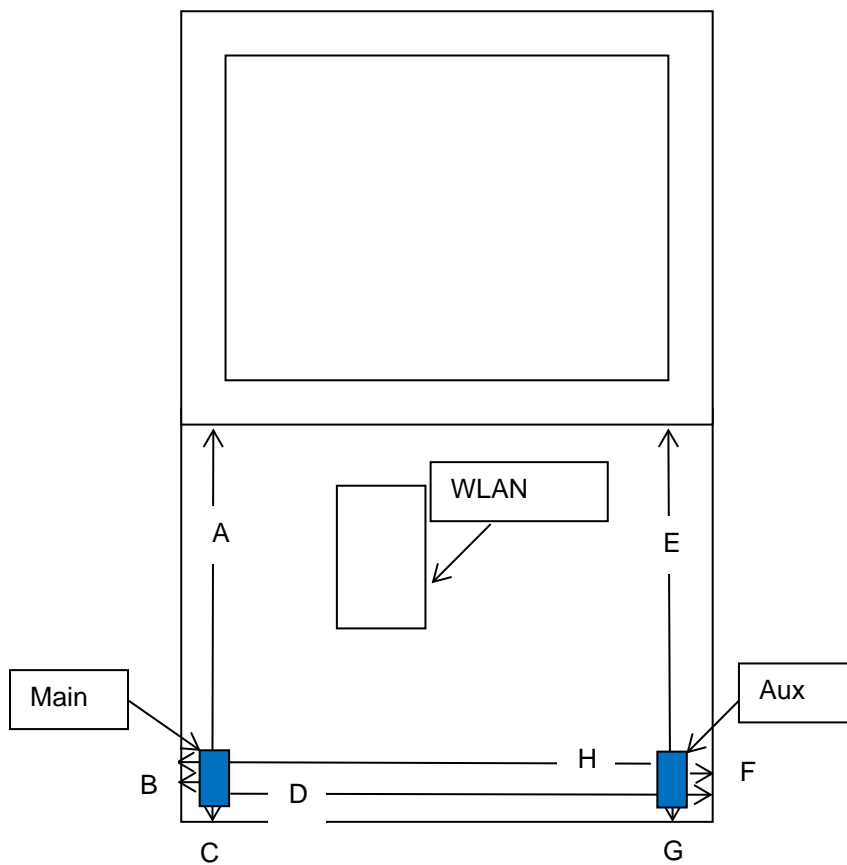

Distance	A	B	C	D	E	F	G	H
(mm)	199.56	6.7	17.10	340.93	199.56	6.7	17.10	340.93