

Antenna Test Report

For

Intel project

Customer	Intel	Project	---
Band	2.3~2.7&3.3~3.8 &5.15~5.85GHz	Color	---
SUC PN	---	Version	

Issued by		Checked by	
Confirmed by		Date	2007/3/30

1 Summary of the Test results

The test fixture was made for further testing, which was shown below.

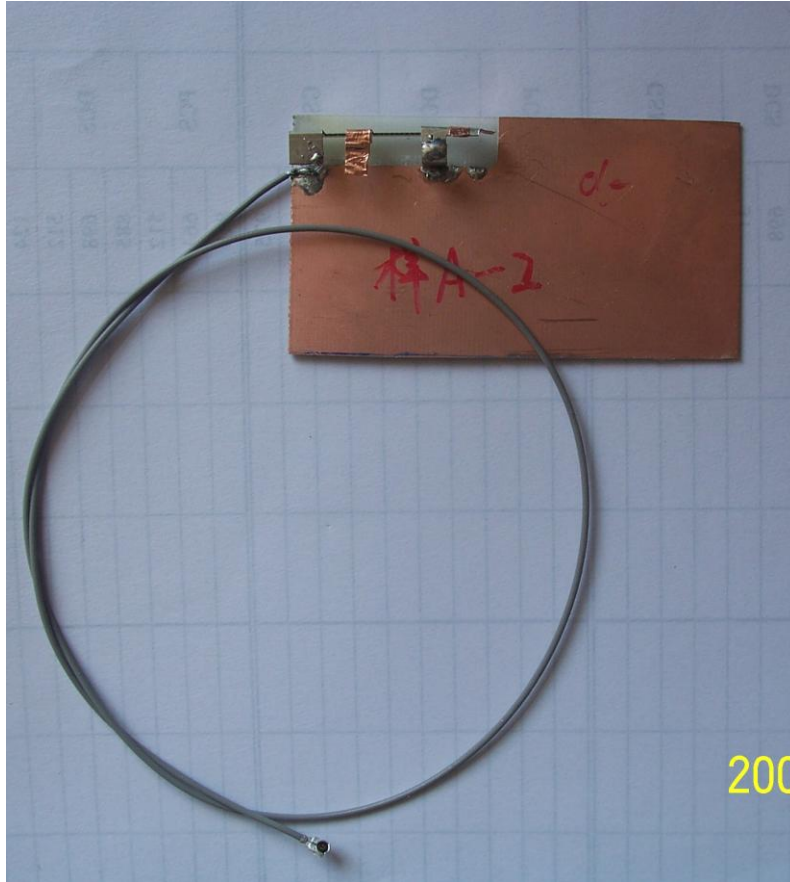

2. Test Result

2.1 RF Performance

2.1.1 S11 Measurement

The S11 parameter was performed using a Hewlett Packard E5071B Network Analyzer. We use a 45cm long 1.13 cable to mitigate surface currents on the outside of the testing cable.

We used no matching circuit .

The S11 parameter was shown below, you could check it.

SUC ANT S11 parameter Summary						
Band	2.3 ~2.7&3.3~3.8&5.15~5.85(GHz)					
	2.3	2.7	3.3	3.8	5.15	5.85
R.L (dB)	-16.59	-11.22	-8.87	-8.96	-8.46	-10.04
VSWR	1.35	1.76	2.13	2.11	2.22	1.92

You could also check in detail in below figures.

S11 parameter of sample antenna tested in free space

Confidential Information

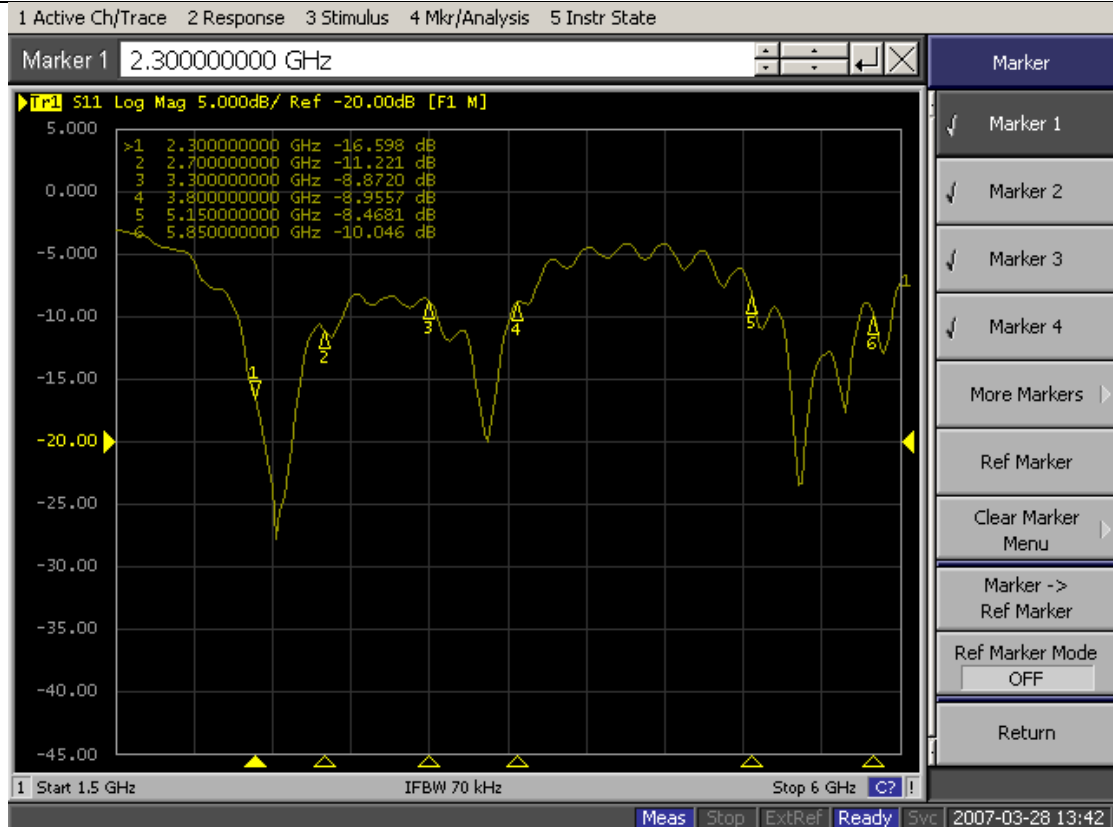

Marker

- Marker 1
- Marker 2
- Marker 3
- Marker 4
- More Markers ▶
- Ref Marker
- Clear Marker Menu ▶
- Marker -> Ref Marker
- Ref Marker Mode OFF
- Return

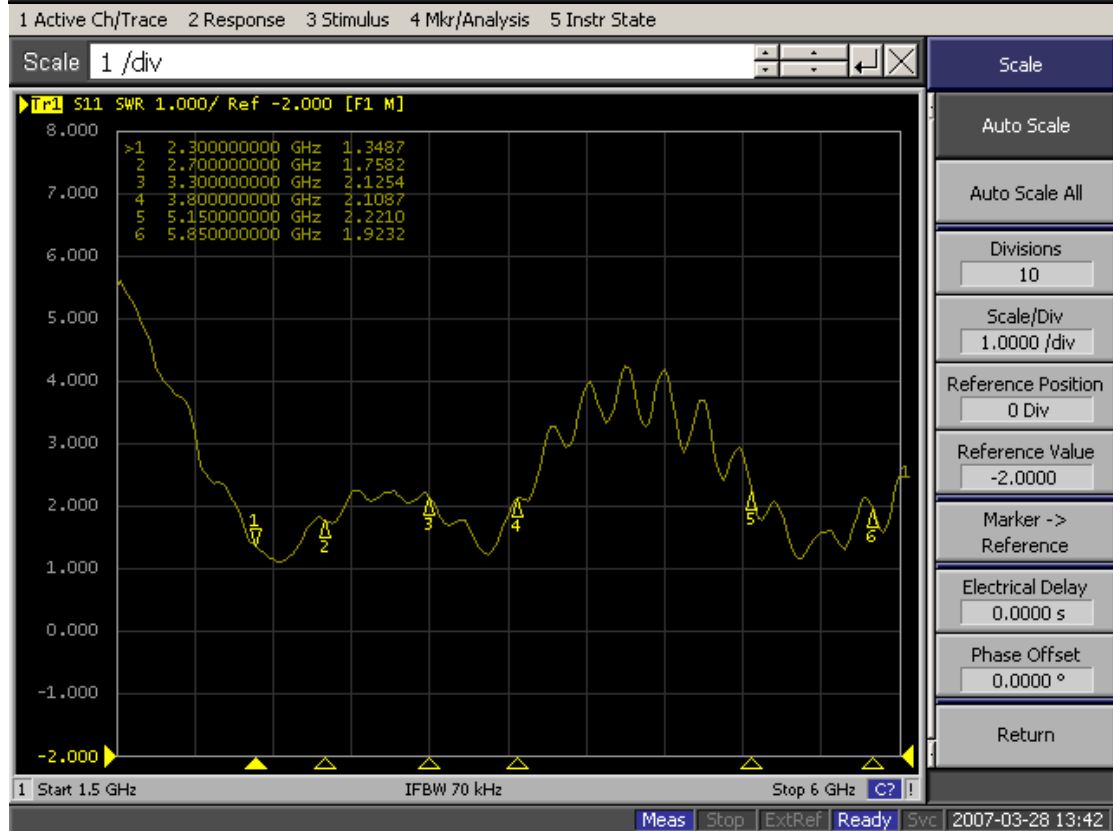

Scale

- Auto Scale
- Auto Scale All
- Divisions 10
- Scale/Div 1.0000 /div
- Reference Position 0 Div
- Reference Value -2.0000
- Marker -> Reference
- Electrical Delay 0.0000 s
- Phase Offset 0.0000 °
- Return

2.1.2 Radiation pattern and Gain Measurement

An anechoic chamber was used to measure radiation pattern and antenna Gain. SUC's chamber was working from 700MHz to 6GHz. The chamber provides less than -40 dB reflectivity from 700 MHz through 6 GHz. A standard horn was used to calibrate the chamber, and we also use a decoupling sleeve to reduce feed line radiation, so we can measure the antenna gain accurately.

The Gain parameter was shown below, you could check it.

SUC ANT Gain parameter Summary							
Band	2.4(GHz)						
	2.3	2.35	2.4	2.45	2.5	2.6	2.7
MAX Gain (dBi)	3.22	3.54	3.24	2.97	3.16	3.47	2.8
Efficiency (%)	74.48	73.72	73.39	72.52	74.29	88.94	74.38
SUC ANT Gain parameter Summary							
Band	3.4 (GHz)						
	3.3		3.5		3.8		
MAX Gain (dBi)	4.54		3.59		4.38		
Efficiency (%)	70.9		72.85		77.4		
SUC ANT Gain parameter Summary							
Band	5.4 (GHz)						
	5.15	5.25	5.35	5.45	5.75	5.85	
MAX Gain (dBi)	3.64	2.57	3.73	4.77	4.43	4.97	
Efficiency (%)	61.74	60.1	78.92	85.58	78.31	69.99	

The radiation pattern was shown below, you could check it.

Confidential Information

S

Location: **RF Chamber**
 Temperatur (): **22.00**

Date: **2007-3-30**
 Humidity (%): **65.00**

Time: **11:00:23**
 Approved by:

Total View

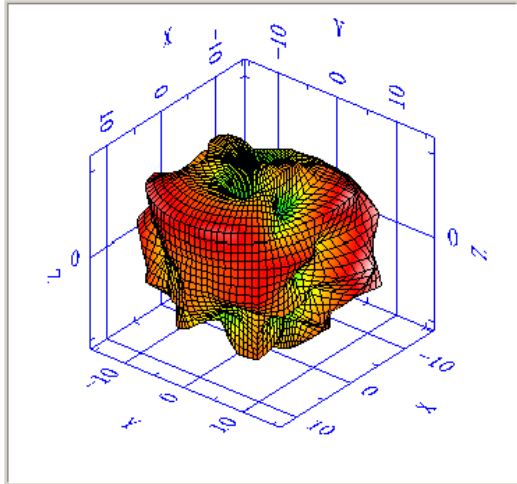

Frequency (MHz)	2300.00
TRP (dBm)	-1.28
Efficiency (%)	74.48
NHPRP +/- 45 (dBm)	-1.85
NHPRP +/- 30 (dBm)	-2.66
Directivity (dBi)	4.5
Gain (dBi)	3.22
Average Gain (dB)	-1.28
Peak EIRP (dBm)	3.22
Max. Power (dBm)	3.22
Min. Power (dBm)	-13.68
Avg. Power (dBm)	-2.17
Max. / Min. Ratio (dB)	16.89
Max. / Avg. Ratio (dB)	5.39
Min. / Avg. Ratio (dB)	-11.51

2.3GHz

S

Location: **RF Chamber**
 Temperatur (): **22.00**

Date: **2007-3-30**
 Humidity (%): **65.00**

Time: **11:00:37**
 Approved by:

Total View

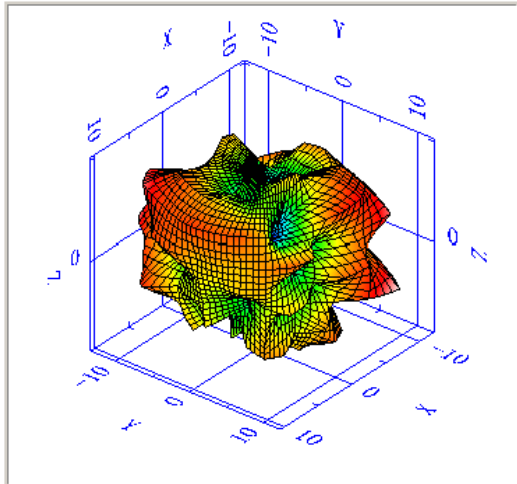

Frequency (MHz)	2350.00
TRP (dBm)	-1.32
Efficiency (%)	73.72
NHPRP +/- 45 (dBm)	-1.89
NHPRP +/- 30 (dBm)	-2.76
Directivity (dBi)	4.87
Gain (dBi)	3.54
Average Gain (dB)	-1.32
Peak EIRP (dBm)	3.54
Max. Power (dBm)	3.54
Min. Power (dBm)	-11.17
Avg. Power (dBm)	-2.18
Max. / Min. Ratio (dB)	14.72
Max. / Avg. Ratio (dB)	5.72
Min. / Avg. Ratio (dB)	-9

2.35GHz

Confidential Information

S

Location: **RF Chamber**
Temperaturer (): **22.00**

Date: **2007-3-30**
Humidity (%): **65.00**

Time: **11:01:28**
Approved by:

Total View

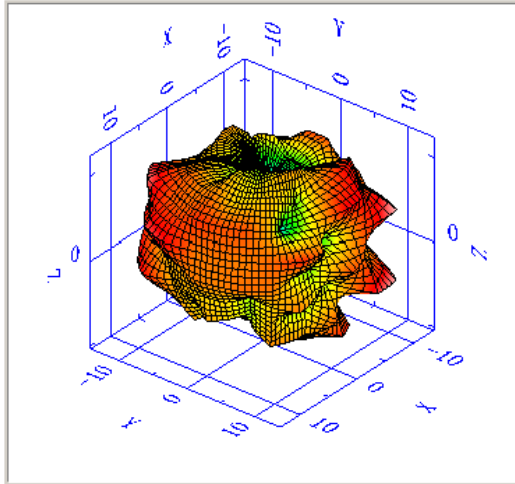

Frequency (MHz)	2400.00	Peak EIRP (dBm)	3.24
TRP (dBm)	-1.34	Max. Power (dBm)	3.24
Efficiency (%)	73.39	Min. Power (dBm)	-13.08
NHPRP +/- 45 (dBm)	-1.89	Avg. Power (dBm)	-2.21
NHPRP +/- 30 (dBm)	-2.79	Max. / Min. Ratio (dB)	16.31
Directivity (dBi)	4.58	Max. / Avg. Ratio (dB)	5.45
Gain (dBi)	3.24	Min. / Avg. Ratio (dB)	-10.87
Average Gain (dB)	-1.34		

2.4GHz

S

Location: **RF Chamber**
Temperaturer (): **22.00**

Date: **2007-3-30**
Humidity (%): **65.00**

Time: **11:01:34**
Approved by:

Total View

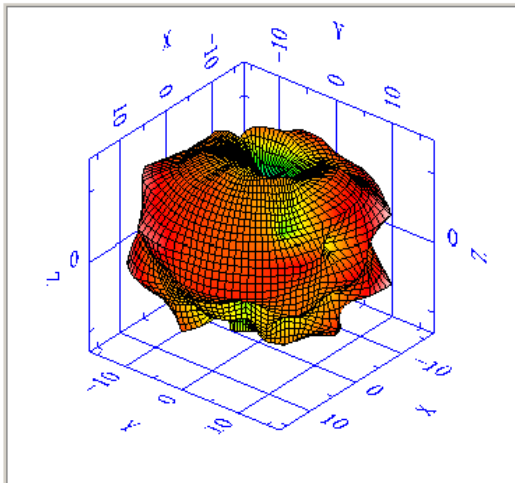

Frequency (MHz)	2450.00	Peak EIRP (dBm)	2.97
TRP (dBm)	-1.4	Max. Power (dBm)	2.97
Efficiency (%)	72.52	Min. Power (dBm)	-16.47
NHPRP +/- 45 (dBm)	-1.87	Avg. Power (dBm)	-2.28
NHPRP +/- 30 (dBm)	-2.71	Max. / Min. Ratio (dB)	19.44
Directivity (dBi)	4.37	Max. / Avg. Ratio (dB)	5.25
Gain (dBi)	2.97	Min. / Avg. Ratio (dB)	-14.19
Average Gain (dB)	-1.4		

2.45GHz

Confidential Information

S

Location: **RF Chamber**
Temperatuer (): **22.00**

Date: **2007-3-30**
Humidity (%): **65.00**

Time: **11:01:41**
Approved by:

Total View

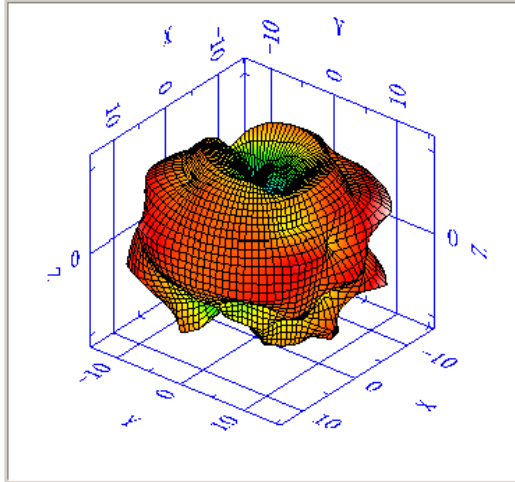

Frequency (MHz)	2500.00	Peak EIRP (dBm)	3.16
TRP (dBm)	-1.29	Max. Power (dBm)	3.16
Efficiency (%)	74.29	Min. Power (dBm)	-14.26
NHPRP +/- 45 (dBm)	-1.71	Avg. Power (dBm)	-2.22
NHPRP +/- 30 (dBm)	-2.61	Max. / Min. Ratio (dB)	17.42
Directivity (dBi)	4.45	Max. / Avg. Ratio (dB)	5.38
Gain (dBi)	3.16	Min. / Avg. Ratio (dB)	-12.04
Average Gain (dB)	-1.29		

2.5GHz

S

Location: **RF Chamber**
Temperatuer (): **22.00**

Date: **2007-3-30**
Humidity (%): **65.00**

Time: **11:01:48**
Approved by:

Total View

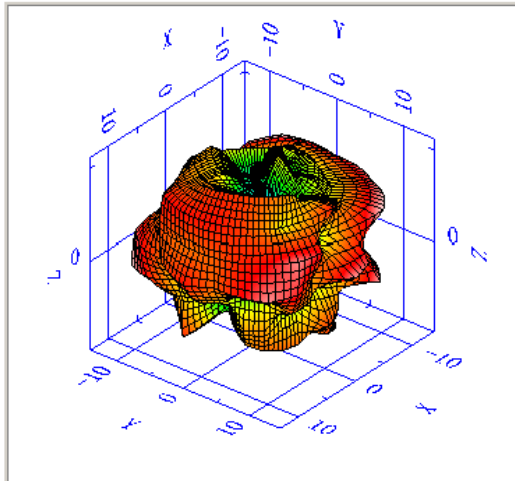

Frequency (MHz)	2600.00	Peak EIRP (dBm)	3.47
TRP (dBm)	-0.51	Max. Power (dBm)	3.47
Efficiency (%)	88.94	Min. Power (dBm)	-11.83
NHPRP +/- 45 (dBm)	-0.91	Avg. Power (dBm)	-1.32
NHPRP +/- 30 (dBm)	-1.82	Max. / Min. Ratio (dB)	15.29
Directivity (dBi)	3.98	Max. / Avg. Ratio (dB)	4.78
Gain (dBi)	3.47	Min. / Avg. Ratio (dB)	-10.51
Average Gain (dB)	-0.51		

2.6GHz

Confidential Information

Location: **RF Chamber**
 Temperatur (): **22.00**

Date: **2007-3-30**
 Humidity (%): **65.00**

Time: **11:01:54**
 Approved by:

Total View

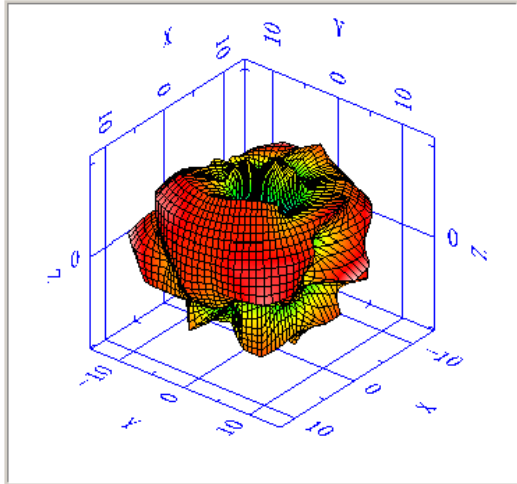

Frequency (MHz)	2700.00
TRP (dBm)	-1.29
Efficiency (%)	74.38
NHPRP +/- 45 (dBm)	-1.73
NHPRP +/- 30 (dBm)	-2.52
Directivity (dBi)	4.09
Gain (dBi)	2.8
Average Gain (dB)	-1.29
Peak EIRP (dBm)	2.8
Max. Power (dBm)	2.8
Min. Power (dBm)	-12.24
Avg. Power (dBm)	-1.98
Max. / Min. Ratio (dB)	15.05
Max. / Avg. Ratio (dB)	4.78
Min. / Avg. Ratio (dB)	-10.27

2.7GHz

Location: **RF Chamber**
 Temperatur (): **22.00**

Date: **2007-3-30**
 Humidity (%): **65.00**

Time: **11:02:03**
 Approved by:

Total View

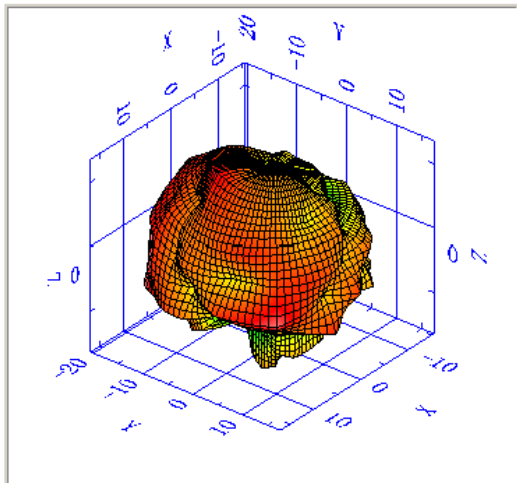

Frequency (MHz)	3300.00
TRP (dBm)	-1.49
Efficiency (%)	70.9
NHPRP +/- 45 (dBm)	-2.18
NHPRP +/- 30 (dBm)	-2.96
Directivity (dBi)	6.04
Gain (dBi)	4.54
Average Gain (dB)	-1.49
Peak EIRP (dBm)	4.54
Max. Power (dBm)	4.54
Min. Power (dBm)	-16.7
Avg. Power (dBm)	-2.05
Max. / Min. Ratio (dB)	21.25
Max. / Avg. Ratio (dB)	6.59
Min. / Avg. Ratio (dB)	-14.65

3.3GHz

Confidential Information

S

Location: **RF Chamber**
Temperatuer (): **22.00**

Date: **2007-3-30**
Humidity (%): **65.00**

Time: **11:02:14**
Approved by:

Total View

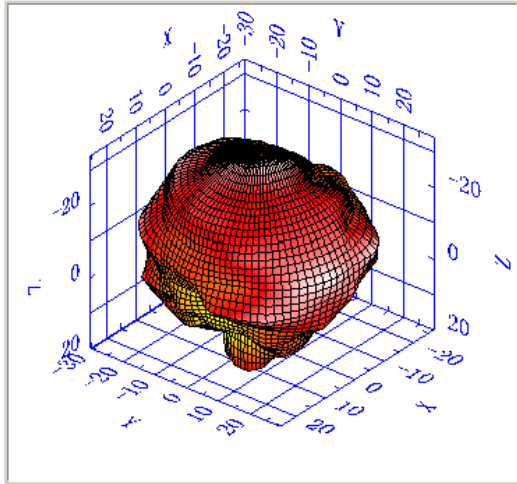

Frequency (MHz)	3500.00
TRP (dBm)	-1.38
Efficiency (%)	72.85
NHPRP +/- 45 (dBm)	-2.26
NHPRP +/- 30 (dBm)	-3.25
Directivity (dBi)	4.97
Gain (dBi)	3.59
Average Gain (dB)	-1.38
Peak EIRP (dBm)	3.59
Max. Power (dBm)	3.59
Min. Power (dBm)	-27.9
Avg. Power (dBm)	-1.23
Max. / Min. Ratio (dB)	31.49
Max. / Avg. Ratio (dB)	4.82
Min. / Avg. Ratio (dB)	-26.67

3.5GHz

S

Location: **RF Chamber**
Temperatuer (): **22.00**

Date: **2007-3-30**
Humidity (%): **65.00**

Time: **11:02:21**
Approved by:

Total View

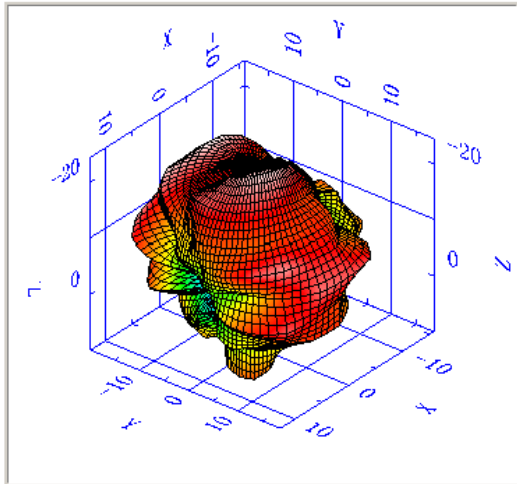

Frequency (MHz)	3800.00
TRP (dBm)	-1.11
Efficiency (%)	77.4
NHPRP +/- 45 (dBm)	-2.31
NHPRP +/- 30 (dBm)	-3.34
Directivity (dBi)	5.5
Gain (dBi)	4.38
Average Gain (dB)	-1.11
Peak EIRP (dBm)	4.38
Max. Power (dBm)	4.38
Min. Power (dBm)	-16.55
Avg. Power (dBm)	-0.69
Max. / Min. Ratio (dB)	20.93
Max. / Avg. Ratio (dB)	5.07
Min. / Avg. Ratio (dB)	-15.86

3.8GHz

Confidential Information

S

Location: **RF Chamber**
 Temperatur (): **22.00**

Date: **2007-3-30**
 Humidity (%): **65.00**

Time: **11:02:28**
 Approved by:

Total View

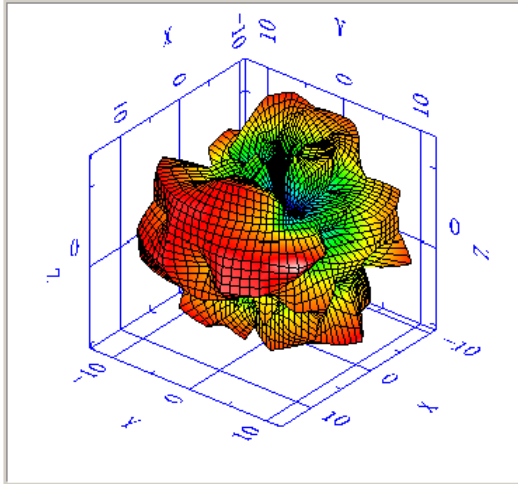

Frequency (MHz)	5150.00
TRP (dBm)	-2.09
Efficiency (%)	61.74
NHPRP +/- 45 (dBm)	-2.84
NHPRP +/- 30 (dBm)	-3.98
Directivity (dBi)	5.73
Gain (dBi)	3.64
Average Gain (dB)	-2.09
Peak EIRP (dBm)	3.64
Max. Power (dBm)	3.64
Min. Power (dBm)	-13.26
Avg. Power (dBm)	-2.36
Max. / Min. Ratio (dB)	16.89
Max. / Avg. Ratio (dB)	5.99
Min. / Avg. Ratio (dB)	-10.9

5.15GHz

S

Location: **RF Chamber**
 Temperatur (): **22.00**

Date: **2007-3-30**
 Humidity (%): **65.00**

Time: **11:02:36**
 Approved by:

Total View

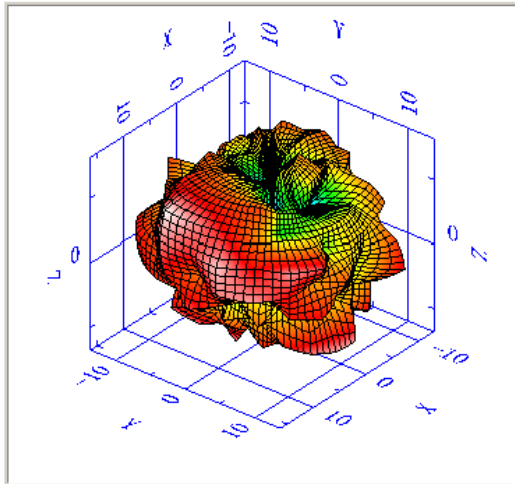

Frequency (MHz)	5250.00
TRP (dBm)	-2.21
Efficiency (%)	60.1
NHPRP +/- 45 (dBm)	-2.99
NHPRP +/- 30 (dBm)	-4.2
Directivity (dBi)	4.78
Gain (dBi)	2.57
Average Gain (dB)	-2.21
Peak EIRP (dBm)	2.57
Max. Power (dBm)	2.57
Min. Power (dBm)	-15.24
Avg. Power (dBm)	-2.57
Max. / Min. Ratio (dB)	17.81
Max. / Avg. Ratio (dB)	5.14
Min. / Avg. Ratio (dB)	-12.67

5.25GHz

Confidential Information

S

Location: **RF Chamber**
 Temperatur (): **22.00**

Date: **2007-3-30**
 Humidity (%): **65.00**

Time: **11:02:44**
 Approved by:

Total View

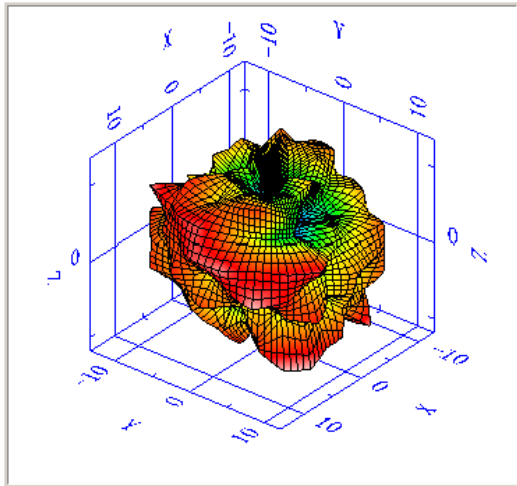

Frequency (MHz)	5350.00
TRP (dBm)	-1.03
Efficiency (%)	78.92
NHPRP +/- 45 (dBm)	-1.79
NHPRP +/- 30 (dBm)	-3.07
Directivity (dBi)	4.76
Gain (dBi)	3.73
Average Gain (dB)	-1.03
Peak EIRP (dBm)	3.73
Max. Power (dBm)	3.73
Min. Power (dBm)	-12.15
Avg. Power (dBm)	-1.42
Max. / Min. Ratio (dB)	15.88
Max. / Avg. Ratio (dB)	5.15
Min. / Avg. Ratio (dB)	-10.73

5.35GHz

S

Location: **RF Chamber**
 Temperatur (): **22.00**

Date: **2007-3-30**
 Humidity (%): **65.00**

Time: **11:02:52**
 Approved by:

Total View

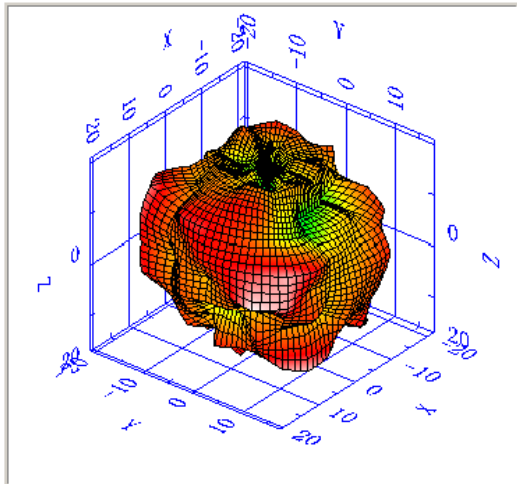

Frequency (MHz)	5450.00
TRP (dBm)	-0.68
Efficiency (%)	85.58
NHPRP +/- 45 (dBm)	-1.36
NHPRP +/- 30 (dBm)	-2.68
Directivity (dBi)	5.44
Gain (dBi)	4.77
Average Gain (dB)	-0.68
Peak EIRP (dBm)	4.77
Max. Power (dBm)	4.77
Min. Power (dBm)	-19.17
Avg. Power (dBm)	-1.07
Max. / Min. Ratio (dB)	23.94
Max. / Avg. Ratio (dB)	5.83
Min. / Avg. Ratio (dB)	-18.11

5.45GHz

Confidential Information

S

Location: **RF Chamber**
 Temperatur (): **22.00**

Date: **2007-3-30**
 Humidity (%): **65.00**

Time: **11:03:21**
 Approved by:

Total View

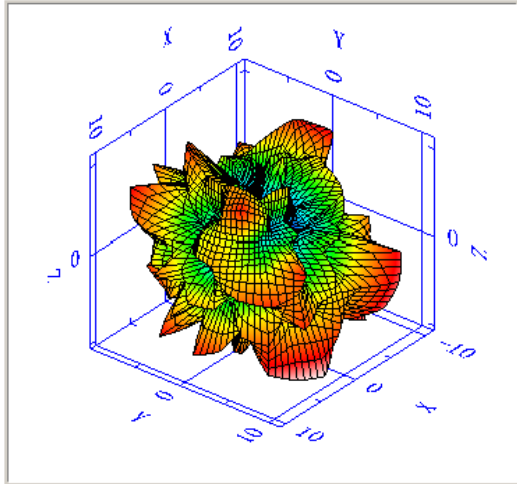

Frequency (MHz)	5750.00
TRP (dBm)	-1.06
Efficiency (%)	78.31
NHPRP +/- 45 (dBm)	-1.82
NHPRP +/- 30 (dBm)	-3.15
Directivity (dBi)	5.49
Gain (dBi)	4.43
Average Gain (dB)	-1.06
Peak EIRP (dBm)	4.43
Max. Power (dBm)	4.43
Min. Power (dBm)	-10.02
Avg. Power (dBm)	-1.21
Max. / Min. Ratio (dB)	14.45
Max. / Avg. Ratio (dB)	5.64
Min. / Avg. Ratio (dB)	-8.81

5.75GHz

S

Location: **RF Chamber**
 Temperatur (): **22.00**

Date: **2007-3-30**
 Humidity (%): **65.00**

Time: **11:03:37**
 Approved by:

Total View

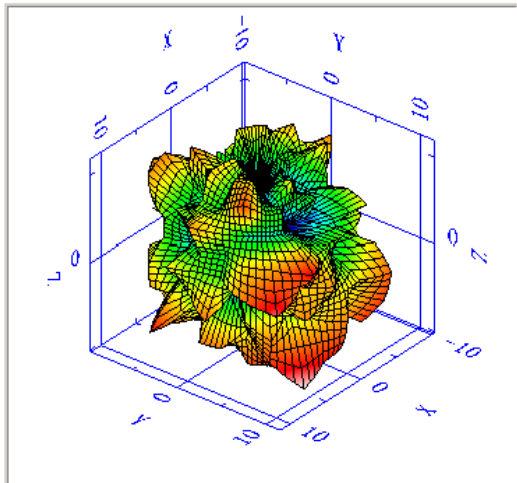

Frequency (MHz)	5850.00
TRP (dBm)	-1.55
Efficiency (%)	69.99
NHPRP +/- 45 (dBm)	-2.42
NHPRP +/- 30 (dBm)	-3.81
Directivity (dBi)	6.52
Gain (dBi)	4.97
Average Gain (dB)	-1.55
Peak EIRP (dBm)	4.97
Max. Power (dBm)	4.97
Min. Power (dBm)	-10.66
Avg. Power (dBm)	-1.54
Max. / Min. Ratio (dB)	15.63
Max. / Avg. Ratio (dB)	6.51
Min. / Avg. Ratio (dB)	-9.12

5.85GHz