

TEST REPORT

CERTIFICATE OF CONFORMITY

Standard: 47 CFR FCC Part 15, Subpart C (Section 15.247)

Report No.: RFBEIH-WTW-P22120764

FCC ID: P27IP6442B

Product: WiFi 6E Router

Brand: Charter Spectrum

Model No.: SAX2V1R

Received Date: 2023/2/20

Test Date: 2023/3/13 ~ 2023/3/28

Issued Date: 2023/4/25

Applicant: Sercomm Corporation

Address: 8F, No. 3-1, YuanQu St., NanKang, Taipei 115, Taiwan, R.O.C.

Issued By: Bureau Veritas Consumer Products Services (H.K.) Ltd., Taoyuan Branch
Lin Kou Laboratories

Lab Address: No. 47-2, 14th Ling, Chia Pau Vil., Lin Kou Dist., New Taipei City, Taiwan

Test Location: No. 47-2, 14th Ling, Chia Pau Vil., Lin Kou Dist., New Taipei City, Taiwan

FCC Registration / 198487 / TW2021

Designation Number:

Approved by:

Jeremy Lin

Date:

2023/4/25

Jeremy Lin / Project Engineer

This test report consists of 79 pages in total. It may be duplicated completely for legal use with the approval of the applicant. It should not be reproduced except in full, without the written approval of our laboratory. The test results in the report only apply to the tested sample. The test results in this report are traceable to the national or international standards.



Prepared by : Annie Chang / Senior Specialist

This report is governed by, and incorporates by reference, the Conditions of Testing as posted at the date of issuance of this report at <http://www.bureauveritas.com/home/about-us/our-business/cps/about-us/terms-conditions/> and is intended for your exclusive use. Any copying or replication of this report to or for any other person or entity, or use of our name or trademark, is permitted only with our prior written permission. This report sets forth our findings solely with respect to the test samples identified herein. The results set forth in this report are not indicative or representative of the quality or characteristics of the lot from which a test sample was taken or any similar or identical product unless specifically and expressly noted. Our report includes all of the tests requested by you and the results thereof based upon the information that you provided to us. Measurement uncertainty is only provided upon request for accredited tests. Statements of conformity are based on simple acceptance criteria without taking measurement uncertainty into account, unless otherwise requested in writing. You have 60 days from date of issuance of this report to notify us of any material error or omission caused by our negligence or if you require measurement uncertainty; provided, however, that such notice shall be in writing and shall specifically address the issue you wish to raise. A failure to raise such issue within the prescribed time shall constitute your unqualified acceptance of the completeness of this report, the tests conducted and the correctness of the report contents.

Table of Contents

Release Control Record	4
1 Certificate	5
2 Summary of Test Results	6
2.1 Measurement Uncertainty	6
2.2 Supplementary Information	6
3 General Information	7
3.1 General Description	7
3.2 Antenna Description of EUT	8
3.3 Channel List	9
3.4 Test Mode Applicability and Tested Channel Detail	10
3.5 Duty Cycle of Test Signal	11
3.6 Test Program Used and Operation Descriptions	13
3.7 Connection Diagram of EUT and Peripheral Devices	13
3.8 Configuration of Peripheral Devices and Cable Connections	13
4 Test Instruments	14
4.1 RF Output Power	14
4.2 Power Spectral Density	14
4.3 6 dB Bandwidth	15
4.4 Conducted Out of Band Emissions	15
4.5 AC Power Conducted Emissions	15
4.6 Unwanted Emissions below 1 GHz	16
4.7 Unwanted Emissions above 1 GHz	17
5 Limits of Test Items	18
5.1 RF Output Power	18
5.2 Power Spectral Density	18
5.3 6 dB Bandwidth	18
5.4 Conducted Out of Band Emissions	18
5.5 AC Power Conducted Emissions	18
5.6 Unwanted Emissions below 1 GHz	19
5.7 Unwanted Emissions above 1 GHz	19
6 Test Arrangements	20
6.1 RF Output Power	20
6.1.1 Test Setup	20
6.1.2 Test Procedure	20
6.2 Power Spectral Density	20
6.2.1 Test Setup	20
6.2.2 Test Procedure	20
6.3 6 dB Bandwidth	21
6.3.1 Test Setup	21
6.3.2 Test Procedure	21
6.4 Conducted Out of Band Emissions	21
6.4.1 Test Setup	21
6.4.2 Test Procedure	21
6.5 AC Power Conducted Emissions	22
6.5.1 Test Setup	22
6.5.2 Test Procedure	22
6.6 Unwanted Emissions below 1 GHz	23
6.6.1 Test Setup	23
6.6.2 Test Procedure	24
6.7 Unwanted Emissions above 1 GHz	25
6.7.1 Test Setup	25
6.7.2 Test Procedure	25
7 Test Results of Test Item	26



7.1	RF Output Power	26
7.2	Power Spectral Density	28
7.3	6 dB Bandwidth	32
7.4	Conducted Out of Band Emissions	34
7.5	AC Power Conducted Emissions	50
7.6	Unwanted Emissions below 1 GHz	52
7.7	Unwanted Emissions above 1 GHz	54
8	Pictures of Test Arrangements	78
9	Information of the Testing Laboratories	79



Release Control Record

Issue No.	Description	Date Issued
RFBEIH-WTW-P22120764	Original release.	2023/4/25

1 Certificate

Product: WiFi 6E Router

Brand: Charter Spectrum

Test Model: SAX2V1R

Sample Status: Engineering sample

Applicant: Sercomm Corporation

Test Date: 2023/3/13 ~ 2023/3/28

Standard: 47 CFR FCC Part 15, Subpart C (Section 15.247)

Measurement ANSI C63.10-2013

procedure: KDB 558074 D01 15.247 Meas Guidance v05r02

KDB 662911 D01 Multiple Transmitter Output v02r01

The above equipment has been tested by **Bureau Veritas Consumer Products Services (H.K.) Ltd., Taoyuan Branch**, and found compliance with the requirement of the above standards. The test record, data evaluation & Equipment Under Test (EUT) configurations represented herein are true and accurate accounts of the measurements of the sample's RF characteristics under the conditions specified in this report.

2 Summary of Test Results

47 CFR FCC Part 15, Subpart C (Section 15.247)			
Standard / Clause	Test Item	Result	Remark
15.247(b)	RF Output Power	Pass	Meet the requirement of limit.
15.247(e)	Power Spectral Density	Pass	Meet the requirement of limit.
15.247(a)(2)	6 dB Bandwidth	Pass	Meet the requirement of limit.
15.247(d)	Conducted Out of Band Emissions	Pass	Meet the requirement of limit.
15.207	AC Power Conducted Emissions	Pass	Minimum passing margin is -14.77 dB at 0.15770 MHz
15.205 / 15.209 / 15.247(d)	Unwanted Emissions below 1 GHz	Pass	Minimum passing margin is -10.2 dB at 66.42 MHz
15.205 / 15.209 / 15.247(d)	Unwanted Emissions above 1 GHz	Pass	Minimum passing margin is -0.3 dB at 2483.50 MHz
15.203	Antenna Requirement	Pass	Antenna connector is ipex not a standard connector.

Note: Determining compliance based on the results of the compliance measurement, not taking into account measurement instrumentation uncertainty.

2.1 Measurement Uncertainty

Where relevant, the following measurement uncertainty levels have been estimated for tests performed on the EUT as specified in CISPR 16-4-2:

Measurement	Specification	Expanded Uncertainty (k=2) (±)
Conducted Out of Band Emissions	9 kHz ~ 40 GHz	2.63 dB
AC Power Conducted Emissions	150 kHz ~ 30 MHz	3.00 dB
Unwanted Emissions below 1 GHz	9 kHz ~ 30 MHz	2.38 dB
	30 MHz ~ 1 GHz	5.7 dB
Unwanted Emissions above 1 GHz	1 GHz ~ 6 GHz	4.83 dB
	6 GHz ~ 18 GHz	5.37 dB
	18 GHz ~ 40 GHz	5.24 dB

The other instruments specified are routine verified to remain within the calibrated levels, no measurement uncertainty is required to be calculated.

2.2 Supplementary Information

There is not any deviation from the test standards for the test method, and no modifications required for compliance.

3 General Information

3.1 General Description

Product	WiFi 6E Router
Brand	Charter Spectrum
Test Model	SAX2V1R
Status of EUT	Engineering sample
Power Supply Rating	12Vdc from Adapter
Modulation Type	CCK, DQPSK, DBPSK for DSSS 64QAM, 16QAM, QPSK, BPSK for OFDM 256QAM for OFDM in VHT mode 1024QAM for OFDMA in 11ax mode only
Modulation Technology	DSSS, OFDM, OFDMA
Transfer Rate	Up to 1147.1 Mbps
Operating Frequency	2.412 GHz ~ 2.462 GHz
Number of Channel	802.11b, 802.11g, 802.11n (HT20), VHT20, 802.11ax (HE20):11 802.11n (HT40), VHT40, 802.11ax (HE40):7
Output Power	997.513 mW (29.99 dBm)

Note:

1. The EUT uses following accessories.

Item	Brand	Model	Specification
Adapter 1	Netbit	NBS36J120300VU	AC Input : 100-120V, 50/60Hz, 1.0A DC Output : 12.0V, 3.0A DC Output Cable : non-shielded, 1.8m
Adapter 2	Delta	ADH-36L WB	AC Input : 100-120V, 50/60Hz, 1.0A DC Output : 12.0V, 3.0A DC Output Cable : non-shielded, 1.8m
Adapter 3	Challenger	PS-2.5-12-3WT3	AC Input : 100-120V, 50/60Hz, 1.0A DC Output : 12.0V, 3.0A DC Output Cable : non-shielded, 1.8m
LAN cable	-	-	Non-shielded 1m

The above adapters were pre-tested and **Adapter 1** was the worst case for final test.

- There are Bluetooth, Thread and WLAN (2.4 GHz & 5 GHz & 5.9 GHz & 6 GHz) technology used for the EUT.
- WLAN 2.4 GHz & WLAN 5.9 GHz & WLAN 6 GHz & Bluetooth & Thread technology can transmit at same time.
WLAN 2.4 GHz & WLAN 5 GHz & WLAN 6 GHz & Bluetooth & Thread technology can transmit at same time.
- The above EUT information is declared by manufacturer and for more detailed features description, please refer to the manufacturer's specifications or user's manual.

3.2 Antenna Description of EUT

1. The antenna information is listed as below.

Antenna No.	Gain (dBi)	Antenna Type	Connector Type
Ant0_2G4	5.8	PCB	ipex(MHF)
Ant1_2G4	3.7		
Ant2_2G4	4.8		
Ant3_2G4	5.0		

* Detail antenna specification please refer to antenna datasheet and/or antenna measurement report.

2. The EUT incorporates a MIMO function:

Modulation Mode	CDD Mode	Beamforming Mode	TX & RX Configuration	
802.11b	Support	Not Support	4TX	4RX
802.11g	Support	Not Support	4TX	4RX
802.11n (HT20)	Support	Support	4TX	4RX
802.11n (HT40)	Support	Support	4TX	4RX
VHT20	Support	Support	4TX	4RX
VHT40	Support	Support	4TX	4RX
802.11ax (HE20)	Support	Support	4TX	4RX
802.11ax (HE40)	Support	Support	4TX	4RX

Note:

1. All of modulation mode support beamforming function except 802.11b & 802.11g modulation mode.
2. The EUT support Beamforming and CDD mode, therefore both mode were investigated and the worst case scenario was identified. The worst case data were presented in test report.
3. The modulation and bandwidth are similar for 802.11n mode for 20 MHz (40 MHz) and VHT mode for 20 MHz (40 MHz), therefore the manufacturer will control the power for 802.11n/VHT mode is the same as the 802.11ax or more lower than it and investigated worst case to representative mode in test report.

3.3 Channel List

11 channels are provided for 802.11b, 802.11g, 802.11n (HT20), VHT20, 802.11ax (HE20):

Channel	Frequency	Channel	Frequency
1	2412 MHz	7	2442 MHz
2	2417 MHz	8	2447 MHz
3	2422 MHz	9	2452 MHz
4	2427 MHz	10	2457 MHz
5	2432 MHz	11	2462 MHz
6	2437 MHz		

7 channels are provided for 802.11n (HT40), VHT40, 802.11ax (HE40):

Channel	Frequency	Channel	Frequency
3	2422 MHz	7	2442 MHz
4	2427 MHz	8	2447 MHz
5	2432 MHz	9	2452 MHz
6	2437 MHz		

3.4 Test Mode Applicability and Tested Channel Detail

Following channel(s) was (were) selected for the final test as listed below:

Test Item	Mode	Signal Mode	Tested Channel	Modulation	Data Rate Parameter
RF Output Power	802.11b	CDD	1, 6, 11	DBPSK	1Mb/s
	802.11g	CDD	1, 6, 11	BPSK	6Mb/s
	802.11ax (HE20)	CDD & Beamforming	1, 6, 11	BPSK	MCS0
	802.11ax (HE40)	CDD & Beamforming	3, 6, 9	BPSK	MCS0
Power Spectral Density	802.11b	CDD	1, 6, 11	DBPSK	1Mb/s
	802.11g	CDD	1, 6, 11	BPSK	6Mb/s
	802.11ax (HE20)	CDD	1, 6, 11	BPSK	MCS0
	802.11ax (HE40)	CDD	3, 6, 9	BPSK	MCS0
6 dB Bandwidth / Conducted Out of Band Emissions	802.11b	CDD	1, 6, 11	DBPSK	1Mb/s
	802.11g	CDD	1, 6, 11	BPSK	6Mb/s
	802.11ax (HE20)	CDD	1, 6, 11	BPSK	MCS0
	802.11ax (HE40)	CDD	3, 6, 9	BPSK	MCS0
AC Power Conducted Emissions	802.11g	-	6	BPSK	6Mb/s
Unwanted Emissions below 1 GHz	802.11g	-	6	BPSK	6Mb/s
Unwanted Emissions above 1 GHz	802.11b	CDD	1, 6, 11	DBPSK	1Mb/s
	802.11g	CDD	1, 6, 11	BPSK	6Mb/s
	802.11ax (HE20)	CDD & Beamforming	1, 6, 11	BPSK	MCS0
	802.11ax (HE40)	CDD & Beamforming	3, 6, 9	BPSK	MCS0

3.5 Duty Cycle of Test Signal

CDD

802.11b: Duty cycle = 12.417 ms / 12.435 ms x 100% = 99.9%

802.11g: Duty cycle = 3.009 ms / 3.035 ms x 100% = 99.1%

802.11ax (HE20): Duty cycle = 3.025 ms / 3.052 ms x 100% = 99.1%

802.11ax (HE40): Duty cycle = 3.011 ms / 3.038 ms x 100% = 99.1%

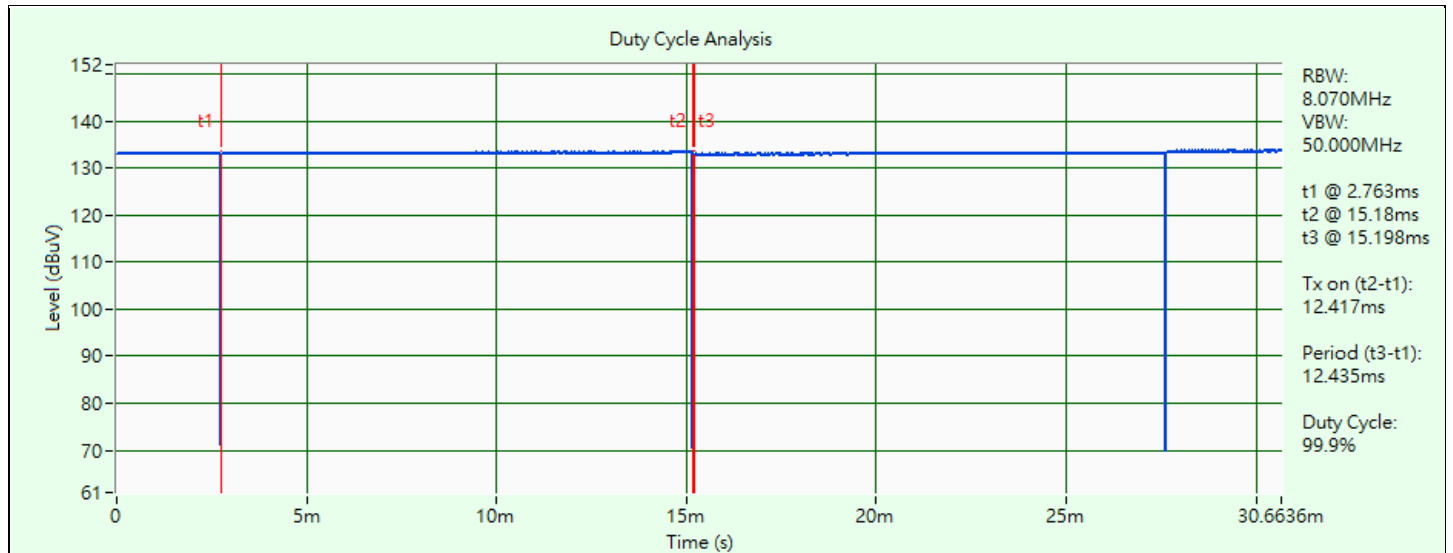

802.11b

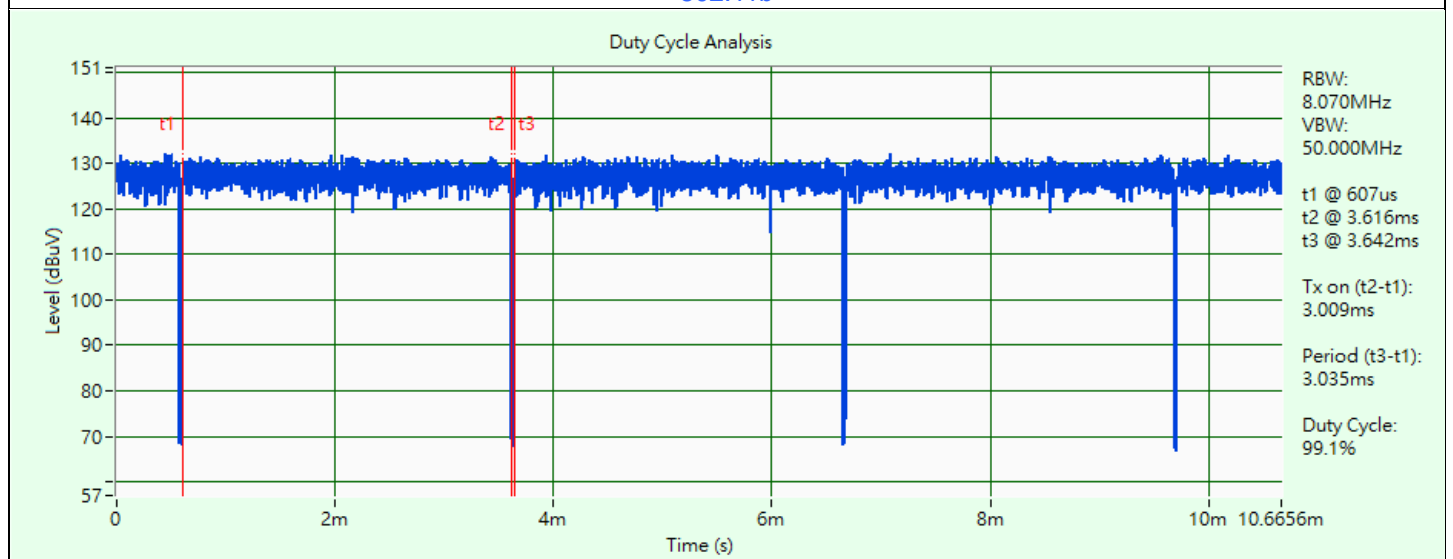

802.11g

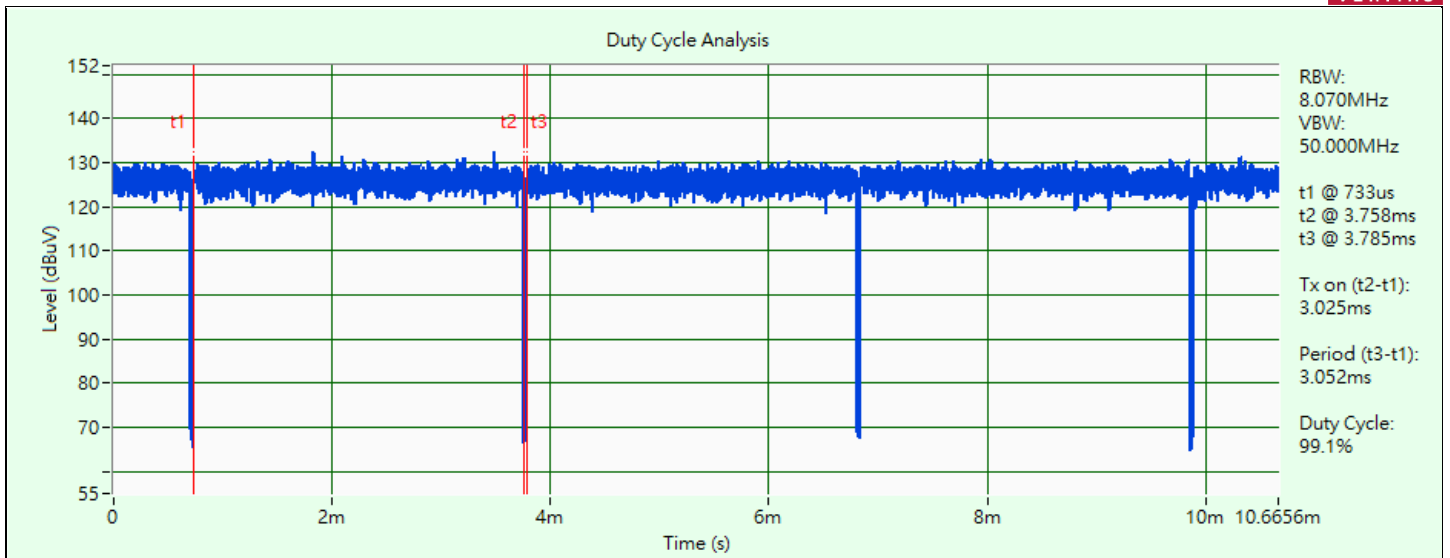

802.11ax (HE20)

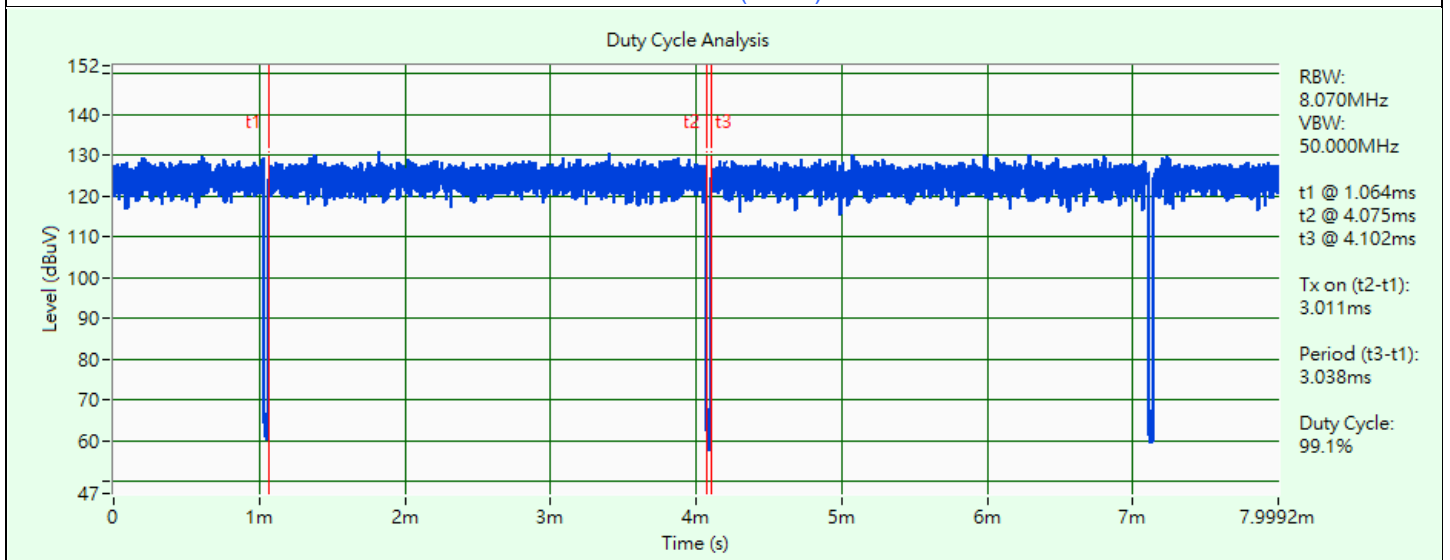

802.11ax (HE40)

3.6 Test Program Used and Operation Descriptions

Controlling software (accessMTool_3_3_0_1) has been activated to set the EUT under transmission condition continuously at specific channel frequency.

3.7 Connection Diagram of EUT and Peripheral Devices

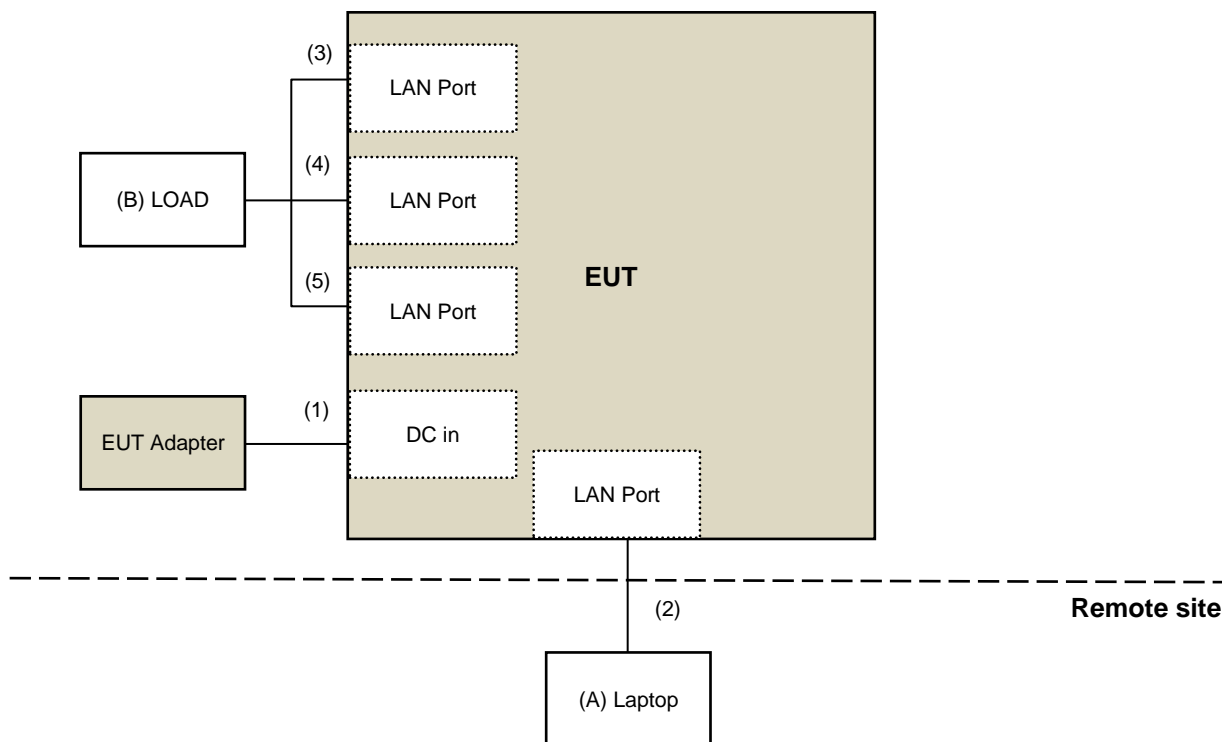

3.8 Configuration of Peripheral Devices and Cable Connections

ID	Product	Brand	Model No.	Serial No.	FCC ID	Remarks
A	Laptop	Lenovo	80WG	YD01YRC9	N/A	Provided by Lab
B	LOAD	N/A	N/A	N/A	N/A	Provided by Lab

ID	Cable Descriptions	Qty.	Length (m)	Shielding (Yes/No)	Cores (Qty.)	Remarks
1	DC cable	1	1.8	N	0	Supplied by applicant
2	LAN Cable	1	10	N	0	Provided by Lab
3	LAN Cable	1	0.9	N	0	Provided by Lab
4	LAN Cable	1	0.9	N	0	Provided by Lab
5	LAN Cable	1	0.9	N	0	Provided by Lab

4 Test Instruments

The calibration interval of the all test instruments are 12 months and the calibrations are traceable to NML/ROC and NIST/USA.

4.1 RF Output Power

Description Manufacturer	Model No.	Serial No.	Calibrated Date	Calibrated Until
MIMO Power measurement Test set (4X4) KEYSIGHT	U2021XA	U2021XA_001	2022/6/13	2023/6/12
MXG Vector Signal Generator KEYSIGHT	N5182B	MY53052658	2022/5/9	2023/5/8
Peak Power meter Anritsu	ML2495A	0842014	2022/4/27	2023/4/26
Pulse Power Sensor Anritsu	MA2411B	0738404	2022/4/27	2023/4/26
Spectrum Analyzer KEYSIGHT	N9030A	MY54490260	2022/7/14	2023/7/13
Spectrum Analyzer R&S	FSV40	101042	2022/9/5	2023/9/4
		101544	2022/5/9	2023/5/8
Temperature & Humidity Chamber TERCHY	MHU-225AU	920409	2022/6/27	2023/6/26
Voltage Meter FLUKE	179	89610322	2022/10/3	2023/10/2

Notes:

1. The test was performed in LK - Oven
2. Tested Date: 2023/3/16 ~ 2023/3/28

4.2 Power Spectral Density

Description Manufacturer	Model No.	Serial No.	Calibrated Date	Calibrated Until
MIMO Powermeasurement Test set (4X4) KEYSIGHT	U2021XA	U2021XA_001	2022/6/13	2023/6/12
MXG Vector Signal Generator KEYSIGHT	N5182B	MY53052658	2022/5/9	2023/5/8
Peak Power meter Anritsu	ML2495A	0842014	2022/4/27	2023/4/26
Pulse Power Sensor Anritsu	MA2411B	0738404	2022/4/27	2023/4/26
Spectrum Analyzer KEYSIGHT	N9030A	MY54490260	2022/7/14	2023/7/13
Spectrum Analyzer R&S	FSV40	101042	2022/9/5	2023/9/4
		101544	2022/5/9	2023/5/8
Temperature & Humidity Chamber TERCHY	MHU-225AU	920409	2022/6/27	2023/6/26
Voltage Meter FLUKE	179	89610322	2022/10/3	2023/10/2

Notes:

1. The test was performed in LK - Oven
2. Tested Date: 2023/3/16

4.3 6 dB Bandwidth

Refer to section 4.2 to get information of the instruments.

4.4 Conducted Out of Band Emissions

Refer to section 4.2 to get information of the instruments.

4.5 AC Power Conducted Emissions

Description Manufacturer	Model No.	Serial No.	Calibrated Date	Calibrated Until
50 ohm terminal LYNICS	0900510	E1-011285	2022/9/19	2023/9/18
		E1-011286	2022/9/19	2023/9/18
50 Ohms Terminator LYNICS	0900510	E1-01-305	2023/2/13	2024/2/12
Attenuator STI	STI02-2200-10	NO.4	2022/9/2	2023/9/1
DC LISN R&S	ESH3-Z6	100219	2022/8/2	2023/8/1
		844950/018	2022/8/2	2023/8/1
DC LISN Schwarzbeck	NNLK 8121	8121-808	2022/4/29	2023/4/28
High Voltage Probe Schwarzbeck	TK9420	00982	2022/12/14	2023/12/13
Isolation Transformer Erika Fiedler	D-65396	017	2022/9/8	2023/9/7
LISN R&S	ENV216	101196	2022/5/24	2023/5/23
LISN Schwarzbeck	NNLK 8121	8121-731	2022/5/26	2023/5/25
		8121-00759	2022/8/18	2023/8/17
	NNLK8129	8129229	2022/6/8	2023/6/7
	NSLK 8128	8128-244	2022/11/8	2023/11/7
RF Coaxial Cable Commate	5D-FB	Cable-CO5-01	2023/1/19	2024/1/18
Software BVADT	Cond_V7.3.7.4	N/A	N/A	N/A
Test Receiver R&S	ESR3	102412	2022/12/21	2023/12/20

Notes:

1. The test was performed in Linkou Conduction 5.
2. Tested Date: 2023/3/15

4.6 Unwanted Emissions below 1 GHz

Description Manufacturer	Model No.	Serial No.	Calibrated Date	Calibrated Until
* LOOP ANTENNA EMCI	LPA600	270	2021/9/2	2023/9/1
Bi_Log Antenna Schwarzbeck	VULB 9168	137	2022/10/21	2023/10/20
Coupling/Dcoupling Network Schwarzbeck	CDNE-M2	00097	2022/6/1	2023/5/31
	CDNE-M3	00091	2022/6/1	2023/5/31
Pre_Amplifier EMCI	EMC001340	980269	2022/6/28	2023/6/27
Pre_Amplifier HP	8447D	2432A03504	2023/2/16	2024/2/15
RF Coaxial Cable Pacific	8D-FB	Cable-CH6-02	2022/6/30	2023/6/29
Software BVADT	Radiated_V7.7.1.1.1	N/A	N/A	N/A
	Radiated_V8.7.08	N/A	N/A	N/A
Spectrum Analyzer R&S	FSV40	101544	2022/5/9	2023/5/8
Test Receiver Agilent	N9038A	MY51210129	2022/4/8	2023/4/7
		MY51210137	2022/6/9	2023/6/8
Tower ADT	AT100	0306	N/A	N/A
Turn Table ADT	TT100	0306	N/A	N/A

Notes:

- * The calibration interval of the above test instruments is 24 months and the calibrations are traceable to NML/ROC and NIST/USA
- The test was performed in Linkou 966 Chamber 6 (CH 6).
- Tested Date: 2023/3/14 ~ 2023/3/23

4.7 Unwanted Emissions above 1 GHz

Description Manufacturer	Model No.	Serial No.	Calibrated Date	Calibrated Until
Band Pass Filter MICRO-TRONICS	BRM17690	005	2022/5/26	2023/5/25
Boresight antenna tower fixture BV	BAF-02	6	N/A	N/A
High Pass Filter Wainwright Instruments	WHK 3.1/18G-10SS	SN 8	2022/5/26	2023/5/25
Horn Antenna EMCO	3115	00028257	2022/11/13	2023/11/12
Horn Antenna ETS-Lindgren	3117-PA	00215857	2023/2/3	2024/2/2
Horn Antenna Schwarzbeck	BBHA 9170	212	2022/10/20	2023/10/19
Notch Filter MICRO-TRONICS	BRC50703-01	010	2022/5/26	2023/5/25
Pre-amplifier HP	8449B	3008A01201	2023/2/16	2024/2/15
Pre-amplifier (18GHz-40GHz) EMCI	EMC184045B	980175	2022/9/3	2023/9/2
Pre_Amplifier EMCI	EMC0126545	980076	2023/2/16	2024/2/15
	EMC184045B	980235	2023/2/16	2024/2/15
RF Coaxial Cable EM	EM102-KMKM-3.5+1M	EM102-KMKM-3.5+1M-01	2022/7/7	2023/7/6
RF Coaxial Cable EMCI	EMC104	190801	2022/9/20	2023/9/19
		190804	2022/9/20	2023/9/19
RF Coaxial Cable HUBER SUHNER	SF-104	Cable-CH6-01	2022/9/20	2023/9/19
Software BVADT	Radiated_V7.7.1.1.1	N/A	N/A	N/A
	Radiated_V8.7.08	N/A	N/A	N/A
Spectrum Analyzer R&S	FSV40	101042	2022/9/5	2023/9/4
		101544	2022/5/9	2023/5/8
Test Receiver Agilent	N9038A	MY51210129	2022/4/8	2023/4/7
Tower ADT	AT100	0306	N/A	N/A
Turn Table ADT	TT100	0306	N/A	N/A

Notes:

1. The test was performed in Linkou 966 Chamber 6 (CH 6).
2. Tested Date: 2023/3/13 ~ 2023/3/14

5 Limits of Test Items

5.1 RF Output Power

For systems using digital modulation in the 2400–2483.5 MHz bands: 1 Watt (30 dBm)

Per KDB 662911 D01 Multiple Transmitter Output Method of conducted output power measurement on IEEE 802.11 devices,

Array Gain = 0 dB (i.e., no array gain) for $N_{ANT} \leq 4$;

Array Gain = 0 dB (i.e., no array gain) for channel widths ≥ 40 MHz for any N_{ANT} ;

Array Gain = $5 \log(N_{ANT}/N_{SS})$ dB or 3 dB, whichever is less, for 20-MHz channel widths with $N_{ANT} \geq 5$.

For power measurements on all other devices: Array Gain = $10 \log(N_{ANT}/N_{SS})$ dB.

5.2 Power Spectral Density

The Maximum of Power Spectral Density Measurement is 8 dBm in any 3 kHz.

5.3 6 dB Bandwidth

The minimum of 6 dB Bandwidth Measurement is 0.5 MHz.

5.4 Conducted Out of Band Emissions

Below 30 dB of the highest emission level of operating band (in 100 kHz Resolution Bandwidth).

5.5 AC Power Conducted Emissions

Frequency (MHz)	Conducted Limit (dBuV)	
	Quasi-peak	Average
0.15 - 0.5	66 - 56	56 - 46
0.50 - 5.0	56	46
5.0 - 30.0	60	50

Notes:

1. The lower limit shall apply at the transition frequencies.
2. The limit decreases in line with the logarithm of the frequency in the range of 0.15 to 0.50 MHz.

5.6 Unwanted Emissions below 1 GHz

Radiated emissions up to 1 GHz which fall in the restricted bands must comply with the radiated emission limits specified as below table. Other emissions shall be at least 30 dB below the highest level of the desired power:

Frequencies (MHz)	Field Strength (microvolts/meter)	Measurement Distance (meters)
0.009 ~ 0.490	2400/F(kHz)	300
0.490 ~ 1.705	24000/F(kHz)	30
1.705 ~ 30.0	30	30
30 ~ 88	100	3
88 ~ 216	150	3
216 ~ 960	200	3
Above 960	500	3

Notes:

1. The lower limit shall apply at the transition frequencies.
2. Emission level (dBuV/m) = 20 log Emission level (uV/m).

5.7 Unwanted Emissions above 1 GHz

Radiated emissions above 1 GHz which fall in the restricted bands must comply with the radiated emission limits specified as below table. Other emissions shall be at least 30 dB below the highest level of the desired power:

Frequencies (MHz)	Field Strength (microvolts/meter)	Measurement Distance (meters)
Above 960	500	3

Notes:

1. The lower limit shall apply at the transition frequencies.
2. Emission level (dBuV/m) = 20 log Emission level (uV/m).
3. For frequencies above 1000 MHz, the field strength limits are based on average detector, however, the peak field strength of any emission shall not exceed the maximum permitted average limits, specified above by more than 20 dB under any condition of modulation.

6 Test Arrangements

6.1 RF Output Power

6.1.1 Test Setup

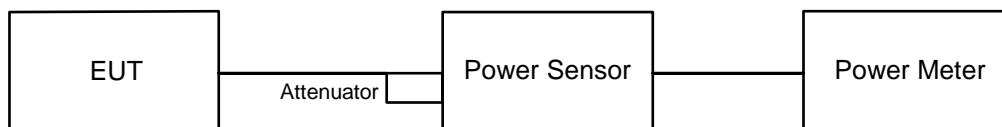

6.1.2 Test Procedure

Average Power:

Average power sensor was used to perform output power measurement, trigger and gating function of wide band power meter is enabled to measure max output power of TX on burst. Duty factor is not added to measured value.

6.2 Power Spectral Density

6.2.1 Test Setup

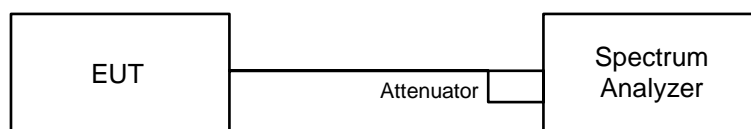

6.2.2 Test Procedure

- a. Measure the duty cycle (x).
- b. Set instrument center frequency to DTS channel center frequency.
- c. Set span to at least 1.5 times the OBW.
- d. Set RBW to: 3 kHz.
- e. Set VBW $\geq 3 \times$ RBW.
- f. Detector = power averaging (RMS) or sample detector (when RMS not available).
- g. Ensure that the number of measurement points in the sweep $\geq 2 \times$ span/RBW.
- h. Sweep time = auto couple.
- i. Do not use sweep triggering. Allow sweep to "free run".
- j. Employ trace averaging (RMS) mode over a minimum of 100 traces.
- k. Use the peak marker function to determine the maximum amplitude level.
- l. Note: If Duty cycle < 98%, Add $10 \log (1/x)$, where x is the duty cycle measured in step (a), to the measured PSD to compute the average PSD during the actual transmission time.

6.3 6 dB Bandwidth

6.3.1 Test Setup

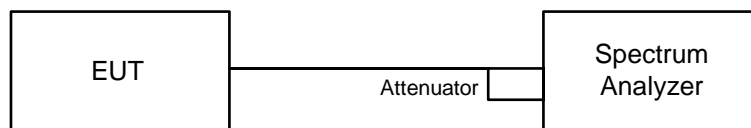

6.3.2 Test Procedure

- Set resolution bandwidth (RBW) = 100 kHz.
- Set the video bandwidth (VBW) $\geq 3 \times$ RBW, Detector = Peak.
- Trace mode = max hold.
- Sweep = auto couple.
- Measure the maximum width of the emission that is constrained by the frequencies associated with the two amplitude points (upper and lower) that are attenuated by 6 dB relative to the maximum level measured in the fundamental emission.

6.4 Conducted Out of Band Emissions

6.4.1 Test Setup

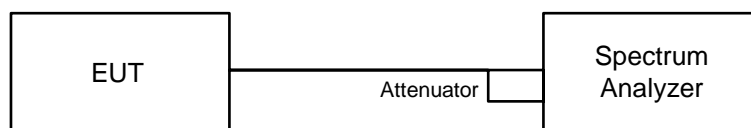

6.4.2 Test Procedure

MEASUREMENT PROCEDURE REF

- Set the RBW = 100 kHz.
- Set the VBW ≥ 300 kHz.
- Detector = peak.
- Sweep time = auto couple.
- Trace mode = max hold.
- Allow trace to fully stabilize.
- Use the peak marker function to determine the maximum power level in any 100 kHz band segment within the fundamental EBW.

MEASUREMENT PROCEDURE OOBE

- Set RBW = 100 kHz.
- Set VBW ≥ 300 kHz.
- Detector = peak.
- Sweep = auto couple.
- Trace Mode = max hold.
- Allow trace to fully stabilize.
- Use the peak marker function to determine the maximum amplitude level.

6.5 AC Power Conducted Emissions

6.5.1 Test Setup

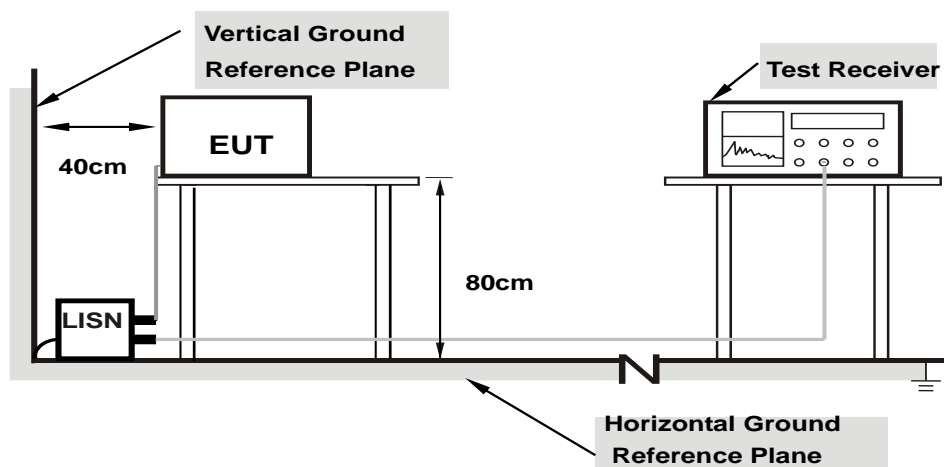

Note: 1.Support units were connected to second LISN.

For the actual test configuration, please refer to the attached file (Test Setup Photo).

6.5.2 Test Procedure

- The EUT was placed on a 0.8 meter to the top of table and placed 0.4 meters from the conducting wall of the shielded room with EUT being connected to the power mains through a line impedance stabilization network (LISN). Other support units were connected to the power mains through another LISN. The two LISNs provide 50 ohm/ 50 uH of coupling impedance for the measuring instrument.
- Both lines of the power mains connected to the EUT were checked for maximum conducted interference.
- The frequency range from 150 kHz to 30 MHz was searched. Emission levels under (Limit – 20 dB) was not recorded.

Note: The resolution bandwidth and video bandwidth of test receiver is 9 kHz for quasi-peak detection (QP) and average detection (AV) at frequency 0.15 MHz-30 MHz.

6.6 Unwanted Emissions below 1 GHz

6.6.1 Test Setup

For Radiated emission below 30 MHz

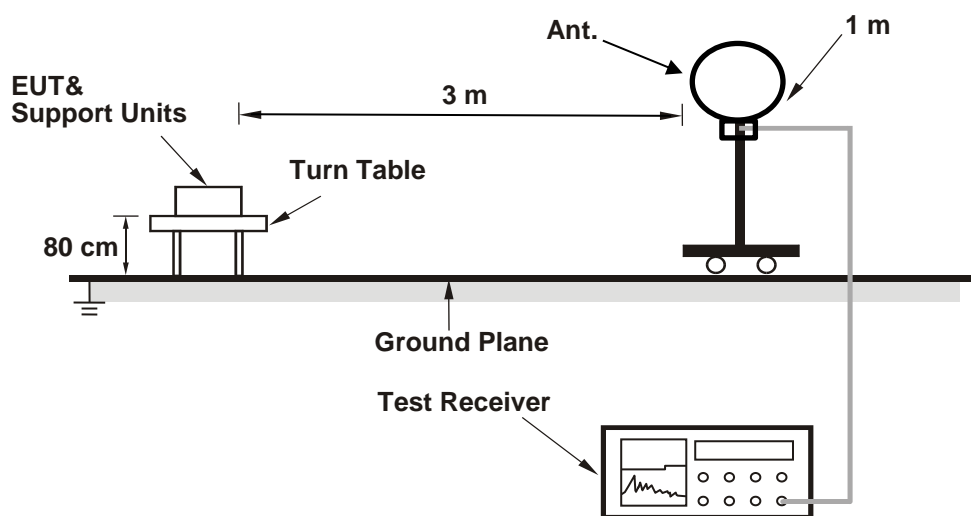

For Radiated emission above 30 MHz

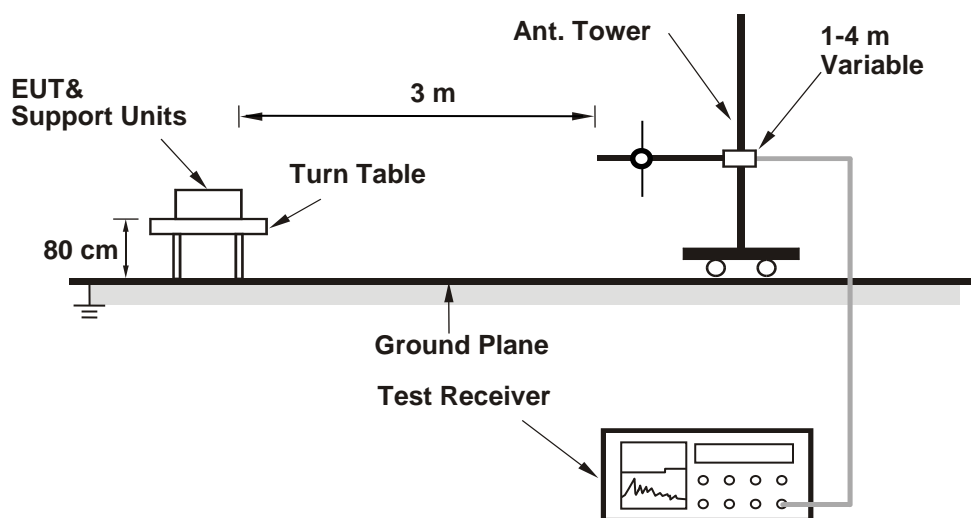

For the actual test configuration, please refer to the attached file (Test Setup Photo).

6.6.2 Test Procedure

For Radiated emission below 30 MHz

- a. The EUT was placed on the top of a rotating table 0.8 meters above the ground at 3 meter chamber room for test. The table was rotated 360 degrees to determine the position of the highest radiation.
- b. The EUT was set 3 meters away from the interference-receiving antenna, which was mounted on the top of a variable-height antenna tower.
- c. Parallel, perpendicular, and ground-parallel orientations of the antenna are set to make the measurement.
- d. For each suspected emission, the EUT was arranged to its worst case and the rotatable table was turned from 0 degrees to 360 degrees to find the maximum reading.
- e. The test-receiver system was set to Quasi-Peak Detect Function and Specified Bandwidth with Maximum Hold Mode, except for the frequency band (9 kHz to 90 kHz and 110 kHz to 490 kHz) set to average detect function and peak detect function.

Notes:

1. The resolution bandwidth and video bandwidth of test receiver/spectrum analyzer is 200 Hz at frequency below 150 kHz.
2. The resolution bandwidth and video bandwidth of test receiver/spectrum analyzer is 9 kHz or 10 kHz at frequency (150 kHz to 30 MHz).
3. All modes of operation were investigated and the worst-case emissions are reported.

For Radiated emission above 30 MHz

- a. The EUT was placed on the top of a rotating table 0.8 meters above the ground at 3 meter chamber room for test. The table was rotated 360 degrees to determine the position of the highest radiation.
- b. The EUT was set 3 meters away from the interference-receiving antenna, which was mounted on the top of a variable-height antenna tower.
- c. The height of antenna is varied from one meter to four meters above the ground to determine the maximum value of the field strength. Both horizontal and vertical polarizations of the antenna are set to make the measurement.
- d. For each suspected emission, the EUT was arranged to its worst case and then the antenna was tuned to heights from 1 meter to 4 meters and the rotatable table was turned from 0 degrees to 360 degrees to find the maximum reading.
- e. The test-receiver system was set to quasi-peak detect function and specified bandwidth with maximum hold mode when the test frequency is below 1 GHz.

Notes:

1. The resolution bandwidth and video bandwidth of test receiver/spectrum analyzer is 120 kHz for Quasi-peak detection (QP) at frequency below 1 GHz.
2. All modes of operation were investigated and the worst-case emissions are reported.

6.7 Unwanted Emissions above 1 GHz

6.7.1 Test Setup

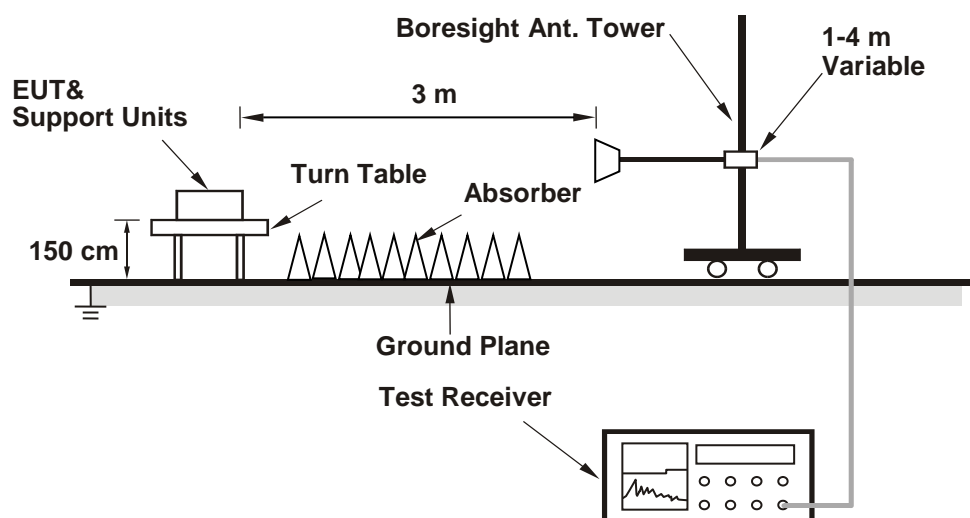

For the actual test configuration, please refer to the attached file (Test Setup Photo).

6.7.2 Test Procedure

- The EUT was placed on the top of a rotating table 1.5 meters above the ground at 3 meter chamber room for test. The table was rotated 360 degrees to determine the position of the highest radiation.
- The EUT was set 3 meters away from the interference-receiving antenna, which was mounted on the top of a variable-height antenna tower.
- The height of antenna is varied from one meter to four meters above the ground to determine the maximum value of the field strength. Both horizontal and vertical polarizations of the antenna are set to make the measurement.
- For each suspected emission, the EUT was arranged to its worst case and then the antenna was tuned to heights from 1 meter to 4 meters and the rotatable table was turned from 0 degrees to 360 degrees to find the maximum reading.
- The test-receiver system was set to peak and average detects function and specified bandwidth with maximum hold mode when the test frequency is above 1 GHz. If the peak reading value also meets average limit, measurement with the average detector is unnecessary.

Notes:

- The resolution bandwidth of test receiver/spectrum analyzer is 1 MHz and the video bandwidth is 3 MHz for Peak detection (PK) and Average detection (AV) at frequency above 1 GHz.
- For fundamental and harmonic signal measurement, the resolution bandwidth of test receiver/spectrum analyzer is 1 MHz and the video bandwidth is $\geq 1/T$ (Duty cycle $< 98\%$) or 10 Hz (Duty cycle $\geq 98\%$) for Average detection (AV) at frequency above 1 GHz.
- All modes of operation were investigated and the worst-case emissions are reported.

7 Test Results of Test Item

7.1 RF Output Power

Input Power:	120 Vac, 60 Hz	Environmental Conditions:	25°C, 76% RH	Tested By:	Dalen Dai
--------------	----------------	---------------------------	--------------	------------	-----------

CDD

802.11b

Chan.	Chan. Freq. (MHz)	Average Power (dBm)				Total Power (mW)	Total Power (dBm)	Power Limit (dBm)	Test Result
		Chain 0	Chain 1	Chain 2	Chain 3				
1	2412	23.97	24.03	23.36	23.90	964.631	29.84	30	Pass
6	2437	23.93	24.08	23.75	24.00	991.357	29.96	30	Pass
11	2462	23.54	23.85	23.00	23.43	888.423	29.49	30	Pass

Notes:

1. Directional gain is the maximum gain of antennas.
2. The maximum gain is 5.8 dBi < 6 dBi, so the output power limit shall not be reduced.

802.11g

Chan.	Chan. Freq. (MHz)	Average Power (dBm)				Total Power (mW)	Total Power (dBm)	Power Limit (dBm)	Test Result
		Chain 0	Chain 1	Chain 2	Chain 3				
1	2412	23.80	23.86	23.27	23.65	927.168	29.67	30	Pass
6	2437	23.78	24.11	23.80	24.17	997.513	29.99	30	Pass
11	2462	23.42	23.72	23.16	23.33	877.583	29.43	30	Pass

Notes:

1. Directional gain is the maximum gain of antennas.
2. The maximum gain is 5.8 dBi < 6 dBi, so the output power limit shall not be reduced.

802.11ax (HE20)

Chan.	Chan. Freq. (MHz)	Average Power (dBm)				Total Power (mW)	Total Power (dBm)	Power Limit (dBm)	Test Result
		Chain 0	Chain 1	Chain 2	Chain 3				
1	2412	23.13	23.20	22.59	23.08	799.306	29.03	30	Pass
6	2437	24.01	23.88	23.87	24.08	995.75	29.98	30	Pass
11	2462	23.53	23.85	23.12	23.55	899.666	29.54	30	Pass

Notes:

1. Directional gain is the maximum gain of antennas.
2. The maximum gain is 5.8 dBi < 6 dBi, so the output power limit shall not be reduced.

802.11ax (HE40)

Chan.	Chan. Freq. (MHz)	Average Power (dBm)				Total Power (mW)	Total Power (dBm)	Power Limit (dBm)	Test Result
		Chain 0	Chain 1	Chain 2	Chain 3				
3	2422	23.32	23.68	23.25	23.59	888.038	29.48	30	Pass
6	2437	24.01	23.99	23.89	23.92	993.889	29.97	30	Pass
9	2452	23.70	23.98	23.78	23.75	960.376	29.82	30	Pass

Notes:

1. Directional gain is the maximum gain of antennas.
2. The maximum gain is 5.8 dBi < 6 dBi, so the output power limit shall not be reduced.

Beamforming

802.11ax (HE20)

Chan.	Chan. Freq. (MHz)	Average Power (dBm)				Total Power (mW)	Total Power (dBm)	Power Limit (dBm)	Test Result
		Chain 0	Chain 1	Chain 2	Chain 3				
1	2412	19.13	19.20	18.59	19.08	318.209	25.03	25.12	Pass
6	2437	19.01	18.88	18.87	19.08	314.884	24.98	25.12	Pass
11	2462	19.03	19.35	18.62	19.05	319.213	25.04	25.12	Pass

Notes:

1. Directional gain = $10 \log[(10^{\text{Chain0}/20} + 10^{\text{Chain1}/20} + 10^{\text{Chain2}/20} + 10^{\text{Chain3}/20})^2 / 4]$
2. The directional gain is 10.88 dBi > 6 dBi, so the output power limit shall be reduced to $30 - (10.88 - 6) = 25.12$ dBm.

802.11ax (HE40)

Chan.	Chan. Freq. (MHz)	Average Power (dBm)				Total Power (mW)	Total Power (dBm)	Power Limit (dBm)	Test Result
		Chain 0	Chain 1	Chain 2	Chain 3				
3	2422	18.82	19.18	18.75	19.09	315.088	24.98	25.12	Pass
6	2437	19.01	18.99	18.89	18.92	314.295	24.97	25.12	Pass
9	2452	18.70	18.98	18.78	18.75	303.698	24.82	25.12	Pass

Notes:

1. Directional gain = $10 \log[(10^{\text{Chain0}/20} + 10^{\text{Chain1}/20} + 10^{\text{Chain2}/20} + 10^{\text{Chain3}/20})^2 / 4]$
2. The directional gain is 10.88 dBi > 6 dBi, so the output power limit shall be reduced to $30 - (10.88 - 6) = 25.12$ dBm.

7.2 Power Spectral Density

Input Power:	120 Vac, 60 Hz	Environmental Conditions:	25°C, 76% RH	Tested By:	Dalen Dai
--------------	----------------	---------------------------	--------------	------------	-----------

CDD

802.11b

TX chain	Channel	Freq. (MHz)	PSD (dBm/3kHz)	10 log (N=4) dB	Total PSD (dBm/3kHz)	PSD Limit (dBm/3kHz)	Pass / Fail
Chain 0	1	2412	-8.03	6.02	-2.01	3.12	Pass
	6	2437	-7.41	6.02	-1.39	3.12	Pass
	11	2462	-7.78	6.02	-1.76	3.12	Pass
Chain 1	1	2412	-7.91	6.02	-1.89	3.12	Pass
	6	2437	-7.2	6.02	-1.18	3.12	Pass
	11	2462	-7.62	6.02	-1.6	3.12	Pass
Chain 2	1	2412	-8.59	6.02	-2.57	3.12	Pass
	6	2437	-7.5	6.02	-1.48	3.12	Pass
	11	2462	-9.35	6.02	-3.33	3.12	Pass
Chain 3	1	2412	-8.01	6.02	-1.99	3.12	Pass
	6	2437	-7.58	6.02	-1.56	3.12	Pass
	11	2462	-8.28	6.02	-2.26	3.12	Pass

Notes:

1. Method E) 2) c) Measure and add $10 \log(\text{NANT})$ dB of KDB 662911 is using for calculating total power density.
2. Directional gain = $10 \log[(10^{\text{Chain0}/20} + 10^{\text{Chain1}/20} + 10^{\text{Chain2}/20} + 10^{\text{Chain3}/20})^2 / 4]$
3. The directional gain is 10.88 dBi > 6 dBi, so the power density limit shall be reduced to $8 - (10.88 - 6) = 3.12$ dBm/3kHz.

802.11g

TX chain	Channel	Freq. (MHz)	PSD (dBm/3kHz)	10 log (N=4) dB	Total PSD (dBm/3kHz)	PSD Limit (dBm/3kHz)	Pass / Fail
Chain 0	1	2412	-11.04	6.02	-5.02	3.12	Pass
	6	2437	-11.08	6.02	-5.06	3.12	Pass
	11	2462	-11.4	6.02	-5.38	3.12	Pass
Chain 1	1	2412	-11.27	6.02	-5.25	3.12	Pass
	6	2437	-10.85	6.02	-4.83	3.12	Pass
	11	2462	-11.1	6.02	-5.08	3.12	Pass
Chain 2	1	2412	-11.6	6.02	-5.58	3.12	Pass
	6	2437	-11.18	6.02	-5.16	3.12	Pass
	11	2462	-11.76	6.02	-5.74	3.12	Pass
Chain 3	1	2412	-11.32	6.02	-5.3	3.12	Pass
	6	2437	-10.98	6.02	-4.96	3.12	Pass
	11	2462	-11.55	6.02	-5.53	3.12	Pass

Notes:

- Method E) 2) c) Measure and add 10 log(NANT) dB of KDB 662911 is using for calculating total power density.
- Directional gain = $10 \log[(10^{\text{Chain0}/20} + 10^{\text{Chain1}/20} + 10^{\text{Chain2}/20} + 10^{\text{Chain3}/20})^2 / 4]$
- The directional gain is 10.88 dBi > 6 dBi, so the power density limit shall be reduced to $8 - (10.88 - 6) = 3.12$ dBm/3kHz.

802.11ax (HE20)

TX chain	Channel	Freq. (MHz)	PSD (dBm/3kHz)	10 log (N=4) dB	Total PSD (dBm/3kHz)	PSD Limit (dBm/3kHz)	Pass / Fail
Chain 0	1	2412	-12.44	6.02	-6.42	3.12	Pass
	6	2437	-11.95	6.02	-5.93	3.12	Pass
	11	2462	-12.3	6.02	-6.28	3.12	Pass
Chain 1	1	2412	-12.14	6.02	-6.12	3.12	Pass
	6	2437	-12	6.02	-5.98	3.12	Pass
	11	2462	-12.25	6.02	-6.23	3.12	Pass
Chain 2	1	2412	-13.36	6.02	-7.34	3.12	Pass
	6	2437	-12.17	6.02	-6.15	3.12	Pass
	11	2462	-12.82	6.02	-6.8	3.12	Pass
Chain 3	1	2412	-12.57	6.02	-6.55	3.12	Pass
	6	2437	-11.96	6.02	-5.94	3.12	Pass
	11	2462	-12.29	6.02	-6.27	3.12	Pass

Notes:

- Method E) 2) c) Measure and add 10 log(NANT) dB of KDB 662911 is using for calculating total power density.
- Directional gain = $10 \log[(10^{\text{Chain0}/20} + 10^{\text{Chain1}/20} + 10^{\text{Chain2}/20} + 10^{\text{Chain3}/20})^2 / 4]$
- The directional gain is 10.88 dBi > 6 dBi, so the power density limit shall be reduced to $8 - (10.88 - 6) = 3.12$ dBm/3kHz.

802.11ax (HE40)

TX chain	Channel	Freq. (MHz)	PSD (dBm/3kHz)	10 log (N=4) dB	Total PSD (dBm/3kHz)	PSD Limit (dBm/3kHz)	Pass / Fail
Chain 0	3	2422	-14.29	6.02	-8.27	3.12	Pass
	6	2437	-13.61	6.02	-7.59	3.12	Pass
	9	2452	-13.77	6.02	-7.75	3.12	Pass
Chain 1	3	2422	-13.88	6.02	-7.86	3.12	Pass
	6	2437	-13.77	6.02	-7.75	3.12	Pass
	9	2452	-13.61	6.02	-7.59	3.12	Pass
Chain 2	3	2422	-14.32	6.02	-8.3	3.12	Pass
	6	2437	-13.6	6.02	-7.58	3.12	Pass
	9	2452	-13.73	6.02	-7.71	3.12	Pass
Chain 3	3	2422	-14.25	6.02	-8.23	3.12	Pass
	6	2437	-13.57	6.02	-7.55	3.12	Pass
	9	2452	-14.06	6.02	-8.04	3.12	Pass

Notes:

- Method E) 2) c) Measure and add $10 \log(\text{NANT})$ dB of KDB 662911 is using for calculating total power density.
- Directional gain = $10 \log[(10^{\text{Chain0}/20} + 10^{\text{Chain1}/20} + 10^{\text{Chain2}/20} + 10^{\text{Chain3}/20})^2 / 4]$
- The directional gain is 10.88 dBi > 6 dBi, so the power density limit shall be reduced to $8 - (10.88 - 6) = 3.12$ dBm/3kHz.



Spectrum Plot of Maximum Value

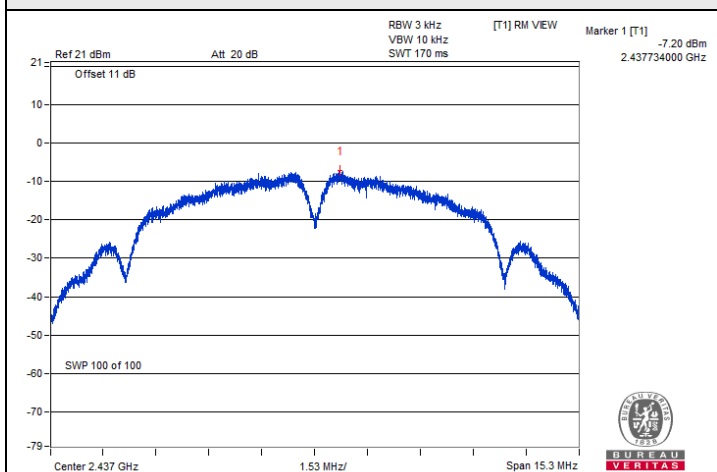

802.11b / Chain 1 : CH 6

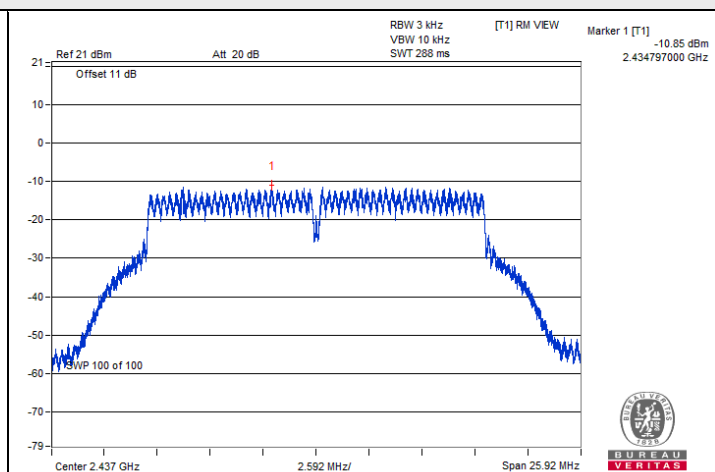

802.11g / Chain 1 : CH 6

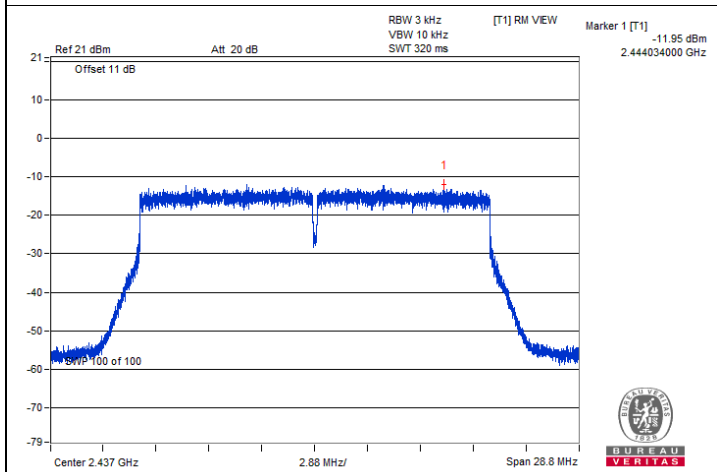

802.11ax (HE20) / Chain 0 : CH 6

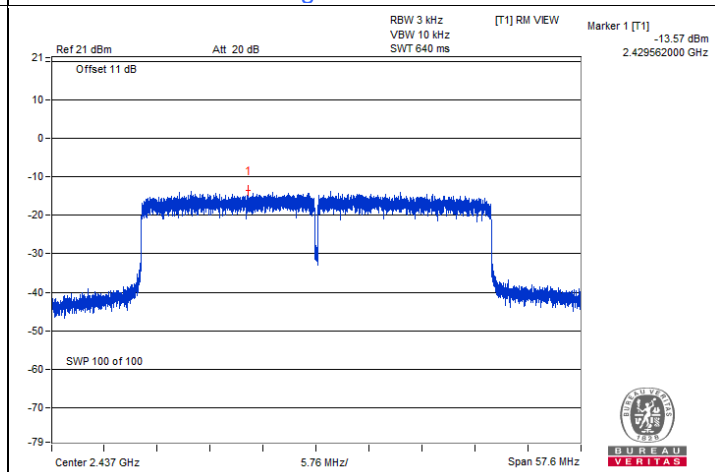

802.11ax (HE40) / Chain 3 : CH 6

7.3 6 dB Bandwidth

Input Power:	120 Vac, 60 Hz	Environmental Conditions:	25°C, 76% RH	Tested By:	Dalen Dai
--------------	----------------	---------------------------	--------------	------------	-----------

CDD

802.11b

Channel	Frequency (MHz)	6 dB Bandwidth (MHz)				Minimum Limit (MHz)	Test Result
		Chain 0	Chain 1	Chain 2	Chain 3		
1	2412	7.11	7.11	7.11	7.11	0.5	Pass
6	2437	7.11	7.09	7.11	7.12	0.5	Pass
11	2462	7.10	7.57	7.57	7.10	0.5	Pass

802.11g

Channel	Frequency (MHz)	6 dB Bandwidth (MHz)				Minimum Limit (MHz)	Test Result
		Chain 0	Chain 1	Chain 2	Chain 3		
1	2412	16.40	16.39	16.37	16.38	0.5	Pass
6	2437	16.38	16.38	16.41	16.41	0.5	Pass
11	2462	16.36	16.40	16.38	16.40	0.5	Pass

802.11ax (HE20)

Channel	Frequency (MHz)	6 dB Bandwidth (MHz)				Minimum Limit (MHz)	Test Result
		Chain 0	Chain 1	Chain 2	Chain 3		
1	2412	19.05	18.98	18.91	18.94	0.5	Pass
6	2437	19.01	18.99	18.95	18.96	0.5	Pass
11	2462	18.98	18.79	18.94	18.50	0.5	Pass

802.11ax (HE40)

Channel	Frequency (MHz)	6 dB Bandwidth (MHz)				Minimum Limit (MHz)	Test Result
		Chain 0	Chain 1	Chain 2	Chain 3		
3	2422	37.98	37.94	37.89	38.04	0.5	Pass
6	2437	38.06	37.98	37.98	38.00	0.5	Pass
9	2452	37.75	37.90	38.06	37.86	0.5	Pass

Spectrum Plot of Minimum Value

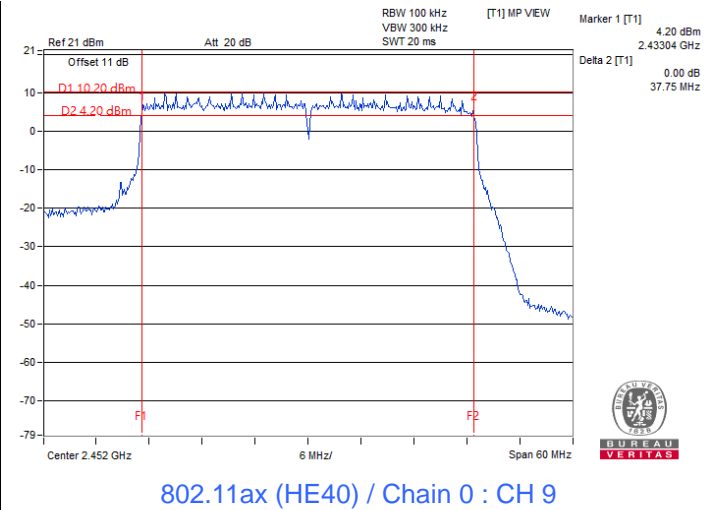
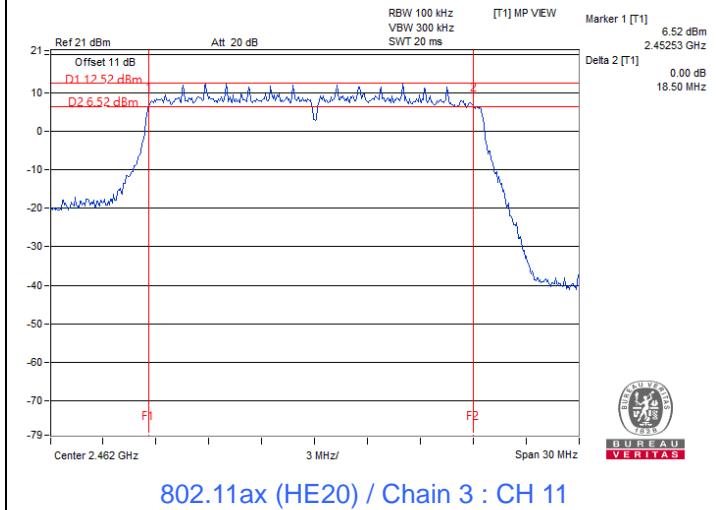
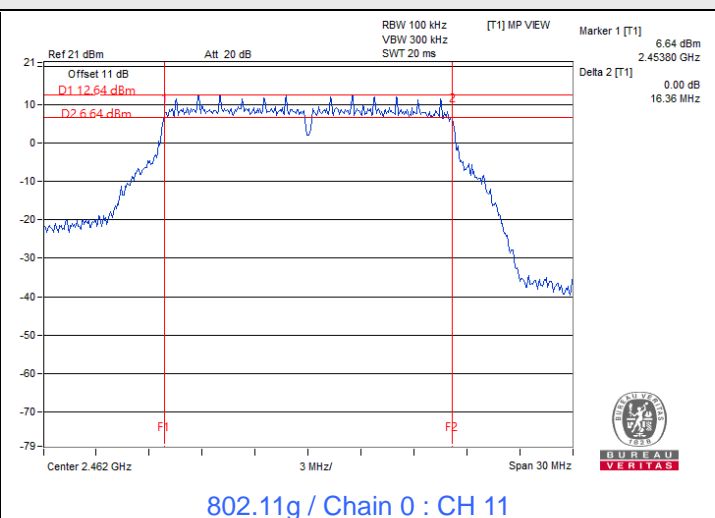
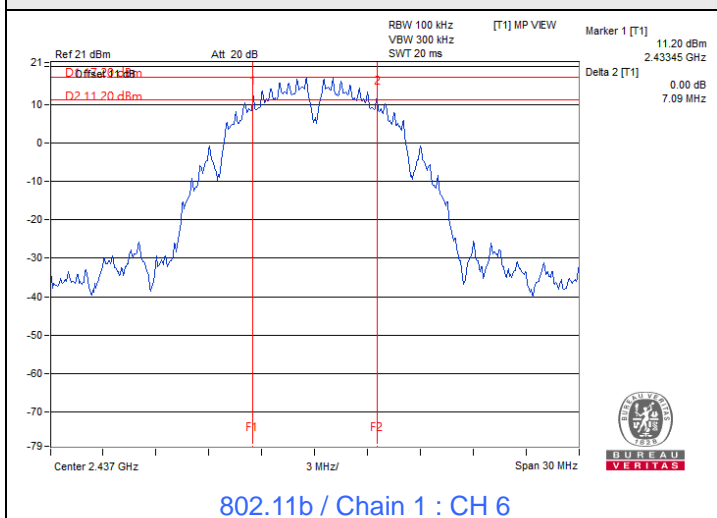



7.4 Conducted Out of Band Emissions

Input Power:	120 Vac, 60 Hz	Environmental Conditions:	25°C, 76% RH	Tested By:	Dalen Dai
--------------	----------------	---------------------------	--------------	------------	-----------

CDD

802.11b

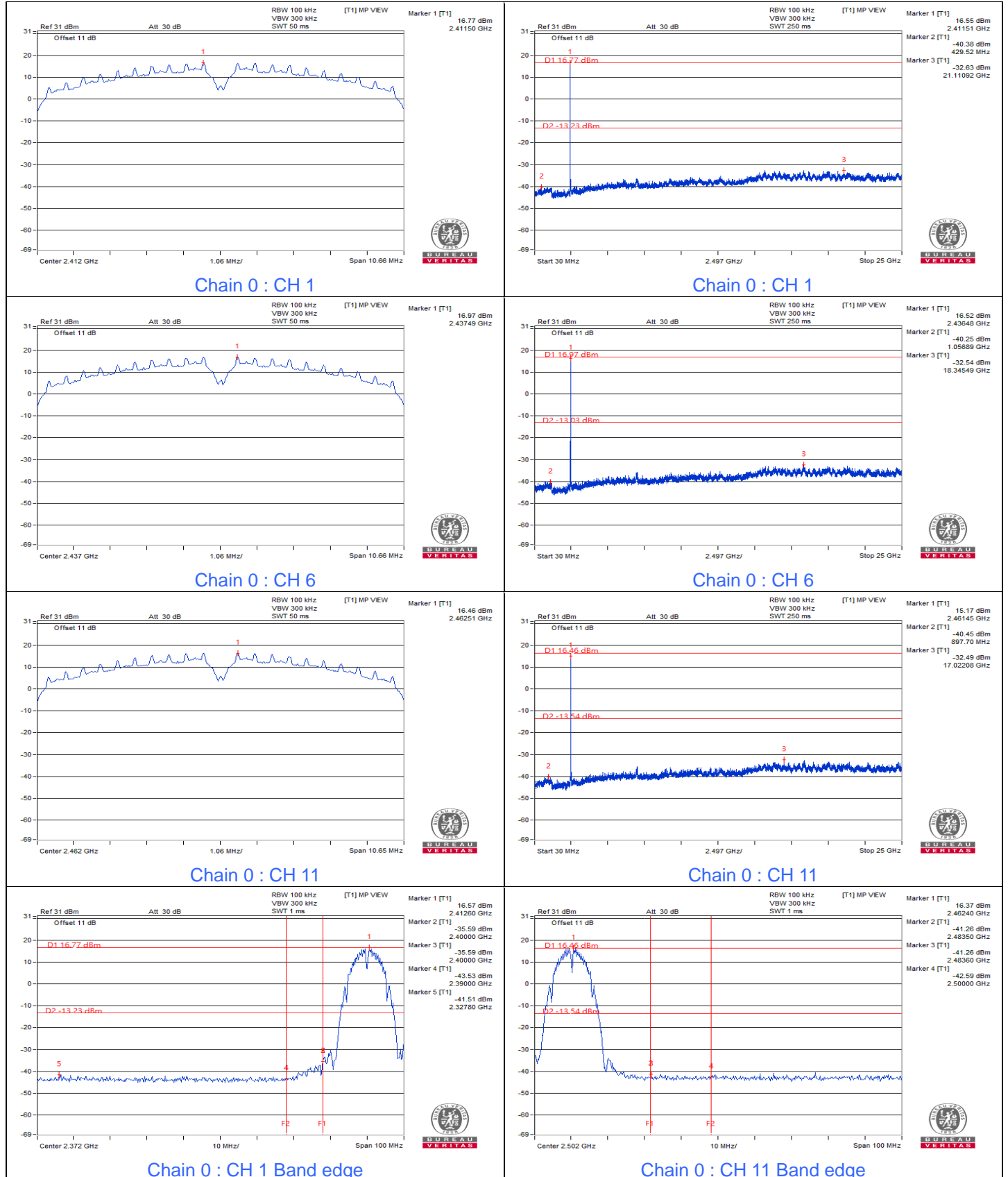

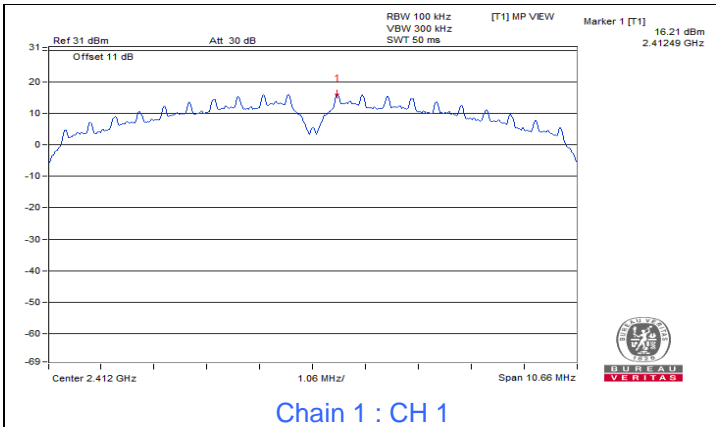

Chain 1 : CH 1

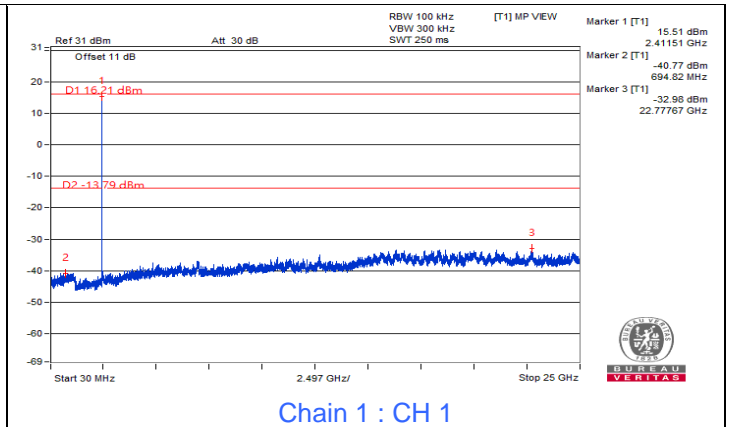

Chain 1 : CH 1

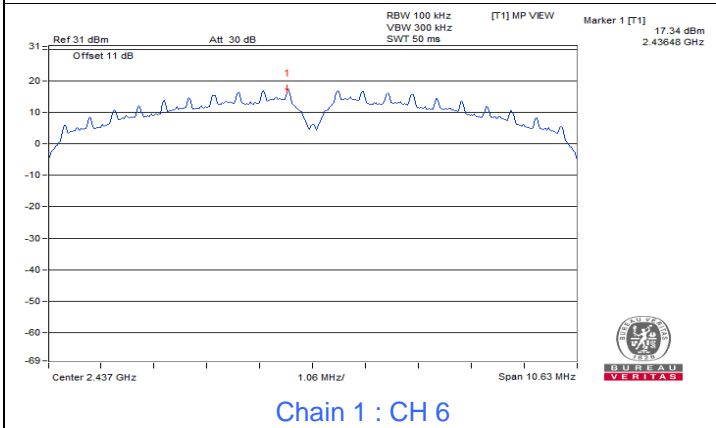

Chain 1 : CH 6

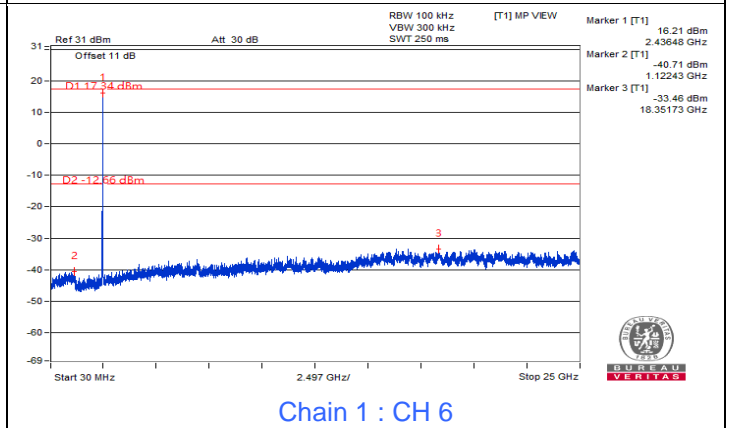

Chain 1 : CH 6

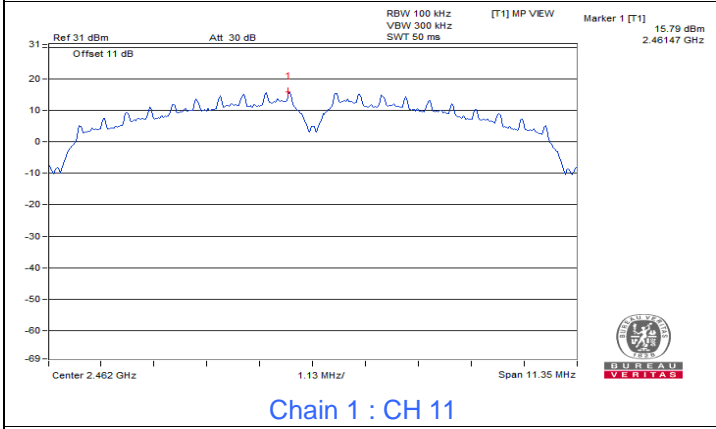

Chain 1 : CH 11

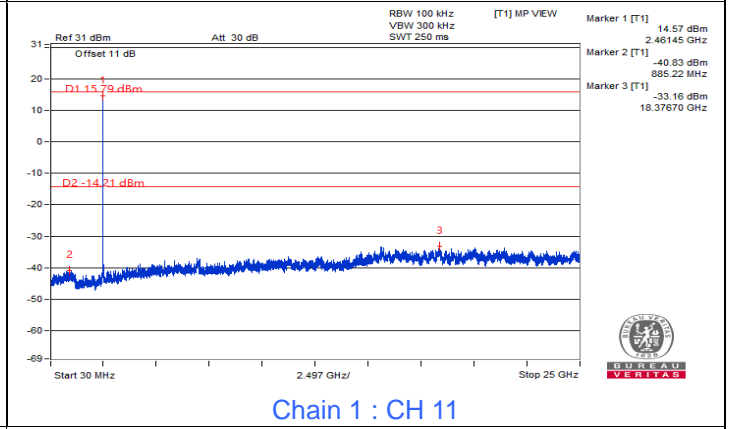

Chain 1 : CH 11

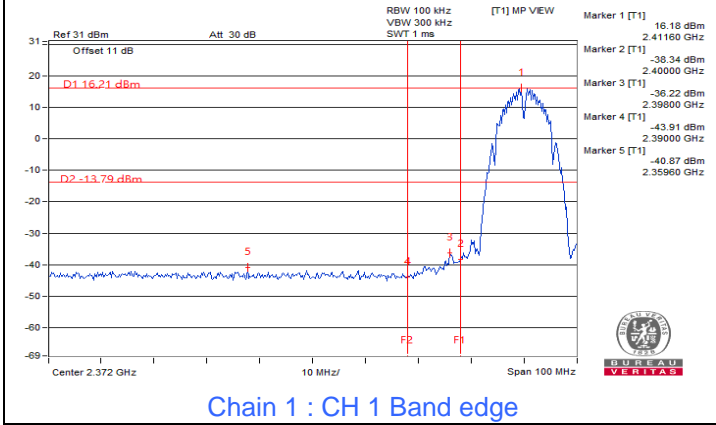

Chain 1 : CH 1 Band edge

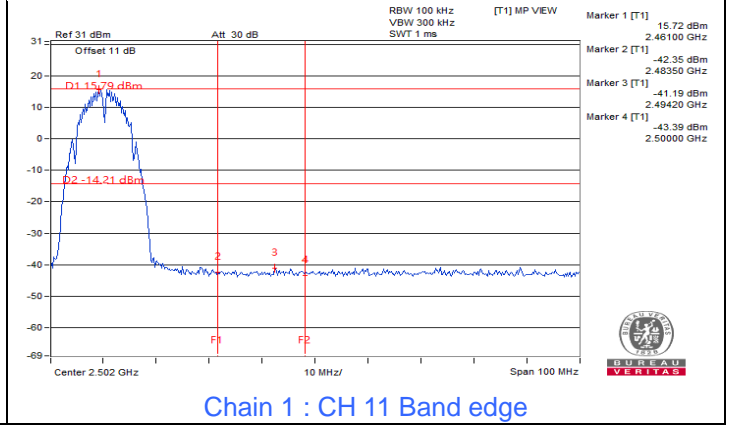

Chain 1 : CH 11 Band edge

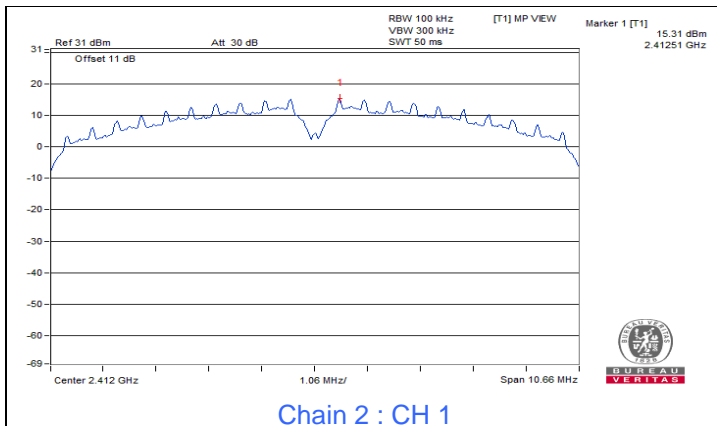

Chain 2 : CH 1

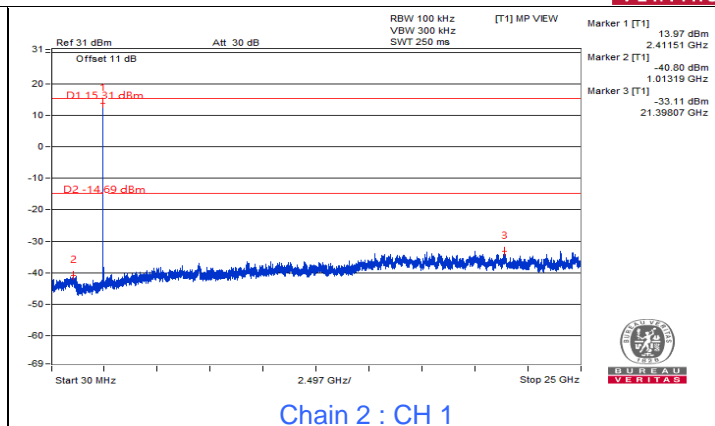

Chain 2 : CH 1

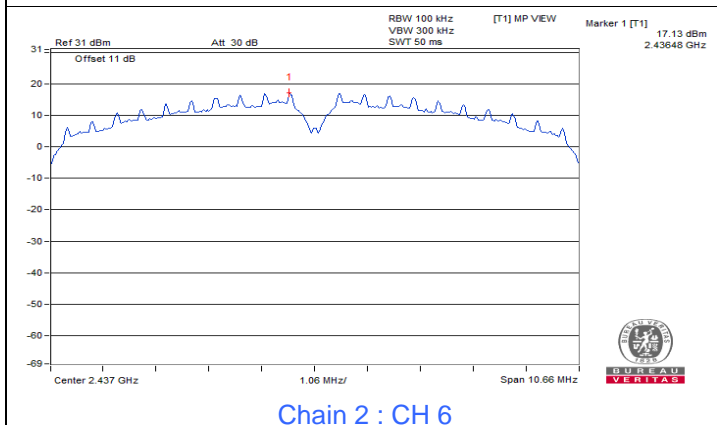

Chain 2 : CH 6

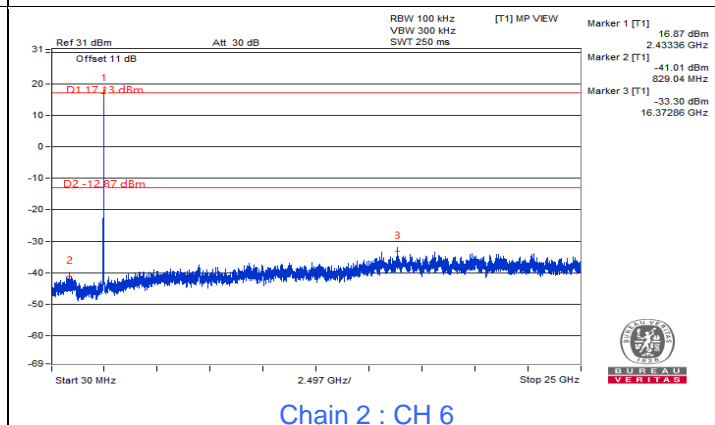

Chain 2 : CH 6

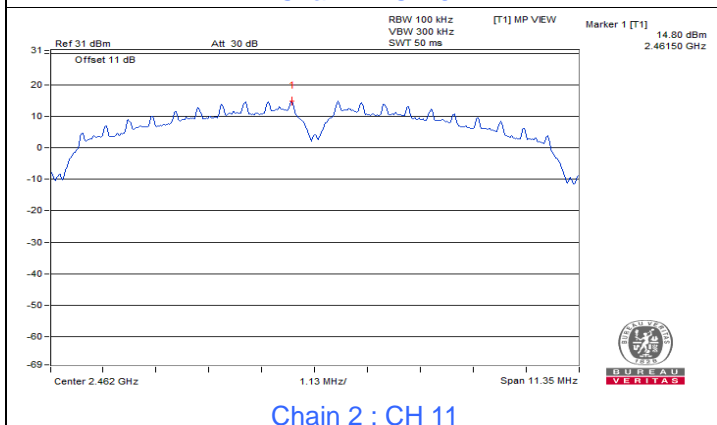

Chain 2 : CH 11

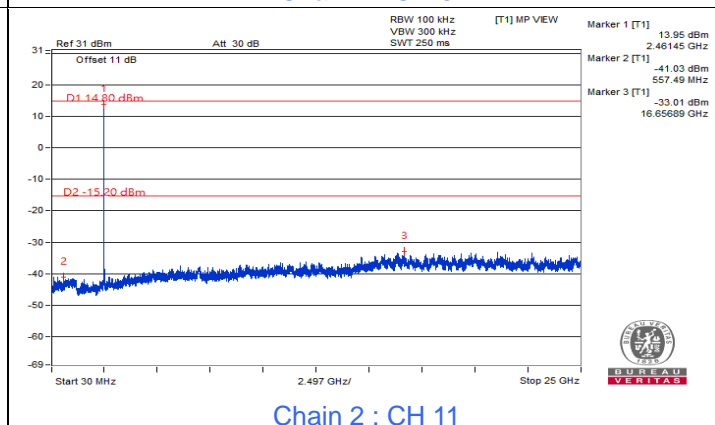

Chain 2 : CH 11

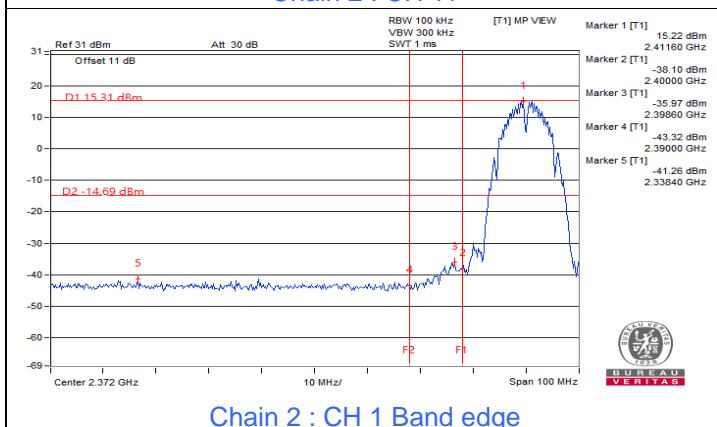

Chain 2 : CH 1 Band edge

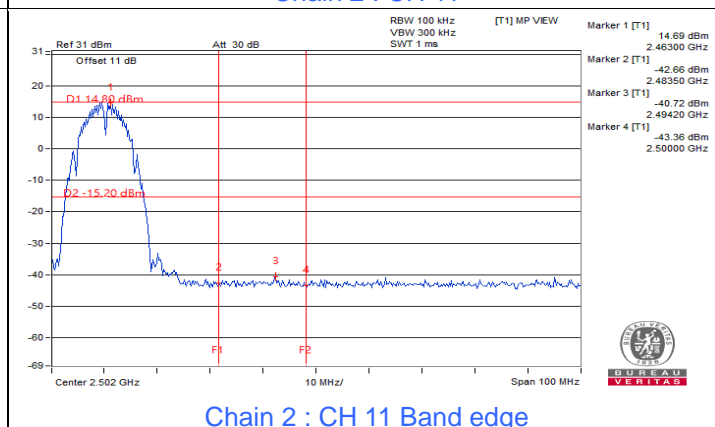

Chain 2 : CH 11 Band edge

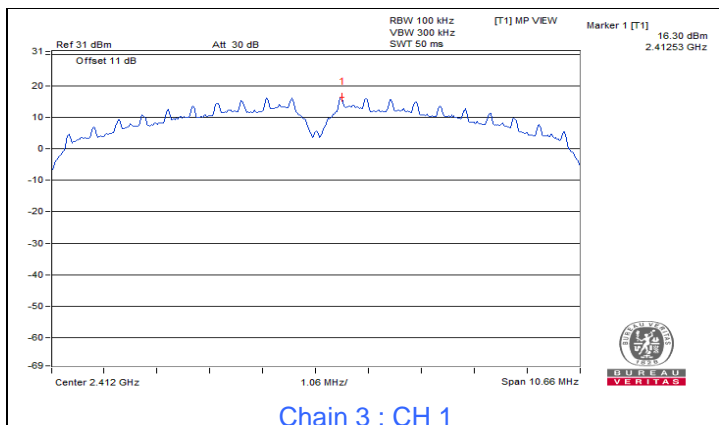

Chain 3 : CH 1

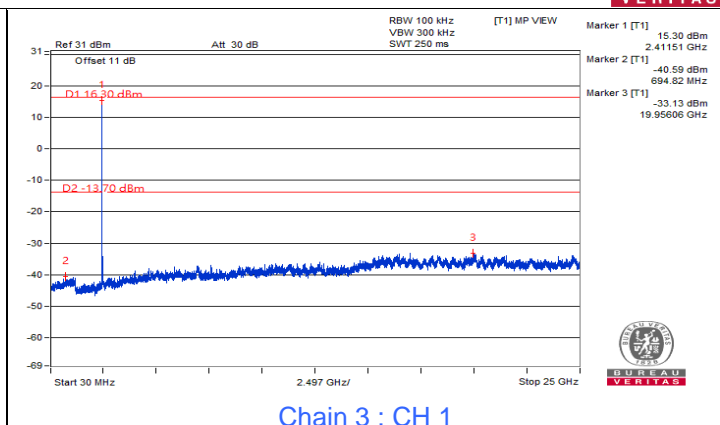

Chain 3 : CH 1

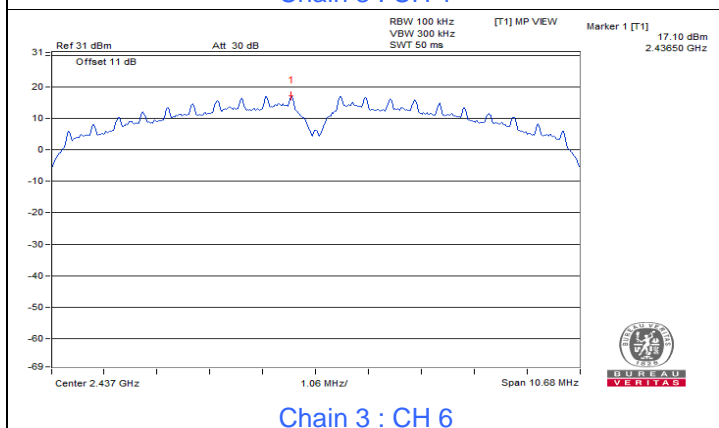

Chain 3 : CH 6

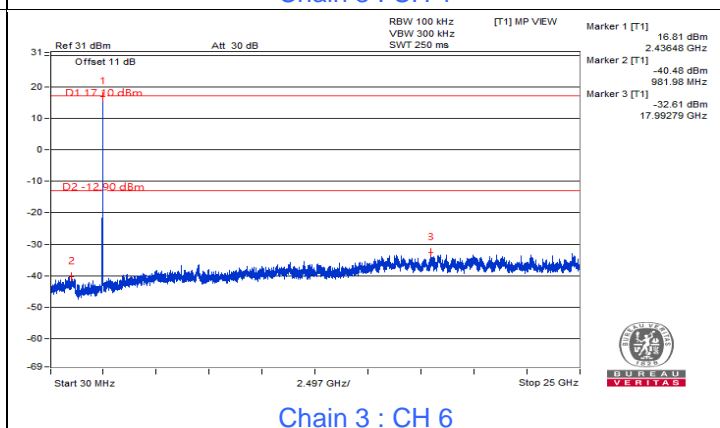

Chain 3 : CH 6

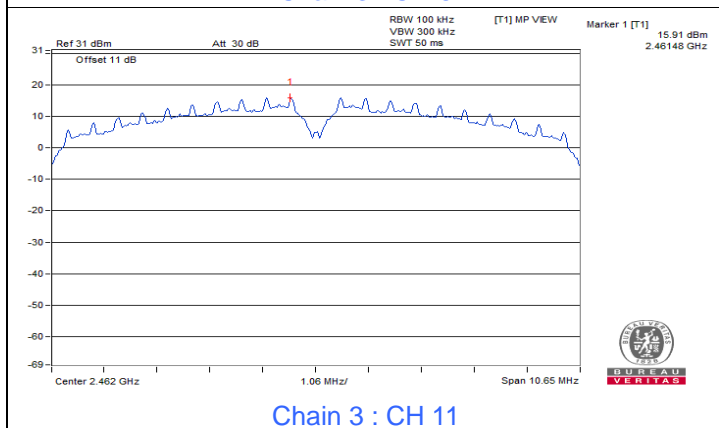

Chain 3 : CH 11

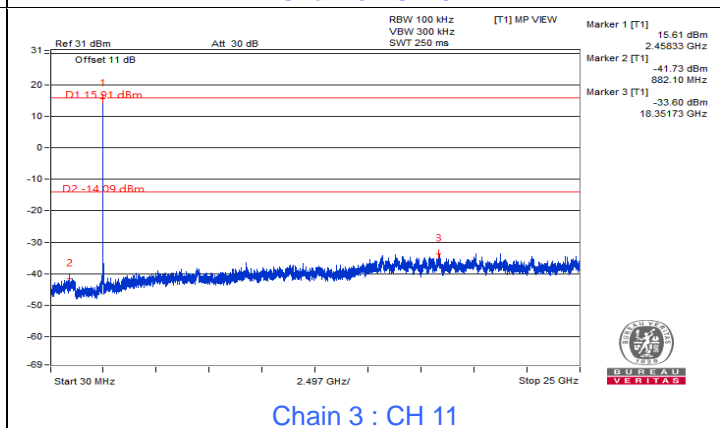

Chain 3 : CH 11

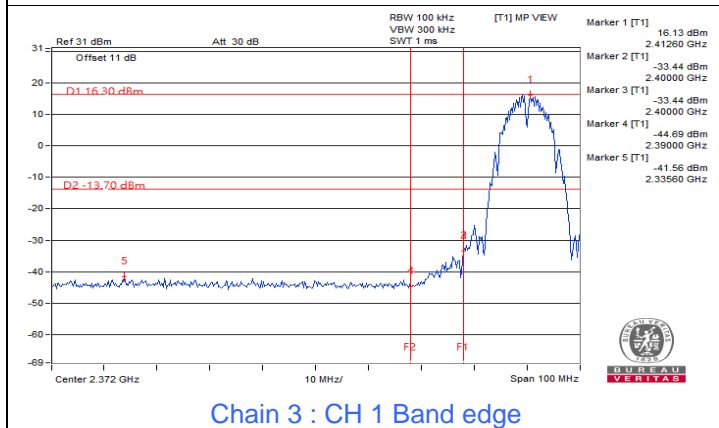

Chain 3 : CH 1 Band edge

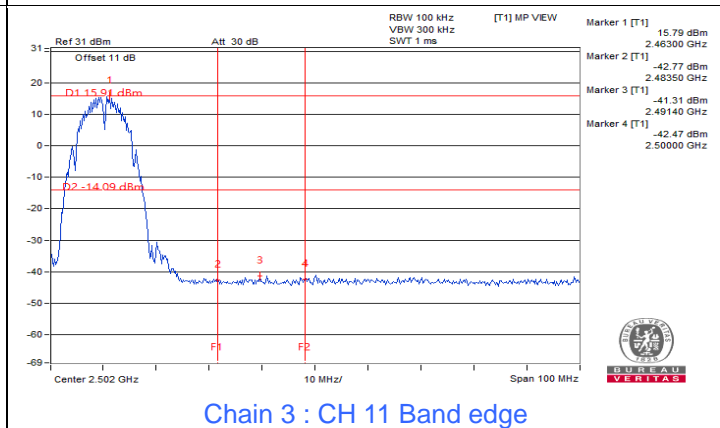

Chain 3 : CH 11 Band edge



802.11g

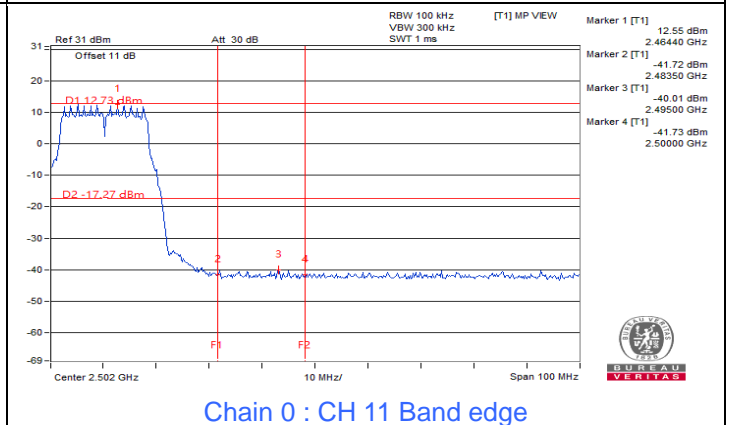
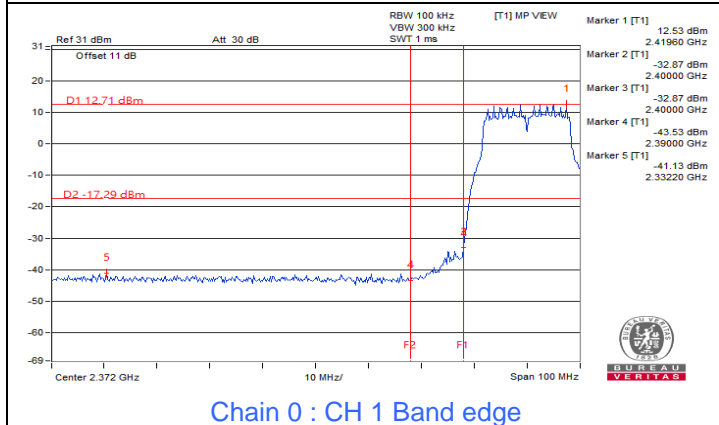
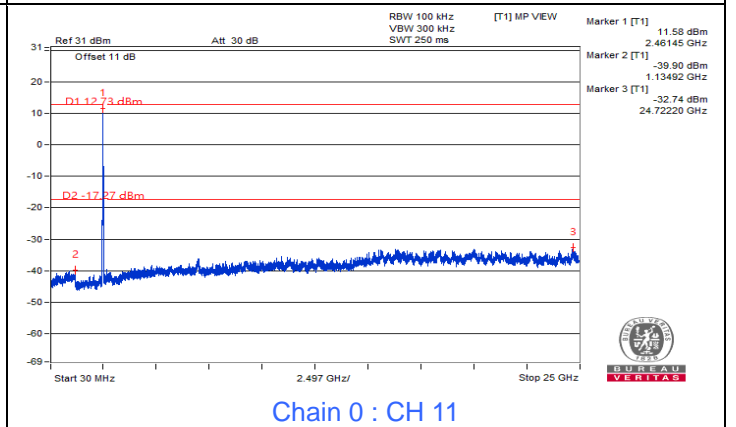
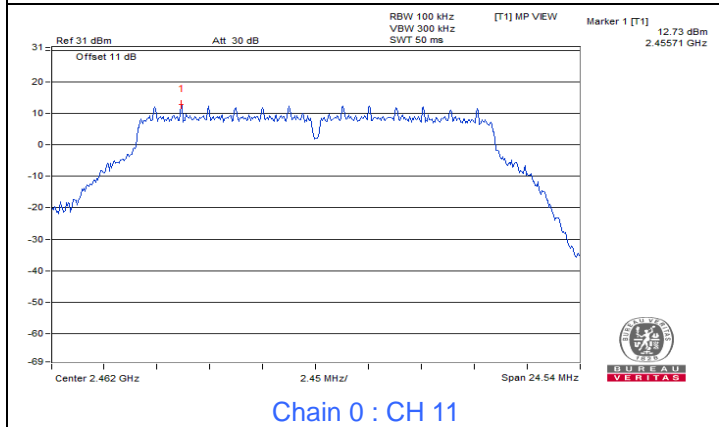
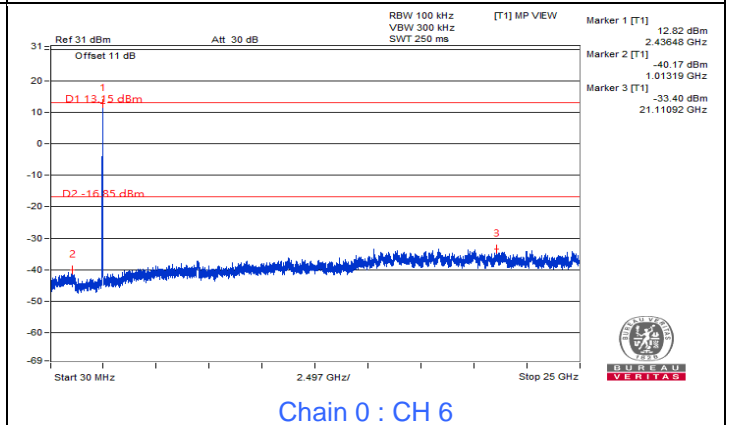
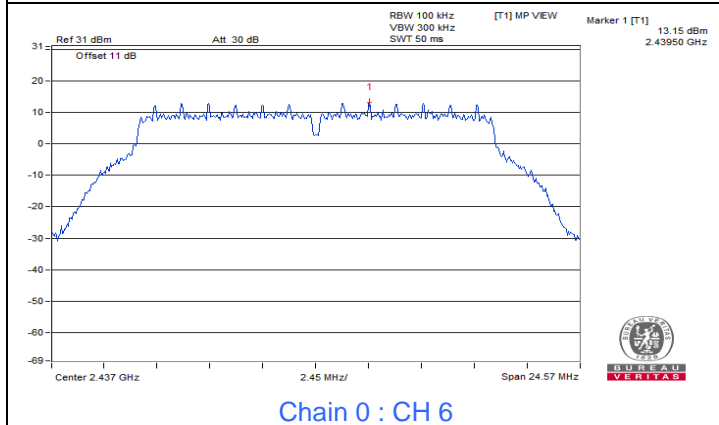
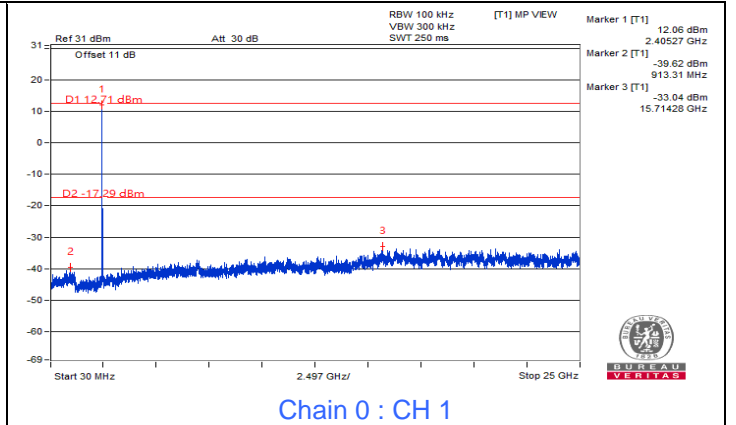
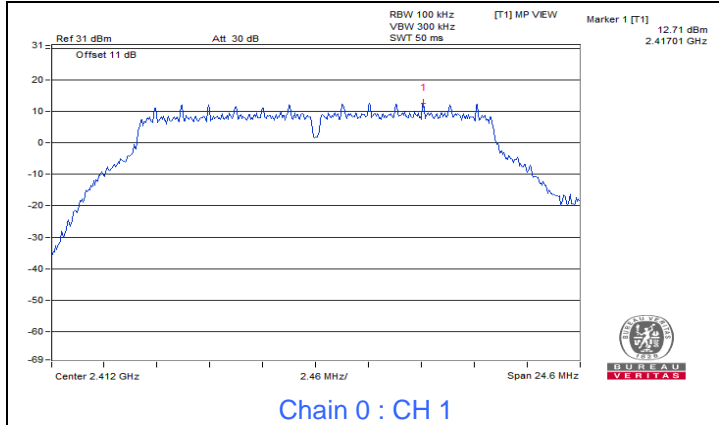

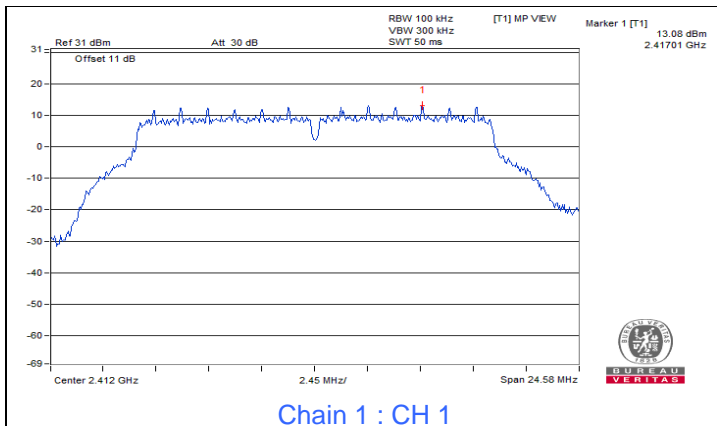

Chain 1 : CH 1

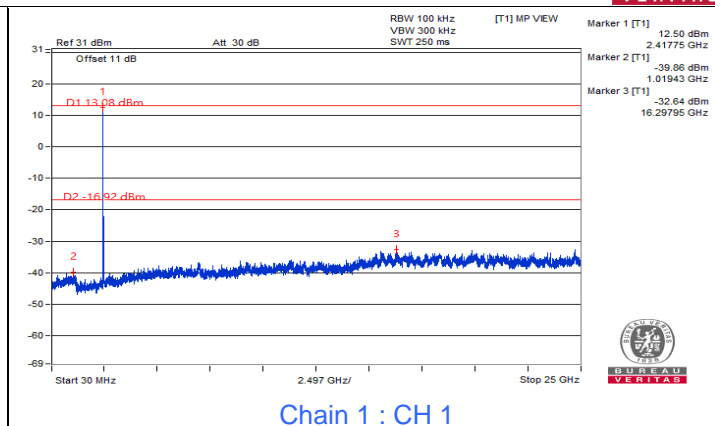

Chain 1 : CH 1

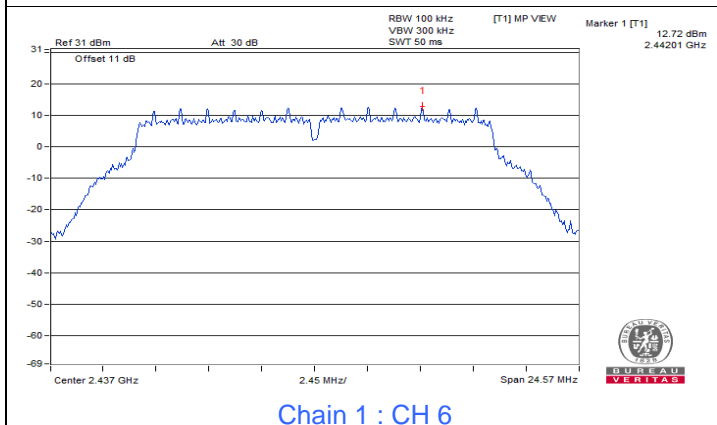

Chain 1 : CH 6

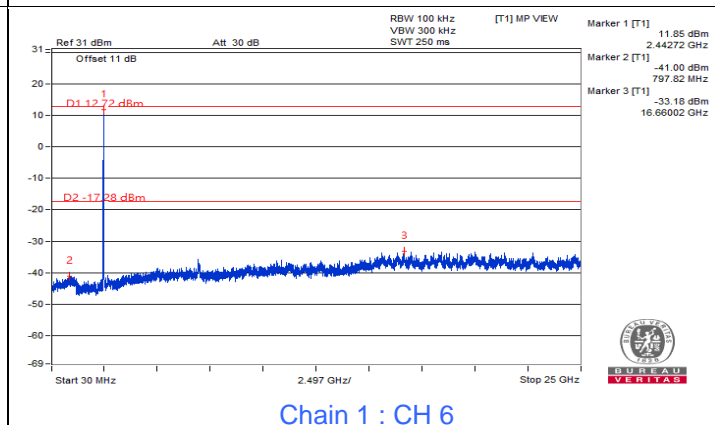

Chain 1 : CH 6

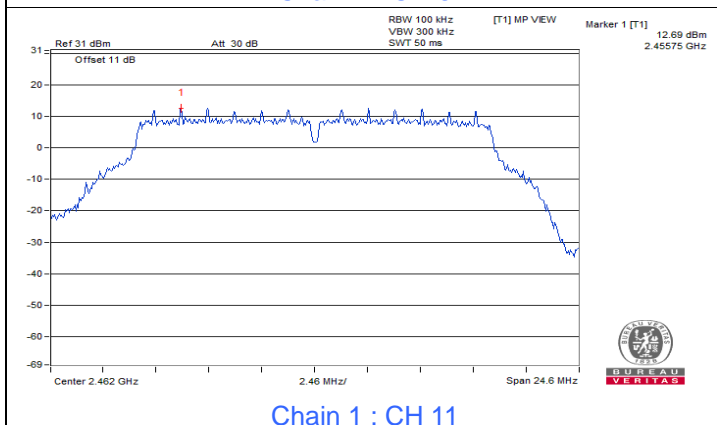

Chain 1 : CH 11

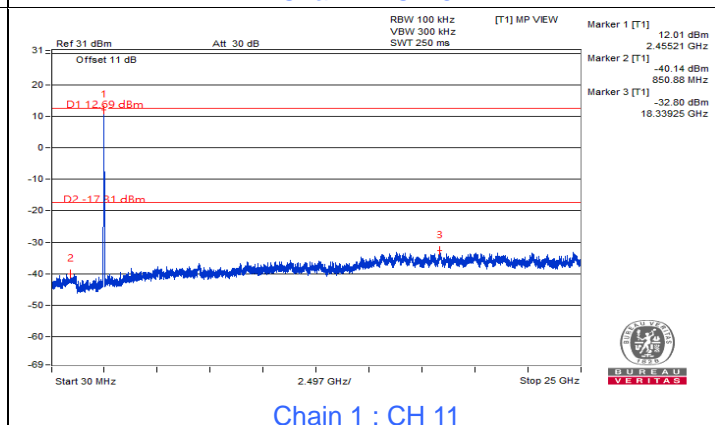

Chain 1 : CH 11

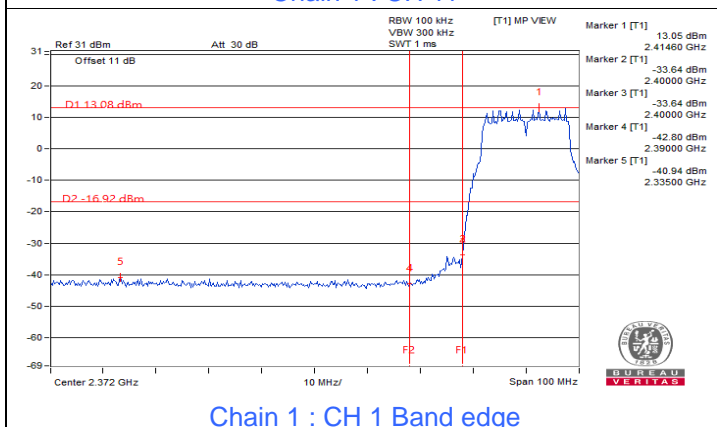

Chain 1 : CH 1 Band edge

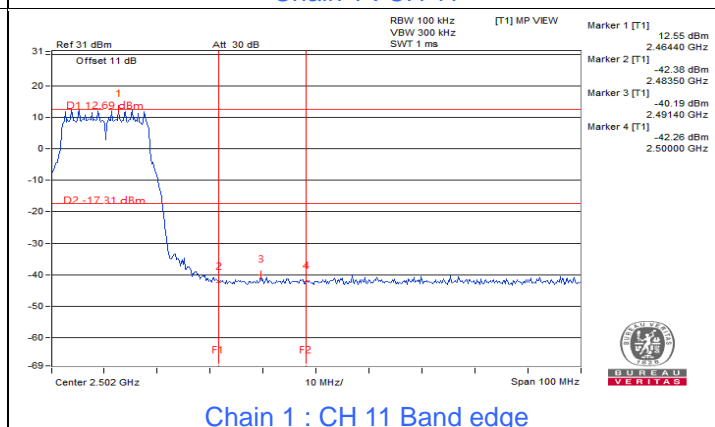

Chain 1 : CH 11 Band edge

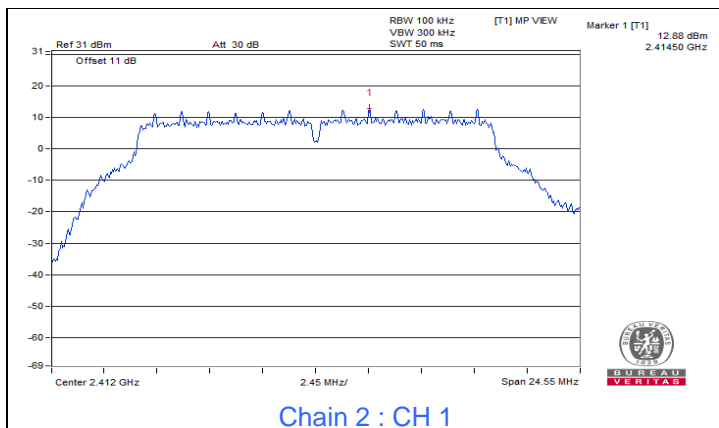

Chain 2 : CH 1

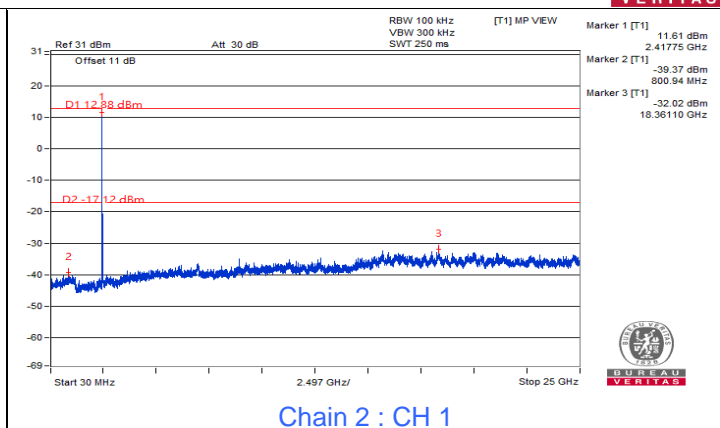

Chain 2 : CH 1

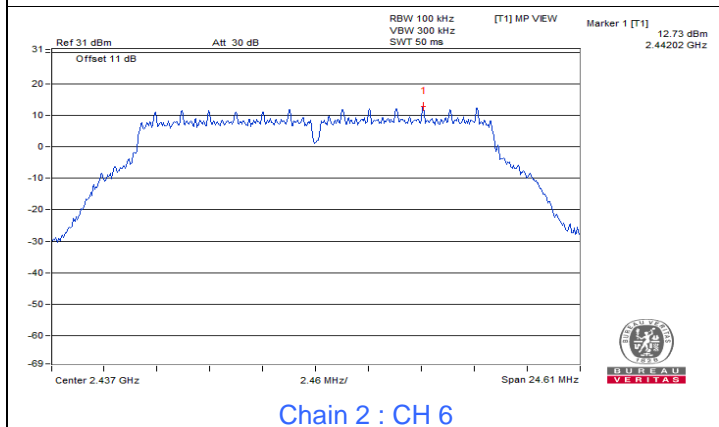

Chain 2 : CH 6

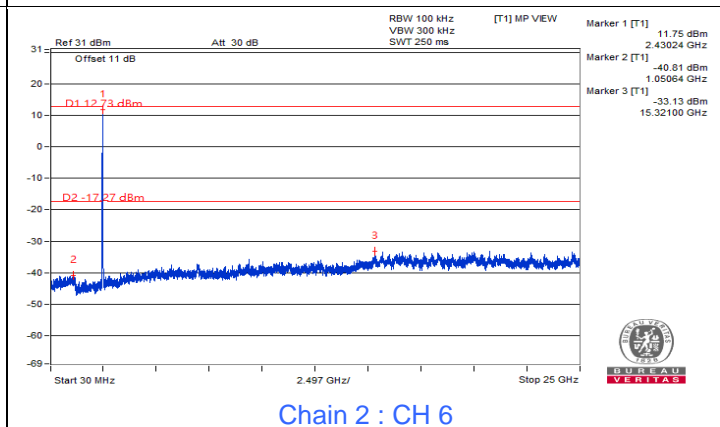

Chain 2 : CH 6

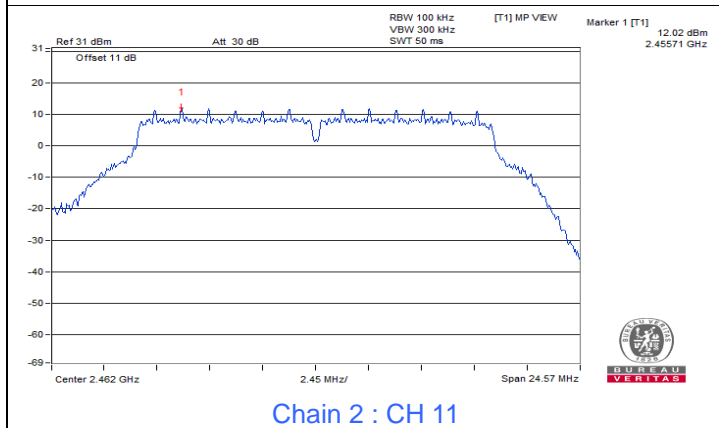

Chain 2 : CH 11

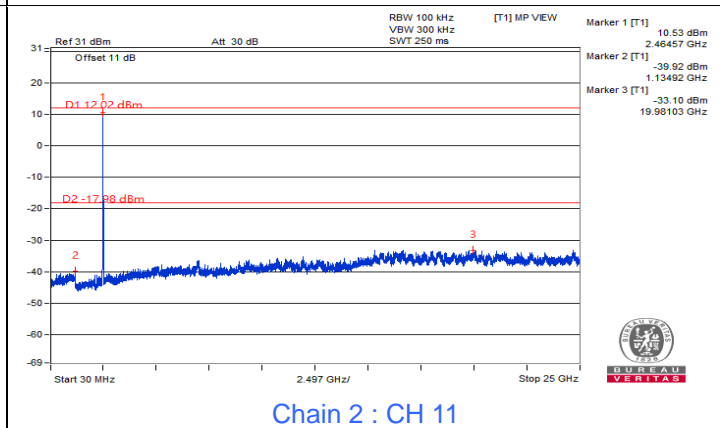

Chain 2 : CH 11

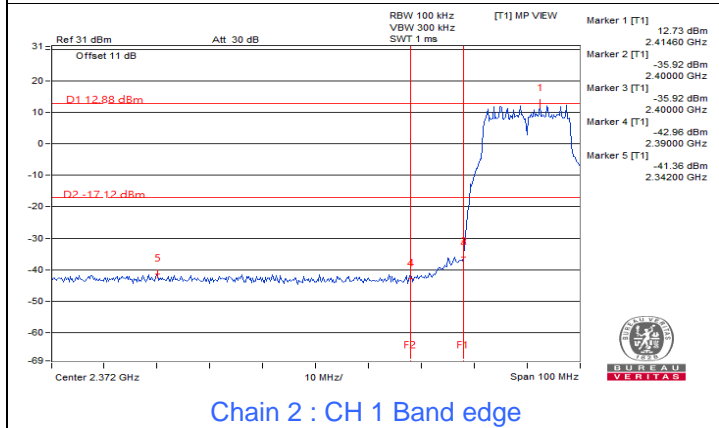

Chain 2 : CH 1 Band edge

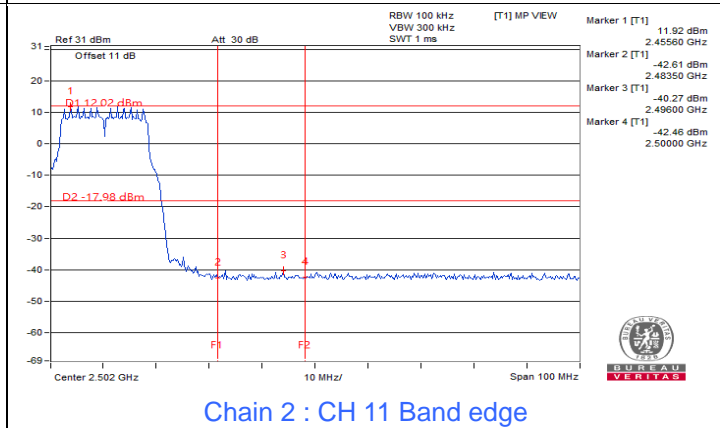

Chain 2 : CH 11 Band edge

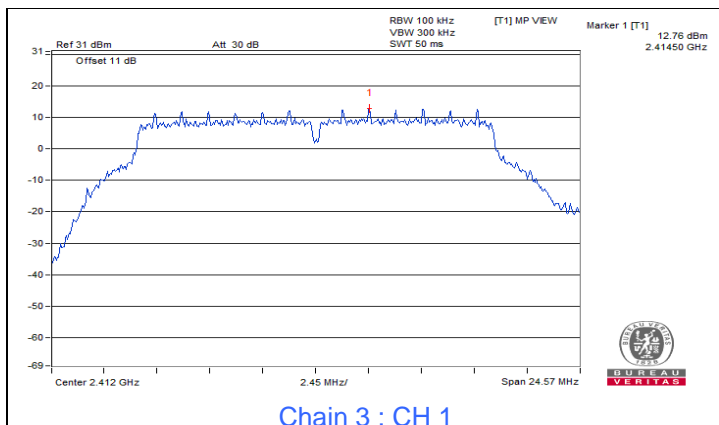

Chain 3 : CH 1

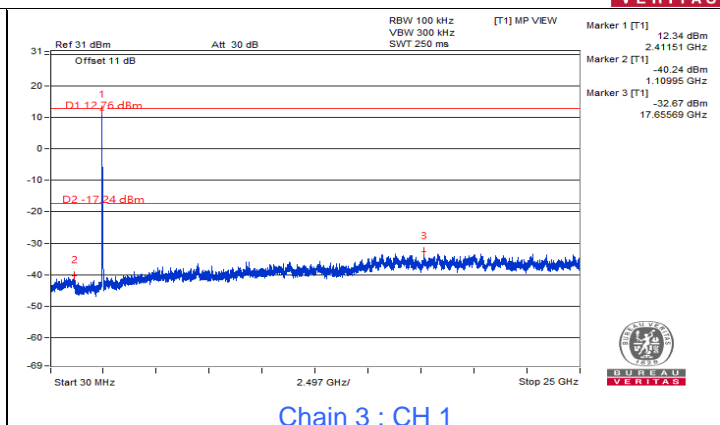

Chain 3 : CH 1

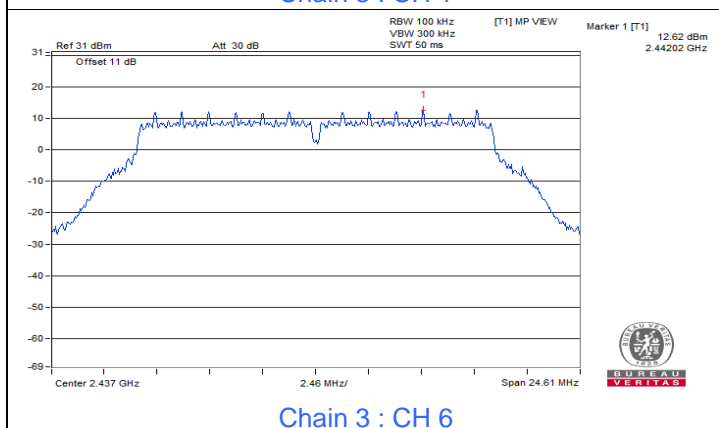

Chain 3 : CH 6

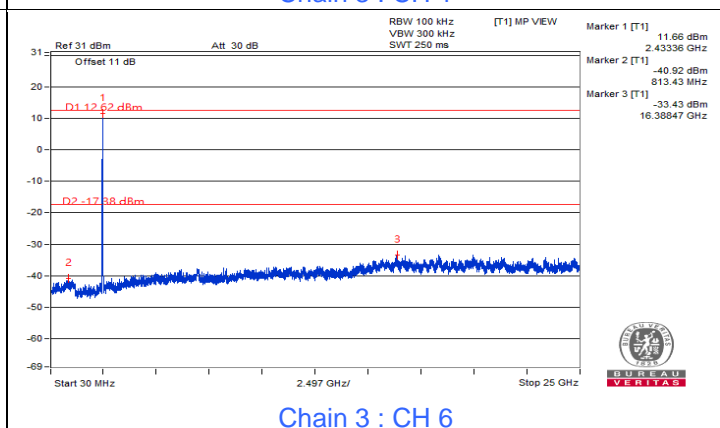

Chain 3 : CH 6

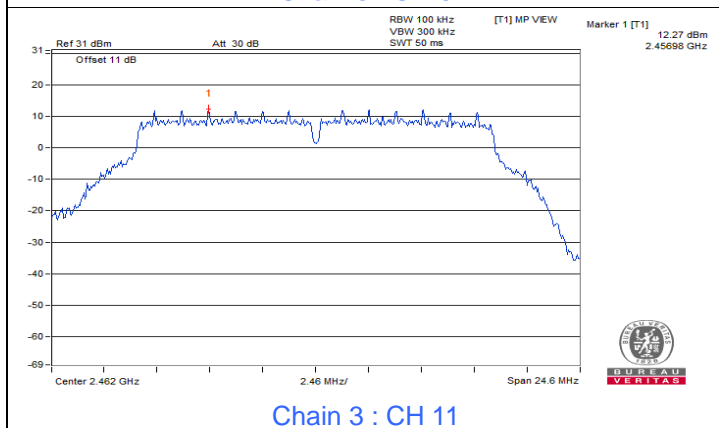

Chain 3 : CH 11

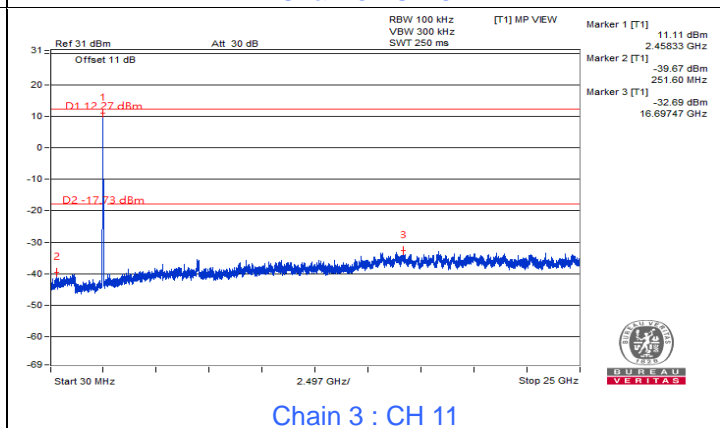

Chain 3 : CH 11

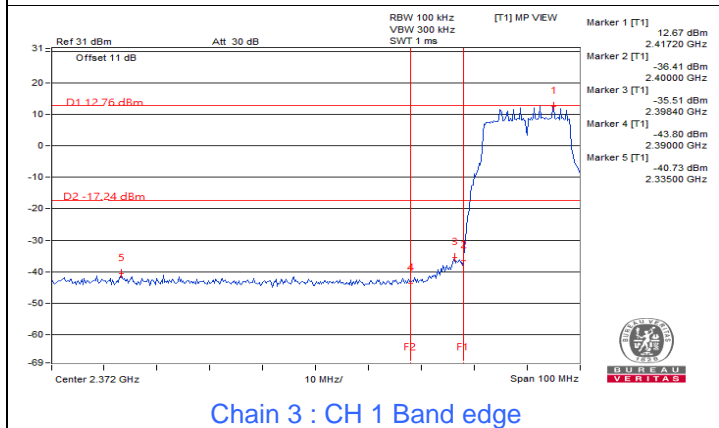

Chain 3 : CH 1 Band edge

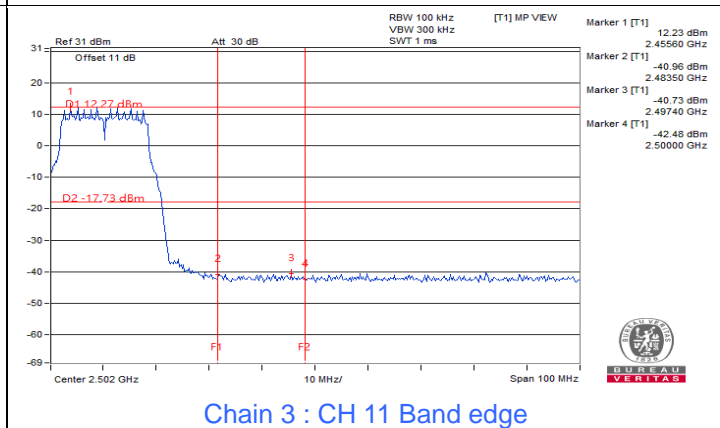

Chain 3 : CH 11 Band edge



802.11ax (HE20)

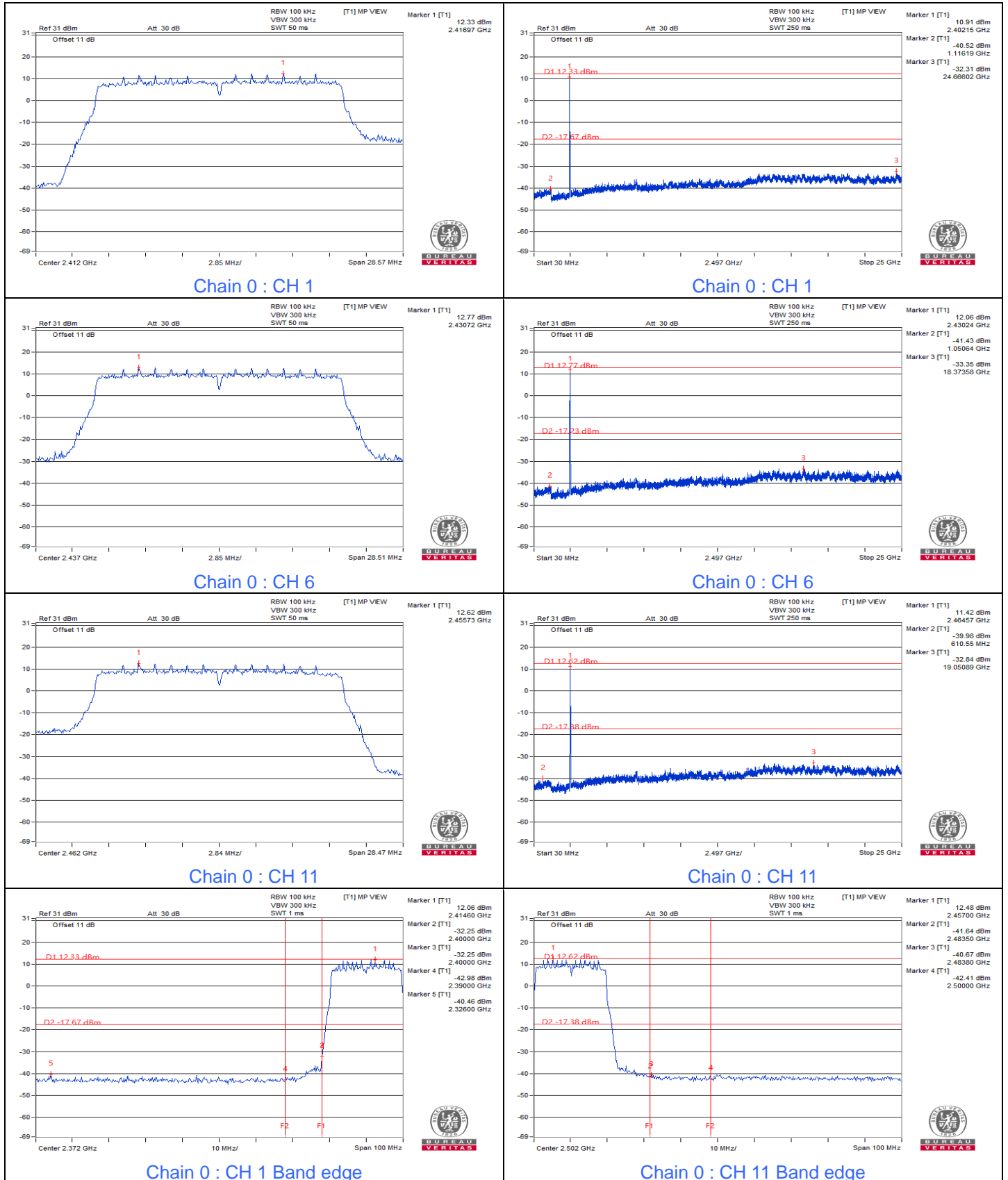

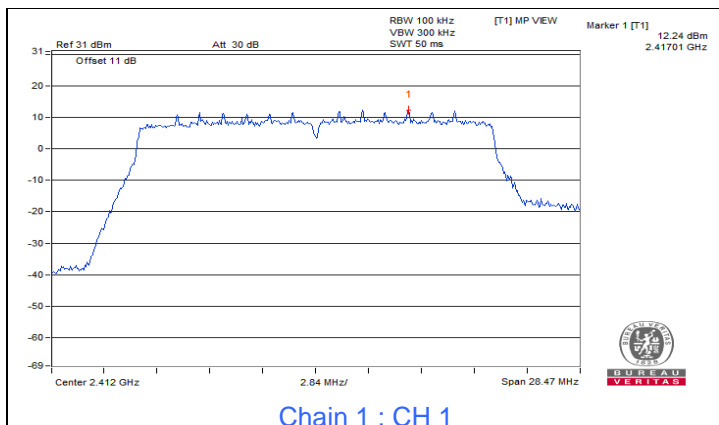

Chain 1 : CH 1

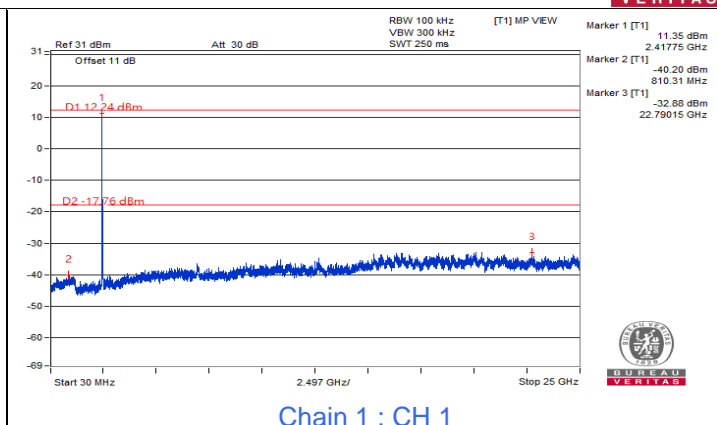

Chain 1 : CH 1

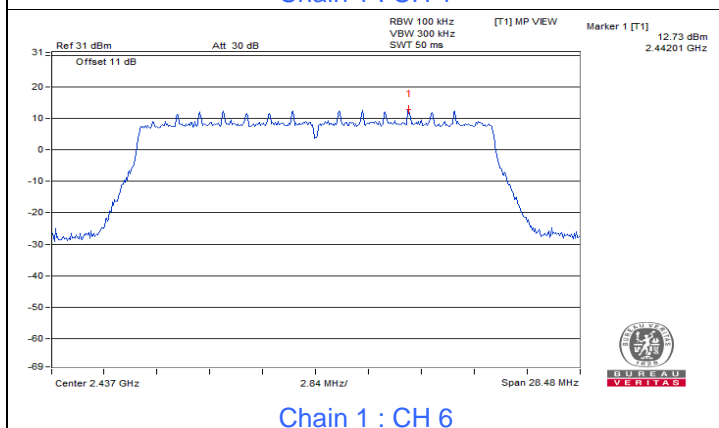

Chain 1 : CH 6

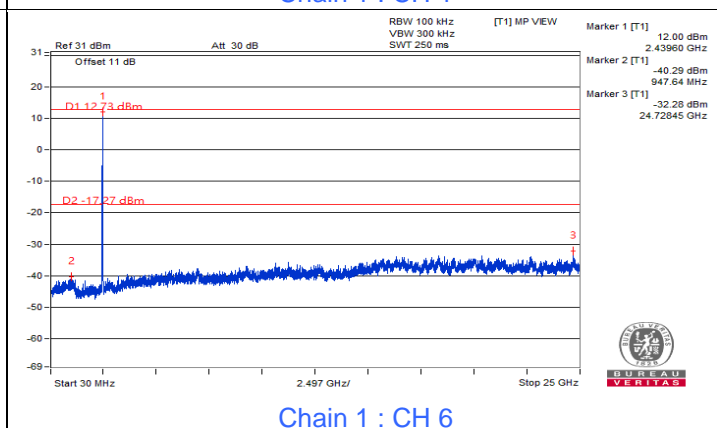

Chain 1 : CH 6

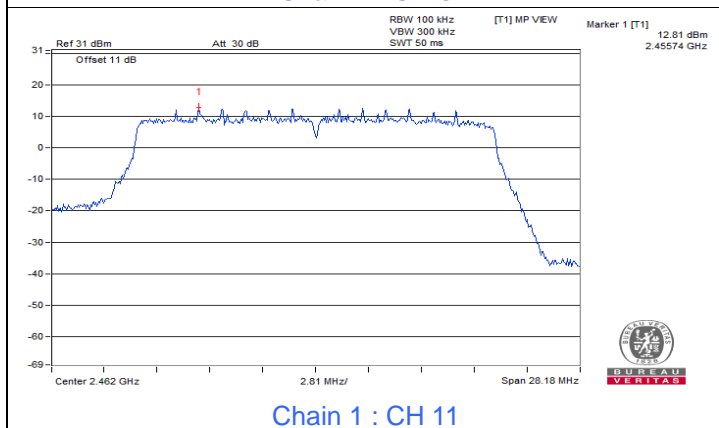

Chain 1 : CH 11

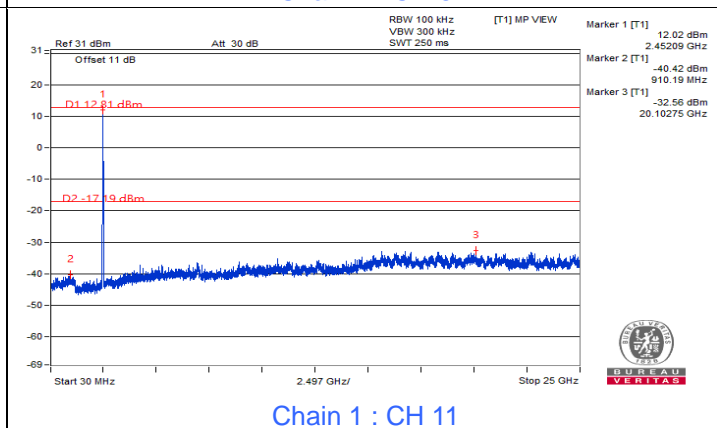

Chain 1 : CH 11

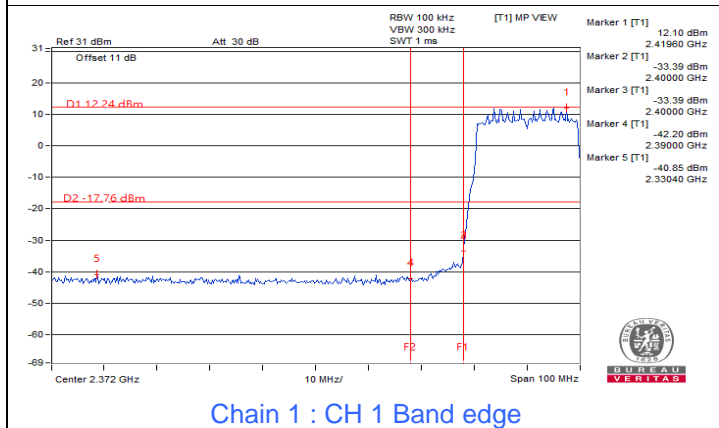

Chain 1 : CH 1 Band edge

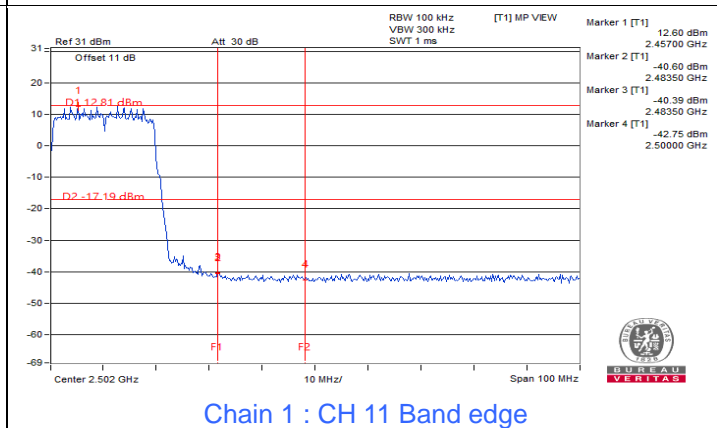

Chain 1 : CH 11 Band edge

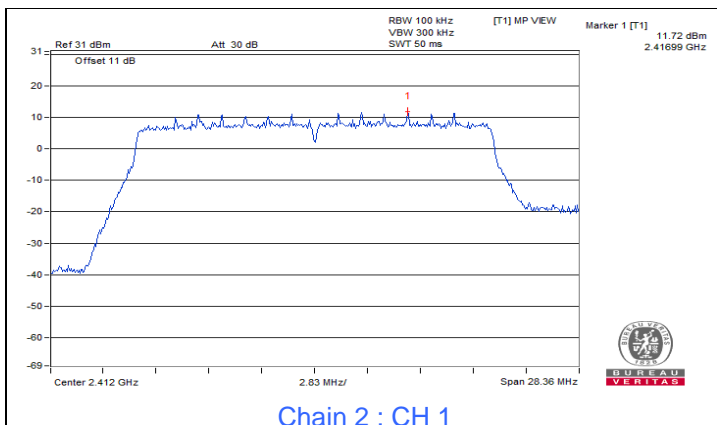

Chain 2 : CH 1

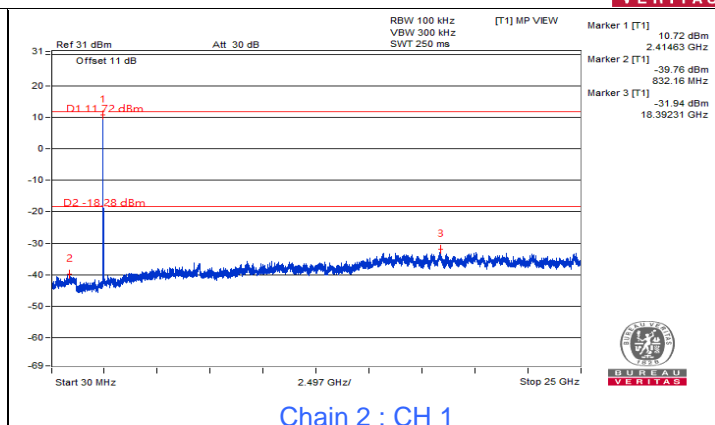

Chain 2 : CH 1

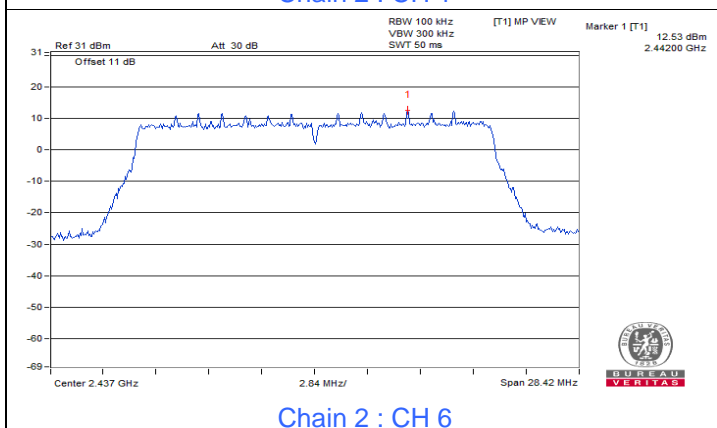

Chain 2 : CH 6

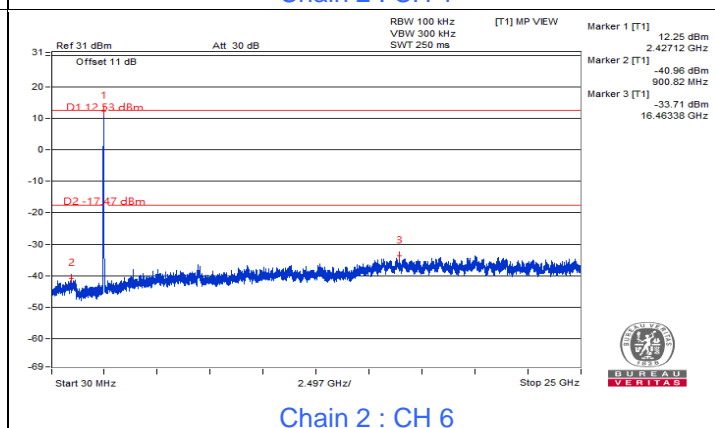

Chain 2 : CH 6

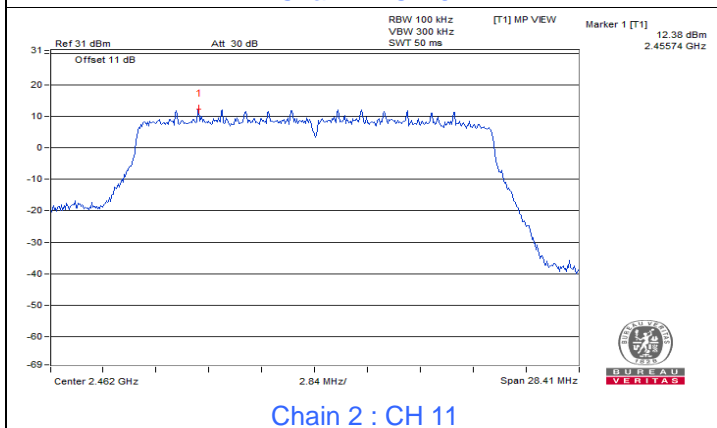

Chain 2 : CH 11

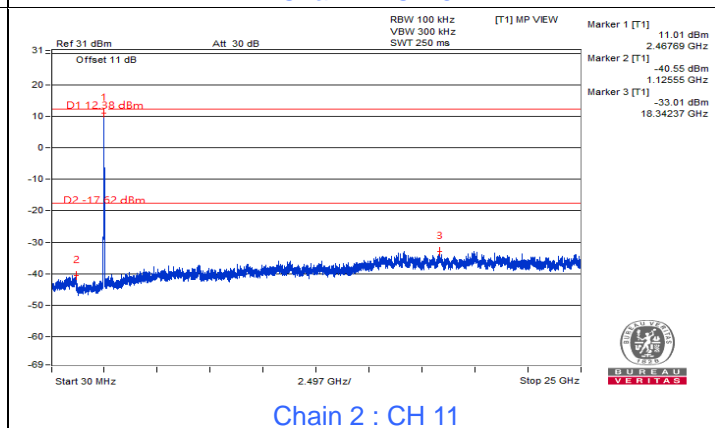

Chain 2 : CH 11

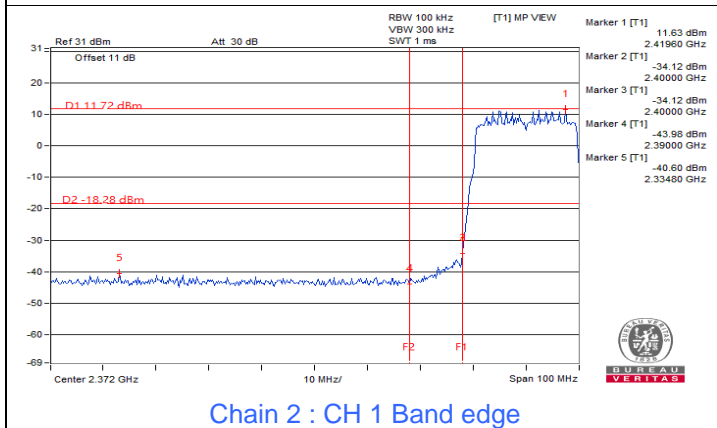

Chain 2 : CH 1 Band edge

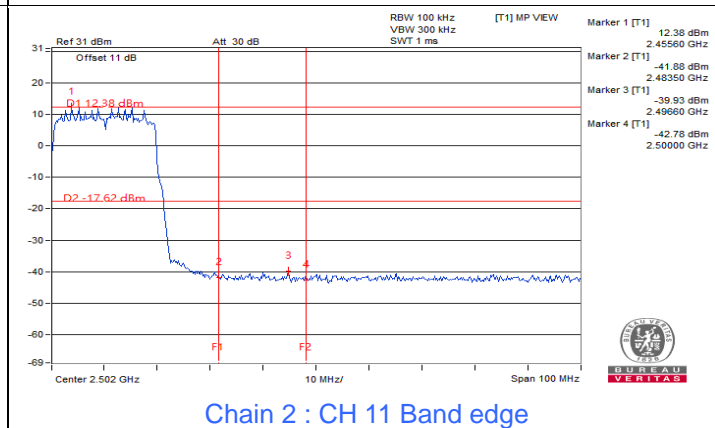

Chain 2 : CH 11 Band edge

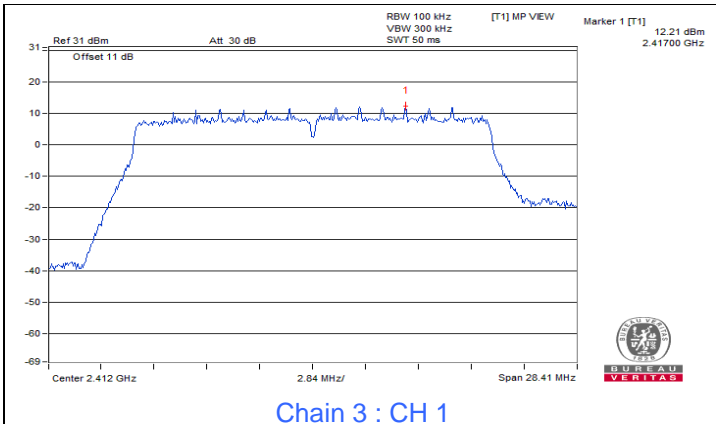

Chain 3 : CH 1

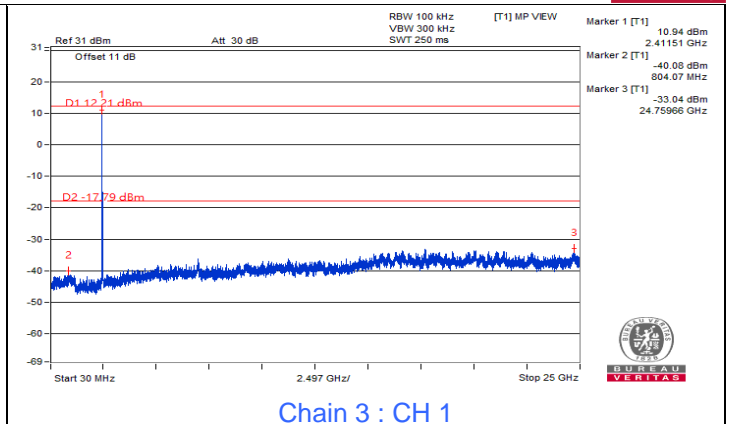

Chain 3 : CH 1

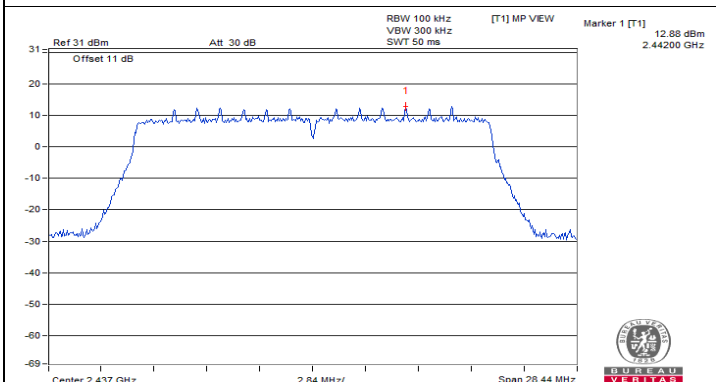

Chain 3 : CH 6

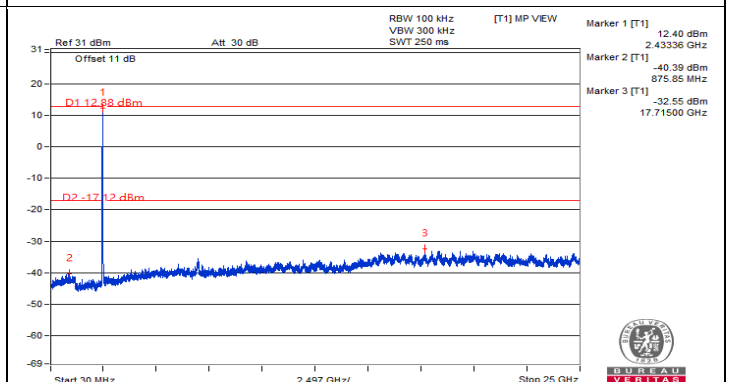

Chain 3 : CH 6

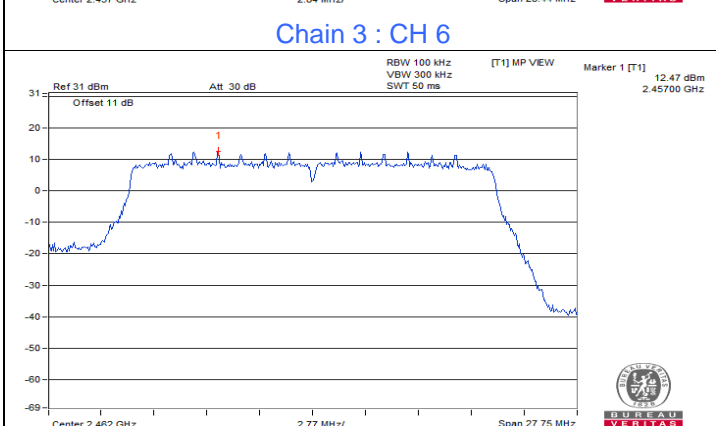

Chain 3 : CH 11

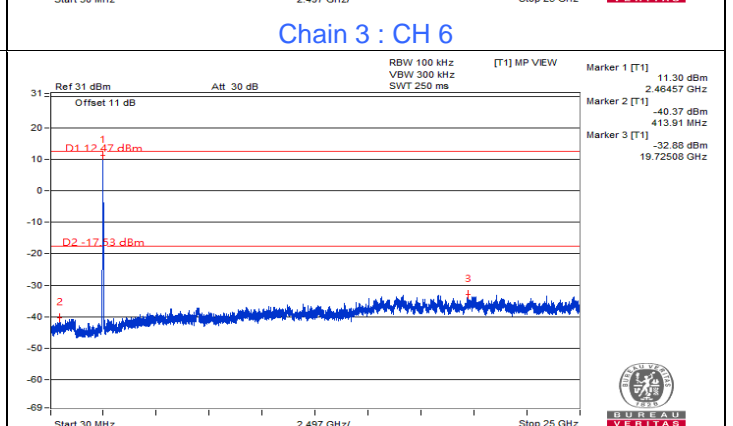

Chain 3 : CH 11

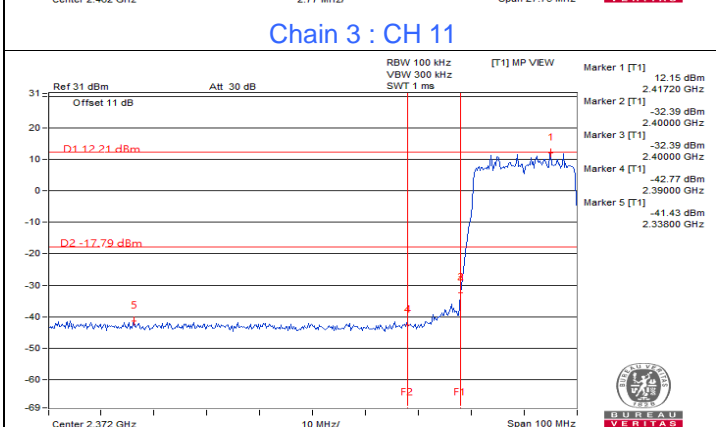

Chain 3 : CH 1 Band edge

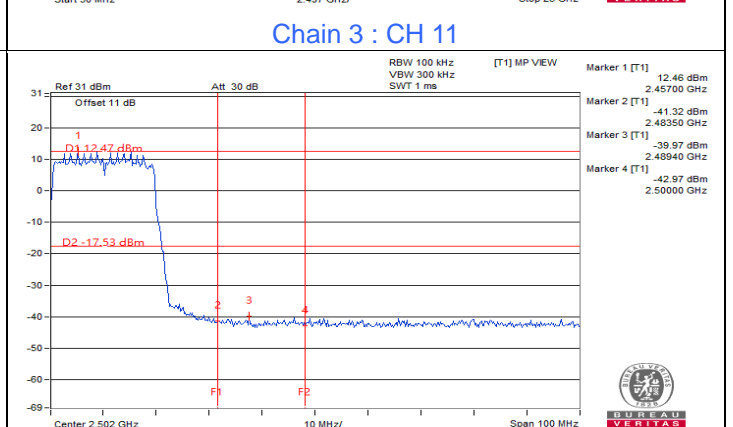

Chain 3 : CH 11 Band edge



BUREAU VERITAS

802.11ax (HE40)

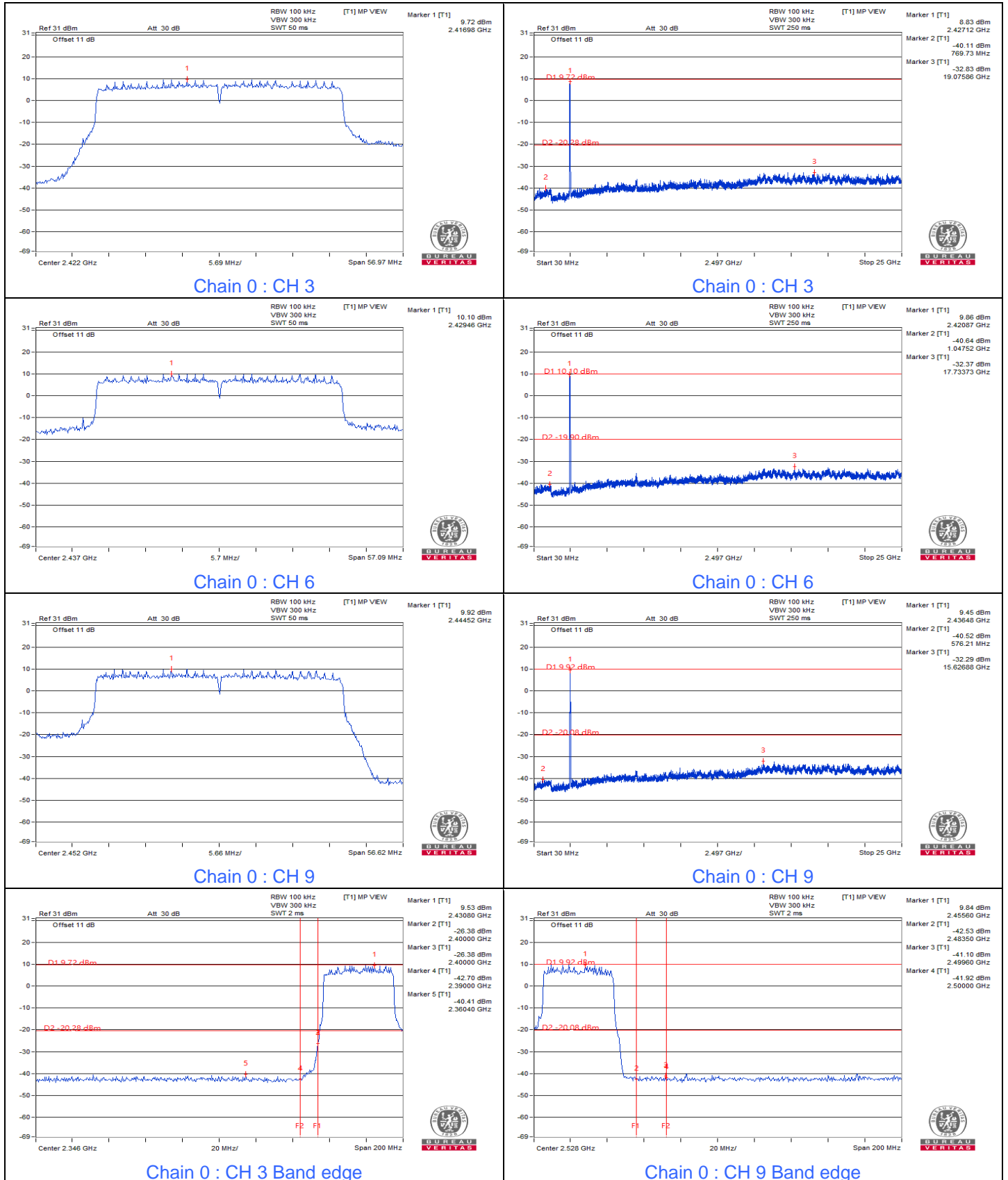

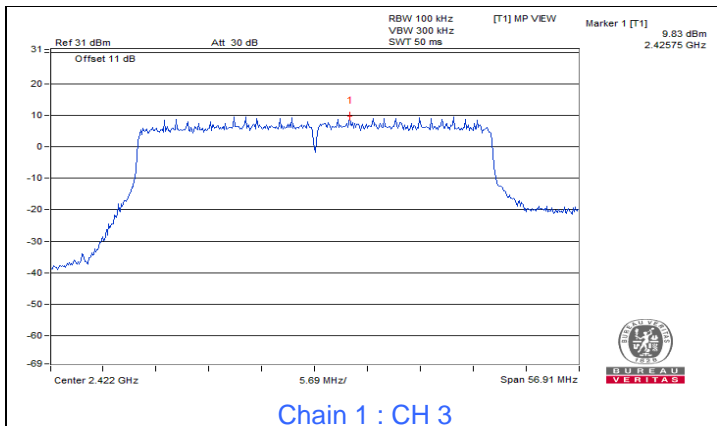

Chain 1 : CH 3

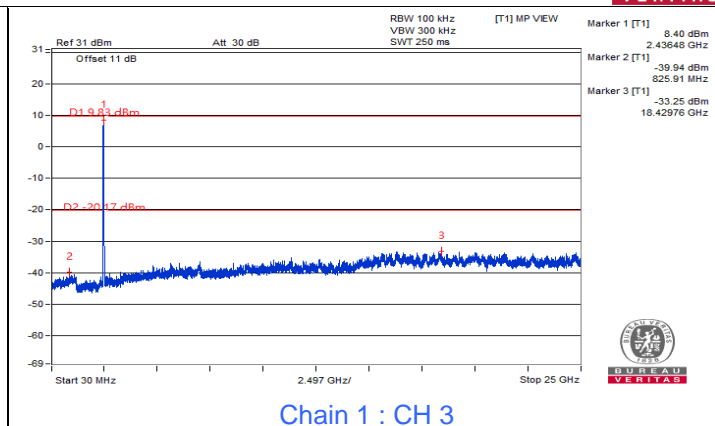

Chain 1 : CH 3

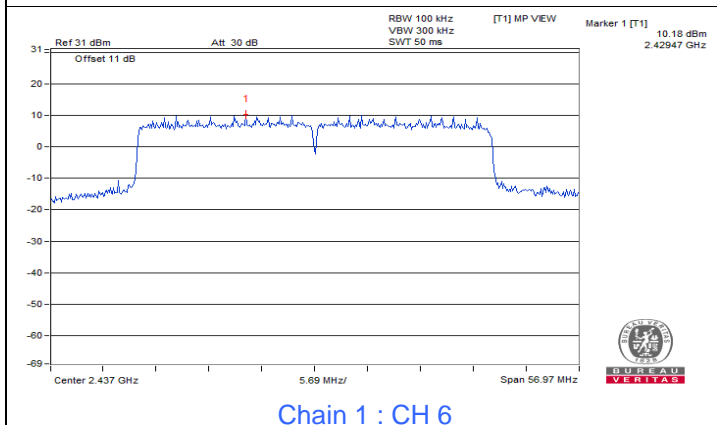

Chain 1 : CH 6

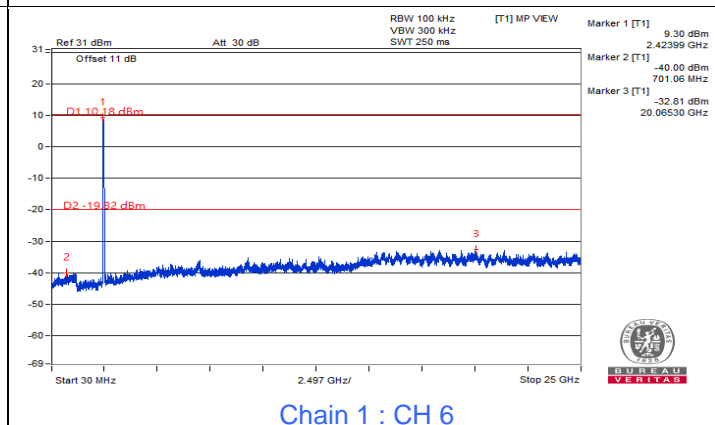

Chain 1 : CH 6

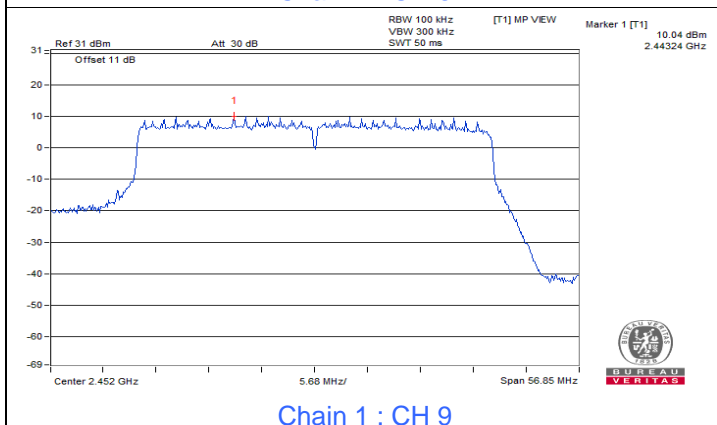

Chain 1 : CH 9

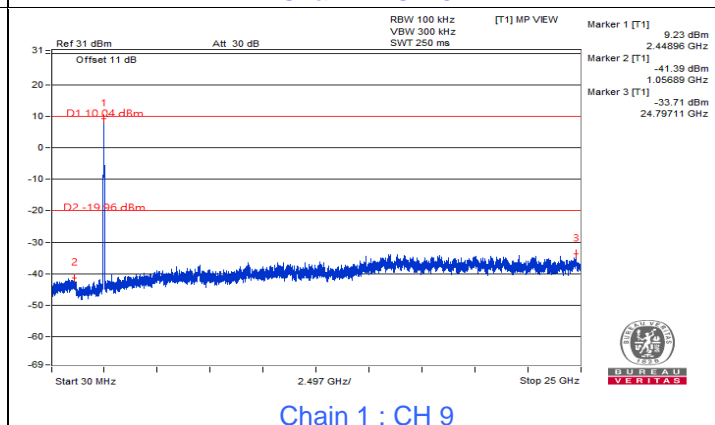

Chain 1 : CH 9

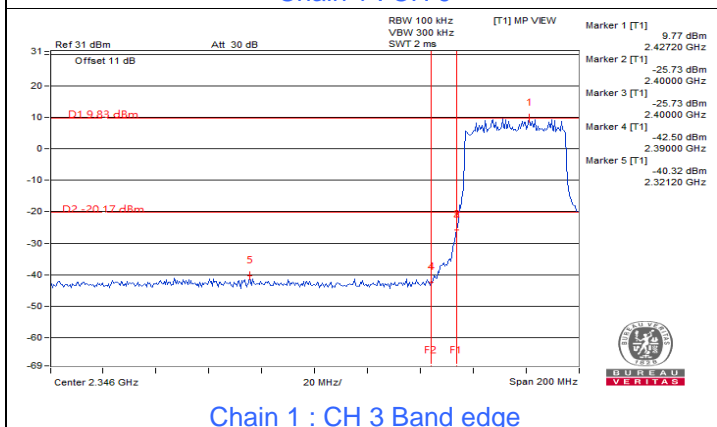

Chain 1 : CH 3 Band edge

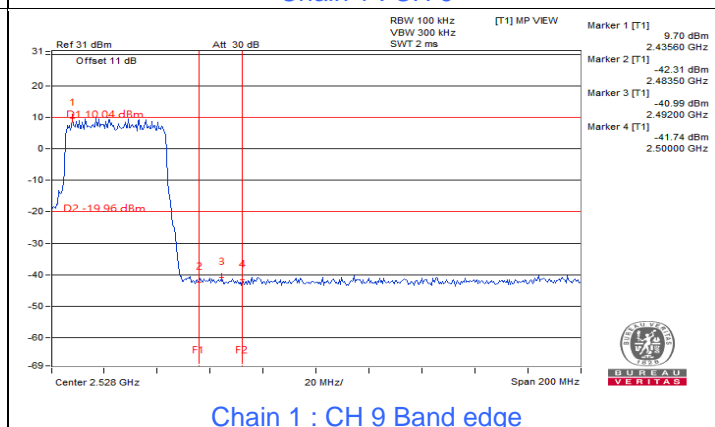

Chain 1 : CH 9 Band edge

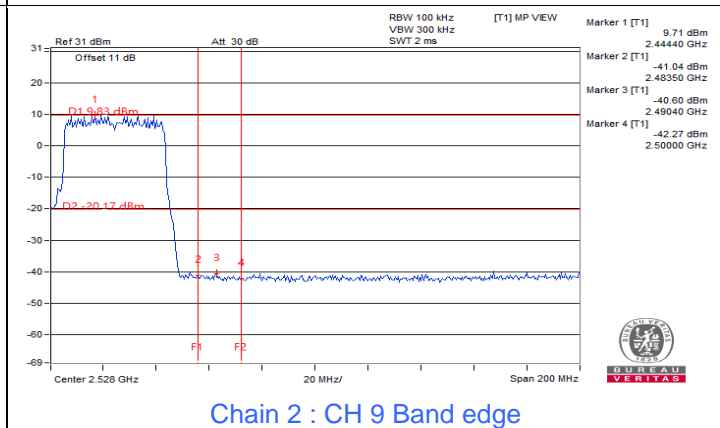
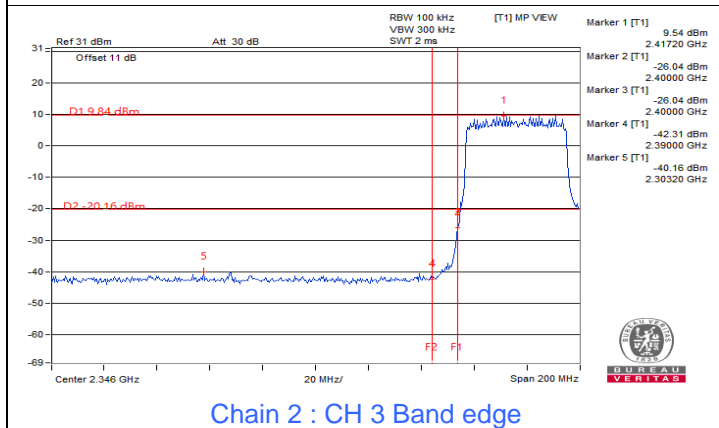
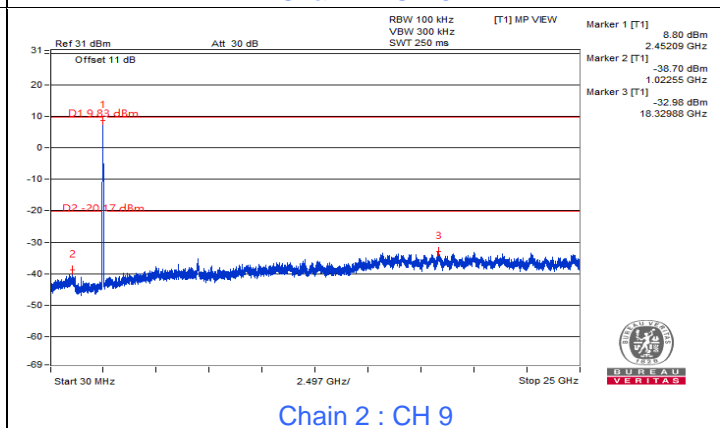
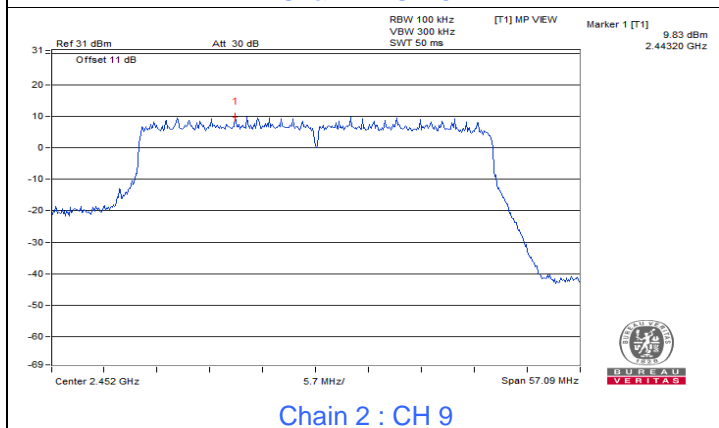
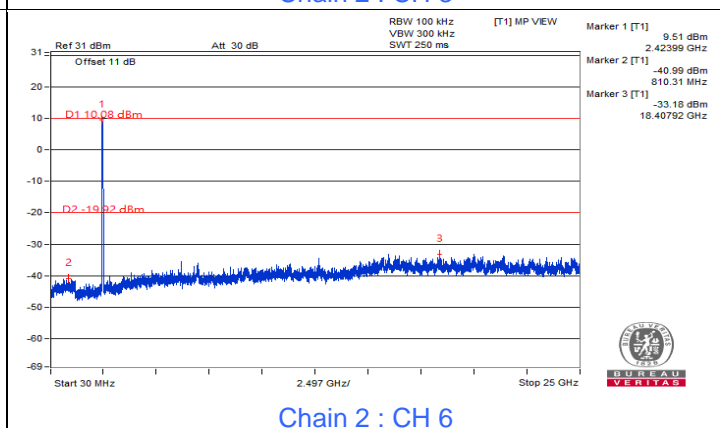
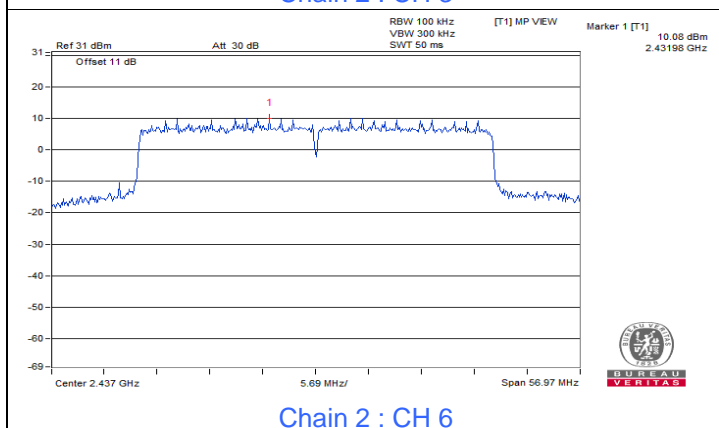
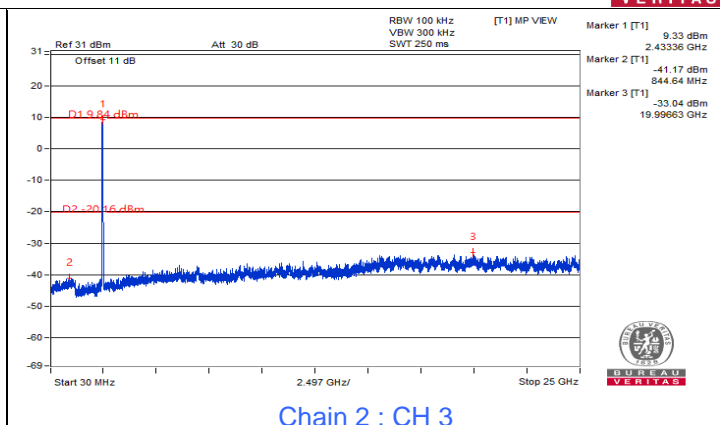
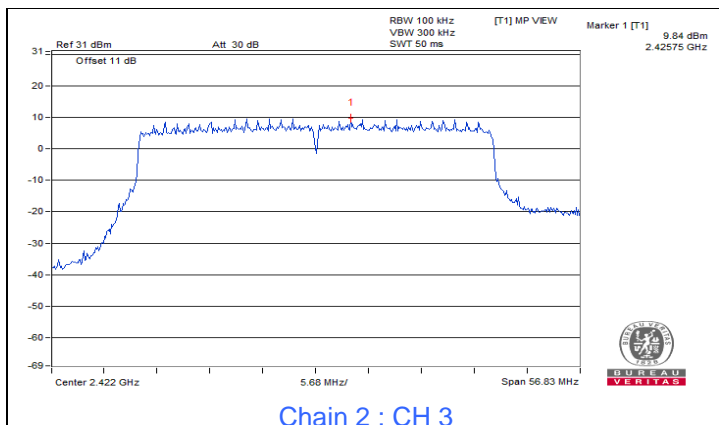

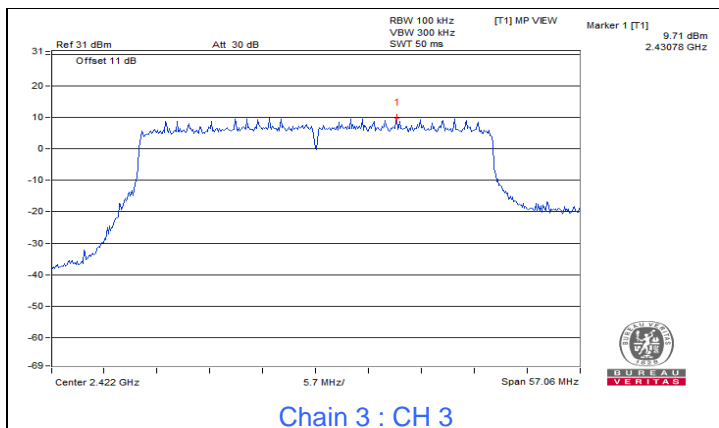

Chain 3 : CH 3

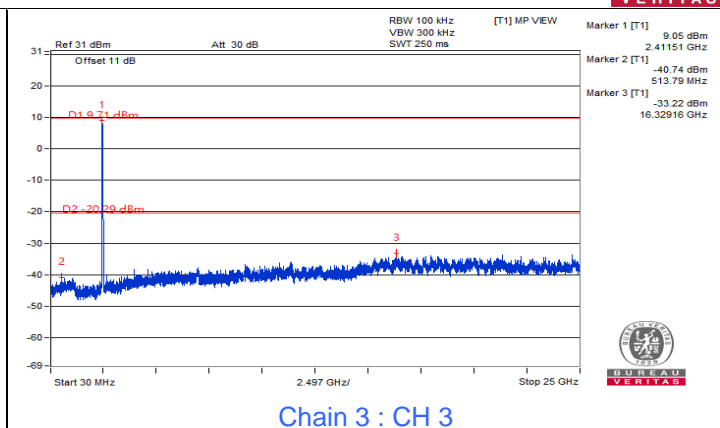

Chain 3 : CH 3

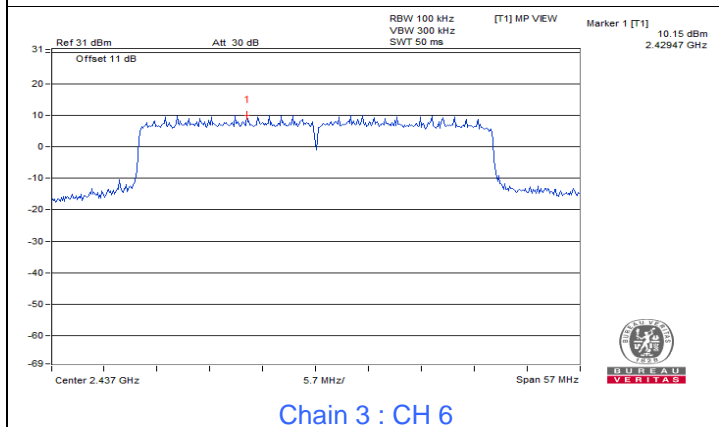

Chain 3 : CH 6

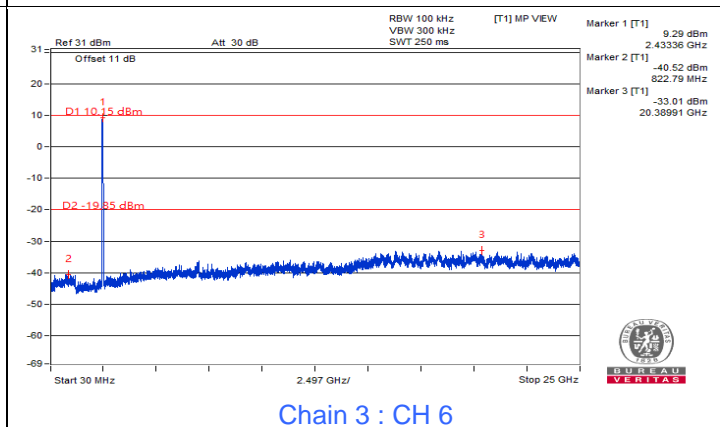

Chain 3 : CH 6

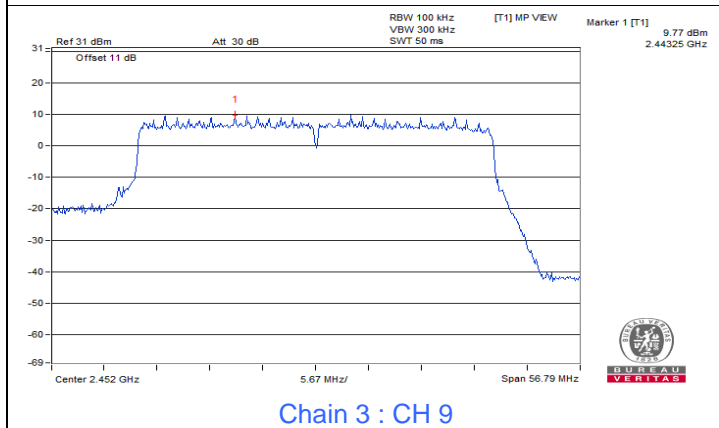

Chain 3 : CH 9

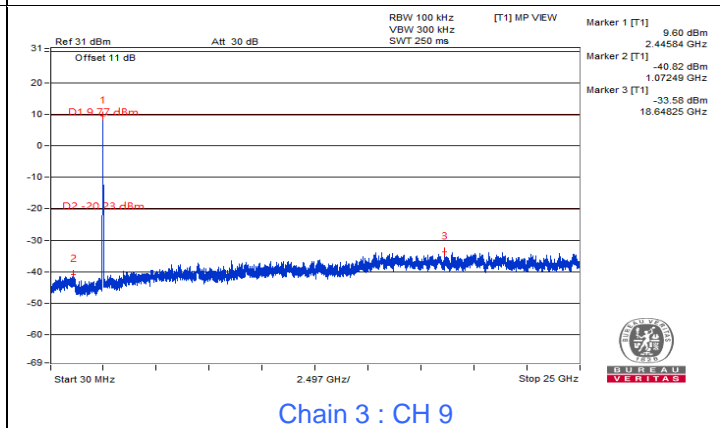

Chain 3 : CH 9

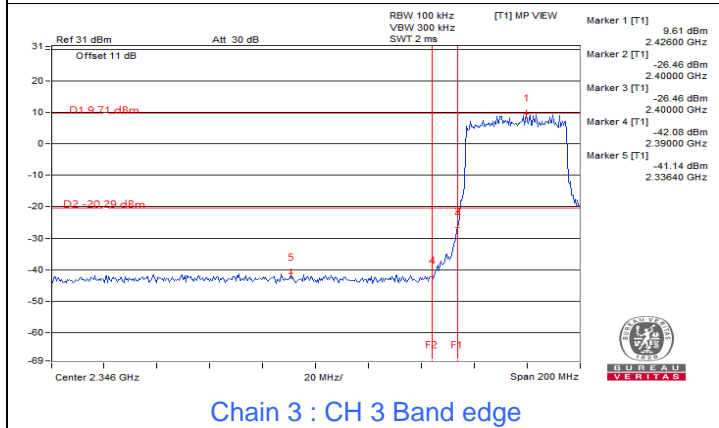

Chain 3 : CH 3 Band edge

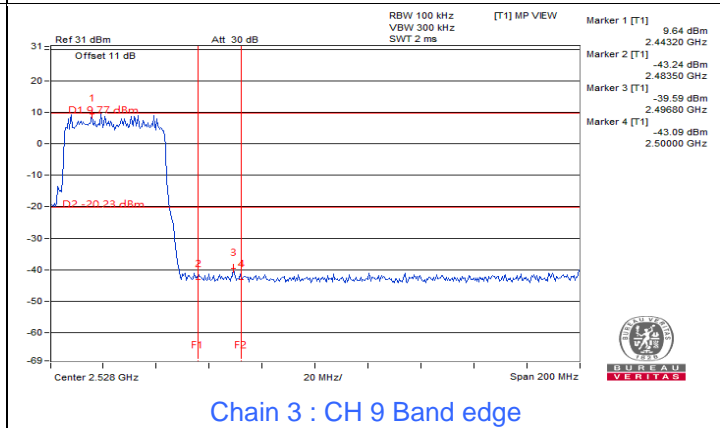

Chain 3 : CH 9 Band edge

7.5 AC Power Conducted Emissions

RF Mode	802.11g	Channel	CH 6 : 2437 MHz
Frequency Range	150kHz ~ 30MHz	Detector Function & Resolution Bandwidth	Quasi-Peak (QP) / Average (AV), 9 kHz
Input Power	120 Vac, 60 Hz	Environmental Conditions	25°C, 75% RH
Tested By	Jed Wu		

Phase Of Power : Line (L)										
No	Frequency (MHz)	Correction Factor (dB)	Reading Value (dBuV)		Emission Level (dBuV)		Limit (dBuV)		Margin (dB)	
			Q.P.	AV.	Q.P.	AV.	Q.P.	AV.	Q.P.	AV.
1	0.15770	10.05	40.76	19.52	50.81	29.57	65.58	55.58	-14.77	-26.01
2	0.41000	10.21	18.89	7.97	29.10	18.18	57.65	47.65	-28.55	-29.47
3	0.74000	10.29	21.90	17.04	32.19	27.33	56.00	46.00	-23.81	-18.67
4	3.52400	10.47	13.05	8.68	23.52	19.15	56.00	46.00	-32.48	-26.85
5	13.22000	10.74	18.25	13.54	28.99	24.28	60.00	50.00	-31.01	-25.72
6	20.78400	10.83	25.34	20.47	36.17	31.30	60.00	50.00	-23.83	-18.70

Remarks:

1. Q.P. and AV. are abbreviations of quasi-peak and average individually.
2. The emission levels of other frequencies were very low against the limit.
3. Margin value = Emission level – Limit value
4. Correction factor = Insertion loss + Cable loss
5. Emission Level = Correction Factor + Reading Value

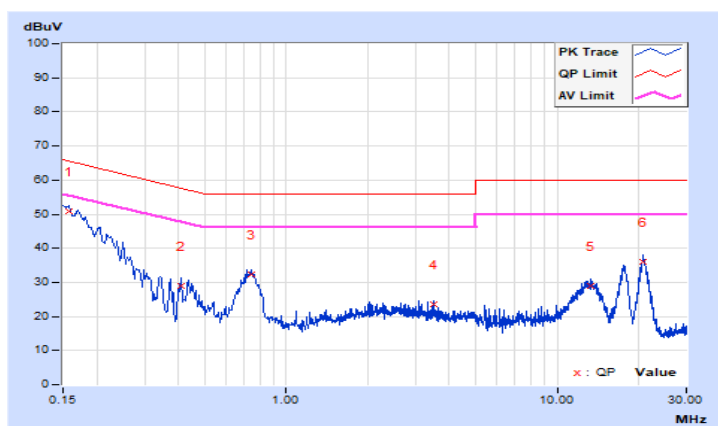

RF Mode	802.11g	Channel	CH 6 : 2437 MHz
Frequency Range	150kHz ~ 30MHz	Detector Function & Resolution Bandwidth	Quasi-Peak (QP) / Average (AV), 9 kHz
Input Power	120 Vac, 60 Hz	Environmental Conditions	25°C, 75% RH
Tested By	Jed Wu		

Phase Of Power : Neutral (N)										
No	Frequency (MHz)	Correction Factor (dB)	Reading Value (dBuV)		Emission Level (dBuV)		Limit (dBuV)		Margin (dB)	
			Q.P.	AV.	Q.P.	AV.	Q.P.	AV.	Q.P.	AV.
1	0.16977	10.11	39.10	20.19	49.21	30.30	64.97	54.97	-15.76	-24.67
2	0.41361	10.19	23.29	12.11	33.48	22.30	57.58	47.58	-24.10	-25.28
3	0.74800	10.24	22.42	17.57	32.66	27.81	56.00	46.00	-23.34	-18.19
4	3.53600	10.40	10.94	6.88	21.34	17.28	56.00	46.00	-34.66	-28.72
5	13.45600	10.74	15.13	10.51	25.87	21.25	60.00	50.00	-34.13	-28.75
6	20.68400	10.83	23.13	18.28	33.96	29.11	60.00	50.00	-26.04	-20.89

Remarks:

1. Q.P. and AV. are abbreviations of quasi-peak and average individually.
2. The emission levels of other frequencies were very low against the limit.
3. Margin value = Emission level – Limit value
4. Correction factor = Insertion loss + Cable loss
5. Emission Level = Correction Factor + Reading Value

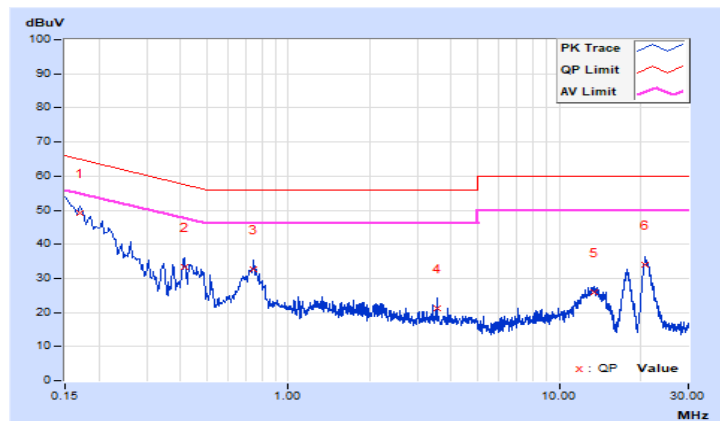

7.6 Unwanted Emissions below 1 GHz

RF Mode	802.11g	Channel	CH 6 : 2437 MHz
Frequency Range	30 MHz ~ 1 GHz	Detector Function & Bandwidth	(QP) RB = 120kHz
Input Power	120 Vac, 60 Hz	Environmental Conditions	22°C, 67% RH
Tested By	Jed Wu		

Antenna Polarity & Test Distance : Horizontal at 3 m								
No	Frequency (MHz)	Emission Level (dBuV/m)	Limit (dBuV/m)	Margin (dB)	Antenna Height (m)	Table Angle (Degree)	Raw Value (dBuV)	Correction Factor (dB/m)
1	51.00	22.2 QP	40.0	-17.8	1.36 H	77	30.7	-8.5
2	108.13	24.7 QP	43.5	-18.8	1.46 H	257	36.6	-11.9
3	156.92	22.0 QP	43.5	-21.5	1.62 H	279	30.2	-8.2
4	287.10	21.4 QP	46.0	-24.6	1.58 H	122	28.0	-6.6
5	365.38	30.1 QP	46.0	-15.9	1.79 H	152	34.9	-4.8
6	459.18	27.8 QP	46.0	-18.2	1.82 H	216	30.1	-2.3

Remarks:

1. Emission Level(dBuV/m) = Raw Value(dBuV) + Correction Factor(dB/m)
2. Correction Factor(dB/m) = Antenna Factor(dB/m) + Cable Factor(dB) – Pre-Amplifier Factor(dB)
3. Margin value = Emission Level – Limit value
4. The other emission levels were very low against the limit of frequency range 30 MHz ~ 1 GHz.
5. The emission levels were very low against the limit of frequency range 9 kHz ~ 30 MHz: the amplitude of spurious emissions attenuated more than 20 dB below the permissible value to be report.

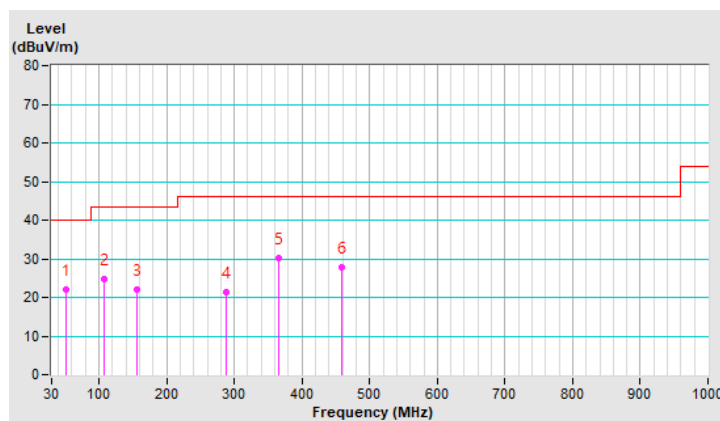

RF Mode	802.11g	Channel	CH 6 : 2437 MHz
Frequency Range	30 MHz ~ 1 GHz	Detector Function & Bandwidth	(QP) RB = 120kHz
Input Power	120 Vac, 60 Hz	Environmental Conditions	14°C, 58% RH
Tested By	Jed Wu		

Antenna Polarity & Test Distance : Vertical at 3 m								
No	Frequency (MHz)	Emission Level (dBuV/m)	Limit (dBuV/m)	Margin (dB)	Antenna Height (m)	Table Angle (Degree)	Raw Value (dBuV)	Correction Factor (dB/m)
1	66.42	29.8 QP	40.0	-10.2	1.28 V	76	40.0	-10.2
2	100.28	23.3 QP	43.5	-20.2	1.34 V	143	36.3	-13.0
3	161.77	20.0 QP	43.5	-23.5	1.67 V	313	28.3	-8.3
4	281.86	21.2 QP	46.0	-24.8	1.98 V	162	27.8	-6.6
5	337.68	22.6 QP	46.0	-23.4	1.62 V	198	27.8	-5.2
6	440.02	25.7 QP	46.0	-20.3	1.15 V	284	28.3	-2.6

Remarks:

1. Emission Level(dBuV/m) = Raw Value(dBuV) + Correction Factor(dB/m)
2. Correction Factor(dB/m) = Antenna Factor(dB/m) + Cable Factor(dB) – Pre-Amplifier Factor(dB)
3. Margin value = Emission Level – Limit value
4. The other emission levels were very low against the limit of frequency range 30 MHz ~ 1 GHz.
5. The emission levels were very low against the limit of frequency range 9 kHz ~ 30 MHz: the amplitude of spurious emissions attenuated more than 20 dB below the permissible value to be report.

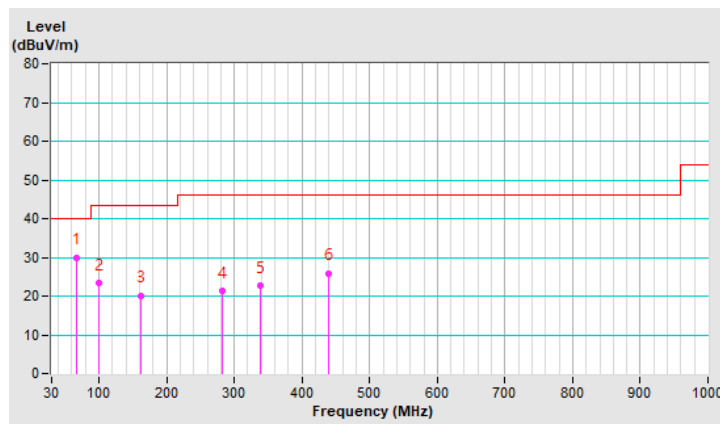

7.7 Unwanted Emissions above 1 GHz

CDD Mode

RF Mode	802.11b	Channel	CH 1 : 2412 MHz
Frequency Range	1 GHz ~ 25 GHz	Detector Function & Bandwidth	(PK) RB = 1 MHz, VB = 3 MHz (AV) RB = 1 MHz, VB = 10 Hz
Input Power	120 Vac, 60 Hz	Environmental Conditions	14°C, 58% RH
Tested By	Jed Wu		

Antenna Polarity & Test Distance : Horizontal at 3 m								
No	Frequency (MHz)	Emission Level (dBuV/m)	Limit (dBuV/m)	Margin (dB)	Antenna Height (m)	Table Angle (Degree)	Raw Value (dBuV)	Correction Factor (dB/m)
1	2390.00	63.8 PK	74.0	-10.2	2.15 H	330	64.9	-1.1
2	2390.00	50.4 AV	54.0	-3.6	2.15 H	330	51.5	-1.1
3	*2412.00	120.0 PK			2.15 H	330	121.1	-1.1
4	*2412.00	117.9 AV			2.15 H	330	119.0	-1.1
5	4824.00	51.6 PK	74.0	-22.4	3.64 H	280	43.9	7.7
6	4824.00	44.9 AV	54.0	-9.1	3.64 H	280	37.2	7.7

Antenna Polarity & Test Distance : Vertical at 3 m								
No	Frequency (MHz)	Emission Level (dBuV/m)	Limit (dBuV/m)	Margin (dB)	Antenna Height (m)	Table Angle (Degree)	Raw Value (dBuV)	Correction Factor (dB/m)
1	2390.00	63.9 PK	74.0	-10.1	1.97 V	339	65.0	-1.1
2	2390.00	50.5 AV	54.0	-3.5	1.97 V	339	51.6	-1.1
3	*2412.00	121.8 PK			1.97 V	339	122.9	-1.1
4	*2412.00	119.5 AV			1.97 V	339	120.6	-1.1
5	4824.00	51.3 PK	74.0	-22.7	1.72 V	236	43.6	7.7
6	4824.00	43.7 AV	54.0	-10.3	1.72 V	236	36.0	7.7

Remarks:

1. Emission Level(dBuV/m) = Raw Value(dBuV) + Correction Factor(dB/m)
2. Correction Factor(dB/m) = Antenna Factor(dB/m) + Cable Factor(dB) – Pre-Amplifier Factor(dB)
3. Margin value = Emission Level – Limit value
4. The other emission levels were very low against the limit.
5. " * " : Fundamental frequency, the limit was restricted at the RF Output Power.



RF Mode	802.11b	Channel	CH 6 : 2437 MHz
Frequency Range	1 GHz ~ 25 GHz	Detector Function & Bandwidth	(PK) RB = 1 MHz, VB = 3 MHz (AV) RB = 1 MHz, VB = 10 Hz
Input Power	120 Vac, 60 Hz	Environmental Conditions	14°C, 58% RH
Tested By	Jed Wu		

Antenna Polarity & Test Distance : Horizontal at 3 m								
No	Frequency (MHz)	Emission Level (dBuV/m)	Limit (dBuV/m)	Margin (dB)	Antenna Height (m)	Table Angle (Degree)	Raw Value (dBuV)	Correction Factor (dB/m)
1	*2437.00	120.8 PK			2.37 H	324	121.8	-1.0
2	*2437.00	118.9 AV			2.37 H	324	119.9	-1.0
3	4874.00	53.3 PK	74.0	-20.7	3.44 H	87	45.5	7.8
4	4874.00	48.1 AV	54.0	-5.9	3.44 H	87	40.3	7.8

Antenna Polarity & Test Distance : Vertical at 3 m								
No	Frequency (MHz)	Emission Level (dBuV/m)	Limit (dBuV/m)	Margin (dB)	Antenna Height (m)	Table Angle (Degree)	Raw Value (dBuV)	Correction Factor (dB/m)
1	*2437.00	122.6 PK			2.19 V	333	123.6	-1.0
2	*2437.00	120.5 AV			2.19 V	333	121.5	-1.0
3	4874.00	53.0 PK	74.0	-21.0	1.42 V	28	45.2	7.8
4	4874.00	46.9 AV	54.0	-7.1	1.42 V	28	39.1	7.8

Remarks:

1. Emission Level(dBuV/m) = Raw Value(dBuV) + Correction Factor(dB/m)
2. Correction Factor(dB/m) = Antenna Factor(dB/m) + Cable Factor(dB) – Pre-Amplifier Factor(dB)
3. Margin value = Emission Level – Limit value
4. The other emission levels were very low against the limit.
5. " * " : Fundamental frequency, the limit was restricted at the RF Output Power.



RF Mode	802.11b	Channel	CH 11 : 2462 MHz
Frequency Range	1 GHz ~ 25 GHz	Detector Function & Bandwidth	(PK) RB = 1 MHz, VB = 3 MHz (AV) RB = 1 MHz, VB = 10 Hz
Input Power	120 Vac, 60 Hz	Environmental Conditions	14°C, 58% RH
Tested By	Jed Wu		

Antenna Polarity & Test Distance : Horizontal at 3 m

No	Frequency (MHz)	Emission Level (dBuV/m)	Limit (dBuV/m)	Margin (dB)	Antenna Height (m)	Table Angle (Degree)	Raw Value (dBuV)	Correction Factor (dB/m)
1	*2462.00	120.9 PK			2.63 H	301	121.8	-0.9
2	*2462.00	118.9 AV			2.63 H	301	119.8	-0.9
3	2483.50	64.4 PK	74.0	-9.6	2.63 H	301	65.2	-0.8
4	2483.50	51.3 AV	54.0	-2.7	2.63 H	301	52.1	-0.8
5	4924.00	53.4 PK	74.0	-20.6	3.16 H	251	45.6	7.8
6	4924.00	48.2 AV	54.0	-5.8	3.16 H	251	40.4	7.8

Antenna Polarity & Test Distance : Vertical at 3 m

No	Frequency (MHz)	Emission Level (dBuV/m)	Limit (dBuV/m)	Margin (dB)	Antenna Height (m)	Table Angle (Degree)	Raw Value (dBuV)	Correction Factor (dB/m)
1	*2462.00	122.8 PK			2.45 V	310	123.7	-0.9
2	*2462.00	120.7 AV			2.45 V	310	121.6	-0.9
3	2483.50	64.6 PK	74.0	-9.4	2.45 V	310	65.4	-0.8
4	2483.50	51.5 AV	54.0	-2.5	2.45 V	310	52.3	-0.8
5	4924.00	53.1 PK	74.0	-20.9	1.68 V	5	45.3	7.8
6	4924.00	47.0 AV	54.0	-7.0	1.68 V	5	39.2	7.8

Remarks:

1. Emission Level(dBuV/m) = Raw Value(dBuV) + Correction Factor(dB/m)
2. Correction Factor(dB/m) = Antenna Factor(dB/m) + Cable Factor(dB) – Pre-Amplifier Factor(dB)
3. Margin value = Emission Level – Limit value
4. The other emission levels were very low against the limit.
5. " * ": Fundamental frequency, the limit was restricted at the RF Output Power.



RF Mode	802.11g	Channel	CH 1 : 2412 MHz
Frequency Range	1 GHz ~ 25 GHz	Detector Function & Bandwidth	(PK) RB = 1 MHz, VB = 3 MHz (AV) RB = 1 MHz, VB = 10 Hz
Input Power	120 Vac, 60 Hz	Environmental Conditions	14°C, 58% RH
Tested By	Jed Wu		

Antenna Polarity & Test Distance : Horizontal at 3 m

No	Frequency (MHz)	Emission Level (dBuV/m)	Limit (dBuV/m)	Margin (dB)	Antenna Height (m)	Table Angle (Degree)	Raw Value (dBuV)	Correction Factor (dB/m)
1	2390.00	64.5 PK	74.0	-9.5	2.91 H	329	65.6	-1.1
2	2390.00	51.3 AV	54.0	-2.7	2.91 H	329	52.4	-1.1
3	*2412.00	123.1 PK			2.91 H	329	124.2	-1.1
4	*2412.00	113.4 AV			2.91 H	329	114.5	-1.1
5	4824.00	49.0 PK	74.0	-25.0	2.88 H	281	41.3	7.7
6	4824.00	35.3 AV	54.0	-18.7	2.88 H	281	27.6	7.7

Antenna Polarity & Test Distance : Vertical at 3 m

No	Frequency (MHz)	Emission Level (dBuV/m)	Limit (dBuV/m)	Margin (dB)	Antenna Height (m)	Table Angle (Degree)	Raw Value (dBuV)	Correction Factor (dB/m)
1	2390.00	67.7 PK	74.0	-6.3	2.73 V	340	68.8	-1.1
2	2390.00	52.7 AV	54.0	-1.3	2.73 V	340	53.8	-1.1
3	*2412.00	125.3 PK			2.73 V	340	126.4	-1.1
4	*2412.00	115.6 AV			2.73 V	340	116.7	-1.1
5	4824.00	48.7 PK	74.0	-25.3	1.96 V	35	41.0	7.7
6	4824.00	35.0 AV	54.0	-19.0	1.96 V	35	27.3	7.7

Remarks:

1. Emission Level(dBuV/m) = Raw Value(dBuV) + Correction Factor(dB/m)
2. Correction Factor(dB/m) = Antenna Factor(dB/m) + Cable Factor(dB) – Pre-Amplifier Factor(dB)
3. Margin value = Emission Level – Limit value
4. The other emission levels were very low against the limit.
5. " * ": Fundamental frequency, the limit was restricted at the RF Output Power.



RF Mode	802.11g	Channel	CH 6 : 2437 MHz
Frequency Range	1 GHz ~ 25 GHz	Detector Function & Bandwidth	(PK) RB = 1 MHz, VB = 3 MHz (AV) RB = 1 MHz, VB = 10 Hz
Input Power	120 Vac, 60 Hz	Environmental Conditions	14°C, 58% RH
Tested By	Jed Wu		

Antenna Polarity & Test Distance : Horizontal at 3 m								
No	Frequency (MHz)	Emission Level (dBuV/m)	Limit (dBuV/m)	Margin (dB)	Antenna Height (m)	Table Angle (Degree)	Raw Value (dBuV)	Correction Factor (dB/m)
1	*2437.00	123.5 PK			2.41 H	307	124.5	-1.0
2	*2437.00	114.3 AV			2.41 H	307	115.3	-1.0
3	4874.00	49.2 PK	74.0	-24.8	3.38 H	256	41.4	7.8
4	4874.00	35.5 AV	54.0	-18.5	3.38 H	256	27.7	7.8

Antenna Polarity & Test Distance : Vertical at 3 m								
No	Frequency (MHz)	Emission Level (dBuV/m)	Limit (dBuV/m)	Margin (dB)	Antenna Height (m)	Table Angle (Degree)	Raw Value (dBuV)	Correction Factor (dB/m)
1	*2437.00	125.5 PK			2.23 V	2	126.5	-1.0
2	*2437.00	115.9 AV			2.23 V	2	116.9	-1.0
3	4874.00	48.9 PK	74.0	-25.1	1.47 V	13	41.1	7.8
4	4874.00	35.2 AV	54.0	-18.8	1.47 V	13	27.4	7.8

Remarks:

1. Emission Level(dBuV/m) = Raw Value(dBuV) + Correction Factor(dB/m)
2. Correction Factor(dB/m) = Antenna Factor(dB/m) + Cable Factor(dB) – Pre-Amplifier Factor(dB)
3. Margin value = Emission Level – Limit value
4. The other emission levels were very low against the limit.
5. " * " : Fundamental frequency, the limit was restricted at the RF Output Power.



RF Mode	802.11g	Channel	CH 11 : 2462 MHz
Frequency Range	1 GHz ~ 25 GHz	Detector Function & Bandwidth	(PK) RB = 1 MHz, VB = 3 MHz (AV) RB = 1 MHz, VB = 10 Hz
Input Power	120 Vac, 60 Hz	Environmental Conditions	14°C, 58% RH
Tested By	Jed Wu		

Antenna Polarity & Test Distance : Horizontal at 3 m

No	Frequency (MHz)	Emission Level (dBuV/m)	Limit (dBuV/m)	Margin (dB)	Antenna Height (m)	Table Angle (Degree)	Raw Value (dBuV)	Correction Factor (dB/m)
1	*2462.00	122.7 PK			2.62 H	324	123.6	-0.9
2	*2462.00	113.5 AV			2.62 H	324	114.4	-0.9
3	2483.50	65.6 PK	74.0	-8.4	2.62 H	324	66.4	-0.8
4	2483.50	52.3 AV	54.0	-1.7	2.62 H	324	53.1	-0.8
5	4924.00	50.3 PK	74.0	-23.7	3.17 H	286	42.5	7.8
6	4924.00	36.6 AV	54.0	-17.4	3.17 H	286	28.8	7.8

Antenna Polarity & Test Distance : Vertical at 3 m

No	Frequency (MHz)	Emission Level (dBuV/m)	Limit (dBuV/m)	Margin (dB)	Antenna Height (m)	Table Angle (Degree)	Raw Value (dBuV)	Correction Factor (dB/m)
1	*2462.00	124.5 PK			2.44 V	333	125.4	-0.9
2	*2462.00	115.0 AV			2.44 V	333	115.9	-0.9
3	2483.50	69.3 PK	74.0	-4.7	2.44 V	333	70.1	-0.8
4	2483.50	53.7 AV	54.0	-0.3	2.44 V	333	54.5	-0.8
5	4924.00	50.0 PK	74.0	-24.0	1.68 V	344	42.2	7.8
6	4924.00	36.3 AV	54.0	-17.7	1.68 V	344	28.5	7.8

Remarks:

1. Emission Level(dBuV/m) = Raw Value(dBuV) + Correction Factor(dB/m)
2. Correction Factor(dB/m) = Antenna Factor(dB/m) + Cable Factor(dB) – Pre-Amplifier Factor(dB)
3. Margin value = Emission Level – Limit value
4. The other emission levels were very low against the limit.
5. " * ": Fundamental frequency, the limit was restricted at the RF Output Power.



RF Mode	802.11ax (HE20)	Channel	CH 1 : 2412 MHz
Frequency Range	1 GHz ~ 25 GHz	Detector Function & Bandwidth	(PK) RB = 1 MHz, VB = 3 MHz (AV) RB = 1 MHz, VB = 10 Hz
Input Power	120 Vac, 60 Hz	Environmental Conditions	14°C, 58% RH
Tested By	Jed Wu		

Antenna Polarity & Test Distance : Horizontal at 3 m

No	Frequency (MHz)	Emission Level (dBuV/m)	Limit (dBuV/m)	Margin (dB)	Antenna Height (m)	Table Angle (Degree)	Raw Value (dBuV)	Correction Factor (dB/m)
1	2390.00	65.2 PK	74.0	-8.8	2.24 H	355	66.3	-1.1
2	2390.00	52.7 AV	54.0	-1.3	2.24 H	355	53.8	-1.1
3	*2412.00	123.6 PK			2.24 H	355	124.7	-1.1
4	*2412.00	111.0 AV			2.24 H	355	112.1	-1.1
5	4824.00	49.2 PK	74.0	-24.8	3.73 H	305	41.5	7.7
6	4824.00	35.5 AV	54.0	-18.5	3.73 H	305	27.8	7.7

Antenna Polarity & Test Distance : Vertical at 3 m

No	Frequency (MHz)	Emission Level (dBuV/m)	Limit (dBuV/m)	Margin (dB)	Antenna Height (m)	Table Angle (Degree)	Raw Value (dBuV)	Correction Factor (dB/m)
1	2390.00	65.4 PK	74.0	-8.6	2.06 V	4	66.5	-1.1
2	2390.00	53.1 AV	54.0	-0.9	2.06 V	4	54.2	-1.1
3	*2412.00	124.8 PK			2.06 V	4	125.9	-1.1
4	*2412.00	112.4 AV			2.06 V	4	113.5	-1.1
5	4824.00	48.9 PK	74.0	-25.1	1.30 V	313	41.2	7.7
6	4824.00	35.2 AV	54.0	-18.8	1.30 V	313	27.5	7.7

Remarks:

1. Emission Level(dBuV/m) = Raw Value(dBuV) + Correction Factor(dB/m)
2. Correction Factor(dB/m) = Antenna Factor(dB/m) + Cable Factor(dB) – Pre-Amplifier Factor(dB)
3. Margin value = Emission Level – Limit value
4. The other emission levels were very low against the limit.
5. " * ": Fundamental frequency, the limit was restricted at the RF Output Power.



RF Mode	802.11ax (HE20)	Channel	CH 6 : 2437 MHz
Frequency Range	1 GHz ~ 25 GHz	Detector Function & Bandwidth	(PK) RB = 1 MHz, VB = 3 MHz (AV) RB = 1 MHz, VB = 10 Hz
Input Power	120 Vac, 60 Hz	Environmental Conditions	14°C, 58% RH
Tested By	Jed Wu		

Antenna Polarity & Test Distance : Horizontal at 3 m								
No	Frequency (MHz)	Emission Level (dBuV/m)	Limit (dBuV/m)	Margin (dB)	Antenna Height (m)	Table Angle (Degree)	Raw Value (dBuV)	Correction Factor (dB/m)
1	*2437.00	125.4 PK			2.22 H	1	126.4	-1.0
2	*2437.00	112.9 AV			2.22 H	1	113.9	-1.0
3	4874.00	50.8 PK	74.0	-23.2	3.71 H	311	43.0	7.8
4	4874.00	37.1 AV	54.0	-16.9	3.71 H	311	29.3	7.8

Antenna Polarity & Test Distance : Vertical at 3 m								
No	Frequency (MHz)	Emission Level (dBuV/m)	Limit (dBuV/m)	Margin (dB)	Antenna Height (m)	Table Angle (Degree)	Raw Value (dBuV)	Correction Factor (dB/m)
1	*2437.00	127.0 PK			2.04 V	10	128.0	-1.0
2	*2437.00	114.3 AV			2.04 V	10	115.3	-1.0
3	4874.00	51.1 PK	74.0	-22.9	1.28 V	319	43.3	7.8
4	4874.00	37.4 AV	54.0	-16.6	1.28 V	319	29.6	7.8

Remarks:

1. Emission Level(dBuV/m) = Raw Value(dBuV) + Correction Factor(dB/m)
2. Correction Factor(dB/m) = Antenna Factor(dB/m) + Cable Factor(dB) – Pre-Amplifier Factor(dB)
3. Margin value = Emission Level – Limit value
4. The other emission levels were very low against the limit.
5. " * " : Fundamental frequency, the limit was restricted at the RF Output Power.



RF Mode	802.11ax (HE20)	Channel	CH 11 : 2462 MHz
Frequency Range	1 GHz ~ 25 GHz	Detector Function & Bandwidth	(PK) RB = 1 MHz, VB = 3 MHz (AV) RB = 1 MHz, VB = 10 Hz
Input Power	120 Vac, 60 Hz	Environmental Conditions	14°C, 58% RH
Tested By	Jed Wu		

Antenna Polarity & Test Distance : Horizontal at 3 m

No	Frequency (MHz)	Emission Level (dBuV/m)	Limit (dBuV/m)	Margin (dB)	Antenna Height (m)	Table Angle (Degree)	Raw Value (dBuV)	Correction Factor (dB/m)
1	*2462.00	122.5 PK			2.20 H	358	123.4	-0.9
2	*2462.00	109.7 AV			2.20 H	358	110.6	-0.9
3	2483.50	65.2 PK	74.0	-8.8	2.20 H	358	66.0	-0.8
4	2483.50	52.4 AV	54.0	-1.6	2.20 H	358	53.2	-0.8
5	4924.00	48.5 PK	74.0	-25.5	3.69 H	252	40.7	7.8
6	4924.00	34.8 AV	54.0	-19.2	3.69 H	252	27.0	7.8

Antenna Polarity & Test Distance : Vertical at 3 m

No	Frequency (MHz)	Emission Level (dBuV/m)	Limit (dBuV/m)	Margin (dB)	Antenna Height (m)	Table Angle (Degree)	Raw Value (dBuV)	Correction Factor (dB/m)
1	*2462.00	124.2 PK			2.02 V	7	125.1	-0.9
2	*2462.00	111.7 AV			2.02 V	7	112.6	-0.9
3	2483.50	66.6 PK	74.0	-7.4	2.02 V	7	67.4	-0.8
4	2483.50	53.2 AV	54.0	-0.8	2.02 V	7	54.0	-0.8
5	4924.00	48.2 PK	74.0	-25.8	1.26 V	316	40.4	7.8
6	4924.00	34.5 AV	54.0	-19.5	1.26 V	316	26.7	7.8

Remarks:

1. Emission Level(dBuV/m) = Raw Value(dBuV) + Correction Factor(dB/m)
2. Correction Factor(dB/m) = Antenna Factor(dB/m) + Cable Factor(dB) – Pre-Amplifier Factor(dB)
3. Margin value = Emission Level – Limit value
4. The other emission levels were very low against the limit.
5. " * ": Fundamental frequency, the limit was restricted at the RF Output Power.



RF Mode	802.11ax (HE40)	Channel	CH 3 : 2422 MHz
Frequency Range	1 GHz ~ 25 GHz	Detector Function & Bandwidth	(PK) RB = 1 MHz, VB = 3 MHz (AV) RB = 1 MHz, VB = 10 Hz
Input Power	120 Vac, 60 Hz	Environmental Conditions	14°C, 58% RH
Tested By	Jed Wu		

Antenna Polarity & Test Distance : Horizontal at 3 m

No	Frequency (MHz)	Emission Level (dBuV/m)	Limit (dBuV/m)	Margin (dB)	Antenna Height (m)	Table Angle (Degree)	Raw Value (dBuV)	Correction Factor (dB/m)
1	2390.00	64.0 PK	74.0	-10.0	2.23 H	352	65.1	-1.1
2	2390.00	52.1 AV	54.0	-1.9	2.23 H	352	53.2	-1.1
3	*2422.00	120.9 PK			2.23 H	352	121.9	-1.0
4	*2422.00	108.9 AV			2.23 H	352	109.9	-1.0
5	4844.00	50.1 PK	74.0	-23.9	3.72 H	302	42.4	7.7
6	4844.00	36.4 AV	54.0	-17.6	3.72 H	302	28.7	7.7

Antenna Polarity & Test Distance : Vertical at 3 m

No	Frequency (MHz)	Emission Level (dBuV/m)	Limit (dBuV/m)	Margin (dB)	Antenna Height (m)	Table Angle (Degree)	Raw Value (dBuV)	Correction Factor (dB/m)
1	2390.00	65.1 PK	74.0	-8.9	2.05 V	1	66.2	-1.1
2	2390.00	52.9 AV	54.0	-1.1	2.05 V	1	54.0	-1.1
3	*2422.00	122.4 PK			2.05 V	1	123.4	-1.0
4	*2422.00	110.1 AV			2.05 V	1	111.1	-1.0
5	4844.00	49.8 PK	74.0	-24.2	1.29 V	310	42.1	7.7
6	4844.00	36.1 AV	54.0	-17.9	1.29 V	310	28.4	7.7

Remarks:

1. Emission Level(dBuV/m) = Raw Value(dBuV) + Correction Factor(dB/m)
2. Correction Factor(dB/m) = Antenna Factor(dB/m) + Cable Factor(dB) – Pre-Amplifier Factor(dB)
3. Margin value = Emission Level – Limit value
4. The other emission levels were very low against the limit.
5. " * ": Fundamental frequency, the limit was restricted at the RF Output Power.



RF Mode	802.11ax (HE40)	Channel	CH 6 : 2437 MHz
Frequency Range	1 GHz ~ 25 GHz	Detector Function & Bandwidth	(PK) RB = 1 MHz, VB = 3 MHz (AV) RB = 1 MHz, VB = 10 Hz
Input Power	120 Vac, 60 Hz	Environmental Conditions	14°C, 58% RH
Tested By	Jed Wu		

Antenna Polarity & Test Distance : Horizontal at 3 m								
No	Frequency (MHz)	Emission Level (dBuV/m)	Limit (dBuV/m)	Margin (dB)	Antenna Height (m)	Table Angle (Degree)	Raw Value (dBuV)	Correction Factor (dB/m)
1	*2437.00	123.0 PK			2.21 H	2	124.0	-1.0
2	*2437.00	110.6 AV			2.21 H	2	111.6	-1.0
3	4874.00	49.0 PK	74.0	-25.0	3.70 H	312	41.2	7.8
4	4874.00	35.2 AV	54.0	-18.8	3.70 H	312	27.4	7.8

Antenna Polarity & Test Distance : Vertical at 3 m								
No	Frequency (MHz)	Emission Level (dBuV/m)	Limit (dBuV/m)	Margin (dB)	Antenna Height (m)	Table Angle (Degree)	Raw Value (dBuV)	Correction Factor (dB/m)
1	*2437.00	124.7 PK			2.03 V	10	125.7	-1.0
2	*2437.00	112.1 AV			2.03 V	10	113.1	-1.0
3	4874.00	48.6 PK	74.0	-25.4	1.27 V	319	40.8	7.8
4	4874.00	34.9 AV	54.0	-19.1	1.27 V	319	27.1	7.8

Remarks:

1. Emission Level(dBuV/m) = Raw Value(dBuV) + Correction Factor(dB/m)
2. Correction Factor(dB/m) = Antenna Factor(dB/m) + Cable Factor(dB) – Pre-Amplifier Factor(dB)
3. Margin value = Emission Level – Limit value
4. The other emission levels were very low against the limit.
5. " * " : Fundamental frequency, the limit was restricted at the RF Output Power.



RF Mode	802.11ax (HE40)	Channel	CH 9 : 2452 MHz
Frequency Range	1 GHz ~ 25 GHz	Detector Function & Bandwidth	(PK) RB = 1 MHz, VB = 3 MHz (AV) RB = 1 MHz, VB = 10 Hz
Input Power	120 Vac, 60 Hz	Environmental Conditions	14°C, 58% RH
Tested By	Jed Wu		

Antenna Polarity & Test Distance : Horizontal at 3 m

No	Frequency (MHz)	Emission Level (dBuV/m)	Limit (dBuV/m)	Margin (dB)	Antenna Height (m)	Table Angle (Degree)	Raw Value (dBuV)	Correction Factor (dB/m)
1	*2452.00	121.8 PK			2.22 H	3	122.7	-0.9
2	*2452.00	109.4 AV			2.22 H	3	110.3	-0.9
3	2483.50	65.2 PK	74.0	-8.8	2.22 H	3	66.0	-0.8
4	2483.50	52.7 AV	54.0	-1.3	2.22 H	3	53.5	-0.8
5	4904.00	50.3 PK	74.0	-23.7	3.71 H	313	42.5	7.8
6	4904.00	36.6 AV	54.0	-17.4	3.71 H	313	28.8	7.8

Antenna Polarity & Test Distance : Vertical at 3 m

No	Frequency (MHz)	Emission Level (dBuV/m)	Limit (dBuV/m)	Margin (dB)	Antenna Height (m)	Table Angle (Degree)	Raw Value (dBuV)	Correction Factor (dB/m)
1	*2452.00	123.4 PK			2.04 V	12	124.3	-0.9
2	*2452.00	110.5 AV			2.04 V	12	111.4	-0.9
3	2483.50	65.9 PK	74.0	-8.1	2.04 V	12	66.7	-0.8
4	2483.50	52.9 AV	54.0	-1.1	2.04 V	12	53.7	-0.8
5	4904.00	50.0 PK	74.0	-24.0	1.28 V	321	42.2	7.8
6	4904.00	36.3 AV	54.0	-17.7	1.28 V	321	28.5	7.8

Remarks:

1. Emission Level(dBuV/m) = Raw Value(dBuV) + Correction Factor(dB/m)
2. Correction Factor(dB/m) = Antenna Factor(dB/m) + Cable Factor(dB) – Pre-Amplifier Factor(dB)
3. Margin value = Emission Level – Limit value
4. The other emission levels were very low against the limit.
5. " * ": Fundamental frequency, the limit was restricted at the RF Output Power.



Plot of Band Edge_CDD Mode

802.11b Channel 1

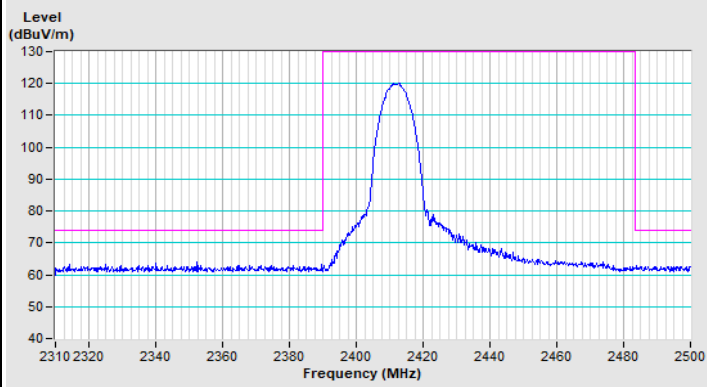

Horizontal (Peak)

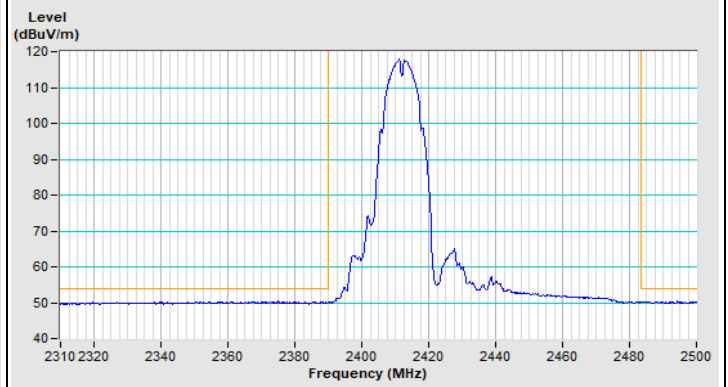

Horizontal (Average)

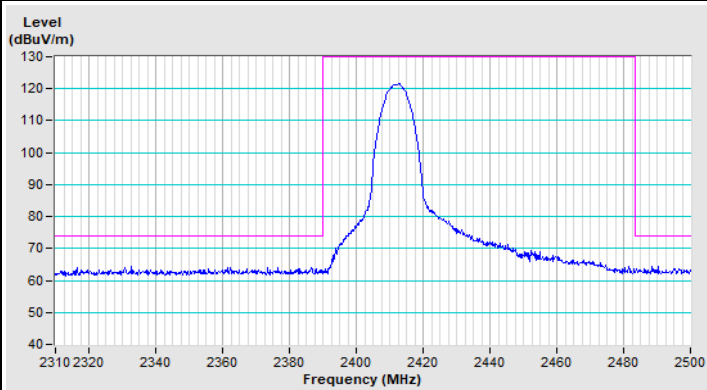

Vertical (Peak)

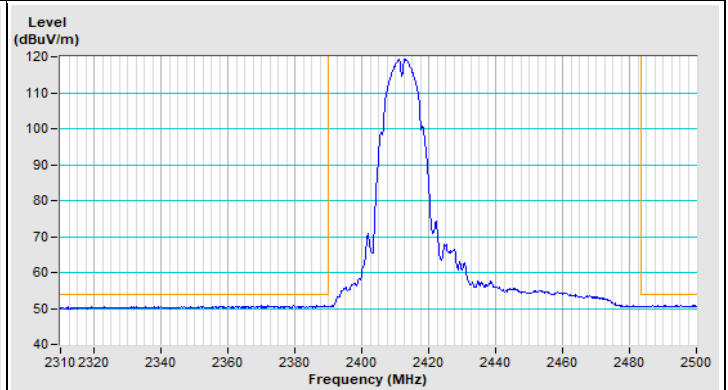

Vertical (Average)

802.11b Channel 11

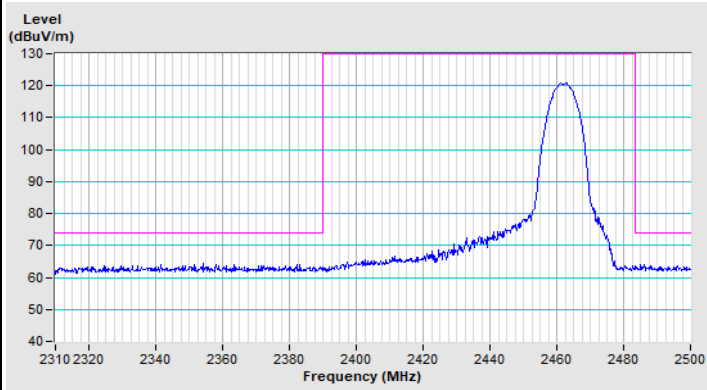

Horizontal (Peak)

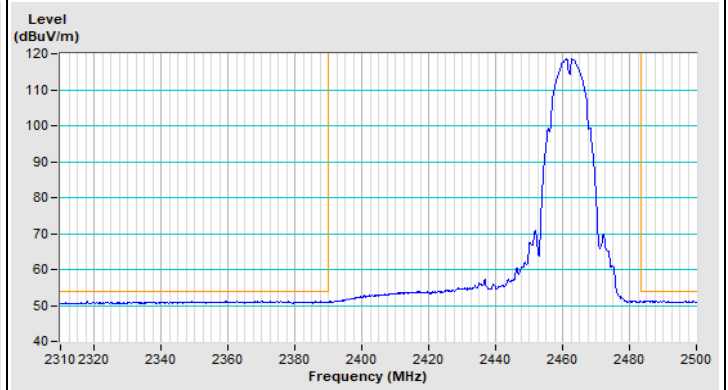

Horizontal (Average)

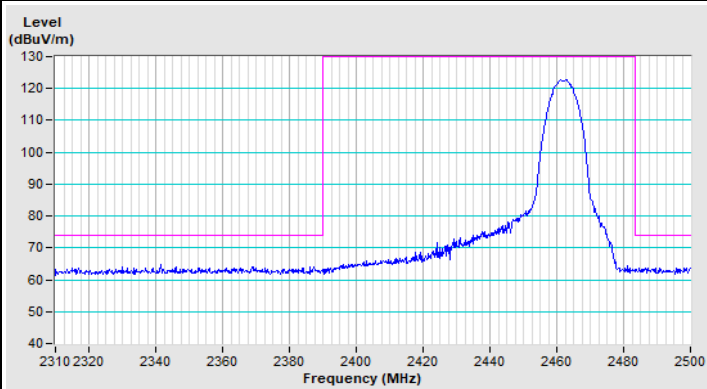

Vertical (Peak)

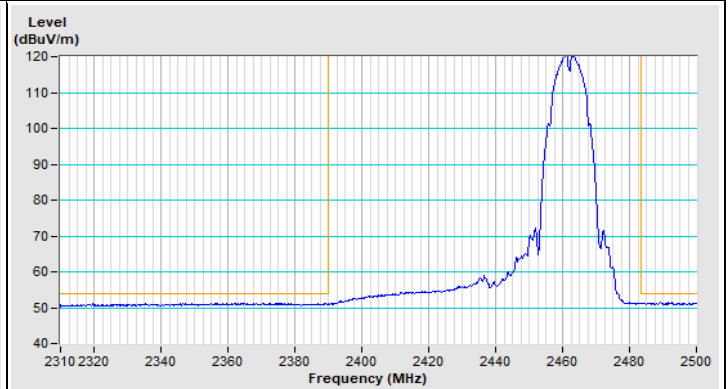

Vertical (Average)



802.11g Channel 1

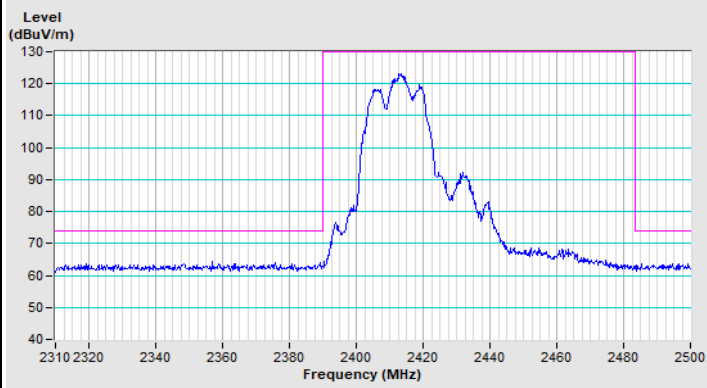

Horizontal (Peak)

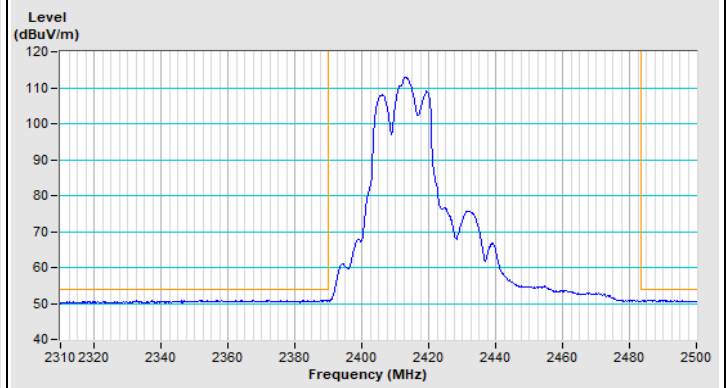

Horizontal (Average)

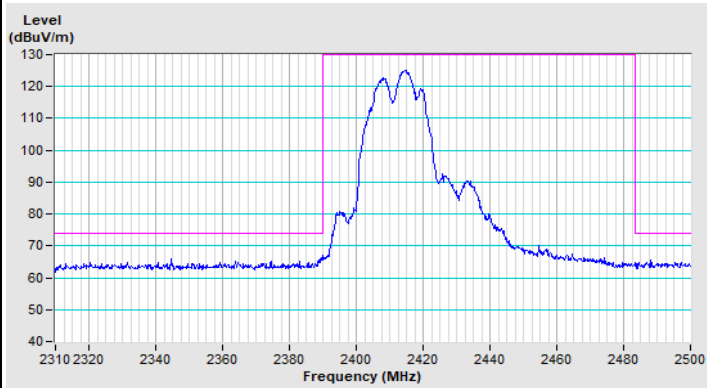

Vertical (Peak)

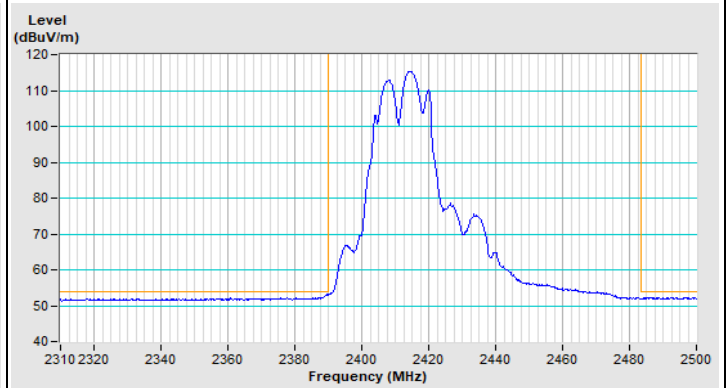

Vertical (Average)

802.11g Channel 11

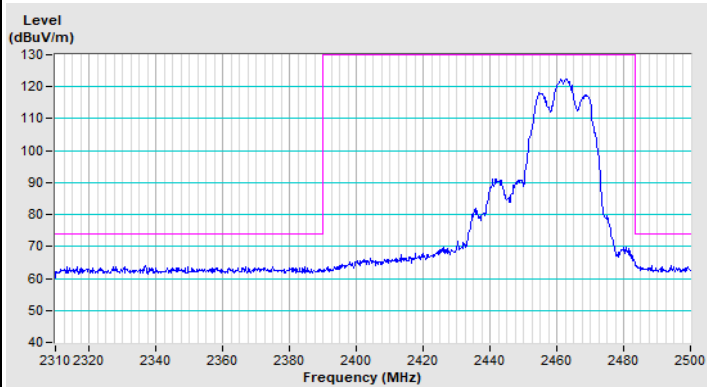

Horizontal (Peak)

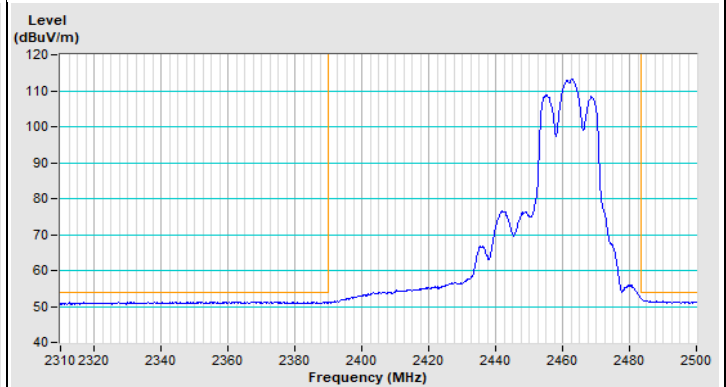

Horizontal (Average)

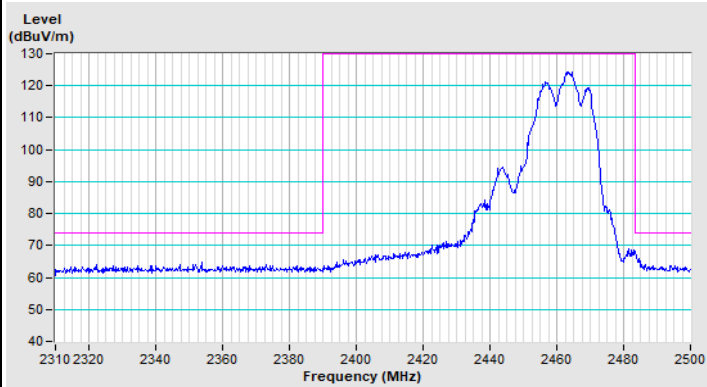

Vertical (Peak)

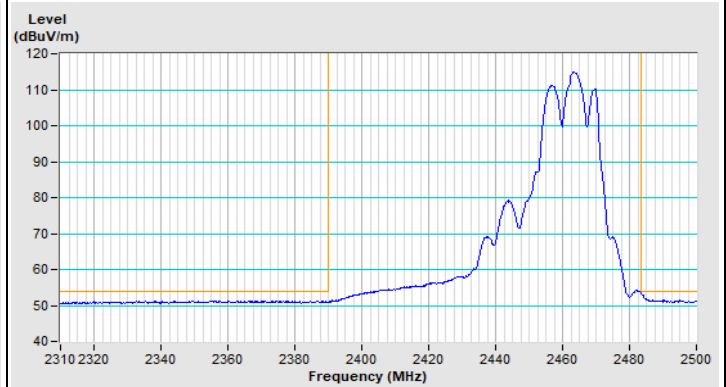

Vertical (Average)

802.11ax (HE20) Channel 1

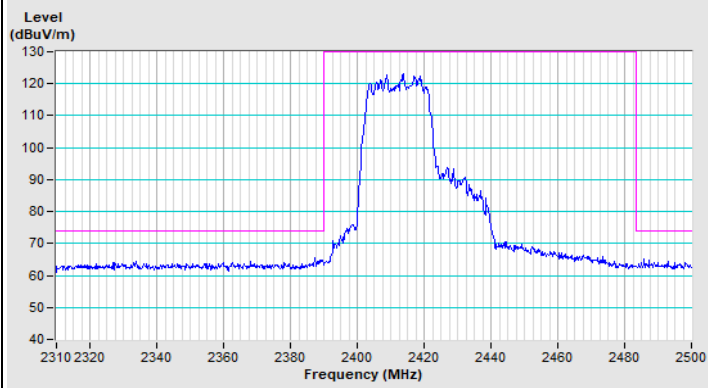

Horizontal (Peak)

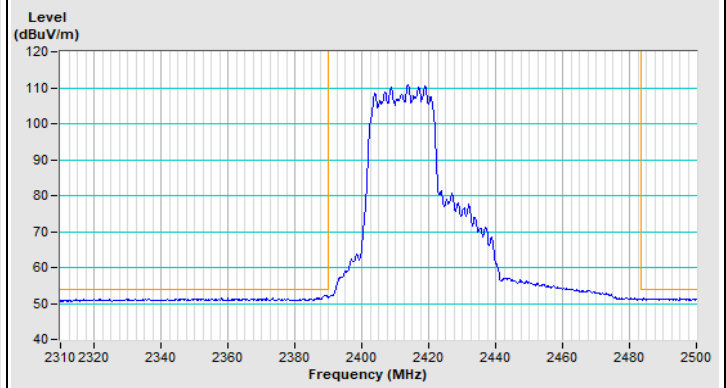

Horizontal (Average)

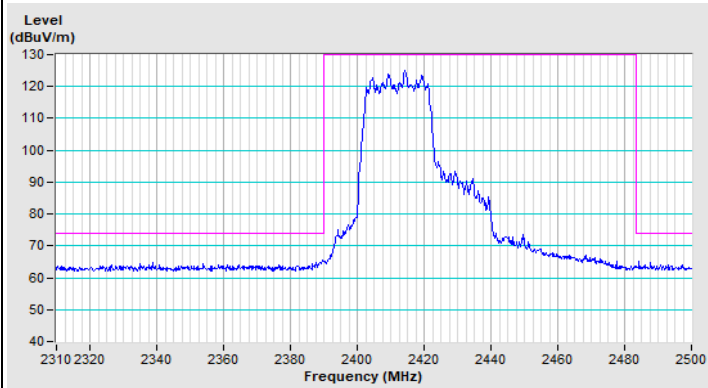

Vertical (Peak)

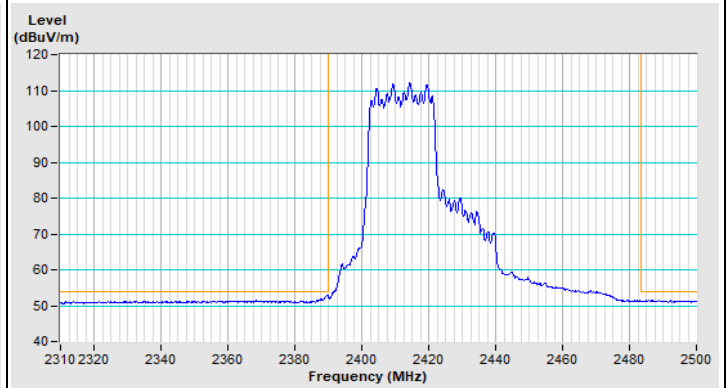

Vertical (Average)

802.11ax (HE20) Channel 11

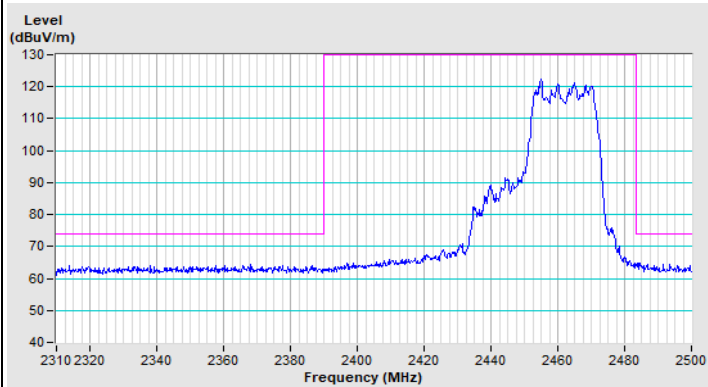

Horizontal (Peak)

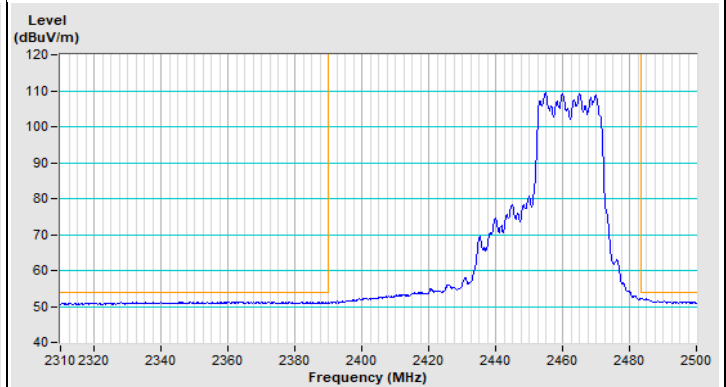

Horizontal (Average)

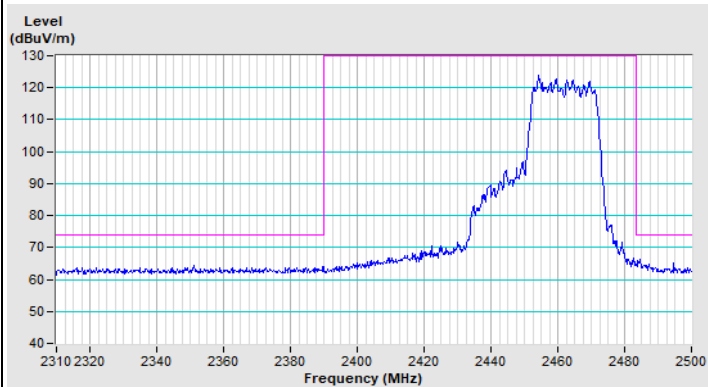

Vertical (Peak)

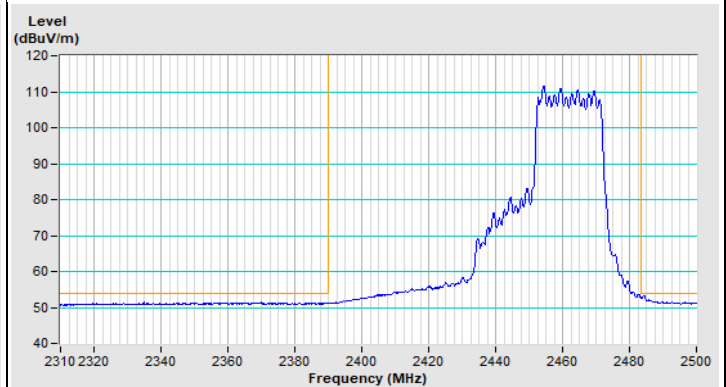

Vertical (Average)

802.11ax (HE40) Channel 3

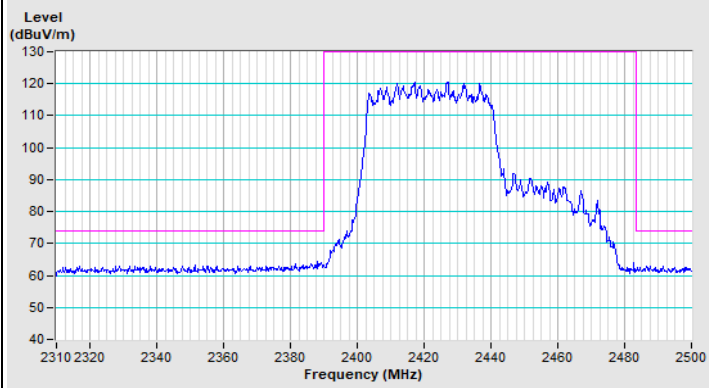

Horizontal (Peak)

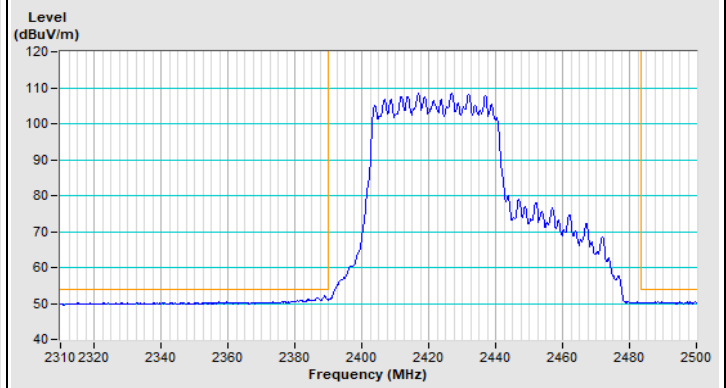

Horizontal (Average)

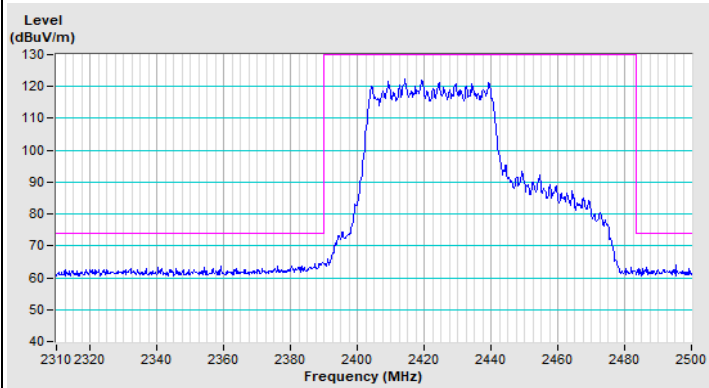

Vertical (Peak)

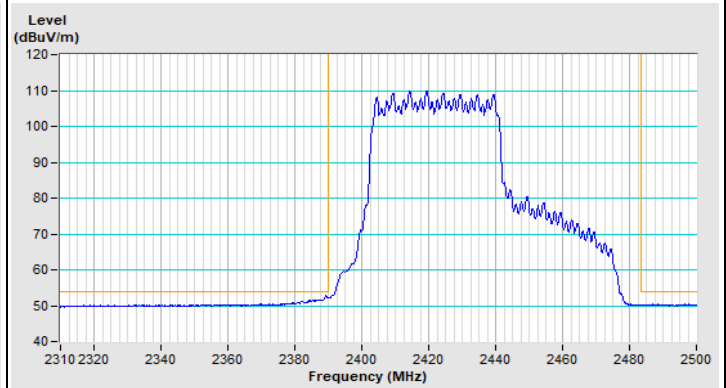

Vertical (Average)

802.11ax (HE40) Channel 9

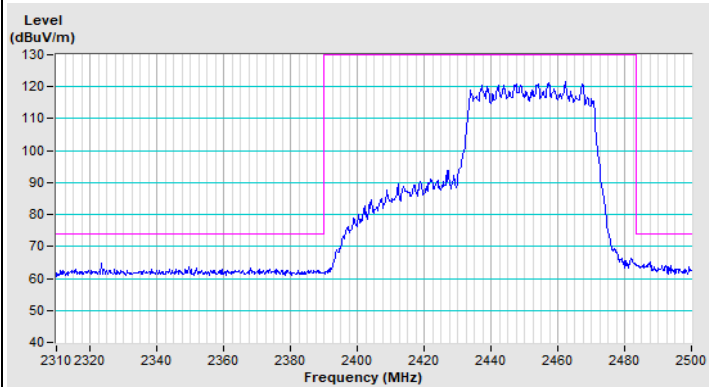

Horizontal (Peak)

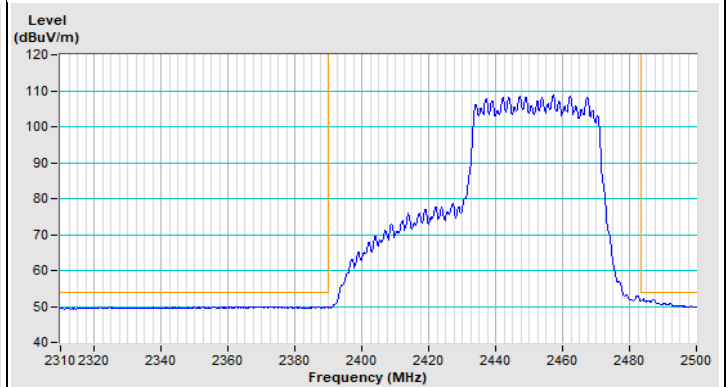

Horizontal (Average)

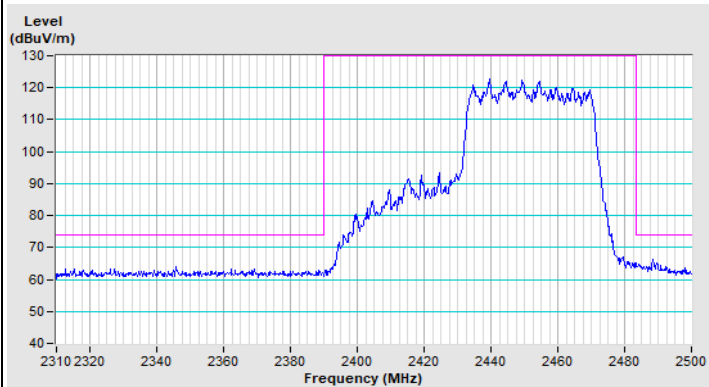

Vertical (Peak)

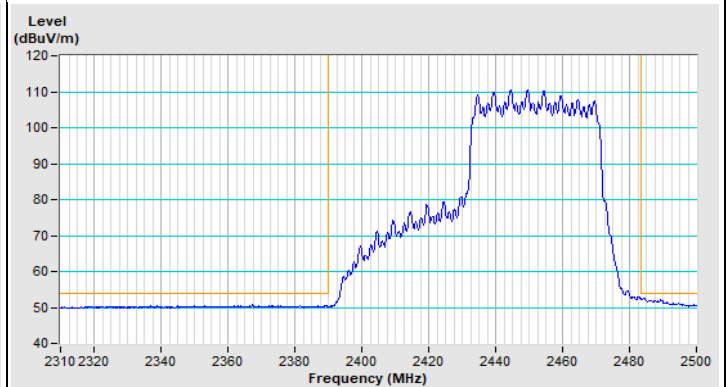

Vertical (Average)

Beamforming Mode

RF Mode	802.11ax (HE20)	Channel	CH 1 : 2412 MHz
Frequency Range	1 GHz ~ 25 GHz	Detector Function & Bandwidth	(PK) RB = 1 MHz, VB = 3 MHz (AV) RB = 1 MHz, VB = 10 Hz
Input Power	120 Vac, 60 Hz	Environmental Conditions	14°C, 58% RH
Tested By	Ian Chang		

Antenna Polarity & Test Distance : Horizontal at 3 m								
No	Frequency (MHz)	Emission Level (dBuV/m)	Limit (dBuV/m)	Margin (dB)	Antenna Height (m)	Table Angle (Degree)	Raw Value (dBuV)	Correction Factor (dB/m)
1	2390.00	61.7 PK	74.0	-12.3	2.40 H	6	62.8	-1.1
2	2390.00	48.5 AV	54.0	-5.5	2.40 H	6	49.6	-1.1
3	*2412.00	122.4 PK			2.40 H	6	123.5	-1.1
4	*2412.00	107.8 AV			2.40 H	6	108.9	-1.1
5	4824.00	50.2 PK	74.0	-23.8	1.85 H	66	42.5	7.7
6	4824.00	36.5 AV	54.0	-17.5	1.85 H	66	28.8	7.7
Antenna Polarity & Test Distance : Vertical at 3 m								
No	Frequency (MHz)	Emission Level (dBuV/m)	Limit (dBuV/m)	Margin (dB)	Antenna Height (m)	Table Angle (Degree)	Raw Value (dBuV)	Correction Factor (dB/m)
1	2390.00	62.8 PK	74.0	-11.2	1.83 V	344	63.9	-1.1
2	2390.00	49.0 AV	54.0	-5.0	1.83 V	344	50.1	-1.1
3	*2412.00	123.8 PK			1.83 V	344	124.9	-1.1
4	*2412.00	108.8 AV			1.83 V	344	109.9	-1.1
5	4824.00	49.5 PK	74.0	-24.5	1.40 V	285	41.8	7.7
6	4824.00	35.2 AV	54.0	-18.8	1.40 V	285	27.5	7.7

Remarks:

1. Emission Level(dBuV/m) = Raw Value(dBuV) + Correction Factor(dB/m)
2. Correction Factor(dB/m) = Antenna Factor(dB/m) + Cable Factor(dB) – Pre-Amplifier Factor(dB)
3. Margin value = Emission Level – Limit value
4. The other emission levels were very low against the limit.
5. " * ": Fundamental frequency, the limit was restricted at the RF Output Power.



RF Mode	802.11ax (HE20)	Channel	CH 6 : 2437 MHz
Frequency Range	1 GHz ~ 25 GHz	Detector Function & Bandwidth	(PK) RB = 1 MHz, VB = 3 MHz (AV) RB = 1 MHz, VB = 10 Hz
Input Power	120 Vac, 60 Hz	Environmental Conditions	14°C, 58% RH
Tested By	Ian Chang		

Antenna Polarity & Test Distance : Horizontal at 3 m								
No	Frequency (MHz)	Emission Level (dBuV/m)	Limit (dBuV/m)	Margin (dB)	Antenna Height (m)	Table Angle (Degree)	Raw Value (dBuV)	Correction Factor (dB/m)
1	*2437.00	122.0 PK			2.35 H	8	123.0	-1.0
2	*2437.00	107.2 AV			2.35 H	8	108.2	-1.0
3	4874.00	50.4 PK	74.0	-23.6	2.51 H	145	42.6	7.8
4	4874.00	36.4 AV	54.0	-17.6	2.51 H	145	28.6	7.8
Antenna Polarity & Test Distance : Vertical at 3 m								
No	Frequency (MHz)	Emission Level (dBuV/m)	Limit (dBuV/m)	Margin (dB)	Antenna Height (m)	Table Angle (Degree)	Raw Value (dBuV)	Correction Factor (dB/m)
1	*2437.00	123.1 PK			1.80 V	333	124.1	-1.0
2	*2437.00	108.8 AV			1.80 V	333	109.8	-1.0
3	4874.00	49.1 PK	74.0	-24.9	1.64 V	235	41.3	7.8
4	4874.00	35.4 AV	54.0	-18.6	1.64 V	235	27.6	7.8

Remarks:

1. Emission Level(dBuV/m) = Raw Value(dBuV) + Correction Factor(dB/m)
2. Correction Factor(dB/m) = Antenna Factor(dB/m) + Cable Factor(dB) – Pre-Amplifier Factor(dB)
3. Margin value = Emission Level – Limit value
4. The other emission levels were very low against the limit.
5. " * " : Fundamental frequency, the limit was restricted at the RF Output Power.



RF Mode	802.11ax (HE20)	Channel	CH 11 : 2462 MHz
Frequency Range	1 GHz ~ 25 GHz	Detector Function & Bandwidth	(PK) RB = 1 MHz, VB = 3 MHz (AV) RB = 1 MHz, VB = 10 Hz
Input Power	120 Vac, 60 Hz	Environmental Conditions	14°C, 58% RH
Tested By	Ian Chang		

Antenna Polarity & Test Distance : Horizontal at 3 m

No	Frequency (MHz)	Emission Level (dBuV/m)	Limit (dBuV/m)	Margin (dB)	Antenna Height (m)	Table Angle (Degree)	Raw Value (dBuV)	Correction Factor (dB/m)
1	*2462.00	123.0 PK			2.34 H	5	123.9	-0.9
2	*2462.00	108.4 AV			2.34 H	5	109.3	-0.9
3	2483.50	64.6 PK	74.0	-9.4	2.34 H	5	65.4	-0.8
4	2483.50	49.5 AV	54.0	-4.5	2.34 H	5	50.3	-0.8
5	4924.00	50.0 PK	74.0	-24.0	2.19 H	236	42.2	7.8
6	4924.00	36.3 AV	54.0	-17.7	2.19 H	236	28.5	7.8

Antenna Polarity & Test Distance : Vertical at 3 m

No	Frequency (MHz)	Emission Level (dBuV/m)	Limit (dBuV/m)	Margin (dB)	Antenna Height (m)	Table Angle (Degree)	Raw Value (dBuV)	Correction Factor (dB/m)
1	*2462.00	124.0 PK			1.87 V	330	124.9	-0.9
2	*2462.00	109.8 AV			1.87 V	330	110.7	-0.9
3	2483.50	65.3 PK	74.0	-8.7	1.87 V	330	66.1	-0.8
4	2483.50	50.3 AV	54.0	-3.7	1.87 V	330	51.1	-0.8
5	4924.00	49.1 PK	74.0	-24.9	1.84 V	178	41.3	7.8
6	4924.00	35.5 AV	54.0	-18.5	1.84 V	178	27.7	7.8

Remarks:

1. Emission Level(dBuV/m) = Raw Value(dBuV) + Correction Factor(dB/m)
2. Correction Factor(dB/m) = Antenna Factor(dB/m) + Cable Factor(dB) – Pre-Amplifier Factor(dB)
3. Margin value = Emission Level – Limit value
4. The other emission levels were very low against the limit.
5. " * ": Fundamental frequency, the limit was restricted at the RF Output Power.



RF Mode	802.11ax (HE40)	Channel	CH 3 : 2422 MHz
Frequency Range	1 GHz ~ 25 GHz	Detector Function & Bandwidth	(PK) RB = 1 MHz, VB = 3 MHz (AV) RB = 1 MHz, VB = 10 Hz
Input Power	120 Vac, 60 Hz	Environmental Conditions	14°C, 58% RH
Tested By	Ian Chang		

Antenna Polarity & Test Distance : Horizontal at 3 m

No	Frequency (MHz)	Emission Level (dBuV/m)	Limit (dBuV/m)	Margin (dB)	Antenna Height (m)	Table Angle (Degree)	Raw Value (dBuV)	Correction Factor (dB/m)
1	2390.00	62.4 PK	74.0	-11.6	2.39 H	5	63.5	-1.1
2	2390.00	49.2 AV	54.0	-4.8	2.39 H	5	50.3	-1.1
3	*2422.00	121.5 PK			2.39 H	5	122.5	-1.0
4	*2422.00	106.6 AV			2.39 H	5	107.6	-1.0
5	4844.00	50.0 PK	74.0	-24.0	2.21 H	145	42.3	7.7
6	4844.00	36.3 AV	54.0	-17.7	2.21 H	145	28.6	7.7

Antenna Polarity & Test Distance : Vertical at 3 m

No	Frequency (MHz)	Emission Level (dBuV/m)	Limit (dBuV/m)	Margin (dB)	Antenna Height (m)	Table Angle (Degree)	Raw Value (dBuV)	Correction Factor (dB/m)
1	2390.00	63.6 PK	74.0	-10.4	1.81 V	342	64.7	-1.1
2	2390.00	49.9 AV	54.0	-4.1	1.81 V	342	51.0	-1.1
3	*2422.00	122.5 PK			1.81 V	342	123.5	-1.0
4	*2422.00	107.6 AV			1.81 V	342	108.6	-1.0
5	4844.00	48.9 PK	74.0	-25.1	1.63 V	265	41.2	7.7
6	4844.00	35.0 AV	54.0	-19.0	1.63 V	265	27.3	7.7

Remarks:

1. Emission Level(dBuV/m) = Raw Value(dBuV) + Correction Factor(dB/m)
2. Correction Factor(dB/m) = Antenna Factor(dB/m) + Cable Factor(dB) – Pre-Amplifier Factor(dB)
3. Margin value = Emission Level – Limit value
4. The other emission levels were very low against the limit.
5. " * ": Fundamental frequency, the limit was restricted at the RF Output Power.



RF Mode	802.11ax (HE40)	Channel	CH 6 : 2437 MHz
Frequency Range	1 GHz ~ 25 GHz	Detector Function & Bandwidth	(PK) RB = 1 MHz, VB = 3 MHz (AV) RB = 1 MHz, VB = 10 Hz
Input Power	120 Vac, 60 Hz	Environmental Conditions	14°C, 58% RH
Tested By	Ian Chang		

Antenna Polarity & Test Distance : Horizontal at 3 m								
No	Frequency (MHz)	Emission Level (dBuV/m)	Limit (dBuV/m)	Margin (dB)	Antenna Height (m)	Table Angle (Degree)	Raw Value (dBuV)	Correction Factor (dB/m)
1	*2437.00	123.0 PK			2.35 H	4	124.0	-1.0
2	*2437.00	107.3 AV			2.35 H	4	108.3	-1.0
3	4874.00	50.1 PK	74.0	-23.9	2.25 H	218	42.3	7.8
4	4874.00	36.2 AV	54.0	-17.8	2.25 H	218	28.4	7.8
Antenna Polarity & Test Distance : Vertical at 3 m								
No	Frequency (MHz)	Emission Level (dBuV/m)	Limit (dBuV/m)	Margin (dB)	Antenna Height (m)	Table Angle (Degree)	Raw Value (dBuV)	Correction Factor (dB/m)
1	*2437.00	124.0 PK			1.86 V	320	125.0	-1.0
2	*2437.00	108.8 AV			1.86 V	320	109.8	-1.0
3	4874.00	49.2 PK	74.0	-24.8	1.69 V	265	41.4	7.8
4	4874.00	35.4 AV	54.0	-18.6	1.69 V	265	27.6	7.8

Remarks:

1. Emission Level(dBuV/m) = Raw Value(dBuV) + Correction Factor(dB/m)
2. Correction Factor(dB/m) = Antenna Factor(dB/m) + Cable Factor(dB) – Pre-Amplifier Factor(dB)
3. Margin value = Emission Level – Limit value
4. The other emission levels were very low against the limit.
5. " * " : Fundamental frequency, the limit was restricted at the RF Output Power.



RF Mode	802.11ax (HE40)	Channel	CH 9 : 2452 MHz
Frequency Range	1 GHz ~ 25 GHz	Detector Function & Bandwidth	(PK) RB = 1 MHz, VB = 3 MHz (AV) RB = 1 MHz, VB = 10 Hz
Input Power	120 Vac, 60 Hz	Environmental Conditions	14°C, 58% RH
Tested By	Ian Chang		

Antenna Polarity & Test Distance : Horizontal at 3 m

No	Frequency (MHz)	Emission Level (dBuV/m)	Limit (dBuV/m)	Margin (dB)	Antenna Height (m)	Table Angle (Degree)	Raw Value (dBuV)	Correction Factor (dB/m)
1	*2452.00	122.0 PK			2.41 H	9	122.9	-0.9
2	*2452.00	107.6 AV			2.41 H	9	108.5	-0.9
3	2483.50	65.4 PK	74.0	-8.6	2.41 H	9	66.2	-0.8
4	2483.50	52.0 AV	54.0	-2.0	2.41 H	9	52.8	-0.8
5	4904.00	50.4 PK	74.0	-23.6	1.78 H	145	42.6	7.8
6	4904.00	36.5 AV	54.0	-17.5	1.78 H	145	28.7	7.8

Antenna Polarity & Test Distance : Vertical at 3 m

No	Frequency (MHz)	Emission Level (dBuV/m)	Limit (dBuV/m)	Margin (dB)	Antenna Height (m)	Table Angle (Degree)	Raw Value (dBuV)	Correction Factor (dB/m)
1	*2452.00	122.7 PK			1.89 V	317	123.6	-0.9
2	*2452.00	108.6 AV			1.89 V	317	109.5	-0.9
3	2483.50	66.5 PK	74.0	-7.5	1.89 V	317	67.3	-0.8
4	2483.50	53.0 AV	54.0	-1.0	1.89 V	317	53.8	-0.8
5	4904.00	49.4 PK	74.0	-24.6	1.88 V	255	41.6	7.8
6	4904.00	35.4 AV	54.0	-18.6	1.88 V	255	27.6	7.8

Remarks:

1. Emission Level(dBuV/m) = Raw Value(dBuV) + Correction Factor(dB/m)
2. Correction Factor(dB/m) = Antenna Factor(dB/m) + Cable Factor(dB) – Pre-Amplifier Factor(dB)
3. Margin value = Emission Level – Limit value
4. The other emission levels were very low against the limit.
5. " * ": Fundamental frequency, the limit was restricted at the RF Output Power.



Plot of Band Edge_Beamforming Mode

802.11ax (HE20) Channel 1

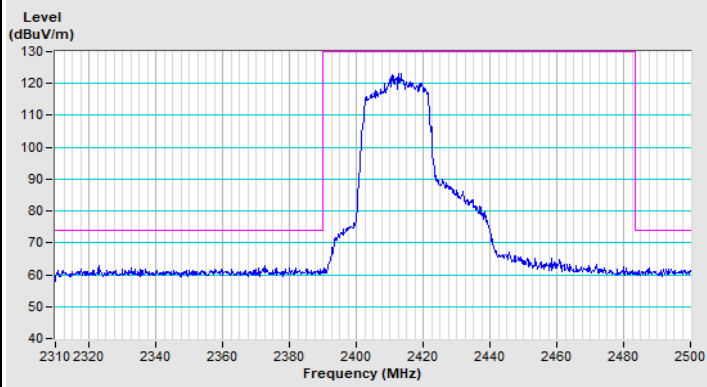

Horizontal (Peak)

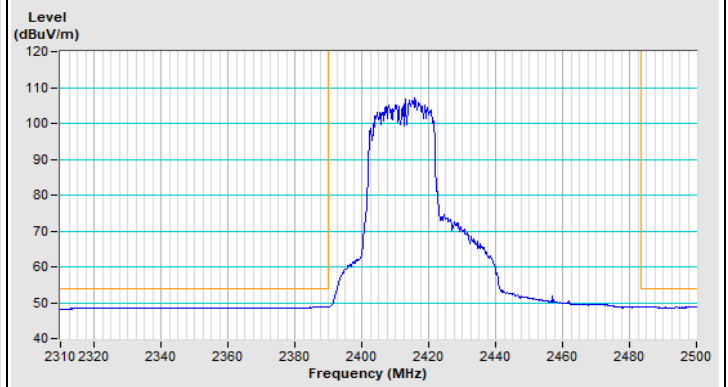

Horizontal (Average)

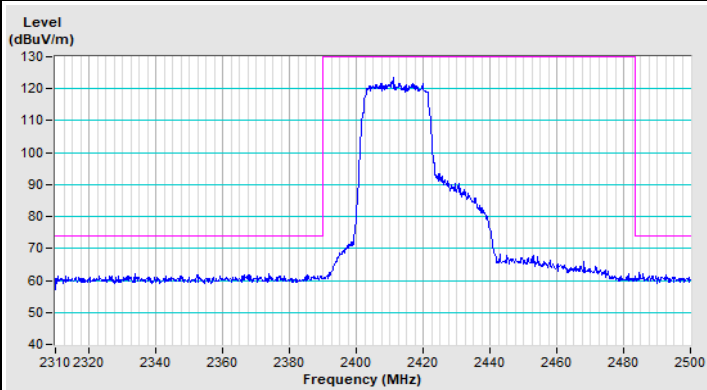

Vertical (Peak)

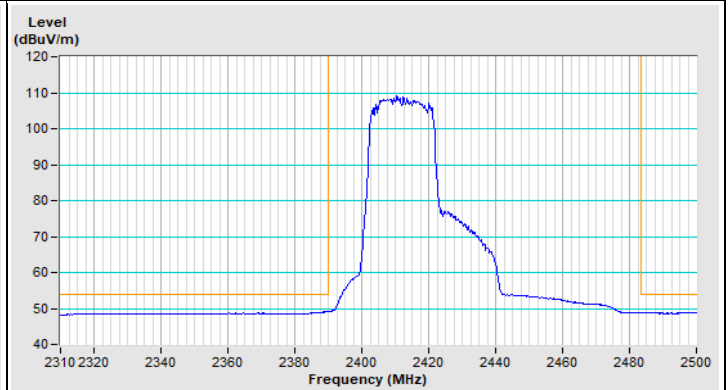

Vertical (Average)

802.11ax (HE20) Channel 11

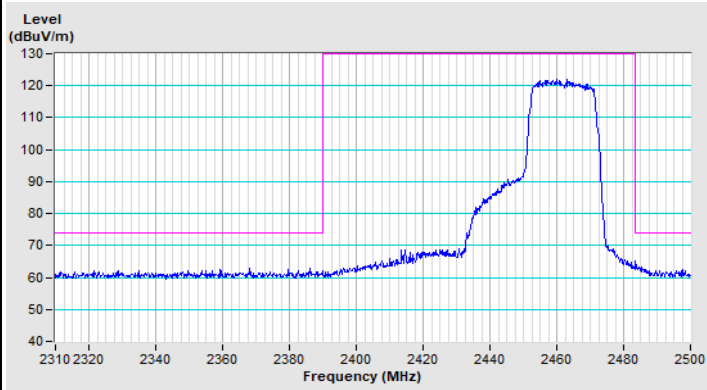

Horizontal (Peak)

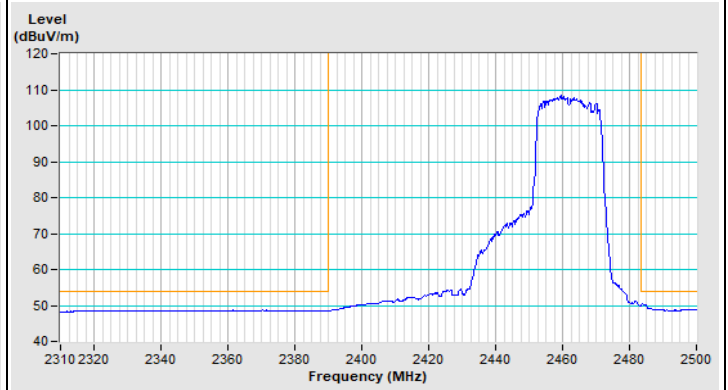

Horizontal (Average)

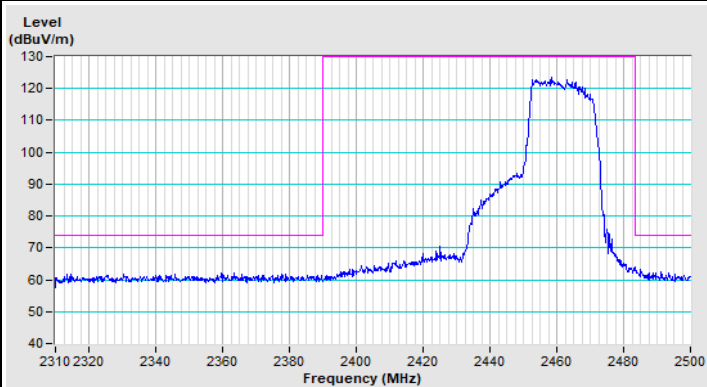

Vertical (Peak)

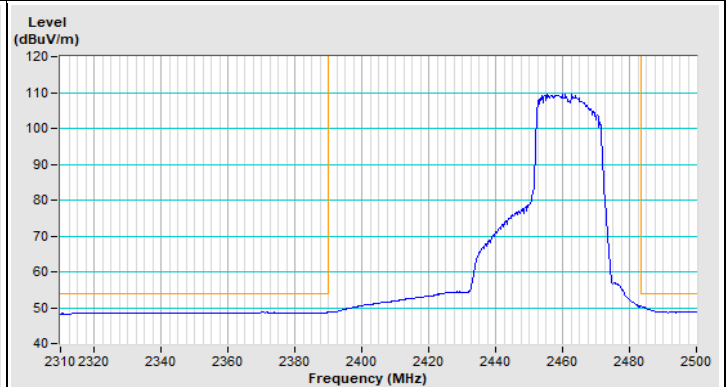

Vertical (Average)

802.11ax (HE40) Channel 3

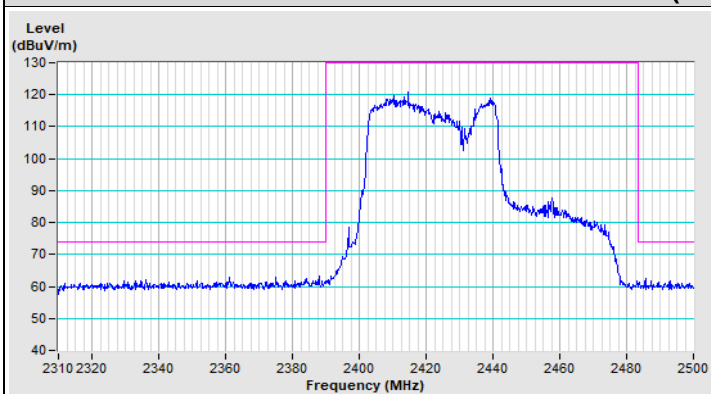

Horizontal (Peak)

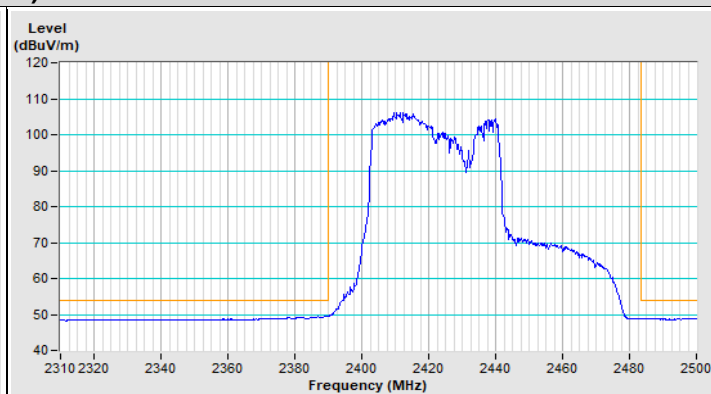

Horizontal (Average)

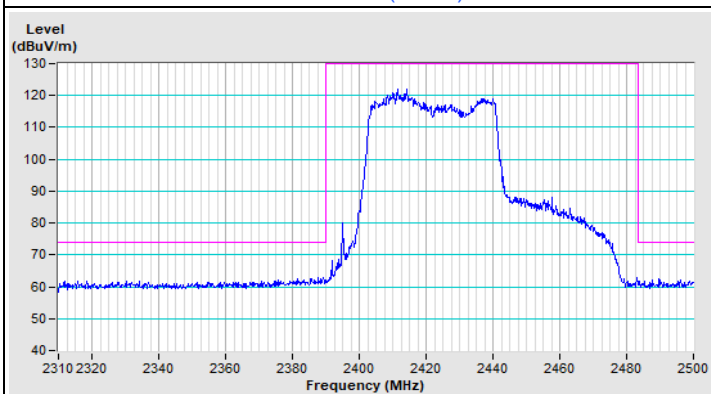

Vertical (Peak)

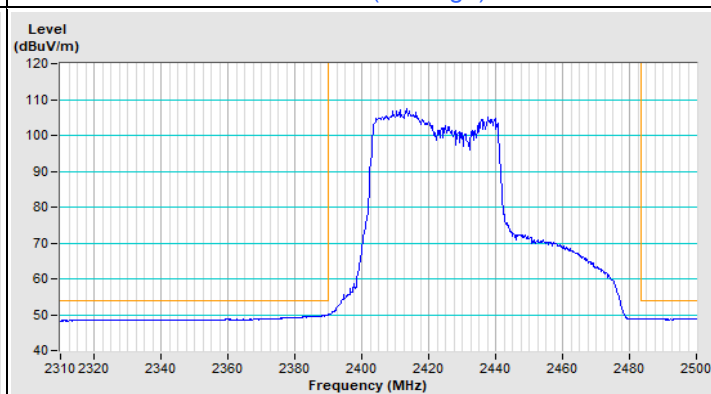

Vertical (Average)

802.11ax (HE40) Channel 9

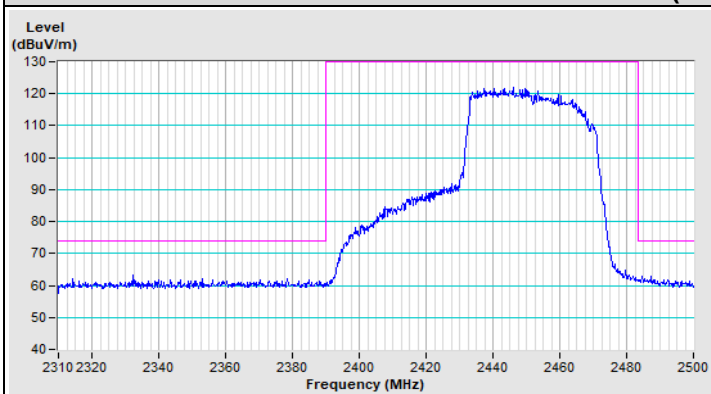

Horizontal (Peak)

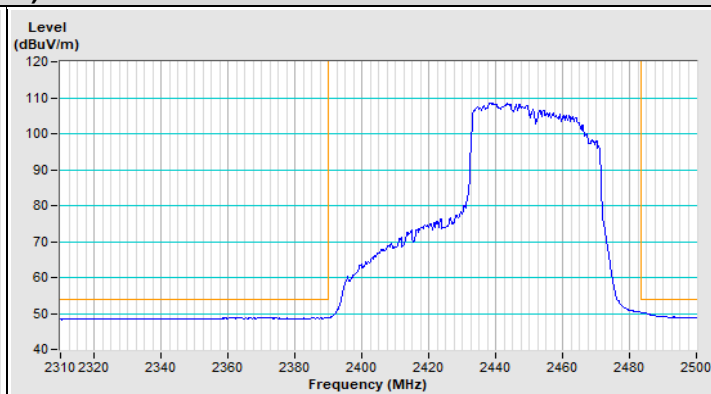

Horizontal (Average)

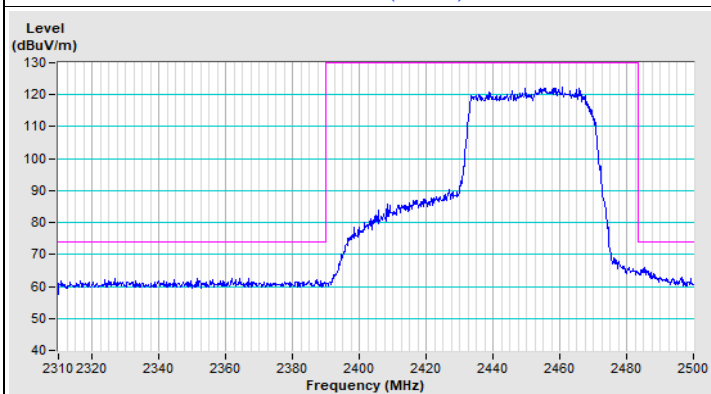

Vertical (Peak)

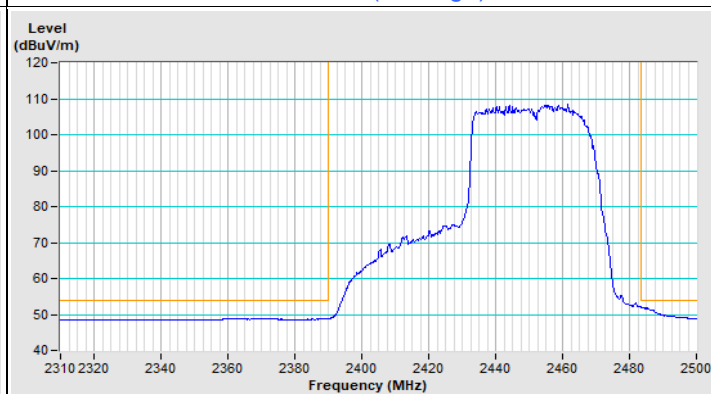

Vertical (Average)

8 Pictures of Test Arrangements

Please refer to the attached file (Test Setup Photo)

9 Information of the Testing Laboratories

We, Bureau Veritas Consumer Products Services (H.K.) Ltd., Taoyuan Branch, were founded in 1988 to provide our best service in EMC, Radio, Telecom and Safety consultation. Our laboratories are FCC recognized accredited test firms and accredited according to ISO/IEC 17025.

If you have any comments, please feel free to contact us at the following:

Lin Kou EMC/RF Lab

Tel: 886-2-26052180

Fax: 886-2-26051924

Hsin Chu EMC/RF/Telecom Lab

Tel: 886-3-6668565

Fax: 886-3-6668323

Hwa Ya EMC/RF/Safety Lab

Tel: 886-3-3183232

Fax: 886-3-3270892

Email: service.adt@bureauveritas.com

Web Site: <http://ee.bureauveritas.com.tw>

The address and road map of all our labs can be found in our web site also.

--- END ---