

FCC Test Report

FCC ID : NKR-KM66
Equipment : WLAN Module
Model No. : DAUB-KM66
Brand Name : Konica Minolta
Applicant : Wistron NeWeb Corp.
Address : 20 Park Avenue II, Hsinchu Science Park,
Hsinchu 308, Taiwan, R.O.C.
Standard : 47 CFR FCC Part 15.407
Received Date : Aug. 06, 2015
Tested Date : Aug. 06 ~ Dec. 28, 2015

We, International Certification Corp., would like to declare that the tested sample has been evaluated and in compliance with the requirement of the above standards. The test results contained in this report refer exclusively to the product. It may be duplicated completely for legal use with the approval of the applicant. It shall not be reproduced except in full without the written approval of our laboratory.

Approved & Reviewed by:



Gary Chang / Manager



Table of Contents

1	GENERAL DESCRIPTION	5
1.1	Information.....	5
1.2	Local Support Equipment List	10
1.3	Test Setup Chart	10
1.4	The Equipment List	11
1.5	Testing Applied Standards	13
1.6	Measurement Uncertainty	13
2	TEST CONFIGURATION	14
2.1	Testing Condition	14
2.2	The Worst Test Modes and Channel Details	14
3	TRANSMITTER TEST RESULTS.....	16
3.1	Conducted Emissions.....	16
3.2	Emission Bandwidth	25
3.3	RF Output Power	33
3.4	Peak Power Spectral Density	41
3.5	Transmitter Radiated and Band Edge Emissions	48
3.6	Frequency Stability.....	143
4	TEST LABORATORY INFORMATION	145

Release Record

Report No.	Version	Description	Issued Date
FR4N2501-02AN	Rev. 01	Initial issue	Jun. 07, 2016

Summary of Test Results

FCC Rules	Test Items	Measured	Result
15.207	Conducted Emissions	[dBuV]: 0.507MHz 36.25 (Margin -9.75dB) - AV	Pass
15.407(b) 15.209	Radiated Emissions	[dBuV/m at 3m]: 15600.00MHz 52.99 (Margin -1.01dB) - AV	Pass
15.407(a)	Emission Bandwidth	Meet the requirement of limit	Pass
15.407(e)	6dB bandwidth	Meet the requirement of limit	Pass
15.407(a)	RF Output Power	Max Power [dBm]: 5150~5250MHz: 17.91 5250~5350MHz: 18.16 5470~5725MHz: 22.76 5725~5850MHz: 21.43	Pass
15.407(a)	Peak Power Spectral Density	Meet the requirement of limit	Pass
15.407(g)	Frequency Stability	Meet the requirement of limit	Pass
15.203	Antenna Requirement	Meet the requirement of limit	Pass

1 General Description

1.1 Information

1.1.1 Specification of the Equipment under Test (EUT)

RF General Information					
Frequency Range (MHz)	IEEE Std. 802.11	Ch. Freq. (MHz)	Channel Number	Transmit Chains (N _{TX})	Data Rate / MCS
5150-5250 5250-5350 5470-5725 5725-5850	a	5180-5240 5260-5320 5500-5720 5745-5825	36-48 [4] 52-64 [4] 100-144 [12] 149-165 [5]	2	6-54 Mbps
5150-5250 5250-5350 5470-5725 5725-5850	n (HT20)	5180-5240 5260-5320 5500-5720 5745-5825	36-48 [4] 52-64 [4] 100-144 [12] 149-165 [5]	2	MCS 0-15
5150-5250 5250-5350 5470-5725 5725-5850	n (HT40)	5190-5230 5270-5310 5510-5710 5755-5795	38-46 [2] 54-62 [2] 102-142 [6] 151-159 [2]	2	MCS 0-15
5150-5250 5250-5350 5470-5725 5725-5850	ac (VHT20)	5180-5240 5260-5320 5500-5720 5745-5825	36-48 [4] 52-64 [4] 100-144 [12] 149-165 [5]	2	MCS 0-9
5150-5250 5250-5350 5470-5725 5725-5850	ac (VHT40)	5190-5230 5270-5310 5510-5710 5755-5795	38-46 [2] 54-62 [2] 102-142 [6] 151-159 [2]	2	MCS 0-9
5150-5250 5250-5350 5470-5725 5725-5850	ac (VHT80)	5210 5290 5530~5690 5775	42 [1] 58 [1] 106-138 [3] 155 [1]	2	MCS 0-9

Note 1: RF output power specifies that Maximum Conducted Output Power.
 Note 2: 802.11a/n/ac uses a combination of OFDM-BPSK, QPSK, 16QAM, 64QAM, 256QAM modulation.
 Note 3: 802.11n/ac supports beamforming function.

1.1.2 Antenna Details

Ant. No.	Model	Type	Connector	Operating Frequencies (MHz) / Antenna Gain (dBi)				
				2400~2483.5	5150~5250	5250~5350	5470~5725	5725~5850
1	Wi Fi up	Printed	N/A	3.26	3.3	3.17	3.31	3.33
2	Wi Fi down	Printed	N/A	4.15	3.1	3.1	2.73	2.65

1.1.3 Power Supply Type of Equipment under Test (EUT)

Power Supply Type	5Vdc from host
--------------------------	----------------

1.1.4 Channel List

802.11 a / HT20 / VHT20		HT40 / VHT40	
Channel	Frequency(MHz)	Channel	Frequency(MHz)
36	5180	38	5190
40	5200	46	5230
44	5220	54	5270
48	5240	62	5310
52	5260	102	5510
56	5280	110	5550
60	5300	118	5590
64	5320	126	5630
100	5500	134	5670
104	5520	142	5710
108	5540	151	5755
112	5560	159	5795
116	5580	VHT80	
120	5600	42	5210
124	5620	58	5290
128	5640	106	5530
132	5660	122	5610
136	5680	138	5690
140	5700	155	5775
144	5720	---	---
149	5745	---	---
153	5765	---	---
157	5785	---	---
161	5805	---	---
165	5825	---	---

1.1.5 Test Tool and Duty Cycle

Test Tool	Non-beamforming: Mtool, V2.0.1.1		
Duty Cycle and Duty Factor	Mode	Duty cycle (%)	Duty factor (dB)
	11a	99.70%	0.01

Test Tool	Beamforming: LanTest		
Duty Cycle and Duty Factor	Mode	Duty cycle (%)	Duty factor (dB)
	VHT20	99.26%	0.03
	VHT40	98.22%	0.08
	VHT80	95.88%	0.18

1.1.6 Power Setting

For Frequency band 5150-5250 MHz		
Modulation Mode	Test Frequency (MHz)	Power Set
11a	5180	62
11a	5200	60
11a	5240	56
HT20	5180	58
HT20	5200	54
HT20	5240	54
HT40	5190	58
HT40	5230	60
VHT20	5180	58
VHT20	5200	54
VHT20	5240	54
VHT40	5190	58
VHT40	5230	60
VHT80	5210	52

For Frequency band 5250~5350 MHz		
Modulation Mode	Test Frequency (MHz)	Power Set
11a	5260	56
11a	5300	60
11a	5320	62
HT20	5260	56
HT20	5300	56
HT20	5320	62
HT40	5270	60
HT40	5310	58
VHT20	5260	56
VHT20	5300	56
VHT20	5320	62
VHT40	5270	60
VHT40	5310	58
VHT80	5290	56

For Frequency band 5470~5725 MHz		
Modulation Mode	Test Frequency (MHz)	Power Set
11a	5500	58
11a	5580	80
11a	5700	58
HT20	5500	60
HT20	5580	80
HT20	5700	62
HT40	5510	46
HT40	5550	80
HT40	5670	60
VHT20	5500	60
VHT20	5580	80
VHT20	5700	62
VHT40	5510	46
VHT40	5590	80
VHT40	5670	60
VHT80	5530	32

Channel that extends across the 5.725 GHz boundary

For Frequency band 5470~5725 MHz		
Modulation Mode	Test Frequency (MHz)	Power Set
11a	5720	80
HT20	5720	80
HT40	5710	80
VHT20	5720	80
VHT40	5710	80
VHT80	5690	80

For Frequency band 5725~5850 MHz		
Modulation Mode	Test Frequency (MHz)	Power Set
11a	5745	60
11a	5785	80
11a	5825	70
HT20	5745	60
HT20	5785	80
HT20	5825	68
HT40	5755	48
HT40	5795	64
VHT20	5745	60
VHT20	5785	80
VHT20	5825	68
VHT40	5755	48
VHT40	5795	64
VHT80	5775	40

1.2 Local Support Equipment List

Support Equipment List					
No.	Equipment	Brand	Model	FCC ID	Signal cable / Length (m)
1	Notebook	DELL	Latitude E6440	DoC	USB, 1m shielded w/o core.
2	Fixture	---	---	---	---

Note: No.2 was supplied by applicant.

1.3 Test Setup Chart

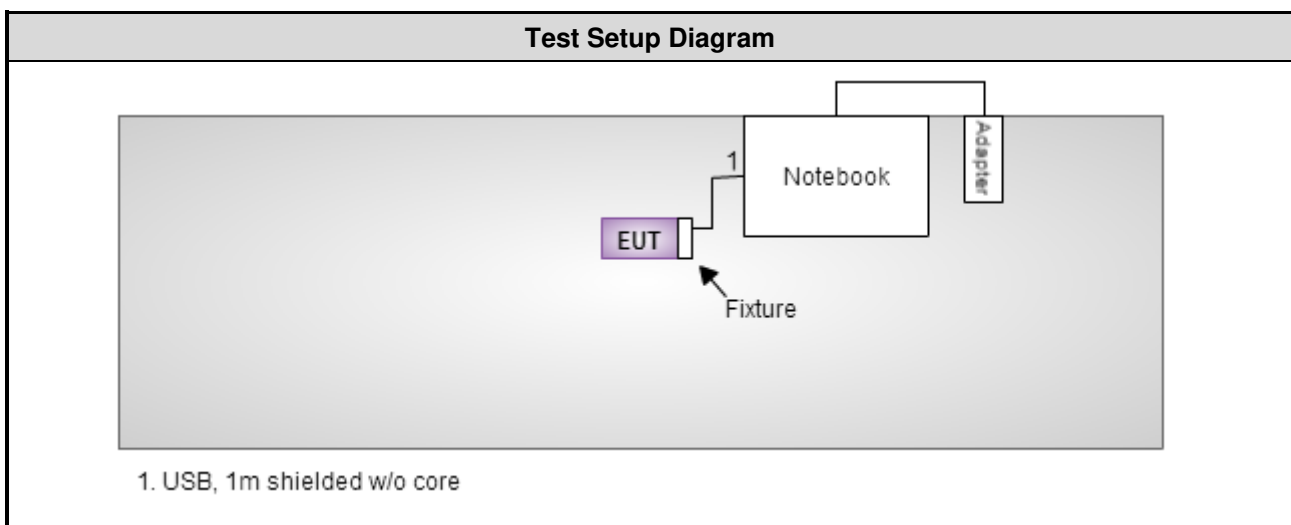

1.4 The Equipment List

Test Item	Conducted Emission				
Test Site	Conduction room 1 / (CO01-WS)				
Tested Date	Dec. 02, 2015				
Instrument	Manufacturer	Model No.	Serial No.	Calibration Date	Calibration Until
EMC Receiver	R&S	ESCS 30	100169	Oct. 21, 2015	Oct. 20, 2016
LISN	SCHWARZBECK	Schwarzbeck 8127	8127-667	Nov. 13, 2015	Nov. 12, 2016
RF Cable-CON	Woken	CFD200-NL	CFD200-NL-001	Dec. 31, 2014	Dec. 30, 2015
Measurement Software	AUDIX	e3	6.120210k	NA	NA
Note: Calibration Interval of instruments listed above is one year.					

Test Item	Radiated Emission				
Test Site	966 chamber 3 / (03CH03-WS)				
Tested Date	Aug. 06, 2015				
Instrument	Manufacturer	Model No.	Serial No.	Calibration Date	Calibration Until
Spectrum Analyzer	Agilent	N9010A	MY53400091	Sep. 16, 2014	Sep. 15, 2015
Receiver	Agilent	N9038A	MY53290044	Oct. 21, 2014	Oct. 20, 2015
Bilog Antenna	SCHWARZBECK	VULB9168	VULB9168-562	Jan. 19, 2015	Jan. 18, 2016
Horn Antenna 1G-18G	SCHWARZBECK	BBHA 9120 D	BBHA 9120 D 1206	Feb. 03, 2015	Feb. 02, 2016
Horn Antenna 18G-40G	SCHWARZBECK	BBHA 9170	BBHA 9170517	Nov. 10, 2014	Nov. 09, 2015
Loop Antenna	R&S	HFH2-Z2	11900	Nov. 10, 2014	Nov. 09, 2015
Preamplifier	EMC	EMC02325	980187	Sep. 26, 2014	Sep. 25, 2015
Preamplifier	Agilent	83017A	MY53270014	Sep. 17, 2014	Sep. 16, 2015
Preamplifier	EMC	EMC184045B	980192	Aug. 26, 2014	Aug. 25, 2015
RF cable-3M	HUBER+SUHNER	SUCOFLEX104	MY22620/4	Feb. 09, 2015	Feb. 08, 2016
RF cable-8M	HUBER+SUHNER	SUCOFLEX104	MY22601/4	Feb. 09, 2015	Feb. 08, 2016
RF cable-1M	HUBER+SUHNER	SUCOFLEX104	MY22624/4	Feb. 09, 2015	Feb. 08, 2016
LF cable-0.8M	EMC	EMC8D-NM-NM-800	EMC8D-NM-NM-800-001	Feb. 09, 2015	Feb. 08, 2016
LF cable-3M	EMC	EMC8D-NM-NM-3000	131103	Feb. 09, 2015	Feb. 08, 2016
LF cable-13M	EMC	EMC8D-NM-NM-13000	131104	Feb. 09, 2015	Feb. 08, 2016
Measurement Software	AUDIX	e3	6.120210g	NA	NA
Note: Calibration Interval of instruments listed above is one year.					

Test Item	Radiated Emission				
Test Site	966 chamber 3 / (03CH03-WS)				
Tested Date	Dec. 04 ~ Dec. 24, 2015				
Instrument	Manufacturer	Model No.	Serial No.	Calibration Date	Calibration Until
Spectrum Analyzer	Agilent	N9010A	MY53400091	Sep. 14, 2015	Sep. 13, 2016
Receiver	Agilent	N9038A	MY53290044	Oct. 14, 2015	Oct. 13, 2016
Bilog Antenna	SCHWARZBECK	VULB9168	VULB9168-563	Dec. 30, 2014	Dec. 29, 2015
Horn Antenna 1G-18G	SCHWARZBECK	BBHA 9120 D	BBHA 9120 D 1206	Feb. 03, 2015	Feb. 02, 2016
Horn Antenna 18G-40G	SCHWARZBECK	BBHA 9170	BBHA 9170517	Nov. 04, 2015	Nov. 03, 2016
Preamplifier	EMC	EMC02325	980187	Sep. 21, 2015	Sep. 20, 2016
Preamplifier	Agilent	83017A	MY53270014	Sep. 07, 2015	Sep. 06, 2016
Preamplifier	EMC	EMC184045B	980192	Sep. 01, 2015	Aug. 31, 2016
RF cable-3M	HUBER+SUHNER	SUCOFLEX104	MY22620/4	Feb. 09, 2015	Feb. 08, 2016
RF cable-8M	HUBER+SUHNER	SUCOFLEX104	MY22600/4	Feb. 09, 2015	Feb. 08, 2016
RF cable-1M	HUBER+SUHNER	SUCOFLEX104	MY22624/4	Feb. 09, 2015	Feb. 08, 2016
LF cable-0.8M	EMC	EMC8D-NM-NM-800	EMC8D-NM-NM-800-001	Feb. 09, 2015	Feb. 08, 2016
LF cable-3M	EMC	EMC8D-NM-NM-3000	131103	Feb. 09, 2015	Feb. 08, 2016
LF cable-13M	EMC	EMC8D-NM-NM-13000	131104	Feb. 09, 2015	Feb. 08, 2016
Measurement Software	AUDIX	e3	6.120210g	NA	NA

Note: Calibration Interval of instruments listed above is one year.

Test Item	RF Conducted				
Test Site	(TH01-WS)				
Tested Date	Dec. 24 ~ Dec. 28, 2015				
Instrument	Manufacturer	Model No.	Serial No.	Calibration Date	Calibration Until
Spectrum Analyzer	R&S	FSV40	101063	Feb. 03, 2015	Feb. 02, 2016
Spectrum Analyzer	Agilent	N9010A	MY53400091	Sep. 14, 2015	Sep. 13, 2016
TEMP&HUMIDITY CHAMBER	GIANT FORCE	GCT-225-40-SP-SD	MAF1212-002	Nov. 27, 2015	Nov. 26, 2016
Power Meter	Anritsu	ML2495A	1241002	Sep. 21, 2015	Sep. 20, 2016
Power Sensor	Anritsu	MA2411B	1207366	Sep. 21, 2015	Sep. 20, 2016
Signal Generator	R&S	SMB100A	175727	Oct. 05, 2015	Oct. 04, 2016
Measurement Software	Sporton	Sporton_1	1.3.30	NA	NA

Note: Calibration Interval of instruments listed above is one year.

1.5 Testing Applied Standards

According to the specification of EUT, the EUT must comply with following standards and KDB documents.

47 CFR FCC Part 15.407

ANSI C63.10-2013

FCC KDB 789033 D02 General UNII Test Procedures New Rules v01r02

FCC KDB 644545 D03 Guidance for IEEE 802.11ac New Rules v01

FCC KDB 662911 D01 Multiple Transmitter Output v02r01

FCC KDB 412172 D01 Determining ERP and EIRP v01r01

1.6 Measurement Uncertainty

ISO/IEC 17025 requires that an estimate of the measurement uncertainties associated with the emissions test results be included in the report. The measurement uncertainties given below are based on a 95% confidence level (based on a coverage factor $k=2$)

Measurement Uncertainty	
Parameters	Uncertainty
Bandwidth	± 34.134 Hz
Conducted power	± 0.808 dB
Frequency error	± 34.134 Hz
Power density	± 0.463 dB
Conducted emission	± 2.670 dB
AC conducted emission	± 2.92 dB
Radiated emission ≤ 1 GHz	± 3.99 dB
Radiated emission > 1 GHz	± 5.52 dB
Time	$\pm 0.1\%$
Temperature	± 0.6 °C

2 Test Configuration

2.1 Testing Condition

Test Item	Test Site	Ambient Condition	Tested By
AC Conduction	CO01-WS	23°C / 52%	Peter Lin
Radiated Emissions	03CH03-WS	21-22°C / 60-67%	Morgan Chen Warren Lee Aska Huang
RF Conducted	TH01-WS	22°C / 64%	Alex Huang

- FCC site registration No.: 390588
- IC site registration No.: 10807C-1

2.2 The Worst Test Modes and Channel Details

Non-beamforming mode

Frequency band 5150~5250 MHz / 5250~5350 MHz / 5470~5725 MHz				
Test item	Modulation Mode	Test Frequency (MHz)	Data Rate (Mbps) / MCS	Test Configuration
Conducted Emissions	11a	5580	6 Mbps	---
Radiated Emissions ≤ 1 GHz	11a	5580	6 Mbps	---
RF Output Power Radiated Emissions > 1 GHz Emission Bandwidth Peak Power Spectral Density	11a	5180 / 5200 / 5240 / 5260 / 5300 5320 / 5500 / 5580 / 5700 / 5720	6 Mbps	---
Frequency Stability	Un-modulation	5320	---	---

NOTE: The EUT was pretested with 3 orientations placed on the table for the radiated emission measurement – X, Y, and Z-plane. The **Y-plane** results were found as the worst case and were shown in this report.

Frequency band 5725-5850 MHz				
Test item	Modulation Mode	Test Frequency (MHz)	Data Rate (Mbps) / MCS	Test Configuration
Conducted Emissions	11a	5785	6 Mbps	---
Radiated Emissions ≤ 1 GHz	11a	5785	6 Mbps	---
RF Output Power Radiated Emissions > 1 GHz Emission Bandwidth 6dB bandwidth Peak Power Spectral Density	11a	5745 / 5785 / 5825	6 Mbps	---
Frequency Stability	Un-modulation	5785	---	---

NOTE: The EUT was pretested with 3 orientations placed on the table for the radiated emission measurement – X, Y, and Z-plane. The **Y-plane** results were found as the worst case and were shown in this report.

Beamforming mode

Frequency band 5150~5250 MHz / 5250~5350 MHz / 5470~5725 MHz				
Test item	Modulation Mode	Test Frequency (MHz)	Data Rate (Mbps) / MCS	Test Configuration
Conducted Emissions	VHT20	5580	MCS 0	---
Radiated Emissions ≤1GHz	VHT20	5580	MCS 0	---
RF Output Power	HT20	5180 / 5200 / 5240 / 5260 / 5300 5320 / 5500 / 5580 / 5700 / 5720	MCS 0	---
	HT40	5190 / 5230 / 5270 / 5310 / 5510 5550 / 5670 / 5710	MCS 0	---
	VHT20	5180 / 5200 / 5240 / 5260 / 5300 5320 / 5500 / 5580 / 5700 / 5720	MCS 0	---
	VHT40	5190 / 5230 / 5270 / 5310 / 5510 5590 / 5670 / 5710	MCS 0	---
	VHT80	5210 / 5290 / 5530 / 5610 / 5690	MCS 0	---
Radiated Emissions >1GHz Emission Bandwidth Peak Power Spectral Density	VHT20	5180 / 5200 / 5240 / 5260 / 5300 5320 / 5500 / 5580 / 5700 / 5720	MCS 0	---
	VHT40	5190 / 5230 / 5270 / 5310 / 5510 5590 / 5670 / 5710	MCS 0	---
	VHT80	5210 / 5290 / 5530 / 5610 / 5690	MCS 0	---

NOTE:

- The device supports non-beamforming and beamforming function in 802.11n/ac. After pre-testing, **beamforming mode** has the worst emission value, therefore the following test results came out from this.
- The EUT was pretested with 3 orientations placed on the table for the radiated emission measurement – X, Y, and Z-plane. The **Y-plane** results were found as the worst case and were shown in this report.

Frequency band 5725-5850 MHz				
Test item	Modulation Mode	Test Frequency (MHz)	Data Rate (Mbps) / MCS	Test Configuration
Conducted Emissions	VHT20	5785	MCS 0	---
Radiated Emissions ≤1GHz	VHT20	5785	MCS 0	---
RF Output Power	HT20	5745 / 5785 / 5825	MCS 0	---
	HT40	5755 / 5795	MCS 0	
	VHT20	5745 / 5785 / 5825	MCS 0	
	VHT40	5755 / 5795	MCS 0	
	VHT80	5775	MCS 0	
Radiated Emissions >1GHz Emission Bandwidth 6dB bandwidth Peak Power Spectral Density	VHT20	5745 / 5785 / 5825	MCS 0	---
	VHT40	5755 / 5795	MCS 0	
	VHT80	5775	MCS 0	

NOTE:

- The device supports non-beamforming and beamforming function in 802.11n/ac. After pre-testing, **beamforming mode** has the worst emission value, therefore the following test results came out from this.
- The EUT was pretested with 3 orientations placed on the table for the radiated emission measurement – X, Y, and Z-plane. The **Y-plane** results were found as the worst case and were shown in this report.

3 Transmitter Test Results

3.1 Conducted Emissions

3.1.1 Limit of Conducted Emissions

Conducted Emissions Limit		
Frequency Emission (MHz)	Quasi-Peak	Average
0.15-0.5	66 - 56 *	56 - 46 *
0.5-5	56	46
5-30	60	50

Note 1: * Decreases with the logarithm of the frequency.

3.1.2 Test Procedures

1. The device is placed on a test table, raised 80 cm above the reference ground plane. The vertical conducting plane is located 40 cm to the rear of the device.
2. The device is connected to line impedance stabilization network (LISN) and other accessories are connected to other LISN. Measured levels of AC power line conducted emission are across the 50 Ω LISN port.
3. AC conducted emission measurements is made over frequency range from 150 kHz to 30 MHz.
4. This measurement was performed with AC 120V/60Hz

3.1.3 Test Setup

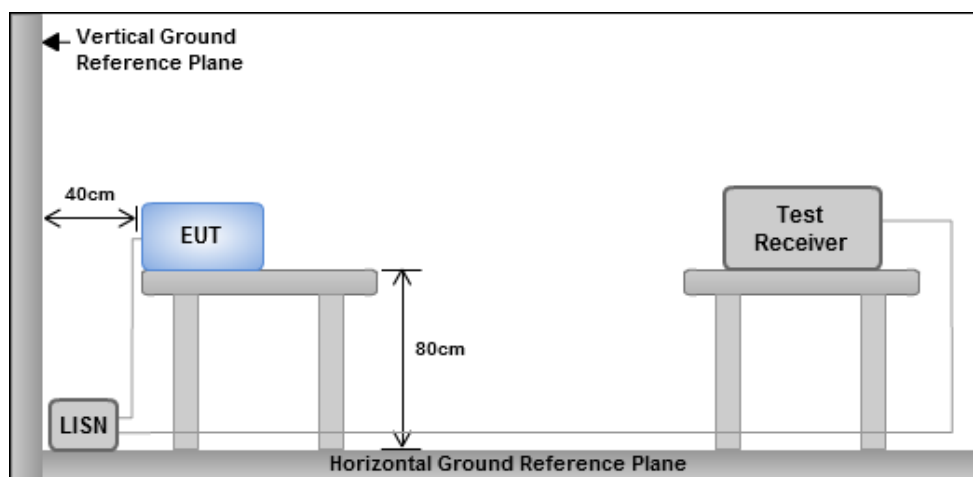

Note: 1. Support units were connected to second LISN.

2. Both of LISNs (AMN) are 80 cm from EUT and at least 80 cm from other units and other metal planes

3.1.4 Test Result of Conducted Emissions

Non-beamforming mode

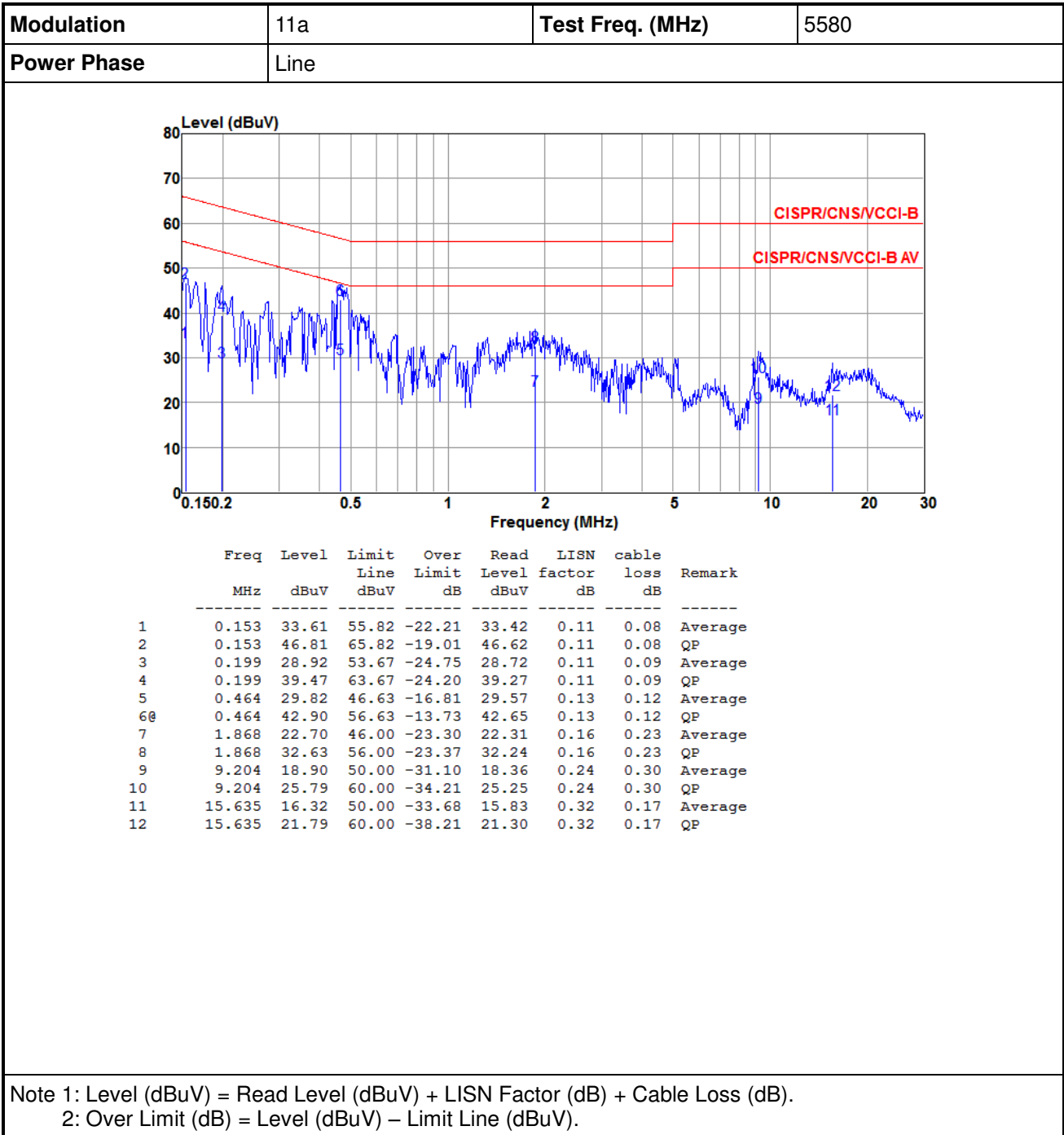

Modulation	11a	Test Freq. (MHz)	5580
Power Phase	Neutral		

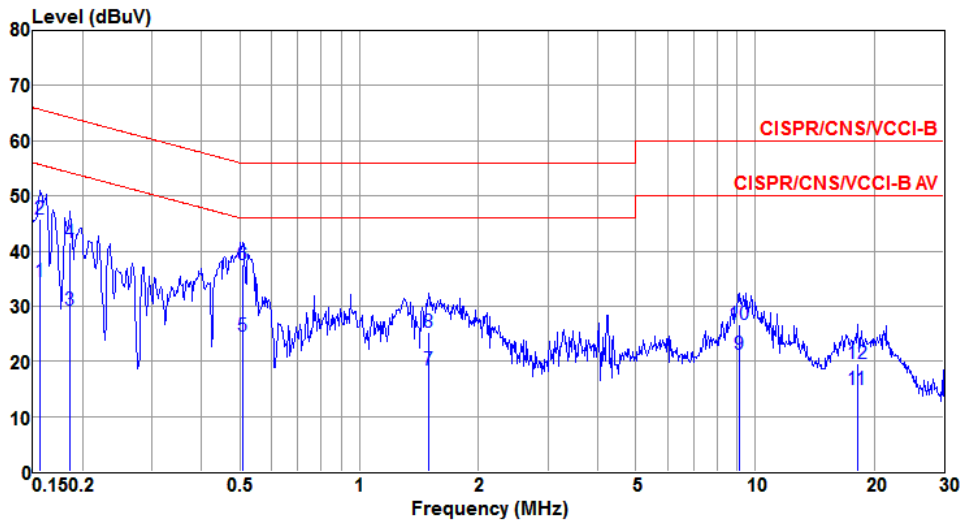

	Freq MHz	Level dBuV	Limit Line dBuV	Over Limit dB	Read Level dBuV	LISN factor dB	cable loss dB	Remark
1	0.156	34.58	55.65	-21.07	34.37	0.13	0.08	Average
2	0.156	45.75	65.65	-19.90	45.54	0.13	0.08	QP
3	0.186	29.30	54.20	-24.90	29.10	0.11	0.09	Average
4	0.186	41.65	64.20	-22.55	41.45	0.11	0.09	QP
5	0.507	24.63	46.00	-21.37	24.37	0.14	0.12	Average
6@	0.507	37.55	56.00	-18.45	37.29	0.14	0.12	QP
7	1.495	18.30	46.00	-27.70	17.94	0.15	0.21	Average
8	1.495	25.32	56.00	-30.68	24.96	0.15	0.21	QP
9	9.156	21.23	50.00	-28.77	20.67	0.26	0.30	Average
10	9.156	26.68	60.00	-33.32	26.12	0.26	0.30	QP
11	18.135	14.80	50.00	-35.20	14.34	0.38	0.08	Average
12	18.135	19.66	60.00	-40.34	19.20	0.38	0.08	QP

Note 1: Level (dBuV) = Read Level (dBuV) + LISN Factor (dB) + Cable Loss (dB).
 Note 2: Over Limit (dB) = Level (dBuV) – Limit Line (dBuV).

Modulation	11a	Test Freq. (MHz)	5785
Power Phase	Line		

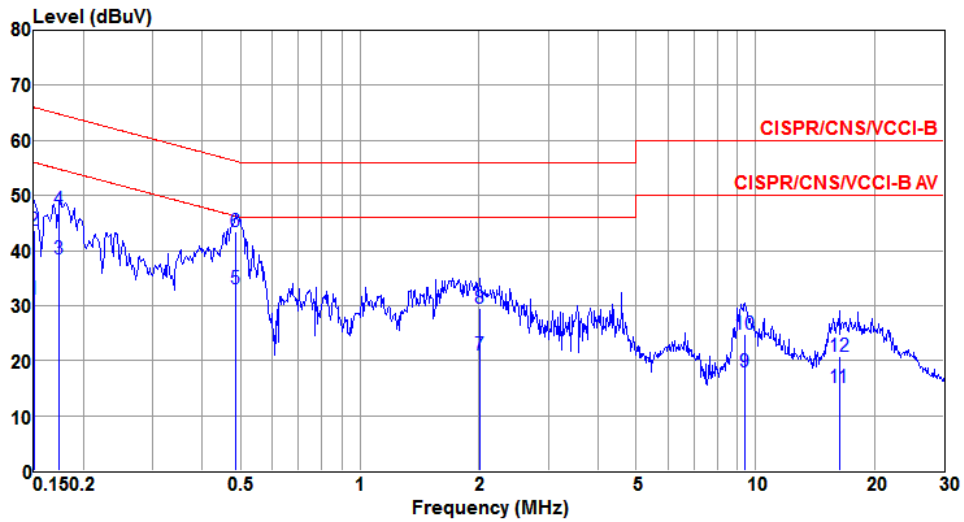

	Freq MHz	Level dBuV	Limit Line dBuV	Over Limit dB	Read Level dBuV	LISN factor dB	cable loss dB	Remark
1	0.150	31.18	56.00	-24.82	30.99	0.11	0.08	Average
2	0.150	43.75	66.00	-22.25	43.56	0.11	0.08	QP
3	0.174	38.48	54.77	-16.29	38.28	0.11	0.09	Average
4	0.174	47.34	64.77	-17.43	47.14	0.11	0.09	QP
5	0.484	33.15	46.27	-13.12	32.90	0.13	0.12	Average
6@	0.484	43.43	56.27	-12.84	43.18	0.13	0.12	QP
7	2.012	21.04	46.00	-24.96	20.64	0.16	0.24	Average
8	2.012	29.43	56.00	-26.57	29.03	0.16	0.24	QP
9	9.401	18.00	50.00	-32.00	17.46	0.24	0.30	Average
10	9.401	24.72	60.00	-35.28	24.18	0.24	0.30	QP
11	16.312	15.04	50.00	-34.96	14.56	0.33	0.15	Average
12	16.312	20.81	60.00	-39.19	20.33	0.33	0.15	QP

Note 1: Level (dBuV) = Read Level (dBuV) + LISN Factor (dB) + Cable Loss (dB).
 2: Over Limit (dB) = Level (dBuV) – Limit Line (dBuV).

Modulation	11a	Test Freq. (MHz)	5785
Power Phase	Neutral		

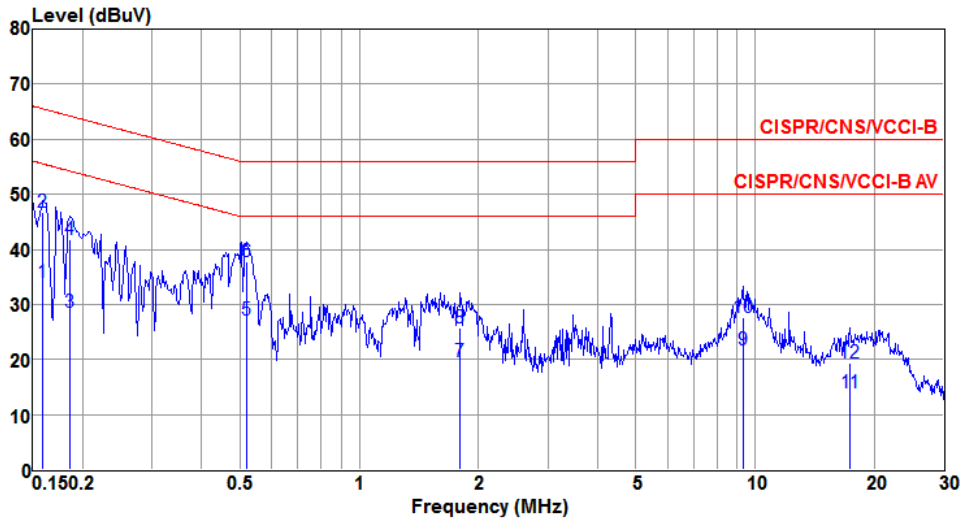

	Freq	Level	Limit	Over	Read	LISN	cable	Remark
	MHz	dBuV	Line	Limit	Level	factor	loss	
			dBuV	dB	dBuV	dB	dB	
1	0.159	33.89	55.52	-21.63	33.69	0.12	0.08	Average
2	0.159	46.81	65.52	-18.71	46.61	0.12	0.08	QP
3	0.186	28.53	54.20	-25.67	28.33	0.11	0.09	Average
4	0.186	41.79	64.20	-22.41	41.59	0.11	0.09	QP
5	0.518	27.16	46.00	-18.84	26.90	0.14	0.12	Average
6@	0.518	37.81	56.00	-18.19	37.55	0.14	0.12	QP
7	1.800	19.62	46.00	-26.38	19.23	0.16	0.23	Average
8	1.800	25.74	56.00	-30.26	25.35	0.16	0.23	QP
9	9.302	21.73	50.00	-28.27	21.17	0.26	0.30	Average
10	9.302	27.55	60.00	-32.45	26.99	0.26	0.30	QP
11	17.383	13.86	50.00	-36.14	13.38	0.37	0.11	Average
12	17.383	19.44	60.00	-40.56	18.96	0.37	0.11	QP

Note 1: Level (dBuV) = Read Level (dBuV) + LISN Factor (dB) + Cable Loss (dB).
 2: Over Limit (dB) = Level (dBuV) – Limit Line (dBuV).

Beamforming mode

Modulation	VHT20	Test Freq. (MHz)	5580
Power Phase	Line		

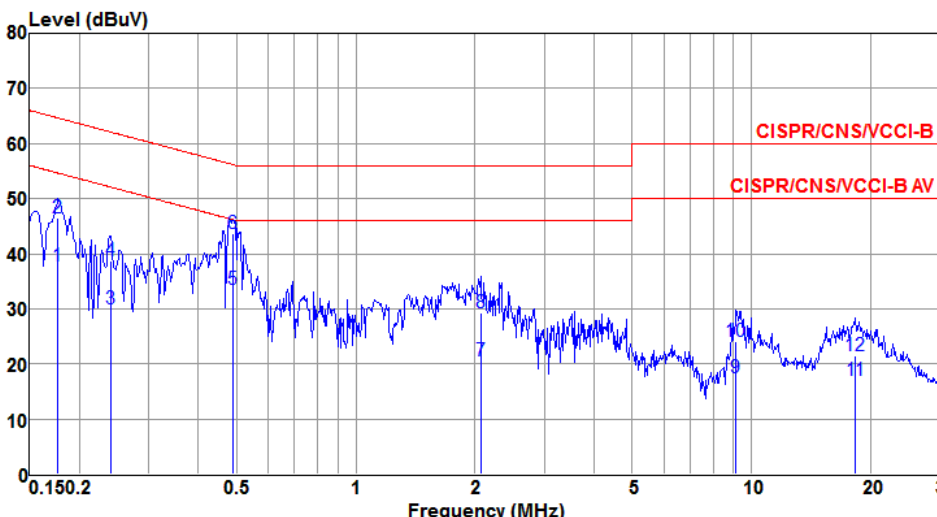

The graph displays the measured level in dBUV against frequency in MHz. Two red limit lines are shown: CISPR/CNS/VCCI-B (upper) and CISPR/CNS/VCCI-B AV (lower). The blue trace represents the measured signal, with several peaks marked by vertical lines and numbered 1 through 12. The x-axis is logarithmic, ranging from 0.150.2 to 30 MHz. The y-axis ranges from 0 to 80 dBUV.

	Freq MHz	Level dBUV	Limit Line dBUV	Over Limit dB	Read Level dBUV	LISN factor dB	cable loss dB	Remark
1	0.177	37.72	54.64	-16.92	37.52	0.11	0.09	Average
2	0.177	46.42	64.64	-18.22	46.22	0.11	0.09	QP
3	0.240	29.87	52.08	-22.21	29.65	0.12	0.10	Average
4	0.240	38.67	62.08	-23.41	38.45	0.12	0.10	QP
5	0.489	33.47	46.19	-12.72	33.22	0.13	0.12	Average
6@	0.489	43.62	56.19	-12.57	43.37	0.13	0.12	QP
7	2.066	20.50	46.00	-25.50	20.10	0.16	0.24	Average
8	2.066	29.24	56.00	-26.76	28.84	0.16	0.24	QP
9	9.156	17.40	50.00	-32.60	16.86	0.24	0.30	Average
10	9.156	24.12	60.00	-35.88	23.58	0.24	0.30	QP
11	18.328	17.07	50.00	-32.93	16.64	0.35	0.08	Average
12	18.328	21.40	60.00	-38.60	20.97	0.35	0.08	QP

Note 1: Level (dBUV) = Read Level (dBUV) + LISN Factor (dB) + Cable Loss (dB).
 Note 2: Over Limit (dB) = Level (dBUV) – Limit Line (dBUV).

Modulation	VHT20	Test Freq. (MHz)	5580
Power Phase	Neutral		

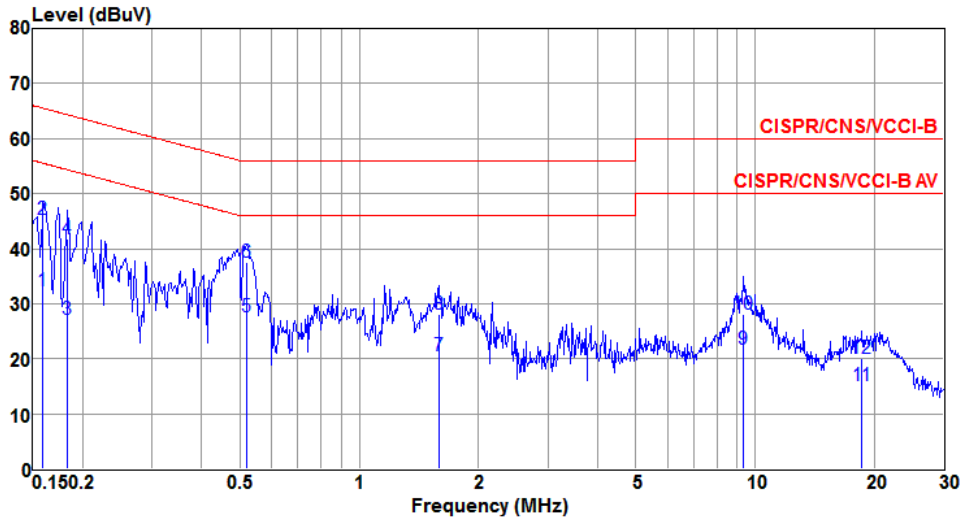

	Freq	Level	Limit	Over	Read	LISN	cable	
	MHz	dBuV	Line	Limit	Level	factor	loss	Remark
			dBuV	dB	dBuV	dB	dB	
1	0.159	32.40	55.52	-23.12	32.20	0.12	0.08	Average
2	0.159	45.25	65.52	-20.27	45.05	0.12	0.08	QP
3	0.183	27.18	54.33	-27.15	26.98	0.11	0.09	Average
4	0.183	41.78	64.33	-22.55	41.58	0.11	0.09	QP
5	0.518	27.53	46.00	-18.47	27.27	0.14	0.12	Average
6	0.518	37.63	56.00	-18.37	37.37	0.14	0.12	QP
7	1.585	20.56	46.00	-25.44	20.19	0.16	0.21	Average
8	1.585	28.20	56.00	-27.80	27.83	0.16	0.21	QP
9	9.302	21.67	50.00	-28.33	21.11	0.26	0.30	Average
10	9.302	28.07	60.00	-31.93	27.51	0.26	0.30	QP
11	18.622	15.05	50.00	-34.95	14.59	0.39	0.07	Average
12	18.622	19.99	60.00	-40.01	19.53	0.39	0.07	QP

Note 1: Level (dBuV) = Read Level (dBuV) + LISN Factor (dB) + Cable Loss (dB).
 Note 2: Over Limit (dB) = Level (dBuV) – Limit Line (dBuV).

Modulation	VHT20	Test Freq. (MHz)	5785
Power Phase	Line		

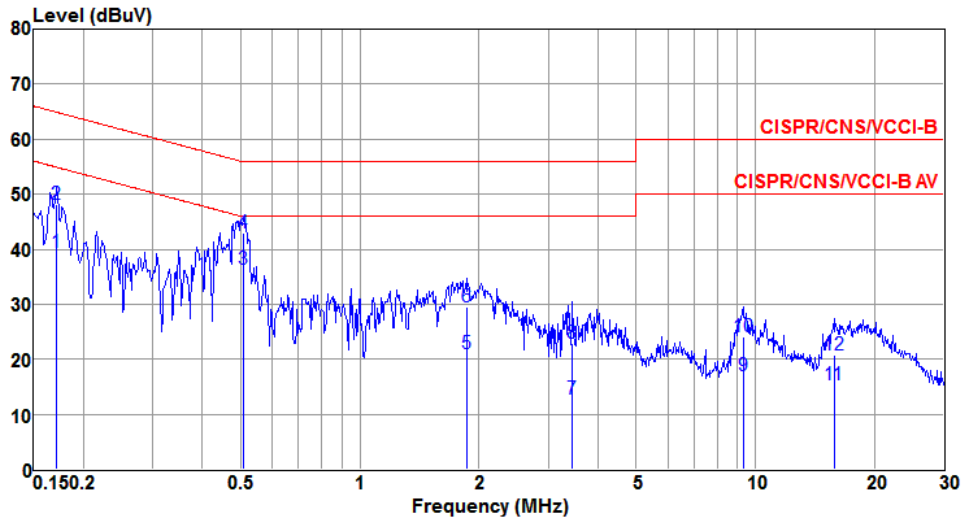

	Freq MHz	Level dBuV	Limit Line dBuV	Over Limit dB	Read Level dBuV	LISN factor dB	cable loss dB	Remark
1	0.171	39.51	54.90	-15.39	39.32	0.11	0.08	Average
2	0.171	48.14	64.90	-16.76	47.95	0.11	0.08	QP
3	0.507	36.25	46.00	-9.75	36.00	0.13	0.12	Average
4	0.507	42.86	56.00	-13.14	42.61	0.13	0.12	QP
5	1.858	20.97	46.00	-25.03	20.58	0.16	0.23	Average
6	1.858	29.51	56.00	-26.49	29.12	0.16	0.23	QP
7	3.454	12.78	46.00	-33.22	12.30	0.18	0.30	Average
8	3.454	22.88	56.00	-33.12	22.40	0.18	0.30	QP
9	9.302	17.02	50.00	-32.98	16.48	0.24	0.30	Average
10	9.302	23.98	60.00	-36.02	23.44	0.24	0.30	QP
11	15.801	15.29	50.00	-34.71	14.79	0.33	0.17	Average
12	15.801	20.83	60.00	-39.17	20.33	0.33	0.17	QP

Note 1: Level (dBuV) = Read Level (dBuV) + LISN Factor (dB) + Cable Loss (dB).
 2: Over Limit (dB) = Level (dBuV) – Limit Line (dBuV).

Modulation	VHT20	Test Freq. (MHz)	5785
Power Phase	Neutral		

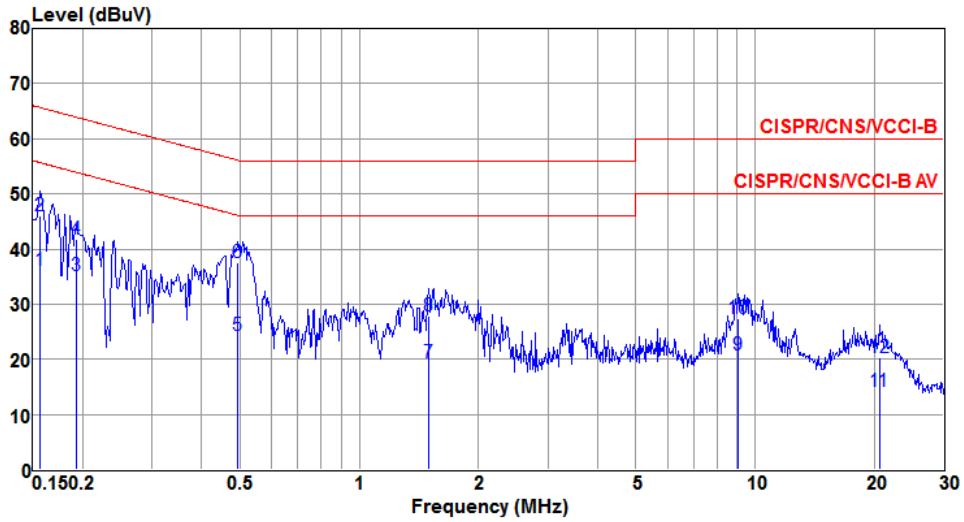

	Freq MHz	Level dBuV	Limit Line dBuV	Over Limit dB	Read Level dBuV	LISN factor dB	cable loss dB	Remark
1	0.156	36.21	55.65	-19.44	36.00	0.13	0.08	Average
2	0.156	46.14	65.65	-19.51	45.93	0.13	0.08	QP
3	0.192	35.06	53.93	-18.87	34.87	0.10	0.09	Average
4	0.192	41.70	63.93	-22.23	41.51	0.10	0.09	QP
5	0.494	24.23	46.10	-21.87	23.97	0.14	0.12	Average
6@	0.494	37.47	56.10	-18.63	37.21	0.14	0.12	QP
7	1.495	19.40	46.00	-26.60	19.04	0.15	0.21	Average
8	1.495	27.88	56.00	-28.12	27.52	0.15	0.21	QP
9	9.059	20.75	50.00	-29.25	20.19	0.26	0.30	Average
10	9.059	27.45	60.00	-32.55	26.89	0.26	0.30	QP
11	20.594	14.21	50.00	-35.79	13.77	0.41	0.03	Average
12	20.594	20.25	60.00	-39.75	19.81	0.41	0.03	QP

Note 1: Level (dBuV) = Read Level (dBuV) + LISN Factor (dB) + Cable Loss (dB).
 Note 2: Over Limit (dB) = Level (dBuV) – Limit Line (dBuV).

3.2 Emission Bandwidth

3.2.1 Limit of Emission Bandwidth

Within the 5.725-5.85 GHz band, the minimum 6 dB bandwidth of U-NII devices shall be at least 500 kHz.

3.2.2 Test Procedures

26dB Bandwidth

1. Set RBW = approximately 1% of the emission bandwidth.
2. Set the VBW > RBW, Detector = Peak.
3. Trace mode = max hold.
4. Measure the maximum width of the emission that is 26 dB down from the peak of the emission.

Occupied Bandwidth

1. Set RBW = 1 % to 5 % of the OBW
2. Set VBW \geq 3 RBW
3. Sample detection and single sweep mode shall be used
4. Use the 99 % power bandwidth function of the instrument

6dB Bandwidth

1. Set RBW = 100kHz, VBW = 300kHz
2. Detector = Peak, Trace mode = max hold.
3. Allow the trace to stabilize.
4. Measure the maximum width of the emission that is constrained by the frequencies associated with the two outermost amplitude points (upper and lower frequencies) that are attenuated by 6 dB relative to the maximum level measured in the fundamental emission

3.2.3 Test Setup

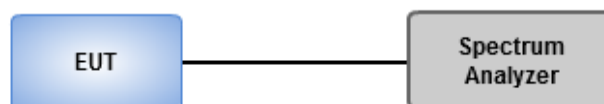

3.2.4 Test Result of Emission Bandwidth

Non-beamforming mode

For Frequency band 5150~5250 MHz										
Emission Bandwidth										
Mode	N _{TX}	Freq. (MHz)	26dB Bandwidth (MHz)				99% Bandwidth (MHz)			
			Chain 0	Chain 1	Chain 2	Chain 3	Chain 0	Chain 1	Chain 2	Chain 3
11a	2	5180	21.91	21.74	---	---	17.07	16.99	---	---
11a	2	5200	21.86	21.80	---	---	17.10	17.01	---	---
11a	2	5240	21.86	21.74	---	---	17.16	17.02	---	---

For Frequency band 5250~5350 / 5470~5725 MHz											
Mode	N _{TX}	Freq. (MHz)	26dB Bandwidth (MHz)				99% Bandwidth (MHz)				Power Limit (dBm)
			Chain 0	Chain 1	Chain 2	Chain 3	Chain 0	Chain 1	Chain 2	Chain 3	
11a	2	5260	21.80	21.74	---	---	17.10	17.03	---	---	24.00
11a	2	5300	21.80	21.86	---	---	17.25	17.12	---	---	24.00
11a	2	5320	21.91	21.91	---	---	17.08	16.98	---	---	24.00
11a	2	5500	21.91	21.74	---	---	17.11	17.07	---	---	24.00
11a	2	5580	23.62	35.36	---	---	19.51	19.00	---	---	24.00
11a	2	5700	21.86	21.80	---	---	17.11	17.19	---	---	24.00

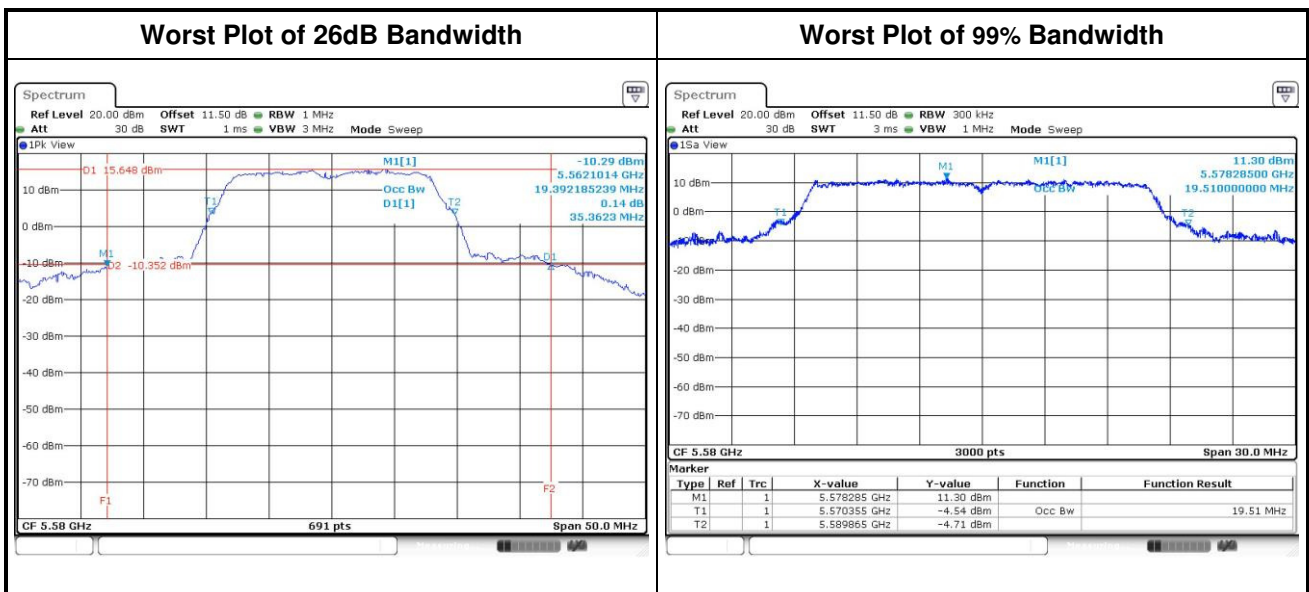

Channel that extends across the 5.725 GHz boundary

Frequency band			UNII Emission Bandwidth Result (Within 5470-5725MHz band)								
Mode	N _{TX}	Freq. (MHz)	26dB Bandwidth (MHz)				99% Bandwidth (MHz)				Power Limit (dBm)
			Chain 0	Chain 1	Chain 2	Chain 3	Chain 0	Chain 1	Chain 2	Chain 3	
11a	2	5720	25.19	24.33	---	---	14.00	13.90	---	---	24.00

Frequency band			UNII Emission Bandwidth Result (Extends across 5725MHz band)								
Mode	N _{TX}	Freq. (MHz)	26dB Bandwidth (MHz)				99% Bandwidth (MHz)				Power Limit (dBm)
			Chain 0	Chain 1	Chain 2	Chain 3	Chain 0	Chain 1	Chain 2	Chain 3	
11a	2	5720	14.20	14.22	---	---	3.82	3.86	---	---	30

Worst Plots

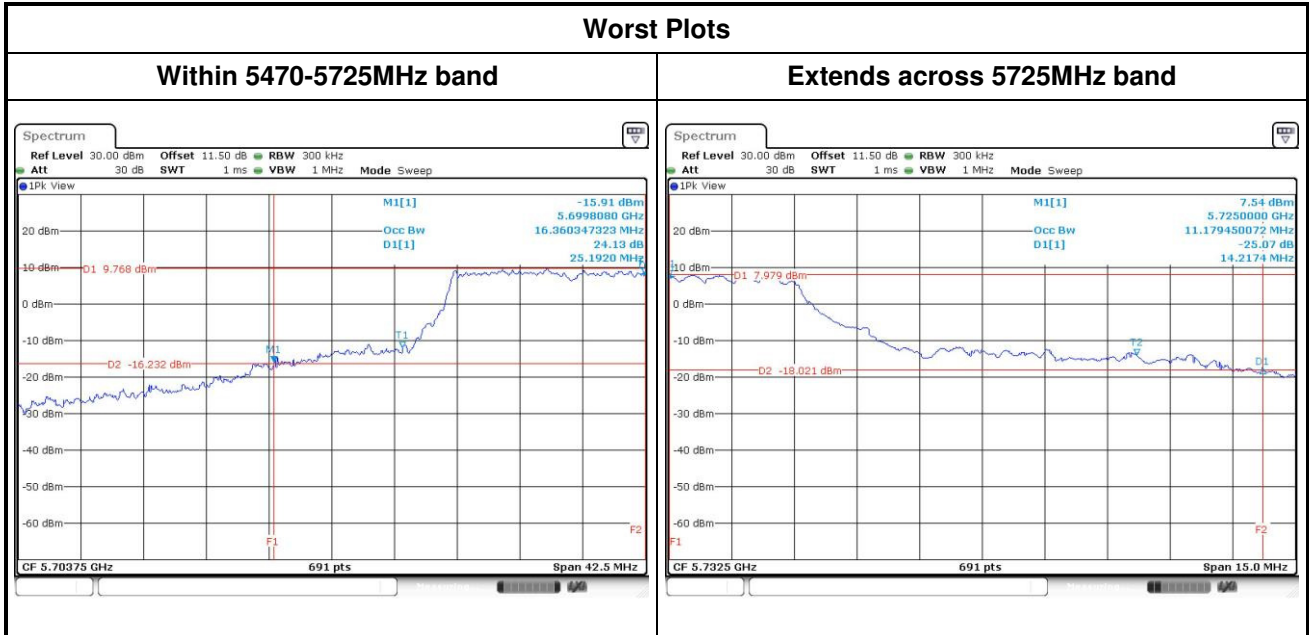

For Frequency band 5725-5850 MHz

Emission Bandwidth

Mode	N _{TX}	Freq. (MHz)	OBW Bandwidth (MHz)				6dB Bandwidth (MHz)				6dB BW Limit (MHz)
			Chain 0	Chain 1	Chain 2	Chain 3	Chain 0	Chain 1	Chain 2	Chain 3	
11a	2	5745	17.14	17.10	---	---	16.35	16.35	---	---	0.5
11a	2	5785	17.79	18.18	---	---	16.35	16.35	---	---	0.5
11a	2	5825	17.29	17.21	---	---	16.35	16.35	---	---	0.5

Worst Plot of 99% Bandwidth

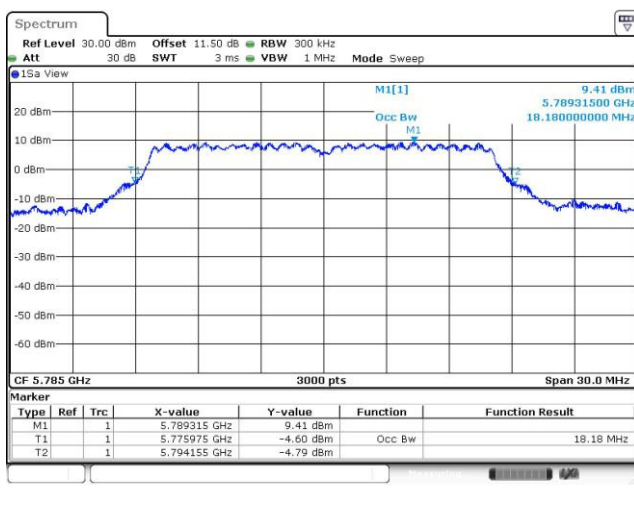

Worst Plot of 6dB Bandwidth

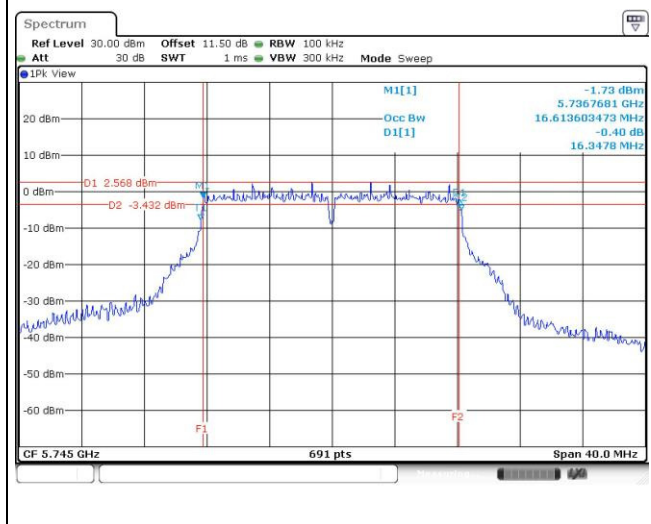

Beamforming mode

For Frequency band 5150~5250 MHz										
Emission Bandwidth										
Mode	N _{TX}	Freq. (MHz)	26dB Bandwidth (MHz)				99% Bandwidth (MHz)			
			Chain 0	Chain 1	Chain 2	Chain 3	Chain 0	Chain 1	Chain 2	Chain 3
VHT20	2	5180	22.14	21.97	---	---	18.14	18.01	---	---
VHT20	2	5200	22.03	21.91	---	---	18.15	18.01	---	---
VHT20	2	5240	22.09	21.97	---	---	18.16	18.01	---	---
VHT40	2	5190	41.16	41.16	---	---	36.62	36.62	---	---
VHT40	2	5230	41.28	40.81	---	---	36.70	36.66	---	---
VHT80	2	5210	82.32	81.86	---	---	76.12	76.20	---	---

For Frequency band 5250~5350 / 5470~5725 MHz											
Mode	N _{TX}	Freq. (MHz)	26dB Bandwidth (MHz)				99% Bandwidth (MHz)				Power Limit (dBm)
			Chain 0	Chain 1	Chain 2	Chain 3	Chain 0	Chain 1	Chain 2	Chain 3	
VHT20	2	5260	22.09	22.14	---	---	18.16	18.01	---	---	24.00
VHT20	2	5300	22.03	21.97	---	---	18.21	17.99	---	---	24.00
VHT20	2	5320	22.09	22.03	---	---	18.27	18.01	---	---	24.00
VHT40	2	5270	41.04	40.81	---	---	36.64	36.60	---	---	24.00
VHT40	2	5310	41.39	41.04	---	---	36.70	36.60	---	---	24.00
VHT80	2	5290	82.09	82.09	---	---	76.16	76.16	---	---	24.00
VHT20	2	5500	22.14	21.86	---	---	18.21	18.02	---	---	24.00
VHT20	2	5580	23.26	32.39	---	---	19.25	18.79	---	---	24.00
VHT20	2	5700	22.09	22.03	---	---	18.18	18.02	---	---	24.00
VHT40	2	5510	41.16	41.04	---	---	36.68	36.64	---	---	24.00
VHT40	2	5590	41.30	75.65	---	---	38.14	37.46	---	---	24.00
VHT40	2	5670	41.28	40.93	---	---	36.68	36.68	---	---	24.00
VHT80	2	5530	82.32	81.62	---	---	76.24	76.20	---	---	24.00
VHT80	2	5610	91.59	99.71	---	---	76.16	76.24	---	---	24.00

Worst Plot of 26dB Bandwidth

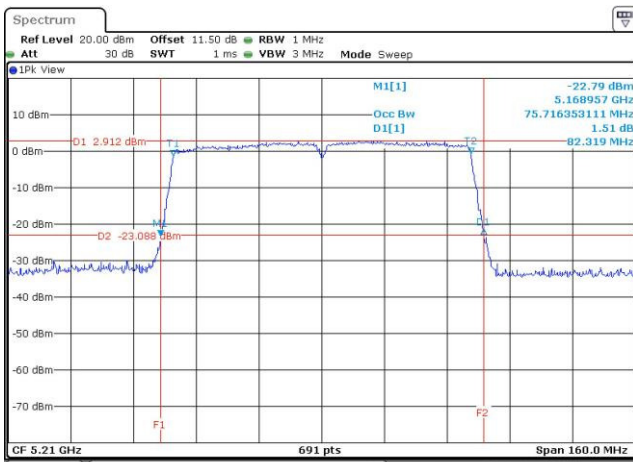

Worst Plot of 99% Bandwidth

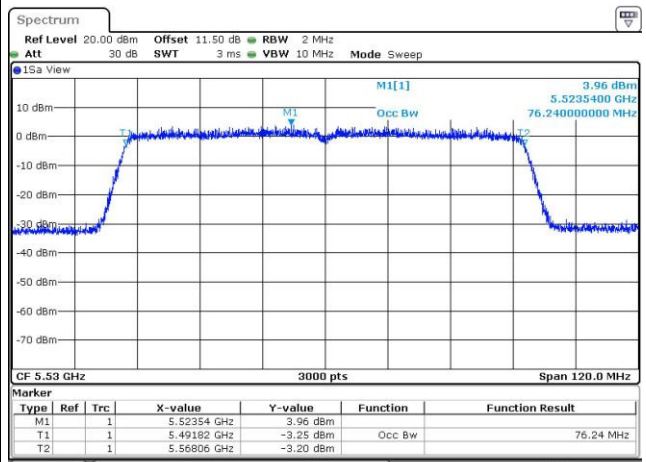

Channel that extends across the 5.725 GHz boundary

Frequency band			UNII Emission Bandwidth Result (Within 5470-5725MHz band)								
Mode	N _{TX}	Freq. (MHz)	26dB Bandwidth (MHz)				99% Bandwidth (MHz)				Power Limit (dBm)
			Chain 0	Chain 1	Chain 2	Chain 3	Chain 0	Chain 1	Chain 2	Chain 3	
VHT20	2	5720	27.35	26.73	---	---	14.22	14.16	---	---	24.00
VHT40	2	5710	65.74	66.55	---	---	33.61	33.57	---	---	24.00
VHT80	2	5690	139.79	128.70	---	---	73.66	73.58	---	---	24.00

Frequency band			UNII Emission Bandwidth Result (Extends across 5725MHz band)								
Mode	N _{TX}	Freq. (MHz)	26dB Bandwidth (MHz)				99% Bandwidth (MHz)				Power Limit (dBm)
			Chain 0	Chain 1	Chain 2	Chain 3	Chain 0	Chain 1	Chain 2	Chain 3	
VHT20	2	5720	13.61	14.57	---	---	4.07	4.01	---	---	30
VHT40	2	5710	33.86	34.09	---	---	3.37	3.39	---	---	30
VHT80	2	5690	58.96	57.91	---	---	3.18	3.10	---	---	30

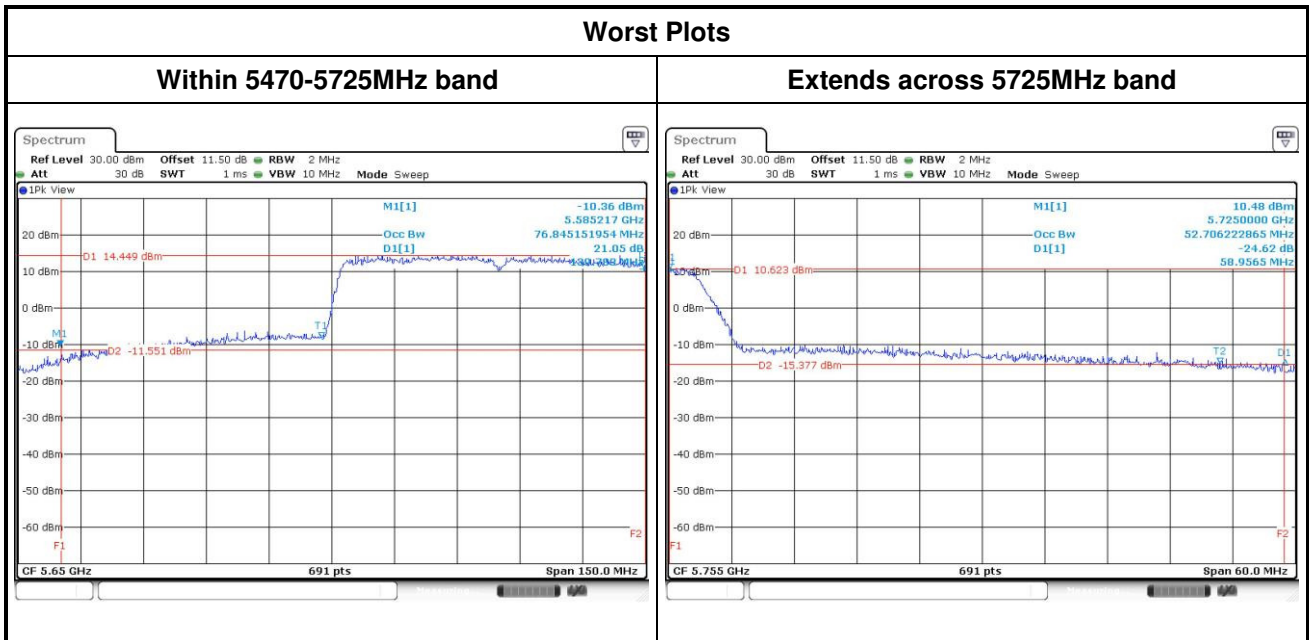

For Frequency band 5725-5850 MHz											
Emission Bandwidth											
Mode	N _{TX}	Freq. (MHz)	OBW Bandwidth (MHz)				6dB Bandwidth (MHz)				6dB BW Limit (MHz)
			Chain 0	Chain 1	Chain 2	Chain 3	Chain 0	Chain 1	Chain 2	Chain 3	
VHT20	2	5745	18.22	18.04	---	---	17.62	17.62	---	---	0.5
VHT20	2	5785	18.50	18.25	---	---	17.62	17.62	---	---	0.5
VHT20	2	5825	18.24	18.03	---	---	17.57	17.62	---	---	0.5
VHT40	2	5755	36.70	36.70	---	---	36.29	36.29	---	---	0.5
VHT40	2	5795	36.76	36.74	---	---	36.29	36.41	---	---	0.5
VHT80	2	5775	76.20	76.16	---	---	76.06	76.52	---	---	0.5

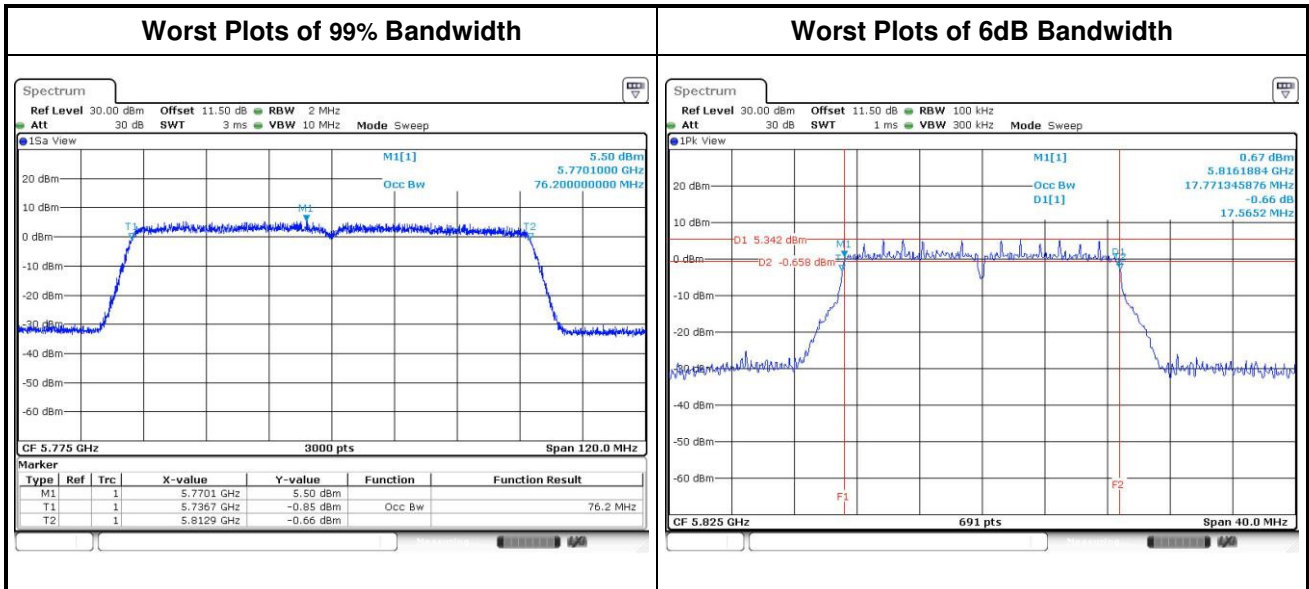

3.3 RF Output Power

3.3.1 Limit of RF Output Power

Frequency band 5150-5250 MHz	
Operating Mode	Limit
<input type="checkbox"/> Outdoor access point	Conducted Power: 1 W The maximum e.i.r.p. at any elevation angle above 30 degrees as measured from the horizon must not exceed 125 mW (21 dBm)
<input type="checkbox"/> Indoor access point	Conducted Power: 1 W
<input type="checkbox"/> Fixed point-to-point access points	Conducted Power: 1 W
<input checked="" type="checkbox"/> Mobile and portable client devices	Conducted Power: 250 mW

Frequency Band (MHz)	Limit
<input checked="" type="checkbox"/> 5250 ~ 5350	250mW or 11dBm+10 log B
<input checked="" type="checkbox"/> 5470 ~ 5725	250mW or 11dBm+10 log B
<input checked="" type="checkbox"/> 5725 ~ 5850	1 W

Note: "B" is the 26dB emission bandwidth in MHz.

3.3.2 Test Procedures

- Power meter (For channel that does not extends across the 5.725 GHz boundary)
 - Measurements is performed using a wideband gated RF power meter provided that the gate parameters are adjusted such that the power is measured only when the EUT is transmitting at its maximum power control level. Since the measurement is made only during the ON time of the transmitter, no duty cycle correction factor is required
- Spectrum analyzer (For channel that extends across the 5.725 GHz boundary)
 1. Set RBW=1MHz, VBW=3MHz , Sweep time= Auto, Detector = RMS
 2. Trace average at least 100 traces in power averaging mode
 3. Compute power by integrating the spectrum across the 26 dB EBW

3.3.3 Test Setup

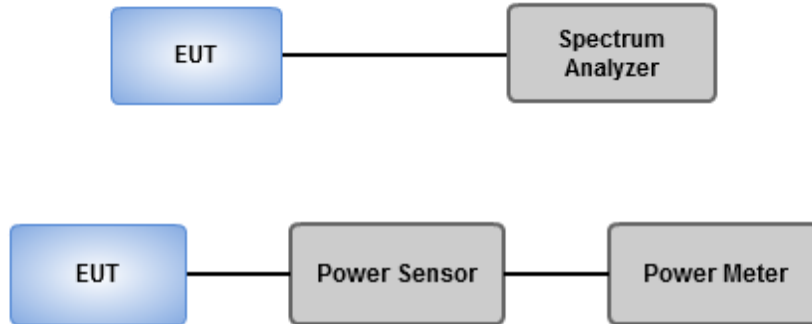

3.3.4 Test Result of Maximum Conducted Output Power

Non-beamforming mode

For Frequency band 5150~5250 MHz									
Mode	N _{TX}	Freq. (MHz)	Conducted Power (dBm)				Total Power (mW)	Total Power (dBm)	Limit (dBm)
			Chain 0	Chain 1	Chain 2	Chain 3			
11a	2	5180	14.16	15.22	---	---	59.327	17.73	24.00
11a	2	5200	13.57	14.65	---	---	51.925	17.15	24.00
11a	2	5240	13.05	13.66	---	---	43.411	16.38	24.00

For Frequency band 5250~5350 / 5470~5725 MHz									
Mode	N _{TX}	Freq. (MHz)	Conducted Power (dBm)				Total Power (mW)	Total Power (dBm)	Limit (dBm)
			Chain 0	Chain 1	Chain 2	Chain 3			
11a	2	5260	13.11	13.82	---	---	44.564	16.49	24.00
11a	2	5300	14.32	14.92	---	---	58.085	17.64	24.00
11a	2	5320	14.78	15.49	---	---	65.460	18.16	24.00
11a	2	5500	14.22	15.40	---	---	61.098	17.86	24.00
11a	2	5580	20.09	19	---	---	181.527	22.59	24.00
11a	2	5700	14.72	14.61	---	---	58.555	17.68	24.00

Channel that extends across the 5.725 GHz boundary

Maximum Conducted Output Power (Within 5470-5725MHz band)											
Mode	N _{TX}	Freq. (MHz)	Conducted Power without duty factor					Duty factor (dB)	Total Power (mW)	Total Power (dBm)	Limit (dBm)
			Chain 0	Chain 1	Chain 2	Chain 3	Total Power (dBm)				
11a	2	5720	18.6	17.67	---	---	21.17	0.00	130.923	21.17	24.00

Maximum Conducted Output Power (Extends across 5725MHz band)											
Mode	N _{TX}	Freq. (MHz)	Conducted Power without duty factor					Duty factor (dB)	Total Power (mW)	Total Power (dBm)	Limit (dBm)
			Chain 0	Chain 1	Chain 2	Chain 3	Total Power (dBm)				
11a	2	5720	10.45	10.31	---	---	13.39	0.00	21.832	13.39	30.00

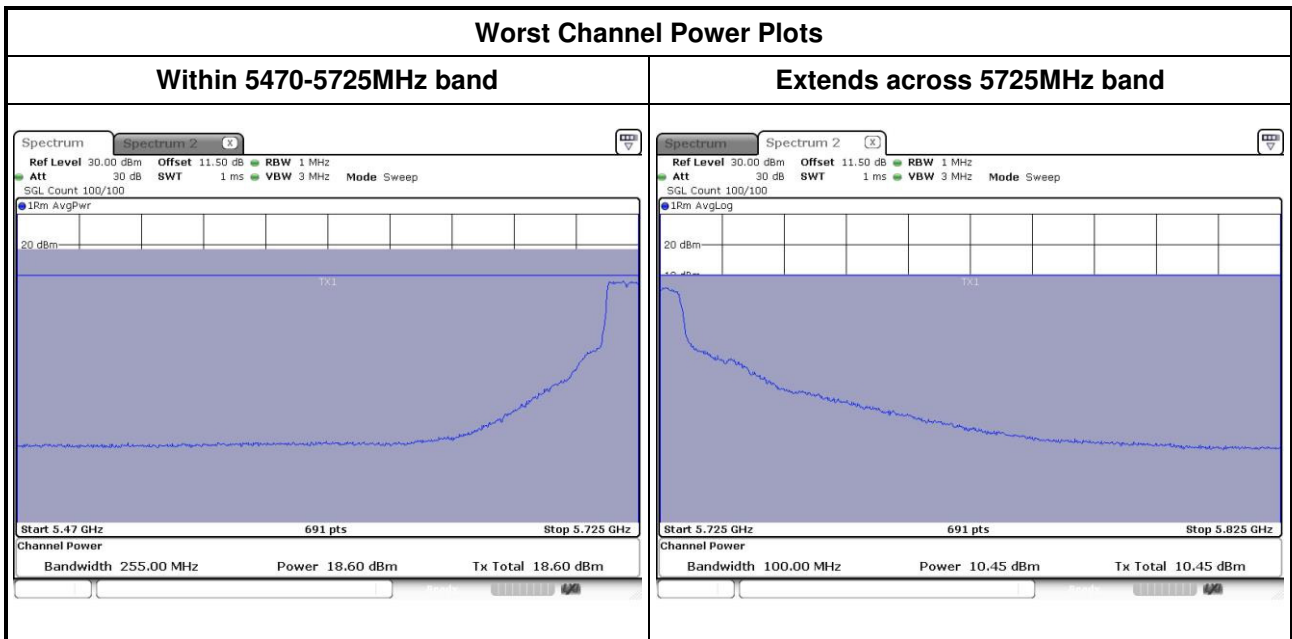

For Frequency band 5725-5850 MHz										
Mode	N _{TX}	Freq. (MHz)	Conducted Power (dBm)				Total Power (mW)	Total Power (dBm)	Limit (dBm)	
			Chain 0	Chain 1	Chain 2	Chain 3				
11a	2	5745	15.01	15.03	---	---	63.538	18.03	30.00	
11a	2	5785	18.55	18.29	---	---	139.067	21.43	30.00	
11a	2	5825	17.01	16.41	---	---	93.986	19.73	30.00	

Beamforming mode

For Frequency band 5150~5250 MHz									
Mode	N _{TX}	Freq. (MHz)	Conducted Power (dBm)				Total Power (mW)	Total Power (dBm)	Limit (dBm)
			Chain 0	Chain 1	Chain 2	Chain 3			
HT20	2	5180	13.29	14.32	---	---	48.370	16.85	23.79
HT20	2	5200	12.27	13.31	---	---	38.294	15.83	23.79
HT20	2	5240	12.21	13.32	---	---	38.112	15.81	23.79
HT40	2	5190	13.57	14.78	---	---	52.812	17.23	23.79
HT40	2	5230	14.39	15.28	---	---	61.208	17.87	23.79
VHT20	2	5180	13.35	14.37	---	---	48.980	16.90	23.79
VHT20	2	5200	12.32	13.35	---	---	38.688	15.88	23.79
VHT20	2	5240	12.25	13.37	---	---	38.515	15.86	23.79
VHT40	2	5190	13.62	14.82	---	---	53.353	17.27	23.79
VHT40	2	5230	14.43	15.32	---	---	61.774	17.91	23.79
VHT80	2	5210	12.25	12.96	---	---	36.558	15.63	23.79

Note:

- Directional gain = $10 * \log((10^{3.3/20} + 10^{3.1/20})^2 / 2) = 6.21 \text{ dBi} > 6 \text{ dBi}$.
Limit shall be reduced to $24 \text{ dBm} - (6.21 \text{ dBi} - 6 \text{ dBi}) = 23.79 \text{ dBm}$.

For Frequency band 5250~5350 MHz									
Mode	N _{TX}	Freq. (MHz)	Conducted Power (dBm)				Total Power (mW)	Total Power (dBm)	Limit (dBm)
			Chain 0	Chain 1	Chain 2	Chain 3			
HT20	2	5260	12.92	14.02	---	---	44.823	16.52	23.85
HT20	2	5300	12.98	13.91	---	---	44.465	16.48	23.85
HT20	2	5320	12.97	14.15	---	---	45.817	16.61	23.85
HT40	2	5270	14.68	15.49	---	---	64.776	18.11	23.85
HT40	2	5310	14.15	14.98	---	---	57.479	17.60	23.85
VHT20	2	5260	12.96	14.11	---	---	45.533	16.58	23.85
VHT20	2	5300	13.02	13.98	---	---	45.048	16.54	23.85
VHT20	2	5320	13.02	14.23	---	---	46.530	16.68	23.85
VHT40	2	5270	14.73	15.52	---	---	65.362	18.15	23.85
VHT40	2	5310	14.23	15.02	---	---	58.254	17.65	23.85
VHT80	2	5290	13.43	14.22	---	---	48.453	16.85	23.85

Note:

- Directional gain = $10 * \log((10^{3.17/20} + 10^{3.1/20})^2 / 2) = 6.15 \text{ dBi} > 6 \text{ dBi}$.
Limit shall be reduced to $24 \text{ dBm} - (6.15 \text{ dBi} - 6 \text{ dBi}) = 23.85 \text{ dBm}$.

For Frequency band 5470~5725 MHz									
Mode	N _{TX}	Freq. (MHz)	Conducted Power (dBm)				Total Power (mW)	Total Power (dBm)	Limit (dBm)
			Chain 0	Chain 1	Chain 2	Chain 3			
HT20	2	5500	14.68	15.75	---	---	66.960	18.26	23.96
HT20	2	5580	20.14	19.22	---	---	186.836	22.71	23.96
HT20	2	5700	15.05	15.46	---	---	67.145	18.27	23.96
HT40	2	5510	11.97	13.03	---	---	35.831	15.54	23.96
HT40	2	5590	19.61	18.62	---	---	164.189	22.15	23.96
HT40	2	5670	15.62	16.15	---	---	77.685	18.90	23.96
VHT20	2	5500	14.72	15.82	---	---	67.843	18.32	23.96
VHT20	2	5580	20.18	19.28	---	---	188.954	22.76	23.96
VHT20	2	5700	15.12	15.52	---	---	68.154	18.33	23.96
VHT40	2	5510	12.03	13.12	---	---	36.470	15.62	23.96
VHT40	2	5590	19.65	18.68	---	---	166.048	22.20	23.96
VHT40	2	5670	15.65	16.22	---	---	78.608	18.95	23.96
VHT80	2	5530	8.52	9.54	---	---	16.107	12.07	23.96
VHT80	2	5610	16.22	16.81	---	---	89.853	19.54	23.96

Note:

1. Directional gain = $10 * \log((10^{3.31/20} + 10^{2.73/20})^2 / 2) = 6.04 \text{ dBi} > 6 \text{ dBi}$.
Limit shall be reduced to $24 \text{ dBm} - (6.04 \text{ dBi} - 6 \text{ dBi}) = 23.96 \text{ dBm}$.

Channel that extends across the 5.725 GHz boundary

Maximum Conducted Output Power (Within 5470-5725MHz band)											
Mode	N _{TX}	Freq. (MHz)	Conducted Power without duty factor					Duty factor (dB)	Total Power (mW)	Total Power (dBm)	Limit (dBm)
			Chain 0	Chain 1	Chain 2	Chain 3	Total Power (dBm)				
HT20	2	5720	18.35	16.91	---	---	20.70	0.00	117.482	20.70	23.96
HT40	2	5710	19.01	17.8	---	---	21.46	0.00	139.872	21.46	23.96
VHT20	2	5720	18.59	17.49	---	---	21.09	0.00	128.382	21.09	23.96
VHT40	2	5710	19.21	18.34	---	---	21.81	0.00	151.602	21.81	23.96
VHT80	2	5690	19.15	19.03	---	---	22.10	0.18	169.072	22.28	23.96

Note: Directional gain = $10 * \log((10^{3.31/20} + 10^{2.73/20})^2/2) = 6.04$ dBi > 6 dBi, conducted power limit is reduced 0.04dB

Maximum Conducted Output Power (Extends across 5725MHz band)											
Mode	N _{TX}	Freq. (MHz)	Conducted Power without duty factor					Duty factor (dB)	Total Power (mW)	Total Power (dBm)	Limit (dBm)
			Chain 0	Chain 1	Chain 2	Chain 3	Total Power (dBm)				
HT20	2	5720	12.68	11.08	---	---	14.96	0.00	31.359	14.96	29.99
HT40	2	5710	8.46	7.04	---	---	10.82	0.00	12.073	10.82	29.99
VHT20	2	5720	12.97	11.79	---	---	15.43	0.00	34.916	15.43	29.99
VHT40	2	5710	8.74	7.97	---	---	11.38	0.00	13.748	11.38	29.99
VHT80	2	5690	4.43	4.78	---	---	7.62	0.18	6.024	7.80	29.99

Note: Directional gain = $10 * \log((10^{3.33/20} + 10^{2.65/20})^2/2) = 6.01$ dBi > 6 dBi, conducted power limit is reduced 0.01dB

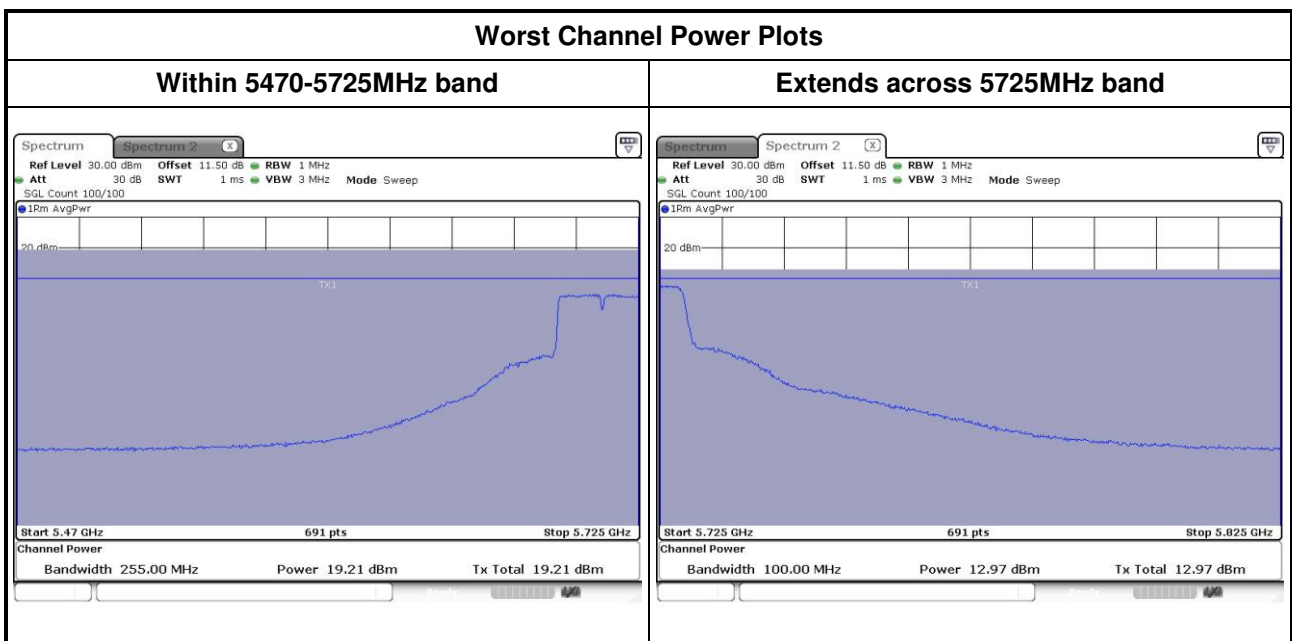

For Frequency band 5725-5850 MHz									
Mode	N _{TX}	Freq. (MHz)	Conducted Power (dBm)				Total Power (mW)	Total Power (dBm)	Limit (dBm)
			Chain 0	Chain 1	Chain 2	Chain 3			
HT20	2	5745	14.72	14.62	---	---	58.622	17.68	29.99
HT20	2	5785	17.82	17.35	---	---	114.859	20.60	29.99
HT20	2	5825	16.14	16.16	---	---	82.420	19.16	29.99
HT40	2	5755	12.48	12.38	---	---	34.999	15.44	29.99
HT40	2	5795	16.23	16.47	---	---	86.337	19.36	29.99
VHT20	2	5745	14.79	14.68	---	---	59.507	17.75	29.99
VHT20	2	5785	17.89	17.41	---	---	116.598	20.67	29.99
VHT20	2	5825	16.18	16.23	---	---	83.471	19.22	29.99
VHT40	2	5755	12.52	12.43	---	---	35.363	15.49	29.99
VHT40	2	5795	16.29	16.53	---	---	87.538	19.42	29.99
VHT80	2	5775	9.84	9.85	---	---	19.299	12.86	29.99

Note:

- Directional gain = $10 * \log((10^{3.33/20} + 10^{2.65/20})^2 / 2) = 6.01 \text{ dBi} > 6 \text{ dBi}$.
Limit shall be reduced to $30 \text{ dBm} - (6.01 \text{ dBi} - 6 \text{ dBi}) = 29.99 \text{ dBm}$.

3.4 Peak Power Spectral Density

3.4.1 Limit of Peak Power Spectral Density

Frequency band 5150-5250 MHz		
Operating Mode		Limit
<input type="checkbox"/>	Outdoor access point	17 dBm / MHz
<input type="checkbox"/>	Indoor access point	17 dBm / MHz
<input type="checkbox"/>	Fixed point-to-point access points	17 dBm / MHz
<input checked="" type="checkbox"/>	Mobile and portable client devices	11 dBm / MHz

Frequency Band (MHz)		Limit
<input checked="" type="checkbox"/>	5250 ~ 5350	11 dBm / MHz
<input checked="" type="checkbox"/>	5470 ~ 5725	11 dBm / MHz
<input checked="" type="checkbox"/>	5725 ~ 5850	30 dBm /500 kHz

3.4.2 Test Procedures

For 5150~5250 MHz, 5250~5350 MHz, 5470~5725 MHz

- Method SA-1 (802.11a / 11ac VHT20/ VHT40)
 1. Set RBW = 1 MHz, VBW = 3 MHz, Sweep time = auto, Detector = RMS.
 2. Trace average 100 traces.
 3. Use the peak marker function to determine the maximum amplitude level.
- Method SA-2 Alternative (11ac VHT80)
 1. Set RBW = 1 MHz, VBW = 3 MHz, Detector = RMS.
 2. Set sweep time $\geq 10 * (\text{number of points in sweep}) * (\text{total on/off period of the transmitted signal})$.
 3. Perform a single sweep.
 4. Use the peak marker function to determine the maximum amplitude level.
 5. Add $10 \log(1/x)$, where x is the duty cycle.

For 5725~5850 MHz

- Method SA-1 (802.11a / 11ac VHT20/ VHT40)
 1. Set RBW = 500 kHz, VBW = 2 MHz, Sweep time = auto, Detector = RMS.
 2. Trace average 100 traces.
 3. Use the peak marker function to determine the maximum amplitude level.
- Method SA-2 Alternative(11ac VHT80)
 1. Set RBW = 500 kHz, VBW = 2 MHz, Detector = RMS.
 2. Set sweep time $\geq 10 * (\text{number of points in sweep}) * (\text{total on/off period of the transmitted signal})$.
 3. Perform a single sweep.
 4. Use the peak marker function to determine the maximum amplitude level.
 5. Add $10 \log(1/x)$, where x is the duty cycle.

3.4.3 Test Setup

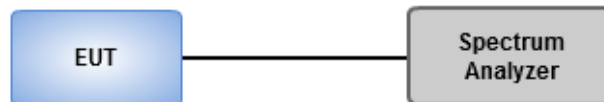

3.4.4 Test Result of Peak Power Spectral Density

Non-beamforming mode

Frequency band			5150~5250 MHz / 5250~5350 MHz / 5470~5725 MHz			
Condition			Peak Power Spectral Density (dBm/MHz)			
Mode	N _{TX}	Freq. (MHz)	PPSD w/o D.F (dBm/MHz)	Duty Factor (dB)	PPSD with D.F (dBm/MHz)	PPSD Limit (dBm/MHz)
11a	2	5180	5.00	0.00	5.00	10.79
11a	2	5200	3.57	0.00	3.57	10.79
11a	2	5240	2.48	0.00	2.48	10.79
11a	2	5260	3.70	0.00	3.70	10.85
11a	2	5300	4.82	0.00	4.82	10.85
11a	2	5320	4.67	0.00	4.67	10.85
11a	2	5500	4.78	0.00	4.78	10.96
11a	2	5580	10.38	0.00	10.38	10.96
11a	2	5700	4.68	0.00	4.68	10.96
11a	2	5720	7.15	0.00	7.15	10.96

Note:

1. D.F is duty factor.
2. Test result is bin-by-bin summing measured value of each TX port.
3. For 5150~5250MHz, Directional gain = $10 * \log((10^{3.3/20} + 10^{3.1/20})^2/2) = 6.21 \text{ dBi} > 6 \text{ dBi}$.
Limit shall be reduced to 11 dBm – (6.21 dBi – 6 dBi) = 10.79 dBm.
4. For 5250~5350MHz, Directional gain = $10 * \log((10^{3.17/20} + 10^{3.1/20})^2/2) = 6.15 \text{ dBi} > 6 \text{ dBi}$.
Limit shall be reduced to 11 dBm – (6.15 dBi – 6 dBi) = 10.85 dBm.
5. For 5470~5725MHz, Directional gain = $10 * \log((10^{3.31/20} + 10^{2.73/20})^2/2) = 6.04 \text{ dBi} > 6 \text{ dBi}$.
Limit shall be reduced to 11 dBm – (6.04 dBi – 6 dBi) = 10.96 dBm.

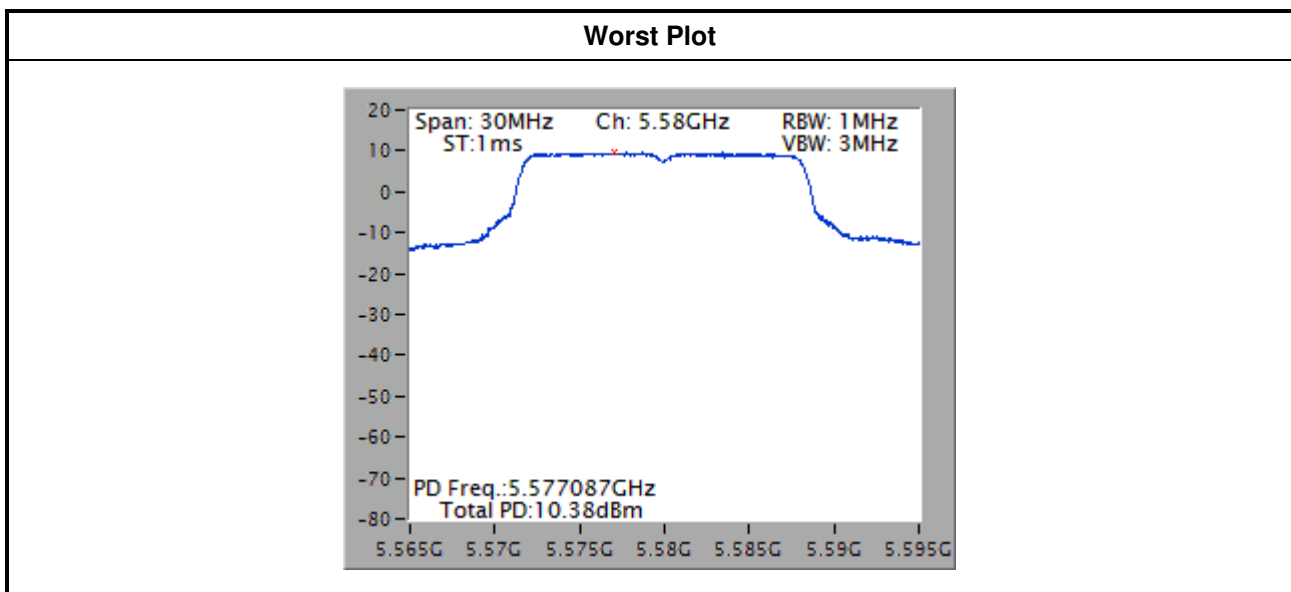

For Frequency band 5725-5850 MHz						
Condition			Peak Power Spectral Density (dBm/500kHz)			
Modulation Mode	N _{TX}	Freq. (MHz)	PPSD w/o D.F (dBm/500kHz)	Duty Factor (dB)	PPSD with D.F (dBm/500kHz)	PPSD Limit (dBm/500kHz)
11a	2	5745	2.92	0.00	2.92	29.99
11a	2	5785	6.86	0.00	6.86	29.99
11a	2	5825	5.23	0.00	5.23	29.99

Note:

1. D.F is duty factor.
2. Test result is bin-by-bin summing measured value of each TX port.
3. Directional gain = $10 * \log((10^{3.33/20} + 10^{2.65/20})^2 / 2) = 6.01 \text{ dBi} > 6 \text{ dBi}$.
Limit shall be reduced to $30 \text{ dBm} - (6.01 \text{ dBi} - 6 \text{ dBi}) = 29.99 \text{ dBm}$.

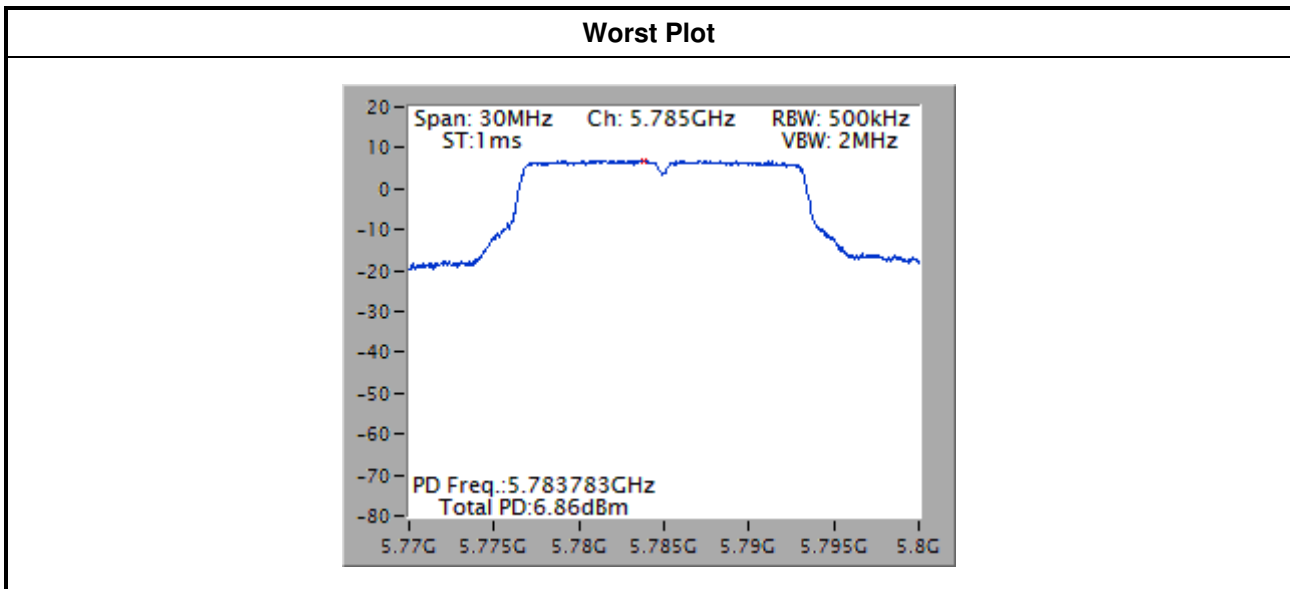

Beamforming mode

Frequency band			5150~5250 MHz / 5250~5350 MHz / 5470~5725 MHz			
Condition			Peak Power Spectral Density (dBm/MHz)			
Mode	N _{TX}	Freq. (MHz)	PPSD w/o D.F (dBm/MHz)	Duty Factor (dB)	PPSD with D.F (dBm/MHz)	PPSD Limit (dBm/MHz)
VHT20	2	5180	3.59	0.00	3.59	10.79
VHT20	2	5200	2.75	0.00	2.75	10.79
VHT20	2	5240	2.63	0.00	2.63	10.79
VHT40	2	5190	1.04	0.00	1.04	10.79
VHT40	2	5230	1.68	0.00	1.68	10.79
VHT80	2	5210	-4.24	0.18	-4.06	10.79
VHT20	2	5260	3.61	0.00	3.61	10.85
VHT20	2	5300	3.54	0.00	3.54	10.85
VHT20	2	5320	5.00	0.00	5.00	10.85
VHT40	2	5270	2.08	0.00	2.08	10.85
VHT40	2	5310	1.52	0.00	1.52	10.85
VHT80	2	5290	-2.76	0.18	-2.58	10.85
VHT20	2	5500	4.98	0.00	4.98	10.96
VHT20	2	5580	10.43	0.00	10.43	10.96
VHT20	2	5700	5.29	0.00	5.29	10.96
VHT20	2	5720	8.81	0.00	8.81	10.96
VHT40	2	5510	-0.64	0.00	-0.64	10.96
VHT40	2	5590	7.38	0.00	7.38	10.96
VHT40	2	5670	2.84	0.00	2.84	10.96
VHT40	2	5710	6.10	0.00	6.10	10.96
VHT80	2	5530	-7.62	0.18	-7.44	10.96
VHT80	2	5610	-0.34	0.18	-0.16	10.96
VHT80	2	5690	3.09	0.18	3.27	10.96

Note:

1. D.F is duty factor.
2. Test result is bin-by-bin summing measured value of each TX port.
3. For 5150~5250MHz, Directional gain = $10 * \log((10^{3.3/20} + 10^{3.1/20})^2 / 2) = 6.21 \text{ dBi} > 6 \text{ dBi}$.
Limit shall be reduced to 11 dBm – (6.21 dBi – 6 dBi) = 10.79 dBm.
4. For 5250~5350MHz, Directional gain = $10 * \log((10^{3.17/20} + 10^{3.1/20})^2 / 2) = 6.15 \text{ dBi} > 6 \text{ dBi}$.
Limit shall be reduced to 11 dBm – (6.15 dBi – 6 dBi) = 10.85 dBm.
5. For 5470~5725MHz, Directional gain = $10 * \log((10^{3.31/20} + 10^{2.73/20})^2 / 2) = 6.04 \text{ dBi} > 6 \text{ dBi}$.
Limit shall be reduced to 11 dBm – (6.04 dBi – 6 dBi) = 10.96 dBm.

Worst Plot

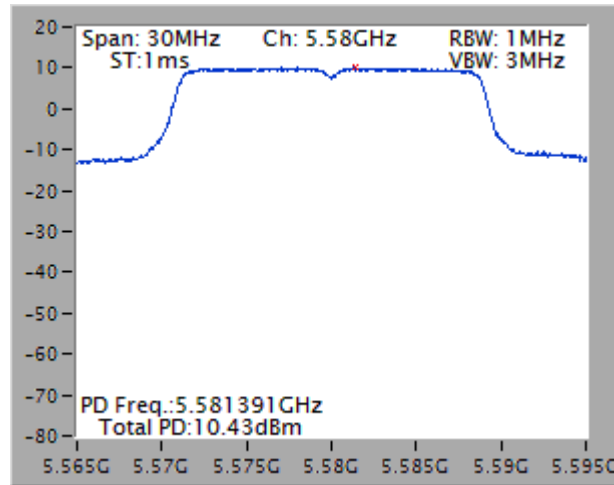

For Frequency band 5725-5850 MHz						
Condition			Peak Power Spectral Density (dBm/500kHz)			
Modulation Mode	N _{TX}	Freq. (MHz)	PPSD w/o D.F (dBm/500kHz)	Duty Factor (dB)	PPSD with D.F (dBm/500kHz)	PPSD Limit (dBm/500kHz)
VHT20	2	5745	2.62	0.00	2.62	29.99
VHT20	2	5785	6.13	0.00	6.13	29.99
VHT20	2	5825	4.12	0.00	4.12	29.99
VHT40	2	5755	-2.59	0.00	-2.59	29.99
VHT40	2	5795	1.16	0.00	1.16	29.99
VHT80	2	5775	-8.46	0.18	-8.28	29.99

Note:

1. D.F is duty factor.
2. Test result is bin-by-bin summing measured value of each TX port.
3. Directional gain = $10 * \log((10^{3.33/20} + 10^{2.65/20})^2 / 2) = 6.01 \text{ dBi} > 6 \text{ dBi}$.
Limit shall be reduced to $30 \text{ dBm} - (6.01 \text{ dBi} - 6 \text{ dBi}) = 29.99 \text{ dBm}$.

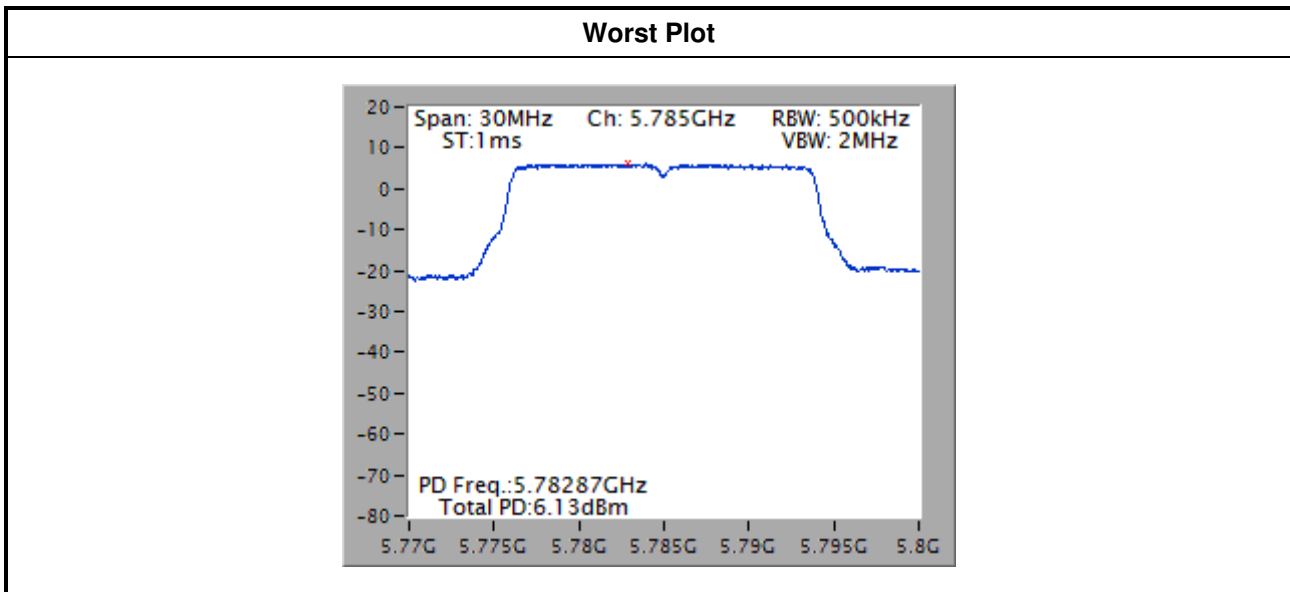

3.5 Transmitter Radiated and Band Edge Emissions

3.5.1 Limit of Transmitter Radiated and Band Edge Emissions

Restricted Band Emissions Limit			
Frequency Range (MHz)	Field Strength (uV/m)	Field Strength (dBuV/m)	Measure Distance (m)
0.009~0.490	2400/F(kHz)	48.5 - 13.8	300
0.490~1.705	24000/F(kHz)	33.8 - 23	30
1.705~30.0	30	29	30
30~88	100	40	3
88~216	150	43.5	3
216~960	200	46	3
Above 960	500	54	3

Note 1:
Qusai-Peak value is measured for frequency below 1GHz except for 9–90 kHz, 110–490 kHz frequency band. Peak and average value are measured for frequency above 1GHz. The limit on average radio frequency emission is as above table. The limit on peak radio frequency emissions is 20 dB above the maximum permitted average emission limit

Note 2:
Measurements may be performed at a distance other than what is specified provided. When performing measurements at a distance other than that specified, the results shall be extrapolated to the specified distance using an extrapolation factor as below, Frequency at or above 30 MHz: 20 dB/decade Frequency below 30 MHz: 40 dB/decade.

Un-restricted band emissions above 1GHz Limit	
Operating Band	Limit
5.15 - 5.25 GHz	e.i.r.p. -27 dBm [68.2 dBuV/m@3m]
5.725 - 5.850 GHz	<input checked="" type="checkbox"/> 15.407(b)(4)(i) All emissions shall be limited to a level of -27 dBm/MHz at 75 MHz or more above or below the band edge increasing linearly to 10 dBm/MHz at 25 MHz above or below the band edge, and from 25 MHz above or below the band edge increasing linearly to a level of 15.6 dBm/MHz at 5 MHz above or below the band edge, and from 5 MHz above or below the band edge increasing linearly to a level of 27 dBm/MHz at the band edge.
	<input type="checkbox"/> 15.407(b)(4)(ii) ,compliance with the emission limits in § 15.247(d) Shall be at least 30dB below that in the 100 kHz bandwidth within the band that contains the highest level of the desired power,. Attenuation below the general limits specified in §15.209(a) is not required. In addition,radiated emissions which fall in the restricted bands, as defined in §15.205(a), must also comply with the radiated emission limits specified in §15.209(a) (see § 15.205(c))

Note 1: Measurements may be performed at a distance other than the limit distance provided they are not performed in the near field and the emissions to be measured can be detected by the measurement equipment. When performing measurements at a distance other than that specified, the results shall be extrapolated to the specified distance using an extrapolation factor of 20 dB/decade (inverse of linear distance for field-strength measurements, inverse of linear distance-squared for power-density measurements).

3.5.2 Test Procedures

1. Measurement is made at a semi-anechoic chamber that incorporates a turntable allowing a EUT rotation of 360°. A continuously-rotating, remotely-controlled turntable is installed at the test site to support the EUT and facilitate determination of the direction of maximum radiation for each EUT emission frequency. The EUT is placed at test table. For emissions testing at or below 1 GHz, the table height is 80 cm above the reference ground plane. For emission measurements above 1 GHz, the table height is 1.5 m
2. Measurement is made with the antenna positioned in both the horizontal and vertical planes of polarization. The measurement antenna is varied in height (1 m ~ 4m) above the reference ground plane to obtain the maximum signal strength. Distance between EUT and antenna is 3 m.
3. This investigation is performed with the EUT rotated 360°, the antenna height scanned between 1 m and 4 m, and the antenna rotated to repeat the measurements for both the horizontal and vertical antenna polarizations.

Note:

1. 120kHz measurement bandwidth of test receiver and Quasi-peak detector is for radiated emission below 1GHz.
2. RBW=1MHz, VBW=3MHz and Peak detector is for peak measured value of radiated emission above 1GHz.
3. RBW=1MHz, VBW=1/T and Peak detector is for average measured value of radiated emission above 1GHz.

3.5.3 Test Setup

Radiated Emissions below 1 GHz

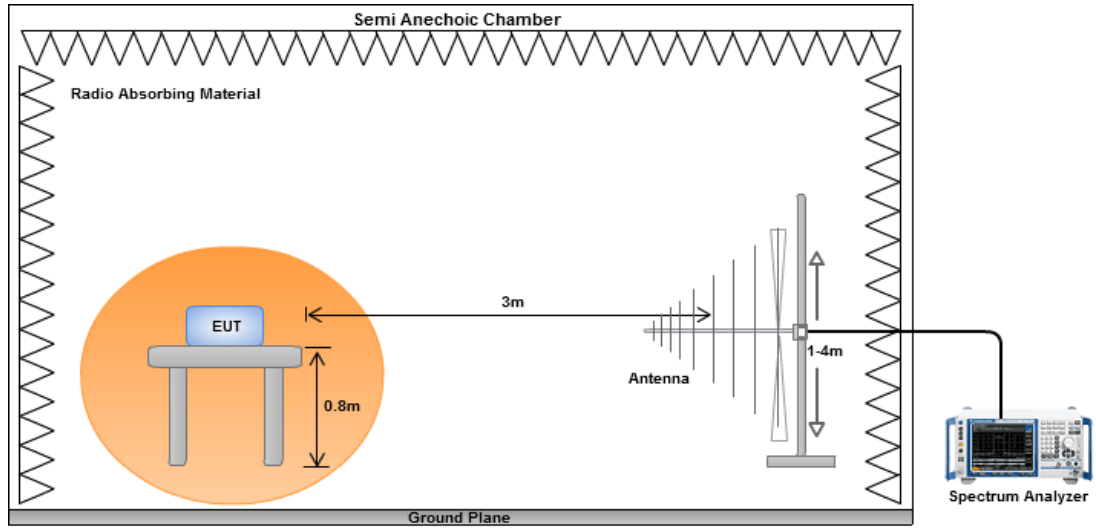

Radiated Emissions above 1 GHz

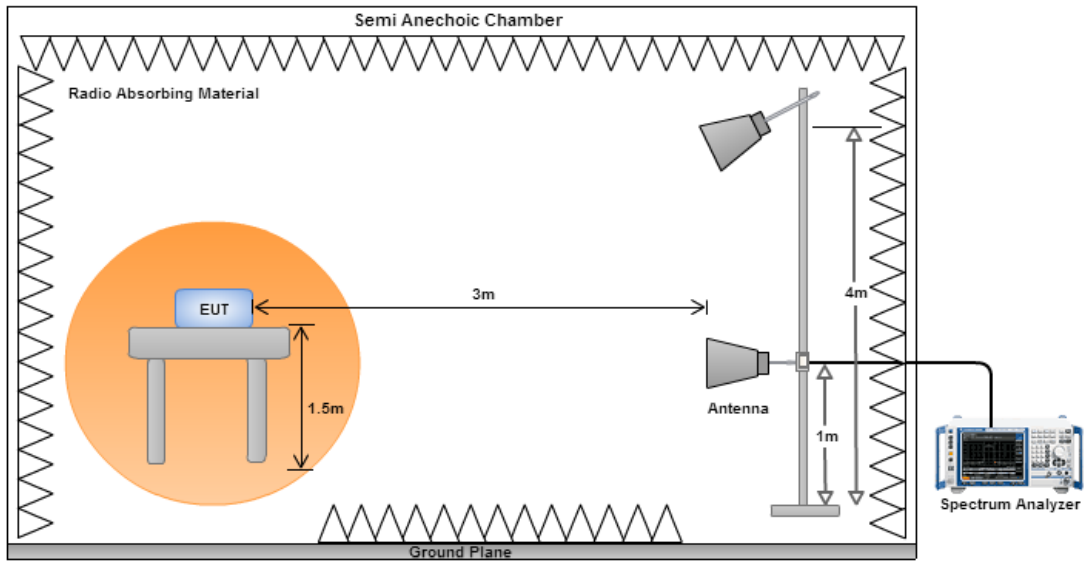

Non-beamforming mode

3.5.4 Transmitter Radiated Unwanted Emissions (Below 1GHz)

Modulation	11a	Test Freq. (MHz)	5580
Polarization	Horizontal		

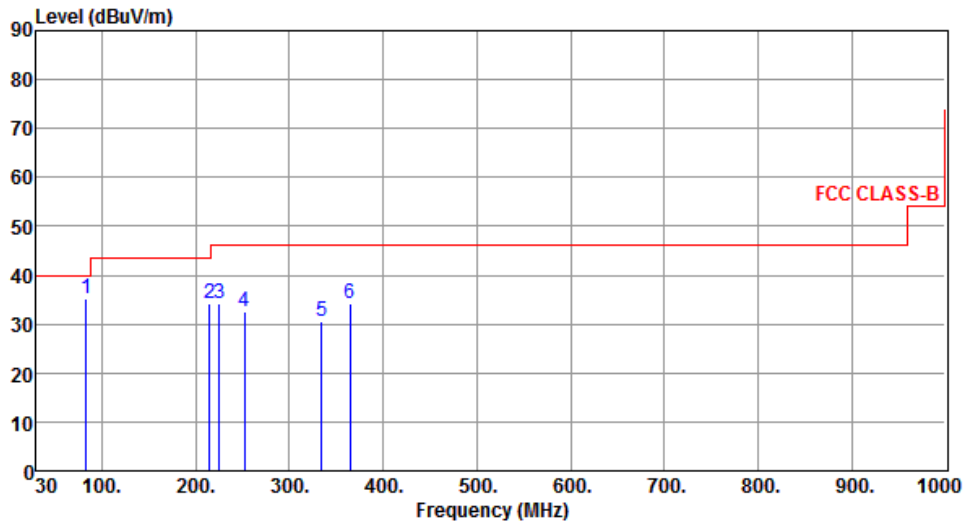

	Freq. MHz	Emission level dBuV/m	Limit dBuV/m	Margin dB	SA reading dBuV	Factor dB	Remark	ANT High cm	Turn Table deg
1	83.35	35.15	40.00	-4.85	53.47	-18.32	Peak	---	---
2	215.27	34.13	43.50	-9.37	50.25	-16.12	Peak	---	---
3	224.97	34.15	46.00	-11.85	49.86	-15.71	Peak	---	---
4	252.13	32.54	46.00	-13.46	47.13	-14.59	Peak	---	---
5	334.58	30.41	46.00	-15.59	42.33	-11.92	Peak	---	---
6	364.65	34.23	46.00	-11.77	45.32	-11.09	Peak	---	---

Note 1: Emission Level (dBuV/m) = SA Reading (dBuV/m) + Factor* (dB)

*Factor includes antenna factor, cable loss and amplifier gain

Note 2: Margin (dB) = Emission level (dBuV/m) – Limit (dBuV/m).

Note 3: All spurious emissions below 30MHz are more than 20 dB below the limit.

Modulation	11a	Test Freq. (MHz)	5580
Polarization	Vertical		

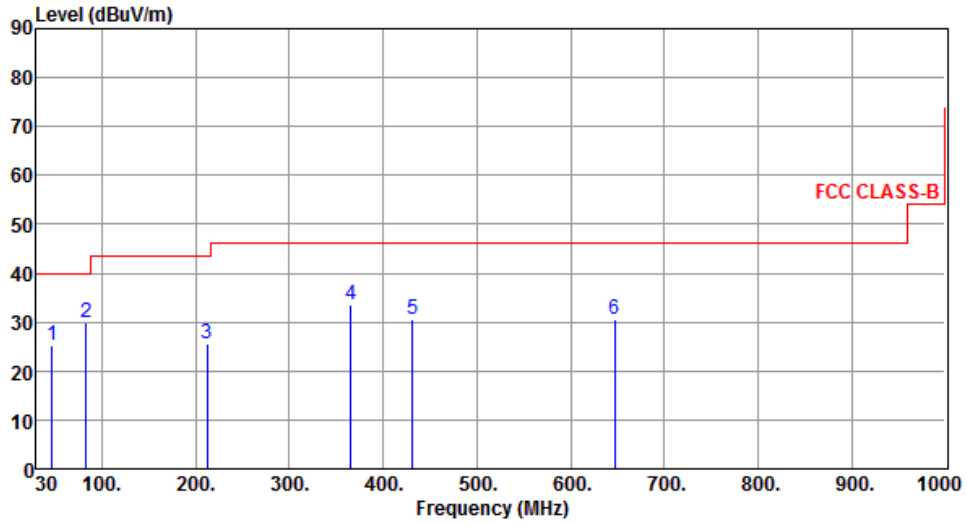

	Freq. MHz	Emission level dBuV/m	Limit dBuV/m	Margin dB	SA reading dBuV	Factor dB	Remark	ANT High cm	Turn Table deg
1	46.49	25.34	40.00	-14.66	38.40	-13.06	Peak	---	---
2	83.35	29.83	40.00	-10.17	48.15	-18.32	Peak	---	---
3	212.36	25.67	43.50	-17.83	41.83	-16.16	Peak	---	---
4	365.62	33.44	46.00	-12.56	44.51	-11.07	Peak	---	---
5	431.58	30.66	46.00	-15.34	39.94	-9.28	Peak	---	---
6	646.92	30.60	46.00	-15.40	35.98	-5.38	Peak	---	---

Note 1: Emission Level (dBuV/m) = SA Reading (dBuV/m) + Factor* (dB)

*Factor includes antenna factor , cable loss and amplifier gain

Note 2: Margin (dB) = Emission level (dBuV/m) – Limit (dBuV/m).

Note 3: All spurious emissions below 30MHz are more than 20 dB below the limit.

Modulation	11a	Test Freq. (MHz)	5785
Polarization	Horizontal		

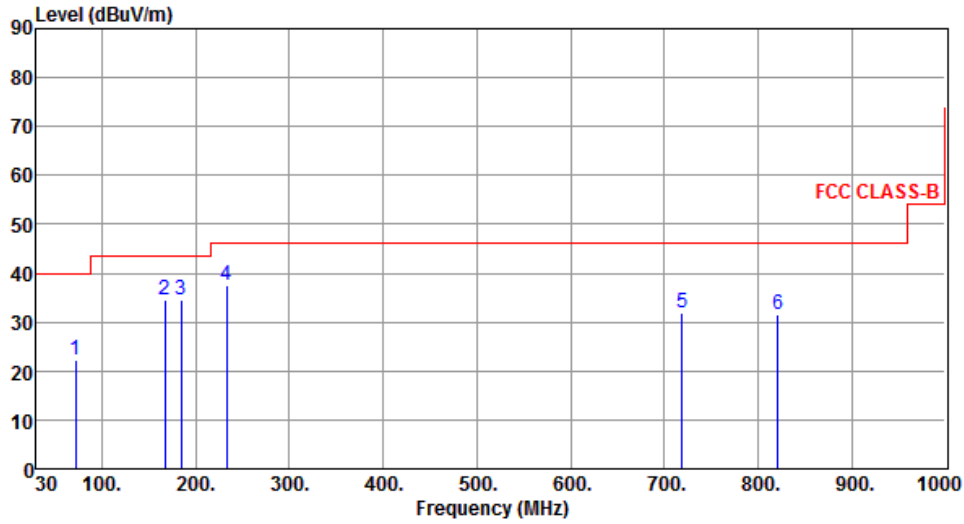

	Freq. MHz	Emission level dBuV/m	Limit dBuV/m	Margin dB	SA reading dBuV	Factor dB	Remark	ANT High cm	Turn Table deg
1	71.71	22.10	40.00	-17.90	41.70	-19.60	Peak	---	---
2	166.77	34.58	43.50	-8.92	51.42	-16.84	Peak	---	---
3	184.23	34.42	43.50	-9.08	52.88	-18.46	Peak	---	---
4	232.73	37.41	46.00	-8.59	55.36	-17.95	Peak	---	---
5	718.70	31.82	46.00	-14.18	39.51	-7.69	Peak	---	---
6	821.52	31.62	46.00	-14.38	38.10	-6.48	Peak	---	---

Note 1: Emission Level (dBuV/m) = SA Reading (dBuV/m) + Factor* (dB)

*Factor includes antenna factor , cable loss and amplifier gain

Note 2: Margin (dB) = Emission level (dBuV/m) – Limit (dBuV/m).

Note 3: All spurious emissions below 30MHz are more than 20 dB below the limit.

Modulation	11a	Test Freq. (MHz)	5785
Polarization	Vertical		

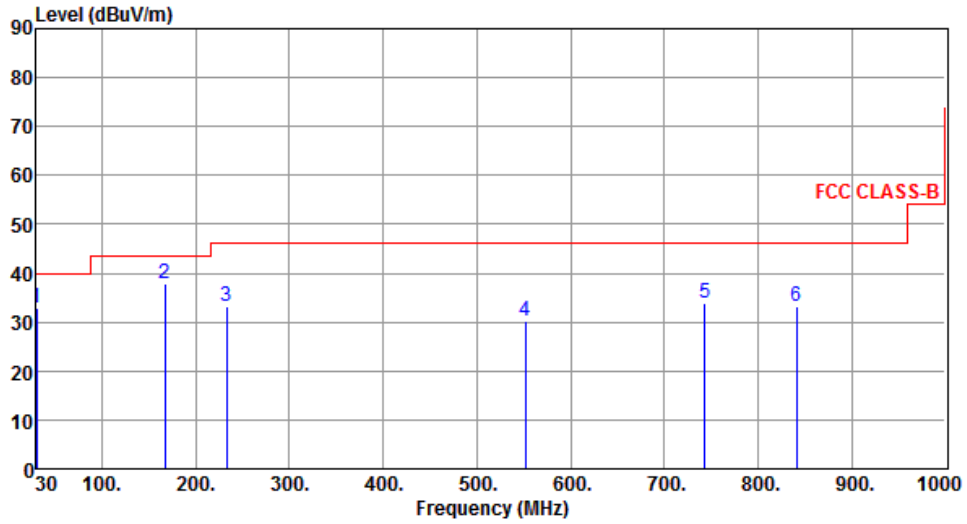

	Freq. MHz	Emission level dBuV/m	Limit dBuV/m	Margin dB	SA reading dBuV	Factor dB	Remark	ANT High cm	Turn Table deg
1	30.00	32.72	40.00	-7.28	50.15	-17.43	Peak	---	---
2	166.77	37.90	43.50	-5.60	54.74	-16.84	Peak	---	---
3	232.73	33.17	46.00	-12.83	51.12	-17.95	Peak	---	---
4	551.86	30.33	46.00	-15.67	40.73	-10.40	Peak	---	---
5	742.95	33.95	46.00	-12.05	41.18	-7.23	Peak	---	---
6	840.92	33.35	46.00	-12.65	39.64	-6.29	Peak	---	---

Note 1: Emission Level (dBuV/m) = SA Reading (dBuV/m) + Factor* (dB)

*Factor includes antenna factor , cable loss and amplifier gain

Note 2: Margin (dB) = Emission level (dBuV/m) – Limit (dBuV/m).

Note 3: All spurious emissions below 30MHz are more than 20 dB below the limit.

3.5.5 Transmitter Radiated Unwanted Emissions (Above 1GHz) for 11a

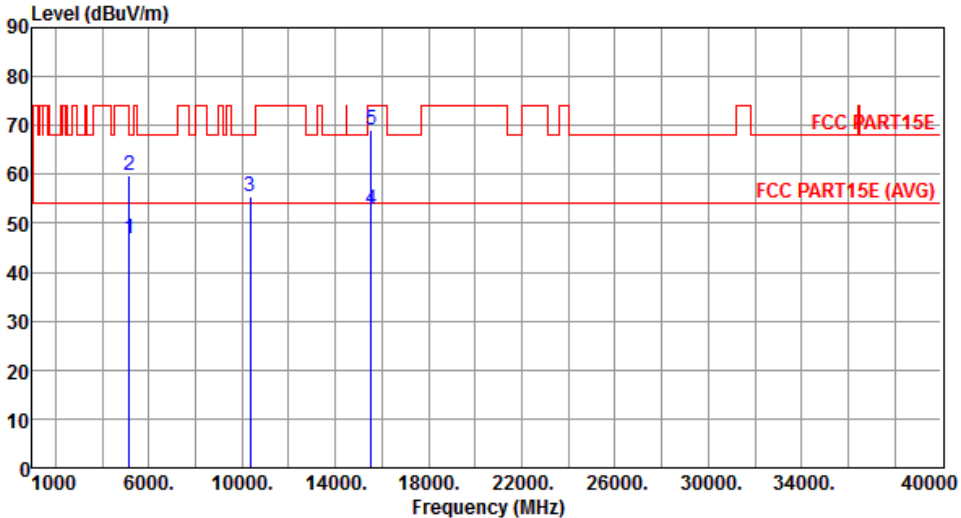
Modulation	11a	Test Freq. (MHz)	5180						
Polarization	Horizontal								
									
	Freq. MHz	Emission level dBuV/m	Limit dBuV/m	Margin dB	SA reading dBuV	Factor dB	Remark	ANT High cm	Turn Table deg
1	5150.00	46.85	54.00	-7.15	40.54	6.31	Average	187	306
2	5150.00	59.82	74.00	-14.18	53.51	6.31	Peak	187	306
3	10360.00	55.52	68.20	-12.68	39.18	16.34	Peak	271	108
4	15540.00	52.89	54.00	-1.11	35.39	17.50	Average	150	210
5	15540.00	69.18	74.00	-4.82	51.68	17.50	Peak	150	210

Note 1: Emission Level (dBuV/m) = SA Reading (dBuV/m) + Factor* (dB)
*Factor includes antenna factor , cable loss and amplifier gain
Note 2: Margin (dB) = Emission level (dBuV/m) – Limit (dBuV/m).

Modulation	11a	Test Freq. (MHz)	5180
Polarization	Vertical		

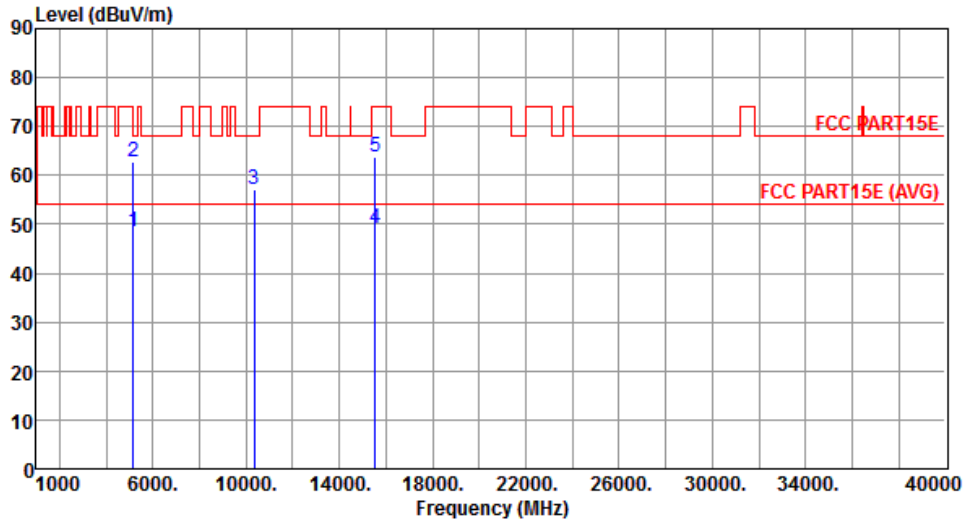

	Freq. MHz	Emission level dBuV/m	Limit dBuV/m	Margin dB	SA reading dBuV	Factor dB	Remark	ANT High cm	Turn Table deg
1	5150.00	48.37	54.00	-5.63	42.06	6.31	Average	150	182
2	5150.00	62.78	74.00	-11.22	56.47	6.31	Peak	150	182
3	10360.00	56.96	68.20	-11.24	40.62	16.34	Peak	181	269
4	15540.00	49.09	54.00	-4.91	31.59	17.50	Average	150	182
5	15540.00	63.75	74.00	-10.25	46.25	17.50	Peak	150	182

Note 1: Emission Level (dBuV/m) = SA Reading (dBuV/m) + Factor* (dB)

*Factor includes antenna factor , cable loss and amplifier gain

Note 2: Margin (dB) = Emission level (dBuV/m) – Limit (dBuV/m).

Modulation	11a	Test Freq. (MHz)	5200
Polarization	Horizontal		

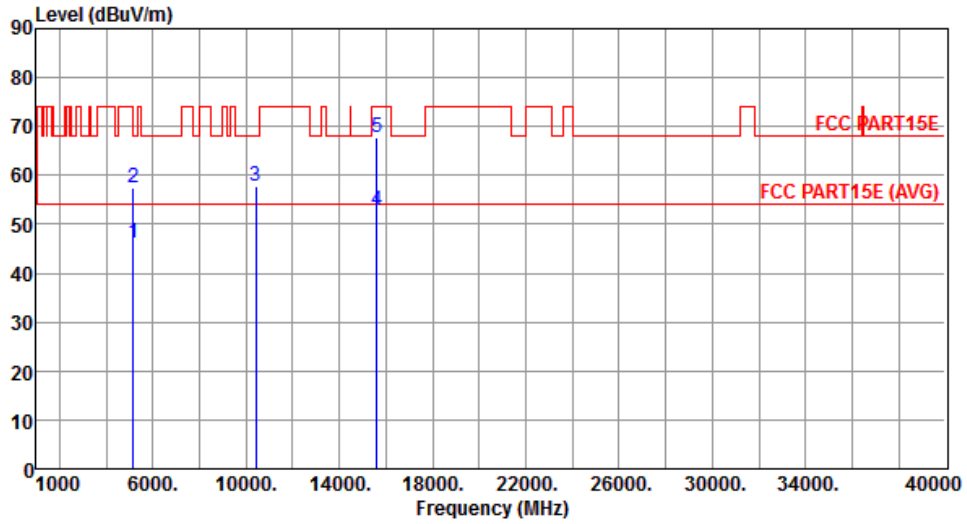

	Freq. MHz	Emission level dBuV/m	Limit dBuV/m	Margin dB	SA reading dBuV	Factor dB	Remark	ANT High cm	Turn Table deg
1	5150.00	46.22	54.00	-7.78	39.91	6.31	Average	150	111
2	5150.00	57.50	74.00	-16.50	51.19	6.31	Peak	150	111
3	10400.00	57.67	68.20	-10.53	41.25	16.42	Peak	267	218
4	15600.00	52.95	54.00	-1.05	35.57	17.38	Average	150	111
5	15600.00	67.64	74.00	-6.36	50.26	17.38	Peak	150	111

Note 1: Emission Level (dBuV/m) = SA Reading (dBuV/m) + Factor* (dB)

*Factor includes antenna factor , cable loss and amplifier gain

Note 2: Margin (dB) = Emission level (dBuV/m) – Limit (dBuV/m).

Modulation	11a	Test Freq. (MHz)	5200
Polarization	Vertical		

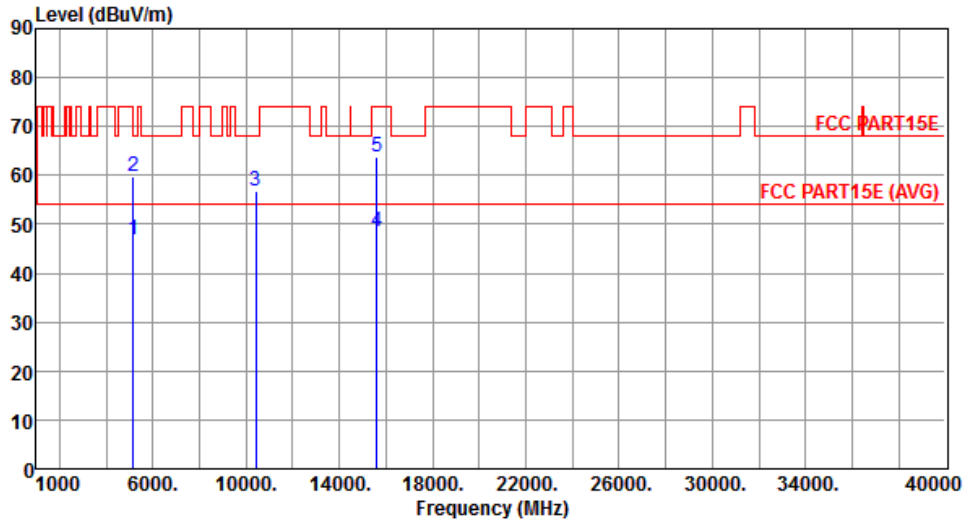

	Freq. MHz	Emission level dBuV/m	Limit dBuV/m	Margin dB	SA reading dBuV	Factor dB	Remark	ANT High cm	Turn Table deg
1	5150.00	46.86	54.00	-7.14	40.55	6.31	Average	259	107
2	5150.00	59.85	74.00	-14.15	53.54	6.31	Peak	259	107
3	10400.00	56.73	68.20	-11.47	40.31	16.42	Peak	301	91
4	15600.00	48.62	54.00	-5.38	31.24	17.38	Average	150	186
5	15600.00	63.88	74.00	-10.12	46.50	17.38	Peak	150	186

Note 1: Emission Level (dBuV/m) = SA Reading (dBuV/m) + Factor* (dB)

*Factor includes antenna factor , cable loss and amplifier gain

Note 2: Margin (dB) = Emission level (dBuV/m) – Limit (dBuV/m).

Modulation	11a	Test Freq. (MHz)	5240
Polarization	Horizontal		

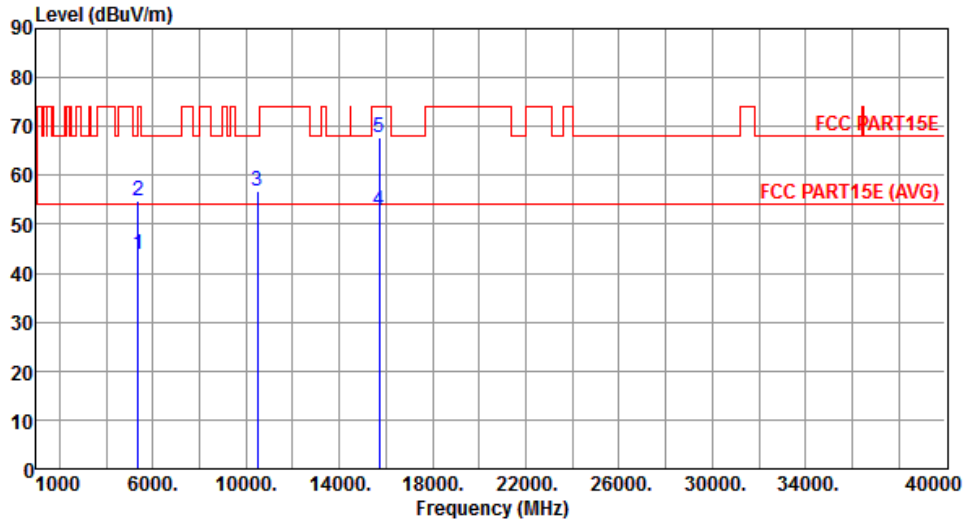

	Freq. MHz	Emission level dBuV/m	Limit dBuV/m	Margin dB	SA reading dBuV	Factor dB	Remark	ANT High cm	Turn Table deg
1	5350.00	43.98	54.00	-10.02	37.36	6.62	Average	150	117
2	5350.00	54.86	74.00	-19.14	48.24	6.62	Peak	150	117
3	10480.00	56.85	68.20	-11.35	40.29	16.56	Peak	169	305
4	15720.00	52.96	54.00	-1.04	35.81	17.15	Average	150	117
5	15720.00	67.59	74.00	-6.41	50.44	17.15	Peak	150	117

Note 1: Emission Level (dBuV/m) = SA Reading (dBuV/m) + Factor* (dB)

*Factor includes antenna factor , cable loss and amplifier gain

Note 2: Margin (dB) = Emission level (dBuV/m) – Limit (dBuV/m).

Modulation	11a	Test Freq. (MHz)	5240
Polarization	Vertical		

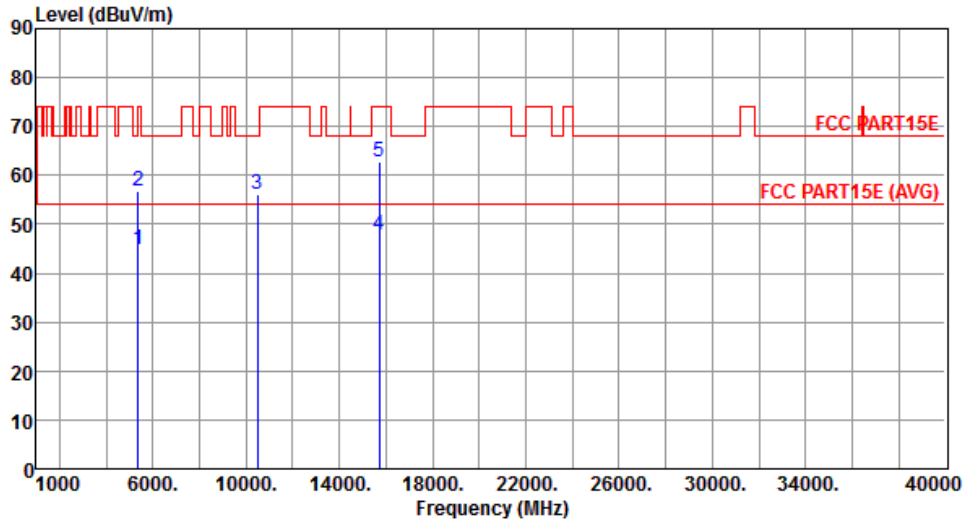

	Freq. MHz	Emission level dBuV/m	Limit dBuV/m	Margin dB	SA reading dBuV	Factor dB	Remark	ANT High cm	Turn Table deg
1	5350.00	44.90	54.00	-9.10	38.28	6.62	Average	288	108
2	5350.00	56.88	74.00	-17.12	50.26	6.62	Peak	288	108
3	10480.00	56.06	68.20	-12.14	39.50	16.56	Peak	177	269
4	15720.00	47.94	54.00	-6.06	30.79	17.15	Average	150	182
5	15720.00	62.81	74.00	-11.19	45.66	17.15	Peak	150	182

Note 1: Emission Level (dBuV/m) = SA Reading (dBuV/m) + Factor* (dB)

*Factor includes antenna factor , cable loss and amplifier gain

Note 2: Margin (dB) = Emission level (dBuV/m) – Limit (dBuV/m).

Modulation	11a	Test Freq. (MHz)	5260
Polarization	Horizontal		

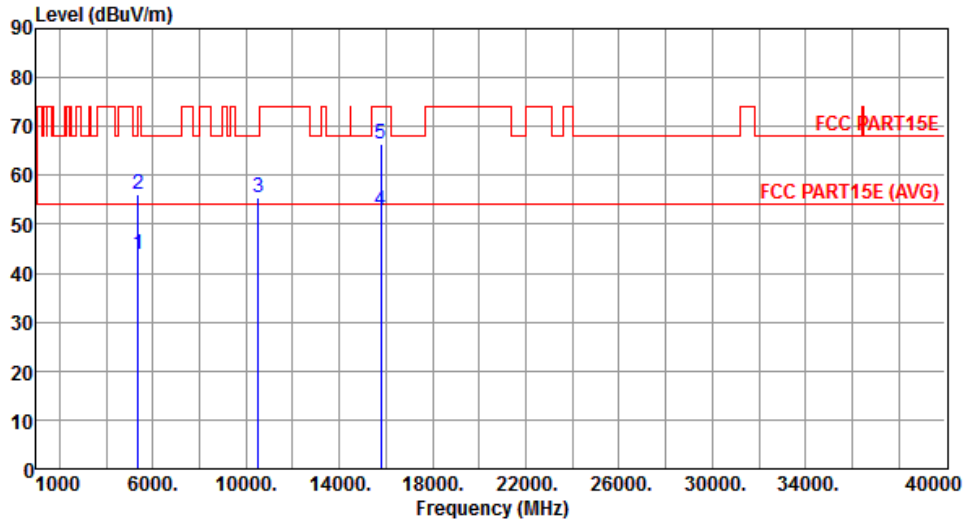

	Freq. MHz	Emission level dBuV/m	Limit dBuV/m	Margin dB	SA reading dBuV	Factor dB	Remark	ANT High cm	Turn Table deg
1	5350.00	43.88	54.00	-10.12	37.26	6.62	Average	209	314
2	5350.00	56.14	74.00	-17.86	49.52	6.62	Peak	209	314
3	10520.00	55.46	68.20	-12.74	38.86	16.60	Peak	305	291
4	15780.00	52.68	54.00	-1.32	35.63	17.05	Average	150	117
5	15780.00	66.51	74.00	-7.49	49.46	17.05	Peak	150	117

Note 1: Emission Level (dBuV/m) = SA Reading (dBuV/m) + Factor* (dB)

*Factor includes antenna factor , cable loss and amplifier gain

Note 2: Margin (dB) = Emission level (dBuV/m) – Limit (dBuV/m).

Modulation	11a	Test Freq. (MHz)	5260
Polarization	Vertical		

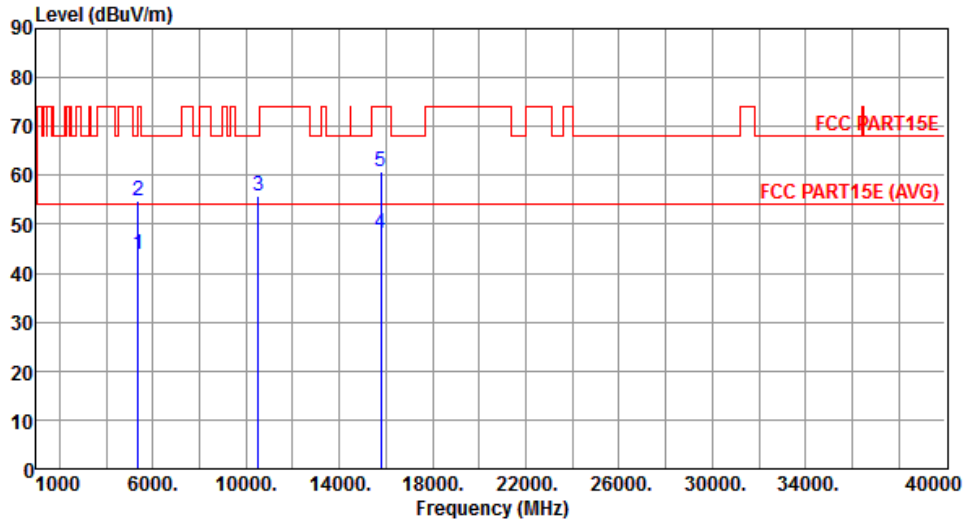

	Freq. MHz	Emission level dBuV/m	Limit dBuV/m	Margin dB	SA reading dBuV	Factor dB	Remark	ANT High cm	Turn Table deg
1	5350.00	43.81	54.00	-10.19	37.19	6.62	Average	203	135
2	5350.00	54.89	74.00	-19.11	48.27	6.62	Peak	203	135
3	10520.00	55.95	68.20	-12.25	39.35	16.60	Peak	226	182
4	15780.00	48.19	54.00	-5.81	31.14	17.05	Average	150	182
5	15780.00	60.71	74.00	-13.29	43.66	17.05	Peak	150	182

Note 1: Emission Level (dBuV/m) = SA Reading (dBuV/m) + Factor* (dB)

*Factor includes antenna factor , cable loss and amplifier gain

Note 2: Margin (dB) = Emission level (dBuV/m) – Limit (dBuV/m).

Modulation	11a	Test Freq. (MHz)	5300
Polarization	Horizontal		

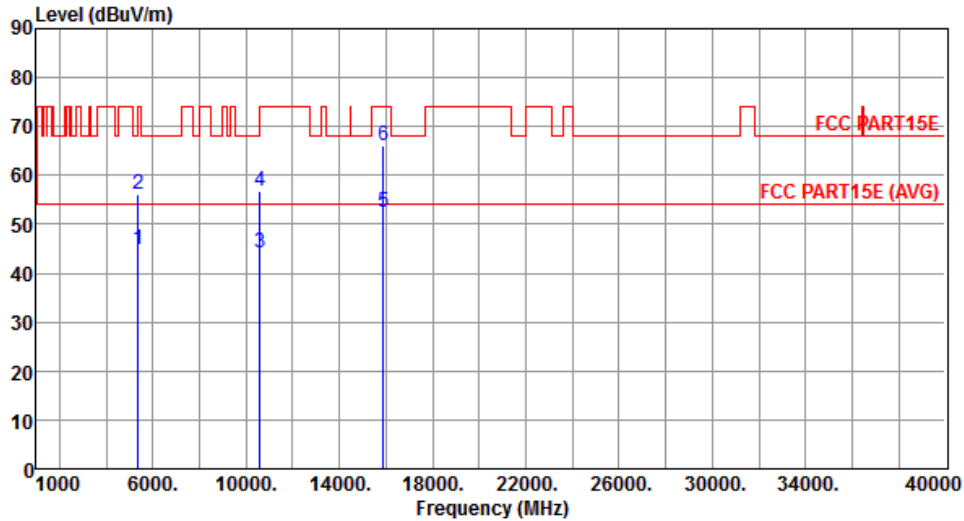

	Freq. MHz	Emission level dBuV/m	Limit dBuV/m	Margin dB	SA reading dBuV	Factor dB	Remark	ANT High cm	Turn Table deg
1	5350.00	44.88	54.00	-9.12	38.26	6.62	Average	188	313
2	5350.00	56.25	74.00	-17.75	49.63	6.62	Peak	188	313
3	10600.00	44.17	54.00	-9.83	27.55	16.62	Average	188	260
4	10600.00	56.88	74.00	-17.12	40.26	16.62	Peak	188	260
5	15900.00	52.52	54.00	-1.48	35.70	16.82	Average	157	113
6	15900.00	66.15	74.00	-7.85	49.33	16.82	Peak	157	113

Note 1: Emission Level (dBuV/m) = SA Reading (dBuV/m) + Factor* (dB)

*Factor includes antenna factor , cable loss and amplifier gain

Note 2: Margin (dB) = Emission level (dBuV/m) – Limit (dBuV/m).

Modulation	11a	Test Freq. (MHz)	5300
Polarization	Vertical		

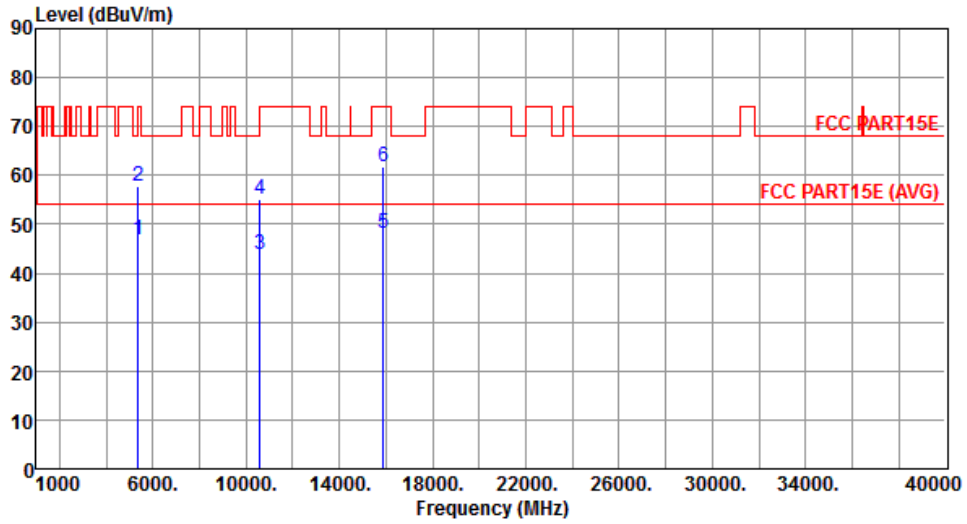

	Freq. MHz	Emission level dBuV/m	Limit dBuV/m	Margin dB	SA reading dBuV	Factor dB	Remark	ANT High cm	Turn Table deg
1	5350.00	46.91	54.00	-7.09	40.29	6.62	Average	286	110
2	5350.00	57.81	74.00	-16.19	51.19	6.62	Peak	286	110
3	10600.00	43.81	54.00	-10.19	27.19	16.62	Average	360	66
4	10600.00	55.22	74.00	-18.78	38.60	16.62	Peak	360	66
5	15900.00	48.28	54.00	-5.72	31.46	16.82	Average	150	186
6	15900.00	61.67	74.00	-12.33	44.85	16.82	Peak	150	186

Note 1: Emission Level (dBuV/m) = SA Reading (dBuV/m) + Factor* (dB)

*Factor includes antenna factor , cable loss and amplifier gain

Note 2: Margin (dB) = Emission level (dBuV/m) – Limit (dBuV/m).

Modulation	11a	Test Freq. (MHz)	5320
Polarization	Horizontal		

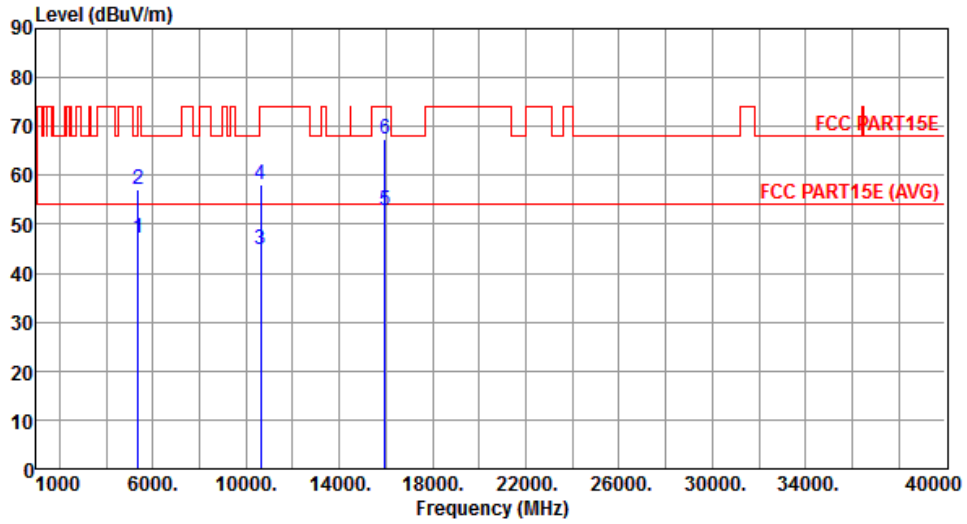

	Freq. MHz	Emission level dBuV/m	Limit dBuV/m	Margin dB	SA reading dBuV	Factor dB	Remark	ANT High cm	Turn Table deg
1	5350.00	47.24	54.00	-6.76	40.62	6.62	Average	187	312
2	5350.00	57.22	74.00	-16.78	50.60	6.62	Peak	187	312
3	10640.00	44.91	54.00	-9.09	28.28	16.63	Average	247	189
4	10640.00	58.03	74.00	-15.97	41.40	16.63	Peak	247	189
5	15960.00	52.77	54.00	-1.23	36.07	16.70	Average	150	116
6	15960.00	67.31	74.00	-6.69	50.61	16.70	Peak	150	116

Note 1: Emission Level (dBuV/m) = SA Reading (dBuV/m) + Factor* (dB)

*Factor includes antenna factor , cable loss and amplifier gain

Note 2: Margin (dB) = Emission level (dBuV/m) – Limit (dBuV/m).

Modulation	11a	Test Freq. (MHz)	5320
Polarization	Vertical		

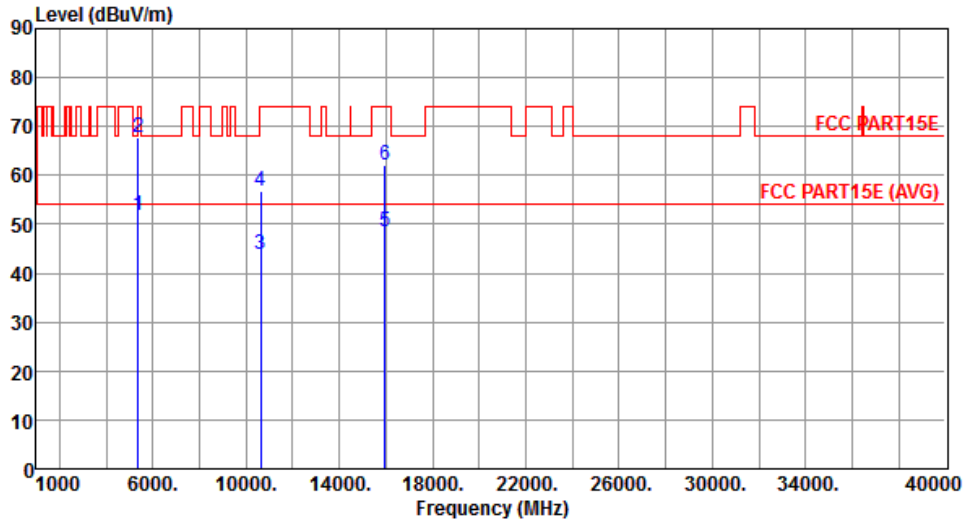

	Freq. MHz	Emission level dBuV/m	Limit dBuV/m	Margin dB	SA reading dBuV	Factor dB	Remark	ANT High cm	Turn Table deg
1	5350.00	51.65	54.00	-2.35	45.03	6.62	Average	319	107
2	5350.00	67.59	74.00	-6.41	60.97	6.62	Peak	319	107
3	10640.00	43.89	54.00	-10.11	27.26	16.63	Average	271	151
4	10640.00	56.72	74.00	-17.28	40.09	16.63	Peak	271	151
5	15960.00	48.55	54.00	-5.45	31.85	16.70	Average	150	184
6	15960.00	61.97	74.00	-12.03	45.27	16.70	Peak	150	184

Note 1: Emission Level (dBuV/m) = SA Reading (dBuV/m) + Factor* (dB)

*Factor includes antenna factor , cable loss and amplifier gain

Note 2: Margin (dB) = Emission level (dBuV/m) – Limit (dBuV/m).

Modulation	11a	Test Freq. (MHz)	5500
Polarization	Horizontal		

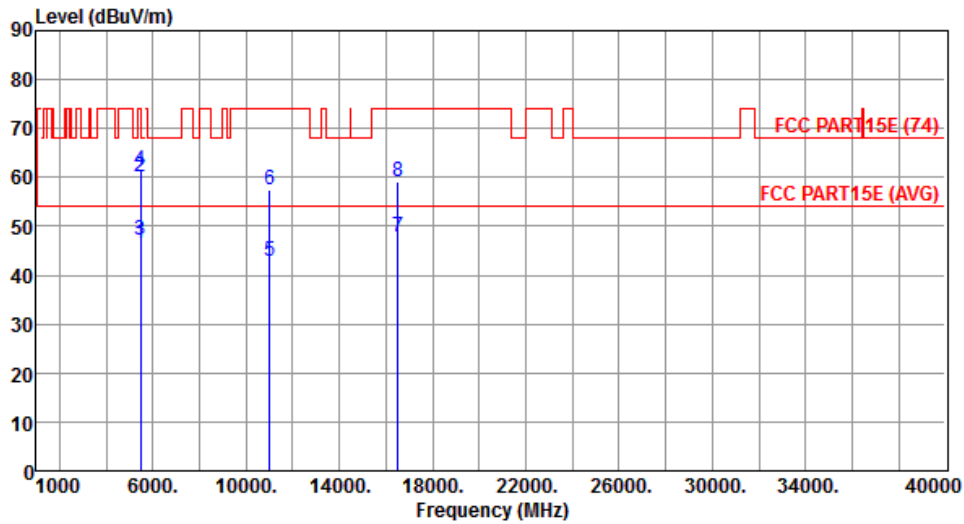

	Freq. MHz	Emission level dBuV/m	Limit dBuV/m	Margin dB	SA reading dBuV	Factor dB	Remark	ANT High cm	Turn Table deg
1	5460.00	46.62	54.00	-7.38	39.86	6.76	Average	193	312
2	5460.00	60.02	74.00	-13.98	53.26	6.76	Peak	193	312
3	5470.00	47.26	54.00	-6.74	40.49	6.77	Average	193	312
4	5470.00	61.47	74.00	-12.53	54.70	6.77	Peak	193	312
5	11000.00	42.96	54.00	-11.04	26.24	16.72	Average	205	173
6	11000.00	57.51	74.00	-16.49	40.79	16.72	Peak	205	173
7	16500.00	47.87	54.00	-6.13	30.00	17.87	Average	252	274
8	16500.00	59.02	74.00	-14.98	41.15	17.87	Peak	252	274

Note 1: Emission Level (dBuV/m) = SA Reading (dBuV/m) + Factor* (dB)

*Factor includes antenna factor , cable loss and amplifier gain

Note 2: Margin (dB) = Emission level (dBuV/m) – Limit (dBuV/m).

Modulation	11a	Test Freq. (MHz)	5500
Polarization	Vertical		

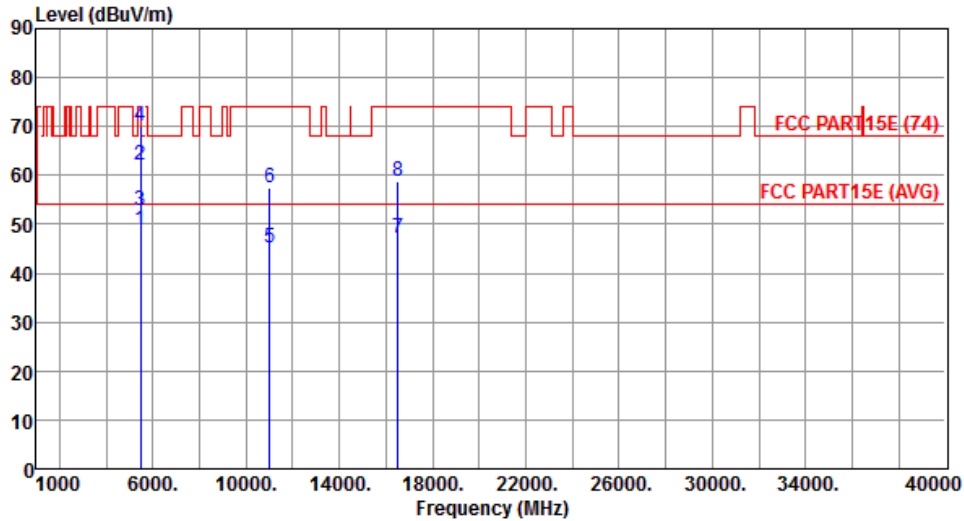

	Freq. MHz	Emission level dBuV/m	Limit dBuV/m	Margin dB	SA reading dBuV	Factor dB	Remark	ANT High cm	Turn Table deg
1	5460.00	48.82	54.00	-5.18	42.06	6.76	Average	280	108
2	5460.00	62.11	74.00	-11.89	55.35	6.76	Peak	280	108
3	5470.00	52.67	54.00	-1.33	45.90	6.77	Average	280	108
4	5470.00	69.97	74.00	-4.03	63.20	6.77	Peak	280	108
5	11000.00	45.11	54.00	-8.89	28.39	16.72	Average	150	348
6	11000.00	57.46	74.00	-16.54	40.74	16.72	Peak	150	348
7	16500.00	47.10	54.00	-6.90	29.23	17.87	Average	171	228
8	16500.00	58.71	74.00	-15.29	40.84	17.87	Peak	171	228

Note 1: Emission Level (dBuV/m) = SA Reading (dBuV/m) + Factor* (dB)

*Factor includes antenna factor , cable loss and amplifier gain

Note 2: Margin (dB) = Emission level (dBuV/m) – Limit (dBuV/m).

Modulation	11a	Test Freq. (MHz)	5580
Polarization	Horizontal		

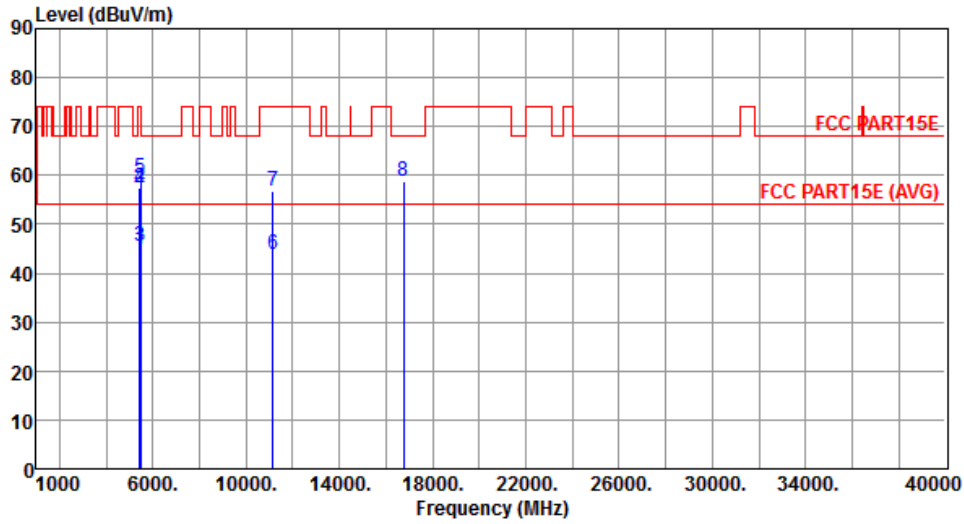

	Freq. MHz	Emission level dBuV/m	Limit dBuV/m	Margin dB	SA reading dBuV	Factor dB	Remark	ANT High cm	Turn Table deg
1	5420.00	44.87	54.00	-9.13	38.15	6.72	Average	302	264
2	5420.00	57.57	74.00	-16.43	50.85	6.72	Peak	302	264
3	5460.00	45.61	54.00	-8.39	38.85	6.76	Average	190	308
4	5460.00	57.38	74.00	-16.62	50.62	6.76	Peak	190	308
5	5470.00	59.30	68.20	-8.90	52.53	6.77	Peak	190	308
6	11160.00	43.97	54.00	-10.03	27.18	16.79	Average	254	29
7	11160.00	56.73	74.00	-17.27	39.94	16.79	Peak	254	29
8	16740.00	58.67	68.20	-9.53	40.27	18.40	Peak	304	117

Note 1: Emission Level (dBuV/m) = SA Reading (dBuV/m) + Factor* (dB)

*Factor includes antenna factor , cable loss and amplifier gain

Note 2: Margin (dB) = Emission level (dBuV/m) – Limit (dBuV/m).

Modulation	11a	Test Freq. (MHz)	5580
Polarization	Vertical		

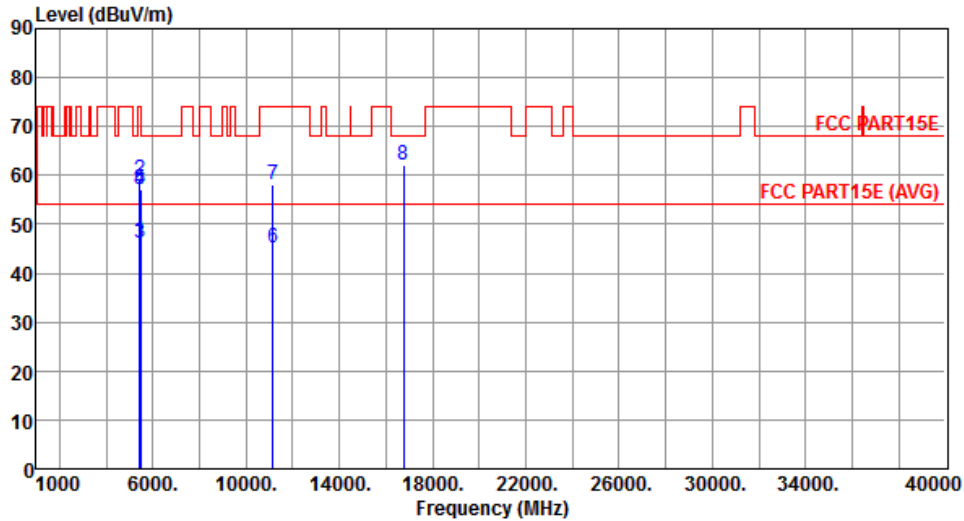

	Freq. MHz	Emission level dBuV/m	Limit dBuV/m	Margin dB	SA reading dBuV	Factor dB	Remark	ANT High cm	Turn Table deg
1	5420.00	46.62	54.00	-7.38	39.90	6.72	Average	286	105
2	5420.00	59.18	74.00	-14.82	52.46	6.72	Peak	286	105
3	5460.00	46.04	54.00	-7.96	39.28	6.76	Average	251	110
4	5460.00	57.11	74.00	-16.89	50.35	6.76	Peak	251	110
5	5470.00	57.02	68.20	-11.18	50.25	6.77	Peak	251	110
6	11160.00	45.15	54.00	-8.85	28.36	16.79	Average	196	347
7	11160.00	58.04	74.00	-15.96	41.25	16.79	Peak	196	347
8	16740.00	62.10	68.20	-6.10	43.70	18.40	Peak	308	81

Note 1: Emission Level (dBuV/m) = SA Reading (dBuV/m) + Factor* (dB)

*Factor includes antenna factor , cable loss and amplifier gain

Note 2: Margin (dB) = Emission level (dBuV/m) – Limit (dBuV/m).

Modulation	11a	Test Freq. (MHz)	5700
Polarization	Horizontal		

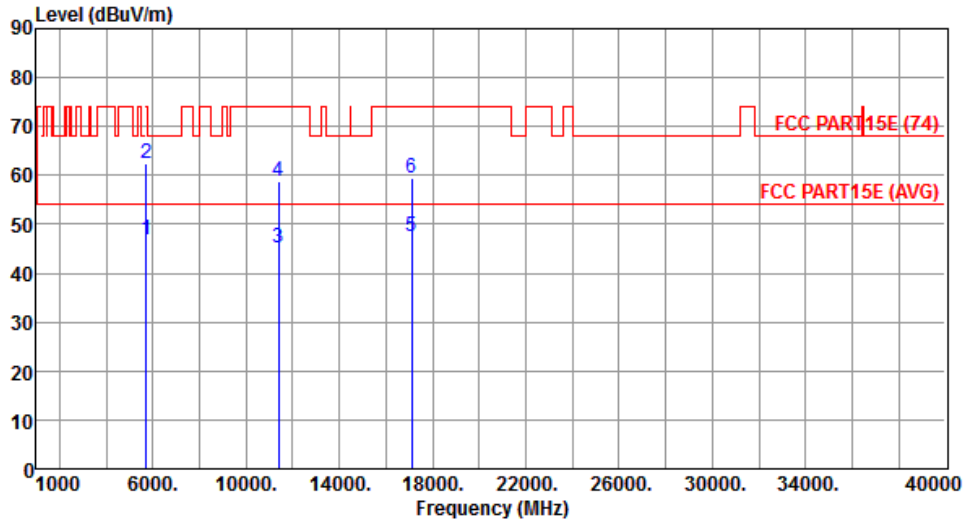

	Freq. MHz	Emission level dBuV/m	Limit dBuV/m	Margin dB	SA reading dBuV	Factor dB	Remark	ANT High cm	Turn Table deg
1	5725.00	46.80	54.00	-7.20	39.56	7.24	Average	185	310
2	5725.00	62.50	74.00	-11.50	55.26	7.24	Peak	185	310
3	11400.00	45.09	54.00	-8.91	28.21	16.88	Average	247	165
4	11400.00	58.66	74.00	-15.34	41.78	16.88	Peak	247	165
5	17100.00	47.44	54.00	-6.56	28.32	19.12	Average	200	192
6	17100.00	59.38	74.00	-14.62	40.26	19.12	Peak	200	192

Note 1: Emission Level (dBuV/m) = SA Reading (dBuV/m) + Factor* (dB)

*Factor includes antenna factor , cable loss and amplifier gain

Note 2: Margin (dB) = Emission level (dBuV/m) – Limit (dBuV/m).

Modulation	11a	Test Freq. (MHz)	5700
Polarization	Vertical		

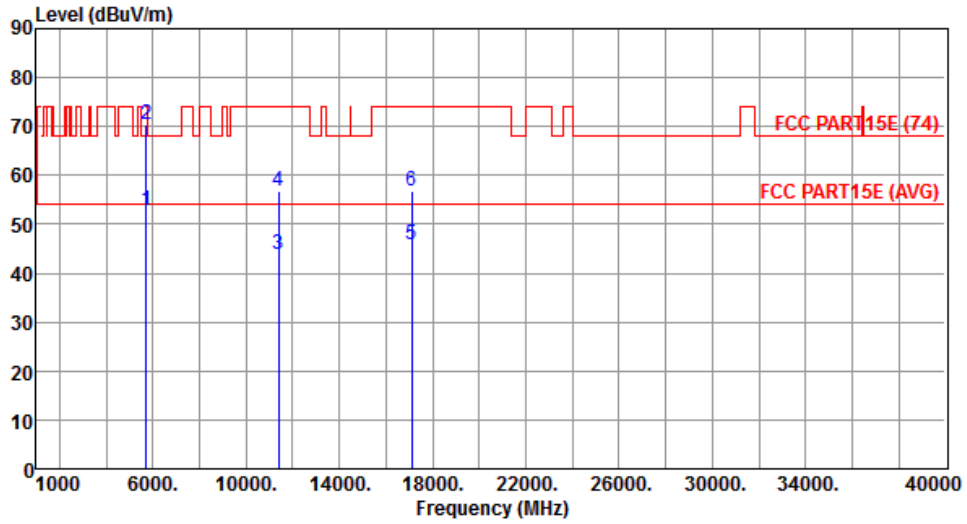

	Freq. MHz	Emission level dBuV/m	Limit dBuV/m	Margin dB	SA reading dBuV	Factor dB	Remark	ANT High cm	Turn Table deg
1	5725.00	52.94	54.00	-1.06	45.70	7.24	Average	252	106
2	5725.00	70.39	74.00	-3.61	63.15	7.24	Peak	252	106
3	11400.00	43.95	54.00	-10.05	27.07	16.88	Average	250	267
4	11400.00	56.84	74.00	-17.16	39.96	16.88	Peak	250	267
5	17100.00	45.78	54.00	-8.22	26.66	19.12	Average	160	4
6	17100.00	56.71	74.00	-17.29	37.59	19.12	Peak	160	4

Note 1: Emission Level (dBuV/m) = SA Reading (dBuV/m) + Factor* (dB)

*Factor includes antenna factor , cable loss and amplifier gain

Note 2: Margin (dB) = Emission level (dBuV/m) – Limit (dBuV/m).

Modulation	11a	Test Freq. (MHz)	5720
Polarization	Horizontal		

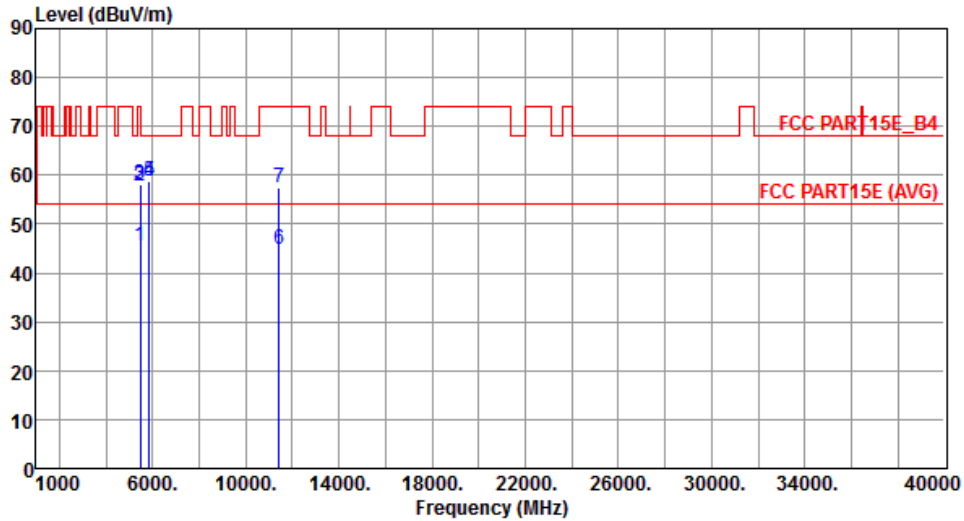

	Freq. MHz	Emission level dBuV/m	Limit dBuV/m	Margin dB	SA reading dBuV	Factor dB	Remark	ANT High cm	Turn Table deg
1	5460.00	45.55	54.00	-8.45	38.79	6.76	Average	201	306
2	5460.00	57.86	74.00	-16.14	51.10	6.76	Peak	201	306
3	5470.00	58.16	68.20	-10.04	51.39	6.77	Peak	201	306
4	5850.00	58.80	78.20	-19.40	51.30	7.50	Peak	201	306
5	5860.00	58.63	68.20	-9.57	51.12	7.51	Peak	201	306
6	11440.00	44.73	54.00	-9.27	27.83	16.90	Average	222	331
7	11440.00	57.33	74.00	-16.67	40.43	16.90	Peak	222	331

Note 1: Emission Level (dBuV/m) = SA Reading (dBuV/m) + Factor* (dB)

*Factor includes antenna factor , cable loss and amplifier gain

Note 2: Margin (dB) = Emission level (dBuV/m) – Limit (dBuV/m).

Modulation	11a	Test Freq. (MHz)	5720
Polarization	Vertical		

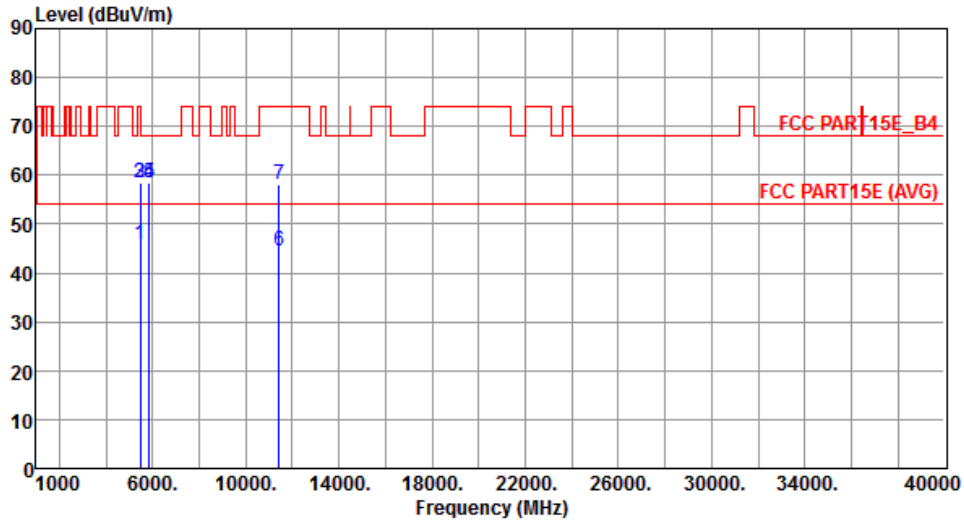

	Freq. MHz	Emission level dBuV/m	Limit dBuV/m	Margin dB	SA reading dBuV	Factor dB	Remark	ANT High cm	Turn Table deg
1	5460.00	45.80	54.00	-8.20	39.04	6.76	Average	169	123
2	5460.00	58.33	74.00	-15.67	51.57	6.76	Peak	169	123
3	5470.00	58.42	68.20	-9.78	51.65	6.77	Peak	169	123
4	5850.00	58.33	78.20	-19.87	50.83	7.50	Peak	169	123
5	5860.00	58.50	68.20	-9.70	50.99	7.51	Peak	169	123
6	11440.00	44.43	54.00	-9.57	27.53	16.90	Average	166	132
7	11440.00	58.16	74.00	-15.84	41.26	16.90	Peak	166	132

Note 1: Emission Level (dBuV/m) = SA Reading (dBuV/m) + Factor* (dB)
 *Factor includes antenna factor , cable loss and amplifier gain
 Note 2: Margin (dB) = Emission level (dBuV/m) – Limit (dBuV/m).

Modulation	11a	Test Freq. (MHz)	5745
Polarization	Horizontal		

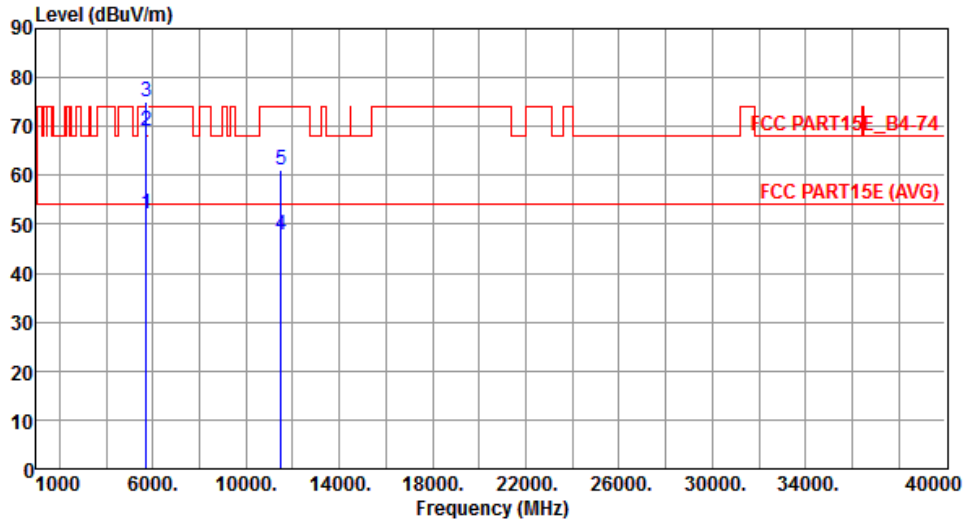

	Freq. MHz	Emission level dBuV/m	Limit dBuV/m	Margin dB	SA reading dBuV	Factor dB	Remark	ANT High cm	Turn Table deg
1	5715.00	52.13	54.00	-1.87	46.48	5.65	Average	213	48
2	5715.00	68.92	74.00	-5.08	63.27	5.65	Peak	213	48
3	5725.00	75.13	78.20	-3.07	69.49	5.64	Peak	213	48
4	11490.00	47.68	54.00	-6.32	31.75	15.93	Average	233	351
5	11490.00	61.02	74.00	-12.98	45.09	15.93	Peak	233	351

Note 1: Emission Level (dBuV/m) = SA Reading (dBuV/m) + Factor* (dB)

*Factor includes antenna factor , cable loss and amplifier gain

Note 2: Margin (dB) = Emission level (dBuV/m) – Limit (dBuV/m).

Modulation	11a	Test Freq. (MHz)	5745
Polarization	Vertical		

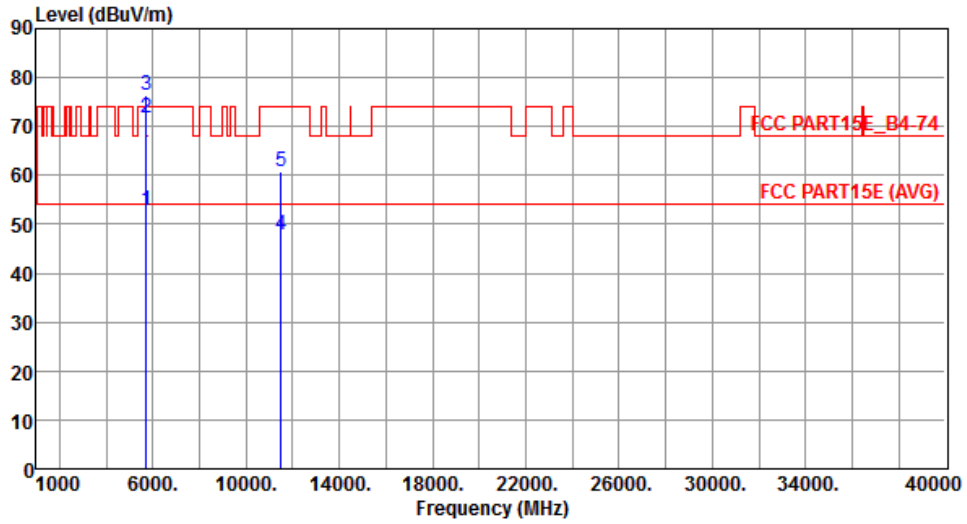

	Freq. MHz	Emission level dBuV/m	Limit dBuV/m	Margin dB	SA reading dBuV	Factor dB	Remark	ANT High cm	Turn Table deg
1	5715.00	52.95	54.00	-1.05	47.30	5.65	Average	111	237
2	5715.00	71.82	74.00	-2.18	66.17	5.65	Peak	111	237
3	5725.00	76.24	78.20	-1.96	70.60	5.64	Peak	111	237
4	11490.00	47.82	54.00	-6.18	31.89	15.93	Average	335	182
5	11490.00	60.74	74.00	-13.26	44.81	15.93	Peak	335	182

Note 1: Emission Level (dBuV/m) = SA Reading (dBuV/m) + Factor* (dB)
 *Factor includes antenna factor , cable loss and amplifier gain
 Note 2: Margin (dB) = Emission level (dBuV/m) – Limit (dBuV/m).

Modulation	11a	Test Freq. (MHz)	5785
Polarization	Horizontal		

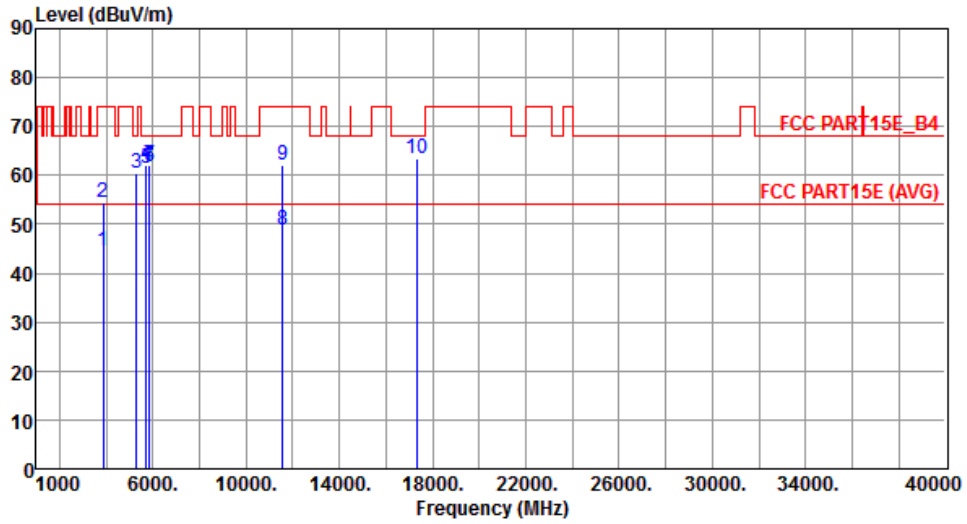

	Freq. MHz	Emission level dBuV/m	Limit dBuV/m	Margin dB	SA reading dBuV	Factor dB	Remark	ANT High cm	Turn Table deg
1	3856.70	44.42	54.00	-9.58	43.30	1.12	Average	232	302
2	3856.70	54.61	74.00	-19.39	53.49	1.12	Peak	232	302
3	5305.00	60.45	68.20	-7.75	54.90	5.55	Peak	204	130
4	5715.00	62.27	68.20	-5.93	56.62	5.65	Peak	220	46
5	5725.00	61.57	78.20	-16.63	55.93	5.64	Peak	220	46
6	5850.00	61.76	78.20	-16.44	56.01	5.75	Peak	220	46
7	5860.00	62.12	68.20	-6.08	56.36	5.76	Peak	220	46
8	11570.00	48.84	54.00	-5.16	33.07	15.77	Average	236	353
9	11570.00	62.10	74.00	-11.90	46.33	15.77	Peak	236	353
10	17355.00	63.33	68.20	-4.87	43.60	19.73	Peak	254	95

Note 1: Emission Level (dBuV/m) = SA Reading (dBuV/m) + Factor* (dB)

*Factor includes antenna factor , cable loss and amplifier gain

Note 2: Margin (dB) = Emission level (dBuV/m) – Limit (dBuV/m).

Modulation	11a	Test Freq. (MHz)	5785
Polarization	Vertical		

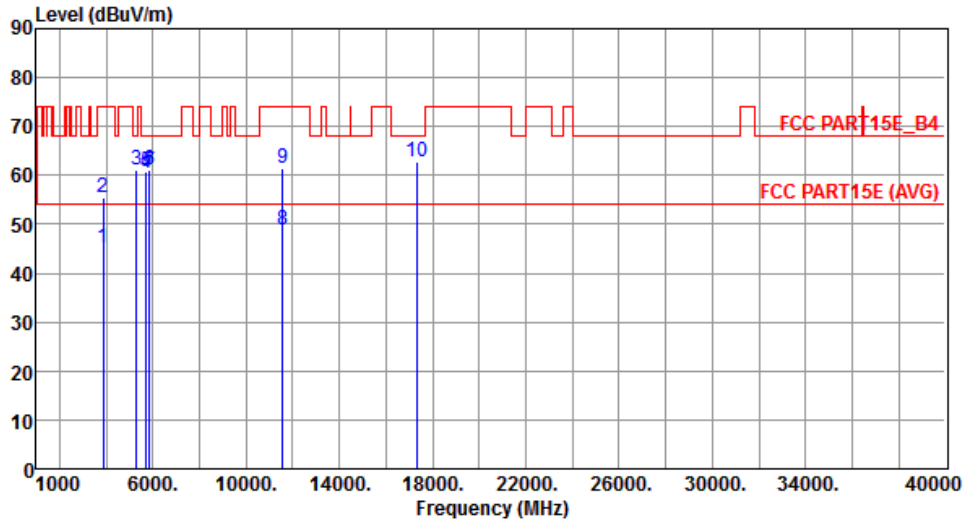

	Freq. MHz	Emission level dBuV/m	Limit dBuV/m	Margin dB	SA reading dBuV	Factor dB	Remark	ANT High cm	Turn Table deg
1	3856.70	45.22	54.00	-8.78	44.10	1.12	Average	249	22
2	3856.70	55.42	74.00	-18.58	54.30	1.12	Peak	249	22
3	5305.00	61.22	68.20	-6.98	55.67	5.55	Peak	217	255
4	5715.00	60.34	68.20	-7.86	54.69	5.65	Peak	232	292
5	5725.00	60.70	78.20	-17.50	55.06	5.64	Peak	232	292
6	5850.00	61.14	78.20	-17.06	55.39	5.75	Peak	232	292
7	5860.00	60.83	68.20	-7.37	55.07	5.76	Peak	232	292
8	11570.00	48.73	54.00	-5.27	32.96	15.77	Average	323	160
9	11570.00	61.59	74.00	-12.41	45.82	15.77	Peak	323	160
10	17355.00	62.85	68.20	-5.35	43.12	19.73	Peak	315	317

Note 1: Emission Level (dBuV/m) = SA Reading (dBuV/m) + Factor* (dB)

*Factor includes antenna factor , cable loss and amplifier gain

Note 2: Margin (dB) = Emission level (dBuV/m) – Limit (dBuV/m).

Modulation	11a	Test Freq. (MHz)	5825
Polarization	Horizontal		

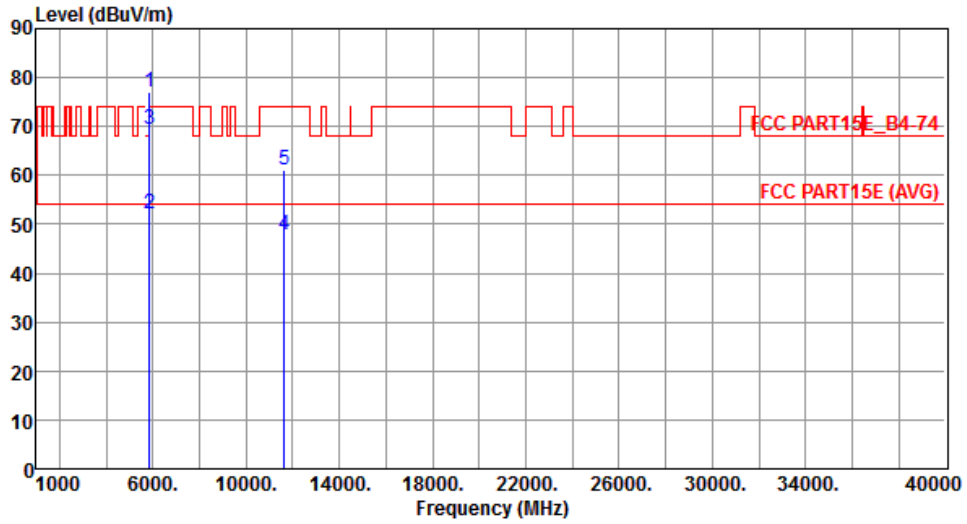

	Freq. MHz	Emission level dBuV/m	Limit dBuV/m	Margin dB	SA reading dBuV	Factor dB	Remark	ANT High cm	Turn Table deg
1	5850.00	77.10	78.20	-1.10	71.35	5.75	Peak	214	47
2	5860.00	52.23	54.00	-1.77	46.47	5.76	Average	214	47
3	5860.00	69.29	74.00	-4.71	63.53	5.76	Peak	214	47
4	11650.00	47.77	54.00	-6.23	32.21	15.56	Average	230	351
5	11650.00	61.07	74.00	-12.93	45.51	15.56	Peak	230	351

Note 1: Emission Level (dBuV/m) = SA Reading (dBuV/m) + Factor* (dB)

*Factor includes antenna factor , cable loss and amplifier gain

Note 2: Margin (dB) = Emission level (dBuV/m) – Limit (dBuV/m).

Modulation	11a	Test Freq. (MHz)	5825
Polarization	Vertical		

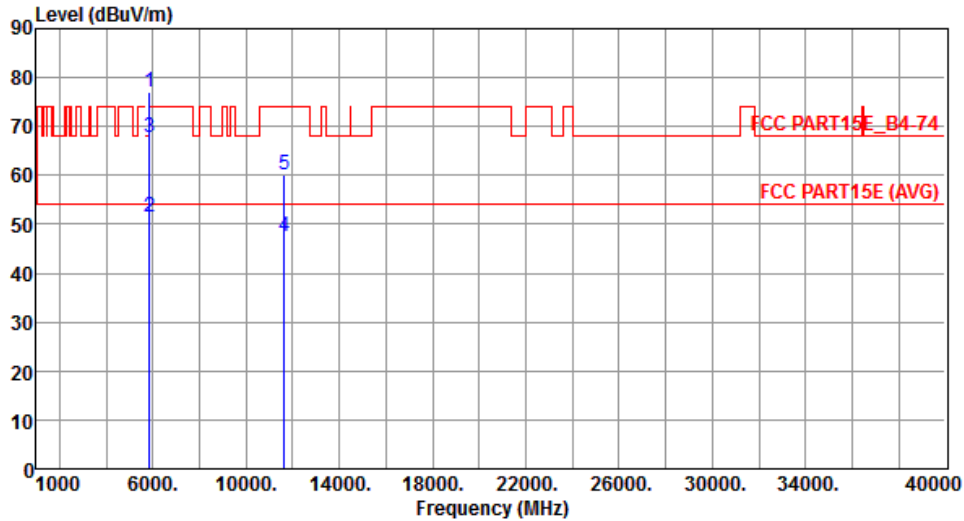

	Freq. MHz	Emission level dBuV/m	Limit dBuV/m	Margin dB	SA reading dBuV	Factor dB	Remark	ANT High cm	Turn Table deg
1	5850.00	76.94	78.20	-1.26	71.19	5.75	Peak	121	246
2	5860.00	51.58	54.00	-2.42	45.82	5.76	Average	121	246
3	5860.00	67.60	74.00	-6.40	61.84	5.76	Peak	121	246
4	11650.00	47.52	54.00	-6.48	31.96	15.56	Average	320	162
5	11650.00	60.27	74.00	-13.73	44.71	15.56	Peak	320	162

Note 1: Emission Level (dBuV/m) = SA Reading (dBuV/m) + Factor* (dB)

*Factor includes antenna factor , cable loss and amplifier gain

Note 2: Margin (dB) = Emission level (dBuV/m) – Limit (dBuV/m).

Beamforming mode

3.5.6 Transmitter Radiated Unwanted Emissions (Below 1GHz)

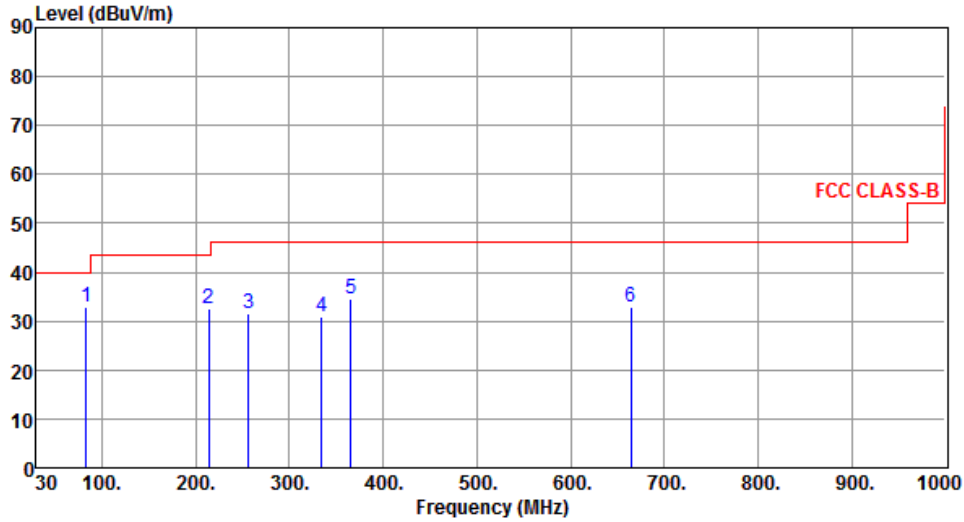
Modulation	VHT20	Test Freq. (MHz)	5580						
Polarization	Horizontal								
 <p>The graph plots Level (dBuV/m) on the y-axis (0 to 90) against Frequency (MHz) on the x-axis (30 to 1000). A red line represents the FCC CLASS-B limit, which is 40 dBuV/m from 30 to 100 MHz, 45 dBuV/m from 100 to 200 MHz, and 50 dBuV/m from 200 to 1000 MHz. Six blue vertical lines indicate emission peaks labeled 1 through 6, with their corresponding SA readings and factors listed in the table below.</p>									
	Freq.	Emission level	Limit	Margin	SA reading	Factor	Remark	ANT High cm	Turn Table deg
	MHz	dBuV/m	dBuV/m	dB	dBuV	dB			
1	83.35	32.72	40.00	-7.28	51.04	-18.32	Peak	---	---
2	214.30	32.51	43.50	-10.99	48.64	-16.13	Peak	---	---
3	256.01	31.41	46.00	-14.59	45.91	-14.50	Peak	---	---
4	334.58	31.00	46.00	-15.00	42.92	-11.92	Peak	---	---
5	365.62	34.68	46.00	-11.32	45.75	-11.07	Peak	---	---
6	664.38	32.88	46.00	-13.12	37.94	-5.06	Peak	---	---
<p>Note 1: Emission Level (dBuV/m) = SA Reading (dBuV/m) + Factor* (dB) *Factor includes antenna factor , cable loss and amplifier gain Note 2: Margin (dB) = Emission level (dBuV/m) – Limit (dBuV/m). Note 3: All spurious emissions below 30MHz are more than 20 dB below the limit.</p>									

Modulation	VHT20	Test Freq. (MHz)	5580
Polarization	Vertical		

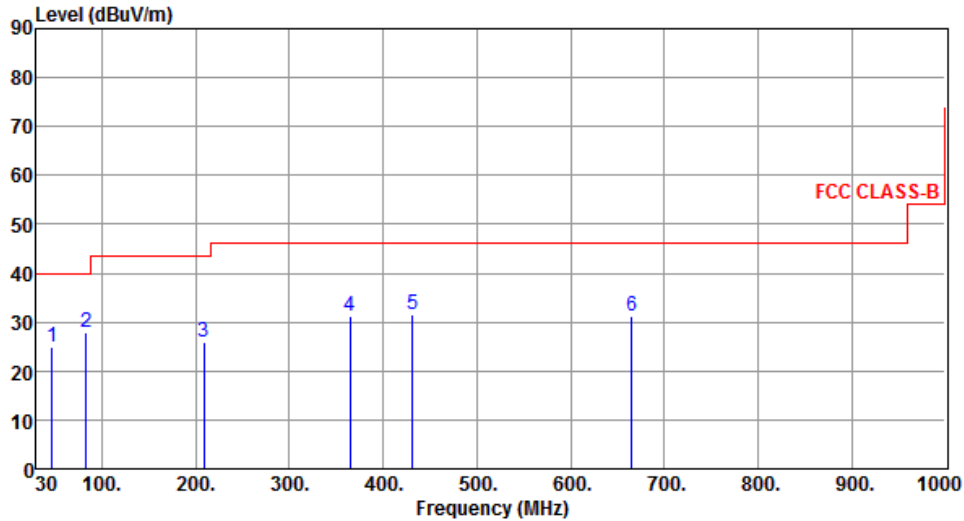

	Freq. MHz	Emission level dBuV/m	Limit dBuV/m	Margin dB	SA reading dBuV	Factor dB	Remark	ANT High cm	Turn Table deg
1	46.49	24.88	40.00	-15.12	37.94	-13.06	Peak	---	---
2	83.35	28.05	40.00	-11.95	46.37	-18.32	Peak	---	---
3	208.48	26.04	43.50	-17.46	42.28	-16.24	Peak	---	---
4	364.65	31.20	46.00	-14.80	42.29	-11.09	Peak	---	---
5	431.58	31.39	46.00	-14.61	40.67	-9.28	Peak	---	---
6	665.35	31.19	46.00	-14.81	36.23	-5.04	Peak	---	---

Note 1: Emission Level (dBuV/m) = SA Reading (dBuV/m) + Factor* (dB)

*Factor includes antenna factor , cable loss and amplifier gain

Note 2: Margin (dB) = Emission level (dBuV/m) – Limit (dBuV/m).

Note 3: All spurious emissions below 30MHz are more than 20 dB below the limit.

Modulation	VHT20	Test Freq. (MHz)	5785
Polarization	Horizontal		

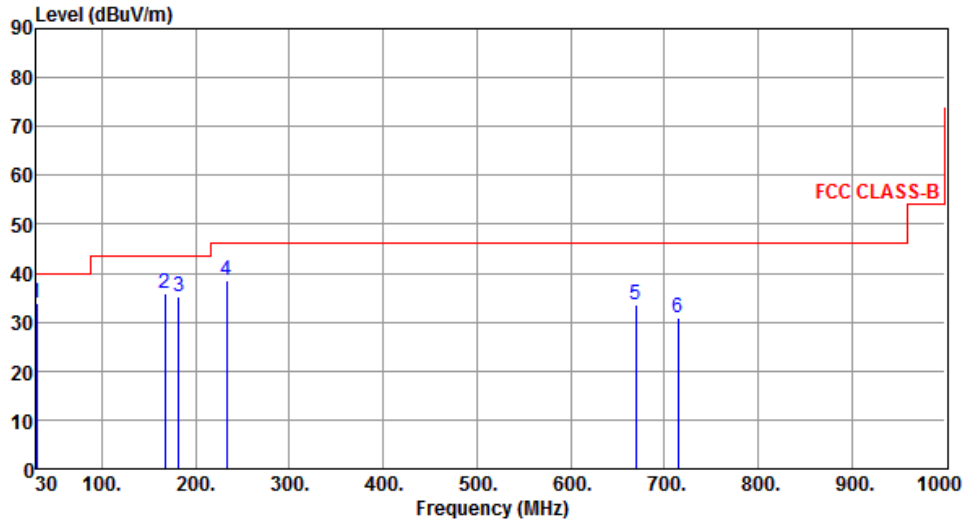

	Freq. MHz	Emission level dBuV/m	Limit dBuV/m	Margin dB	SA reading dBuV	Factor dB	Remark	ANT High cm	Turn Table deg
1	30.00	33.97	40.00	-6.03	51.40	-17.43	Peak	---	---
2	166.77	35.82	43.50	-7.68	52.66	-16.84	Peak	---	---
3	182.29	35.32	43.50	-8.18	53.59	-18.27	Peak	---	---
4	232.73	38.57	46.00	-7.43	56.52	-17.95	Peak	---	---
5	669.23	33.62	46.00	-12.38	42.15	-8.53	Peak	---	---
6	714.82	30.99	46.00	-15.01	38.75	-7.76	Peak	---	---

Note 1: Emission Level (dBuV/m) = SA Reading (dBuV/m) + Factor* (dB)

*Factor includes antenna factor, cable loss and amplifier gain

Note 2: Margin (dB) = Emission level (dBuV/m) – Limit (dBuV/m).

Note 3: All spurious emissions below 30MHz are more than 20 dB below the limit.

Modulation	VHT20	Test Freq. (MHz)	5785
Polarization	Vertical		

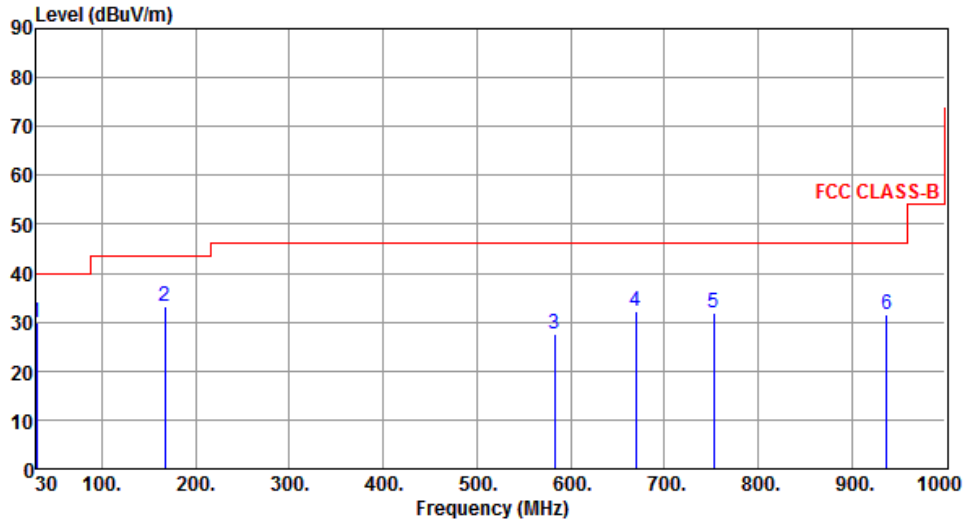

	Freq. MHz	Emission level dBuV/m	Limit dBuV/m	Margin dB	SA reading dBuV	Factor dB	Remark	ANT High cm	Turn Table deg
1	30.00	29.76	40.00	-10.24	47.19	-17.43	Peak	---	---
2	166.77	33.35	43.50	-10.15	50.19	-16.84	Peak	---	---
3	582.90	27.68	46.00	-18.32	37.53	-9.85	Peak	---	---
4	669.23	32.24	46.00	-13.76	40.77	-8.53	Peak	---	---
5	752.65	32.04	46.00	-13.96	39.12	-7.08	Peak	---	---
6	936.95	31.39	46.00	-14.61	36.30	-4.91	Peak	---	---

Note 1: Emission Level (dBuV/m) = SA Reading (dBuV/m) + Factor* (dB)

*Factor includes antenna factor , cable loss and amplifier gain

Note 2: Margin (dB) = Emission level (dBuV/m) – Limit (dBuV/m).

Note 3: All spurious emissions below 30MHz are more than 20 dB below the limit.

3.5.7 Transmitter Radiated Unwanted Emissions (Above 1GHz) for VHT20

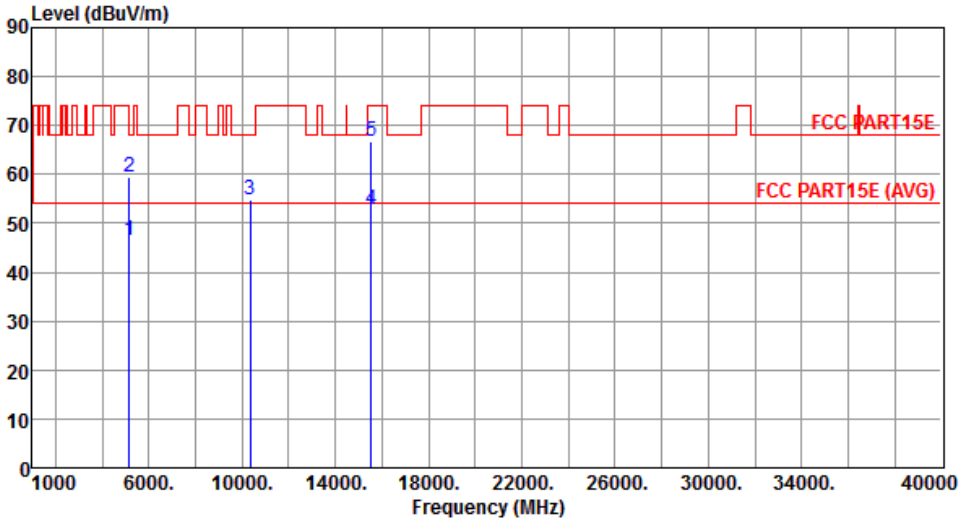
Modulation	VHT20	Test Freq. (MHz)	5180																																																																					
Polarization	Horizontal																																																																							
																																																																								
	<table border="1"> <thead> <tr> <th>Freq.</th> <th>Emission level</th> <th>Limit</th> <th>Margin</th> <th>SA reading</th> <th>Factor</th> <th>Remark</th> <th>ANT High</th> <th>Turn Table</th> </tr> <tr> <th>MHz</th> <th>dBuV/m</th> <th>dBuV/m</th> <th>dB</th> <th>dBuV</th> <th>dB</th> <th></th> <th>cm</th> <th>deg</th> </tr> </thead> <tbody> <tr> <td>1</td> <td>5150.00</td> <td>46.64</td> <td>54.00</td> <td>-7.36</td> <td>40.33</td> <td>6.31</td> <td>Average</td> <td>150</td> <td>240</td> </tr> <tr> <td>2</td> <td>5150.00</td> <td>59.49</td> <td>74.00</td> <td>-14.51</td> <td>53.18</td> <td>6.31</td> <td>Peak</td> <td>150</td> <td>240</td> </tr> <tr> <td>3</td> <td>10360.00</td> <td>54.88</td> <td>68.20</td> <td>-13.32</td> <td>38.54</td> <td>16.34</td> <td>Peak</td> <td>278</td> <td>162</td> </tr> <tr> <td>4</td> <td>15540.00</td> <td>52.85</td> <td>54.00</td> <td>-1.15</td> <td>35.35</td> <td>17.50</td> <td>Average</td> <td>155</td> <td>206</td> </tr> <tr> <td>5</td> <td>15540.00</td> <td>66.78</td> <td>74.00</td> <td>-7.22</td> <td>49.28</td> <td>17.50</td> <td>Peak</td> <td>155</td> <td>206</td> </tr> </tbody> </table>	Freq.	Emission level	Limit	Margin	SA reading	Factor	Remark	ANT High	Turn Table	MHz	dBuV/m	dBuV/m	dB	dBuV	dB		cm	deg	1	5150.00	46.64	54.00	-7.36	40.33	6.31	Average	150	240	2	5150.00	59.49	74.00	-14.51	53.18	6.31	Peak	150	240	3	10360.00	54.88	68.20	-13.32	38.54	16.34	Peak	278	162	4	15540.00	52.85	54.00	-1.15	35.35	17.50	Average	155	206	5	15540.00	66.78	74.00	-7.22	49.28	17.50	Peak	155	206			
Freq.	Emission level	Limit	Margin	SA reading	Factor	Remark	ANT High	Turn Table																																																																
MHz	dBuV/m	dBuV/m	dB	dBuV	dB		cm	deg																																																																
1	5150.00	46.64	54.00	-7.36	40.33	6.31	Average	150	240																																																															
2	5150.00	59.49	74.00	-14.51	53.18	6.31	Peak	150	240																																																															
3	10360.00	54.88	68.20	-13.32	38.54	16.34	Peak	278	162																																																															
4	15540.00	52.85	54.00	-1.15	35.35	17.50	Average	155	206																																																															
5	15540.00	66.78	74.00	-7.22	49.28	17.50	Peak	155	206																																																															
<p>Note 1: Emission Level (dBuV/m) = SA Reading (dBuV/m) + Factor* (dB) *Factor includes antenna factor , cable loss and amplifier gain Note 2: Margin (dB) = Emission level (dBuV/m) – Limit (dBuV/m).</p>																																																																								

Modulation	VHT20	Test Freq. (MHz)	5180
Polarization	Vertical		

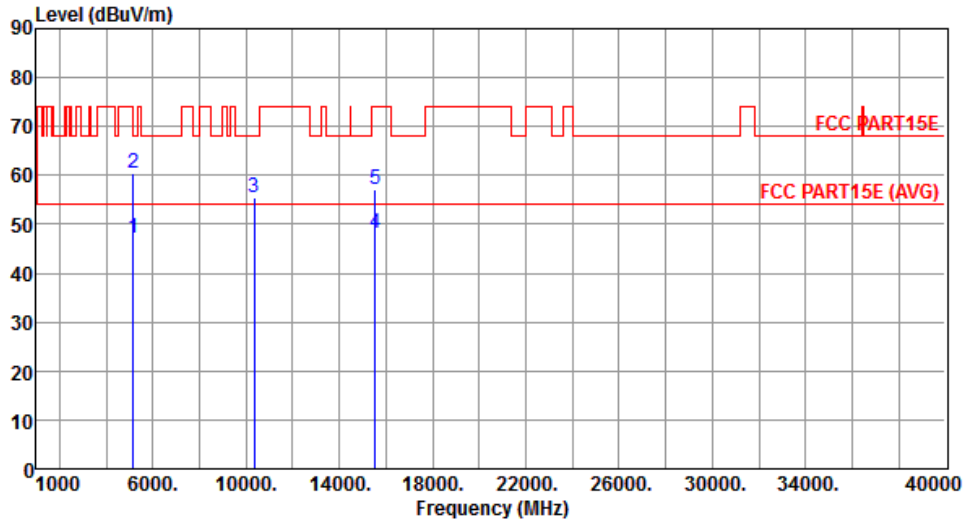

	Freq. MHz	Emission level dBuV/m	Limit dBuV/m	Margin dB	SA reading dBuV	Factor dB	Remark	ANT High cm	Turn Table deg
1	5150.00	47.12	54.00	-6.88	40.81	6.31	Average	210	92
2	5150.00	60.37	74.00	-13.63	54.06	6.31	Peak	210	92
3	10360.00	55.36	68.20	-12.84	39.02	16.34	Peak	215	339
4	15540.00	48.12	54.00	-5.88	30.62	17.50	Average	316	154
5	15540.00	57.20	74.00	-16.80	39.70	17.50	Peak	316	154

Note 1: Emission Level (dBuV/m) = SA Reading (dBuV/m) + Factor* (dB)

*Factor includes antenna factor , cable loss and amplifier gain

Note 2: Margin (dB) = Emission level (dBuV/m) – Limit (dBuV/m).

Modulation	VHT20	Test Freq. (MHz)	5200
Polarization	Horizontal		

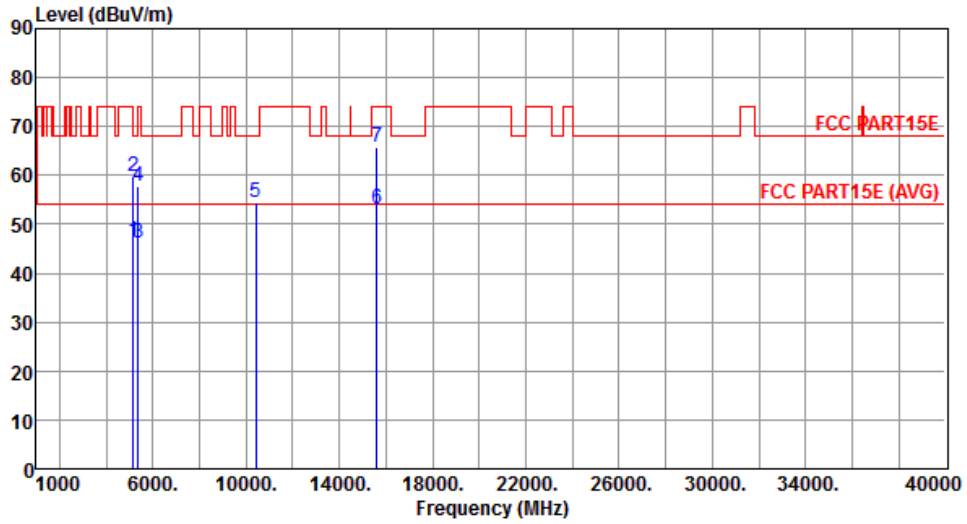

	Freq. MHz	Emission level dBuV/m	Limit dBuV/m	Margin dB	SA reading dBuV	Factor dB	Remark	ANT High cm	Turn Table deg
1	5150.00	46.45	54.00	-7.55	40.14	6.31	Average	290	168
2	5150.00	59.88	74.00	-14.12	53.57	6.31	Peak	290	168
3	5350.00	46.23	54.00	-7.77	39.61	6.62	Average	290	168
4	5350.00	57.81	74.00	-16.19	51.19	6.62	Peak	290	168
5	10400.00	54.61	68.20	-13.59	38.19	16.42	Peak	290	168
6	15600.00	52.99	54.00	-1.01	35.61	17.38	Average	165	106
7	15600.00	65.60	74.00	-8.40	48.22	17.38	Peak	165	106

Note 1: Emission Level (dBuV/m) = SA Reading (dBuV/m) + Factor* (dB)

*Factor includes antenna factor , cable loss and amplifier gain

Note 2: Margin (dB) = Emission level (dBuV/m) – Limit (dBuV/m).

Modulation	VHT20	Test Freq. (MHz)	5200
Polarization	Vertical		

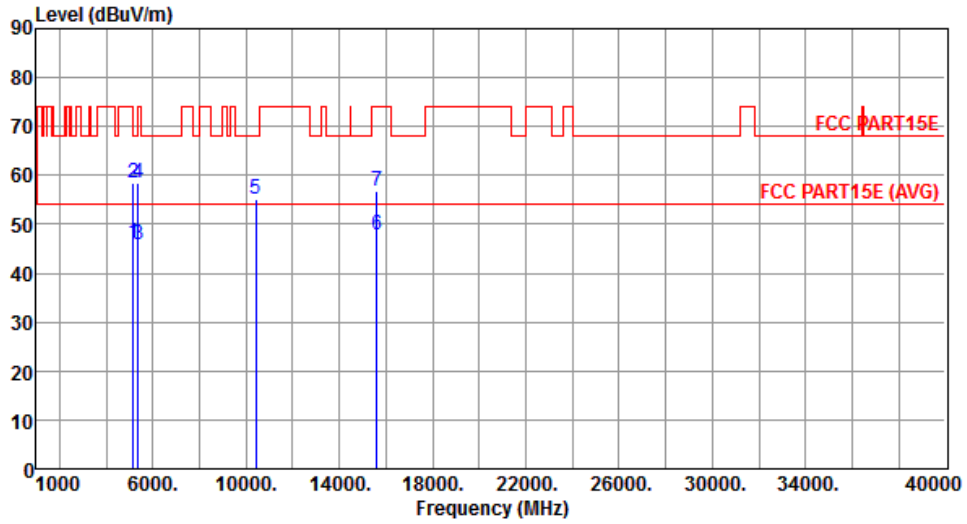

	Freq. MHz	Emission level dBuV/m	Limit dBuV/m	Margin dB	SA reading dBuV	Factor dB	Remark	ANT High cm	Turn Table deg
1	5150.00	46.27	54.00	-7.73	39.96	6.31	Average	211	96
2	5150.00	58.36	74.00	-15.64	52.05	6.31	Peak	211	96
3	5350.00	45.82	54.00	-8.18	39.20	6.62	Average	211	96
4	5350.00	58.29	74.00	-15.71	51.67	6.62	Peak	211	96
5	10400.00	55.15	68.20	-13.05	38.73	16.42	Peak	226	343
6	15600.00	47.84	54.00	-6.16	30.46	17.38	Average	306	158
7	15600.00	56.93	74.00	-17.07	39.55	17.38	Peak	306	158

Note 1: Emission Level (dBuV/m) = SA Reading (dBuV/m) + Factor* (dB)

*Factor includes antenna factor , cable loss and amplifier gain

Note 2: Margin (dB) = Emission level (dBuV/m) – Limit (dBuV/m).

Modulation	VHT20	Test Freq. (MHz)	5240
Polarization	Horizontal		

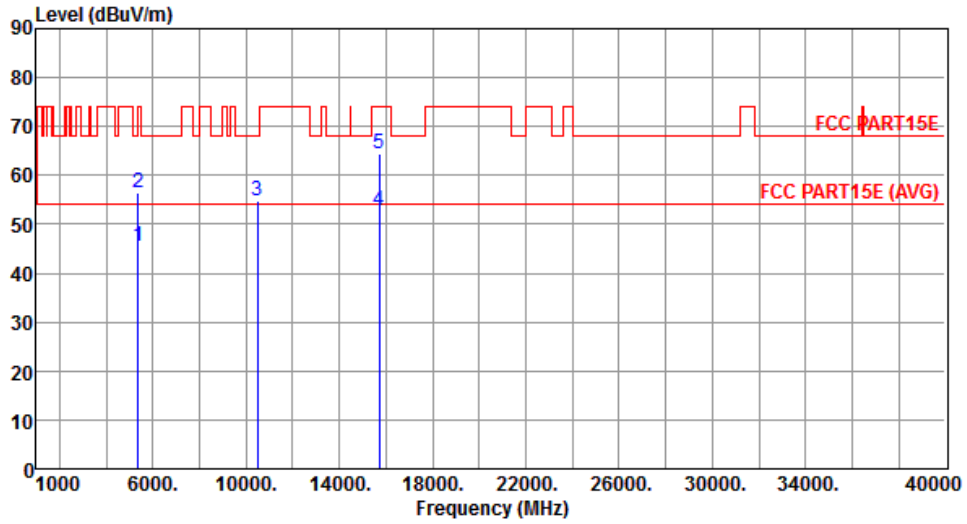

	Freq. MHz	Emission level dBuV/m	Limit dBuV/m	Margin dB	SA reading dBuV	Factor dB	Remark	ANT High cm	Turn Table deg
1	5350.00	45.51	54.00	-8.49	38.89	6.62	Average	152	312
2	5350.00	56.50	74.00	-17.50	49.88	6.62	Peak	152	312
3	10480.00	54.87	68.20	-13.33	38.31	16.56	Peak	278	162
4	15720.00	52.91	54.00	-1.09	35.76	17.15	Average	161	204
5	15720.00	64.32	74.00	-9.68	47.17	17.15	Peak	161	204

Note 1: Emission Level (dBuV/m) = SA Reading (dBuV/m) + Factor* (dB)

*Factor includes antenna factor , cable loss and amplifier gain

Note 2: Margin (dB) = Emission level (dBuV/m) – Limit (dBuV/m).

Modulation	VHT20	Test Freq. (MHz)	5240
Polarization	Vertical		

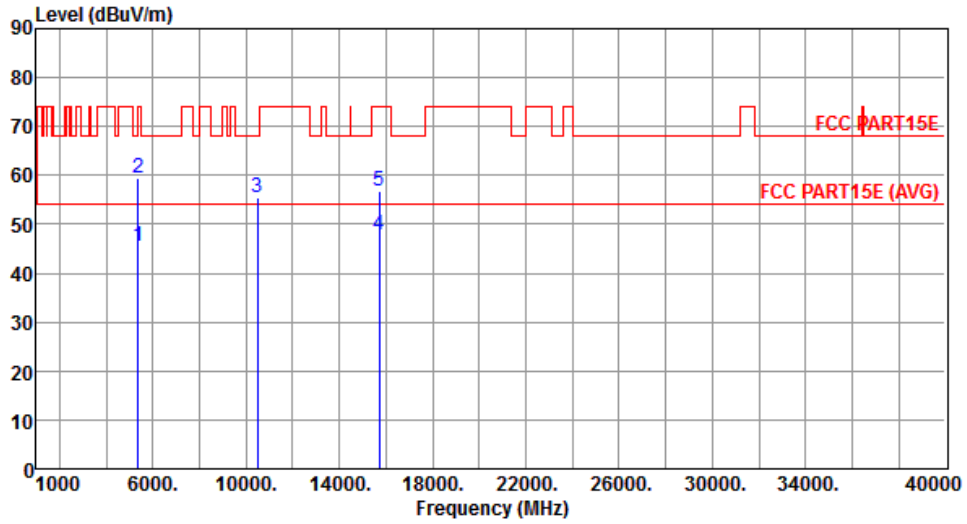

	Freq. MHz	Emission level dBuV/m	Limit dBuV/m	Margin dB	SA reading dBuV	Factor dB	Remark	ANT High cm	Turn Table deg
1	5350.00	45.50	54.00	-8.50	38.88	6.62	Average	217	69
2	5350.00	59.35	74.00	-14.65	52.73	6.62	Peak	217	69
3	10480.00	55.43	68.20	-12.77	38.87	16.56	Peak	222	336
4	15720.00	47.98	54.00	-6.02	30.83	17.15	Average	296	154
5	15720.00	56.73	74.00	-17.27	39.58	17.15	Peak	296	154

Note 1: Emission Level (dBuV/m) = SA Reading (dBuV/m) + Factor* (dB)

*Factor includes antenna factor , cable loss and amplifier gain

Note 2: Margin (dB) = Emission level (dBuV/m) – Limit (dBuV/m).

Modulation	VHT20	Test Freq. (MHz)	5260
Polarization	Horizontal		

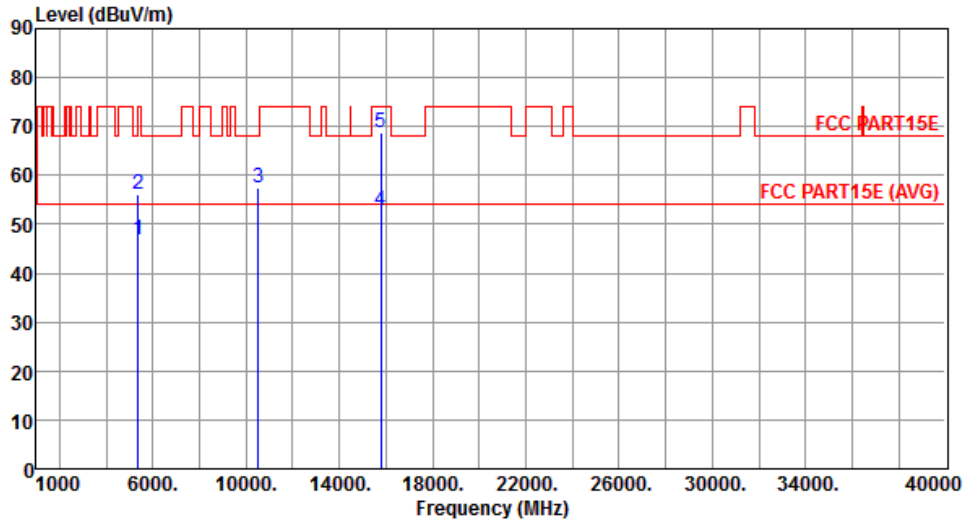

	Freq. MHz	Emission level dBuV/m	Limit dBuV/m	Margin dB	SA reading dBuV	Factor dB	Remark	ANT High cm	Turn Table deg
1	5350.00	46.86	54.00	-7.14	40.24	6.62	Average	218	314
2	5350.00	56.14	74.00	-17.86	49.52	6.62	Peak	218	314
3	10520.00	57.52	68.20	-10.68	40.92	16.60	Peak	270	92
4	15780.00	52.90	54.00	-1.10	35.85	17.05	Average	162	210
5	15780.00	68.79	74.00	-5.21	51.74	17.05	Peak	150	209

Note 1: Emission Level (dBuV/m) = SA Reading (dBuV/m) + Factor* (dB)

*Factor includes antenna factor , cable loss and amplifier gain

Note 2: Margin (dB) = Emission level (dBuV/m) – Limit (dBuV/m).

Modulation	VHT20	Test Freq. (MHz)	5260
Polarization	Vertical		

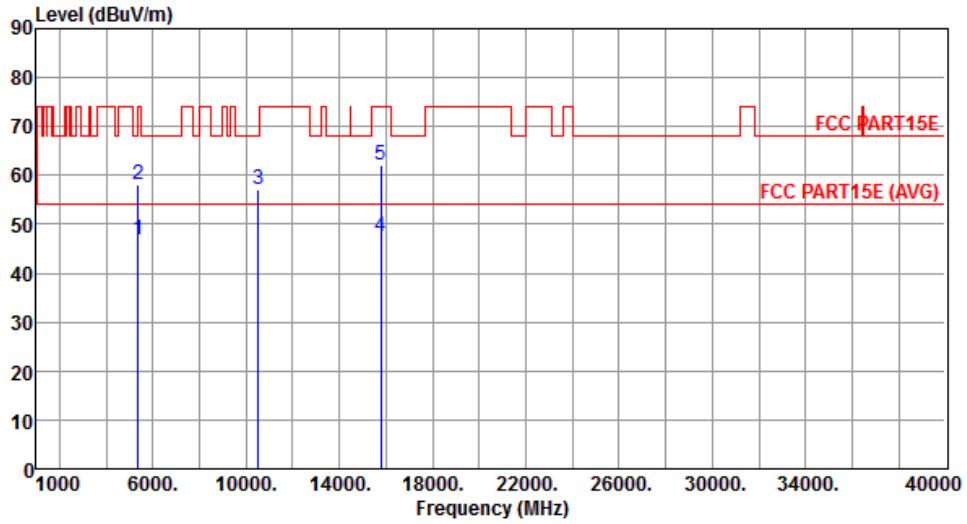

	Freq. MHz	Emission level dBuV/m	Limit dBuV/m	Margin dB	SA reading dBuV	Factor dB	Remark	ANT High cm	Turn Table deg
1	5350.00	46.94	54.00	-7.06	40.32	6.62	Average	220	119
2	5350.00	58.11	74.00	-15.89	51.49	6.62	Peak	220	119
3	10520.00	57.15	68.20	-11.05	40.55	16.60	Peak	175	267
4	15780.00	47.38	54.00	-6.62	30.33	17.05	Average	159	331
5	15780.00	62.24	74.00	-11.76	45.19	17.05	Peak	159	331

Note 1: Emission Level (dBuV/m) = SA Reading (dBuV/m) + Factor* (dB)

*Factor includes antenna factor , cable loss and amplifier gain

Note 2: Margin (dB) = Emission level (dBuV/m) – Limit (dBuV/m).

Modulation	VHT20	Test Freq. (MHz)	5300
Polarization	Horizontal		

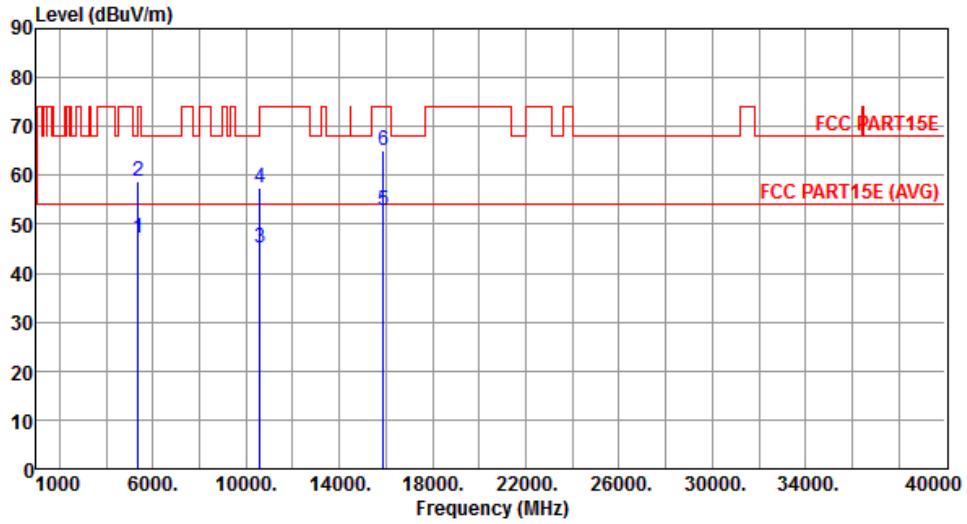

	Freq. MHz	Emission level dBuV/m	Limit dBuV/m	Margin dB	SA reading dBuV	Factor dB	Remark	ANT High cm	Turn Table deg
1	5350.00	47.25	54.00	-6.75	40.63	6.62	Average	205	227
2	5350.00	58.88	74.00	-15.12	52.26	6.62	Peak	205	227
3	10600.00	45.32	54.00	-8.68	28.70	16.62	Average	218	192
4	10600.00	57.29	74.00	-16.71	40.67	16.62	Peak	218	192
5	15900.00	52.83	54.00	-1.17	36.01	16.82	Average	165	209
6	15900.00	65.21	74.00	-8.79	48.39	16.82	Peak	165	209

Note 1: Emission Level (dBuV/m) = SA Reading (dBuV/m) + Factor* (dB)

*Factor includes antenna factor , cable loss and amplifier gain

Note 2: Margin (dB) = Emission level (dBuV/m) – Limit (dBuV/m).

Modulation	VHT20	Test Freq. (MHz)	5300
Polarization	Vertical		

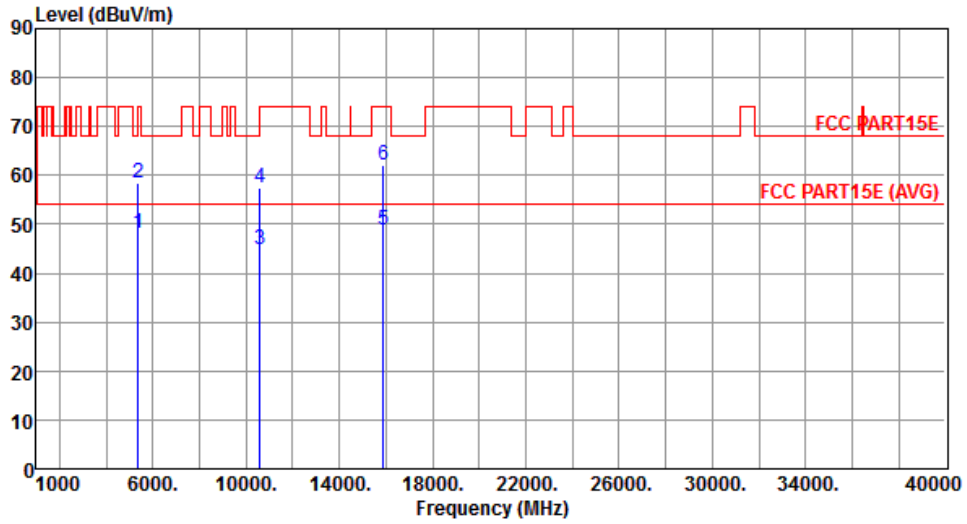

	Freq. MHz	Emission level dBuV/m	Limit dBuV/m	Margin dB	SA reading dBuV	Factor dB	Remark	ANT High cm	Turn Table deg
1	5350.00	48.24	54.00	-5.76	41.62	6.62	Average	182	127
2	5350.00	58.54	74.00	-15.46	51.92	6.62	Peak	182	127
3	10600.00	44.86	54.00	-9.14	28.24	16.62	Average	270	5
4	10600.00	57.56	74.00	-16.44	40.94	16.62	Peak	270	5
5	15900.00	48.71	54.00	-5.29	31.89	16.82	Average	161	182
6	15900.00	62.24	74.00	-11.76	45.42	16.82	Peak	161	182

Note 1: Emission Level (dBuV/m) = SA Reading (dBuV/m) + Factor* (dB)

*Factor includes antenna factor , cable loss and amplifier gain

Note 2: Margin (dB) = Emission level (dBuV/m) – Limit (dBuV/m).

Modulation	VHT20	Test Freq. (MHz)	5320
Polarization	Horizontal		

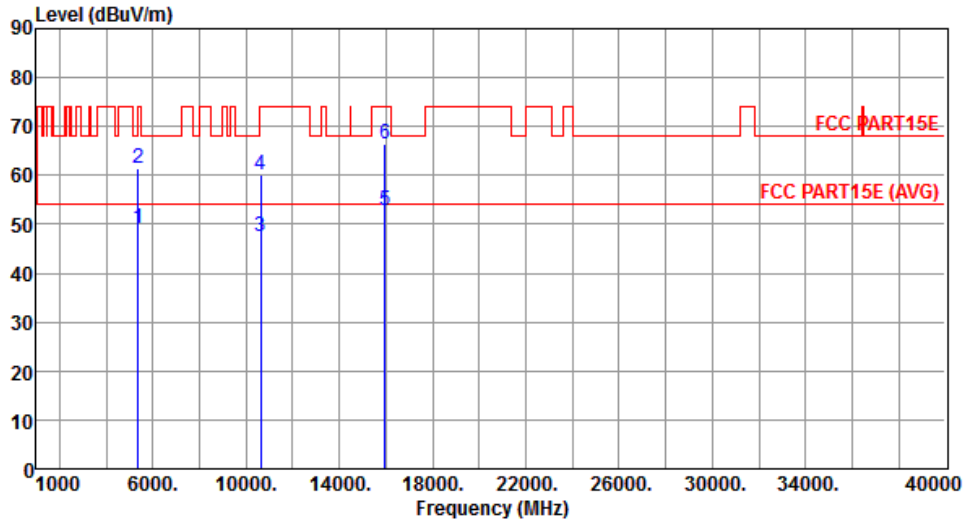

	Freq. MHz	Emission level dBuV/m	Limit dBuV/m	Margin dB	SA reading dBuV	Factor dB	Remark	ANT High cm	Turn Table deg
1	5350.00	49.05	54.00	-4.95	42.43	6.62	Average	202	290
2	5350.00	61.50	74.00	-12.50	54.88	6.62	Peak	202	290
3	10640.00	47.55	54.00	-6.45	30.92	16.63	Average	162	212
4	10640.00	59.96	74.00	-14.04	43.33	16.63	Peak	162	212
5	15960.00	52.90	54.00	-1.10	36.20	16.70	Average	165	208
6	15960.00	66.58	74.00	-7.42	49.88	16.70	Peak	165	208

Note 1: Emission Level (dBuV/m) = SA Reading (dBuV/m) + Factor* (dB)

*Factor includes antenna factor , cable loss and amplifier gain

Note 2: Margin (dB) = Emission level (dBuV/m) – Limit (dBuV/m).

Modulation	VHT20	Test Freq. (MHz)	5320
Polarization	Vertical		

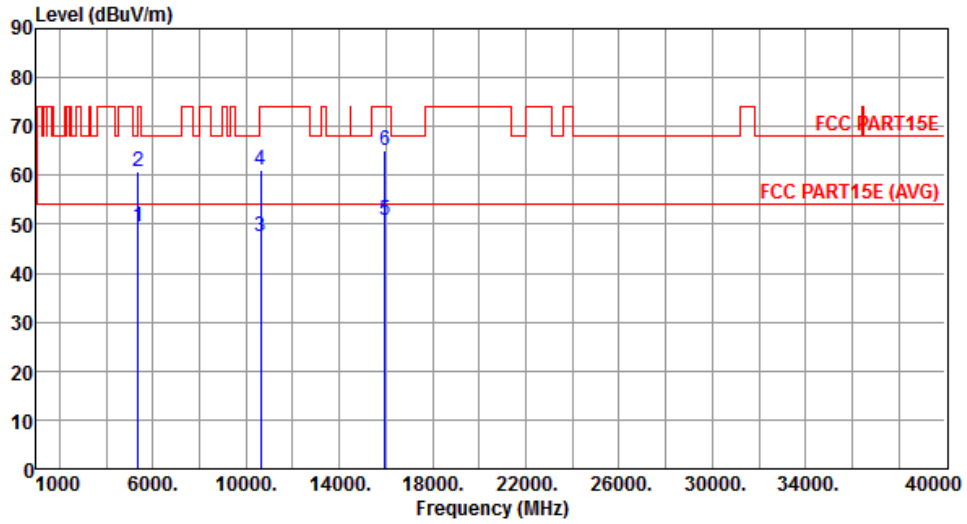

	Freq. MHz	Emission level dBuV/m	Limit dBuV/m	Margin dB	SA reading dBuV	Factor dB	Remark	ANT High cm	Turn Table deg
1	5350.00	49.59	54.00	-4.41	42.97	6.62	Average	218	143
2	5350.00	60.89	74.00	-13.11	54.27	6.62	Peak	218	143
3	10640.00	47.33	54.00	-6.67	30.70	16.63	Average	185	315
4	10640.00	61.06	74.00	-12.94	44.43	16.63	Peak	185	315
5	15960.00	50.73	54.00	-3.27	34.03	16.70	Average	153	81
6	15960.00	64.97	74.00	-9.03	48.27	16.70	Peak	153	81

Note 1: Emission Level (dBuV/m) = SA Reading (dBuV/m) + Factor* (dB)

*Factor includes antenna factor , cable loss and amplifier gain

Note 2: Margin (dB) = Emission level (dBuV/m) – Limit (dBuV/m).

Modulation	VHT20	Test Freq. (MHz)	5500
Polarization	Horizontal		

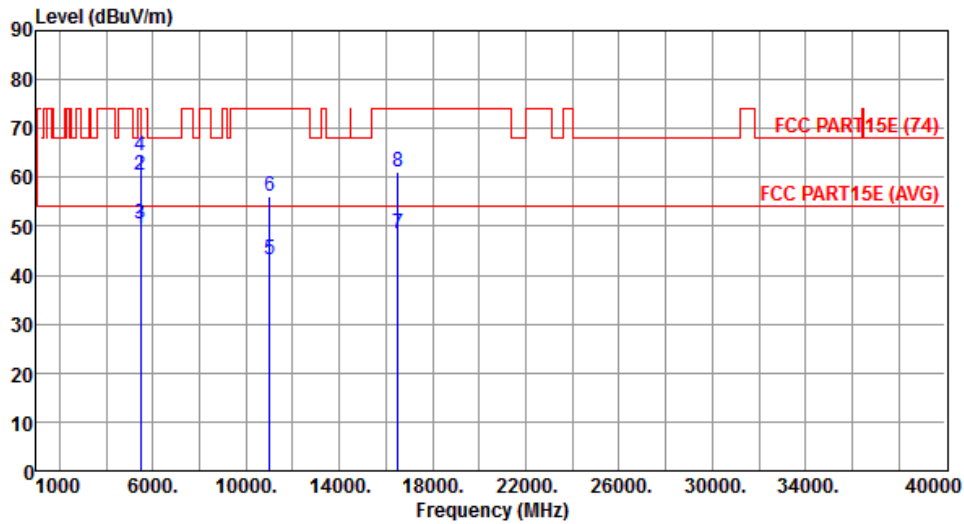

	Freq. MHz	Emission level dBuV/m	Limit dBuV/m	Margin dB	SA reading dBuV	Factor dB	Remark	ANT High cm	Turn Table deg
1	5460.00	49.62	54.00	-4.38	42.86	6.76	Average	191	306
2	5460.00	60.36	74.00	-13.64	53.60	6.76	Peak	191	306
3	5470.00	50.52	54.00	-3.48	43.75	6.77	Average	191	306
4	5470.00	64.59	74.00	-9.41	57.82	6.77	Peak	191	306
5	11000.00	43.21	54.00	-10.79	26.49	16.72	Average	150	194
6	11000.00	56.12	74.00	-17.88	39.40	16.72	Peak	150	194
7	16500.00	48.57	54.00	-5.43	30.70	17.87	Average	150	194
8	16500.00	60.95	74.00	-13.05	43.08	17.87	Peak	150	194

Note 1: Emission Level (dBuV/m) = SA Reading (dBuV/m) + Factor* (dB)

*Factor includes antenna factor , cable loss and amplifier gain

Note 2: Margin (dB) = Emission level (dBuV/m) – Limit (dBuV/m).

Modulation	VHT20	Test Freq. (MHz)	5500
Polarization	Vertical		

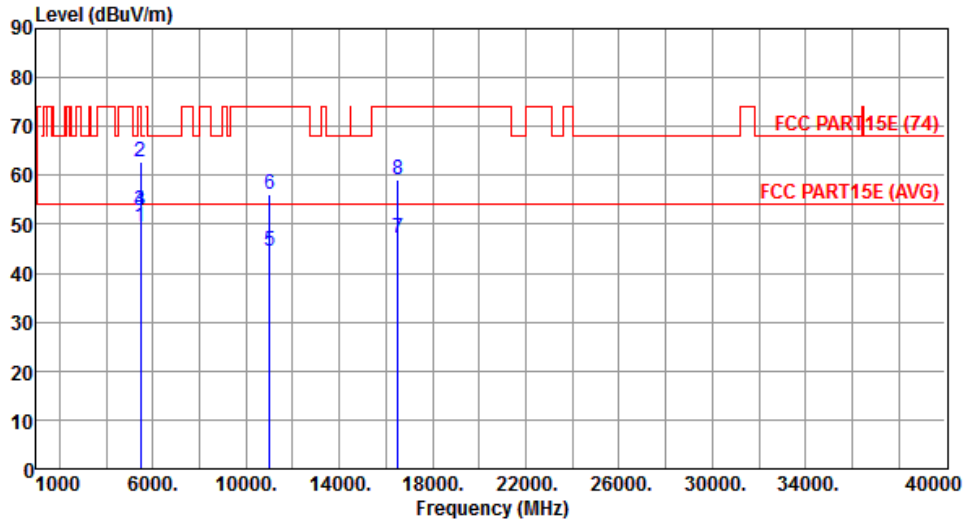

	Freq. MHz	Emission level dBuV/m	Limit dBuV/m	Margin dB	SA reading dBuV	Factor dB	Remark	ANT High cm	Turn Table deg
1	5460.00	49.36	54.00	-4.64	42.60	6.76	Average	173	129
2	5460.00	62.65	74.00	-11.35	55.89	6.76	Peak	173	129
3	5470.00	52.67	54.00	-1.33	45.90	6.77	Average	173	129
4	5470.00	52.67	74.00	-21.33	45.90	6.77	Peak	173	129
5	11000.00	44.62	54.00	-9.38	27.90	16.72	Average	150	272
6	11000.00	55.98	74.00	-18.02	39.26	16.72	Peak	150	272
7	16500.00	47.13	54.00	-6.87	29.26	17.87	Average	174	267
8	16500.00	59.14	74.00	-14.86	41.27	17.87	Peak	174	267

Note 1: Emission Level (dBuV/m) = SA Reading (dBuV/m) + Factor* (dB)

*Factor includes antenna factor , cable loss and amplifier gain

Note 2: Margin (dB) = Emission level (dBuV/m) – Limit (dBuV/m).

Modulation	VHT20	Test Freq. (MHz)	5580
Polarization	Horizontal		

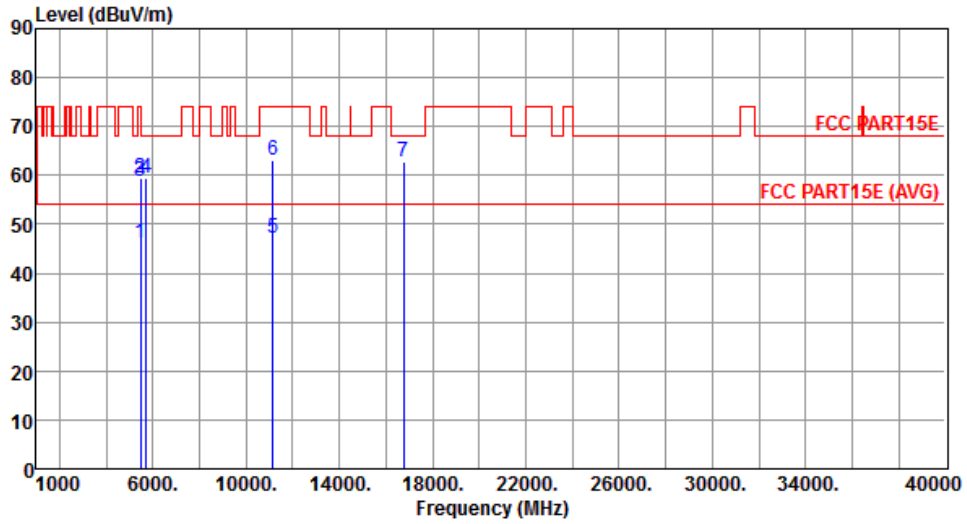

	Freq. MHz	Emission level dBuV/m	Limit dBuV/m	Margin dB	SA reading dBuV	Factor dB	Remark	ANT High cm	Turn Table deg
1	5460.00	46.11	54.00	-7.89	39.35	6.76	Average	199	300
2	5460.00	59.28	74.00	-14.72	52.52	6.76	Peak	199	300
3	5470.00	58.78	68.20	-9.42	52.01	6.77	Peak	199	300
4	5725.00	59.51	68.20	-8.69	52.27	7.24	Peak	199	300
5	11160.00	47.18	54.00	-6.82	30.39	16.79	Average	160	168
6	11160.00	63.04	74.00	-10.96	46.25	16.79	Peak	160	168
7	16740.00	62.77	68.20	-5.43	44.37	18.40	Peak	168	194

Note 1: Emission Level (dBuV/m) = SA Reading (dBuV/m) + Factor* (dB)

*Factor includes antenna factor , cable loss and amplifier gain

Note 2: Margin (dB) = Emission level (dBuV/m) – Limit (dBuV/m).

Modulation	VHT20	Test Freq. (MHz)	5580
Polarization	Vertical		

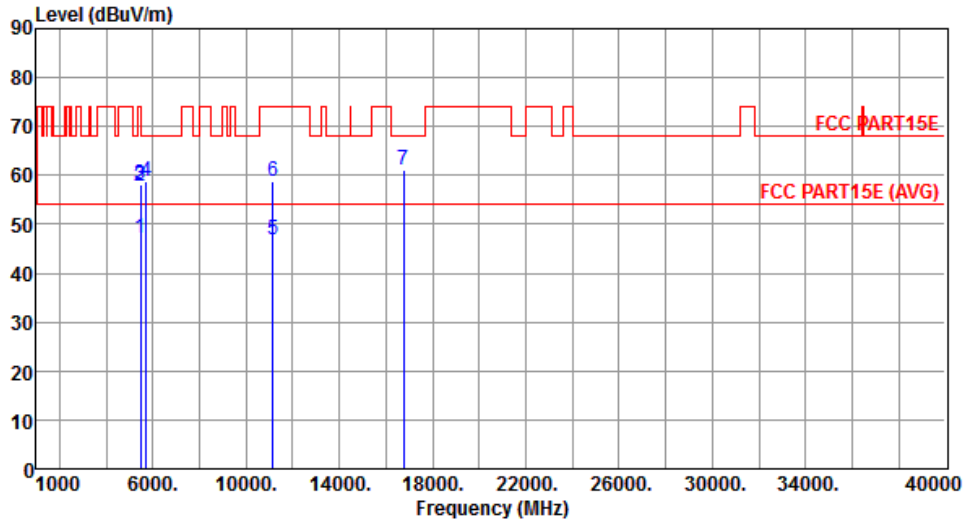

	Freq. MHz	Emission level dBuV/m	Limit dBuV/m	Margin dB	SA reading dBuV	Factor dB	Remark	ANT High cm	Turn Table deg
1	5460.00	47.05	54.00	-6.95	40.29	6.76	Average	310	104
2	5460.00	57.81	74.00	-16.19	51.05	6.76	Peak	310	104
3	5470.00	58.02	68.20	-10.18	51.25	6.77	Peak	310	104
4	5725.00	58.80	68.20	-9.40	51.56	7.24	Peak	310	104
5	11160.00	46.88	54.00	-7.12	30.09	16.79	Average	310	19
6	11160.00	58.94	74.00	-15.06	42.15	16.79	Peak	310	19
7	16740.00	61.00	68.20	-7.20	42.60	18.40	Peak	251	226

Note 1: Emission Level (dBuV/m) = SA Reading (dBuV/m) + Factor* (dB)

*Factor includes antenna factor , cable loss and amplifier gain

Note 2: Margin (dB) = Emission level (dBuV/m) – Limit (dBuV/m).

Modulation	VHT20	Test Freq. (MHz)	5700
Polarization	Horizontal		

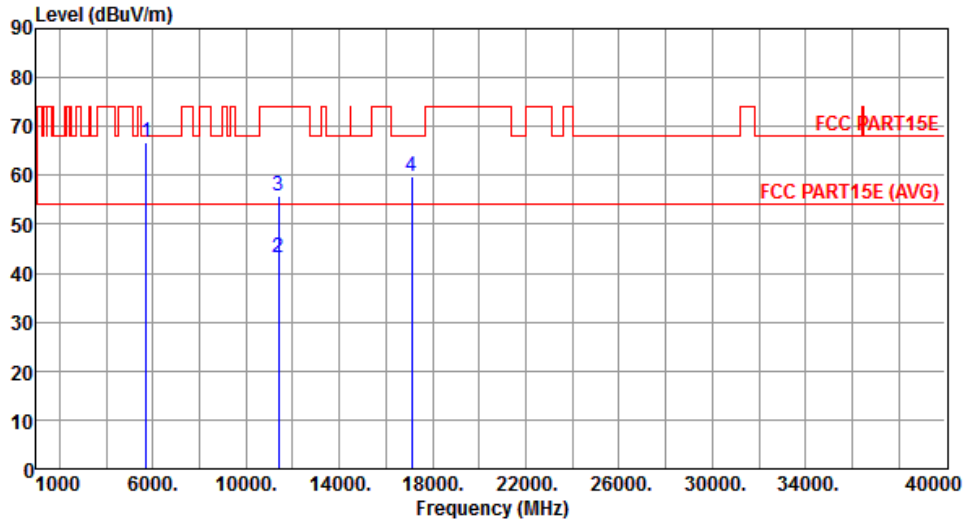

	Freq. MHz	Emission level dBuV/m	Limit dBuV/m	Margin dB	SA reading dBuV	Factor dB	Remark	ANT High cm	Turn Table deg
1	5725.00	66.76	68.20	-1.44	59.52	7.24	Peak	208	295
2	11400.00	43.01	54.00	-10.99	26.13	16.88	Average	247	2
3	11400.00	55.94	74.00	-18.06	39.06	16.88	Peak	247	2
4	17100.00	59.91	68.20	-8.29	40.79	19.12	Peak	210	209

Note 1: Emission Level (dBuV/m) = SA Reading (dBuV/m) + Factor* (dB)

*Factor includes antenna factor , cable loss and amplifier gain

Note 2: Margin (dB) = Emission level (dBuV/m) – Limit (dBuV/m).

Modulation	VHT20	Test Freq. (MHz)	5700
Polarization	Vertical		

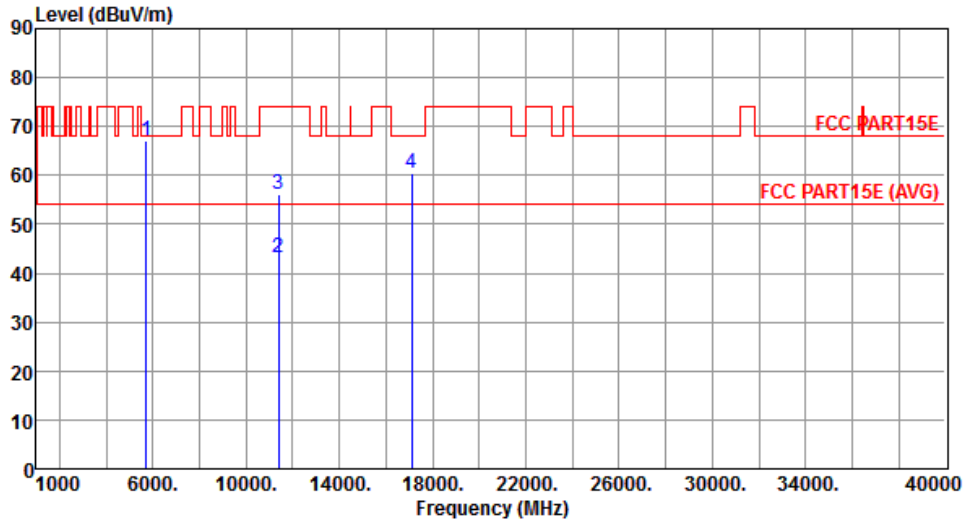

	Freq. MHz	Emission level dBuV/m	Limit dBuV/m	Margin dB	SA reading dBuV	Factor dB	Remark	ANT High cm	Turn Table deg
1	5725.00	67.12	68.20	-1.08	59.88	7.24	Peak	205	126
2	11400.00	43.03	54.00	-10.97	26.15	16.88	Average	305	267
3	11400.00	56.22	74.00	-17.78	39.34	16.88	Peak	305	267
4	17100.00	60.38	68.20	-7.82	41.26	19.12	Peak	195	269

Note 1: Emission Level (dBuV/m) = SA Reading (dBuV/m) + Factor* (dB)

*Factor includes antenna factor , cable loss and amplifier gain

Note 2: Margin (dB) = Emission level (dBuV/m) – Limit (dBuV/m).

Modulation	VHT20	Test Freq. (MHz)	5720
Polarization	Horizontal		

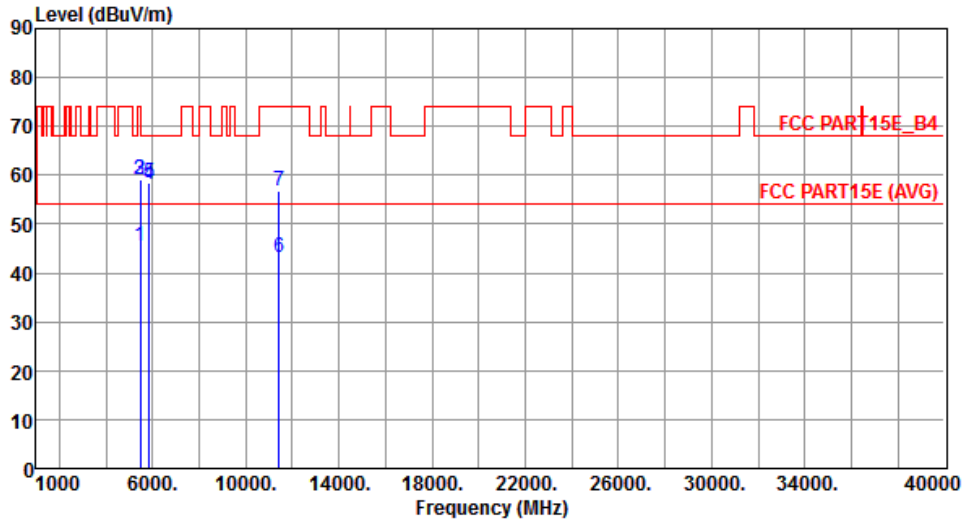

	Freq. MHz	Emission level dBuV/m	Limit dBuV/m	Margin dB	SA reading dBuV	Factor dB	Remark	ANT High cm	Turn Table deg
1	5460.00	45.46	54.00	-8.54	38.70	6.76	Average	200	310
2	5460.00	59.16	74.00	-14.84	52.40	6.76	Peak	200	310
3	5470.00	59.19	68.20	-9.01	52.42	6.77	Peak	200	310
4	5850.00	58.28	78.20	-19.92	50.78	7.50	Peak	200	310
5	5860.00	58.50	68.20	-9.70	50.99	7.51	Peak	200	310
6	11440.00	43.21	54.00	-10.79	26.31	16.90	Average	166	222
7	11440.00	56.82	74.00	-17.18	39.92	16.90	Peak	166	222

Note 1: Emission Level (dBuV/m) = SA Reading (dBuV/m) + Factor* (dB)

*Factor includes antenna factor , cable loss and amplifier gain

Note 2: Margin (dB) = Emission level (dBuV/m) – Limit (dBuV/m).

Modulation	VHT20	Test Freq. (MHz)	5720
Polarization	Vertical		

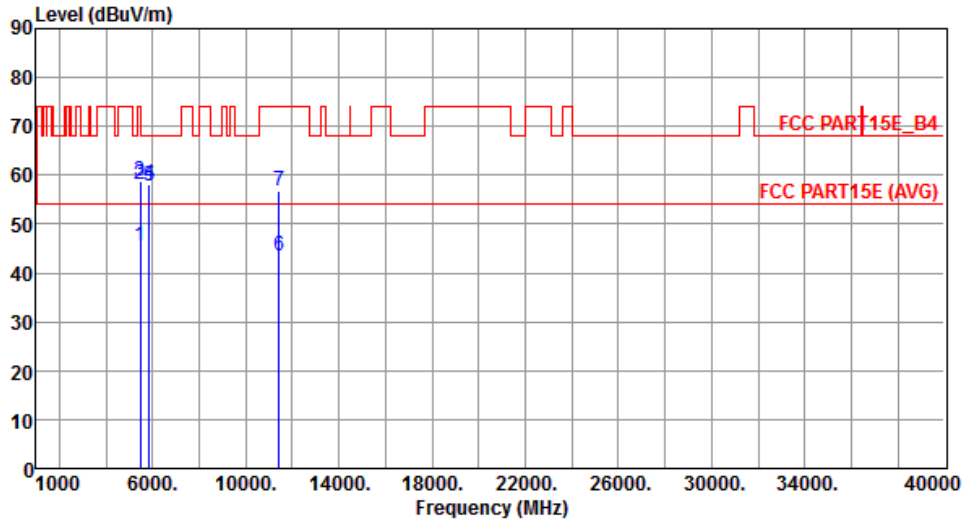

	Freq. MHz	Emission level dBuV/m	Limit dBuV/m	Margin dB	SA reading dBuV	Factor dB	Remark	ANT High cm	Turn Table deg
1	5460.00	45.40	54.00	-8.60	38.64	6.76	Average	202	76
2	5460.00	58.24	74.00	-15.76	51.48	6.76	Peak	202	76
3	5470.00	58.64	68.20	-9.56	51.87	6.77	Peak	202	76
4	5850.00	57.99	78.20	-20.21	50.49	7.50	Peak	202	76
5	5860.00	57.72	68.20	-10.48	50.21	7.51	Peak	202	76
6	11440.00	43.63	54.00	-10.37	26.73	16.90	Average	156	123
7	11440.00	56.78	74.00	-17.22	39.88	16.90	Peak	156	123

Note 1: Emission Level (dBuV/m) = SA Reading (dBuV/m) + Factor* (dB)

*Factor includes antenna factor , cable loss and amplifier gain

Note 2: Margin (dB) = Emission level (dBuV/m) – Limit (dBuV/m).

Modulation	VHT20	Test Freq. (MHz)	5745
Polarization	Horizontal		

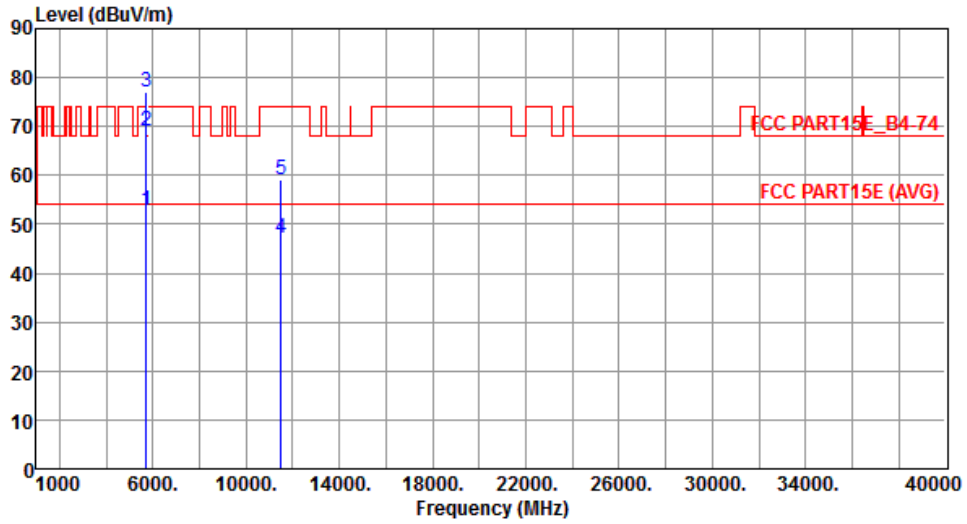

	Freq. MHz	Emission level dBuV/m	Limit dBuV/m	Margin dB	SA reading dBuV	Factor dB	Remark	ANT High cm	Turn Table deg
1	5715.00	52.89	54.00	-1.11	47.24	5.65	Average	293	120
2	5715.00	69.04	74.00	-4.96	63.39	5.65	Peak	293	120
3	5725.00	77.19	78.20	-1.01	71.55	5.64	Peak	293	120
4	11490.00	47.24	54.00	-6.76	31.31	15.93	Average	233	351
5	11490.00	59.24	74.00	-14.76	43.31	15.93	Peak	233	351

Note 1: Emission Level (dBuV/m) = SA Reading (dBuV/m) + Factor* (dB)

*Factor includes antenna factor , cable loss and amplifier gain

Note 2: Margin (dB) = Emission level (dBuV/m) – Limit (dBuV/m).

Modulation	VHT20	Test Freq. (MHz)	5745
Polarization	Vertical		

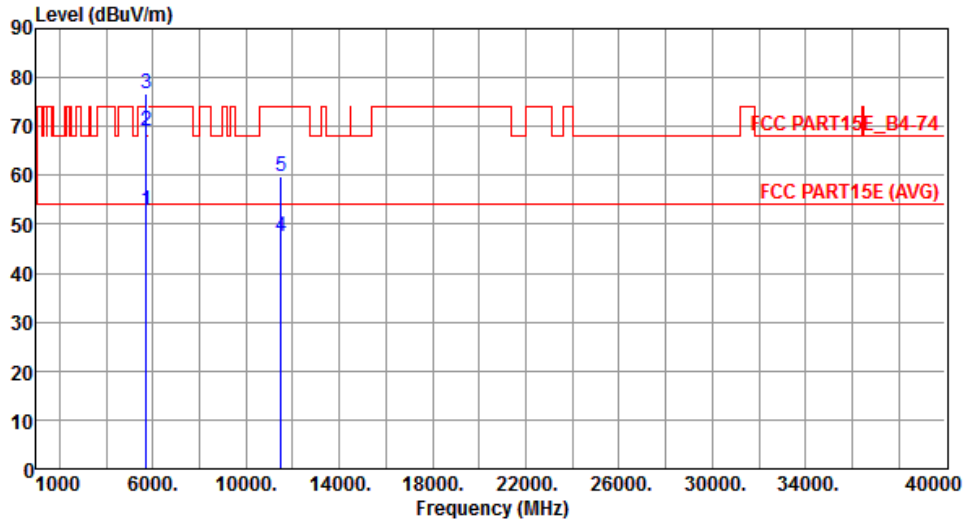

	Freq. MHz	Emission level dBuV/m	Limit dBuV/m	Margin dB	SA reading dBuV	Factor dB	Remark	ANT High cm	Turn Table deg
1	5715.00	52.86	54.00	-1.14	47.21	5.65	Average	107	244
2	5715.00	69.15	74.00	-4.85	63.50	5.65	Peak	107	244
3	5725.00	76.82	78.20	-1.38	71.18	5.64	Peak	107	244
4	11490.00	47.39	54.00	-6.61	31.46	15.93	Average	332	175
5	11490.00	59.89	74.00	-14.11	43.96	15.93	Peak	332	175

Note 1: Emission Level (dBuV/m) = SA Reading (dBuV/m) + Factor* (dB)

*Factor includes antenna factor , cable loss and amplifier gain

Note 2: Margin (dB) = Emission level (dBuV/m) – Limit (dBuV/m).

Modulation	VHT20	Test Freq. (MHz)	5785
Polarization	Horizontal		

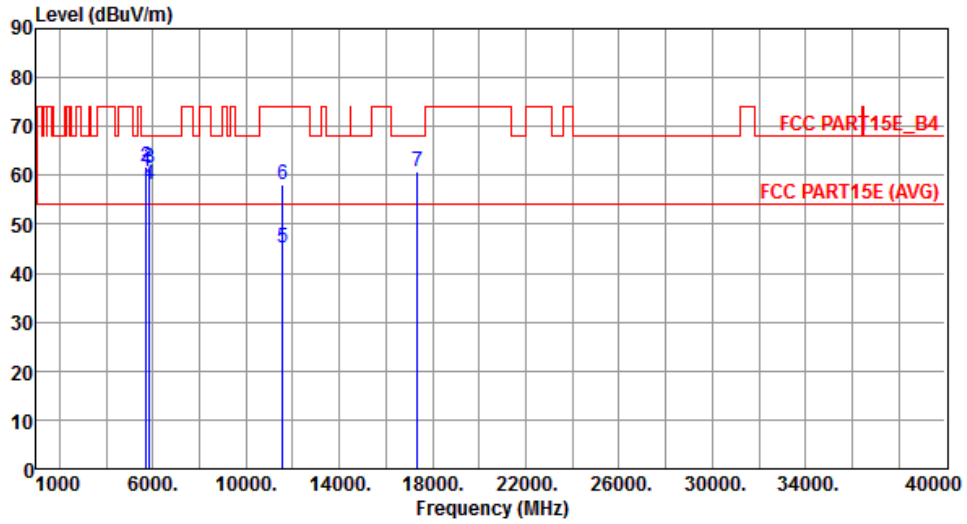

	Freq. MHz	Emission level dBuV/m	Limit dBuV/m	Margin dB	SA reading dBuV	Factor dB	Remark	ANT High cm	Turn Table deg
1	5715.00	60.66	68.20	-7.54	55.01	5.65	Peak	239	119
2	5725.00	61.69	78.20	-16.51	56.05	5.64	Peak	239	119
3	5850.00	61.51	78.20	-16.69	55.76	5.75	Peak	239	119
4	5860.00	58.15	68.20	-10.05	52.39	5.76	Peak	239	119
5	11570.00	45.18	54.00	-8.82	29.41	15.77	Average	300	316
6	11570.00	58.27	74.00	-15.73	42.50	15.77	Peak	300	316
7	17355.00	60.92	68.20	-7.28	41.19	19.73	Peak	100	123

Note 1: Emission Level (dBuV/m) = SA Reading (dBuV/m) + Factor* (dB)

*Factor includes antenna factor , cable loss and amplifier gain

Note 2: Margin (dB) = Emission level (dBuV/m) – Limit (dBuV/m).

Modulation	VHT20	Test Freq. (MHz)	5785
Polarization	Vertical		

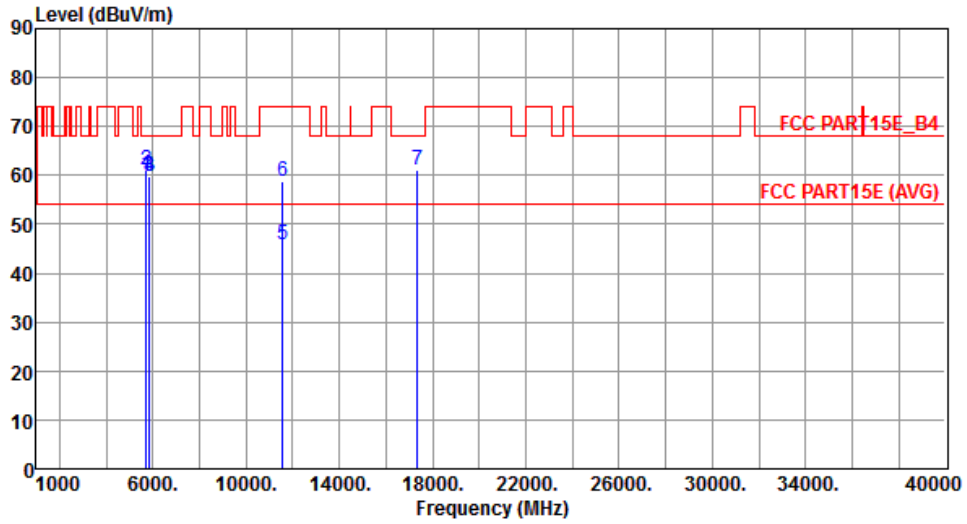

	Freq. MHz	Emission level dBuV/m	Limit dBuV/m	Margin dB	SA reading dBuV	Factor dB	Remark	ANT High cm	Turn Table deg
1	5715.00	60.03	68.20	-8.17	54.38	5.65	Peak	100	252
2	5725.00	60.94	78.20	-17.26	55.30	5.64	Peak	100	252
3	5850.00	59.74	78.20	-18.46	53.99	5.75	Peak	100	252
4	5860.00	59.69	68.20	-8.51	53.93	5.76	Peak	100	252
5	11570.00	45.97	54.00	-8.03	30.20	15.77	Average	178	20
6	11570.00	58.89	74.00	-15.11	43.12	15.77	Peak	178	20
7	17355.00	61.13	68.20	-7.07	41.40	19.73	Peak	100	166

Note 1: Emission Level (dBuV/m) = SA Reading (dBuV/m) + Factor* (dB)

*Factor includes antenna factor , cable loss and amplifier gain

Note 2: Margin (dB) = Emission level (dBuV/m) – Limit (dBuV/m).

Modulation	VHT20	Test Freq. (MHz)	5825
Polarization	Horizontal		

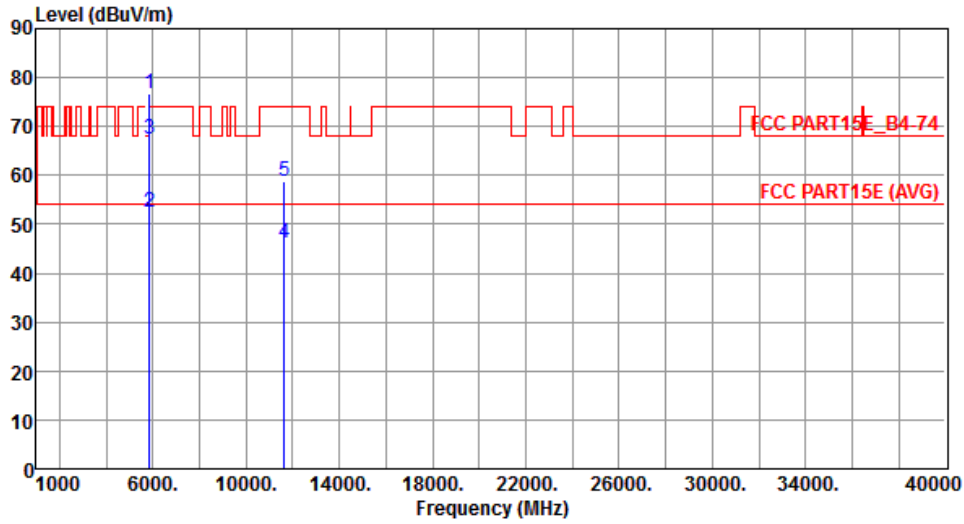

	Freq. MHz	Emission level dBuV/m	Limit dBuV/m	Margin dB	SA reading dBuV	Factor dB	Remark	ANT High cm	Turn Table deg
1	5850.00	76.60	78.20	-1.60	70.85	5.75	Peak	240	119
2	5860.00	52.58	54.00	-1.42	46.82	5.76	Average	240	119
3	5860.00	67.32	74.00	-6.68	61.56	5.76	Peak	240	119
4	11650.00	46.10	54.00	-7.90	30.54	15.56	Average	115	213
5	11650.00	58.92	74.00	-15.08	43.36	15.56	Peak	115	213

Note 1: Emission Level (dBuV/m) = SA Reading (dBuV/m) + Factor* (dB)

*Factor includes antenna factor , cable loss and amplifier gain

Note 2: Margin (dB) = Emission level (dBuV/m) – Limit (dBuV/m).

Modulation	VHT20	Test Freq. (MHz)	5825
Polarization	Vertical		

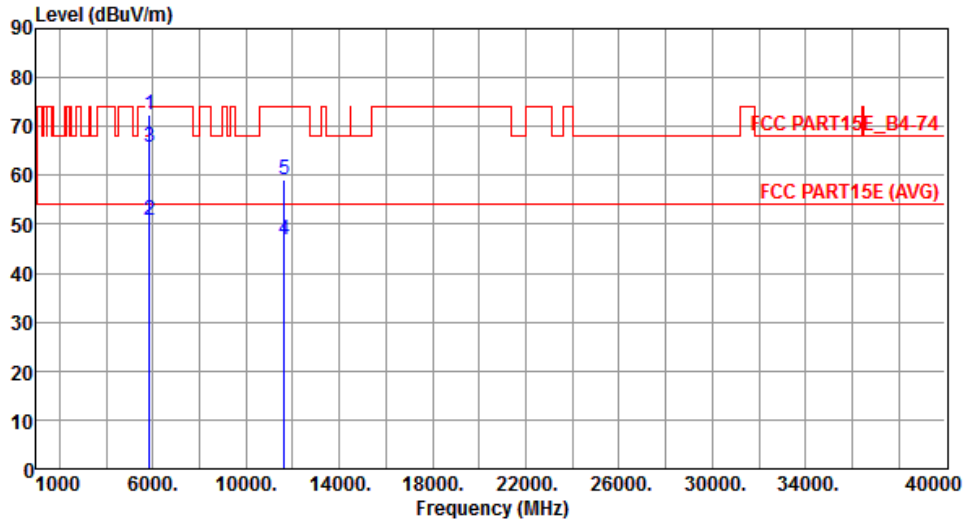

	Freq. MHz	Emission level dBuV/m	Limit dBuV/m	Margin dB	SA reading dBuV	Factor dB	Remark	ANT High cm	Turn Table deg
1	5850.00	72.31	78.20	-5.89	66.56	5.75	Peak	105	249
2	5860.00	50.75	54.00	-3.25	44.99	5.76	Average	105	249
3	5860.00	65.79	74.00	-8.21	60.03	5.76	Peak	105	249
4	11650.00	46.80	54.00	-7.20	31.24	15.56	Average	132	288
5	11650.00	59.15	74.00	-14.85	43.59	15.56	Peak	132	288

Note 1: Emission Level (dBuV/m) = SA Reading (dBuV/m) + Factor* (dB)

*Factor includes antenna factor , cable loss and amplifier gain

Note 2: Margin (dB) = Emission level (dBuV/m) – Limit (dBuV/m).

3.5.8 Transmitter Radiated Unwanted Emissions (Above 1GHz) for VHT40

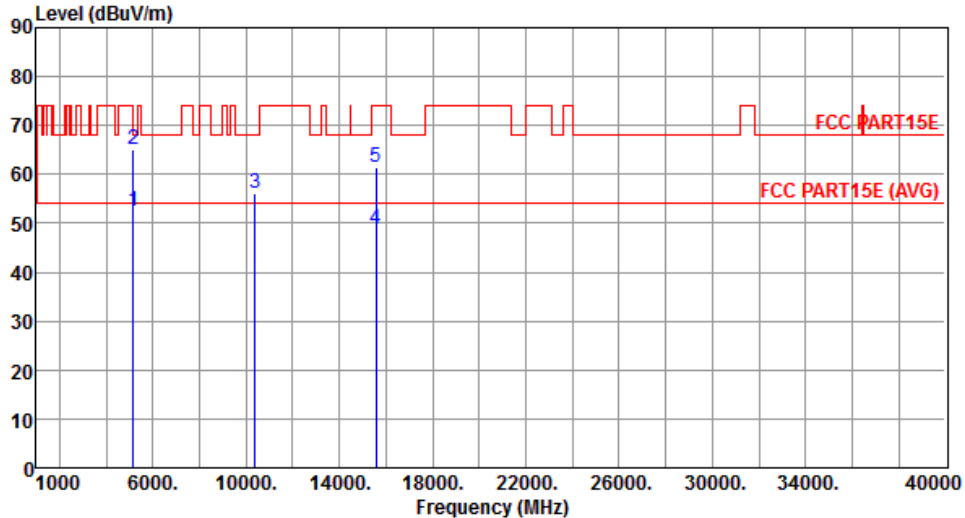
Modulation	VHT40	Test Freq. (MHz)	5190						
Polarization	Horizontal								
									
	Freq.	Emission level	Limit	Margin	SA reading	Factor	Remark	ANT High	Turn Table
	MHz	dBuV/m	dBuV/m	dB	dBuV	dB		cm	deg
1	5150.00	52.42	54.00	-1.58	46.11	6.31	Average	223	312
2	5150.00	65.04	74.00	-8.96	58.73	6.31	Peak	223	312
3	10380.00	56.08	68.20	-12.12	39.71	16.37	Peak	261	250
4	15570.00	48.98	54.00	-5.02	31.55	17.43	Average	170	206
5	15570.00	61.39	74.00	-12.61	43.96	17.43	Peak	170	206
<p>Note 1: Emission Level (dBuV/m) = SA Reading (dBuV/m) + Factor* (dB) *Factor includes antenna factor , cable loss and amplifier gain Note 2: Margin (dB) = Emission level (dBuV/m) – Limit (dBuV/m).</p>									

Modulation	VHT40	Test Freq. (MHz)	5190
Polarization	Vertical		

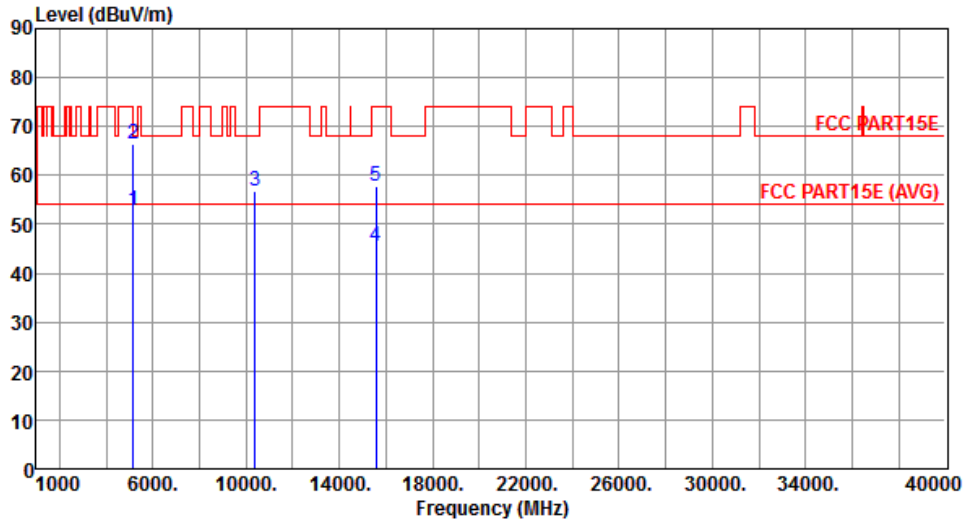

	Freq. MHz	Emission level dBuV/m	Limit dBuV/m	Margin dB	SA reading dBuV	Factor dB	Remark	ANT High cm	Turn Table deg
1	5150.00	52.82	54.00	-1.18	46.51	6.31	Average	183	126
2	5150.00	66.27	74.00	-7.73	59.96	6.31	Peak	183	126
3	10380.00	56.67	68.20	-11.53	40.30	16.37	Peak	309	277
4	15570.00	45.55	54.00	-8.45	28.12	17.43	Average	167	283
5	15570.00	57.79	74.00	-16.21	40.36	17.43	Peak	167	283

Note 1: Emission Level (dBuV/m) = SA Reading (dBuV/m) + Factor* (dB)

*Factor includes antenna factor , cable loss and amplifier gain

Note 2: Margin (dB) = Emission level (dBuV/m) – Limit (dBuV/m).

Modulation	VHT40	Test Freq. (MHz)	5230
Polarization	Horizontal		

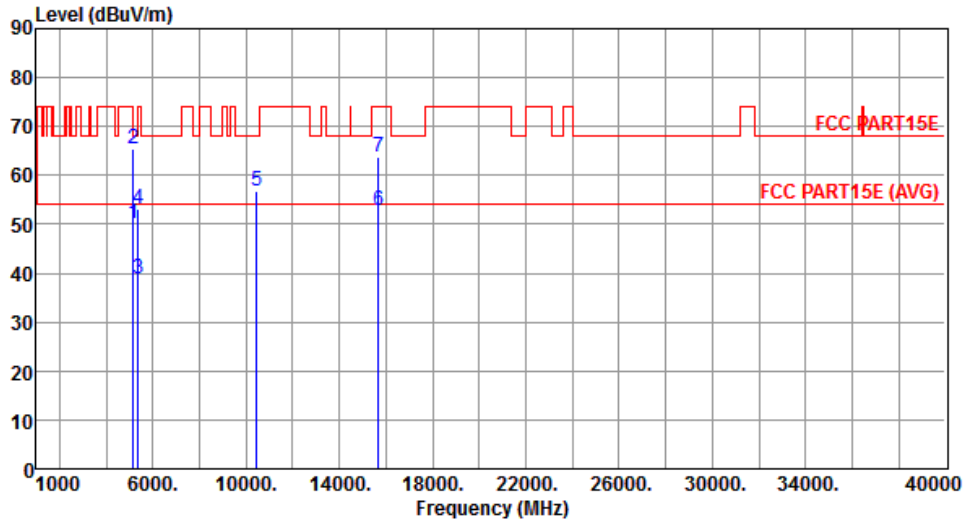

	Freq. MHz	Emission level dBuV/m	Limit dBuV/m	Margin dB	SA reading dBuV	Factor dB	Remark	ANT High cm	Turn Table deg
1	5150.00	50.21	54.00	-3.79	43.90	6.31	Average	220	305
2	5150.00	65.50	74.00	-8.50	59.19	6.31	Peak	220	305
3	5350.00	38.82	54.00	-15.18	32.20	6.62	Average	162	204
4	5350.00	53.11	74.00	-20.89	46.49	6.62	Peak	162	204
5	10460.00	56.79	68.20	-11.41	40.26	16.53	Peak	182	288
6	15690.00	52.79	54.00	-1.21	35.57	17.22	Average	162	204
7	15690.00	63.73	74.00	-10.27	46.51	17.22	Peak	162	204

Note 1: Emission Level (dBuV/m) = SA Reading (dBuV/m) + Factor* (dB)

*Factor includes antenna factor , cable loss and amplifier gain

Note 2: Margin (dB) = Emission level (dBuV/m) – Limit (dBuV/m).

Modulation	VHT40	Test Freq. (MHz)	5230
Polarization	Vertical		

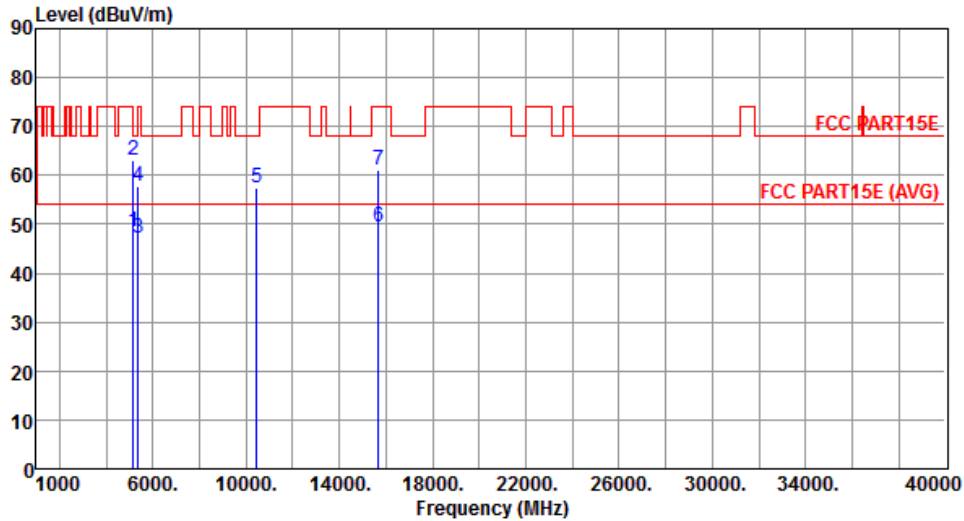

	Freq. MHz	Emission level dBuV/m	Limit dBuV/m	Margin dB	SA reading dBuV	Factor dB	Remark	ANT High cm	Turn Table deg
1	5150.00	48.53	54.00	-5.47	42.22	6.31	Average	219	119
2	5150.00	62.94	74.00	-11.06	56.63	6.31	Peak	219	119
3	5350.00	47.01	54.00	-6.99	40.39	6.62	Average	219	119
4	5350.00	57.91	74.00	-16.09	51.29	6.62	Peak	219	119
5	10460.00	57.39	68.20	-10.81	40.86	16.53	Peak	219	119
6	15690.00	49.47	54.00	-4.53	32.25	17.22	Average	156	183
7	15690.00	61.26	74.00	-12.74	44.04	17.22	Peak	156	183

Note 1: Emission Level (dBuV/m) = SA Reading (dBuV/m) + Factor* (dB)

*Factor includes antenna factor , cable loss and amplifier gain

Note 2: Margin (dB) = Emission level (dBuV/m) – Limit (dBuV/m).

Modulation	VHT40	Test Freq. (MHz)	5270
Polarization	Horizontal		

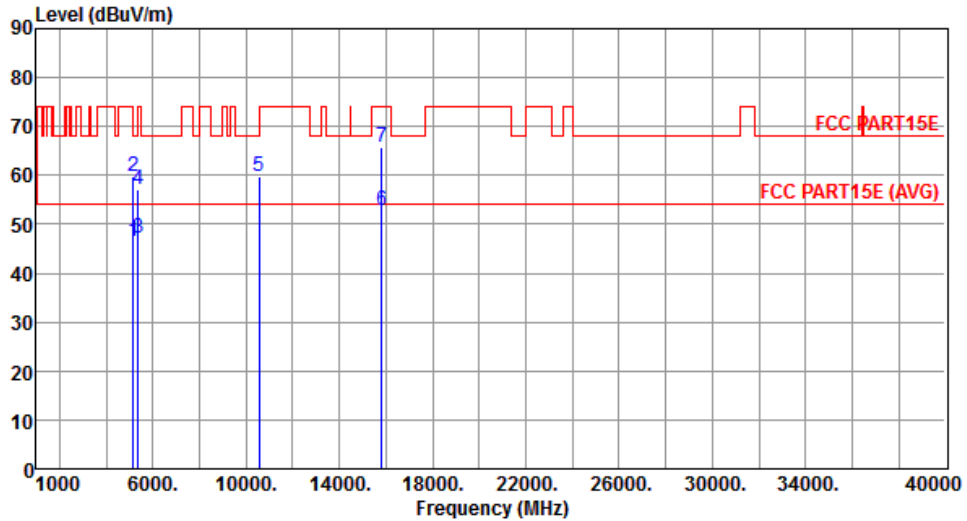

	Freq. MHz	Emission level dBuV/m	Limit dBuV/m	Margin dB	SA reading dBuV	Factor dB	Remark	ANT High cm	Turn Table deg
1	5150.00	46.55	54.00	-7.45	40.24	6.31	Average	166	207
2	5150.00	59.92	74.00	-14.08	53.61	6.31	Peak	166	207
3	5350.00	47.07	54.00	-6.93	40.45	6.62	Average	166	207
4	5350.00	57.11	74.00	-16.89	50.49	6.62	Peak	166	207
5	10540.00	59.88	68.20	-8.32	43.28	16.60	Peak	207	52
6	15810.00	52.96	54.00	-1.04	35.98	16.98	Average	166	207
7	15810.00	65.84	74.00	-8.16	48.86	16.98	Peak	166	207

Note 1: Emission Level (dBuV/m) = SA Reading (dBuV/m) + Factor* (dB)

*Factor includes antenna factor , cable loss and amplifier gain

Note 2: Margin (dB) = Emission level (dBuV/m) – Limit (dBuV/m).

Modulation	VHT40	Test Freq. (MHz)	5270
Polarization	Vertical		

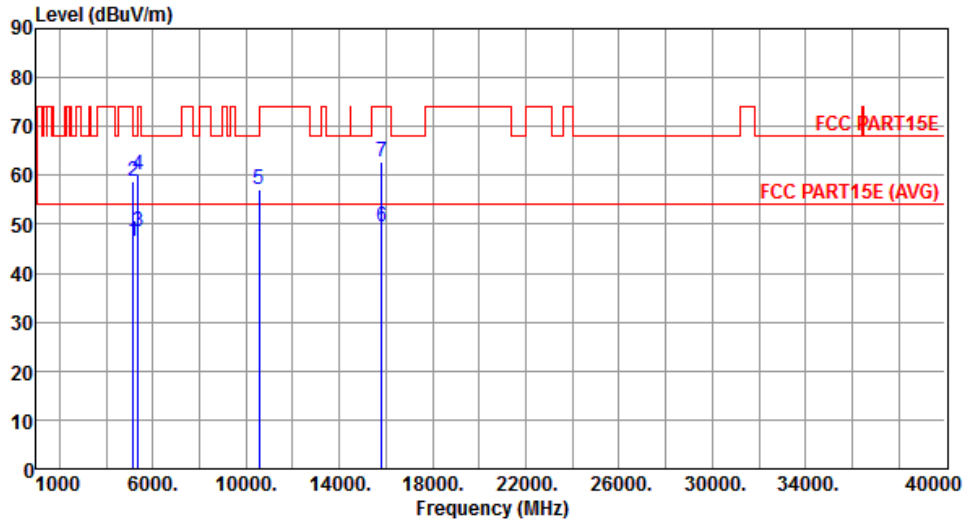

	Freq. MHz	Emission level dBuV/m	Limit dBuV/m	Margin dB	SA reading dBuV	Factor dB	Remark	ANT High cm	Turn Table deg
1	5150.00	46.45	54.00	-7.55	40.14	6.31	Average	178	124
2	5150.00	58.69	74.00	-15.31	52.38	6.31	Peak	178	124
3	5350.00	48.62	54.00	-5.38	42.00	6.62	Average	168	328
4	5350.00	60.10	74.00	-13.90	53.48	6.62	Peak	168	328
5	10540.00	57.11	68.20	-11.09	40.51	16.60	Peak	271	73
6	15810.00	49.48	54.00	-4.52	32.50	16.98	Average	168	328
7	15810.00	62.68	74.00	-11.32	45.70	16.98	Peak	168	328

Note 1: Emission Level (dBuV/m) = SA Reading (dBuV/m) + Factor* (dB)

*Factor includes antenna factor , cable loss and amplifier gain

Note 2: Margin (dB) = Emission level (dBuV/m) – Limit (dBuV/m).

Modulation	VHT40	Test Freq. (MHz)	5310
Polarization	Horizontal		

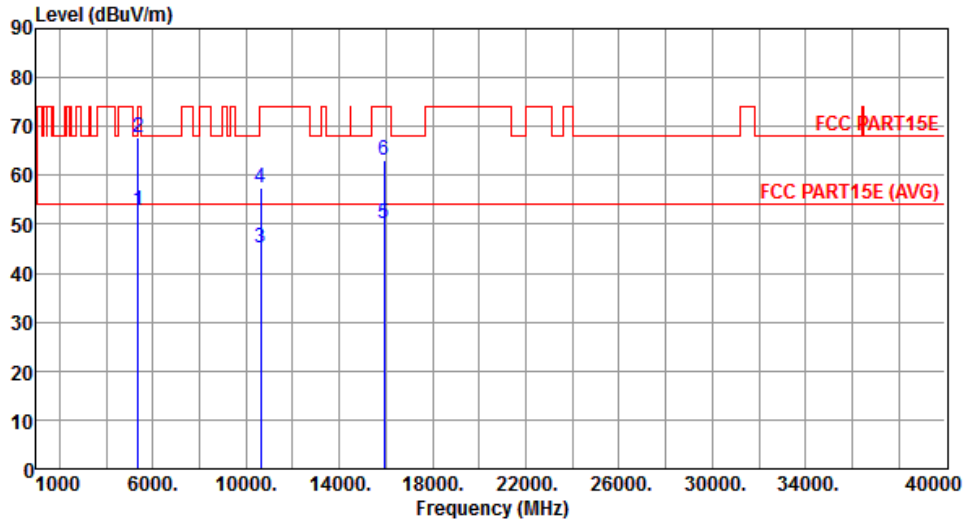

	Freq. MHz	Emission level dBuV/m	Limit dBuV/m	Margin dB	SA reading dBuV	Factor dB	Remark	ANT High cm	Turn Table deg
1	5350.00	52.92	54.00	-1.08	46.30	6.62	Average	183	47
2	5350.00	67.83	74.00	-6.17	61.21	6.62	Peak	183	47
3	10620.00	45.04	54.00	-8.96	28.42	16.62	Average	207	218
4	10620.00	57.38	74.00	-16.62	40.76	16.62	Peak	207	218
5	15930.00	50.21	54.00	-3.79	33.44	16.77	Average	207	218
6	15930.00	62.95	74.00	-11.05	46.18	16.77	Peak	207	218

Note 1: Emission Level (dBuV/m) = SA Reading (dBuV/m) + Factor* (dB)

*Factor includes antenna factor , cable loss and amplifier gain

Note 2: Margin (dB) = Emission level (dBuV/m) – Limit (dBuV/m).

Modulation	VHT40	Test Freq. (MHz)	5310
Polarization	Vertical		

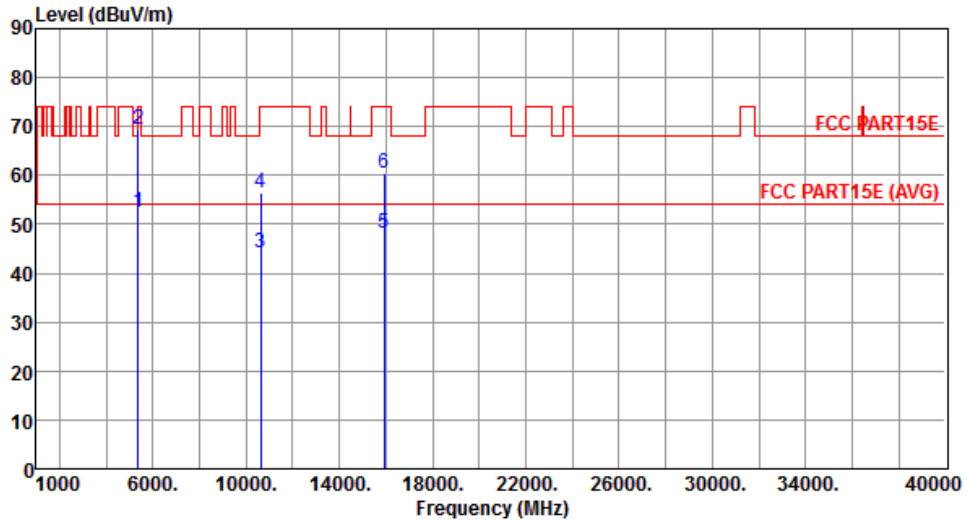

	Freq. MHz	Emission level dBuV/m	Limit dBuV/m	Margin dB	SA reading dBuV	Factor dB	Remark	ANT High cm	Turn Table deg
1	5350.00	52.53	54.00	-1.47	45.91	6.62	Average	188	46
2	5350.00	69.38	74.00	-4.62	62.76	6.62	Peak	188	46
3	10620.00	44.04	54.00	-9.96	27.42	16.62	Average	192	273
4	10620.00	56.32	74.00	-17.68	39.70	16.62	Peak	192	273
5	15930.00	48.09	54.00	-5.91	31.32	16.77	Average	241	58
6	15930.00	60.57	74.00	-13.43	43.80	16.77	Peak	241	58

Note 1: Emission Level (dBuV/m) = SA Reading (dBuV/m) + Factor* (dB)

*Factor includes antenna factor , cable loss and amplifier gain

Note 2: Margin (dB) = Emission level (dBuV/m) – Limit (dBuV/m).

Modulation	VHT40	Test Freq. (MHz)	5510
Polarization	Horizontal		

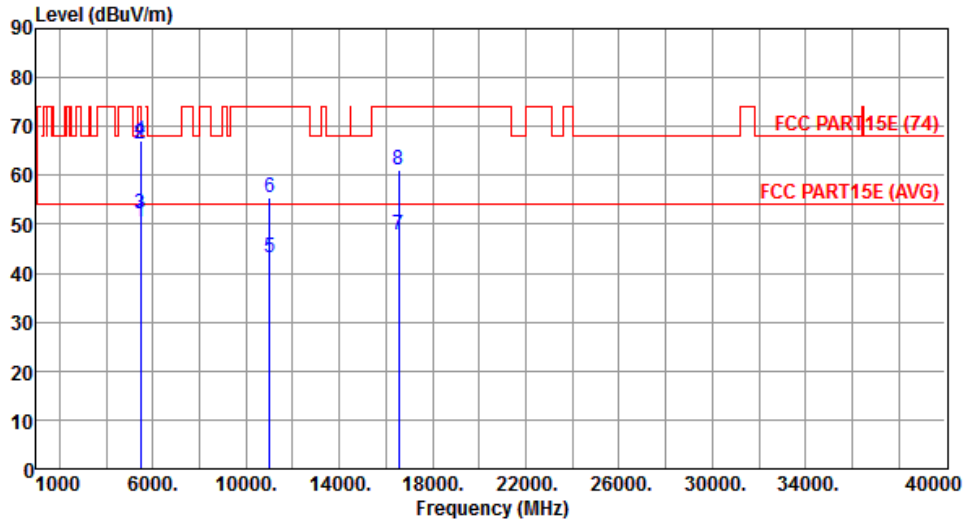

	Freq. MHz	Emission level dBuV/m	Limit dBuV/m	Margin dB	SA reading dBuV	Factor dB	Remark	ANT High cm	Turn Table deg
1	5460.00	50.33	54.00	-3.67	43.57	6.76	Average	192	314
2	5460.00	66.55	74.00	-7.45	59.79	6.76	Peak	192	314
3	5470.00	51.98	54.00	-2.02	45.21	6.77	Average	192	314
4	5470.00	67.01	74.00	-6.99	60.24	6.77	Peak	192	314
5	11020.00	43.32	54.00	-10.68	26.59	16.73	Average	291	335
6	11020.00	55.50	74.00	-18.50	38.77	16.73	Peak	291	335
7	16530.00	47.73	54.00	-6.27	29.79	17.94	Average	151	109
8	16530.00	61.27	74.00	-12.73	43.33	17.94	Peak	151	109

Note 1: Emission Level (dBuV/m) = SA Reading (dBuV/m) + Factor* (dB)

*Factor includes antenna factor , cable loss and amplifier gain

Note 2: Margin (dB) = Emission level (dBuV/m) – Limit (dBuV/m).

Modulation	VHT40	Test Freq. (MHz)	5510
Polarization	Vertical		

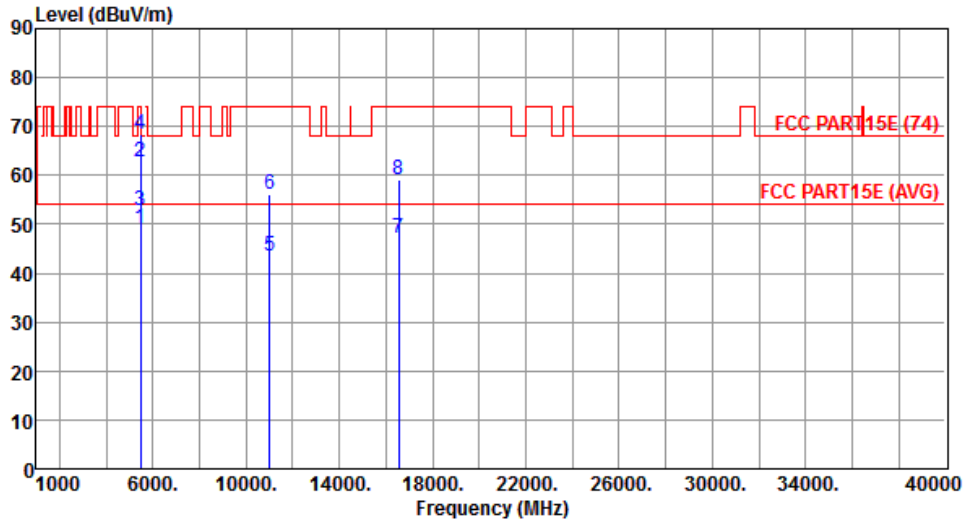

	Freq. MHz	Emission level dBuV/m	Limit dBuV/m	Margin dB	SA reading dBuV	Factor dB	Remark	ANT High cm	Turn Table deg
1	5460.00	49.06	54.00	-4.94	42.30	6.76	Average	197	117
2	5460.00	62.62	74.00	-11.38	55.86	6.76	Peak	197	117
3	5470.00	52.94	54.00	-1.06	46.17	6.77	Average	197	117
4	5470.00	68.36	74.00	-5.64	61.59	6.77	Peak	197	117
5	11020.00	43.38	54.00	-10.62	26.65	16.73	Average	251	137
6	11020.00	55.97	74.00	-18.03	39.24	16.73	Peak	251	137
7	16530.00	47.14	54.00	-6.86	29.20	17.94	Average	199	267
8	16530.00	59.20	74.00	-14.80	41.26	17.94	Peak	199	267

Note 1: Emission Level (dBuV/m) = SA Reading (dBuV/m) + Factor* (dB)

*Factor includes antenna factor , cable loss and amplifier gain

Note 2: Margin (dB) = Emission level (dBuV/m) – Limit (dBuV/m).

Modulation	VHT40	Test Freq. (MHz)	5550
Polarization	Horizontal		

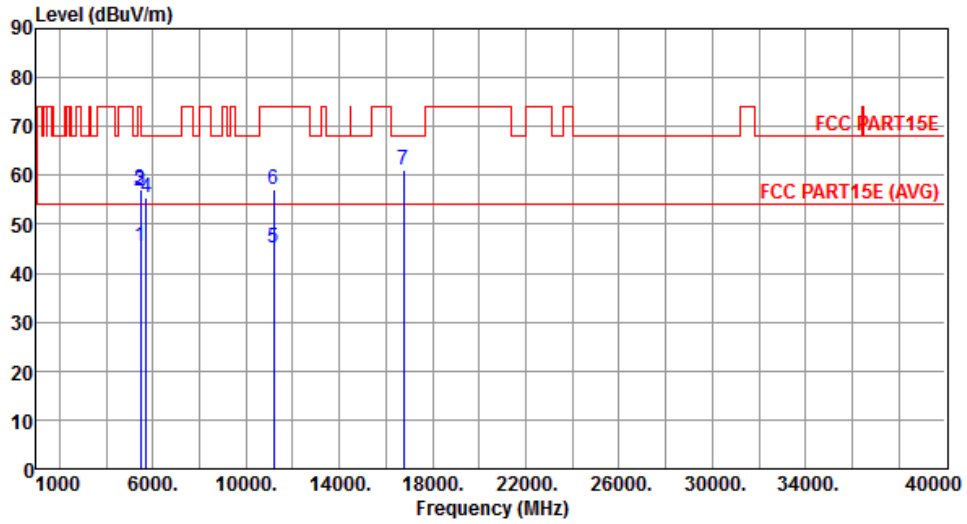

	Freq. MHz	Emission level dBuV/m	Limit dBuV/m	Margin dB	SA reading dBuV	Factor dB	Remark	ANT High cm	Turn Table deg
1	5460.00	45.54	54.00	-8.46	38.78	6.76	Average	210	297
2	5460.00	56.64	74.00	-17.36	49.88	6.76	Peak	210	297
3	5470.00	57.28	68.20	-10.92	50.51	6.77	Peak	210	297
4	5725.00	55.60	68.20	-12.60	48.36	7.24	Peak	210	300
5	11180.00	45.28	54.00	-8.72	28.49	16.79	Average	250	127
6	11180.00	57.13	74.00	-16.87	40.34	16.79	Peak	250	127
7	16770.00	61.24	68.20	-6.96	42.77	18.47	Peak	161	290

Note 1: Emission Level (dBuV/m) = SA Reading (dBuV/m) + Factor* (dB)

*Factor includes antenna factor , cable loss and amplifier gain

Note 2: Margin (dB) = Emission level (dBuV/m) – Limit (dBuV/m).

Modulation	VHT40	Test Freq. (MHz)	5550
Polarization	Vertical		

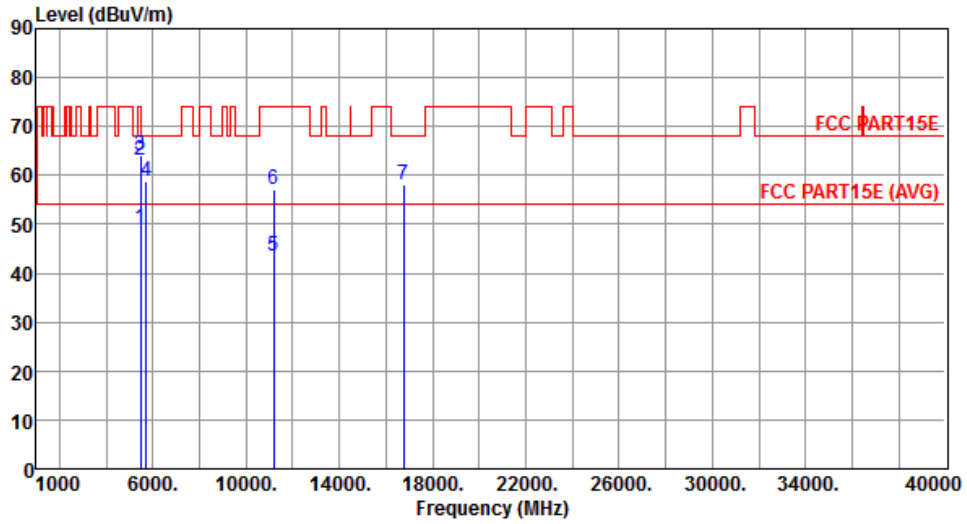

	Freq. MHz	Emission level dBuV/m	Limit dBuV/m	Margin dB	SA reading dBuV	Factor dB	Remark	ANT High cm	Turn Table deg
1	5460.00	49.29	54.00	-4.71	42.53	6.76	Average	259	104
2	5460.00	63.25	74.00	-10.75	56.49	6.76	Peak	259	104
3	5470.00	64.22	68.20	-3.98	57.45	6.77	Peak	259	104
4	5725.00	58.71	68.20	-9.49	51.47	7.24	Peak	262	100
5	11180.00	43.56	54.00	-10.44	26.77	16.79	Average	167	92
6	11180.00	57.18	74.00	-16.82	40.39	16.79	Peak	167	92
7	16770.00	58.17	68.20	-10.03	39.70	18.47	Peak	197	267

Note 1: Emission Level (dBuV/m) = SA Reading (dBuV/m) + Factor* (dB)

*Factor includes antenna factor , cable loss and amplifier gain

Note 2: Margin (dB) = Emission level (dBuV/m) – Limit (dBuV/m).

Modulation	VHT40	Test Freq. (MHz)	5670
Polarization	Horizontal		

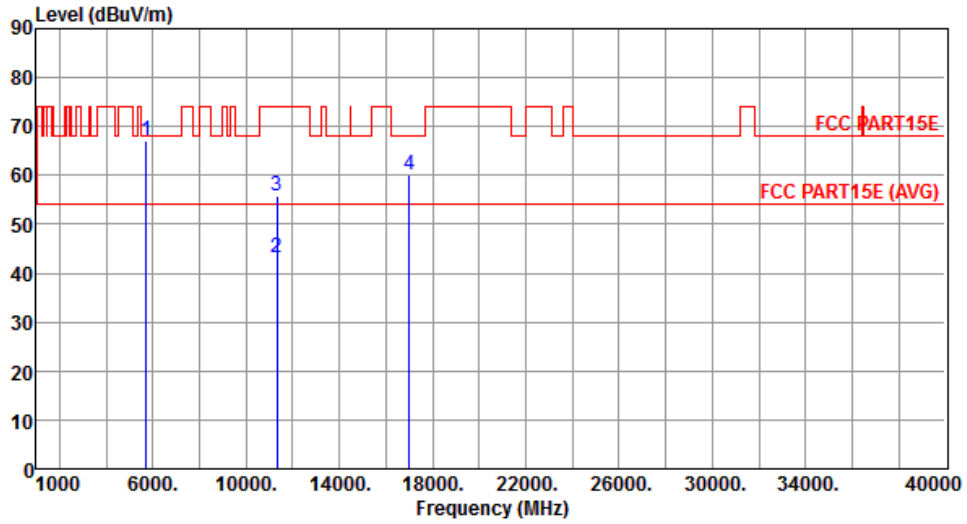

	Freq. MHz	Emission level dBuV/m	Limit dBuV/m	Margin dB	SA reading dBuV	Factor dB	Remark	ANT High cm	Turn Table deg
1	5725.00	67.06	68.20	-1.14	59.82	7.24	Peak	208	299
2	11340.00	43.27	54.00	-10.73	26.42	16.85	Average	287	135
3	11340.00	55.76	74.00	-18.24	38.91	16.85	Peak	287	135
4	17010.00	59.96	68.20	-8.24	40.97	18.99	Peak	267	100

Note 1: Emission Level (dBuV/m) = SA Reading (dBuV/m) + Factor* (dB)

*Factor includes antenna factor , cable loss and amplifier gain

Note 2: Margin (dB) = Emission level (dBuV/m) – Limit (dBuV/m).

Modulation	VHT40	Test Freq. (MHz)	5670
Polarization	Vertical		

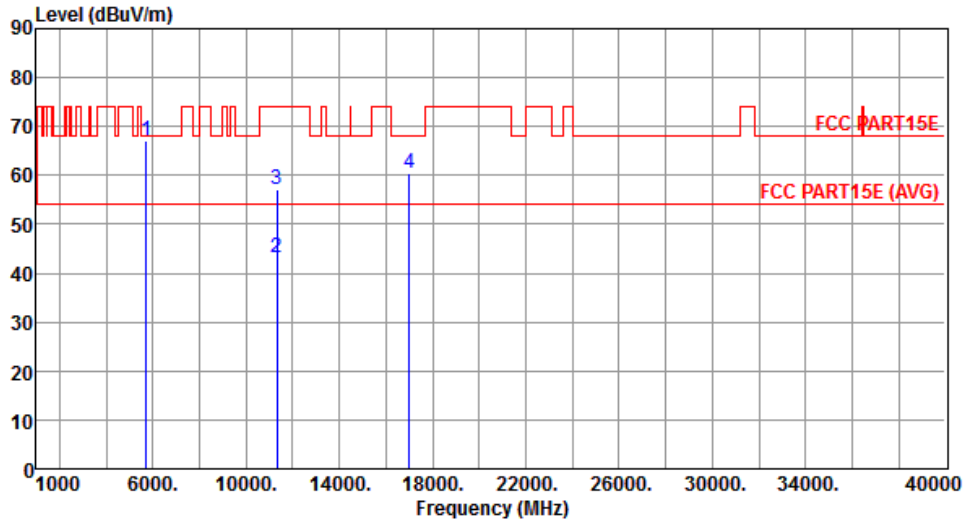

	Freq. MHz	Emission level dBuV/m	Limit dBuV/m	Margin dB	SA reading dBuV	Factor dB	Remark	ANT High cm	Turn Table deg
1	5725.00	67.11	68.20	-1.09	59.87	7.24	Peak	204	131
2	11340.00	43.30	54.00	-10.70	26.45	16.85	Average	223	137
3	11340.00	57.26	74.00	-16.74	40.41	16.85	Peak	223	137
4	17010.00	60.52	68.20	-7.68	41.53	18.99	Peak	189	305

Note 1: Emission Level (dBuV/m) = SA Reading (dBuV/m) + Factor* (dB)

*Factor includes antenna factor , cable loss and amplifier gain

Note 2: Margin (dB) = Emission level (dBuV/m) – Limit (dBuV/m).

Modulation	VHT40	Test Freq. (MHz)	5710
Polarization	Horizontal		

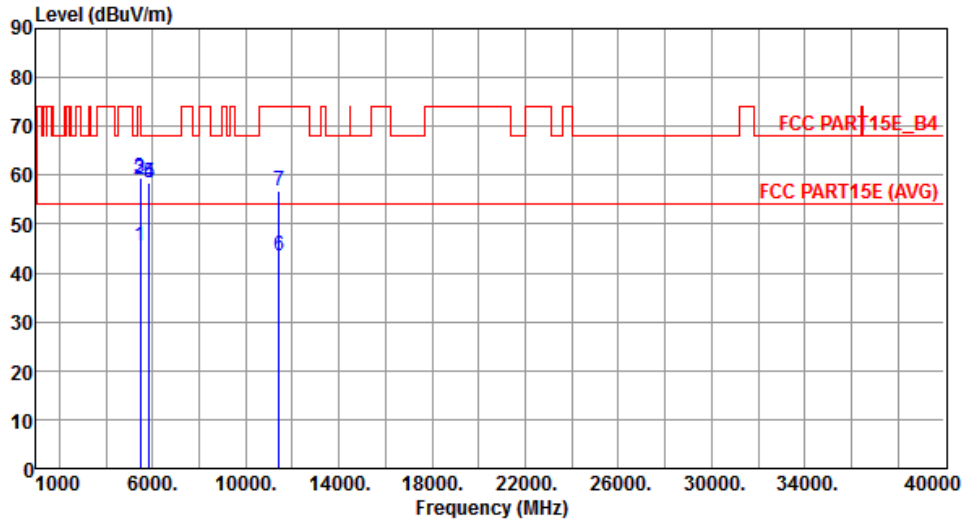

	Freq. MHz	Emission level dBuV/m	Limit dBuV/m	Margin dB	SA reading dBuV	Factor dB	Remark	ANT High cm	Turn Table deg
1	5460.00	45.48	54.00	-8.52	38.72	6.76	Average	203	300
2	5460.00	59.26	74.00	-14.74	52.50	6.76	Peak	203	300
3	5470.00	59.49	68.20	-8.71	52.72	6.77	Peak	203	300
4	5850.00	58.43	78.20	-19.77	50.93	7.50	Peak	203	300
5	5860.00	58.29	68.20	-9.91	50.78	7.51	Peak	203	300
6	11420.00	43.42	54.00	-10.58	26.53	16.89	Average	155	229
7	11420.00	56.95	74.00	-17.05	40.06	16.89	Peak	155	229

Note 1: Emission Level (dBuV/m) = SA Reading (dBuV/m) + Factor* (dB)

*Factor includes antenna factor , cable loss and amplifier gain

Note 2: Margin (dB) = Emission level (dBuV/m) – Limit (dBuV/m).

Modulation	VHT40	Test Freq. (MHz)	5710
Polarization	Vertical		

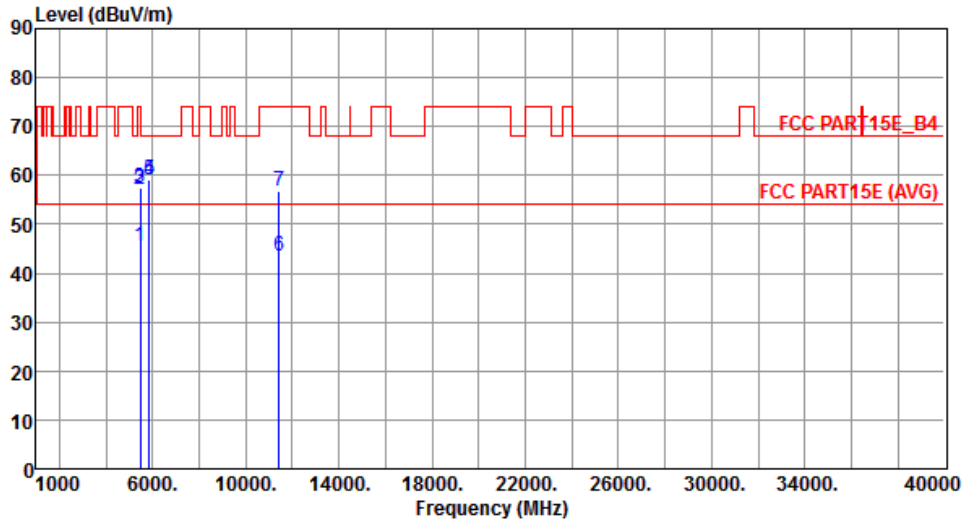

	Freq. MHz	Emission level dBuV/m	Limit dBuV/m	Margin dB	SA reading dBuV	Factor dB	Remark	ANT High cm	Turn Table deg
1	5460.00	45.38	54.00	-8.62	38.62	6.76	Average	209	140
2	5460.00	57.18	74.00	-16.82	50.42	6.76	Peak	209	140
3	5470.00	57.60	68.20	-10.60	50.83	6.77	Peak	209	140
4	5850.00	59.26	78.20	-18.94	51.76	7.50	Peak	209	140
5	5860.00	59.04	68.20	-9.16	51.53	7.51	Peak	209	140
6	11420.00	43.62	54.00	-10.38	26.73	16.89	Average	150	123
7	11420.00	56.75	74.00	-17.25	39.86	16.89	Peak	150	123

Note 1: Emission Level (dBuV/m) = SA Reading (dBuV/m) + Factor* (dB)
 *Factor includes antenna factor , cable loss and amplifier gain
 Note 2: Margin (dB) = Emission level (dBuV/m) – Limit (dBuV/m).

Modulation	VHT40	Test Freq. (MHz)	5755
Polarization	Horizontal		

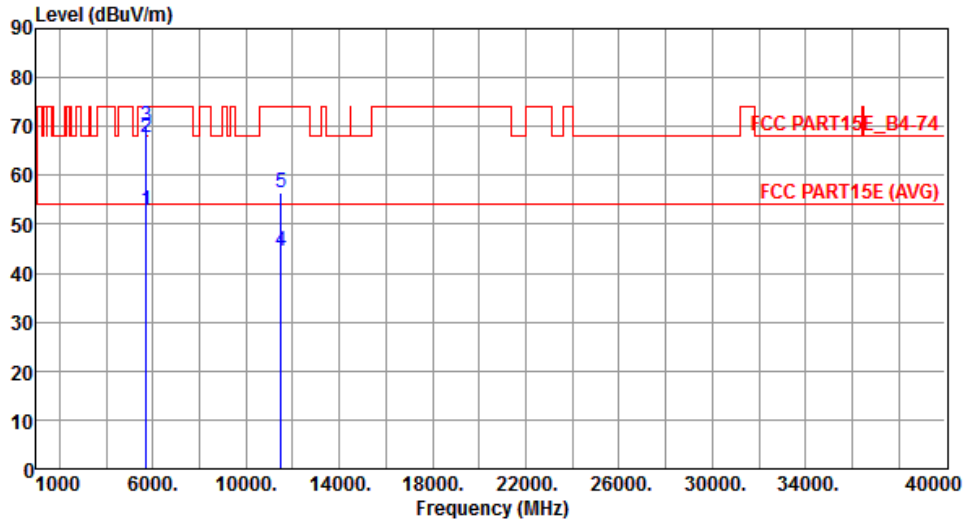

	Freq. MHz	Emission level dBuV/m	Limit dBuV/m	Margin dB	SA reading dBuV	Factor dB	Remark	ANT High cm	Turn Table deg
1	5715.00	52.96	54.00	-1.04	47.31	5.65	Average	102	118
2	5715.00	67.76	74.00	-6.24	62.11	5.65	Peak	102	118
3	5725.00	70.11	78.20	-8.09	64.47	5.64	Peak	102	118
4	11510.00	44.57	54.00	-9.43	28.65	15.92	Average	100	166
5	11510.00	56.30	74.00	-17.70	40.38	15.92	Peak	100	166

Note 1: Emission Level (dBuV/m) = SA Reading (dBuV/m) + Factor* (dB)

*Factor includes antenna factor , cable loss and amplifier gain

Note 2: Margin (dB) = Emission level (dBuV/m) – Limit (dBuV/m).

Modulation	VHT40	Test Freq. (MHz)	5755
Polarization	Vertical		

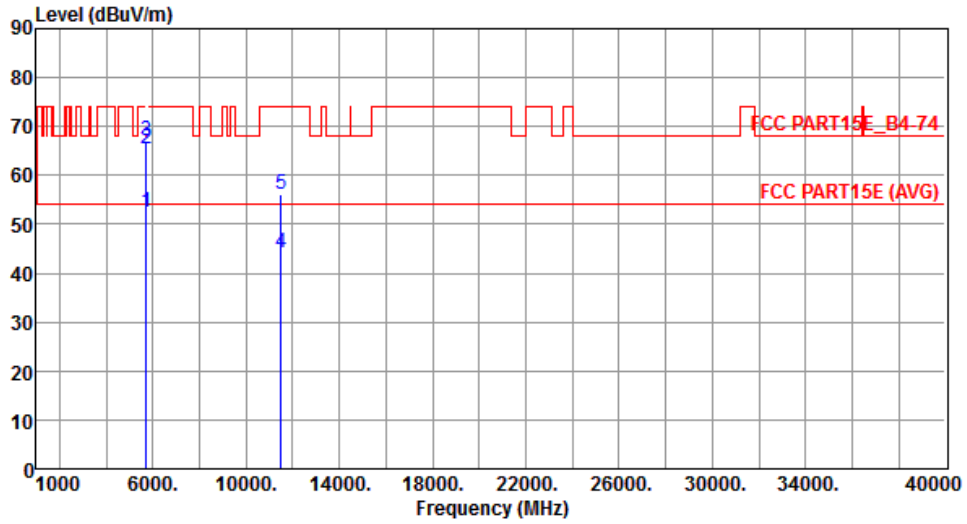

	Freq. MHz	Emission level dBuV/m	Limit dBuV/m	Margin dB	SA reading dBuV	Factor dB	Remark	ANT High cm	Turn Table deg
1	5715.00	52.47	54.00	-1.53	46.82	5.65	Average	213	246
2	5715.00	65.47	74.00	-8.53	59.82	5.65	Peak	213	246
3	5725.00	66.94	78.20	-11.26	61.30	5.64	Peak	213	246
4	11510.00	44.34	54.00	-9.66	28.42	15.92	Average	100	168
5	11510.00	56.23	74.00	-17.77	40.31	15.92	Peak	100	168

Note 1: Emission Level (dBuV/m) = SA Reading (dBuV/m) + Factor* (dB)

*Factor includes antenna factor , cable loss and amplifier gain

Note 2: Margin (dB) = Emission level (dBuV/m) – Limit (dBuV/m).

Modulation	VHT40	Test Freq. (MHz)	5795
Polarization	Horizontal		

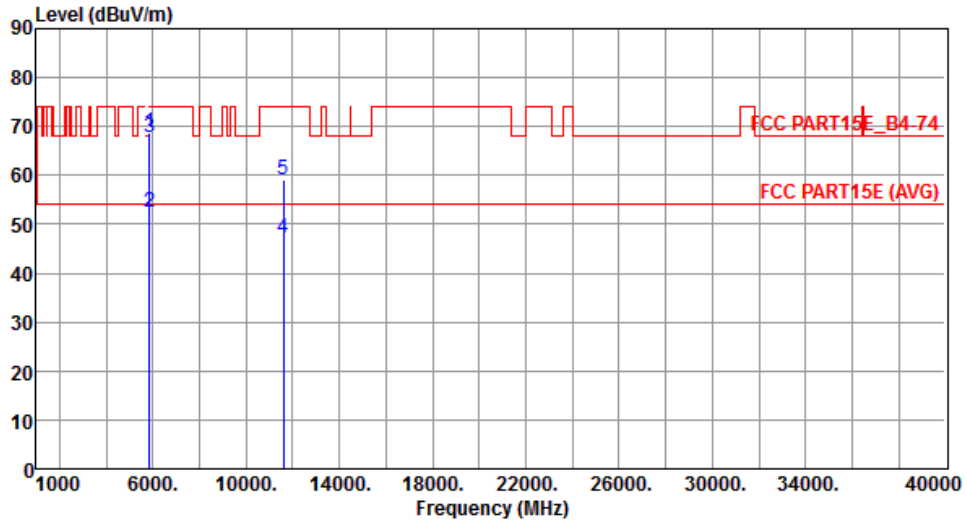

	Freq. MHz	Emission level dBuV/m	Limit dBuV/m	Margin dB	SA reading dBuV	Factor dB	Remark	ANT High cm	Turn Table deg
1	5850.00	68.60	78.20	-9.60	62.85	5.75	Peak	240	117
2	5860.00	52.60	54.00	-1.40	46.84	5.76	Average	240	117
3	5860.00	67.63	74.00	-6.37	61.87	5.76	Peak	240	117
4	11590.00	47.14	54.00	-6.86	31.43	15.71	Average	121	316
5	11590.00	59.10	74.00	-14.90	43.39	15.71	Peak	121	316

Note 1: Emission Level (dBuV/m) = SA Reading (dBuV/m) + Factor* (dB)

*Factor includes antenna factor , cable loss and amplifier gain

Note 2: Margin (dB) = Emission level (dBuV/m) – Limit (dBuV/m).

Modulation	VHT40	Test Freq. (MHz)	5795
Polarization	Vertical		

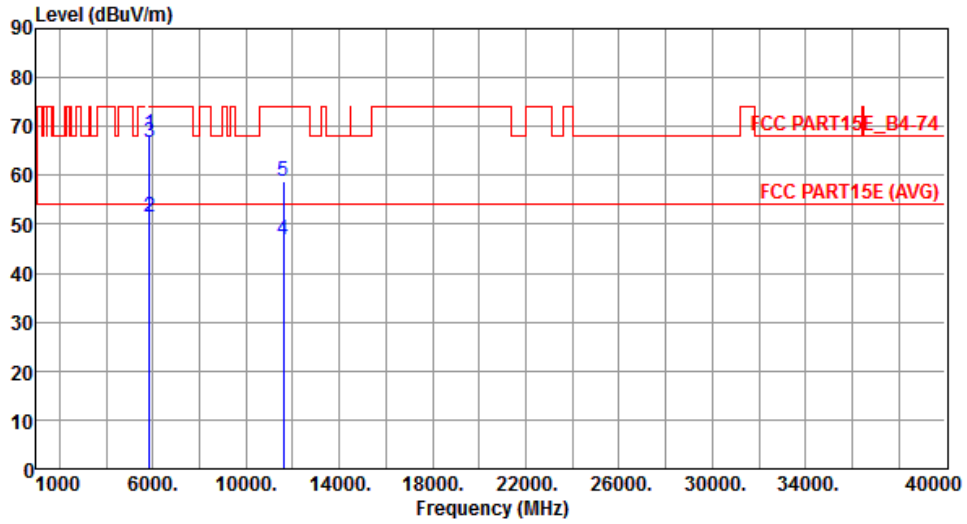

	Freq. MHz	Emission level dBuV/m	Limit dBuV/m	Margin dB	SA reading dBuV	Factor dB	Remark	ANT High cm	Turn Table deg
1	5850.00	68.25	78.20	-9.95	62.50	5.75	Peak	102	250
2	5860.00	51.37	54.00	-2.63	45.61	5.76	Average	102	250
3	5860.00	66.72	74.00	-7.28	60.96	5.76	Peak	102	250
4	11590.00	46.93	54.00	-7.07	31.22	15.71	Average	100	258
5	11590.00	58.93	74.00	-15.07	43.22	15.71	Peak	100	258

Note 1: Emission Level (dBuV/m) = SA Reading (dBuV/m) + Factor* (dB)

*Factor includes antenna factor , cable loss and amplifier gain

Note 2: Margin (dB) = Emission level (dBuV/m) – Limit (dBuV/m).

3.5.9 Transmitter Radiated Unwanted Emissions (Above 1GHz) for VHT80

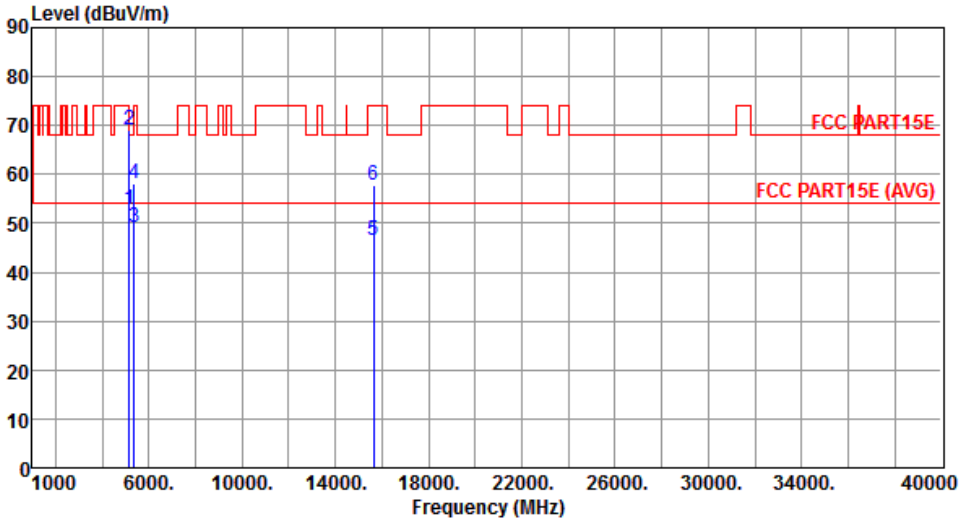
Modulation	VHT80	Test Freq. (MHz)	5210																																																																																			
Polarization	Horizontal																																																																																					
																																																																																						
	<table border="1"> <thead> <tr> <th>Freq.</th> <th>Emission level</th> <th>Limit</th> <th>Margin</th> <th>SA reading</th> <th>Factor</th> <th>Remark</th> <th>ANT High</th> <th>Turn Table</th> </tr> <tr> <th>MHz</th> <th>dBuV/m</th> <th>dBuV/m</th> <th>dB</th> <th>dBuV</th> <th>dB</th> <th></th> <th>cm</th> <th>deg</th> </tr> </thead> <tbody> <tr> <td>1</td> <td>5150.00</td> <td>52.65</td> <td>54.00</td> <td>-1.35</td> <td>46.34</td> <td>6.31</td> <td>Average</td> <td>176</td> <td>123</td> </tr> <tr> <td>2</td> <td>5150.00</td> <td>68.98</td> <td>74.00</td> <td>-5.02</td> <td>62.67</td> <td>6.31</td> <td>Peak</td> <td>176</td> <td>123</td> </tr> <tr> <td>3</td> <td>5350.00</td> <td>49.05</td> <td>54.00</td> <td>-4.95</td> <td>42.43</td> <td>6.62</td> <td>Average</td> <td>226</td> <td>308</td> </tr> <tr> <td>4</td> <td>5350.00</td> <td>58.01</td> <td>74.00</td> <td>-15.99</td> <td>51.39</td> <td>6.62</td> <td>Peak</td> <td>226</td> <td>308</td> </tr> <tr> <td>5</td> <td>15630.00</td> <td>46.62</td> <td>54.00</td> <td>-7.38</td> <td>29.31</td> <td>17.31</td> <td>Average</td> <td>160</td> <td>87</td> </tr> <tr> <td>6</td> <td>15630.00</td> <td>57.62</td> <td>74.00</td> <td>-16.38</td> <td>40.31</td> <td>17.31</td> <td>Peak</td> <td>160</td> <td>87</td> </tr> </tbody> </table>	Freq.	Emission level	Limit	Margin	SA reading	Factor	Remark	ANT High	Turn Table	MHz	dBuV/m	dBuV/m	dB	dBuV	dB		cm	deg	1	5150.00	52.65	54.00	-1.35	46.34	6.31	Average	176	123	2	5150.00	68.98	74.00	-5.02	62.67	6.31	Peak	176	123	3	5350.00	49.05	54.00	-4.95	42.43	6.62	Average	226	308	4	5350.00	58.01	74.00	-15.99	51.39	6.62	Peak	226	308	5	15630.00	46.62	54.00	-7.38	29.31	17.31	Average	160	87	6	15630.00	57.62	74.00	-16.38	40.31	17.31	Peak	160	87							
Freq.	Emission level	Limit	Margin	SA reading	Factor	Remark	ANT High	Turn Table																																																																														
MHz	dBuV/m	dBuV/m	dB	dBuV	dB		cm	deg																																																																														
1	5150.00	52.65	54.00	-1.35	46.34	6.31	Average	176	123																																																																													
2	5150.00	68.98	74.00	-5.02	62.67	6.31	Peak	176	123																																																																													
3	5350.00	49.05	54.00	-4.95	42.43	6.62	Average	226	308																																																																													
4	5350.00	58.01	74.00	-15.99	51.39	6.62	Peak	226	308																																																																													
5	15630.00	46.62	54.00	-7.38	29.31	17.31	Average	160	87																																																																													
6	15630.00	57.62	74.00	-16.38	40.31	17.31	Peak	160	87																																																																													
<p>Note 1: Emission Level (dBuV/m) = SA Reading (dBuV/m) + Factor* (dB) *Factor includes antenna factor , cable loss and amplifier gain Note 2: Margin (dB) = Emission level (dBuV/m) – Limit (dBuV/m).</p>																																																																																						

Modulation	VHT80	Test Freq. (MHz)	5210
Polarization	Vertical		

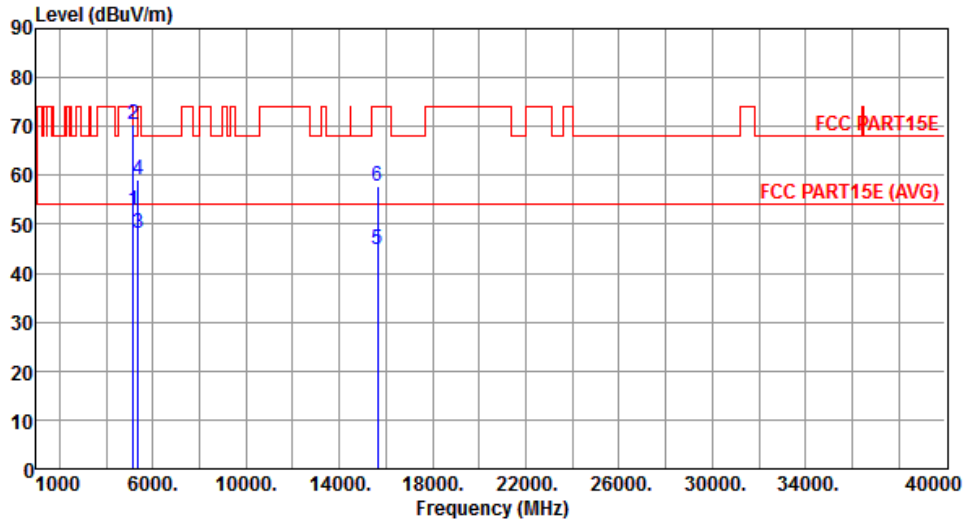

	Freq. MHz	Emission level dBuV/m	Limit dBuV/m	Margin dB	SA reading dBuV	Factor dB	Remark	ANT High cm	Turn Table deg
1	5150.00	52.80	54.00	-1.20	46.49	6.31	Average	189	101
2	5150.00	70.37	74.00	-3.63	64.06	6.31	Peak	189	101
3	5350.00	48.12	54.00	-5.88	41.50	6.62	Average	183	123
4	5350.00	59.21	74.00	-14.79	52.59	6.62	Peak	183	123
5	15630.00	44.74	54.00	-9.26	27.43	17.31	Average	274	225
6	15630.00	57.69	74.00	-16.31	40.38	17.31	Peak	274	225

Note 1: Emission Level (dBuV/m) = SA Reading (dBuV/m) + Factor* (dB)

*Factor includes antenna factor , cable loss and amplifier gain

Note 2: Margin (dB) = Emission level (dBuV/m) – Limit (dBuV/m).

Modulation	VHT80	Test Freq. (MHz)	5290
Polarization	Horizontal		

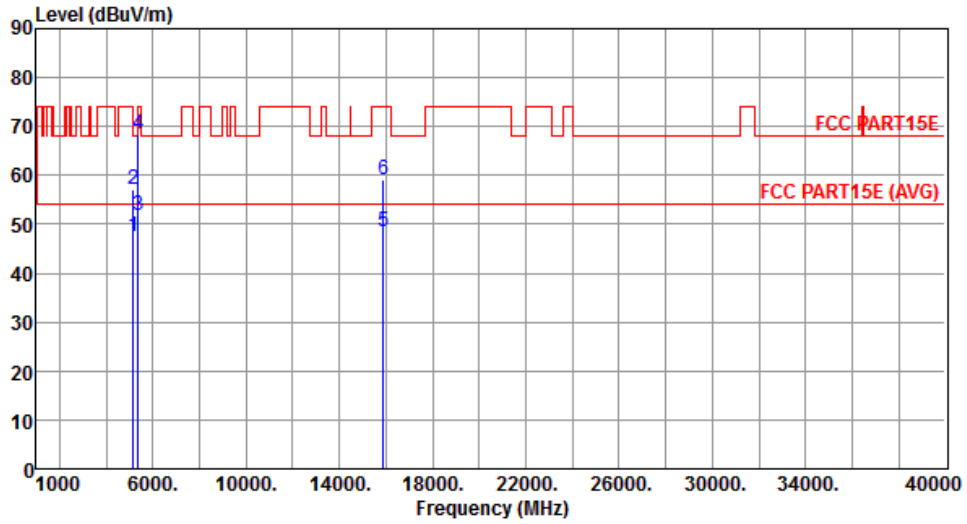

	Freq. MHz	Emission level dBuV/m	Limit dBuV/m	Margin dB	SA reading dBuV	Factor dB	Remark	ANT High cm	Turn Table deg
1	5150.00	47.57	54.00	-6.43	41.26	6.31	Average	192	311
2	5150.00	57.07	74.00	-16.93	50.76	6.31	Peak	192	311
3	5350.00	51.94	54.00	-2.06	45.32	6.62	Average	232	50
4	5350.00	68.32	74.00	-5.68	61.70	6.62	Peak	232	50
5	15870.00	48.43	54.00	-5.57	31.54	16.89	Average	163	211
6	15870.00	58.96	74.00	-15.04	42.07	16.89	Peak	163	211

Note 1: Emission Level (dBuV/m) = SA Reading (dBuV/m) + Factor* (dB)

*Factor includes antenna factor , cable loss and amplifier gain

Note 2: Margin (dB) = Emission level (dBuV/m) – Limit (dBuV/m).

Modulation	VHT80	Test Freq. (MHz)	5290
Polarization	Vertical		

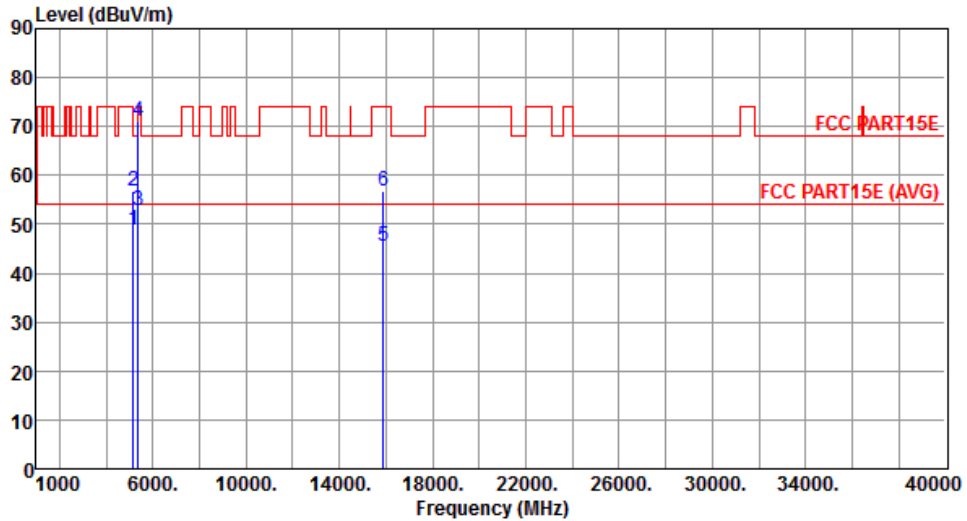

	Freq. MHz	Emission level dBuV/m	Limit dBuV/m	Margin dB	SA reading dBuV	Factor dB	Remark	ANT High cm	Turn Table deg
1	5150.00	48.66	54.00	-5.34	42.35	6.31	Average	262	100
2	5150.00	56.71	74.00	-17.29	50.40	6.31	Peak	262	100
3	5350.00	52.82	54.00	-1.18	46.20	6.62	Average	268	70
4	5350.00	71.12	74.00	-2.88	64.50	6.62	Peak	268	70
5	15870.00	45.65	54.00	-8.35	28.76	16.89	Average	200	177
6	15870.00	56.73	74.00	-17.27	39.84	16.89	Peak	200	177

Note 1: Emission Level (dBuV/m) = SA Reading (dBuV/m) + Factor* (dB)

*Factor includes antenna factor , cable loss and amplifier gain

Note 2: Margin (dB) = Emission level (dBuV/m) – Limit (dBuV/m).

Modulation	VHT80	Test Freq. (MHz)	5530
Polarization	Horizontal		

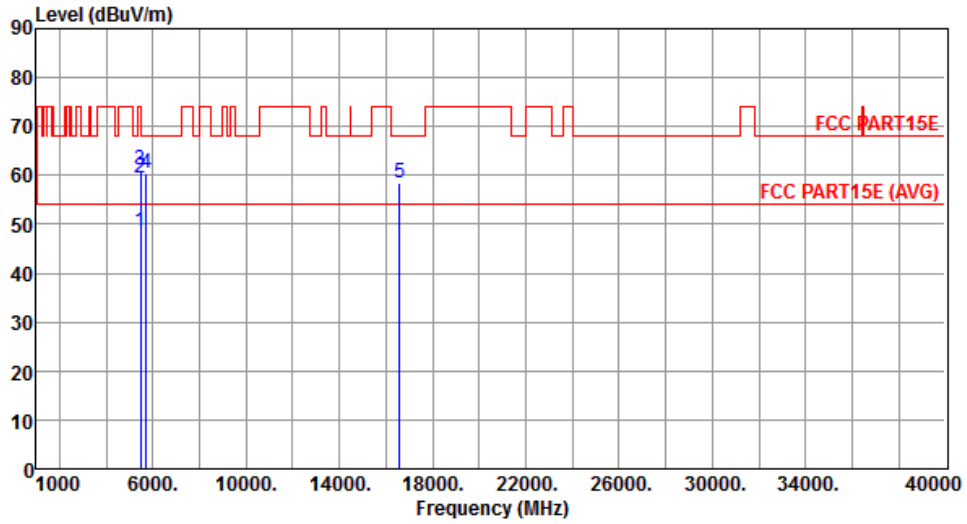

	Freq. MHz	Emission level dBuV/m	Limit dBuV/m	Margin dB	SA reading dBuV	Factor dB	Remark	ANT High cm	Turn Table deg
1	5460.00	48.57	54.00	-5.43	41.81	6.76	Average	191	302
2	5460.00	59.48	74.00	-14.52	52.72	6.76	Peak	191	302
3	5470.00	61.02	68.20	-7.18	54.25	6.77	Peak	191	302
4	5725.00	60.44	68.20	-7.76	53.20	7.24	Peak	191	302
5	16590.00	58.37	68.20	-9.83	40.30	18.07	Peak	160	191

Note 1: Emission Level (dBuV/m) = SA Reading (dBuV/m) + Factor* (dB)

*Factor includes antenna factor , cable loss and amplifier gain

Note 2: Margin (dB) = Emission level (dBuV/m) – Limit (dBuV/m).

Modulation	VHT80	Test Freq. (MHz)	5530
Polarization	Vertical		

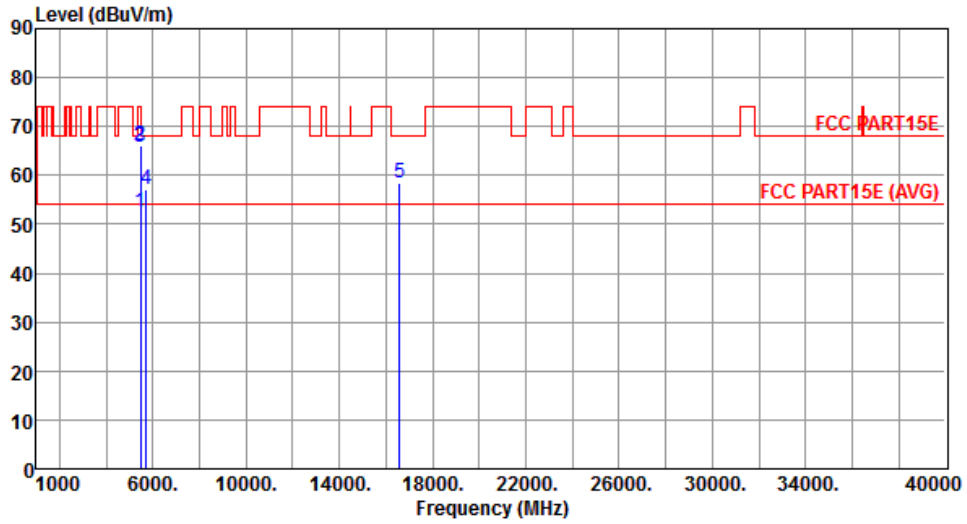

	Freq. MHz	Emission level dBuV/m	Limit dBuV/m	Margin dB	SA reading dBuV	Factor dB	Remark	ANT High cm	Turn Table deg
1	5460.00	52.63	54.00	-1.37	45.87	6.76	Average	267	101
2	5460.00	66.20	74.00	-7.80	59.44	6.76	Peak	267	101
3	5470.00	65.87	68.20	-2.33	59.10	6.77	Peak	267	101
4	5725.00	57.17	68.20	-11.03	49.93	7.24	Peak	210	108
5	16590.00	58.59	68.20	-9.61	40.52	18.07	Peak	180	52

Note 1: Emission Level (dBuV/m) = SA Reading (dBuV/m) + Factor* (dB)

*Factor includes antenna factor , cable loss and amplifier gain

Note 2: Margin (dB) = Emission level (dBuV/m) – Limit (dBuV/m).

Modulation	VHT80	Test Freq. (MHz)	5610
Polarization	Horizontal		

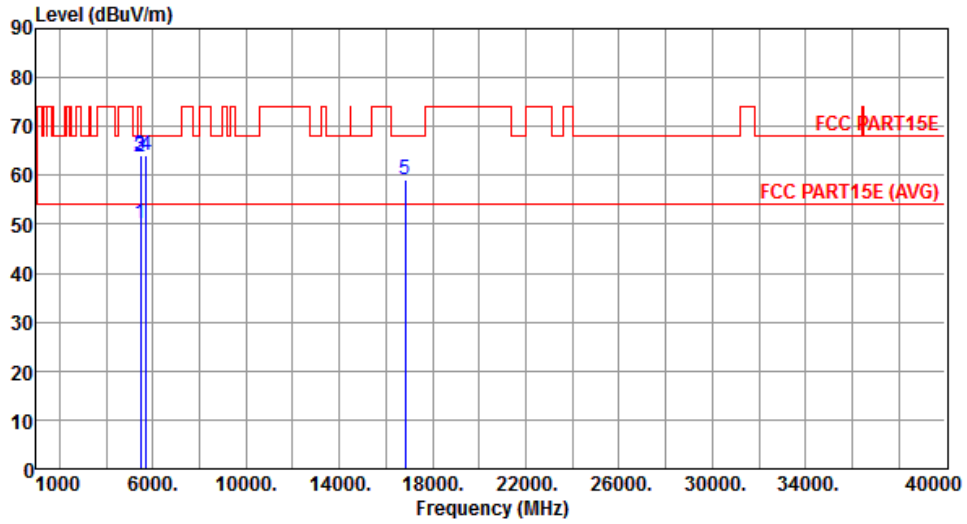

	Freq. MHz	Emission level dBuV/m	Limit dBuV/m	Margin dB	SA reading dBuV	Factor dB	Remark	ANT High cm	Turn Table deg
1	5460.00	50.25	54.00	-3.75	43.49	6.76	Average	209	48
2	5460.00	63.63	74.00	-10.37	56.87	6.76	Peak	209	48
3	5470.00	64.09	68.20	-4.11	57.32	6.77	Peak	209	48
4	5725.00	64.09	68.20	-4.11	56.85	7.24	Peak	273	49
5	16830.00	59.18	68.20	-9.02	40.57	18.61	Peak	234	119

Note 1: Emission Level (dBuV/m) = SA Reading (dBuV/m) + Factor* (dB)

*Factor includes antenna factor , cable loss and amplifier gain

Note 2: Margin (dB) = Emission level (dBuV/m) – Limit (dBuV/m).

Modulation	VHT80	Test Freq. (MHz)	5610
Polarization	Vertical		

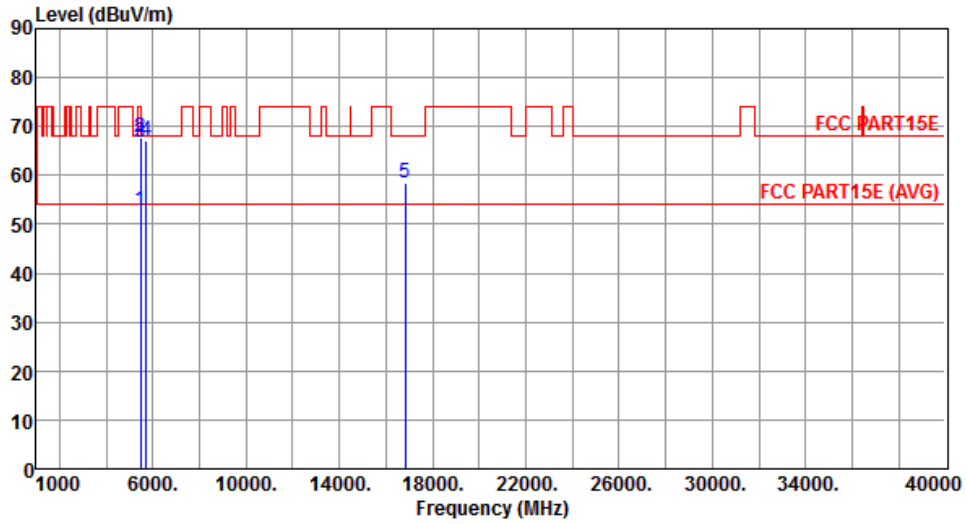

	Freq. MHz	Emission level dBuV/m	Limit dBuV/m	Margin dB	SA reading dBuV	Factor dB	Remark	ANT High cm	Turn Table deg
1	5460.00	52.95	54.00	-1.05	46.19	6.76	Average	261	102
2	5460.00	67.88	74.00	-6.12	61.12	6.76	Peak	261	102
3	5470.00	66.91	68.20	-1.29	60.14	6.77	Peak	261	102
4	5725.00	67.12	68.20	-1.08	59.88	7.24	Peak	214	97
5	16830.00	58.30	68.20	-9.90	39.69	18.61	Peak	178	135

Note 1: Emission Level (dBuV/m) = SA Reading (dBuV/m) + Factor* (dB)

*Factor includes antenna factor , cable loss and amplifier gain

Note 2: Margin (dB) = Emission level (dBuV/m) – Limit (dBuV/m).

Modulation	VHT80	Test Freq. (MHz)	5690
Polarization	Horizontal		

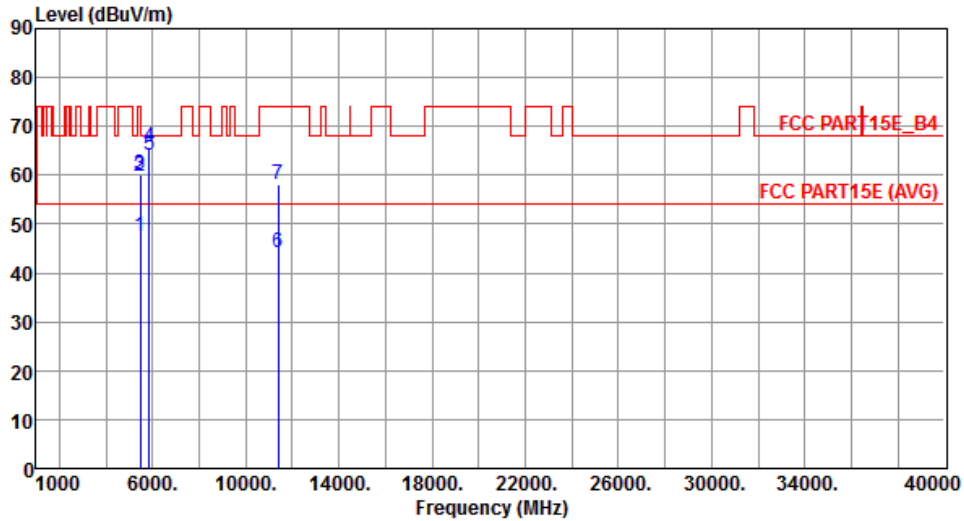

	Freq. MHz	Emission level dBuV/m	Limit dBuV/m	Margin dB	SA reading dBuV	Factor dB	Remark	ANT High cm	Turn Table deg
1	5460.00	47.64	54.00	-6.36	40.88	6.76	Average	193	326
2	5460.00	59.91	74.00	-14.09	53.15	6.76	Peak	193	326
3	5470.00	59.99	68.20	-8.21	53.22	6.77	Peak	193	326
4	5850.00	65.69	78.20	-12.51	58.19	7.50	Peak	193	326
5	5860.00	64.02	68.20	-4.18	56.51	7.51	Peak	193	326
6	11380.00	44.16	54.00	-9.84	27.30	16.86	Average	166	333
7	11380.00	58.12	74.00	-15.88	41.26	16.86	Peak	166	333

Note 1: Emission Level (dBuV/m) = SA Reading (dBuV/m) + Factor* (dB)

*Factor includes antenna factor , cable loss and amplifier gain

Note 2: Margin (dB) = Emission level (dBuV/m) – Limit (dBuV/m).

Modulation	VHT80	Test Freq. (MHz)	5690
Polarization	Vertical		

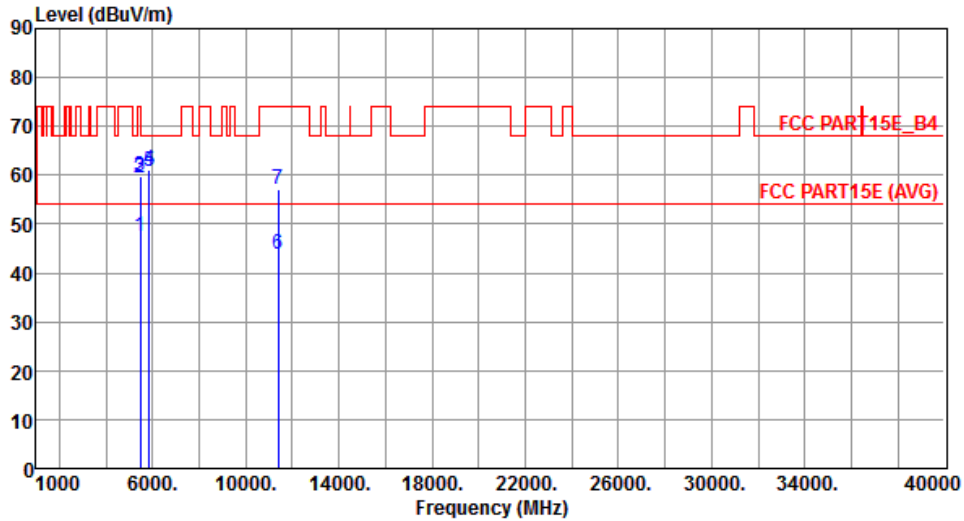

	Freq. MHz	Emission level dBuV/m	Limit dBuV/m	Margin dB	SA reading dBuV	Factor dB	Remark	ANT High cm	Turn Table deg
1	5460.00	47.48	54.00	-6.52	40.72	6.76	Average	208	127
2	5460.00	59.40	74.00	-14.60	52.64	6.76	Peak	208	127
3	5470.00	59.89	68.20	-8.31	53.12	6.77	Peak	208	127
4	5850.00	61.06	78.20	-17.14	53.56	7.50	Peak	208	127
5	5860.00	60.80	68.20	-7.40	53.29	7.51	Peak	208	127
6	11380.00	43.99	54.00	-10.01	27.13	16.86	Average	165	158
7	11380.00	57.12	74.00	-16.88	40.26	16.86	Peak	165	158

Note 1: Emission Level (dBuV/m) = SA Reading (dBuV/m) + Factor* (dB)

*Factor includes antenna factor , cable loss and amplifier gain

Note 2: Margin (dB) = Emission level (dBuV/m) – Limit (dBuV/m).

Modulation	VHT80	Test Freq. (MHz)	5775
Polarization	Horizontal		

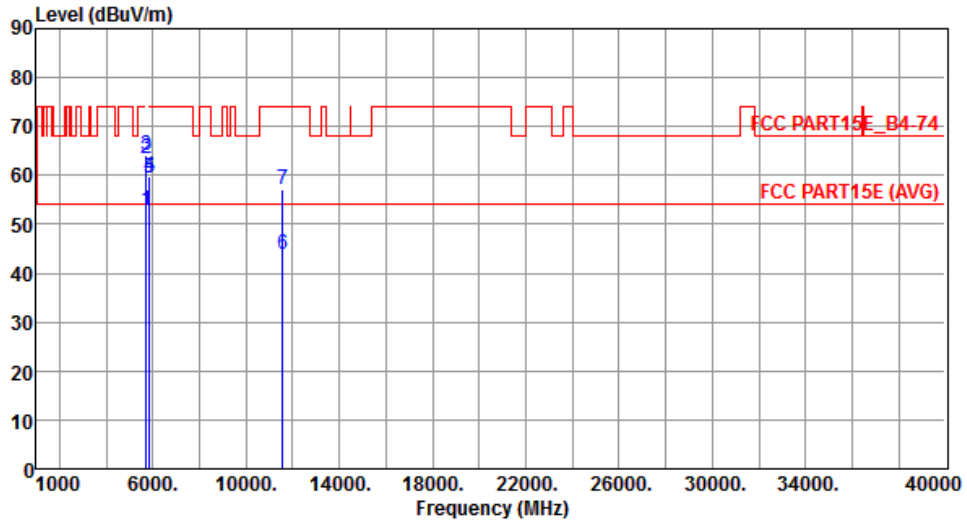

	Freq. MHz	Emission level dBuV/m	Limit dBuV/m	Margin dB	SA reading dBuV	Factor dB	Remark	ANT High cm	Turn Table deg
1	5715.00	52.94	54.00	-1.06	47.29	5.65	Average	101	115
2	5715.00	63.52	74.00	-10.48	57.87	5.65	Peak	101	115
3	5725.00	64.18	78.20	-14.02	58.54	5.64	Peak	101	115
4	5850.00	59.83	78.20	-18.37	54.08	5.75	Peak	101	115
5	5860.00	59.46	74.00	-14.54	53.70	5.76	Peak	101	115
6	11550.00	43.94	54.00	-10.06	28.13	15.81	Average	162	123
7	11550.00	57.15	74.00	-16.85	41.34	15.81	Peak	162	123

Note 1: Emission Level (dBuV/m) = SA Reading (dBuV/m) + Factor* (dB)

*Factor includes antenna factor , cable loss and amplifier gain

Note 2: Margin (dB) = Emission level (dBuV/m) – Limit (dBuV/m).

Modulation	VHT80	Test Freq. (MHz)	5775
Polarization	Vertical		

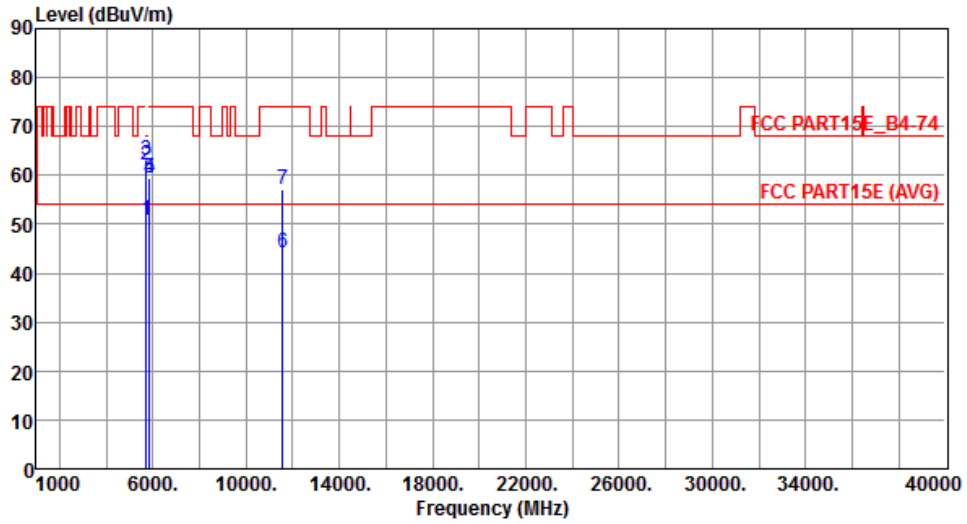

	Freq. MHz	Emission level dBuV/m	Limit dBuV/m	Margin dB	SA reading dBuV	Factor dB	Remark	ANT High cm	Turn Table deg
1	5715.00	50.91	54.00	-3.09	45.26	5.65	Average	200	236
2	5715.00	62.08	74.00	-11.92	56.43	5.65	Peak	200	236
3	5725.00	63.17	78.20	-15.03	57.53	5.64	Peak	200	236
4	5850.00	59.56	78.20	-18.64	53.81	5.75	Peak	200	236
5	5860.00	59.31	74.00	-14.69	53.55	5.76	Peak	200	236
6	11550.00	44.03	54.00	-9.97	28.22	15.81	Average	155	213
7	11550.00	57.15	74.00	-16.85	41.34	15.81	Peak	155	213

Note 1: Emission Level (dBuV/m) = SA Reading (dBuV/m) + Factor* (dB)

*Factor includes antenna factor , cable loss and amplifier gain

Note 2: Margin (dB) = Emission level (dBuV/m) – Limit (dBuV/m).

3.6 Frequency Stability

3.6.1 Limit of Frequency Stability

Manufacturers of U-NII devices are responsible for ensuring frequency stability such that an emission is maintained within the band of operation under all conditions of normal operation as specified in the user's manual.

3.6.2 Test Procedures

1. The EUT is installed in an environment test chamber with external power source.
2. Set the chamber to operate at 50 centigrade and external power source to output at nominal voltage of EUT.
3. A sufficient stabilization period at each temperature is used prior to each frequency measurement.
4. When temperature is stabled, measure the frequency stability.
5. The test shall be performed under -30 to 50 centigrade and 85 to 115 percent of the nominal voltage. Change setting of chamber and external power source to complete all conditions.

3.6.3 Test Setup

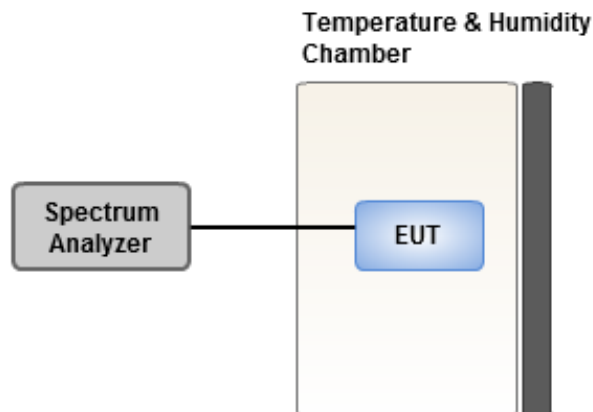

3.6.4 Test Result of Frequency Stability

Frequency: 5320 MHz	Frequency Drift (ppm)			
Temperature (°C)	0 minute	2 minutes	5 minutes	10 minutes
T20°C Vmax	-0.33	0.40	0.18	-0.31
T20°C Vmin	0.12	0.52	0.43	0.40
T60°C Vnom	0.38	0.28	0.96	0.42
T50°C Vnom	0.45	0.51	0.45	1.15
T40°C Vnom	0.94	1.49	1.16	1.23
T30°C Vnom	-0.09	0.00	0.13	-0.32
T20°C Vnom	1.13	1.61	1.52	1.05
T10°C Vnom	-0.10	0.45	-0.14	0.16
T0°C Vnom	-0.36	-0.05	0.04	0.22
T-10°C Vnom	0.00	-0.24	0.06	0.44
T-20°C Vnom	0.08	-0.03	0.92	0.19
T-30°C Vnom	0.14	-0.14	0.65	0.49
Vnom [Vac]: 120		Vmax [Vac]: 138		Vmin [Vac]: 102
Tnom [°C]: 20		Tmax [°C]: 60		Tmin [°C]: -30

Frequency: 5785 MHz	Frequency Drift (ppm)			
Temperature (°C)	0 minute	2 minutes	5 minutes	10 minutes
T20°C Vmax	4.75	4.81	5.36	5.29
T20°C Vmin	4.42	4.94	4.17	4.98
T60°C Vnom	3.62	3.71	3.60	4.05
T50°C Vnom	3.62	4.12	4.24	3.99
T40°C Vnom	2.77	2.87	3.17	2.98
T30°C Vnom	2.50	2.65	2.83	2.63
T20°C Vnom	2.49	2.53	2.71	2.07
T10°C Vnom	2.28	2.52	2.70	2.05
T0°C Vnom	1.55	1.94	1.77	2.29
T-10°C Vnom	0.78	0.69	1.03	0.84
T-20°C Vnom	0.63	0.90	1.18	0.37
T-30°C Vnom	0.61	0.87	1.15	0.34
Vnom [Vac]: 120		Vmax [Vac]: 138		Vmin [Vac]: 102
Tnom [°C]: 20		Tmax [°C]: 60		Tmin [°C]: -30

4 Test laboratory information

Established in 2012, ICC provides foremost EMC & RF Testing and advisory consultation services by our skilled engineers and technicians. Our services employ a wide variety of advanced edge test equipment and one of the widest certification extents in the business.

International Certification Corp, it is our definitive objective is to institute long term, trust-based associations with our clients. The expectation we set up with our clients is based on outstanding service, practical expertise and devotion to a certified value structure. Our passion is to grant our clients with best EMC / RF services by oriented knowledgeable and accommodating staff.

Our Test sites are located at Linkou District and Kwei Shan Hsiang. Location map can be found on our website <http://www.icertifi.com.tw>.

Linkou

Tel: 886-2-2601-1640

No. 30-2, Ding Fwu Tsuen, Lin Kou
District, New Taipei City, Taiwan,
R.O.C.

Kwei Shan

Tel: 886-3-271-8666

No. 3-1, Lane 6, Wen San 3rd
St., Kwei Shan Hsiang, Tao Yuan
Hsien 333, Taiwan, R.O.C.

Kwei Shan Site II

Tel: 886-3-271-8640

No. 14-1, Lane 19, Wen San 3rd
St., Kwei Shan Hsiang, Tao Yuan
Hsien 333, Taiwan, R.O.C.

If you have any suggestion, please feel free to contact us as below information

Tel: 886-3-271-8666

Fax: 886-3-318-0155

Email: ICC_Service@icertifi.com.tw

==END==