



# FCC RF Test Report

**APPLICANT** : Motorola Mobility LLC  
**EQUIPMENT** : Mobile Cellular Phone  
**BRAND NAME** : Motorola  
**MODEL NAME** : XT1926-6, XT1926-7  
**FCC ID** : IHDT56WL4  
**STANDARD** : FCC Part 15 Subpart E §15.407  
**CLASSIFICATION** : (NII) Unlicensed National Information Infrastructure

The product was received on Dec. 27, 2017 and testing was completed on Jan. 22, 2018. We, Sporton International (Kunshan) Inc., would like to declare that the tested sample has been evaluated in accordance with the test procedures and has been in compliance with the applicable technical standards.

The test results in this report apply exclusively to the tested model / sample. Without written approval of Sporton International (Kunshan) Inc., the test report shall not be reproduced except in full.



Approved by: James Huang / Manager

**Sporton International (Kunshan) Inc.**  
**No.3-2 Ping-Xiang Rd, Kunshan Development Zone Kunshan City Jiangsu Province 215335**  
**China**



# TABLE OF CONTENTS

**1 GENERAL DESCRIPTION ..... 5**

1.1 Applicant ..... 5

1.2 Manufacturer ..... 5

1.3 Product Feature of Equipment Under Test ..... 5

1.4 Product Specification of Equipment Under Test ..... 6

1.5 Specification of Accessory ..... 8

1.6 Modification of EUT ..... 9

1.7 Testing Location ..... 9

1.8 Applicable Standards ..... 10

**2 TEST CONFIGURATION OF EQUIPMENT UNDER TEST ..... 11**

2.1 Carrier Frequency Channel ..... 11

2.2 Test Mode ..... 13

2.3 Connection Diagram of Test System ..... 15

2.4 Support Unit used in test configuration and system ..... 16

2.5 EUT Operation Test Setup ..... 16

2.6 Measurement Results Explanation Example ..... 17

**3 TEST RESULT ..... 18**

3.1 26dB & 99% Occupied Bandwidth Measurement ..... 18

3.2 Maximum Conducted Output Power Measurement ..... 20

3.3 Power Spectral Density Measurement ..... 22

3.4 Unwanted Radiated Emission Measurement ..... 25

3.5 AC Conducted Emission Measurement ..... 31

3.6 Automatically Discontinue Transmission ..... 35

3.7 Antenna Requirements ..... 36

**4 LIST OF MEASURING EQUIPMENTS ..... 37**

**5 UNCERTAINTY OF EVALUATION ..... 38**

**APPENDIX A. CONDUCTED TEST RESULTS**

**APPENDIX B. RADIATED SPURIOUS EMISSION**

**APPENDIX C. DUTY CYCLE PLOTS**

**APPENDIX D. SETUP PHOTOGRAPHS**





### SUMMARY OF TEST RESULT

Report Section	FCC Rule	Description	Limit	Result	Remark
3.1	2.1049 15.403(i)	26dB & 99% Bandwidth	-	Pass	-
3.2	15.407(a)	Maximum Conducted Output Power	FCC ≤ 24 dBm (depend on band)	Pass	-
3.3	15.407(a)	Power Spectral Density	FCC ≤ 11 dBm (depend on band)	Pass	-
3.4	15.407(b)	Unwanted Emissions	15.407(b) 15.209(a)	Pass	Under limit 3.03 dB at 5350.320 MHz
3.5	15.207	AC Conducted Emission	15.207(a)	Pass	Under limit 13.94 dB at 0.195 MHz
3.6	15.407(c)	Automatically Discontinue Transmission	Discontinue Transmission	Pass	-
3.7	15.203 & 15.407(a)	Antenna Requirement	N/A	Pass	-



# 1 General Description

## 1.1 Applicant

Motorola Mobility LLC  
222 W, Merchandise Mart Plaza, Chicago IL 60654 USA

## 1.2 Manufacturer

Motorola Mobility LLC  
222 W, Merchandise Mart Plaza, Chicago IL 60654 USA

## 1.3 Product Feature of Equipment Under Test

Product Feature	
Equipment	Mobile Cellular Phone
Brand Name	Motorola
Model Name	XT1926-6, XT1926-7
FCC ID	IHDT56WL4
EUT supports Radios application	GSM/GPRS/EGPRS/WCDMA/HSPA/DC-HSDPA /HSPA+/LTE/NFC WLAN 2.4GHz 802.11b/g/n HT20 WLAN 5GHz 802.11a/n HT20/HT40 WLAN 5GHz 802.11ac VHT20/VHT40/VHT80 Bluetooth v3.0+EDR/ Bluetooth v4.0 LE/ Bluetooth v4.1 LE/Bluetooth v4.2 LE/ Bluetooth v5.0 LE
IMEI Code	Conducted: 351853090015717/351853090015725 Conduction: N/A Radiation: 351853090016053/351853090016061
HW Version	DVT1B
SW Version	evert_n-userdebug 8.0.0 OPW27.88 1825 intcfg,test-keys
EUT Stage	Identical Prototype

**Remark:**

1. The above EUT's information was declared by manufacturer. Please refer to the specifications or user's manual for more detailed description.
2. There are two types of EUT sample 1 and sample 2, the differences between two samples are only for SIM slot, sample 1(Model name: XT1926-7) is dual SIM slot, sample 2(Model name: XT1926-6) is single SIM slot. We only choose dual SIM sample to perform full test.



### 1.4 Product Specification of Equipment Under Test

Standards-related Product Specification	
<b>Tx/Rx Frequency Range</b>	5180 MHz ~ 5240 MHz 5260 MHz ~ 5320 MHz 5500 MHz ~ 5700 MHz
<b>Maximum Output Power to Antenna</b>	<p><b>&lt;5180 MHz ~ 5240 MHz&gt;</b>  802.11a : 15.98 dBm / 0.0396 W  802.11n HT20 : 15.86 dBm / 0.0385 W  802.11n HT40 : 13.26 dBm / 0.0212 W  802.11ac VHT20 : 15.81 dBm / 0.0381 W  802.11ac VHT40 : 13.22 dBm / 0.0210 W  802.11ac VHT80 : 11.79 dBm / 0.0151 W</p> <p><b>&lt;5260 MHz ~ 5320 MHz&gt;</b>  802.11a : 15.89 dBm / 0.0388 W  802.11n HT20 : 15.81 dBm / 0.0381 W  802.11n HT40 : 13.12 dBm / 0.0205 W  802.11ac VHT20 : 15.71 dBm / 0.0372 W  802.11ac VHT40 : 13.09 dBm / 0.0204 W  802.11ac VHT80 : 10.92 dBm / 0.0124 W</p> <p><b>&lt;5500 MHz ~ 5700 MHz &gt;</b>  802.11a : 16.06 dBm / 0.0404 W  802.11n HT20 : 15.97 dBm / 0.0395 W  802.11n HT40 : 13.14 dBm / 0.0206 W  802.11ac VHT20 : 15.95 dBm / 0.0394 W  802.11ac VHT40 : 11.34 dBm / 0.0136 W  802.11ac VHT80 : 12.41 dBm / 0.0174 W</p>
<b>99% Occupied Bandwidth</b>	<p><b>&lt;5180 MHz ~ 5240 MHz&gt;</b>  802.11a : 17.53 MHz  802.11n HT20 : 18.88 MHz  802.11n HT40 : 36.56 MHz  802.11ac VHT80 : 75.76 MHz</p> <p><b>&lt;5260 MHz ~ 5320 MHz &gt;</b>  802.11a : 17.53 MHz  802.11n HT20 : 18.73 MHz  802.11n HT40 : 36.56 MHz  802.11ac VHT80 : 75.76 MHz</p> <p><b>&lt;5500 MHz ~ 5700 MHz &gt;</b>  802.11a : 17.58 MHz  802.11n HT20 : 18.83 MHz  802.11n HT40 : 36.56 MHz  802.11ac VHT80 : 75.88 MHz</p>



<b>Antenna Gain / Gain</b>	<5180 MHz ~ 5240 MHz> PIFA Antenna with gain -1.4 dBi <5260 MHz ~ 5320 MHz> PIFA Antenna with gain -1.6 dBi <5500 MHz ~ 5700 MHz> PIFA Antenna with gain -0.9 dBi
<b>Type of Modulation</b>	802.11a/n : OFDM (BPSK / QPSK / 16QAM / 64QAM) 802.11ac : OFDM (BPSK / QPSK / 16QAM / 64QAM / 256QAM)

**Note:** For 802.11n HT20 / ac VHT20 and 802.11n HT40 / ac VHT40 mode, the whole testing has assessed only 802.11an HT20/ HT40 by referring to their maximum conducted power.



### 1.5 Specification of Accessory

Specification of Accessory				
AC Adapter 1(US)	Brand Name	Motorola (Salom)	Model Name	SC-22
	Power Rating	I/P: 100-240 Vac, 500mA, O/P: 5Vdc,3000mA or 9Vdc,1600mA or 12Vdc,1200mA		
AC Adapter 1(EU)	Brand Name	Motorola (Salom)	Model Name	SC-23
	Power Rating	I/P: 100-240 Vac, 500mA, O/P: 5Vdc,3000mA or 9Vdc,1600mA or 12Vdc,1200mA		
AC Adapter 1(UK)	Brand Name	Motorola (Salom)	Model Name	SC-24
	Power Rating	I/P: 100-240 Vac, 500mA, O/P: 5Vdc,3000mA or 9Vdc,1600mA or 12Vdc,1200mA		
AC Adapter 1(IN)	Brand Name	Motorola (Salom)	Model Name	SC-25
	Power Rating	I/P: 100-240 Vac, 500mA, O/P: 5Vdc,3000mA or 9Vdc,1600mA or 12Vdc,1200mA		
AC Adapter 1(AU)	Brand Name	Motorola (Salom)	Model Name	SC-26
	Power Rating	I/P: 100-240 Vac, 500mA, O/P: 5Vdc,3000mA or 9Vdc,1600mA or 12Vdc,1200mA		
AC Adapter 1(AR)	Brand Name	Motorola (Salom)	Model Name	SC-27
	Power Rating	I/P: 100-240 Vac, 500mA, O/P: 5Vdc,3000mA or 9Vdc,1600mA or 12Vdc,1200mA		
AC Adapter 2(US)	Brand Name	Motorola (Chenyang)	Model Name	SC-22
	Power Rating	I/P: 100-240 Vac, 500mA, O/P: 5Vdc,3000mA or 9Vdc,1600mA or 12Vdc,1200mA		
AC Adapter 2(EU)	Brand Name	Motorola (Chenyang)	Model Name	SC-23
	Power Rating	I/P: 100-240 Vac, 500mA, O/P: 5Vdc,3000mA or 9Vdc,1600mA or 12Vdc,1200mA		
AC Adapter 2(UK)	Brand Name	Motorola (Chenyang)	Model Name	SC-24
	Power Rating	I/P: 100-240 Vac, 500mA, O/P: 5Vdc,3000mA or 9Vdc,1600mA or 12Vdc,1200mA		
AC Adapter 2(IN)	Brand Name	Motorola (Chenyang)	Model Name	SC-25
	Power Rating	I/P: 100-240 Vac, 500mA, O/P: 5Vdc,3000mA or 9Vdc,1600mA or 12Vdc,1200mA		
AC Adapter 2(AU)	Brand Name	Motorola (Chenyang)	Model Name	SC-26
	Power Rating	I/P: 100-240 Vac, 500mA, O/P: 5Vdc,3000mA or 9Vdc,1600mA or 12Vdc,1200mA		
AC Adapter 2(AR)	Brand Name	Motorola (chenyang)	Model Name	SC-27
	Power Rating	I/P: 100-240 Vac, 500mA, O/P: 5Vdc,3000mA or 9Vdc,1600mA or 12Vdc,1200mA		
Battery	Brand Name	Motorola (ATL)	Model Name	JT40
	Power Rating	3.8Vdc,3200mAh	Type	Li-ion Polymer
Earphone 1	Brand Name	Motorola (Jiahe)	Model Name	LS-118M-12
	Signal Line Type	1.2 meter, non-shielded cable, without ferrite core		
Earphone 2	Brand Name	Motorola (Lianyun)	Model Name	TS910A-38AMS01WHR-M
	Signal Line Type	1.2 meter, non-shielded cable, without ferrite core		
USB Cable	Brand Name	Motorola (Liqi)	Model Name	L32B-053000100-ALL
	Signal Line Type	1.0 meter, shielded cable, without ferrite core		



### 1.6 Modification of EUT

No modifications are made to the EUT during all test items.

### 1.7 Testing Location

Sporton International (Kunshan) Inc. is accredited to ISO 17025 by National Voluntary Laboratory Accreditation Program (NVLAP code: 600155-0) and the FCC designation No. is CN5013.

<b>Test Site</b>	Sporton International (Kunshan) Inc.		
<b>Test Site Location</b>	No.3-2 Ping-Xiang Rd, Kunshan Development Zone Kunshan City Jiangsu Province 215335 China TEL : +86-512-57900158 FAX : +86-512-57900958		
<b>Test Site No.</b>	<b>Sporton Site No.</b>		<b>FCC Test Firm Registration No.</b>
	TH01-KS	CO01-KS	630927

**Note:** The test site complies with ANSI C63.4 2014 requirement.

Sporton International (Shenzhen) Inc. is accredited to ISO 17025 by National Voluntary Laboratory Accreditation Program (NVLAP code: 600156-0) and the FCC designation No is CN5019.

<b>Test Site</b>	Sporton International (Shenzhen) Inc.		
<b>Test Site Location</b>	No. 3 Bldg the third floor of south, Shahe River west, Fengzeyuan Warehouse, Nanshan District Shenzhen City Guangdong Province 518055 China TEL: +86-755-3320-2398		
<b>Test Site No.</b>	<b>Sporton Site No.</b>		<b>FCC Test Firm Registration No.</b>
	03CH01-SZ		577730

**Note:** The test site complies with ANSI C63.4 2014 requirement.



## 1.8 Applicable Standards

According to the specifications of the manufacturer, the EUT must comply with the requirements of the following standards:

- ♦ FCC Part 15 Subpart E
- ♦ FCC KDB 789033 D02 General UNII Test Procedures New Rules v02r01
- ♦ ANSI C63.10-2013

### **Remark:**

1. All test items were verified and recorded according to the standards and without any deviation during the test.
2. This EUT has also been tested and complied with the requirements of FCC Part 15, Subpart B, recorded in a separate test report.



## 2 Test Configuration of Equipment Under Test

The EUT has been associated with peripherals and configuration operated in a manner tended to maximize its emission characteristics in a typical application. Frequency range investigated: conducted emission (150 kHz to 30 MHz) and radiated emission (9 kHz to the 10th harmonic of the highest fundamental frequency or to 40 GHz, whichever is lower). For radiated measurement, pre-scanned in three orthogonal panels, X, Y, Z. The worst cases were recorded in this report.

### 2.1 Carrier Frequency Channel

Frequency Band	Channel	Freq. (MHz)	Channel	Freq. (MHz)
5180-5240 MHz Band 1 (U-NII-1)	36	5180	44	5220
	38*	5190	46*	5230
	40	5200	48	5240
	42#	5210	-	-

Frequency Band	Channel	Freq. (MHz)	Channel	Freq. (MHz)
5260-5320 MHz Band 2 (U-NII-2A)	52	5260	60	5300
	54*	5270	62*	5310
	56	5280	64	5320
	58#	5290		

Frequency Band	Channel	Freq. (MHz)	Channel	Freq. (MHz)
5500-5700 MHz Band 3 (U-NII-2C)	100	5500	112	5560
	102*	5510	116	5580
	104	5520	132	5660
	106#	5530	134*	5670
	108	5540	136	5680
	110*	5550	140	5700



Frequency Band	Channel	Freq. (MHz)	Channel	Freq. (MHz)
TDWR Channel	118*	5590	124	5620
	120	5600	126*	5630
	122#	5610	128	5640

**Note:**

1. The above Frequency and Channel in "\*" were 802.11n HT40 and 802.11ac VHT40.
2. The above Frequency and Channel in "#" were 802.11ac VHT80.



## 2.2 Test Mode

Final test mode of conducted test items and radiated spurious emissions are considering the modulation and worse data rates as below table.

Modulation	Data Rate
802.11a	6 Mbps
802.11n HT20	MCS0
802.11n HT40	MCS0
802.11ac VHT80	MCS0

Test Cases	
AC Conducted Emission	Mode 1 : GSM850 Idle + Bluetooth Link + WLAN Link (5G) + USB Cable (Charging from Adapter 1) + Earphone 1
<b>Remark:</b> For Radiated Test Cases, The tests were performed with Earphone 1, Adapter 1 and USB Cable.	



Ch. #		Band I : 5180-5240 MHz	Band II : 5260-5320 MHz	Band III : 5500-5700MHz
		802.11a	802.11a	802.11a
L	Low	36	52	100
M	Middle	44	60	116
H	High	48	64	140

Ch. #		Band I : 5180-5240 MHz	Band II : 5260-5320 MHz	Band III : 5500-5700MHz
		802.11n HT20	802.11n HT20	802.11n HT20
L	Low	36	52	100
M	Middle	44	60	116
H	High	48	64	140

Ch. #		Band I : 5180-5240 MHz	Band II : 5260-5320 MHz	Band III : 5500-5700MHz
		802.11n HT40	802.11n HT40	802.11n HT40
L	Low	38	54	102
M	Middle	-	-	110
H	High	46	62	134

Ch. #		Band I : 5180-5240 MHz	Band II : 5260-5320 MHz	Band III : 5500-5700MHz
		802.11ac VHT20	802.11ac VHT20	802.11ac VHT20
L	Low	36	52	100
M	Middle	44	60	116
H	High	48	64	140

Ch. #		Band I : 5180-5240 MHz	Band II : 5260-5320 MHz	Band III : 5500-5700MHz
		802.11ac VHT40	802.11ac VHT40	802.11ac VHT40
L	Low	38	54	102
M	Middle	-	-	110
H	High	46	62	134

Ch. #		Band I : 5180-5240 MHz	Band II : 5260-5320 MHz	Band III : 5500-5700MHz
		802.11ac VHT80	802.11ac VHT80	802.11ac VHT80
L	Low	-	-	106
M	Middle	42	58	-
H	High	-	-	122

## 2.3 Connection Diagram of Test System

### < Radiated Emission Mode >

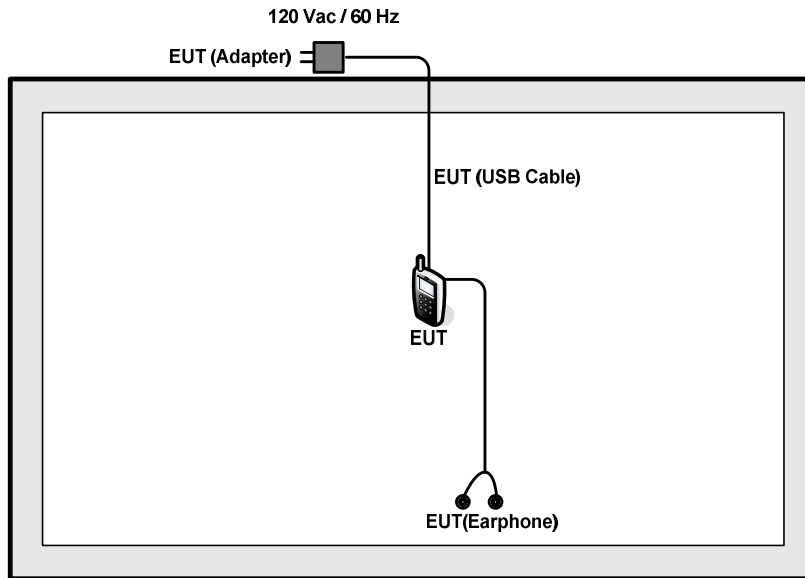

### < AC Conducted Emission Mode >

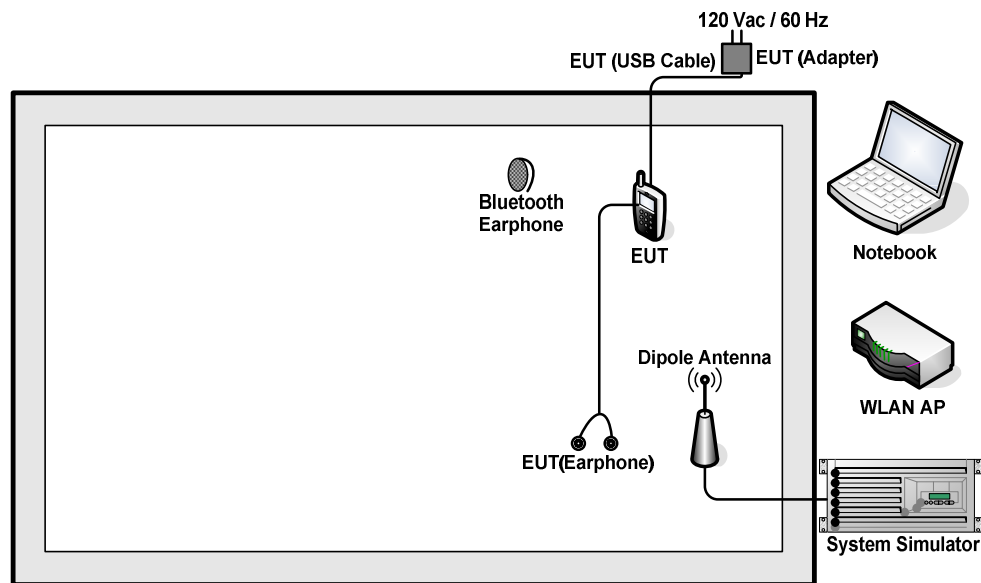



## 2.4 Support Unit used in test configuration and system

Item	Equipment	Trade Name	Model Name	FCC ID	Data Cable	Power Cord
1.	System Simulator	R&S	CMU 200	N/A	N/A	Unshielded, 1.8 m
2.	WLAN AP	D-Link	DIR-855	KA2DIR855A2	N/A	Unshielded, 1.8 m
3.	Notebook	Lenovo	G480	N/A	N/A	AC I/P: Unshielded, 1.8 m DC O/P: Shielded, 1.8 m
4.	Bluetooth Earphone	Lenovo	LBH308	N/A	N/A	N/A

## 2.5 EUT Operation Test Setup

For WLAN RF test items, an engineering test program was provided and enabled to make EUT continuously transmit/receive.

For AC power line conducted emissions, the EUT was set to connect with the WLAN AP under large package sizes transmission.



## 2.6 Measurement Results Explanation Example

For all conducted test items:

The offset level is set in the spectrum analyzer to compensate the RF cable loss between EUT conducted output port and spectrum analyzer. With the offset compensation, the spectrum analyzer reading level is exactly the EUT RF output level.

Example :

The spectrum analyzer offset is derived from RF cable loss.

*Offset = RF cable loss.*

Following shows an offset computation example with cable loss 6.9 dB.

$$\begin{aligned} \text{Offset(dB)} &= \text{RF cable loss(dB)}. \\ &= 6.9 \text{ (dB)} \end{aligned}$$

### 3 Test Result

#### 3.1 26dB & 99% Occupied Bandwidth Measurement

##### 3.1.1 Description of 26dB & 99% Occupied Bandwidth

This section is for reporting purpose only.

There is no restriction limits for bandwidth.

##### 3.1.2 Measuring Instruments

The measuring equipment is listed in the section 4 of this test report.

##### 3.1.3 Test Procedures

1. The testing follows FCC KDB 789033 D02 General UNII Test Procedures New Rules v02r01.  
Section C) Emission bandwidth
2. Set RBW = approximately 1% of the emission bandwidth.
3. Set the VBW > RBW.
4. Detector = Peak.
5. Trace mode = max hold
6. Measure the maximum width of the emission that is 26 dB down from the peak of the emission.  
Compare this with the RBW setting of the analyzer. Readjust RBW and repeat measurement as needed until the RBW/EBW ratio is approximately 1%.
7. For 99% Bandwidth Measurement, the spectrum analyzer's resolution bandwidth (RBW) is set 1MHz and set the Video bandwidth (VBW)  $\geq 3 * RBW$ .
8. Measure and record the results in the test report.

##### 3.1.4 Test Setup

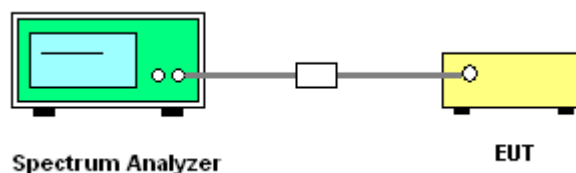



### 3.1.5 Test Result of 26dB & 99% Occupied Bandwidth Plots

Please refer to Appendix A.

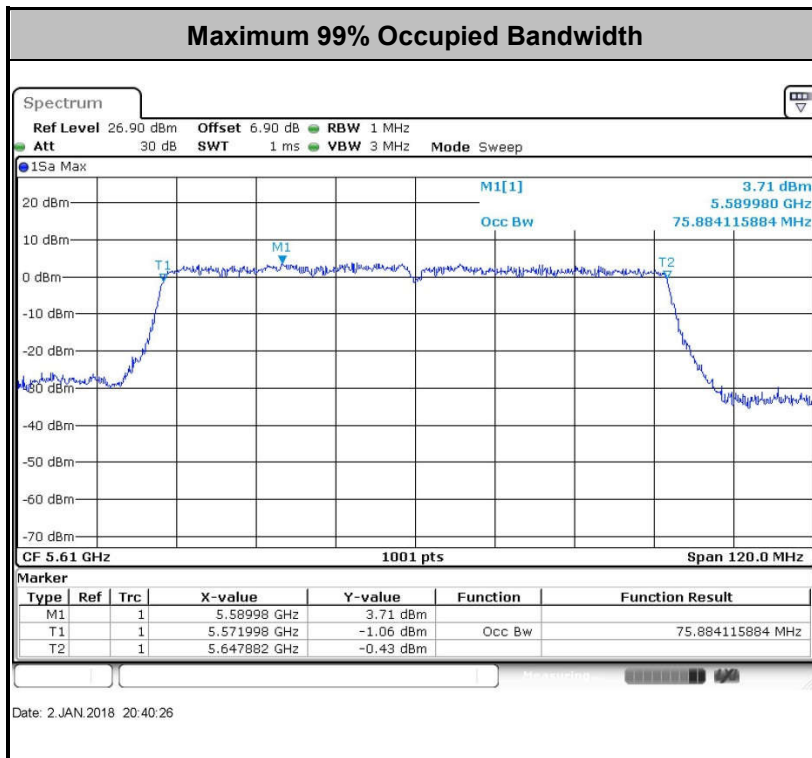
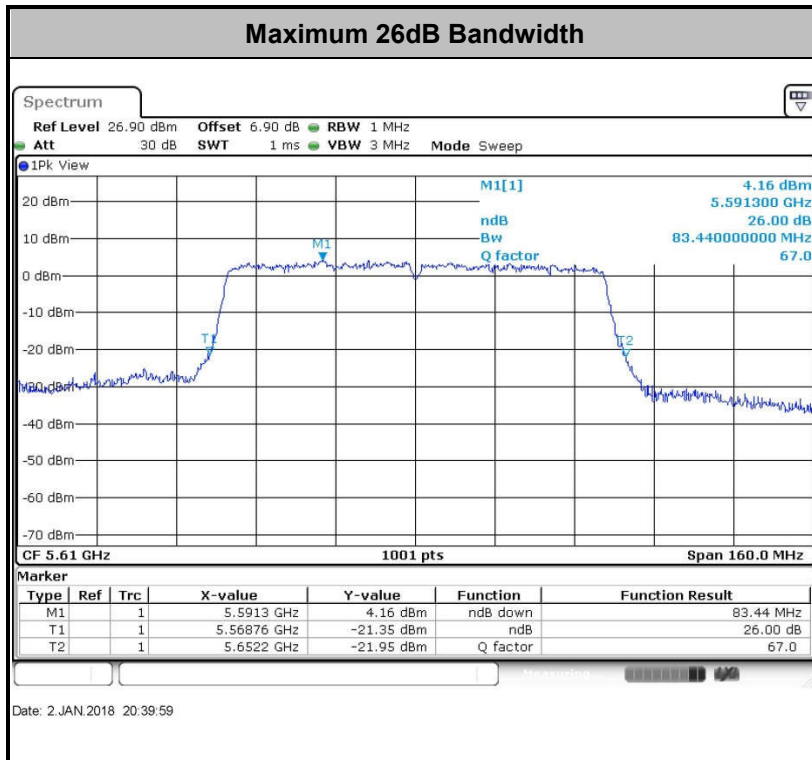

Note : The occupied channel bandwidth is maintained within the band of operation for all of the modulations.



## 3.2 Maximum Conducted Output Power Measurement

### 3.2.1 Limit of Maximum Conducted Output Power

#### <FCC 14-30 CFR 15.407>

For mobile and portable client devices in the 5.15–5.25 GHz band, the maximum conducted output power over the frequency band of operation shall not exceed 250 mW.

For the 5.25–5.725 GHz bands, the maximum conducted output power over the frequency bands of operation shall not exceed the lesser of 250 mW or  $11 \text{ dBm} + 10 \log B$ , where B is the 26 dB emission bandwidth in megahertz.

If transmitting antennas of directional gain greater than 6 dBi are used, the peak output power shall be reduced by the amount in dB that the directional gain of the antenna exceeds 6 dBi.

Note that U-NII-2 band, devices with a maximum e.i.r.p. greater than 500 mW shall implement TPC in order to have the capability to operate at least 6 dB below the maximum permitted e.i.r.p. of 1 W.

### 3.2.2 Measuring Instruments

The measuring equipment is listed in the section 4 of this test report.

### 3.2.3 Test Procedures

The testing follows Method PM of FCC KDB 789033 D02 General UNII Test Procedures New Rules v02r01.

Method PM (Measurement using an RF average power meter):

1. Measurement is performed using a wideband RF power meter.
2. The EUT is configured to transmit continuously with a consistent duty cycle at its maximum power control level.
3. Measure the average power of the transmitter, and the average power is corrected with duty factor,  $10 \log(1/x)$ , where  $x$  is the duty cycle.

### 3.2.4 Test Setup

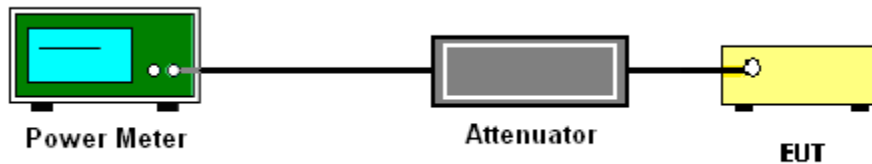

### 3.2.5 Test Result of Maximum Conducted Output Power

Please refer to Appendix A.



### 3.3 Power Spectral Density Measurement

#### 3.3.1 Limit of Power Spectral Density

<FCC 14-30 CFR 15.407>

For mobile and portable client devices in the 5.15–5.25 GHz band, the maximum power spectral density shall not exceed 11dBm in any 1 megahertz band.

For the 5.25–5.725 GHz bands, the maximum power spectral density shall not exceed 11 dBm in any 1 megahertz band.

If transmitting antennas of directional gain greater than 6 dBi are used, the peak output power shall be reduced by the amount in dB that the directional gain of the antenna exceeds 6 dBi.

#### 3.3.2 Measuring Instruments

The measuring equipment is listed in the section 4 of this test report.

### 3.3.3 Test Procedures

The testing follows FCC KDB 789033 D02 General UNII Test Procedures New Rules v02r01.  
Section F) Maximum power spectral density.

#### # Method SA-2 #

(trace averaging across on and off times of the EUT transmissions, followed by duty cycle correction).

1. The testing follows Method SA-2 of FCC KDB 789033 D02 General UNII Test Procedures New Rules v02r01.
  - Measure the duty cycle.
  - Set span to encompass the entire emission bandwidth (EBW) of the signal.
  - Set RBW = 1 MHz.
  - Set VBW  $\geq$  3 MHz.
  - Number of points in sweep  $\geq$  2 Span / RBW.
  - Sweep time = auto.
  - Detector = RMS
  - Trace average at least 100 traces in power averaging mode.
  - Add  $10 \log(1/x)$ , where  $x$  is the duty cycle, to the measured power in order to compute the average power during the actual transmission times. For example, add  $10 \log(1/0.25) = 6$  dB if the duty cycle is 25 percent.
2. The RF output of EUT was connected to the spectrum analyzer by a low loss cable.
3. Each plot has already offset with cable loss, and attenuator loss. Measure the PPSD and record it.

### 3.3.4 Test Setup

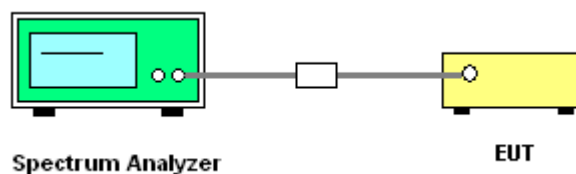





### 3.4 Unwanted Radiated Emission Measurement

This section is to measure unwanted emissions through radiated measurement for band edge spurious emissions and out of band emissions measurement.

#### 3.4.1 Limit of Unwanted Emissions

- (1) For transmitters operating in the 5150-5250 MHz band: all emissions outside of the 5150-5350 MHz band shall not exceed an EIRP of -27dBm/MHz.

For transmitters operating in the 5250-5350 MHz band: all emissions outside of the 5150-5350 MHz band shall not exceed an EIRP of -27 dBm/MHz. Devices operating in the 5250-5350 MHz band that generate emissions in the 5150-5250 MHz band must meet all applicable technical requirements for operation in the 5150-5250 MHz band (including indoor use) or alternatively meet an out-of-band emission EIRP limit of -27 dBm/MHz in the 5150-5250 MHz band.

For transmitters operating in the 5470-5725MHz band: all emissions outside of the 5470-5725MHz band shall not exceed an EIRP of -27 dBm/MHz.

- (2) Unwanted spurious emissions fallen in restricted bands shall comply with the general field strength limits as below table,

Frequency (MHz)	Field Strength (microvolts/meter)	Measurement Distance (meters)
0.009 – 0.490	2400/F(kHz)	300
0.490 – 1.705	24000/F(kHz)	30
1.705 – 30.0	30	30
30 – 88	100	3
88 – 216	150	3
216 - 960	200	3
Above 960	500	3

**Note:** The following formula is used to convert the EIRP to field strength.

$$E = \frac{1000000\sqrt{30P}}{3} \text{ } \mu\text{V/m, where P is the eirp (Watts)}$$



EIRP (dBm)	Field Strength at 3m (dBμV/m)
- 27	68.3

(3) KDB789033 D01 v02r01 G)2)c)

- (i) Section 15.407(b)(1) to (b)(3) specify the unwanted emission limits for the U-NII-1 and U-NII-2 bands. As specified, emissions above 1000 MHz that are outside of the restricted bands are subject to a peak emission limit of -27 dBm/MHz.<sup>3</sup>
- (ii) Section 15.407(b)(4) specifies the unwanted emission limit for the U-NII-3 band. A band emissions mask is specified in Section 15.407(b)(4)(i). The emission limits are in terms of a Peak detector. An alternative to the band emissions mask is specified in Section 15.407(b)(4)(ii). The alternative limits are based on the highest antenna gain specified in the filing. There are also marketing and importation restrictions for the devices using the alternative limit.<sup>4</sup>

**Note 3:** An out-of-band emission that complies with both the average and peak limits of Section 15.209 is not required to satisfy the -27 dBm/MHz peak emission limit.

**Note 4:** Only devices with antenna gains of 10 dBi or less may be approved using the emission limits specified in Section 15.247(d) till March 2, 2018; all other devices operating in this band must use the mask specified in Section 15.407(b)(4)(i).



### 3.4.2 Measuring Instruments

The measuring equipment is listed in the section 4 of this test report.

### 3.4.3 Test Procedures

1. The testing follows FCC KDB 789033 D02 General UNII Test Procedures New Rules v02r01. Section G) Unwanted emissions measurement.

(1) Procedure for Unwanted Emissions Measurements Below 1000MHz

- RBW = 120 kHz
- VBW = 300 kHz
- Detector = Peak
- Trace mode = max hold

(2) Procedure for Peak Unwanted Emissions Measurements Above 1000 MHz

- RBW = 1 MHz
- VBW  $\geq$  3 MHz
- Detector = Peak
- Sweep time = auto
- Trace mode = max hold

(3) Procedures for Average Unwanted Emissions Measurements Above 1000MHz

- RBW = 1 MHz
- VBW = 10 Hz, when duty cycle is no less than 98 percent.
- VBW  $\geq$  1/T, when duty cycle is less than 98 percent where T is the minimum transmission duration over which the transmitter is on and is transmitting at its maximum power control level for the tested mode of operation.



2. The EUT was placed on a turntable with 0.8 meter for frequency below 1GHz and 1.5 meter for frequency above 1GHz respectively above ground.
3. The EUT was set 3 meters from the interference receiving antenna which was mounted on the top of a variable height antenna tower.
4. The antenna is a broadband antenna and its height is adjusted between one meter and four meters above ground to find the maximum value of the field strength for both horizontal polarization and vertical polarization of the antenna.
5. For each suspected emission, the EUT was arranged to its worst case and then adjust the antenna tower (from 1 m to 4 m) and turntable (from 0 degree to 360 degrees) to find the maximum reading.
6. For testing below 1GHz, if the emission level of the EUT in peak mode was 3 dB lower than the limit specified, then peak values of EUT will be reported, otherwise, the emissions will be repeated one by one using the CISPR quasi-peak method and reported.
7. For testing above 1GHz, the emission level of the EUT in peak mode was 20dB lower than average limit (that means the emission level in average mode also complies with the limit in average mode), then peak values of EUT will be reported, otherwise, the emissions will be measured in average mode again and reported.

### 3.4.4 Test Setup

For radiated emissions below 30MHz

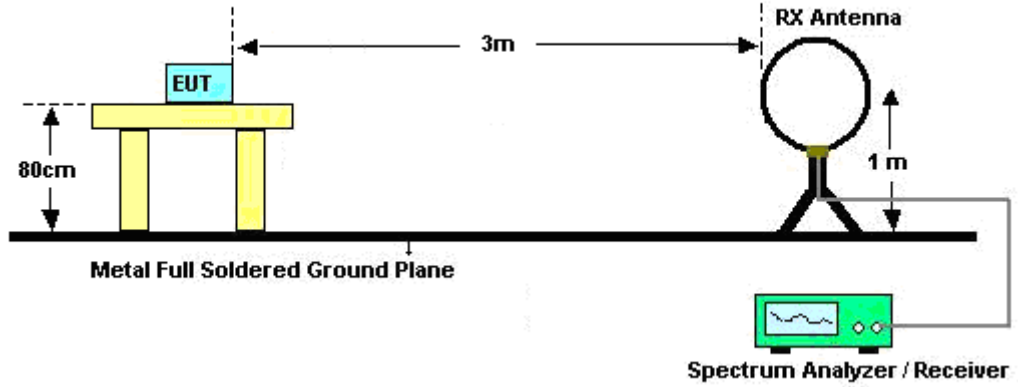

For radiated emissions from 30MHz to 1GHz

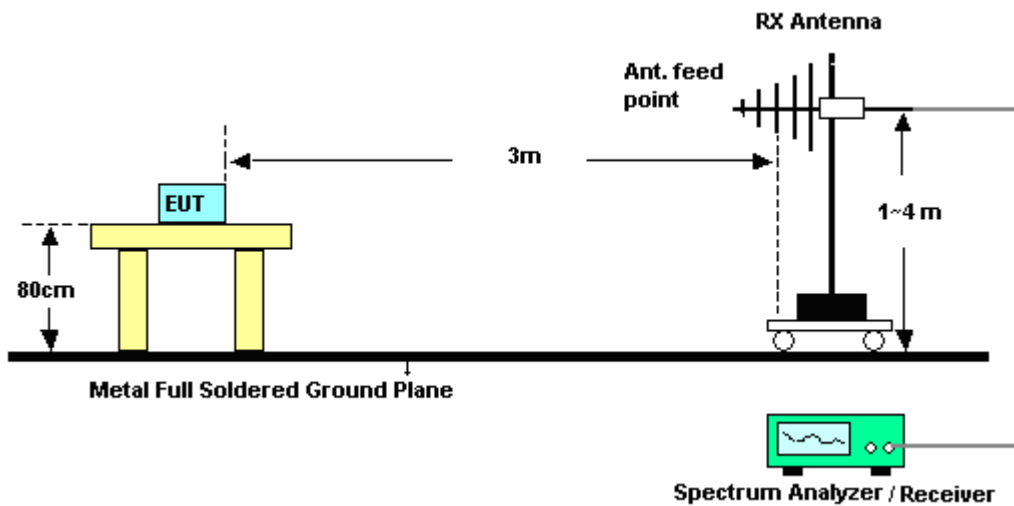

For radiated emissions above 1GHz

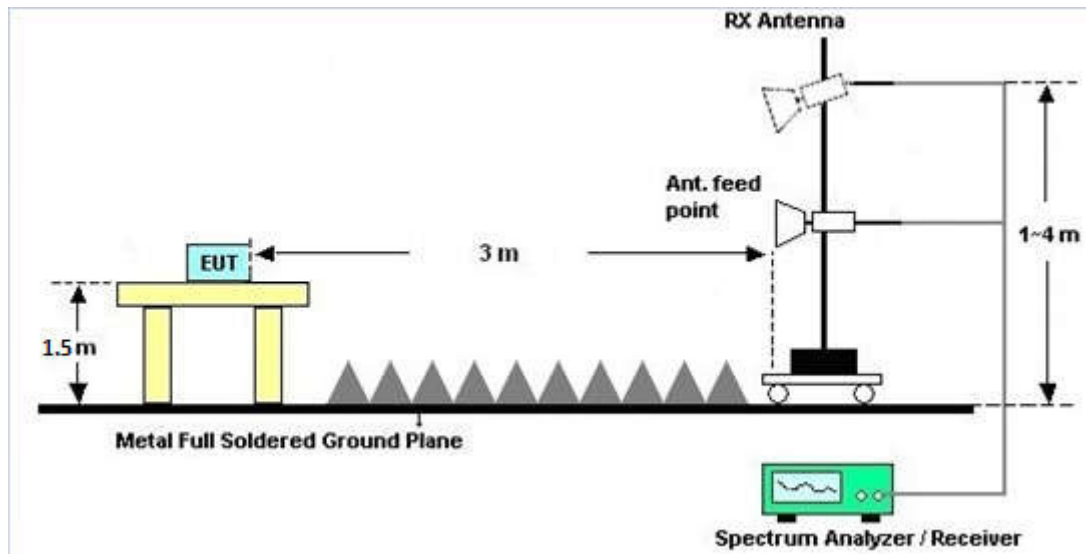

### 3.4.5 Test Results of Radiated Spurious Emissions (9 kHz ~ 30 MHz)

The low frequency, which started from 9 kHz to 30MHz, was pre-scanned and the result which was 20dB lower than the limit line was not reported.

### 3.4.6 Test Result of Radiated Spurious at Band Edges

Please refer to Appendix B.

### 3.4.7 Duty Cycle

Please refer to Appendix C.

### 3.4.8 Test Result of Radiated Spurious Emission (30MHz ~ 10th Harmonic)

Please refer to Appendix B.



### 3.5 AC Conducted Emission Measurement

#### 3.5.1 Limit of AC Conducted Emission

For equipment that is designed to be connected to the public utility (AC) power line, the radio frequency voltage that is conducted back onto the AC power line on any frequency or frequencies within the band 150 kHz to 30 MHz shall not exceed the limits in the following table.

Frequency of emission (MHz)	Conducted limit (dBµV)	
	Quasi-peak	Average
0.15-0.5	66 to 56*	56 to 46*
0.5-5	56	46
5-30	60	50

\*Decreases with the logarithm of the frequency.

#### 3.5.2 Measuring Instruments

The measuring equipment is listed in the section 4 of this test report.

#### 3.5.3 Test Procedures

1. The EUT was placed 0.4 meter from the conducting wall of the shielding room was kept at least 80 centimeters from any other grounded conducting surface.
2. Connect EUT to the power mains through a line impedance stabilization network (LISN).
3. All the support units are connecting to the other LISN.
4. The LISN provides 50 ohm coupling impedance for the measuring instrument.
5. The FCC states that a 50 ohm, 50 microhenry LISN should be used.
6. Both sides of AC line were checked for maximum conducted interference.
7. The frequency range from 150 kHz to 30 MHz was searched.
8. Set the test-receiver system to Peak Detect Function and specified bandwidth with Maximum Hold Mode.

### 3.5.4 Test Setup

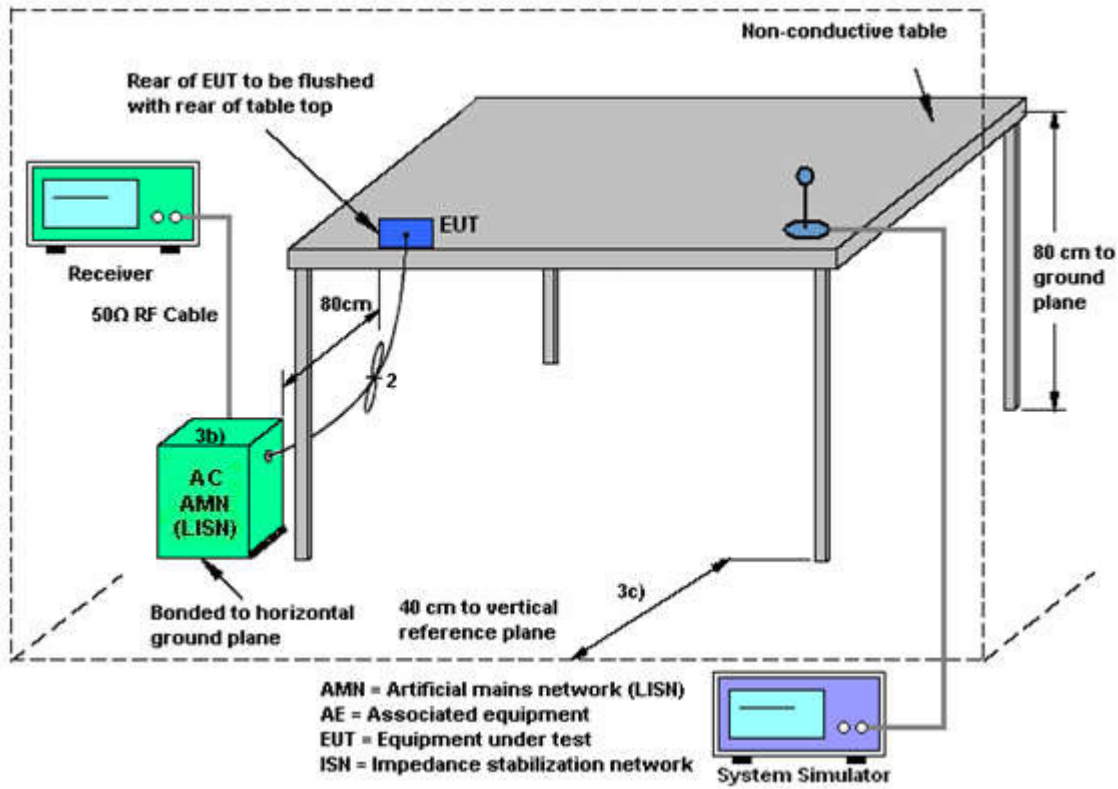



3.5.5 Test Result of AC Conducted Emission

Test Mode :	Mode 1	Temperature :	22~24°C
Test Engineer :	Eko Guan	Relative Humidity :	40~42%
Test Voltage :	120Vac / 60Hz	Phase :	Line
Function Type :	GSM850 Idle + Bluetooth Link + WLAN Link (5G) + USB Cable (Charging from Adapter 1) + Earphone 1		

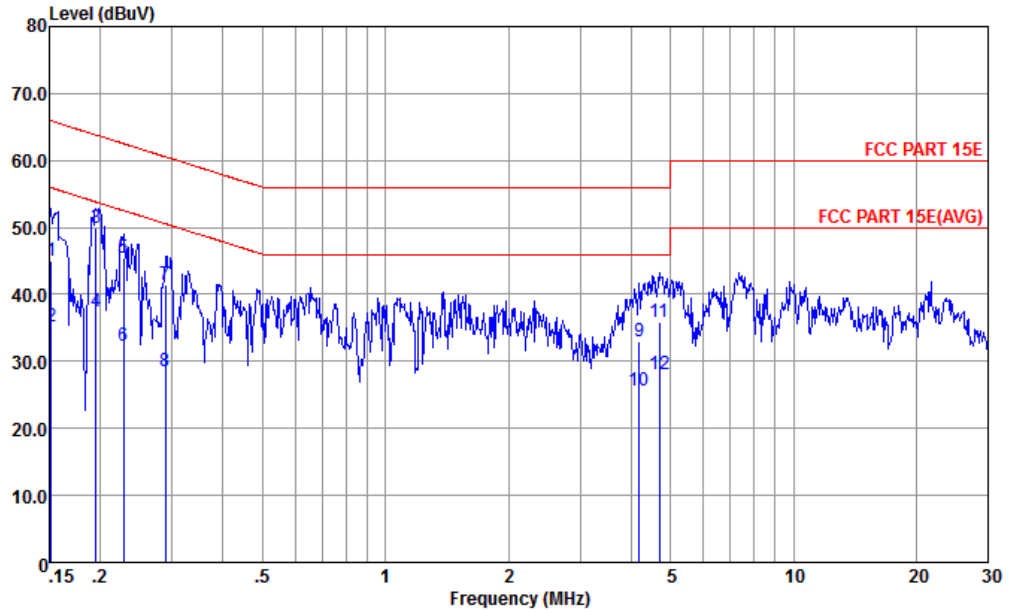

Site : CO01-KS  
 Condition : FCC PART 15E LISN-L-171013-060103 LINE

	Freq	Level	Over Limit	Limit Line	Read Level	LISN Factor	Cable Loss	Remark
	MHz	dBuV	dB	dBuV	dBuV	dB	dB	
1	0.152	44.97	-20.94	65.91	34.20	0.16	10.61	QP
2	0.152	35.27	-20.64	55.91	24.50	0.16	10.61	Average
3 *	0.195	49.86	-13.94	63.80	39.19	0.20	10.47	QP
4	0.195	37.46	-16.34	53.80	26.79	0.20	10.47	Average
5	0.228	45.45	-17.07	62.52	34.79	0.21	10.45	QP
6	0.228	32.25	-20.27	52.52	21.59	0.21	10.45	Average
7	0.289	41.45	-19.09	60.54	30.80	0.22	10.43	QP
8	0.289	28.55	-21.99	50.54	17.90	0.22	10.43	Average
9	4.180	33.03	-22.97	56.00	22.50	0.35	10.18	QP
10	4.180	25.73	-20.27	46.00	15.20	0.35	10.18	Average
11	4.696	35.78	-20.22	56.00	25.21	0.36	10.21	QP
12	4.696	28.08	-17.92	46.00	17.51	0.36	10.21	Average



Test Mode :	Mode 1	Temperature :	22~24°C
Test Engineer :	Eko Guan	Relative Humidity :	40~42%
Test Voltage :	120Vac / 60Hz	Phase :	Neutral
Function Type :	GSM850 Idle + Bluetooth Link + WLAN Link (5G) + USB Cable (Charging from Adapter 1) + Earphone 1		

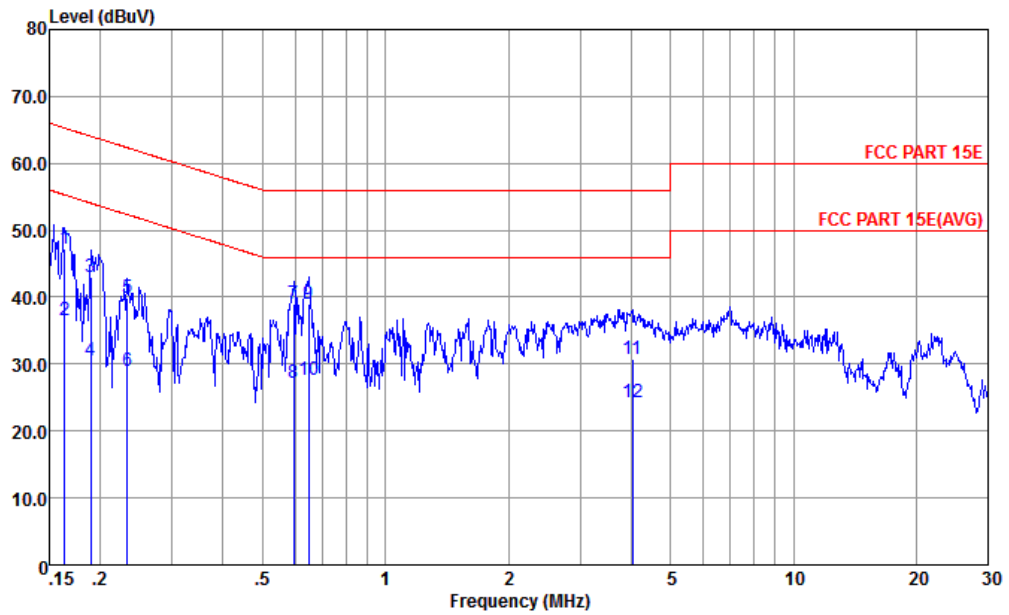

Site : CO01-KS  
 Condition : FCC PART 15E LISN-N-171013-060103 NEUTRAL

	Freq	Level	Over Limit	Limit Line	Read Level	LISN Factor	Cable Loss	Remark
	MHz	dBuV	dB	dBuV	dBuV	dB	dB	
1	0.163	47.15	-18.15	65.30	36.30	0.28	10.57	QP
2	0.163	36.65	-18.65	55.30	25.80	0.28	10.57	Average
3	0.189	43.07	-20.99	64.06	32.30	0.28	10.49	QP
4	0.189	30.57	-23.49	54.06	19.80	0.28	10.49	Average
5	0.233	39.93	-22.42	62.35	29.21	0.28	10.44	QP
6	0.233	28.93	-23.42	52.35	18.21	0.28	10.44	Average
7 *	0.595	39.03	-16.97	56.00	28.50	0.30	10.23	QP
8	0.595	27.13	-18.87	46.00	16.60	0.30	10.23	Average
9	0.647	38.99	-17.01	56.00	28.49	0.30	10.20	QP
10	0.647	27.69	-18.31	46.00	17.19	0.30	10.20	Average
11	4.027	30.80	-25.20	56.00	20.29	0.34	10.17	QP
12	4.027	24.30	-21.70	46.00	13.79	0.34	10.17	Average



## **3.6 Automatically Discontinue Transmission**

### **3.6.1 Limit of Automatically Discontinue Transmission**

The device shall automatically discontinue transmission in case of either absence of information to transmit or operational failure. These provisions are not intended to preclude the transmission of control or signaling information or the use of repetitive codes used by certain digital technologies to complete frame or burst intervals. Applicants shall include in their application for equipment authorization to describe how this requirement is met.

### **3.6.2 Measuring Instruments**

The measuring equipment is listed in the section 4 of this test report.

### **3.6.3 Test Result of Automatically Discontinue Transmission**

While the EUT is not transmitting any information, the EUT can automatically discontinue transmission and become standby mode for power saving. The EUT can detect the controlling signal of ACK message transmitting from remote device and verify whether it shall resend or discontinue transmission.



## **3.7 Antenna Requirements**

### **3.7.1 Standard Applicable**

If transmitting antenna directional gain is greater than 6 dBi, both the peak transmit power and the peak power spectral density shall be reduced by the amount in dB that the directional gain of the antenna exceeds 6 dBi.

### **3.7.2 Antenna Anti-Replacement Construction**

An embedded-in antenna design is used.

### **3.7.3 Antenna Gain**

The antenna gain is less than 6 dBi. Therefore, it is not necessary to reduce maximum peak output power limit.



## 4 List of Measuring Equipments

Instrument	Manufacturer	Model No.	Serial No.	Characteristics	Calibration Date	Test Date	Due Date	Remark
Spectrum Analyzer	R&S	FSV40	101040	10Hz~40GHz	Aug. 08, 2017	Jan. 02, 2018~ Jan. 05, 2018	Aug. 07, 2018	Conducted (TH01-KS)
Pulse Power Sensor	Anritsu	MA2411B	0917070	300MHz~40GHz	Jan. 19, 2017	Jan. 02, 2018~ Jan. 05, 2018	Jan. 18, 2018	Conducted (TH01-KS)
Power Meter	Anritsu	ML2495A	1005002	50MHz Bandwidth	Jan. 19, 2017	Jan. 02, 2018~ Jan. 05, 2018	Jan. 18, 2018	Conducted (TH01-KS)
EMI Test Receiver&SA	Agilent	N9038A	MY52260185	20Hz~26.5GHz	Apr. 20, 2017	Jan. 12, 2018~ Jan. 17, 2018	Apr. 19, 2018	Radiation (03CH01-SZ)
Loop Antenna	R&S	HFH2-Z2	100354	9kHz~30MHz	May 14, 2017	Jan. 12, 2018~ Jan. 17, 2018	May 13, 2018	Radiation (03CH01-SZ)
Bilog Antenna	TeseQ	CBL6112D	23188	30MHz-2GHz	Apr. 25, 2017	Jan. 12, 2018~ Jan. 17, 2018	Apr. 24, 2018	Radiation (03CH01-SZ)
Double Ridge Horn Antenna	ETS Lindgren	3117	119436	1GHz~18GHz	Jul. 28, 2017	Jan. 12, 2018~ Jan. 17, 2018	Jul. 27, 2018	Radiation (03CH01-SZ)
SHF-EHF Horn	com-power	AH-840	101071	18Ghz-40GHz	Jun. 16, 2017	Jan. 12, 2018~ Jan. 17, 2018	Jun. 15, 2018	Radiation (03CH01-SZ)
LF Amplifier	Burgeon	BPA-530	102209	0.01~3000Mhz	Apr. 20, 2017	Jan. 12, 2018~ Jan. 17, 2018	Apr. 19, 2018	Radiation (03CH01-SZ)
HF Amplifier	MITEQ	AMF-7D-0010 1800-30-10P-R	1707137	1GHz~18GHz	Oct. 19, 2017	Jan. 12, 2018~ Jan. 17, 2018	Oct. 18, 2018	Radiation (03CH01-SZ)
HF Amplifier	KEYSIGHT	83017A	MY53270104	0.5GHz~26.5GHz	Oct. 19, 2017	Jan. 12, 2018~ Jan. 17, 2018	Oct. 18, 2018	Radiation (03CH01-SZ)
HF Amplifier	MITEQ	TTA1840-35-H G	1871923	18GHz~40GHz	Jul. 18, 2017	Jan. 12, 2018~ Jan. 17, 2018	Jul. 17, 2018	Radiation (03CH01-SZ)
AC Power Source	Chroma	61601	6160100019 85	N/A	NCR	Jan. 12, 2018~ Jan. 17, 2018	NCR	Radiation (03CH01-SZ)
Turn Table	EM	EM1000	N/A	0~360 degree	NCR	Jan. 12, 2018~ Jan. 17, 2018	NCR	Radiation (03CH01-SZ)
EMI Receiver	R&S	ESC17	100768	9kHz~7GHz;	Apr. 20, 2017	Jan. 22, 2018	Apr. 19, 2018	Conduction (CO01-KS)
AC LISN	MessTec	AN3016	060103	9kHz~30MHz	Oct. 13, 2017	Jan. 22, 2018	Oct. 12, 2018	Conduction (CO01-KS)
AC LISN (for auxiliary equipment)	MessTec	AN3016	060105	9kHz~30MHz	Oct. 13, 2017	Jan. 22, 2018	Oct. 12, 2018	Conduction (CO01-KS)
AC Power Source	Chroma	61602	ABP0000008 11	AC 0V~300V, 45Hz~1000Hz	Oct. 12, 2017	Jan. 22, 2018	Oct. 11, 2018	Conduction (CO01-KS)

NCR: No Calibration Required



## 5 Uncertainty of Evaluation

### Uncertainty of Conducted Emission Measurement (150kHz ~ 30MHz)

Measuring Uncertainty for a Level of Confidence of 95% ( $U = 2Uc(y)$ )	2.3dB
---	-------

### Uncertainty of Radiated Emission Measurement (30 MHz ~ 1000 MHz)

Measuring Uncertainty for a Level of Confidence of 95% ( $U = 2Uc(y)$ )	4.8dB
---	-------

### Uncertainty of Radiated Emission Measurement (1000 MHz ~ 18000 MHz)

Measuring Uncertainty for a Level of Confidence of 95% ( $U = 2Uc(y)$ )	5.0dB
---	-------

### Uncertainty of Radiated Emission Measurement (18000 MHz ~ 40000 MHz)

Measuring Uncertainty for a Level of Confidence of 95% ( $U = 2Uc(y)$ )	4.3dB
---	-------



## **Appendix A. Conducted Test Results**

Test Engineer:	Silent Hai	Temperature:	21~25	°C
Test Date:	2018/1/2 ~ 2018/1/5	Relative Humidity:	51~55	%

**TEST RESULTS DATA**  
**26dB and 99% OBW**

Band I										
Mod.	Data Rate	NTX	CH.	Freq. (MHz)	99% Bandwidth (MHz)	26 dB Bandwidth (MHz)	IC 99% Bandwidth Power Limit (dBm)	IC 99% Bandwidth EIRP Limit (dBm)		
11a	6M bps	1	36	5180	17.43	23.03	-	22.41		
11a	6M bps	1	44	5220	17.53	23.38	-	22.44		
11a	6M bps	1	48	5240	17.48	23.78	-	22.43		
HT20	MCS0	1	36	5180	18.83	25.48	-	22.75		
HT20	MCS0	1	44	5220	18.88	25.38	-	22.76		
HT20	MCS0	1	48	5240	18.73	25.48	-	22.73		
HT40	MCS0	1	38	5190	36.56	41.81	-	23.01		
HT40	MCS0	1	46	5230	36.56	41.81	-	23.01		
VHT80	MCS0	1	42	5210	75.76	82.80	-	23.01		

**TEST RESULTS DATA**  
**Average Power Table**

FCC Band I										
Mod.	Data Rate	NTX	CH.	Freq. (MHz)	Duty Factor (dB)	Average Conducted Power (dBm)	FCC Conducted Power Limit (dBm)	DG (dBi)		Pass/Fail
11a	6M bps	1	36	5180	0.20	15.75	24.00	-1.40		Pass
11a	6M bps	1	44	5220	0.20	15.77	24.00	-1.40		Pass
11a	6M bps	1	48	5240	0.20	15.98	24.00	-1.40		Pass
HT20	MCS0	1	36	5180	0.26	15.65	24.00	-1.40		Pass
HT20	MCS0	1	44	5220	0.26	15.80	24.00	-1.40		Pass
HT20	MCS0	1	48	5240	0.26	15.86	24.00	-1.40		Pass
HT40	MCS0	1	38	5190	0.45	13.03	24.00	-1.40		Pass
HT40	MCS0	1	46	5230	0.45	13.26	24.00	-1.40		Pass
VHT20	MCS0	1	36	5180	0.20	15.62	24.00	-1.40		Pass
VHT20	MCS0	1	44	5220	0.20	15.79	24.00	-1.40		Pass
VHT20	MCS0	1	48	5240	0.20	15.81	24.00	-1.40		Pass
VHT40	MCS0	1	38	5190	0.40	12.91	24.00	-1.40		Pass
VHT40	MCS0	1	46	5230	0.40	13.22	24.00	-1.40		Pass
VHT80	MCS0	1	42	5210	0.75	11.79	24.00	-1.40		Pass

**TEST RESULTS DATA**  
**Power Spectral Density**

FCC Band I										
Mod.	Data Rate	NTX	CH.	Freq. (MHz)	Duty Factor (dB)	Average Power Density (dBm/MHz)	Average PSD Limit (dBm/MHz)	DG (dBi)	-	Pass/Fail
11a	6M bps	1	36	5180	0.56	5.48	11.00	-1.40		Pass
11a	6M bps	1	44	5220	0.56	5.19	11.00	-1.40		Pass
11a	6M bps	1	48	5240	0.56	5.63	11.00	-1.40		Pass
HT20	MCS0	1	36	5180	0.26	5.22	11.00	-1.40		Pass
HT20	MCS0	1	44	5220	0.26	5.24	11.00	-1.40		Pass
HT20	MCS0	1	48	5240	0.26	5.75	11.00	-1.40		Pass
HT40	MCS0	1	38	5190	0.45	-0.63	11.00	-1.40		Pass
HT40	MCS0	1	46	5230	0.45	-0.39	11.00	-1.40		Pass
VHT80	MCS0	1	42	5210	0.75	-5.25	11.00	-1.40		Pass

**TEST RESULTS DATA**  
**26dB and 99% OBW**

Band II										
Mod.	Data Rate	NTX	CH.	Freq. (MHz)	99% Bandwidth (MHz)	26 dB Bandwidth (MHz)	IC 99% Bandwidth Power Limit (dBm)	IC 99% Bandwidth EIRP Limit (dBm)	FCC 26dB Bandwidth Power Limit (dBm)	Note
11a	6M bps	1	52	5260	17.53	23.58	23.44	29.44	23.98	
11a	6M bps	1	60	5300	17.53	22.98	23.44	29.44	23.98	
11a	6M bps	1	64	5320	17.43	23.93	23.41	29.41	23.98	
HT20	MCS 0	1	52	5260	18.73	24.98	23.73	29.73	23.98	
HT20	MCS 0	1	60	5300	18.73	25.52	23.73	29.73	23.98	
HT20	MCS 0	1	64	5320	18.73	24.68	23.73	29.73	23.98	
HT40	MCS 0	1	54	5270	36.56	41.81	23.98	30.00	23.98	
HT40	MCS 0	1	62	5310	36.46	41.63	23.98	30.00	23.98	
VHT80	MCS 0	1	58	5290	75.76	82.96	23.98	30.00	23.98	

**TEST RESULTS DATA**  
**Average Power Table**

FCC Band II										
Mod.	Data Rate	NTX	CH.	Freq. (MHz)	Duty Factor (dB)	Average Conducted Power (dBm)	FCC Conducted Power Limit (dBm)	DG (dBi)	EIRP Power Limit (dBm)	Pass/Fail
11a	6M bps	1	52	5260	0.20	15.89	23.98	-1.60	26.99	Pass
11a	6M bps	1	60	5300	0.20	15.62	23.98	-1.60	26.99	Pass
11a	6M bps	1	64	5320	0.20	15.56	23.98	-1.60	26.99	Pass
HT20	MCS 0	1	52	5260	0.26	15.81	23.98	-1.60	26.99	Pass
HT20	MCS 0	1	60	5300	0.26	15.65	23.98	-1.60	26.99	Pass
HT20	MCS 0	1	64	5320	0.26	15.64	23.98	-1.60	26.99	Pass
HT40	MCS 0	1	54	5270	0.45	13.12	23.98	-1.60	26.99	Pass
HT40	MCS 0	1	62	5310	0.45	12.92	23.98	-1.60	26.99	Pass
VHT20	MCS 0	1	52	5260	0.20	15.71	23.98	-1.60	26.99	Pass
VHT20	MCS 0	1	60	5300	0.20	15.62	23.98	-1.60	26.99	Pass
VHT20	MCS 0	1	64	5320	0.20	15.63	23.98	-1.60	26.99	Pass
VHT40	MCS 0	1	54	5270	0.40	13.09	23.98	-1.60	26.99	Pass
VHT40	MCS 0	1	62	5310	0.40	12.89	23.98	-1.60	26.99	Pass
VHT80	MCS 0	1	58	5290	0.75	10.92	23.98	-1.60	26.99	Pass

**TEST RESULTS DATA**  
**Power Spectral Density**

Band II										
Mod.	Data Rate	NTX	CH.	Freq. (MHz)	Duty Factor (dB)	Average Power Density (dBm/MHz)	Average PSD Limit (dBm/MHz)	DG (dBi)		Pass/Fail
11a	6M bps	1	52	5260	0.56	5.90	11.00	-1.60		Pass
11a	6M bps	1	60	5300	0.56	5.18	11.00	-1.60		Pass
11a	6M bps	1	64	5320	0.56	5.58	11.00	-1.60		Pass
HT20	MCS 0	1	52	5260	0.26	5.44	11.00	-1.60		Pass
HT20	MCS 0	1	60	5300	0.26	4.96	11.00	-1.60		Pass
HT20	MCS 0	1	64	5320	0.26	5.75	11.00	-1.60		Pass
HT40	MCS 0	1	54	5270	0.45	-0.35	11.00	-1.60		Pass
HT40	MCS 0	1	62	5310	0.45	-0.67	11.00	-1.60		Pass
VHT80	MCS 0	1	58	5290	0.75	-5.80	11.00	-1.60		Pass

**TEST RESULTS DATA**  
**26dB and 99% OBW**

Band III										
Mod.	Data Rate	NTX	CH.	Freq. (MHz)	99% Bandwidth (MHz)	26 dB Bandwidth (MHz)	IC 99% Bandwidth Power Limit (dBm)	IC 99% Bandwidth EIRP Limit (dBm)	FCC 26dB Bandwidth Power Limit (dBm)	Note
11a	6M bps	1	100	5500	17.48	23.53	23.43	29.43	23.98	
11a	6M bps	1	116	5580	17.48	23.53	23.43	29.43	23.98	
11a	6M bps	1	140	5700	17.58	23.38	23.45	29.45	23.98	
HT20	MCS 0	1	100	5500	18.83	25.38	23.75	29.75	23.98	
HT20	MCS 0	1	116	5580	18.78	25.28	23.74	29.74	23.98	
HT20	MCS 0	1	140	5700	18.78	25.57	23.74	29.74	23.98	
HT40	MCS 0	1	102	5510	36.56	41.81	23.98	30.00	23.98	
HT40	MCS 0	1	110	5550	36.56	41.90	23.98	30.00	23.98	
HT40	MCS 0	1	134	5670	36.56	41.90	23.98	30.00	23.98	
VHT80	MCS 0	1	106	5530	75.76	83.28	23.98	30.00	23.98	
VHT80	MCS 0	1	122	5610	75.88	83.44	23.98	30.00	23.98	

**TEST RESULTS DATA**  
**Average Power Table**

FCC Band III										
Mod.	Data Rate	NTX	CH.	Freq. (MHz)	Duty Factor (dB)	Average Conducted Power (dBm)	FCC Conducted Power Limit (dBm)	DG (dBi)	EIRP Power Limit (dBm)	Pass/Fail
11a	6M bps	1	100	5500	0.20	16.06	23.98	-0.90	26.99	Pass
11a	6M bps	1	116	5580	0.20	15.55	23.98	-0.90	26.99	Pass
11a	6M bps	1	140	5700	0.20	15.02	23.98	-0.90	26.99	Pass
HT20	MCS 0	1	100	5500	0.26	15.97	23.98	-0.90	26.99	Pass
HT20	MCS 0	1	116	5580	0.26	15.77	23.98	-0.90	26.99	Pass
HT20	MCS 0	1	140	5700	0.26	14.75	23.98	-0.90	26.99	Pass
HT40	MCS 0	1	102	5510	0.45	13.14	23.98	-0.90	26.99	Pass
HT40	MCS 0	1	110	5550	0.45	13.11	23.98	-0.90	26.99	Pass
HT40	MCS 0	1	134	5670	0.45	12.43	23.98	-0.90	26.99	Pass
VHT20	MCS 0	1	100	5500	0.20	15.95	23.98	-0.90	26.99	Pass
VHT20	MCS 0	1	116	5580	0.20	15.75	23.98	-0.90	26.99	Pass
VHT20	MCS 0	1	140	5700	0.20	14.74	23.98	-0.90	26.99	Pass
VHT40	MCS 0	1	102	5510	0.40	11.34	23.98	-0.90	26.99	Pass
VHT40	MCS 0	1	110	5550	0.40	11.22	23.98	-0.90	26.99	Pass
VHT40	MCS 0	1	134	5670	0.40	10.61	23.98	-0.90	26.99	Pass
VHT80	MCS 0	1	106	5530	0.75	8.84	23.98	-0.90	26.99	Pass
VHT80	MCS 0	1	122	5610	0.75	12.41	23.98	-0.90	26.99	Pass

**TEST RESULTS DATA**  
**Power Spectral Density**

Band III										
Mod.	Data Rate	NTX	CH.	Freq. (MHz)	Duty Factor (dB)	Average Power Density (dBm/MHz)	Average PSD Limit (dBm/MHz)	DG (dBi)		Pass/Fail
11a	6M bps	1	100	5500	0.56	5.64	11.00	-0.90		Pass
11a	6M bps	1	116	5580	0.56	5.70	11.00	-0.90		Pass
11a	6M bps	1	140	5700	0.56	5.27	11.00	-0.90		Pass
HT20	MCS 0	1	100	5500	0.26	5.76	11.00	-0.90		Pass
HT20	MCS 0	1	116	5580	0.26	5.29	11.00	-0.90		Pass
HT20	MCS 0	1	140	5700	0.26	4.40	11.00	-0.90		Pass
HT40	MCS 0	1	102	5510	0.45	0.17	11.00	-0.90		Pass
HT40	MCS 0	1	110	5550	0.45	-0.29	11.00	-0.90		Pass
HT40	MCS 0	1	134	5670	0.45	-1.09	11.00	-0.90		Pass
VHT80	MCS 0	1	106	5530	0.75	-8.05	11.00	-0.90		Pass
VHT80	MCS 0	1	122	5610	0.75	-4.64	11.00	-0.90		Pass



## Appendix B. Radiated Spurious Emission

### Band 1 - 5150~5250MHz WIFI 802.11a (Band Edge @ 3m)

WIFI	Note	Frequency	Level	Over	Limit	Read	Antenna	Cable	Preamp	Ant	Table	Peak	Pol.
Ant.				Limit	Line	Level	Factor	Loss	Factor	Pos	Pos	Avg.	
1		( MHz )	( dBμV/m )	( dB )	( dBμV/m )	( dBμV )	( dB/m )	( dB )	( dB )	( cm )	( deg )	( P/A )	( H/V )
802.11a CH 36 5180MHz		5146.38	52.6	-21.4	74	40.46	33.87	11.37	33.1	167	305	P	H
		5149.76	45.9	-8.1	54	33.76	33.87	11.37	33.1	167	305	A	H
	*	5180	103.87	-	-	91.58	33.92	11.47	33.1	167	305	P	H
	*	5180	96.79	-	-	84.5	33.92	11.47	33.1	167	305	A	H
		5146.12	53.74	-20.26	74	41.6	33.87	11.37	33.1	188	247	P	V
		5150	44.85	-9.15	54	32.71	33.87	11.37	33.1	188	247	A	V
	*	5180	100.58	-	-	88.29	33.92	11.47	33.1	188	247	P	V
	*	5180	94.44	-	-	82.15	33.92	11.47	33.1	188	247	A	V
802.11a CH 44 5220MHz		5093.6	53.23	-20.77	74	41.26	33.81	11.26	33.1	145	308	P	H
		5149.24	43.67	-10.33	54	31.53	33.87	11.37	33.1	145	308	A	H
	*	5220	103.98	-	-	91.54	33.96	11.58	33.1	145	308	P	H
	*	5220	97.04	-	-	84.6	33.96	11.58	33.1	145	308	A	H
		5404.28	52.78	-21.22	74	39.9	34.2	11.78	33.1	145	308	P	H
		5447.4	43.8	-10.2	54	30.8	34.26	11.84	33.1	145	308	A	H
		5064.74	50.93	-23.07	74	39.11	33.76	11.16	33.1	204	246	P	V
		5148.98	41.81	-12.19	54	29.67	33.87	11.37	33.1	204	246	A	V
	*	5220	100.58	-	-	88.14	33.96	11.58	33.1	204	246	P	V
	*	5220	94.03	-	-	81.59	33.96	11.58	33.1	204	246	A	V
		5451.04	51.36	-22.64	74	38.36	34.26	11.84	33.1	204	246	P	V
		5459.72	42.56	-11.44	54	29.56	34.26	11.84	33.1	204	246	A	V



802.11a CH 48 5240MHz		5004.68	52.49	-21.51	74	40.84	33.7	11.05	33.1	159	309	P	H
		5083.2	43.8	-10.2	54	31.85	33.79	11.26	33.1	159	309	A	H
	*	5240	103.02	-	-	90.52	33.98	11.62	33.1	159	309	P	H
	*	5240	96.7	-	-	84.2	33.98	11.62	33.1	159	309	A	H
		5395.04	53.11	-20.89	74	40.23	34.2	11.78	33.1	159	309	P	H
		5446.56	43.75	-10.25	54	30.75	34.26	11.84	33.1	159	309	A	H
		5017.68	50.17	-23.83	74	38.52	33.7	11.05	33.1	207	248	P	V
		5112.32	41.93	-12.07	54	29.94	33.83	11.26	33.1	207	248	A	V
	*	5240	100.09	-	-	87.59	33.98	11.62	33.1	207	248	P	V
	*	5240	94.14	-	-	81.64	33.98	11.62	33.1	207	248	A	V
		5382.16	50.88	-23.12	74	38.06	34.18	11.74	33.1	207	248	P	V
		5433.12	42.81	-11.19	54	29.83	34.24	11.84	33.1	207	248	A	V
Remark	1. No other spurious found. 2. All results are PASS against Peak and Average limit line.												



Band 1 5150~5250MHz

WIFI 802.11a (Harmonic @ 3m)

WIFI Ant. 1	Note	Frequency ( MHz )	Level ( dBμV/m )	Over Limit ( dB )	Limit Line ( dBμV/m )	Read Level (dBμV)	Antenna Factor ( dB/m )	Cable Loss ( dB )	Preamp Factor ( dB )	Ant Pos ( cm )	Table Pos ( deg )	Peak Avg. (P/A)	Pol. (H/V)
802.11a CH 36 5180MHz		10360	49.76	-24.24	74	53.98	37.02	14.61	55.85	152	260	P	H
		15540	50.13	-23.87	74	49.74	40.78	16.34	56.73	189	238	P	H
		10360	50.99	-23.01	74	55.21	37.02	14.61	55.85	152	260	P	V
		15540	50.77	-23.23	74	50.38	40.78	16.34	56.73	189	238	P	V
802.11a CH 44 5220MHz		10440	50.39	-23.61	74	54.58	37.06	14.63	55.88	150	230	P	H
		15660	54.45	-19.55	74	53.44	41.07	16.43	56.49	160	225	P	H
		10440	50.61	-23.39	74	54.8	37.06	14.63	55.88	150	230	P	V
		15660	54.82	-19.18	74	53.81	41.07	16.43	56.49	160	225	P	V
802.11a CH 48 5240MHz		10480	50.71	-23.29	74	54.88	37.09	14.64	55.9	150	289	P	H
		15720	50.98	-23.02	74	49.64	41.24	16.45	56.35	150	291	P	H
		10480	50.51	-23.49	74	54.68	37.09	14.64	55.9	150	289	P	V
		15720	50.77	-23.23	74	49.43	41.24	16.45	56.35	150	291	P	V
Remark	1. No other spurious found. 2. All results are PASS against Peak and Average limit line.												



**Band 1 5150~5250MHz**  
**WIFI 802.11n HT20 (Band Edge @ 3m)**

WIFI Ant. 1	Note	Frequency ( MHz )	Level ( dBμV/m )	Over Limit ( dB )	Limit Line ( dBμV/m )	Read Level ( dBμV )	Antenna Factor ( dB/m )	Cable Loss ( dB )	Preamp Factor ( dB )	Ant Pos ( cm )	Table Pos ( deg )	Peak Avg. ( P/A )	Pol. ( H/V )
802.11n HT20 CH 36 5180MHz		5148.98	53.3	-20.7	74	41.16	33.87	11.37	33.1	144	311	P	H
		5148.98	45.84	-8.16	54	33.7	33.87	11.37	33.1	144	311	A	H
	*	5180	103.87	-	-	91.58	33.92	11.47	33.1	144	311	P	H
	*	5180	96.83	-	-	84.54	33.92	11.47	33.1	144	311	A	H
		5105.82	53.69	-20.31	74	41.7	33.83	11.26	33.1	391	245	P	V
		5150	46.52	-7.48	54	34.38	33.87	11.37	33.1	391	245	A	V
	*	5180	103.66	-	-	91.37	33.92	11.47	33.1	391	245	P	V
	*	5180	96.93	-	-	84.64	33.92	11.47	33.1	391	245	A	V
802.11n HT20 CH 44 5220MHz		5046.02	53.07	-20.93	74	41.27	33.74	11.16	33.1	163	312	P	H
		5015.6	43.69	-10.31	54	32.04	33.7	11.05	33.1	163	312	A	H
	*	5220	104.15	-	-	91.71	33.96	11.58	33.1	163	312	P	H
	*	5220	96.85	-	-	84.41	33.96	11.58	33.1	163	312	A	H
		5439.84	52.54	-21.46	74	39.56	34.24	11.84	33.1	163	312	P	H
		5459.72	43.95	-10.05	54	30.95	34.26	11.84	33.1	163	312	A	H
		5062.14	52.71	-21.29	74	40.89	33.76	11.16	33.1	387	255	P	V
		5143.26	43.98	-10.02	54	31.84	33.87	11.37	33.1	387	255	A	V
	*	5220	105.51	-	-	93.07	33.96	11.58	33.1	387	255	P	V
	*	5220	97.84	-	-	85.4	33.96	11.58	33.1	387	255	A	V
		5440.68	52.37	-21.63	74	39.39	34.24	11.84	33.1	387	255	P	V
	5454.4	43.9	-10.1	54	30.9	34.26	11.84	33.1	387	255	A	V	



802.11n HT20 CH 48 5240MHz		5037.96	52.69	-21.31	74	40.89	33.74	11.16	33.1	163	312	P	H
		5037.44	43.7	-10.3	54	31.92	33.72	11.16	33.1	163	312	A	H
	*	5240	103.01	-	-	90.51	33.98	11.62	33.1	163	312	P	H
	*	5240	96.15	-	-	83.65	33.98	11.62	33.1	163	312	A	H
		5444.6	52.82	-21.18	74	39.84	34.24	11.84	33.1	163	312	P	H
		5456.92	43.82	-10.18	54	30.82	34.26	11.84	33.1	163	312	A	H
		5072.8	53.79	-20.21	74	41.94	33.79	11.16	33.1	384	277	P	V
		5063.96	43.77	-10.23	54	31.95	33.76	11.16	33.1	384	277	A	V
	*	5240	105.42	-	-	92.92	33.98	11.62	33.1	384	277	P	V
	*	5240	96.71	-	-	84.21	33.98	11.62	33.1	384	277	A	V
		5445.16	52.69	-21.31	74	39.71	34.24	11.84	33.1	384	277	P	V
		5456.08	43.83	-10.17	54	30.83	34.26	11.84	33.1	384	277	A	V
<b>Remark</b>	1. No other spurious found. 2. All results are PASS against Peak and Average limit line.												



**Band 1 5150~5250MHz**  
**WIFI 802.11n HT20 (Harmonic @ 3m)**

WIFI Ant. 1	Note	Frequency ( MHz )	Level ( dBμV/m )	Over Limit ( dB )	Limit Line ( dBμV/m )	Read Level (dBμV)	Antenna Factor ( dB/m )	Cable Loss ( dB )	Preamp Factor ( dB )	Ant Pos ( cm )	Table Pos ( deg )	Peak Avg. (P/A)	Pol. (H/V)
802.11n HT20 CH 36 5180MHz		10360	53.75	-20.25	74	57.97	37.02	14.61	55.85	152	260	P	H
		10360	49.38	-4.62	54	53.6	37.02	14.61	55.85	152	260	A	H
		15540	50.65	-23.35	74	50.26	40.78	16.34	56.73	189	238	P	H
		10360	50.72	-23.28	74	54.94	37.02	14.61	55.85	149	360	P	V
		15540	50.9	-23.1	74	50.51	40.78	16.34	56.73	189	238	P	V
802.11n HT20 CH 44 5220MHz		10440	54.09	-19.91	74	58.28	37.06	14.63	55.88	150	230	P	H
		10440	48.94	-5.06	54	53.13	37.06	14.63	55.88	150	230	A	H
		15660	50.75	-23.25	74	49.74	41.07	16.43	56.49	160	225	P	H
		10440	50.49	-23.51	74	54.68	37.06	14.63	55.88	150	230	P	V
		15660	50.55	-23.45	74	49.54	41.07	16.43	56.49	160	225	P	V
802.11n HT20 CH 48 5240MHz		10480	54.3	-19.7	74	58.47	37.09	14.64	55.9	150	289	P	H
		10480	50.3	-3.7	54	54.47	37.09	14.64	55.9	150	289	A	H
		15720	50.44	-23.56	74	49.1	41.24	16.45	56.35	150	291	P	H
		10480	48.78	-25.22	74	52.95	37.09	14.64	55.9	150	289	P	V
		15720	50.07	-23.93	74	48.73	41.24	16.45	56.35	150	291	P	V
<b>Remark</b>	1. No other spurious found. 2. All results are PASS against Peak and Average limit line.												



**Band 1 5150~5250MHz**  
**WIFI 802.11n HT40 (Band Edge @ 3m)**

WIFI Ant. 1	Note	Frequency ( MHz )	Level ( dBμV/m )	Over Limit ( dB )	Limit Line ( dBμV/m )	Read Level (dBμV)	Antenna Factor ( dB/m )	Cable Loss ( dB )	Preamp Factor ( dB )	Ant Pos ( cm )	Table Pos ( deg )	Peak Avg. (P/A)	Pol. (H/V)
802.11n HT40 CH 38 5190MHz		5148.46	58.4	-15.6	74	46.26	33.87	11.37	33.1	137	306	P	H
		5150	47.65	-6.35	54	35.51	33.87	11.37	33.1	137	306	A	H
	*	5190	100.8	-	-	88.51	33.92	11.47	33.1	137	306	P	H
	*	5190	91.52	-	-	79.23	33.92	11.47	33.1	137	306	A	H
		5425.56	52.42	-21.58	74	39.52	34.22	11.78	33.1	137	306	P	H
		5456.92	42.03	-11.97	54	29.03	34.26	11.84	33.1	137	306	A	H
		5147.42	55.95	-18.05	74	43.81	33.87	11.37	33.1	157	273	P	V
		5150	47.24	-6.76	54	35.1	33.87	11.37	33.1	157	273	A	V
	*	5190	96.7	-	-	84.41	33.92	11.47	33.1	157	273	P	V
	*	5190	88.99	-	-	76.7	33.92	11.47	33.1	157	273	A	V
		5401.76	52.66	-21.34	74	39.78	34.2	11.78	33.1	157	273	P	V
		5393.08	41.71	-12.29	54	28.85	34.18	11.78	33.1	157	273	A	V
802.11n HT40 CH 46 5230MHz		5047.58	52.31	-21.69	74	40.51	33.74	11.16	33.1	158	306	P	H
		5149.5	42.49	-11.51	54	30.35	33.87	11.37	33.1	158	306	A	H
	*	5230	99.54	-	-	87.08	33.98	11.58	33.1	158	306	P	H
	*	5230	90.69	-	-	78.23	33.98	11.58	33.1	158	306	A	H
		5389.92	52.52	-21.48	74	39.66	34.18	11.78	33.1	158	306	P	H
		5436.96	41.63	-12.37	54	28.65	34.24	11.84	33.1	158	306	A	H
		5143.26	53.25	-20.75	74	41.11	33.87	11.37	33.1	157	275	P	V
		5143	42.5	-11.5	54	30.36	33.87	11.37	33.1	157	275	A	V
	*	5230	97.81	-	-	85.35	33.98	11.58	33.1	157	275	P	V
	*	5230	90.69	-	-	78.23	33.98	11.58	33.1	157	275	A	V
	5428.56	51.82	-22.18	74	38.84	34.24	11.84	33.1	157	275	P	V	
	5452.8	41.71	-12.29	54	28.71	34.26	11.84	33.1	157	275	A	V	
<b>Remark</b>	1. No other spurious found. 2. All results are PASS against Peak and Average limit line.												



**Band 1 5150~5250MHz**  
**WIFI 802.11n HT40 (Harmonic @ 3m)**

WIFI Ant. 1	Note	Frequency ( MHz )	Level ( dBμV/m )	Over Limit ( dB )	Limit Line ( dBμV/m )	Read Level (dBμV)	Antenna Factor ( dB/m )	Cable Loss ( dB )	Preamp Factor ( dB )	Ant Pos ( cm )	Table Pos ( deg )	Peak Avg. (P/A)	Pol. (H/V)
802.11n		10380	48.76	-25.24	74	52.97	37.03	14.62	55.86	150	360	P	H
HT40		15570	50.41	-23.59	74	49.83	40.87	16.37	56.66	155	360	P	H
CH 38		10380	50.62	-23.38	74	54.83	37.03	14.62	55.86	150	360	P	V
5190MHz		15570	49.83	-24.17	74	49.25	40.87	16.37	56.66	155	360	P	V
802.11n		10460	50.12	-23.88	74	54.29	37.07	14.64	55.88	150	360	P	H
HT40		15690	50.67	-23.33	74	49.48	41.16	16.45	56.42	150	225	P	H
CH 46		10460	50.96	-23.04	74	55.13	37.07	14.64	55.88	150	360	P	V
5230MHz		15690	50.61	-23.39	74	49.42	41.16	16.45	56.42	150	225	P	V
<b>Remark</b>	1. No other spurious found. 2. All results are PASS against Peak and Average limit line.												



**Band 1 5150~5250MHz**  
**WIFI 802.11ac VHT80 (Band Edge @ 3m)**

WIFI Ant. 1	Note	Frequency ( MHz )	Level ( dBμV/m )	Over Limit ( dB )	Limit Line ( dBμV/m )	Read Level (dBμV)	Antenna Factor ( dB/m )	Cable Loss ( dB )	Preamp Factor ( dB )	Ant Pos ( cm )	Table Pos ( deg )	Peak Avg. (P/A)	Pol. (H/V)
802.11ac VHT80 CH 42 5210MHz		5141.18	58.51	-15.49	74	46.37	33.87	11.37	33.1	144	303	P	H
		5144.82	50.52	-3.48	54	38.38	33.87	11.37	33.1	144	303	A	H
	*	5210	96.36	-	-	83.92	33.96	11.58	33.1	144	303	P	H
	*	5210	89.58	-	-	77.14	33.96	11.58	33.1	144	303	A	H
		5433.6	52.02	-21.98	74	39.04	34.24	11.84	33.1	144	303	P	H
		5453.28	44.08	-9.92	54	31.08	34.26	11.84	33.1	144	303	A	H
		5145.6	55.42	-18.58	74	43.28	33.87	11.37	33.1	363	290	P	V
		5147.42	47.75	-6.25	54	35.61	33.87	11.37	33.1	363	290	A	V
	*	5210	94.05	-	-	81.61	33.96	11.58	33.1	363	290	P	V
	*	5210	87.76	-	-	75.32	33.96	11.58	33.1	363	290	A	V
		5454.68	52.27	-21.73	74	39.27	34.26	11.84	33.1	363	290	P	V
	5446.84	44.59	-9.41	54	31.59	34.26	11.84	33.1	363	290	A	V	
<b>Remark</b>	1. No other spurious found. 2. All results are PASS against Peak and Average limit line.												



**Band 1 5150~5250MHz**  
**WIFI 802.11ac VHT80 (Harmonic @ 3m)**

WIFI Ant. 1	Note	Frequency ( MHz )	Level ( dBμV/m )	Over Limit ( dB )	Limit Line ( dBμV/m )	Read Level (dBμV)	Antenna Factor ( dB/m )	Cable Loss ( dB )	Preamp Factor ( dB )	Ant Pos ( cm )	Table Pos ( deg )	Peak Avg. (P/A)	Pol. (H/V)
802.11ac		10420	50.05	-23.95	74	54.24	37.05	14.63	55.87	150	230	P	H
VHT80		15630	49.35	-24.65	74	48.44	41.03	16.4	56.52	160	225	P	H
CH 42		10420	50.44	-23.56	74	54.63	37.05	14.63	55.87	150	230	P	V
5210MHz		15630	49.98	-24.02	74	49.07	41.03	16.4	56.52	160	225	P	V
<b>Remark</b>	1. No other spurious found. 2. All results are PASS against Peak and Average limit line.												



**Band 2 - 5250~5350MHz**  
**WIFI 802.11a (Band Edge @ 3m)**

WIFI	Note	Frequency	Level	Over	Limit	Read	Antenna	Cable	Preamp	Ant	Table	Peak	Pol.
Ant.				Limit	Line	Level	Factor	Loss	Factor	Pos	Pos	Avg.	
1		( MHz )	( dBμV/m )	( dB )	( dBμV/m )	( dBμV )	( dB/m )	( dB )	( dB )	( cm )	( deg )	( P/A )	( H/V )
802.11a CH 52 5260MHz		5150	52.39	-21.61	74	40.25	33.87	11.37	33.1	167	304	P	H
		5048.65	43.95	-10.05	54	32.15	33.74	11.16	33.1	167	304	A	H
	*	5260	102.79	-	-	90.25	34.02	11.62	33.1	167	304	P	H
	*	5260	96.7	-	-	84.16	34.02	11.62	33.1	167	304	A	H
		5443.92	52.46	-21.54	74	39.48	34.24	11.84	33.1	167	304	P	H
		5456.88	43.83	-10.17	54	30.83	34.26	11.84	33.1	167	304	A	H
		5050.4	51.74	-22.26	74	39.94	33.74	11.16	33.1	375	259	P	V
		5116.9	42.05	-11.95	54	29.95	33.83	11.37	33.1	375	259	A	V
	*	5260	101.93	-	-	89.39	34.02	11.62	33.1	375	259	P	V
	*	5260	96.1	-	-	83.56	34.02	11.62	33.1	375	259	A	V
		5443.68	52.85	-21.15	74	39.87	34.24	11.84	33.1	375	259	P	V
		5429.52	42.7	-11.3	54	29.72	34.24	11.84	33.1	375	259	A	V
802.11a CH 60 5300MHz		5041.3	52.43	-21.57	74	40.63	33.74	11.16	33.1	156	302	P	H
		5066.15	43.88	-10.12	54	32.06	33.76	11.16	33.1	156	302	A	H
	*	5300	103.15	-	-	90.52	34.07	11.66	33.1	156	302	P	H
	*	5300	96.64	-	-	84.01	34.07	11.66	33.1	156	302	A	H
		5454.96	52.66	-21.34	74	39.66	34.26	11.84	33.1	156	302	P	H
		5452.56	43.99	-10.01	54	30.99	34.26	11.84	33.1	156	302	A	H
		5086.8	50.81	-23.19	74	38.86	33.79	11.26	33.1	375	259	P	V
		5110.95	41.98	-12.02	54	29.99	33.83	11.26	33.1	375	259	A	V
	*	5300	102.48	-	-	89.85	34.07	11.66	33.1	375	259	P	V
	*	5300	95.95	-	-	83.32	34.07	11.66	33.1	375	259	A	V
		5356.56	50.89	-23.11	74	38.12	34.13	11.74	33.1	375	259	P	V
		5413.68	42.83	-11.17	54	29.93	34.22	11.78	33.1	375	259	A	V



802.11a CH 64 5320MHz	*	5320	102.1	-	-	89.41	34.09	11.7	33.1	157	305	P	H
	*	5320	96.19	-	-	83.5	34.09	11.7	33.1	157	305	A	H
		5434.08	53.56	-20.44	74	40.58	34.24	11.84	33.1	157	305	P	H
		5350.24	44.29	-9.71	54	31.52	34.13	11.74	33.1	157	305	A	H
	*	5320	101.91	-	-	89.22	34.09	11.7	33.1	375	261	P	V
	*	5320	95.05	-	-	82.36	34.09	11.7	33.1	375	261	A	V
		5358.56	52.3	-21.7	74	39.53	34.13	11.74	33.1	375	261	P	V
		5350.72	44.01	-9.99	54	31.24	34.13	11.74	33.1	375	261	A	V
Remark	<ol style="list-style-type: none"> <li>No other spurious found.</li> <li>All results are PASS against Peak and Average limit line.</li> </ol>												



Band 2 5250~5350MHz

WIFI 802.11a (Harmonic @ 3m)

WIFI Ant. 1	Note	Frequency ( MHz )	Level ( dBμV/m )	Over Limit ( dB )	Limit Line ( dBμV/m )	Read Level (dBμV)	Antenna Factor ( dB/m )	Cable Loss ( dB )	Preamp Factor ( dB )	Ant Pos ( cm )	Table Pos ( deg )	Peak Avg. (P/A)	Pol. (H/V)
802.11a CH 52 5260MHz		10520	54.55	-19.45	74	58.7	37.11	14.65	55.91	150	220	P	H
		10520	50.53	-3.47	54	54.68	37.11	14.65	55.91	150	220	A	H
		15780	50.9	-23.1	74	49.28	41.36	16.51	56.25	159	345	P	H
		10520	50.66	-23.34	74	54.81	37.11	14.65	55.91	150	220	P	V
		15780	50.64	-23.36	74	49.02	41.36	16.51	56.25	159	345	P	V
802.11a CH 60 5300MHz		10600	50.26	-23.74	74	54.37	37.16	14.67	55.94	185	215	P	H
		15900	50.65	-23.35	74	48.42	41.65	16.59	56.01	196	190	P	H
		10600	49.74	-24.26	74	53.85	37.16	14.67	55.94	185	215	P	V
		15900	50.49	-23.51	74	48.26	41.65	16.59	56.01	196	190	P	V
802.11a CH 64 5320MHz		10640	49.73	-24.27	74	53.83	37.18	14.68	55.96	152	135	P	H
		15960	50.66	-23.34	74	48.07	41.82	16.64	55.87	173	245	P	H
		10640	50.69	-23.31	74	54.79	37.18	14.68	55.96	152	135	P	V
		15960	50.28	-23.72	74	47.69	41.82	16.64	55.87	173	245	P	V
<b>Remark</b>	<ol style="list-style-type: none"> <li>No other spurious found.</li> <li>All results are PASS against Peak and Average limit line.</li> </ol>												



**Band 2 5250~5350MHz**  
**WIFI 802.11n HT20 (Band Edge @ 3m)**

WIFI Ant. 1	Note	Frequency ( MHz )	Level ( dBμV/m )	Over Limit ( dB )	Limit Line ( dBμV/m )	Read Level ( dBμV )	Antenna Factor ( dB/m )	Cable Loss ( dB )	Preamp Factor ( dB )	Ant Pos ( cm )	Table Pos ( deg )	Peak Avg. ( P/A )	Pol. ( H/V )
802.11n HT20 CH 52 5260MHz		5113.4	50.35	-23.65	74	38.36	33.83	11.26	33.1	100	215	P	H
		5139.65	45.02	-8.98	54	32.88	33.87	11.37	33.1	100	215	A	H
	*	5260	101.68	-	-	89.14	34.02	11.62	33.1	100	215	P	H
	*	5260	95.64	-	-	83.1	34.02	11.62	33.1	100	215	A	H
		5356.32	50.64	-23.36	74	37.87	34.13	11.74	33.1	100	215	P	H
		5452.56	44.44	-9.56	54	31.44	34.26	11.84	33.1	100	215	A	H
		5020.3	53.01	-20.99	74	41.36	33.7	11.05	33.1	384	277	P	V
		5093.45	43.91	-10.09	54	31.94	33.81	11.26	33.1	384	277	A	V
	*	5260	104.4	-	-	91.86	34.02	11.62	33.1	384	277	P	V
	*	5260	97.14	-	-	84.6	34.02	11.62	33.1	384	277	A	V
		5436.24	52.48	-21.52	74	39.5	34.24	11.84	33.1	384	277	P	V
		5455.44	44.02	-9.98	54	31.02	34.26	11.84	33.1	384	277	A	V
802.11n HT20 CH 60 5300MHz		5107.45	52.89	-21.11	74	40.9	33.83	11.26	33.1	100	55	P	H
		5059.5	45.59	-8.41	54	33.77	33.76	11.16	33.1	100	55	A	H
	*	5300	102.59	-	-	89.96	34.07	11.66	33.1	100	55	P	H
	*	5300	95.49	-	-	82.86	34.07	11.66	33.1	100	55	A	H
		5458.32	51.27	-22.73	74	38.27	34.26	11.84	33.1	100	55	P	H
		5432.64	44.69	-9.31	54	31.71	34.24	11.84	33.1	100	55	A	H
		5113.75	52.54	-21.46	74	40.55	33.83	11.26	33.1	384	277	P	V
		5091	43.96	-10.04	54	31.99	33.81	11.26	33.1	384	277	A	V
	*	5300	104.49	-	-	91.86	34.07	11.66	33.1	384	277	P	V
	*	5300	97.03	-	-	84.4	34.07	11.66	33.1	384	277	A	V
	5390.16	52.03	-21.97	74	39.17	34.18	11.78	33.1	384	277	P	V	
	5351.04	44.2	-9.8	54	31.43	34.13	11.74	33.1	384	277	A	V	



802.11n HT20 CH 64 5320MHz	*	5320	102.3	-	-	89.61	34.09	11.7	33.1	100	66	P	H
	*	5320	95.6	-	-	82.91	34.09	11.7	33.1	100	66	A	H
		5352.48	53.28	-20.72	74	40.51	34.13	11.74	33.1	100	66	P	H
		5350.08	45.21	-8.79	54	32.44	34.13	11.74	33.1	100	66	A	H
	*	5320	105.62	-	-	92.93	34.09	11.7	33.1	367	255	P	V
	*	5320	97.49	-	-	84.8	34.09	11.7	33.1	367	255	A	V
		5351.84	53.88	-20.12	74	41.11	34.13	11.74	33.1	367	255	P	V
		5350.08	46.31	-7.69	54	33.54	34.13	11.74	33.1	367	255	A	V
Remark	<ol style="list-style-type: none"> <li>No other spurious found.</li> <li>All results are PASS against Peak and Average limit line.</li> </ol>												



**Band 2 5250~5350MHz**  
**WIFI 802.11n HT20 (Harmonic @ 3m)**

WIFI Ant. 1	Note	Frequency ( MHz )	Level ( dBμV/m )	Over Limit ( dB )	Limit Line ( dBμV/m )	Read Level (dBμV)	Antenna Factor ( dB/m )	Cable Loss ( dB )	Preamp Factor ( dB )	Ant Pos ( cm )	Table Pos ( deg )	Peak Avg. (P/A)	Pol. (H/V)
802.11n HT20 CH 52 5260MHz		10520	54.91	-19.09	74	59.06	37.11	14.65	55.91	150	220	P	H
		10520	49.97	-4.03	54	54.12	37.11	14.65	55.91	151	360	A	H
		15780	50.81	-23.19	74	49.19	41.36	16.51	56.25	159	345	P	H
		10520	50.85	-23.15	74	55	37.11	14.65	55.91	150	220	P	V
		10520	48.6	-5.4	54	52.75	37.11	14.65	55.91	150	220	A	V
		15780	50.42	-23.58	74	48.8	41.36	16.51	56.25	159	345	P	V
802.11n HT20 CH 60 5300MHz		10600	54.72	-19.28	74	58.83	37.16	14.67	55.94	185	215	P	H
		10600	50.45	-3.55	54	54.56	37.16	14.67	55.94	185	215	A	H
		15900	50.96	-23.04	74	48.73	41.65	16.59	56.01	196	190	P	H
		10600	54.52	-19.48	74	58.63	37.16	14.67	55.94	185	215	P	V
		10600	48.34	-5.66	54	52.45	37.16	14.67	55.94	185	215	A	V
		15900	50.54	-23.46	74	48.31	41.65	16.59	56.01	196	190	P	V
802.11n HT20 CH 64 5320MHz		10520	55.44	-18.56	74	59.59	37.11	14.65	55.91	150	220	P	H
		10520	50.31	-3.69	54	54.46	37.11	14.65	55.91	150	220	A	H
		15780	50.45	-23.55	74	48.83	41.36	16.51	56.25	159	345	P	H
		10640	49.84	-24.16	74	53.94	37.18	14.68	55.96	152	135	P	V
		15960	50.56	-23.44	74	47.97	41.82	16.64	55.87	173	245	P	V
<b>Remark</b>	1. No other spurious found. 2. All results are PASS against Peak and Average limit line.												



**Band 2 5250~5350MHz**  
**WIFI 802.11n HT40 (Band Edge @ 3m)**

WIFI Ant. 1	Note	Frequency ( MHz )	Level ( dBμV/m )	Over Limit ( dB )	Limit Line ( dBμV/m )	Read Level ( dBμV )	Antenna Factor ( dB/m )	Cable Loss ( dB )	Preamp Factor ( dB )	Ant Pos ( cm )	Table Pos ( deg )	Peak Avg. ( P/A )	Pol. ( H/V )	
802.11n HT40 CH 54 5270MHz		5033.8	52.74	-21.26	74	41.07	33.72	11.05	33.1	158	303	P	H	
		5134.16	42.32	-11.68	54	30.2	33.85	11.37	33.1	158	303	A	H	
	*	5270	100.62	-	-	88.08	34.02	11.62	33.1	158	303	P	H	
	*	5270	91.79	-	-	79.25	34.02	11.62	33.1	158	303	A	H	
		5456.16	52.82	-21.18	74	39.82	34.26	11.84	33.1	158	303	P	H	
		5354.64	41.87	-12.13	54	29.1	34.13	11.74	33.1	158	303	A	H	
		5007.8	52.33	-21.67	74	40.68	33.7	11.05	33.1	150	268	P	V	
		5067.08	42.32	-11.68	54	30.5	33.76	11.16	33.1	150	268	A	V	
	*	5270	97.09	-	-	84.55	34.02	11.62	33.1	150	268	P	V	
	*	5270	89.91	-	-	77.37	34.02	11.62	33.1	150	268	A	V	
		5435.76	52.75	-21.25	74	39.77	34.24	11.84	33.1	150	268	P	V	
		5453.04	41.64	-12.36	54	28.64	34.26	11.84	33.1	150	268	A	V	
	802.11n HT40 CH 62 5310MHz		5128.1	52.86	-21.14	74	40.74	33.85	11.37	33.1	164	312	P	H
			5099.75	42.45	-11.55	54	30.48	33.81	11.26	33.1	164	312	A	H
*		5310	98.78	-	-	86.09	34.09	11.7	33.1	164	312	P	H	
*		5310	90.41	-	-	77.72	34.09	11.7	33.1	164	312	A	H	
		5350.08	55.98	-18.02	74	43.21	34.13	11.74	33.1	164	312	P	H	
		5350.56	47.47	-6.53	54	34.7	34.13	11.74	33.1	164	312	A	H	
		5136.85	52.87	-21.13	74	40.75	33.85	11.37	33.1	150	268	P	V	
		5065.45	42.44	-11.56	54	30.62	33.76	11.16	33.1	150	268	A	V	
*		5310	97.5	-	-	84.81	34.09	11.7	33.1	150	268	P	V	
*		5310	89.92	-	-	77.23	34.09	11.7	33.1	150	268	A	V	
	5350.32	54.41	-19.59	74	41.64	34.13	11.74	33.1	150	268	P	V		
	5350.08	46.14	-7.86	54	33.37	34.13	11.74	33.1	150	268	A	V		
<b>Remark</b>	1. No other spurious found. 2. All results are PASS against Peak and Average limit line.													



**Band 2 5250~5350MHz**  
**WIFI 802.11n HT40 (Harmonic @ 3m)**

WIFI Ant. 1	Note	Frequency ( MHz )	Level ( dBμV/m )	Over Limit ( dB )	Limit Line ( dBμV/m )	Read Level (dBμV)	Antenna Factor ( dB/m )	Cable Loss ( dB )	Preamp Factor ( dB )	Ant Pos ( cm )	Table Pos ( deg )	Peak Avg. (P/A)	Pol. (H/V)
802.11n HT40 CH 54 5270MHz		10540	50.54	-23.46	74	54.68	37.12	14.66	55.92	150	220	P	H
		15810	50.33	-23.67	74	48.54	41.44	16.53	56.18	168	345	P	H
		10540	50.06	-23.94	74	54.2	37.12	14.66	55.92	150	220	P	V
		15810	50.04	-23.96	74	48.25	41.44	16.53	56.18	168	345	P	V
802.11n HT40 CH 62 5310MHz		10620	50.89	-23.11	74	54.99	37.17	14.68	55.95	150	220	P	H
		15930	50.14	-23.86	74	47.73	41.73	16.62	55.94	160	100	P	H
		10620	50.09	-23.91	74	54.19	37.17	14.68	55.95	150	220	P	V
		15930	50.51	-23.49	74	48.1	41.73	16.62	55.94	160	100	P	V
<b>Remark</b>	1. No other spurious found. 2. All results are PASS against Peak and Average limit line.												



**Band 2 5250~5350MHz**  
**WIFI 802.11ac VHT80 (Band Edge @ 3m)**

WIFI Ant. 1	Note	Frequency ( MHz )	Level ( dBμV/m )	Over Limit ( dB )	Limit Line ( dBμV/m )	Read Level (dBμV)	Antenna Factor ( dB/m )	Cable Loss ( dB )	Preamp Factor ( dB )	Ant Pos ( cm )	Table Pos ( deg )	Peak Avg. (P/A)	Pol. (H/V)
802.11ac VHT80 CH 58 5290MHz		5056.35	55.68	-18.32	74	41.45	33.76	11.16	30.69	144	306	P	H
		5038.15	47.01	-6.99	54	32.8	33.74	11.16	30.69	144	306	A	H
	*	5290	96.66	-	-	81.65	34.05	11.66	30.7	144	306	P	H
	*	5290	90.13	-	-	75.12	34.05	11.66	30.7	144	306	A	H
		5362.8	58.07	-15.93	74	42.88	34.15	11.74	30.7	144	306	P	H
		5350.32	50.97	-3.03	54	35.8	34.13	11.74	30.7	144	306	A	H
		5109.55	56.45	-17.55	74	42.05	33.83	11.26	30.69	400	108	P	V
		5007.7	47	-7	54	32.94	33.7	11.05	30.69	400	108	A	V
	*	5290	95.07	-	-	80.06	34.05	11.66	30.7	400	108	P	V
	*	5290	88.77	-	-	73.76	34.05	11.66	30.7	400	108	A	V
		5360.88	54.91	-19.09	74	39.72	34.15	11.74	30.7	400	108	P	V
		5350.08	47.85	-6.15	54	32.68	34.13	11.74	30.7	400	108	A	V
<b>Remark</b>	1. No other spurious found. 2. All results are PASS against Peak and Average limit line.												



Band 2 5250~5350MHz
WIFI 802.11ac VHT80 (Harmonic @ 3m)

Table with 14 columns: WIFI Ant. 1, Note, Frequency (MHz), Level (dBµV/m), Over Limit (dB), Limit Line (dBµV/m), Read Level (dBµV), Antenna Factor (dB/m), Cable Loss (dB), Preamp Factor (dB), Ant Pos (cm), Table Pos (deg), Peak Avg. (P/A), Pol. (H/V). Rows include 802.11ac VHT80 CH 58 5290MHz and a Remark section.



**Band 3 - 5470~5725MHz**  
**WIFI 802.11a (Band Edge @ 3m)**

WIFI	Note	Frequency	Level	Over	Limit	Read	Antenna	Cable	Preamp	Ant	Table	Peak	Pol.
Ant.				Limit	Line	Level	Factor	Loss	Factor	Pos	Pos	Avg.	
1		( MHz )	( dBμV/m )	( dB )	( dBμV/m )	( dBμV )	( dB/m )	( dB )	( dB )	( cm )	( deg )	( P/A )	( H/V )
802.11a CH 100 5500MHz		5469.68	54.79	-19.21	74	41.71	34.28	11.9	33.1	400	232	P	H
		5470	45.68	-8.32	54	32.6	34.28	11.9	33.1	400	232	A	H
	*	5500	101.16	-	-	88.03	34.33	11.9	33.1	400	232	P	H
	*	5500	93.98	-	-	80.85	34.33	11.9	33.1	400	232	A	H
		5468.88	54.48	-19.52	74	41.4	34.28	11.9	33.1	364	247	P	V
		5469.84	45.46	-8.54	54	32.38	34.28	11.9	33.1	364	247	A	V
	*	5500	98.58	-	-	85.45	34.33	11.9	33.1	364	247	P	V
	*	5500	92.22	-	-	79.09	34.33	11.9	33.1	364	247	A	V
802.11a CH 116 5580MHz		5437.6	51.78	-22.22	74	38.8	34.24	11.84	33.1	150	307	P	H
		5465.44	44	-10	54	30.98	34.28	11.84	33.1	150	307	A	H
	*	5580	100.66	-	-	87.32	34.41	12.03	33.1	150	307	P	H
	*	5580	94.36	-	-	81.02	34.41	12.03	33.1	150	307	A	H
		5761.22	53.04	-20.96	74	39.04	34.45	12.65	33.1	150	307	P	H
		5727.2	44.55	-9.45	54	30.68	34.46	12.51	33.1	150	307	A	H
		5391.76	50.88	-23.12	74	38.02	34.18	11.78	33.1	365	259	P	V
		5403.28	42.63	-11.37	54	29.75	34.2	11.78	33.1	365	259	A	V
	*	5580	99.46	-	-	86.12	34.41	12.03	33.1	365	259	P	V
	*	5580	92.19	-	-	78.85	34.41	12.03	33.1	365	259	A	V
		5735.705	51.33	-22.67	74	37.47	34.45	12.51	33.1	365	259	P	V
		5726.57	43.15	-10.85	54	29.28	34.46	12.51	33.1	365	259	A	V



802.11a CH 140 5700MHz	*	5700	101.05	-	-	87.16	34.48	12.51	33.1	158	305	P	H
	*	5700	95.29	-	-	81.4	34.48	12.51	33.1	158	305	A	H
		5725.08	56.64	-17.36	74	42.77	34.46	12.51	33.1	158	305	P	H
		5725.24	48.95	-5.05	54	35.08	34.46	12.51	33.1	158	305	A	H
	*	5700	99.73	-	-	85.84	34.48	12.51	33.1	364	259	P	V
	*	5700	94.14	-	-	80.25	34.48	12.51	33.1	364	259	A	V
		5725	57.41	-16.59	74	43.54	34.46	12.51	33.1	364	259	P	V
		5725	48.46	-5.54	54	34.59	34.46	12.51	33.1	364	259	A	V
Remark	<ol style="list-style-type: none"> <li>No other spurious found.</li> <li>All results are PASS against Peak and Average limit line.</li> </ol>												



**Band 3 - 5470~5725MHz**  
**WIFI 802.11a (Harmonic @ 3m)**

WIFI Ant. 1	Note	Frequency ( MHz )	Level ( dBμV/m )	Over Limit ( dB )	Limit Line ( dBμV/m )	Read Level (dBμV)	Antenna Factor ( dB/m )	Cable Loss ( dB )	Preamp Factor ( dB )	Ant Pos ( cm )	Table Pos ( deg )	Peak Avg. (P/A)	Pol. (H/V)
802.11a CH 100 5500MHz		11100	50.31	-23.69	74	54.01	37.46	14.79	55.95	150	200	P	H
		16650	50.12	-23.88	74	45.19	43.68	17.38	56.13	180	350	P	H
		11100	50.15	-23.85	74	53.85	37.46	14.79	55.95	150	200	P	V
		16650	50.37	-23.63	74	45.44	43.68	17.38	56.13	180	350	P	V
802.11a CH 116 5580MHz		11160	50.62	-23.38	74	54.16	37.5	14.81	55.85	170	200	P	H
		16740	50.78	-23.22	74	45.53	43.91	17.51	56.17	156	350	P	H
		11160	49.65	-24.35	74	53.19	37.5	14.81	55.85	170	200	P	V
		16740	50.36	-23.64	74	45.11	43.91	17.51	56.17	156	350	P	V
802.11a CH 140 5700MHz		11400	51.72	-22.28	74	54.71	37.64	14.86	55.49	157	285	P	H
		17100	50.11	-23.89	74	44.29	44.29	17.91	56.38	165	246	P	H
		11400	51.39	-22.61	74	54.38	37.64	14.86	55.49	157	285	P	V
		17100	50.12	-23.88	74	44.3	44.29	17.91	56.38	165	246	P	V
<b>Remark</b>	1. No other spurious found. 2. All results are PASS against Peak and Average limit line.												



**Band 3 - 5470~5725MHz**  
**WIFI 802.11n HT20 (Band Edge @ 3m)**

WIFI Ant. 1	Note	Frequency ( MHz )	Level ( dBμV/m )	Over Limit ( dB )	Limit Line ( dBμV/m )	Read Level (dBμV)	Antenna Factor ( dB/m )	Cable Loss ( dB )	Preamp Factor ( dB )	Ant Pos ( cm )	Table Pos ( deg )	Peak Avg. (P/A)	Pol. (H/V)
802.11n HT20 CH 100 5500MHz		5468.4	54.48	-19.52	74	41.4	34.28	11.9	33.1	100	59	P	H
		5470	47.97	-6.03	54	34.89	34.28	11.9	33.1	100	59	A	H
	*	5500	101.2	-	-	88.07	34.33	11.9	33.1	100	59	P	H
	*	5500	94.49	-	-	81.36	34.33	11.9	33.1	100	59	A	H
		5465.52	55.51	-18.49	74	42.43	34.28	11.9	33.1	359	254	P	V
		5469.68	48.13	-5.87	54	35.05	34.28	11.9	33.1	359	254	A	V
	*	5500	102.31	-	-	89.18	34.33	11.9	33.1	359	254	P	V
		5500	94.63	-	-	81.5	34.33	11.9	33.1	359	254	A	V
802.11n HT20 CH 116 5580MHz		5445.04	51.11	-22.89	74	38.13	34.24	11.84	33.1	100	59	P	H
		5443.12	44.06	-9.94	54	31.08	34.24	11.84	33.1	100	59	A	H
	*	5580	101.56	-	-	88.22	34.41	12.03	33.1	100	59	P	H
	*	5580	95.15	-	-	81.81	34.41	12.03	33.1	100	59	A	H
		5736.335	52.14	-21.86	74	38.28	34.45	12.51	33.1	100	59	P	H
		5733.5	46.09	-7.91	54	32.22	34.46	12.51	33.1	100	59	A	H
		5433.76	51.81	-22.19	74	38.83	34.24	11.84	33.1	364	267	P	V
		5463.28	44.15	-9.85	54	31.13	34.28	11.84	33.1	364	267	A	V
	*	5580	102.63	-	-	89.29	34.41	12.03	33.1	364	267	P	V
	*	5580	94.74	-	-	81.4	34.41	12.03	33.1	364	267	A	V
		5738.54	52.72	-21.28	74	38.72	34.45	12.65	33.1	364	267	P	V
	5763.425	44.51	-9.49	54	30.51	34.45	12.65	33.1	364	267	A	V	



802.11n HT20 CH 140 5700MHz	*	5700	102.11	-	-	88.22	34.48	12.51	33.1	100	60	P	H
	*	5700	94.36	-	-	80.47	34.48	12.51	33.1	100	60	A	H
		5725.72	59.19	-14.81	74	45.32	34.46	12.51	33.1	100	60	P	H
		5725.24	50.08	-3.92	54	36.21	34.46	12.51	33.1	100	60	A	H
	*	5700	100.92	-	-	87.03	34.48	12.51	33.1	100	119	P	V
	*	5700	94.26	-	-	80.37	34.48	12.51	33.1	100	119	A	V
		5725.64	59.23	-14.77	74	45.36	34.46	12.51	33.1	100	119	P	V
		5725.08	49.04	-4.96	54	35.17	34.46	12.51	33.1	100	119	A	V
Remark	<ol style="list-style-type: none"> <li>No other spurious found.</li> <li>All results are PASS against Peak and Average limit line.</li> </ol>												



**Band 3 - 5470~5725MHz**  
**WIFI 802.11n HT20 (Harmonic @ 3m)**

WIFI Ant. 1	Note	Frequency ( MHz )	Level ( dBμV/m )	Over Limit ( dB )	Limit Line ( dBμV/m )	Read Level (dBμV)	Antenna Factor ( dB/m )	Cable Loss ( dB )	Preamp Factor ( dB )	Ant Pos ( cm )	Table Pos ( deg )	Peak Avg. (P/A)	Pol. (H/V)
802.11n HT20 CH 100 5500MHz		11000	52.72	-21.28	74	56.66	37.4	14.76	56.1	163	230	P	H
		11000	49.07	-4.93	54	53.01	37.4	14.76	56.1	163	230	A	H
		16500	50.41	-23.59	74	45.99	43.27	17.2	56.05	178	296	P	H
		11000	49.79	-24.21	74	53.73	37.4	14.76	56.1	163	230	P	V
		16500	50.38	-23.62	74	45.96	43.27	17.2	56.05	178	296	P	V
802.11n HT20 CH 116 5580MHz		11160	50.8	-23.2	74	54.34	37.5	14.81	55.85	170	200	P	H
		16740	50.54	-23.46	74	45.29	43.91	17.51	56.17	156	350	P	H
		11160	49.76	-24.24	74	53.3	37.5	14.81	55.85	170	200	P	V
		16740	50.43	-23.57	74	45.18	43.91	17.51	56.17	156	350	P	V
802.11n HT20 CH 140 5700MHz		11400	50.63	-23.37	74	53.62	37.64	14.86	55.49	157	285	P	H
		17100	50.1	-23.9	74	44.28	44.29	17.91	56.38	165	246	P	H
		11400	49.39	-24.61	74	52.38	37.64	14.86	55.49	157	285	P	V
		17100	50.79	-23.21	74	44.97	44.29	17.91	56.38	165	246	P	V
<b>Remark</b>	1. No other spurious found. 2. All results are PASS against Peak and Average limit line.												



**Band 3 - 5470~5725MHz**  
**WIFI 802.11n HT40 (Band Edge @ 3m)**

WIFI Ant. 1	Note	Frequency ( MHz )	Level ( dBμV/m )	Over Limit ( dB )	Limit Line ( dBμV/m )	Read Level ( dBμV )	Antenna Factor ( dB/m )	Cable Loss ( dB )	Preamp Factor ( dB )	Ant Pos ( cm )	Table Pos ( deg )	Peak Avg. ( P/A )	Pol. ( H/V )
802.11n HT40 CH 102 5510MHz		5469.28	62.08	-11.92	74	49	34.28	11.9	33.1	158	309	P	H
		5470	50.8	-3.2	54	37.72	34.28	11.9	33.1	158	309	A	H
	*	5510	98.2	-	-	85	34.33	11.97	33.1	158	309	P	H
	*	5510	89.78	-	-	76.58	34.33	11.97	33.1	158	309	A	H
		5745.155	53.55	-20.45	74	39.55	34.45	12.65	33.1	158	309	P	H
		5747.36	43.12	-10.88	54	29.12	34.45	12.65	33.1	158	309	A	H
		5468.32	59.15	-14.85	74	46.07	34.28	11.9	33.1	164	255	P	V
		5470	48.93	-5.07	54	35.85	34.28	11.9	33.1	164	255	A	V
	*	5510	95.19	-	-	81.99	34.33	11.97	33.1	164	255	P	V
	*	5510	86.31	-	-	73.11	34.33	11.97	33.1	164	255	A	V
		5757.755	53.36	-20.64	74	39.36	34.45	12.65	33.1	164	255	P	V
		5751.77	43.15	-10.85	54	29.15	34.45	12.65	33.1	164	255	A	V
802.11n HT40 CH 110 5550MHz		5453.92	52.62	-21.38	74	39.62	34.26	11.84	33.1	157	308	P	H
		5468.32	42.16	-11.84	54	29.08	34.28	11.9	33.1	157	308	A	H
	*	5550	97.34	-	-	84.02	34.39	12.03	33.1	157	308	P	H
	*	5550	88.83	-	-	75.51	34.39	12.03	33.1	157	308	A	H
		5755.865	53.18	-20.82	74	39.18	34.45	12.65	33.1	157	308	P	H
		5743.895	42.98	-11.02	54	28.98	34.45	12.65	33.1	157	308	A	H
		5357.44	52.79	-21.21	74	40.02	34.13	11.74	33.1	167	272	P	V
		5466.88	42.23	-11.77	54	29.15	34.28	11.9	33.1	167	272	A	V
	*	5550	94.03	-	-	80.71	34.39	12.03	33.1	167	272	P	V
	*	5550	85.78	-	-	72.46	34.39	12.03	33.1	167	272	A	V
	5749.88	52.43	-21.57	74	38.43	34.45	12.65	33.1	167	272	P	V	
	5733.185	43.02	-10.98	54	29.15	34.46	12.51	33.1	167	272	A	V	



802.11n HT40 CH 134 5670MHz		5450.8	51.46	-22.54	74	38.46	34.26	11.84	33.1	157	308	P	H
		5467.6	42.02	-11.98	54	28.94	34.28	11.9	33.1	157	308	A	H
	*	5670	97.12	-	-	83.37	34.48	12.37	33.1	157	308	P	H
	*	5670	88.35	-	-	74.6	34.48	12.37	33.1	157	308	A	H
		5738.225	53.97	-20.03	74	40.11	34.45	12.51	33.1	157	308	P	H
		5726.675	43.37	-10.63	54	29.5	34.46	12.51	33.1	157	308	A	H
		5358.05	52.6	-21.4	74	39.83	34.13	11.74	33.1	173	246	P	V
		5453.95	41.72	-12.28	54	28.72	34.26	11.84	33.1	173	246	A	V
	*	5670	94.27	-	-	80.52	34.48	12.37	33.1	173	246	P	V
	*	5670	86.32	-	-	72.57	34.48	12.37	33.1	173	246	A	V
		5735.25	54.32	-19.68	74	40.46	34.45	12.51	33.1	173	246	P	V
		5726.675	43.2	-10.8	54	29.33	34.46	12.51	33.1	173	246	A	V
<b>Remark</b>	1. No other spurious found. 2. All results are PASS against Peak and Average limit line.												



**Band 3 - 5470~5725MHz**  
**WIFI 802.11n HT40 (Harmonic @ 3m)**

WIFI Ant. 1	Note	Frequency ( MHz )	Level ( dBμV/m )	Over Limit ( dB )	Limit Line ( dBμV/m )	Read Level ( dBμV )	Antenna Factor ( dB/m )	Cable Loss ( dB )	Preamp Factor ( dB )	Ant Pos ( cm )	Table Pos ( deg )	Peak Avg. ( P/A )	Pol. ( H/V )
802.11n		11020	50.9	-23.1	74	54.79	37.41	14.77	56.07	170	230	P	H
HT40		16530	50.86	-23.14	74	46.32	43.36	17.25	56.07	160	300	P	H
CH 102		11020	50.19	-23.81	74	54.08	37.41	14.77	56.07	170	230	P	V
5510MHz		16530	50.61	-23.39	74	46.07	43.36	17.25	56.07	160	300	P	V
802.11n		11100	50.17	-23.83	74	53.87	37.46	14.79	55.95	150	200	P	H
HT40		16650	50.23	-23.77	74	45.3	43.68	17.38	56.13	180	350	P	H
CH 110		11100	50.14	-23.86	74	53.84	37.46	14.79	55.95	150	200	P	V
5550MHz		16650	50.31	-23.69	74	45.38	43.68	17.38	56.13	180	350	P	V
802.11n		11340	50.91	-23.09	74	54.06	37.6	14.84	55.59	200	360	P	H
HT40		17010	50.05	-23.95	74	43.99	44.55	17.82	56.31	200	360	P	H
CH 134		11340	50.88	-23.12	74	54.03	37.6	14.84	55.59	200	360	P	V
5670MHz		17010	50.35	-23.65	74	44.29	44.55	17.82	56.31	200	360	P	V
<b>Remark</b>	1. No other spurious found. 2. All results are PASS against Peak and Average limit line.												



**Band 2 5470~5725MHz**  
**WIFI 802.11ac VHT80 (Band Edge @ 3m)**

WIFI Ant. 1	Note	Frequency ( MHz )	Level ( dBμV/m )	Over Limit ( dB )	Limit Line ( dBμV/m )	Read Level ( dBμV )	Antenna Factor ( dB/m )	Cable Loss ( dB )	Preamp Factor ( dB )	Ant Pos ( cm )	Table Pos ( deg )	Peak Avg. ( P/A )	Pol. ( H/V )
802.11ac VHT80 CH 106 5530MHz		5457.76	56.99	-17.01	74	41.59	34.26	11.84	30.7	241	301	P	H
		5461.84	49.44	-4.56	54	34.04	34.26	11.84	30.7	241	301	A	H
	*	5530	93.82	-	-	78.22	34.35	11.97	30.72	241	301	P	H
	*	5530	87.63	-	-	72.03	34.35	11.97	30.72	241	301	A	H
		5744.525	55.98	-18.02	74	39.79	34.45	12.65	30.91	241	301	P	H
		5757.125	47.33	-6.67	54	31.16	34.45	12.65	30.93	241	301	A	H
		5464	56.74	-17.26	74	41.32	34.28	11.84	30.7	351	253	P	V
		5465.68	50.18	-3.82	54	34.7	34.28	11.9	30.7	351	253	A	V
	*	5530	95.82	-	-	80.22	34.35	11.97	30.72	351	253	P	V
	*	5530	89.63	-	-	74.03	34.35	11.97	30.72	351	253	A	V
		5734.445	54.36	-19.64	74	38.29	34.46	12.51	30.9	351	253	P	V
		5761.85	47.33	-6.67	54	31.16	34.45	12.65	30.93	351	253	A	V
802.11ac VHT80 CH 122 5610MHz		5466.88	54.5	-19.5	74	39.02	34.28	11.9	30.7	133	303	P	H
		5468.32	47.21	-6.79	54	31.73	34.28	11.9	30.7	133	303	A	H
	*	5610	96.68	-	-	80.92	34.46	12.09	30.79	133	303	P	H
	*	5610	90.39	-	-	74.63	34.46	12.09	30.79	133	303	A	H
		5730.665	55.98	-18.02	74	39.91	34.46	12.51	30.9	133	303	P	H
		5725	47.7	-6.3	54	31.63	34.46	12.51	30.9	133	303	A	H
		5451.28	55.78	-18.22	74	40.38	34.26	11.84	30.7	344	244	P	V
		5459.92	46.9	-7.1	54	31.5	34.26	11.84	30.7	344	244	A	V
	*	5614	97.5	-	-	81.74	34.46	12.09	30.79	344	244	P	V
	5725.94	55.18	-18.82	74	39.11	34.46	12.51	30.9	344	244	P	V	
	5727.2	47.53	-6.47	54	31.46	34.46	12.51	30.9	344	244	A	V	
<b>Remark</b>	1. No other spurious found. 2. All results are PASS against Peak and Average limit line.												



Band 3 5470~5725MHz
WIFI 802.11ac VHT80 (Harmonic @ 3m)

Table with 14 columns: WIFI Ant. 1, Note, Frequency (MHz), Level (dBµV/m), Over Limit (dB), Limit Line (dBµV/m), Read Level (dBµV), Antenna Factor (dB/m), Cable Loss (dB), Preamp Factor (dB), Ant Pos (cm), Table Pos (deg), Peak Avg. (P/A), Pol. (H/V). Rows include data for 802.11ac VHT80 CH 106 5530MHz and 802.11ac VHT80 CH 122 5610MHz.

Remark
1. No other spurious found.
2. All results are PASS against Peak and Average limit line.



Emission below 1GHz

WiFi 802.11ac VHT80 (LF @ 3m)

WiFi	Note	Frequency	Level	Over	Limit	Read	Antenna	Cable	Preamp	Ant	Table	Peak	Pol.
Ant.				Limit	Line	Level	Factor	Loss	Factor	Pos	Pos	Avg.	
1		( MHz )	( dBμV/m )	( dB )	( dBμV/m )	( dBμV )	( dB/m )	( dB )	( dB )	( cm )	( deg )	( P/A )	( H/V )
802.11ac VHT80 LF		34.85	22.43	-17.57	40	27.41	26.3	0.32	31.6	-	-	P	H
		173.56	24.95	-18.55	43.5	36.95	17.86	1.45	31.31	-	-	P	H
		207.51	26.47	-17.03	43.5	37.94	18.03	1.66	31.16	-	-	P	H
		228.85	26.23	-19.77	46	36.33	19.22	1.76	31.08	-	-	P	H
		454.86	31.95	-14.05	46	33.98	26.49	2.58	31.1	100	125	P	H
		982.54	29.24	-24.76	54	26.13	30.42	4.12	31.43	-	-	P	H
		32.91	32.89	-7.11	40	37.35	26.86	0.28	31.6	100	165	P	V
		172.59	20.41	-23.09	43.5	32.41	17.87	1.44	31.31	-	-	P	V
		207.51	22.75	-20.75	43.5	34.22	18.03	1.66	31.16	-	-	P	V
		228.85	21.4	-24.6	46	31.5	19.22	1.76	31.08	-	-	P	V
		434.49	28.68	-17.32	46	31.25	26.02	2.51	31.1	-	-	P	V
		851.59	26.75	-19.25	46	27.3	27.05	3.7	31.3	-	-	P	V
Remark	1. No other spurious found. 2. All results are PASS against limit line.												



Note symbol

*	<b>Fundamental Frequency</b> which can be ignored. However, the level of any unwanted emissions shall not exceed the level of the fundamental frequency.
!	Test result is <b>over limit</b> line.
P/A	<b>Peak</b> or <b>Average</b>
H/V	<b>Horizontal</b> or <b>Vertical</b>



A calculation example for radiated spurious emission is shown as below:

WIFI	Note	Frequency	Level	Over	Limit	Read	Antenna	Cable	Preamp	Ant	Table	Peak	Pol.
Ant.				Limit	Line	Level	Factor	Loss	Factor	Pos	Pos	Avg.	
1		( MHz )	( dBμV/m )	( dB )	( dBμV/m )	( dBμV )	( dB/m )	( dB )	( dB )	( cm )	( deg )	( P/A )	( H/V )
802.11b		2390	55.45	-18.55	74	54.51	32.22	4.58	35.86	103	308	P	H
CH 01													
2412MHz		2390	43.54	-10.46	54	42.6	32.22	4.58	35.86	103	308	A	H

- Level(dBμV/m) =  
Antenna Factor(dB/m) + Cable Loss(dB) + Read Level(dBμV) - Preamp Factor(dB)
- Over Limit(dB) = Level(dBμV/m) – Limit Line(dBμV/m)

**For Peak Limit @ 2390MHz:**

- Level(dBμV/m)  
= Antenna Factor(dB/m) + Cable Loss(dB) + Read Level(dBμV) - Preamp Factor(dB)  
= 32.22(dB/m) + 4.58(dB) + 54.51(dBμV) – 35.86 (dB)  
= 55.45 (dBμV/m)
- Over Limit(dB)  
= Level(dBμV/m) – Limit Line(dBμV/m)  
= 55.45(dBμV/m) – 74(dBμV/m)  
= -18.55(dB)

**For Average Limit @ 2390MHz:**

- Level(dBμV/m)  
= Antenna Factor(dB/m) + Cable Loss(dB) + Read Level(dBμV) - Preamp Factor(dB)  
= 32.22(dB/m) + 4.58(dB) + 42.6(dBμV) – 35.86 (dB)  
= 43.54 (dBμV/m)
- Over Limit(dB)  
= Level(dBμV/m) – Limit Line(dBμV/m)  
= 43.54(dBμV/m) – 54(dBμV/m)  
= -10.46(dB)

Both peak and average measured complies with the limit line, so test result is “PASS”.



### Appendix C. Duty Cycle Plots

Band	Duty Cycle(%)	T(ms)	1/T(kHz)	VBW Setting
802.11a	95.54	2.078	0.481	1 kHz
802.11n HT20	94.20	1.930	0.518	1 kHz
802.11n HT40	90.10	0.949	1.053	3 kHz
802.11ac VHT80	84.21	0.464	2.156	3 kHz

#### 802.11a

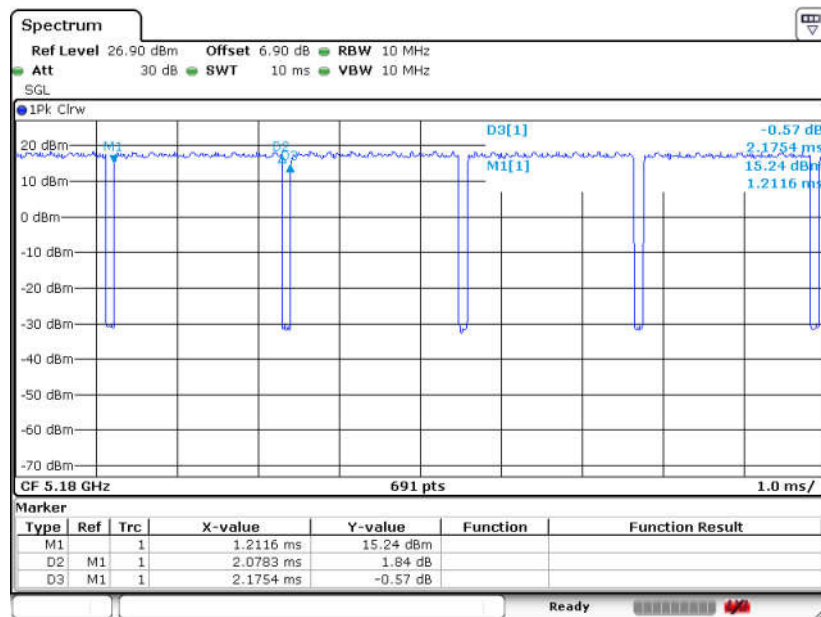



802.11n HT20

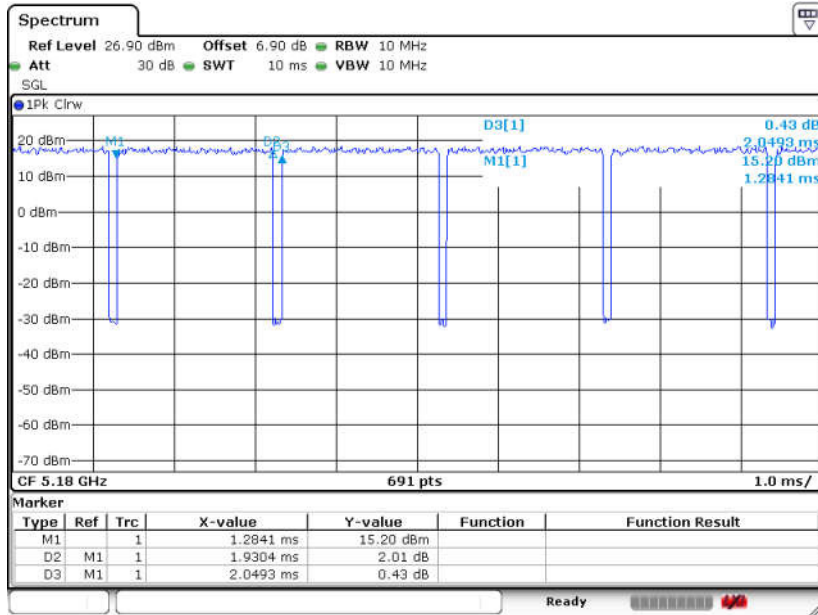

802.11n HT40

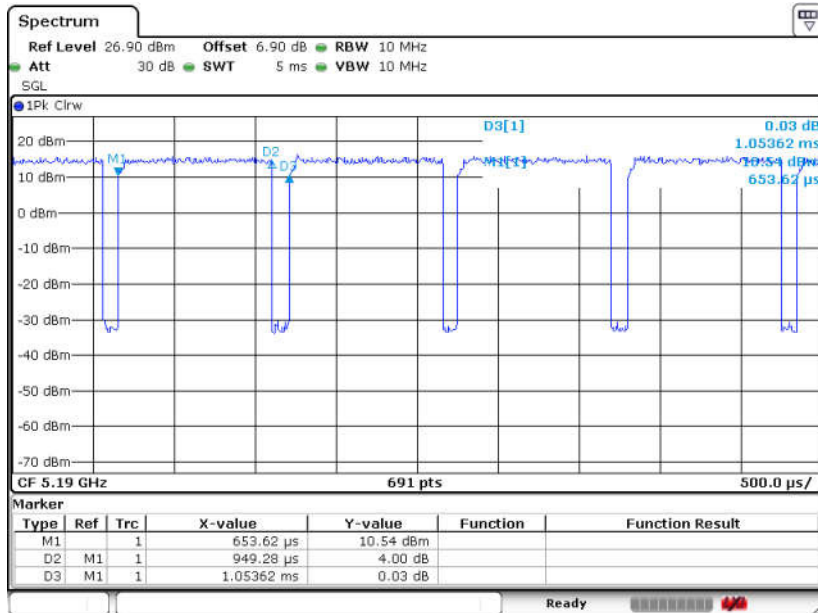



802.11ac VHT80

