



FCC RF Test Report

APPLICANT : Motorola Mobility, LLC
EQUIPMENT : Mobile Cellular Phone
BRAND NAME : Motorola
MODEL NAME : 10722
FCC ID : IHDT56WB4
STANDARD : FCC Part 15 Subpart C §15.247
CLASSIFICATION : (DTS) Digital Transmission System

The product was received on Mar. 31, 2017 and testing was completed on Apr. 25, 2017. We, SPORTON INTERNATIONAL INC., would like to declare that the tested sample has been evaluated in accordance with the test procedures and has been in compliance with the applicable technical standards.

The test results in this report apply exclusively to the tested model / sample. Without written approval of SPORTON INTERNATIONAL INC., the test report shall not be reproduced except in full.

Reviewed by: Joseph Lin / Supervisor

Approved by: Jones Tsai / Manager



SPORTON INTERNATIONAL INC.

No. 52, Hwa Ya 1st Rd., Hwa Ya Technology Park, Kwei-Shan District, Tao Yuan City, Taiwan, R.O.C.



TABLE OF CONTENTS

REVISION HISTORY.....3

SUMMARY OF TEST RESULT4

1 GENERAL DESCRIPTION5

 1.1 Applicant5

 1.2 Manufacturer5

 1.3 Product Feature of Equipment Under Test.....5

 1.4 Product Specification of Equipment Under Test.....7

 1.5 Modification of EUT7

 1.6 Testing Location8

 1.7 Applicable Standards9

2 TEST CONFIGURATION OF EQUIPMENT UNDER TEST10

 2.1 Carrier Frequency and Channel10

 2.2 Test Mode11

 2.3 Connection Diagram of Test System12

 2.4 Support Unit used in test configuration and system13

 2.5 EUT Operation Test Setup13

 2.6 Measurement Results Explanation Example13

3 TEST RESULT14

 3.1 6dB and 99% Bandwidth Measurement14

 3.2 Output Power Measurement16

 3.3 Power Spectral Density Measurement18

 3.4 Conducted Band Edges and Spurious Emission Measurement20

 3.5 Radiated Band Edges and Spurious Emission Measurement45

 3.6 AC Conducted Emission Measurement49

 3.7 Antenna Requirements53

4 LIST OF MEASURING EQUIPMENT54

5 UNCERTAINTY OF EVALUATION55

APPENDIX A. CONDUCTED TEST RESULTS

APPENDIX B. RADIATED SPURIOUS EMISSION

APPENDIX C. RADIATED SPURIOUS EMISSION PLOTS

APPENDIX D. DUTY CYCLE PLOTS



SUMMARY OF TEST RESULT

Report Section	FCC Rule	Description	Limit	Result	Remark
3.1	15.247(a)(2)	6dB Bandwidth	$\geq 0.5\text{MHz}$	Pass	-
3.1	-	99% Bandwidth	-	Pass	-
3.2	15.247(b)	Power Output Measurement	$\leq 30\text{dBm}$	Pass	-
3.3	15.247(e)	Power Spectral Density	$\leq 8\text{dBm}/3\text{kHz}$	Pass	-
3.4	15.247(d)	Conducted Band Edges	$\leq 20\text{dBc}$	Pass	-
		Conducted Spurious Emission		Pass	-
3.5	15.247(d)	Radiated Band Edges and Radiated Spurious Emission	15.209(a) & 15.247(d)	Pass	Under limit 0.30 dB at 2483.520 MHz
3.6	15.207	AC Conducted Emission	15.207(a)	Pass	Under limit 12.80 dB at 0.606 MHz
3.7	15.203 & 15.247(b)	Antenna Requirement	N/A	Pass	-



1 General Description

1.1 Applicant

Motorola Mobility, LLC

222 W Merchandise Mart Plaza, Suite 1800, Chicago, IL 60654, United States

1.2 Manufacturer

Motorola Mobility, LLC

222 W Merchandise Mart Plaza, Suite 1800, Chicago, IL 60654, United States

1.3 Product Feature of Equipment Under Test

Product Feature	
Equipment	Mobile Cellular Phone
Brand Name	Motorola
Model Name	10722
FCC ID	IHDT56WB4
IMEI Code	353311080000163 (for Radiation) 353311080000643 (for Conduction)
EUT supports Radios application	GSM/EGPRS/WCDMA/HSPA/LTE/NFC WLAN 11b/g/n HT20 WLAN 11a/n HT20/HT40 WLAN 11ac VHT20/VHT40/VHT80 Bluetooth BR/EDR/LE
HW Version	DVT2
EUT Stage	Identical Prototype

Remark: The above EUT's information was declared by manufacturer. Please refer to the specifications or user's manual for more detailed description.



Accessory List		
AC Adapter 1	Brand Name :	Motorola
	Model Name :	SPN5970A
AC Adapter 2	Brand Name :	Motorola
	Model Name :	SPN5993A
AC Adapter 3	Brand Name :	Motorola
	Model Name :	SPN5978A
Battery 1	Brand Name :	Motorola
	Model Name :	SNN5986A
Battery 2	Brand Name :	Motorola
	Model Name :	SNN5897A
Earphone	Brand Name :	Motorola
	Model Name :	SH38C16618
USB Cable	Brand Name :	Motorola
	Model Name :	SKN6473A
USB-C Data Cable	Brand Name :	Motorola
	Model Name :	SKN6474A



1.4 Product Specification of Equipment Under Test

Standards-related Product Specification										
Tx/Rx Channel Frequency Range	2412 MHz ~ 2462 MHz									
Maximum (Peak) Output Power to antenna	<p><Ant. 1> 802.11b : 22.27 dBm (0.1687 W) 802.11g : 23.85 dBm (0.2427 W) 802.11n HT20 : 23.73 dBm (0.2360 W) 802.11ac VHT20 : 23.75 dBm (0.2371 W)</p> <p><Ant. 2> 802.11b : 21.65 dBm (0.1462 W) 802.11g : 22.56 dBm (0.1803 W) 802.11n HT20 : 22.55 dBm (0.1799 W) 802.11ac VHT20 : 22.57 dBm (0.1807 W)</p> <p>MIMO <Ant. 1 + 2> 802.11b : 24.97 dBm (0.3141 W) 802.11g : 26.06 dBm (0.4036 W) 802.11n HT20 : 25.95 dBm (0.3936 W) 802.11ac VHT20 : 25.93 dBm (0.3917 W)</p>									
99% Occupied Bandwidth	<p>MIMO <Ant. 1> 802.11b : 12.90MHz 802.11g : 17.95MHz 802.11n HT20 : 19.15MHz 802.11ac VHT20 : 19.05MHz</p> <p>MIMO <Ant. 2> 802.11b : 13.20MHz 802.11g : 18.25MHz 802.11n HT20 : 19.45MHz 802.11ac VHT20 : 19.40MHz</p>									
Antenna Type / Gain	<p><Ant. 1> Fixed Internal Antenna type with gain -2.0 dBi</p> <p><Ant. 2> Fixed Internal Antenna type with gain -0.3 dBi</p>									
Type of Modulation	802.11b : DSSS (DBPSK / DQPSK / CCK) 802.11g/n : OFDM (BPSK / QPSK / 16QAM / 64QAM) 802.11ac : OFDM (BPSK / QPSK / 16QAM / 64QAM / 256QAM)									
Antenna Function for Transmitter	<table border="1"> <thead> <tr> <th></th> <th>Ant. 1</th> <th>Ant. 2</th> </tr> </thead> <tbody> <tr> <td>802.11 b/g/n/ac</td> <td>V</td> <td>V</td> </tr> <tr> <td>802.11 b/g/n/ac MIMO</td> <td>V</td> <td>V</td> </tr> </tbody> </table>		Ant. 1	Ant. 2	802.11 b/g/n/ac	V	V	802.11 b/g/n/ac MIMO	V	V
	Ant. 1	Ant. 2								
802.11 b/g/n/ac	V	V								
802.11 b/g/n/ac MIMO	V	V								

Note: MIMO Ant. 1+2 is a calculated result from sum of the power MIMO Ant. 1 and MIMO Ant. 2.

1.5 Modification of EUT

No modifications are made to the EUT during all test items.



1.6 Testing Location

Sporton Lab is accredited to ISO 17025 by Taiwan Accreditation Foundation (TAF code : 1190) and the FCC designation No. TW0007 under the FCC 2.948(e) by Mutual Recognition Agreement (MRA) in FCC Test.

Test Site	SPORTON INTERNATIONAL INC.	
Test Site Location	No. 52, Hwa Ya 1 st Rd., Hwa Ya Technology Park, Kwei-Shan District, Tao Yuan City, Taiwan, R.O.C. TEL: +886-3-327-3456 FAX: +886-3-328-4978	
Test Site No.	Sporton Site No.	
	TH05-HY	CO05-HY

Note: The test site complies with ANSI C63.4 2014 requirement.

Test Site	SPORTON INTERNATIONAL INC.	
Test Site Location	No.58, Aly. 75, Ln. 564, Wenhua 3rd Rd. Guishan Dist, Taoyuan City, Taiwan (R.O.C.) TEL: +886-3-327-0868 FAX: +886-3-327-0855	
Test Site No.	Sporton Site No.	
	03CH11-HY	

Note: The test site complies with ANSI C63.4 2014 requirement.



1.7 Applicable Standards

According to the specifications of the manufacturer, the EUT must comply with the requirements of the following standards:

- ♦ FCC Part 15 Subpart C §15.247
- ♦ FCC KDB Publication No. 558074 D01 DTS Meas. Guidance v04
- ♦ FCC KDB 662911 D01 Multiple Transmitter Output v02r01.
- ♦ FCC KDB 644545 D03 Guidance for IEEE 802 11ac New Rules v01
- ♦ ANSI C63.10-2013

Remark:

1. All test items were verified and recorded according to the standards and without any deviation during the test.
2. This EUT has also been tested and complied with the requirements of FCC Part 15, Subpart B, recorded in a separate test report.



2 Test Configuration of Equipment Under Test

The EUT has been associated with peripherals and configuration operated in a manner tended to maximize its emission characteristics in a typical application. Frequency range investigated: conducted emission (150 kHz to 30 MHz) and radiated emission (9 kHz to the 10th harmonic of the highest fundamental frequency or to 40 GHz, whichever is lower). For radiated measurement, pre-scanned in three orthogonal panels, X, Y, Z. The worst cases (Y plane) were recorded in this report.

2.1 Carrier Frequency and Channel

Frequency Band	Channel	Freq. (MHz)	Channel	Freq. (MHz)
2400-2483.5 MHz	1	2412	7	2442
	2	2417	8	2447
	3	2422	9	2452
	4	2427	10	2457
	5	2432	11	2462
	6	2437	-	-



2.2 Test Mode

Final test mode of conducted test items and radiated spurious emissions are considering the modulation and worse data rates as below table.

Single Antenna

Modulation	Data Rate
802.11b	1 Mbps
802.11g	6 Mbps
802.11n HT20	MCS0
802.11n VHT20	MCS0

MIMO Antenna

Modulation	Data Rate
802.11b	1 Mbps
802.11g	6 Mbps
802.11n HT20	MCS0
802.11n VHT20	MCS0

Test Cases	
AC Conducted Emission	Mode 1 : GSM850 Idle + Bluetooth Link + WLAN (2.4GHz) Link + MP3 + Battery 2 + USB Cable (Charging from Adapter 3)
Remark: All the radiated test cases were performance with Adapter 1 and Battery 2.	

2.3 Connection Diagram of Test System

<WLAN Tx Mode>

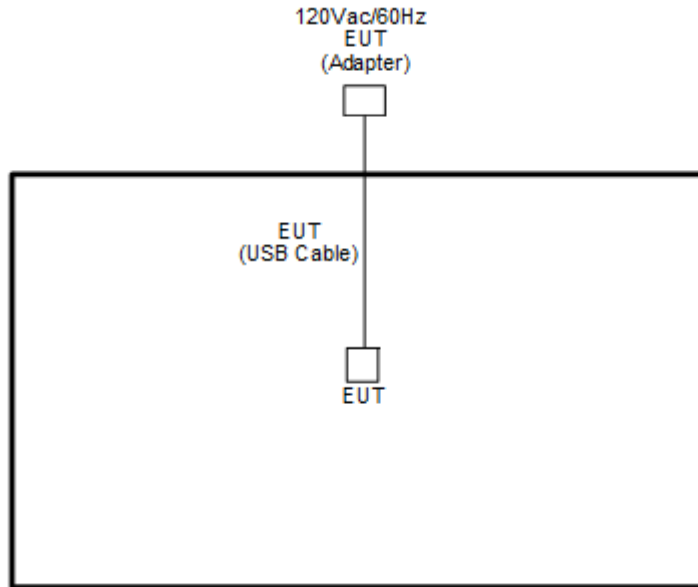

<AC Conducted Emission Mode>

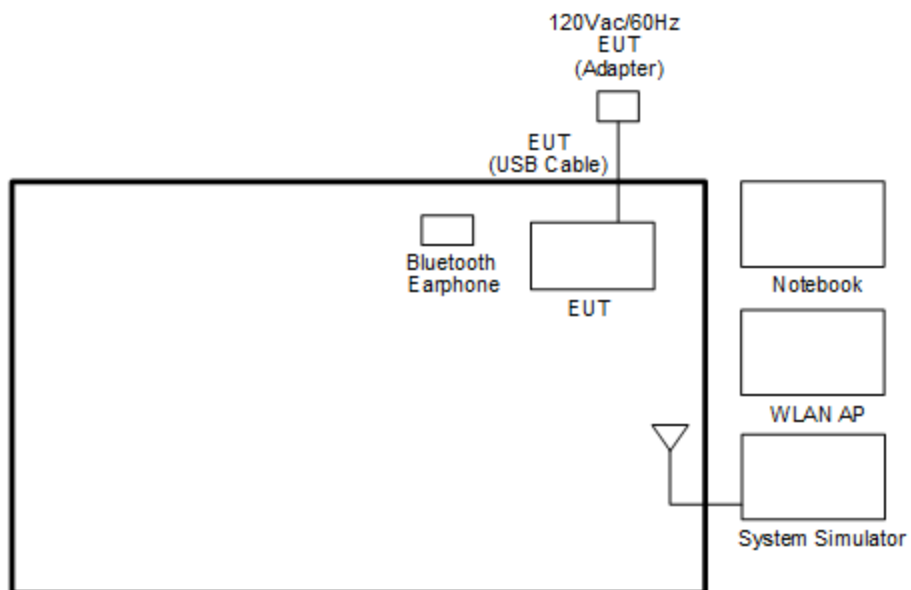



2.4 Support Unit used in test configuration and system

Item	Equipment	Trade Name	Model Name	FCC ID	Data Cable	Power Cord
1.	System Simulator	R&S	CMU 200	N/A	N/A	Unshielded, 1.8 m
2.	WLAN AP	ASUS	RT-AC66U	MSQ-RTAC66U	N/A	Unshielded, 1.8 m
3.	Bluetooth Earphone	Sony Ericsson	MW600	PY7DDA-2029	N/A	N/A
4.	Notebook	DELL	Latitude E6320	FCC DoC/ Contains FCC ID: QDS-BRCM1054	N/A	AC I/P: Unshielded, 1.2 m DC O/P: Shielded, 1.8 m
5.	SD Card	SanDisk	MicroSD HC	FCC DoC	N/A	N/A

2.5 EUT Operation Test Setup

The RF test items, programmed RF utility, “QRCT” installed in the notebook make the EUT provide functions like channel selection and power level for continuous transmitting and receiving signals.

2.6 Measurement Results Explanation Example

For all conducted test items:

The offset level is set in the spectrum analyzer to compensate the RF cable loss and attenuator factor between EUT conducted output port and spectrum analyzer. With the offset compensation, the spectrum analyzer reading level is exactly the EUT RF output level.

Example :

The spectrum analyzer offset is derived from RF cable loss and attenuator factor.

Offset = RF cable loss + attenuator factor.

Following shows an offset computation example with cable loss 4.2 dB and 10dB attenuator.

$$\begin{aligned}
 \text{Offset(dB)} &= \text{RF cable loss(dB)} + \text{attenuator factor(dB)}. \\
 &= 4.2 + 10 = 14.2 \text{ (dB)}
 \end{aligned}$$

3 Test Result

3.1 6dB and 99% Bandwidth Measurement

3.1.1 Limit of 6dB and 99% Bandwidth

The minimum 6 dB bandwidth shall be at least 500 kHz.

3.1.2 Measuring Instruments

The measuring equipment is listed in the section 4 of this test report.

3.1.3 Test Procedures

1. The testing follows FCC KDB Publication No. 558074 DTS D01 Meas. Guidance v04.
2. The RF output of EUT was connected to the spectrum analyzer by RF cable and attenuator. The path loss was compensated to the results for each measurement.
3. Set to the maximum power setting and enable the EUT transmit continuously.
4. Make the measurement with the spectrum analyzer's resolution bandwidth (RBW) = 100 kHz. Set the Video bandwidth (VBW) = 300 kHz. In order to make an accurate measurement. The 6 dB bandwidth must be greater than 500 kHz.
5. For 99% Bandwidth Measurement, the spectrum analyzer's resolution bandwidth (RBW) = 1MHz and set the Video bandwidth (VBW) = 3MHz.
6. Measure and record the results in the test report.

3.1.4 Test Setup

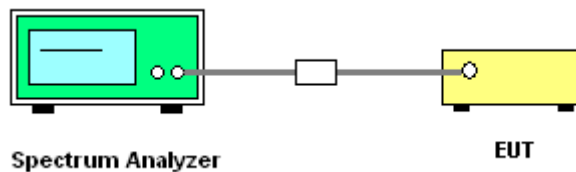



3.1.5 Test Result of 6dB and 99% Occupied Bandwidth

Please refer to Appendix A.

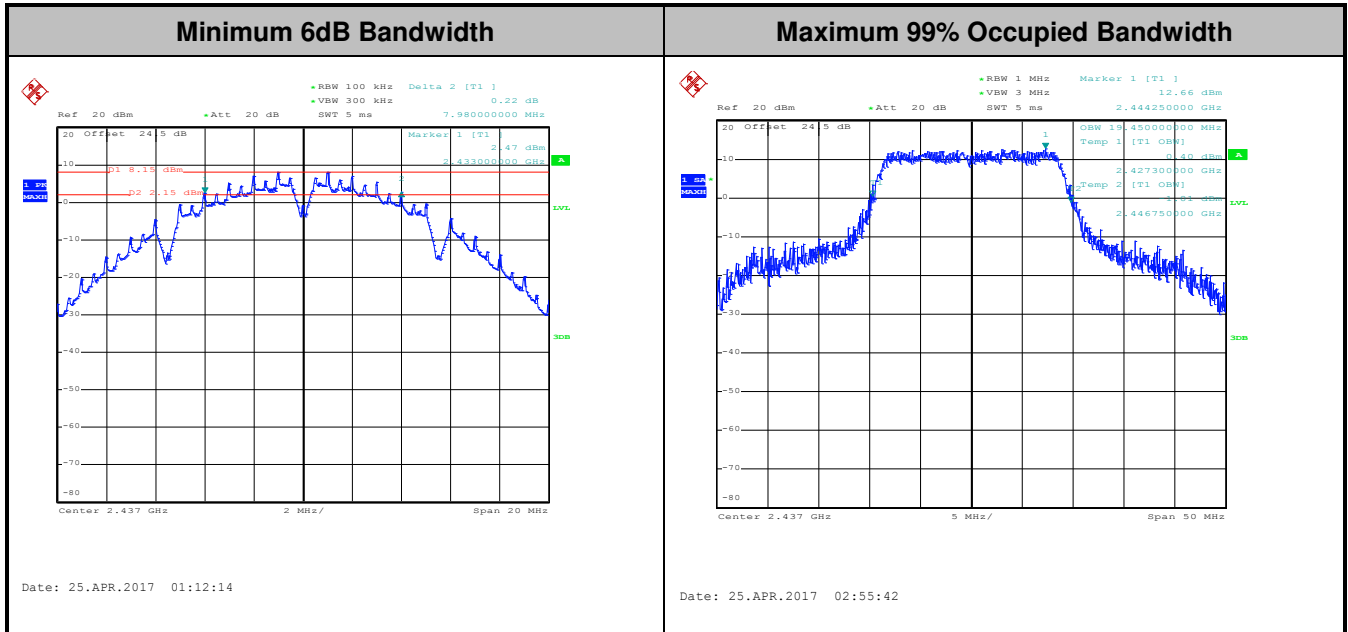

Note : The occupied channel bandwidth is maintained within the band of operation for all of the modulations.



3.2 Output Power Measurement

3.2.1 Limit of Output Power

For systems using digital modulation in the 2400-2483.5MHz, the limit for peak output power is 30dBm. If transmitting antenna of directional gain greater than 6dBi are used the peak output power from the intentional radiator shall be reduced below the above stated value by the amount in dB that the directional gain of the antenna exceeds 6 dBi. In case of point-to-point operation, the limit has to be reduced by 1dB for every 3dB that the directional gain of the antenna exceeds 6dBi.

3.2.2 Measuring Instruments

The measuring equipment is listed in the section 4 of this test report.

3.2.3 Test Procedures

1. The testing follows the Measurement Procedure of FCC KDB No. 558074 DTS D01 Meas. Guidance v04 section 9.1.3 PKPM1 Peak power meter method.
2. The RF output of EUT was connected to the power meter by RF cable and attenuator. The path loss was compensated to the results for each measurement.
3. Set to the maximum power setting and enable the EUT transmit continuously.
4. Measure the conducted output power and record the results in the test report.
5. For MIMO mode, calculation method follows FCC KDB 662911 D01 Multiple Transmitter Output v02r01.

3.2.4 Test Setup

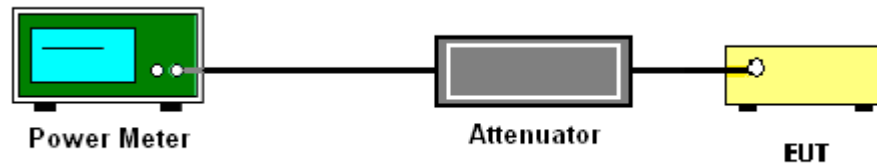

3.2.5 Test Result of Peak Output Power

Please refer to Appendix A.

3.2.6 Test Result of Average output Power (Reporting Only)

Please refer to Appendix A.

3.3 Power Spectral Density Measurement

3.3.1 Limit of Power Spectral Density

The peak power spectral density shall not be greater than 8dBm in any 3kHz band at any time interval of continuous transmission.

3.3.2 Measuring Instruments

The measuring equipment is listed in the section 4 of this test report.

3.3.3 Test Procedures

1. The testing follows Measurement Procedure 10.2 Method PKPSD of FCC KDB Publication No. 558074 D01 DTS Meas. Guidance v04
2. The RF output of EUT was connected to the spectrum analyzer by RF cable and attenuator. The path loss was compensated to the results for each measurement.
3. Set to the maximum power setting and enable the EUT transmit continuously.
4. Make the measurement with the spectrum analyzer's resolution bandwidth (RBW) = 3 kHz. Video bandwidth VBW = 10 kHz In order to make an accurate measurement, set the span to 1.5 times DTS Channel Bandwidth. (6dB BW)
5. Detector = peak, Sweep time = auto couple, Trace mode = max hold, Allow trace to fully stabilize. Use the peak marker function to determine the maximum power level.
6. Measure and record the results in the test report.

3.3.4 Test Setup

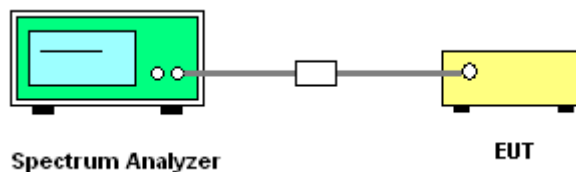



3.3.5 Test Result of Power Spectral Density

Please refer to Appendix A.

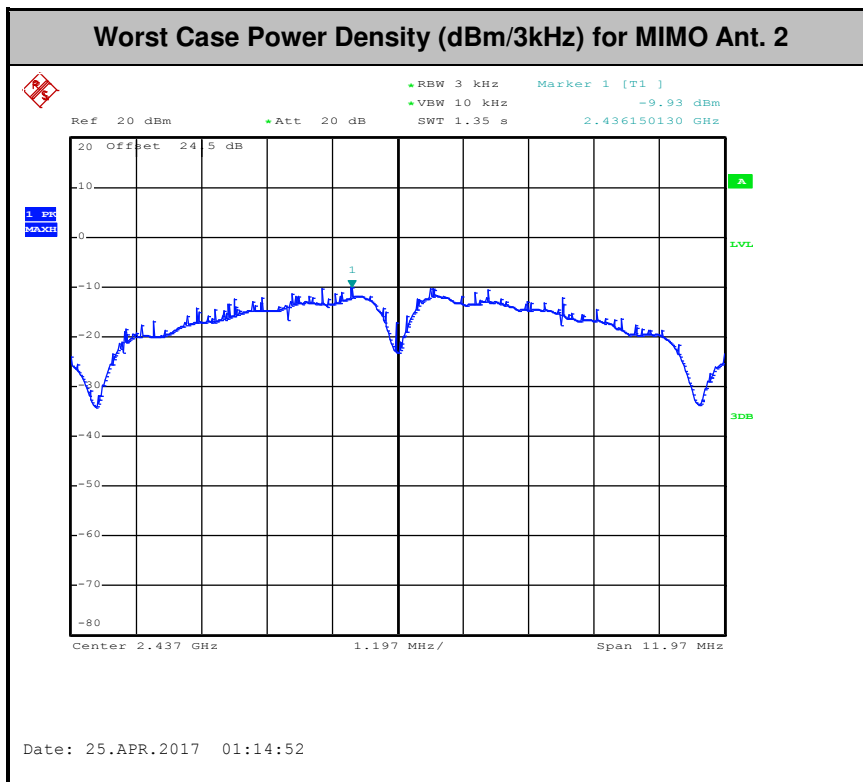
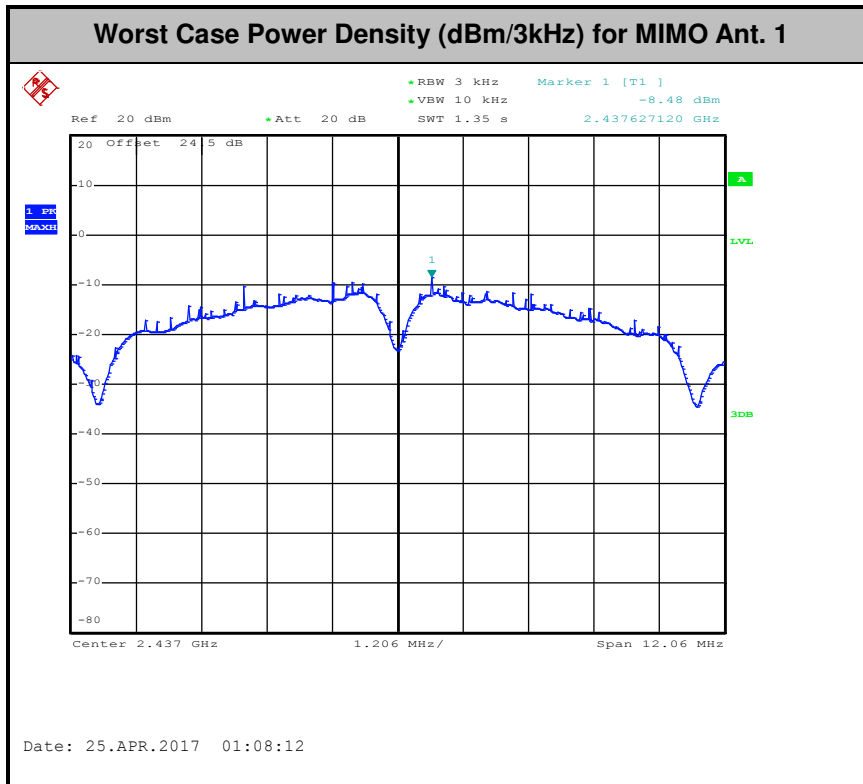

3.4 Conducted Band Edges and Spurious Emission Measurement

3.4.1 Limit of Conducted Band Edges and Spurious Emission Measurement

In any 100 kHz bandwidth outside of the authorized frequency band, the emissions which fall in the non-restricted bands shall be attenuated at least 20 dB / 30dB relative to the maximum PSD level in 100 kHz by RF conducted measurement.

3.4.2 Measuring Instruments

The measuring equipment is listed in the section 4 of this test report.

3.4.3 Test Procedures

1. The testing follows FCC KDB Publication No. 558074 D01 DTS Meas. Guidance v04.
2. The RF output of EUT was connected to the spectrum analyzer by RF cable and attenuator. The path loss was compensated to the results for each measurement.
3. Set to the maximum power setting and enable the EUT transmit continuously.
4. Set RBW = 100 kHz, VBW=300 kHz, Peak Detector. Unwanted Emissions measured in any 100 kHz bandwidth outside of the authorized frequency band shall be attenuated by at least 20 dB relative to the maximum in-band peak PSD level in 100 kHz when maximum peak conducted output power procedure is used. If the transmitter complies with the conducted power limits based on the use of RMS averaging over a time interval, the attenuation required under this paragraph shall be 30 dB instead of 20 dB.
5. Measure and record the results in the test report.
6. The RF fundamental frequency should be excluded against the limit line in the operating frequency band.

3.4.4 Test Setup

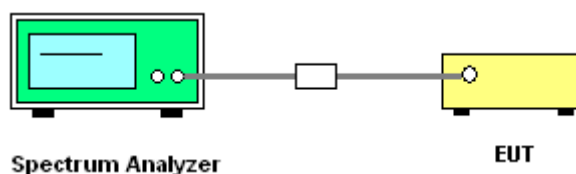



3.4.5 Test Result of Conducted Band Edges and Spurious Emission

Number of TX = 2, Ant. 1 (Measured)

Number of TX	2	Ant. :	1
Test Mode :	802.11b	Temperature :	21~25°C
Test Band :	2.4GHz Low	Relative Humidity :	51~54%
Test Channel :	01	Test Engineer :	Shiming Liu

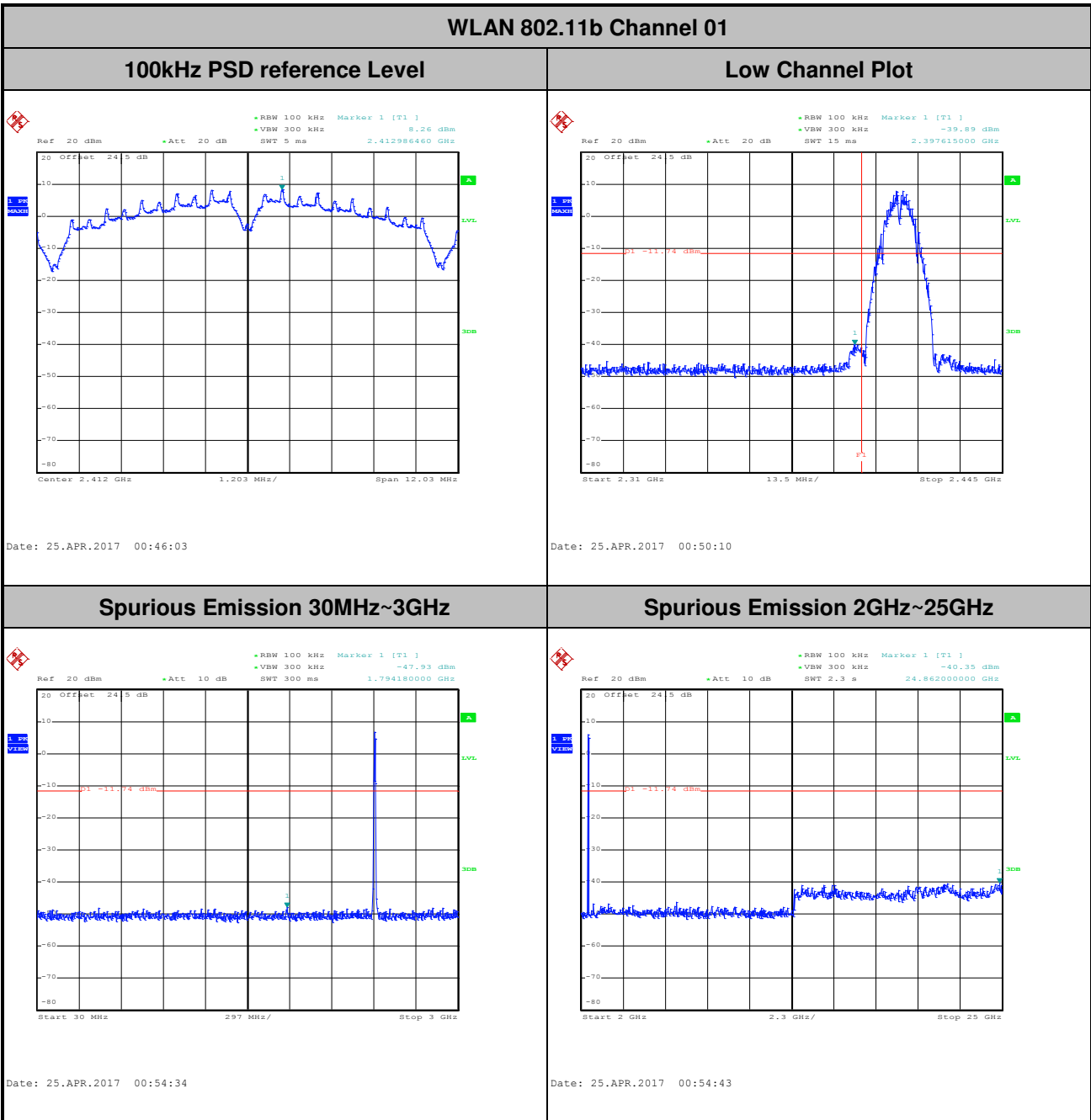



Number of TX	2	Ant. :	1
Test Mode :	802.11b	Temperature :	21~25°C
Test Band :	2.4GHz Mid	Relative Humidity :	51~54%
Test Channel :	06	Test Engineer :	Shiming Liu

WLAN 802.11b Channel 06

100kHz PSD reference Level

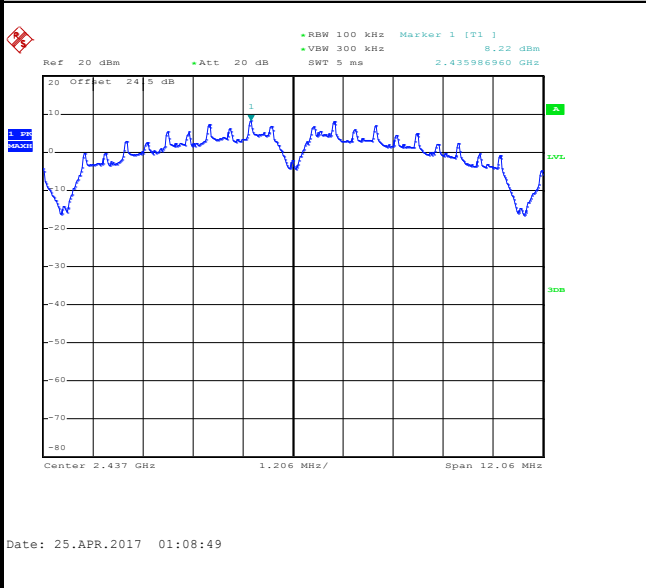

Spurious Emission 30MHz~3GHz

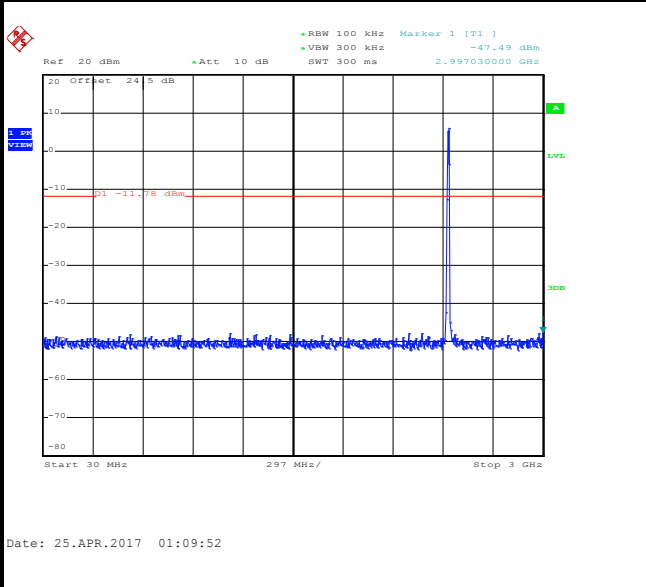

Spurious Emission 2GHz~25GHz

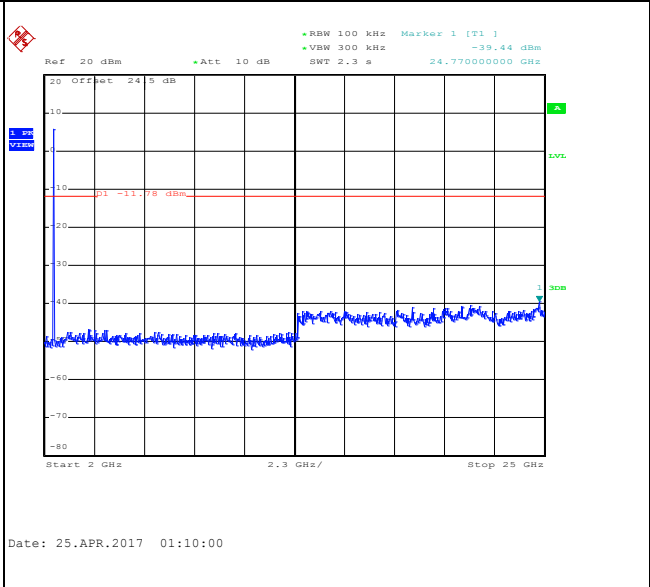



Number of TX	2	Ant. :	1
Test Mode :	802.11b	Temperature :	21~25°C
Test Band :	2.4GHz High	Relative Humidity :	51~54%
Test Channel :	11	Test Engineer :	Shiming Liu

WLAN 802.11b Channel 11

100kHz PSD reference Level

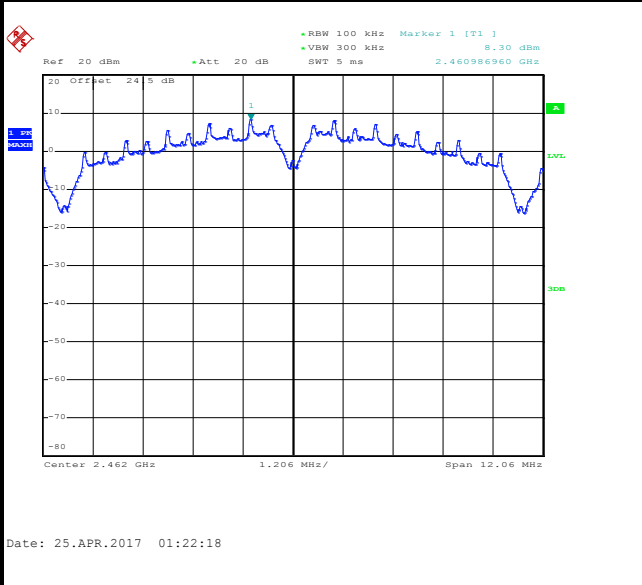

High Channel Plot

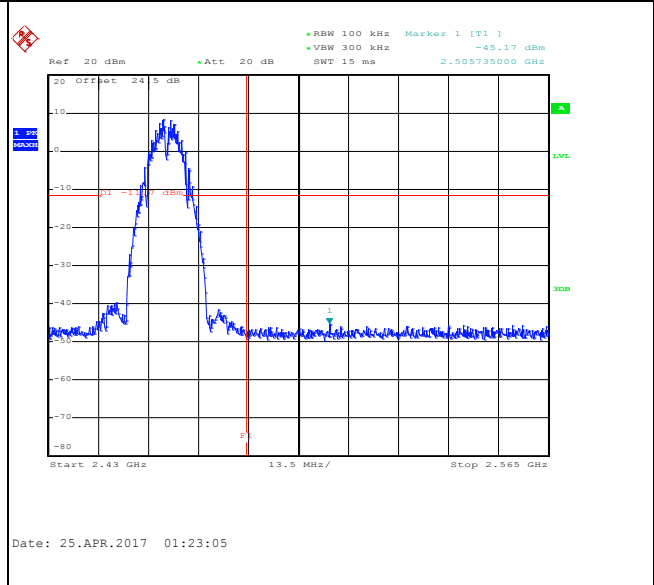

Spurious Emission 30MHz~3GHz

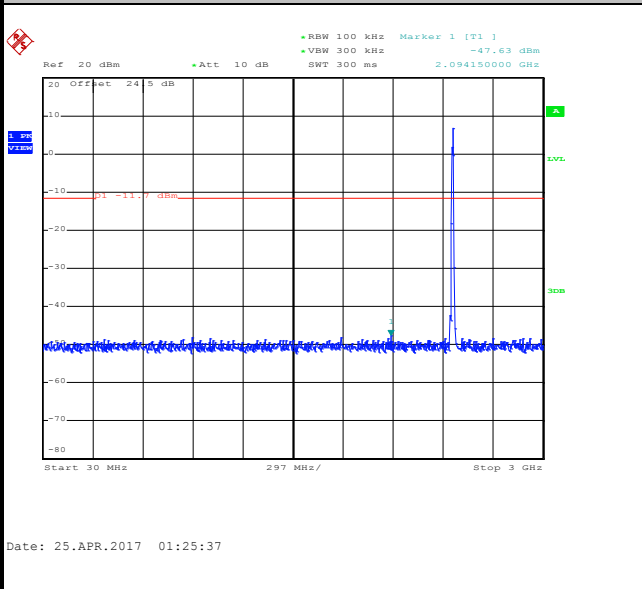

Spurious Emission 2GHz~25GHz

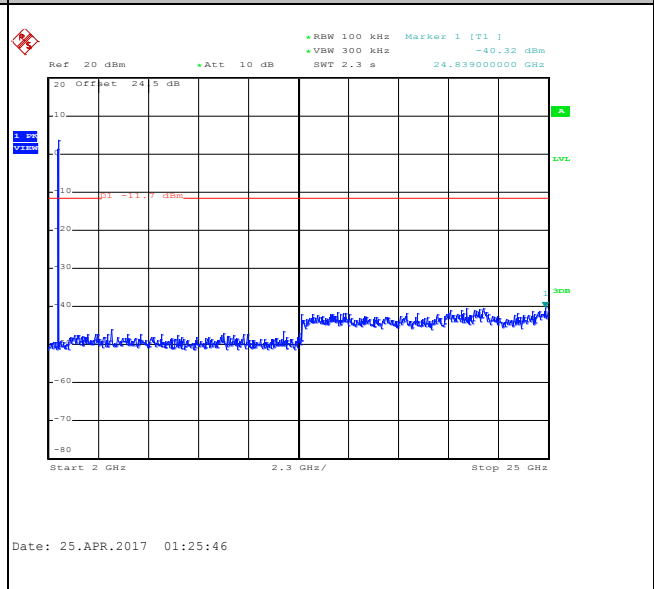



Number of TX	2	Ant. :	1
Test Mode :	802.11g	Temperature :	21~25°C
Test Band :	2.4GHz Low	Relative Humidity :	51~54%
Test Channel :	01	Test Engineer :	Shiming Liu

WLAN 802.11g Channel 01

100kHz PSD reference Level

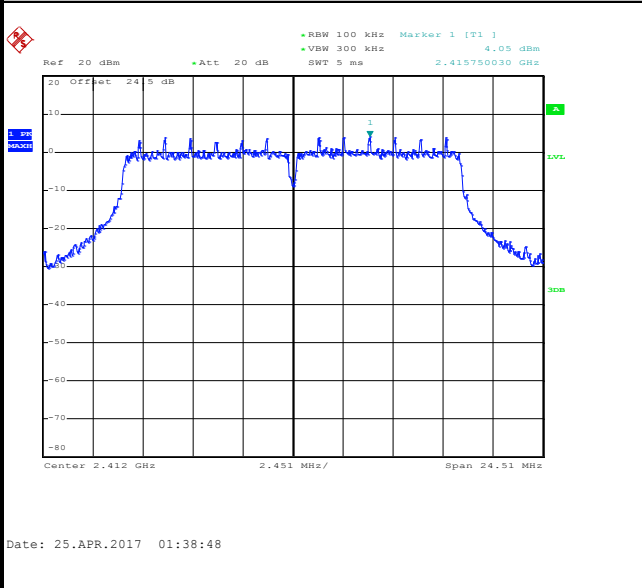

Low Channel Plot

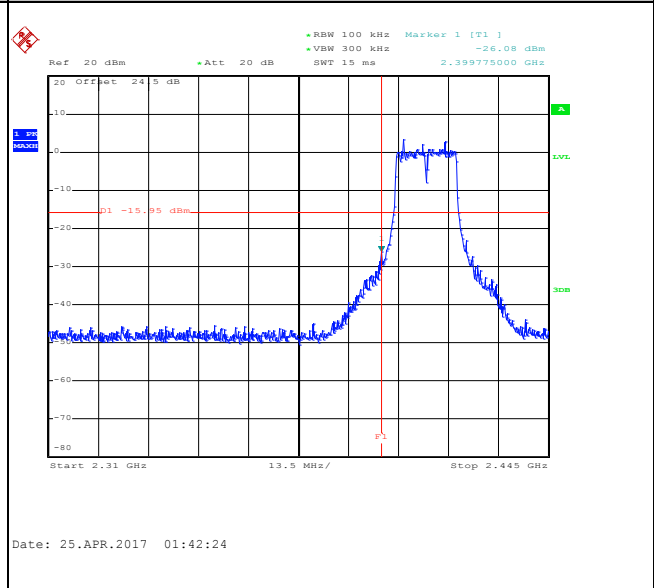

Spurious Emission 30MHz~3GHz

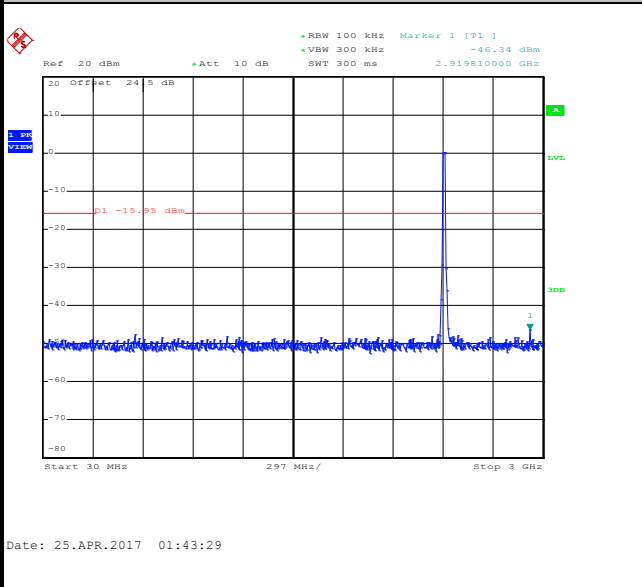

Spurious Emission 2GHz~25GHz

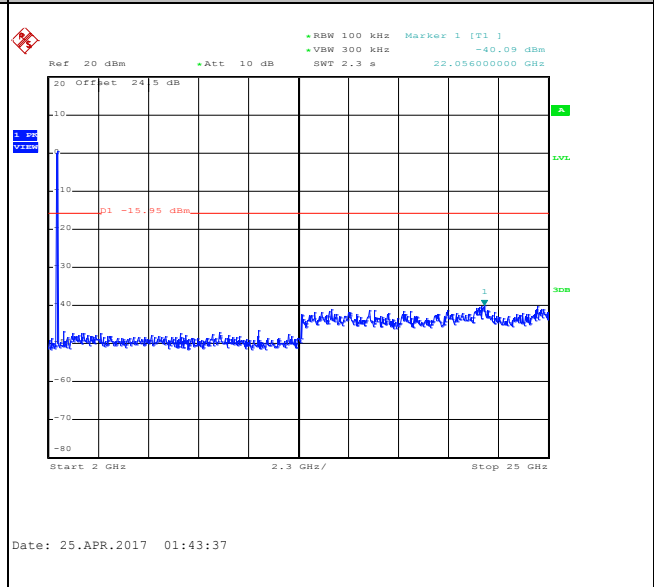



Number of TX	2	Ant. :	1
Test Mode :	802.11g	Temperature :	21~25°C
Test Band :	2.4GHz Mid	Relative Humidity :	51~54%
Test Channel :	06	Test Engineer :	Shiming Liu

WLAN 802.11g Channel 06

100kHz PSD reference Level

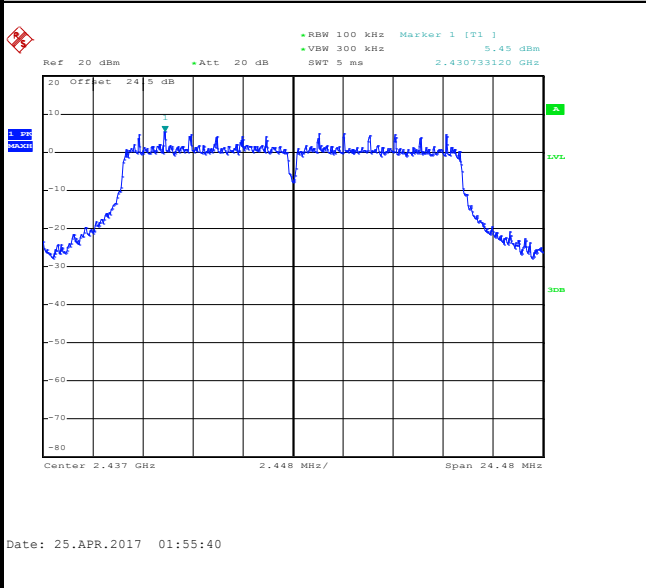

Spurious Emission 30MHz~3GHz

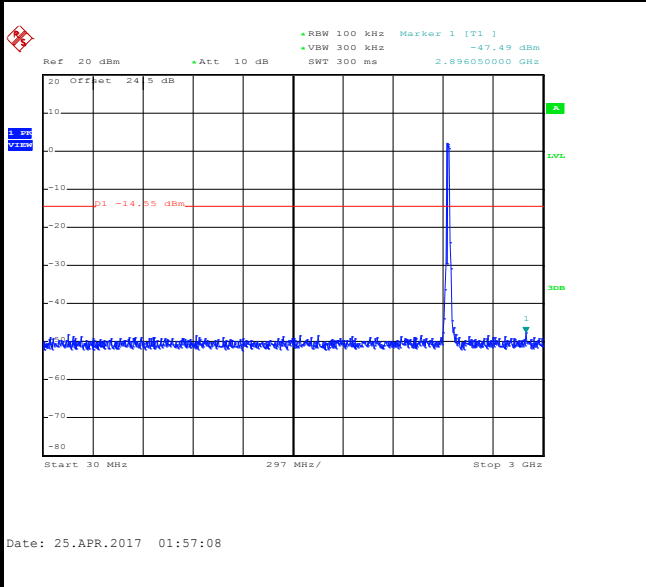

Spurious Emission 2GHz~25GHz

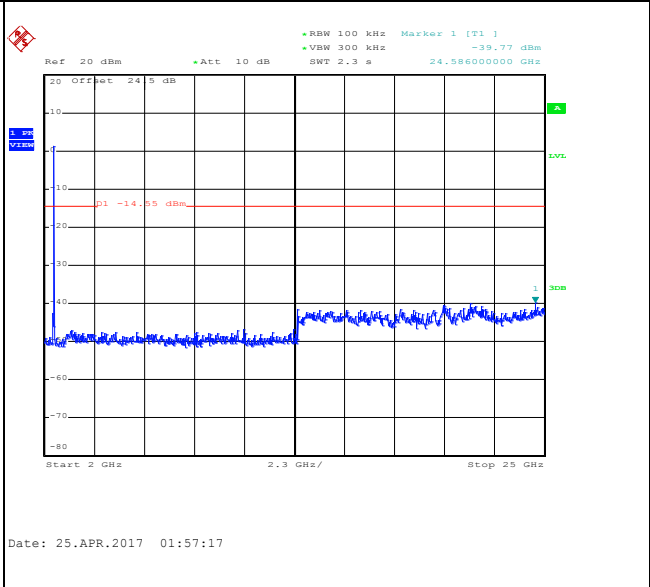



Number of TX	2	Ant. :	1
Test Mode :	802.11g	Temperature :	21~25°C
Test Band :	2.4GHz High	Relative Humidity :	51~54%
Test Channel :	11	Test Engineer :	Shiming Liu

WLAN 802.11g Channel 11

100kHz PSD reference Level

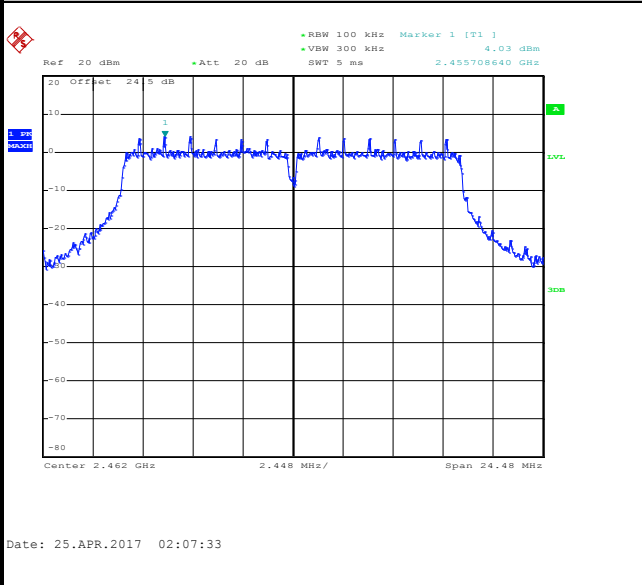

High Channel Plot

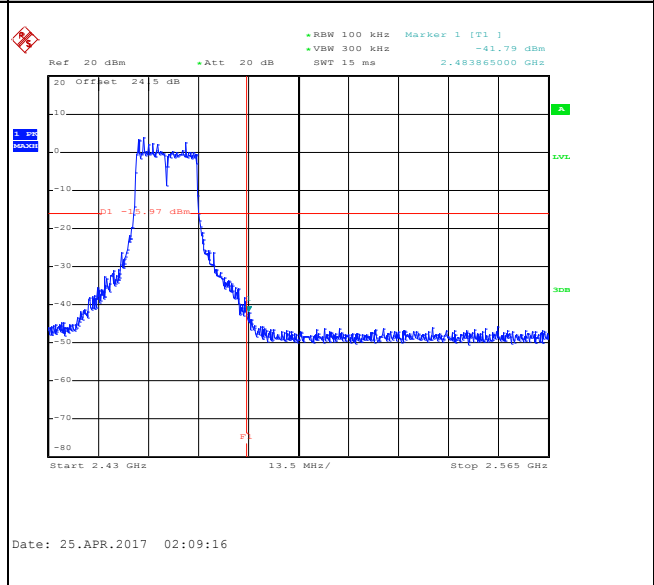

Spurious Emission 30MHz~3GHz

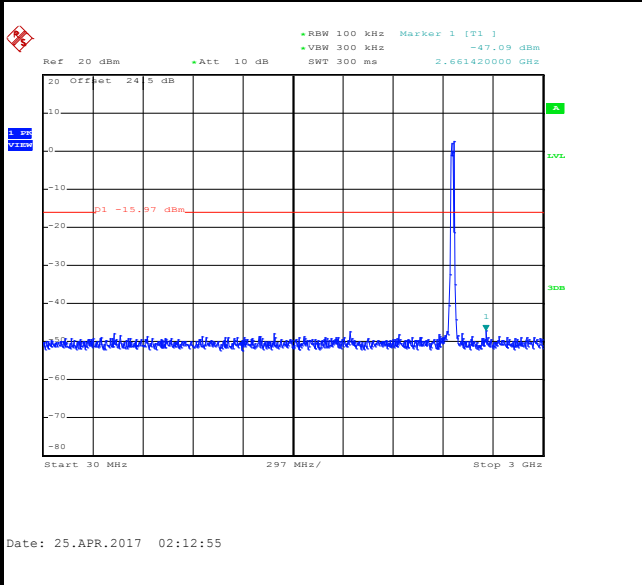

Spurious Emission 2GHz~25GHz

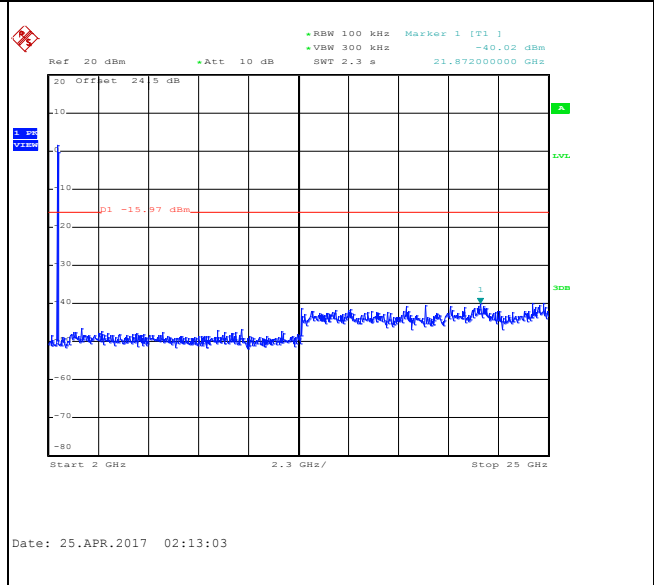



Number of TX	2	Ant. :	1
Test Mode :	802.11n HT20	Temperature :	21~25°C
Test Band :	2.4GHz Low	Relative Humidity :	51~54%
Test Channel :	01	Test Engineer :	Shiming Liu

WLAN 802.11n HT20 Channel 01

100kHz PSD reference Level

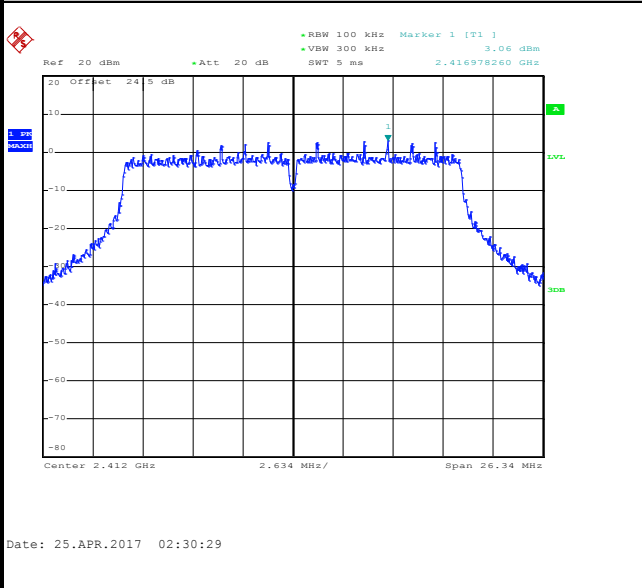

Low Channel Plot

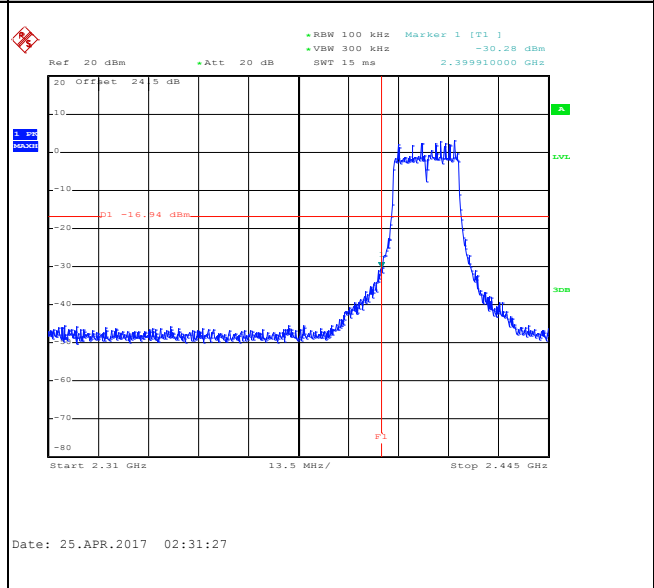

Spurious Emission 30MHz~3GHz

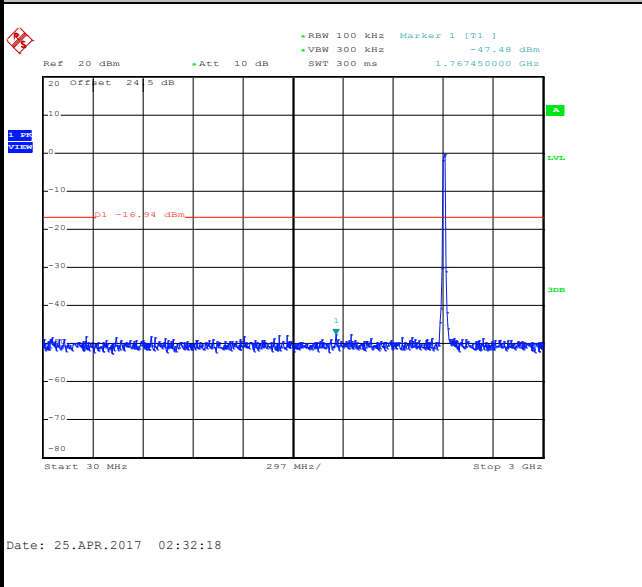

Spurious Emission 2GHz~25GHz

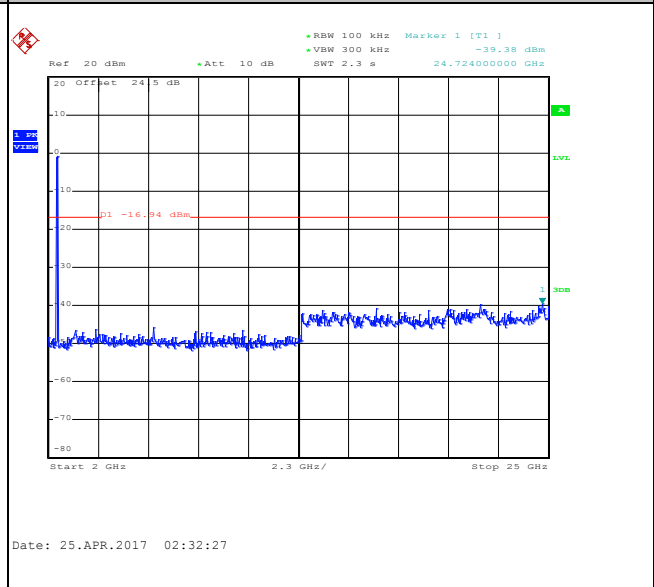



Number of TX	2	Ant. :	1
Test Mode :	802.11n HT20	Temperature :	21~25°C
Test Band :	2.4GHz Mid	Relative Humidity :	51~54%
Test Channel :	06	Test Engineer :	Shiming Liu

WLAN 802.11n HT20 Channel 06

100kHz PSD reference Level

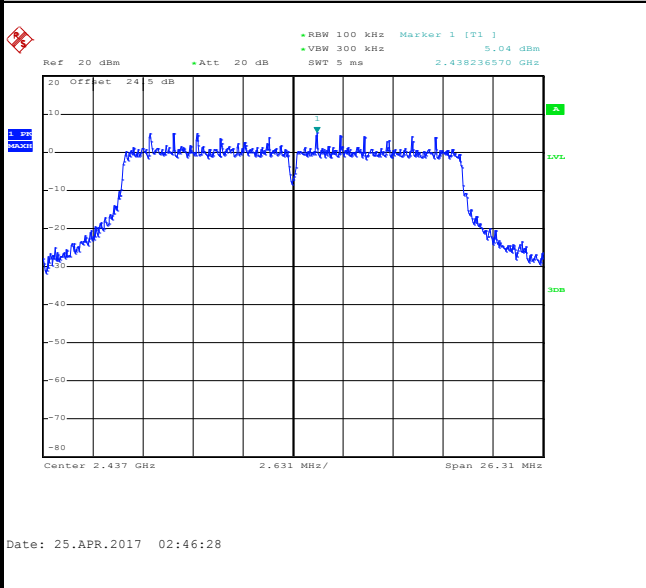

Spurious Emission 30MHz~3GHz

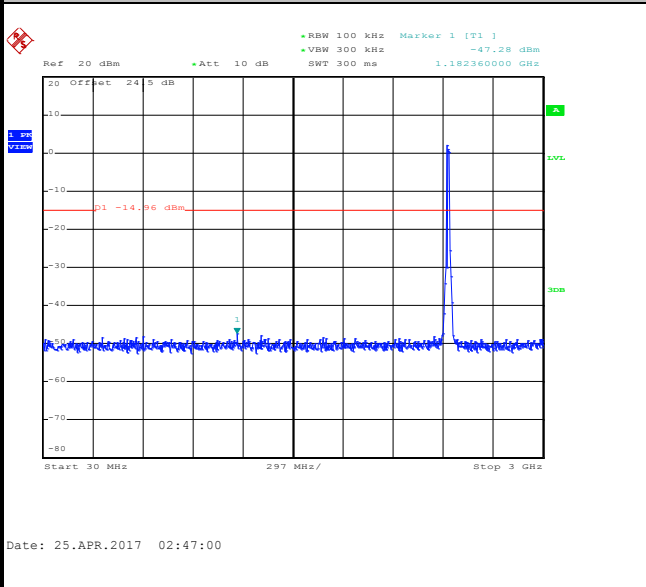

Spurious Emission 2GHz~25GHz

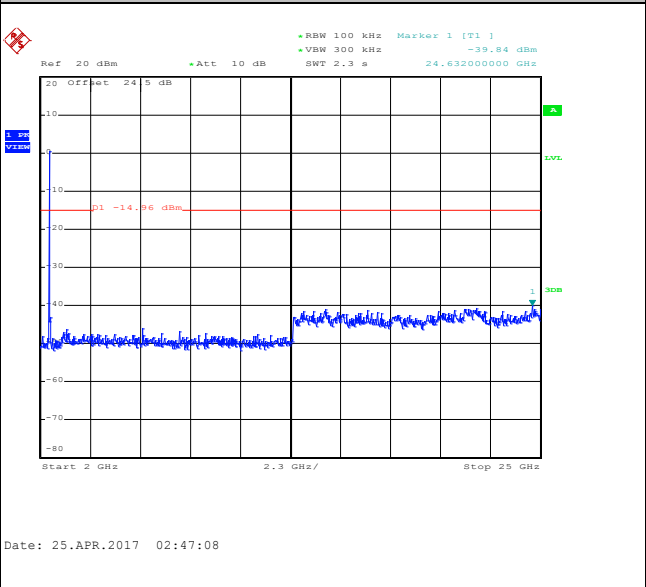



Number of TX	2	Ant. :	1
Test Mode :	802.11n HT20	Temperature :	21~25°C
Test Band :	2.4GHz High	Relative Humidity :	51~54%
Test Channel :	11	Test Engineer :	Shiming Liu

WLAN 802.11n HT20 Channel 11

100kHz PSD reference Level

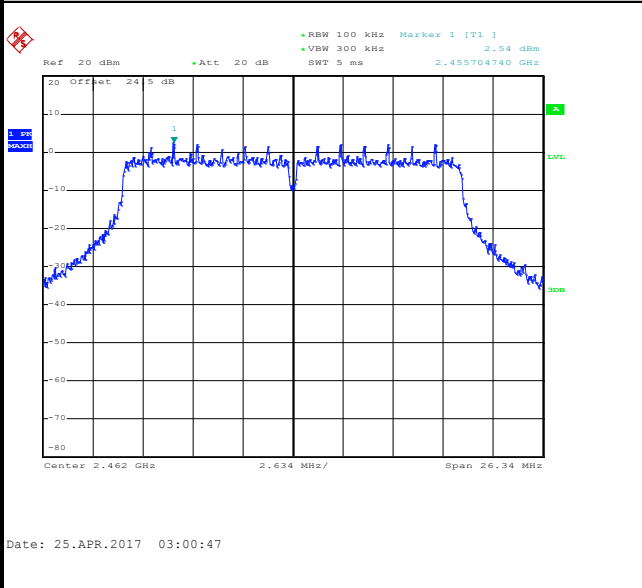

High Channel Plot

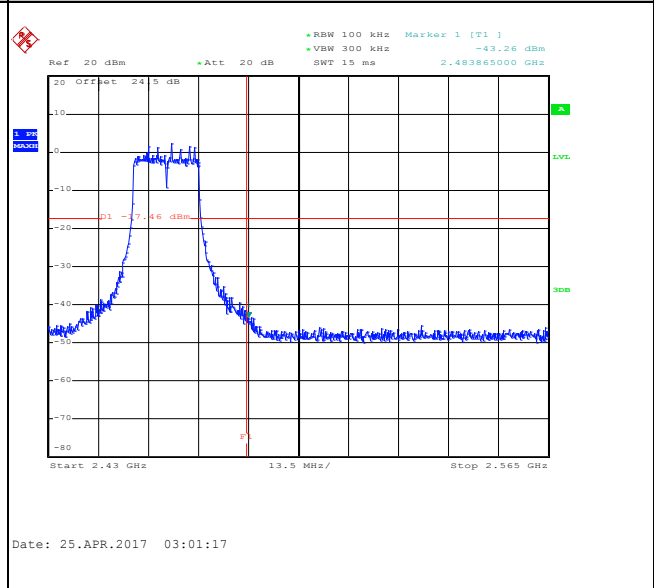

Spurious Emission 30MHz~3GHz

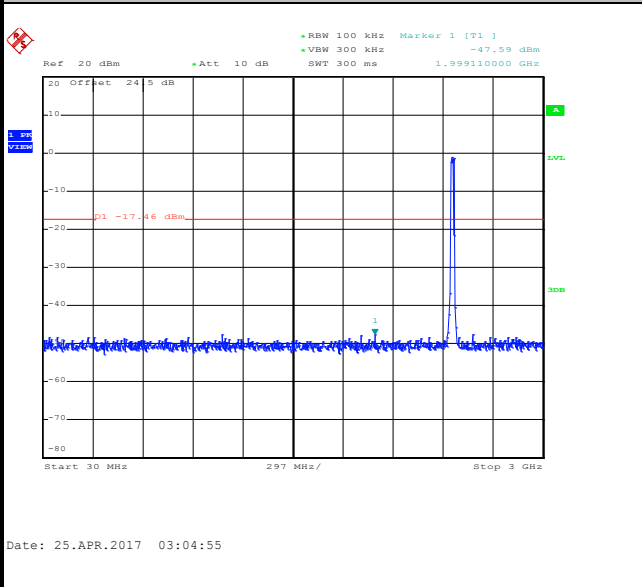

Spurious Emission 2GHz~25GHz

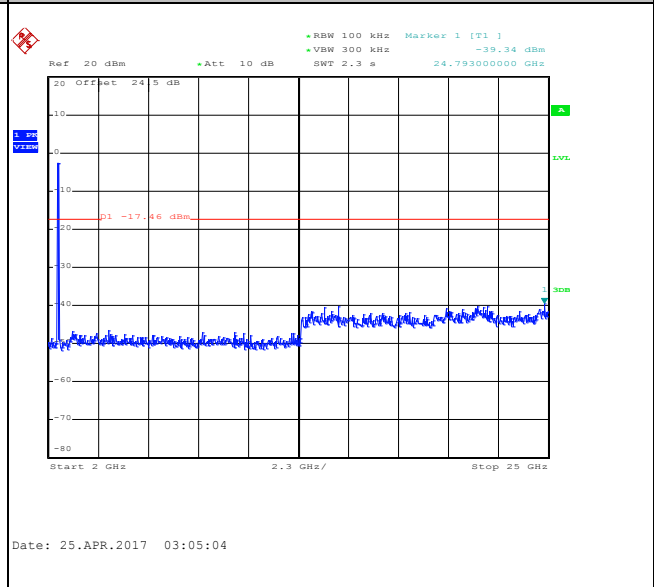



Number of TX	2	Ant. :	1
Test Mode :	802.11ac VHT20	Temperature :	21~25°C
Test Band :	2.4GHz Low	Relative Humidity :	51~54%
Test Channel :	01	Test Engineer :	Shiming Liu

WLAN 802.11ac VHT20 Channel 01

100kHz PSD reference Level

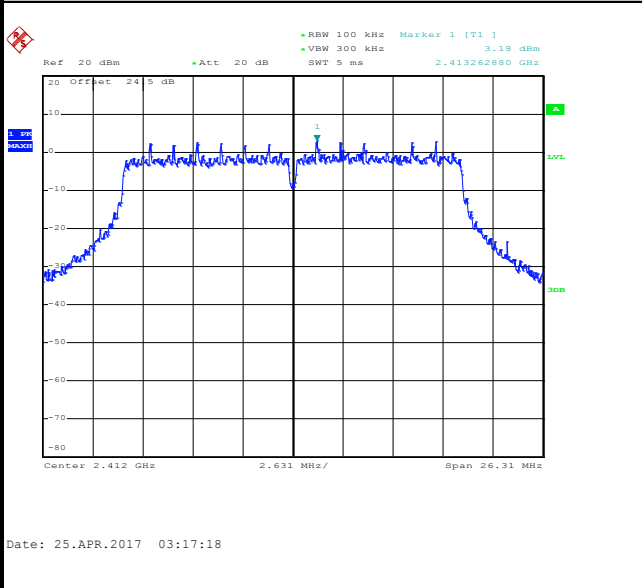

Low Channel Plot

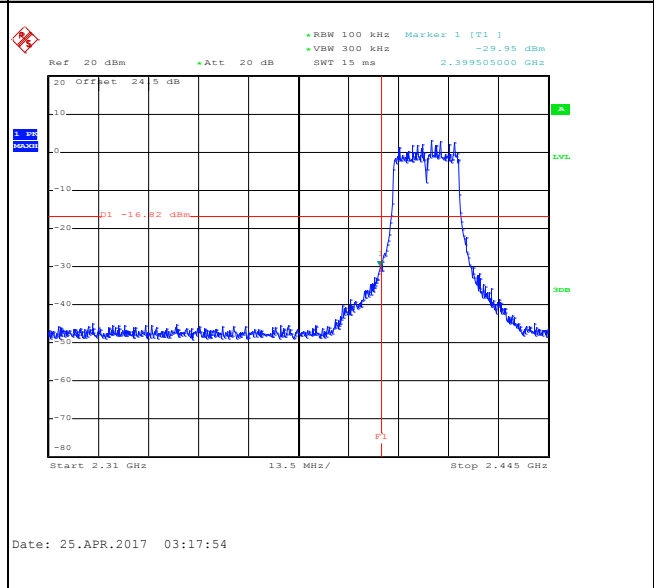

Spurious Emission 30MHz~3GHz

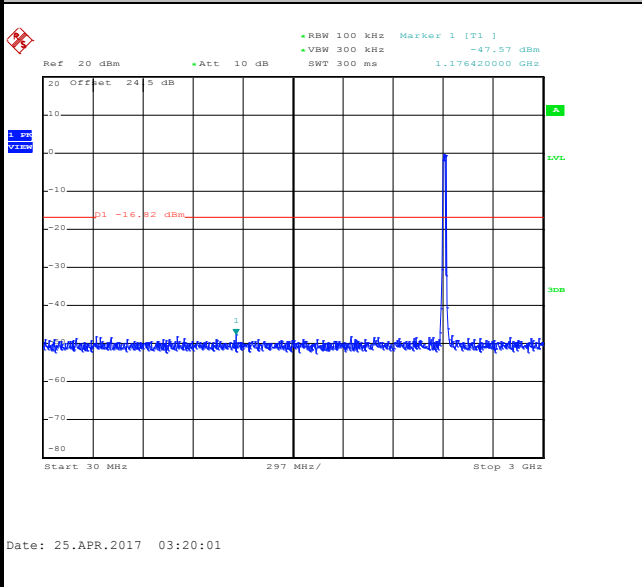

Spurious Emission 2GHz~25GHz

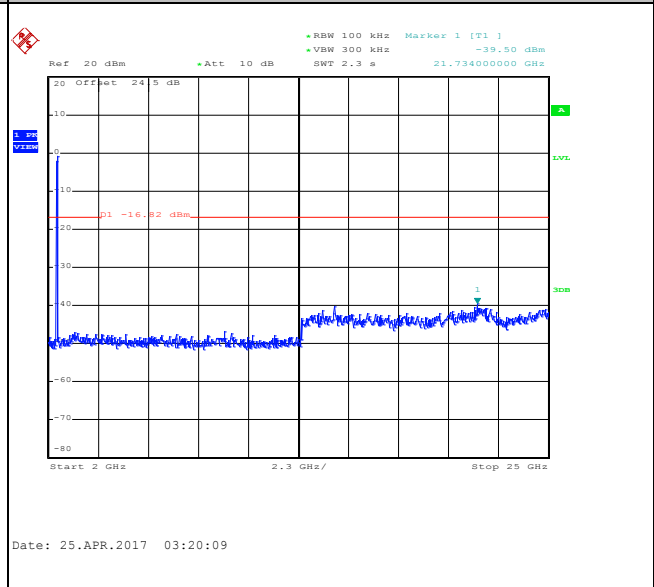



Number of TX	2	Ant. :	1
Test Mode :	802.11ac VHT20	Temperature :	21~25°C
Test Band :	2.4GHz Mid	Relative Humidity :	51~54%
Test Channel :	06	Test Engineer :	Shiming Liu

WLAN 802.11ac VHT20 Channel 06

100kHz PSD reference Level

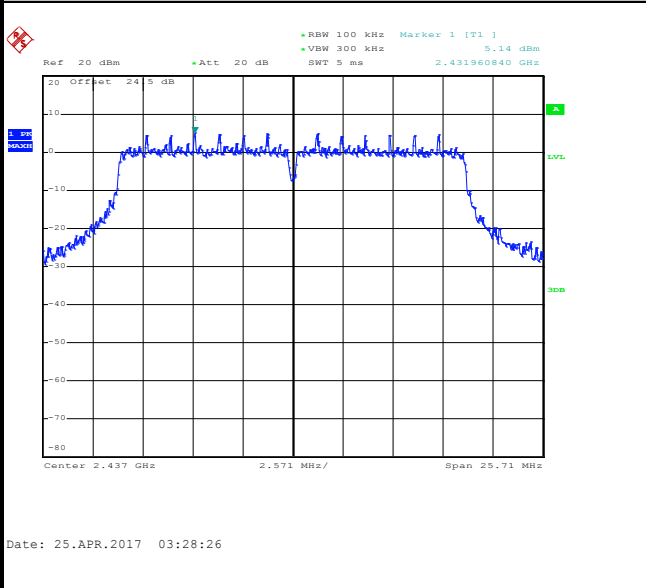

Spurious Emission 30MHz~3GHz

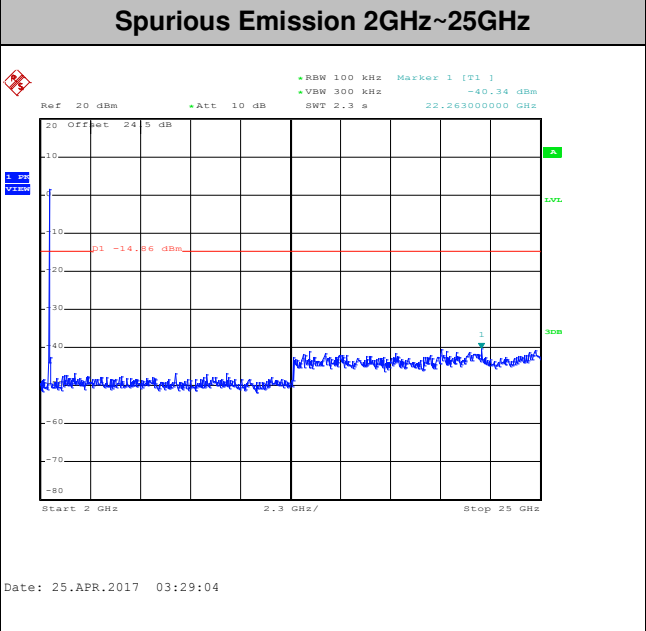
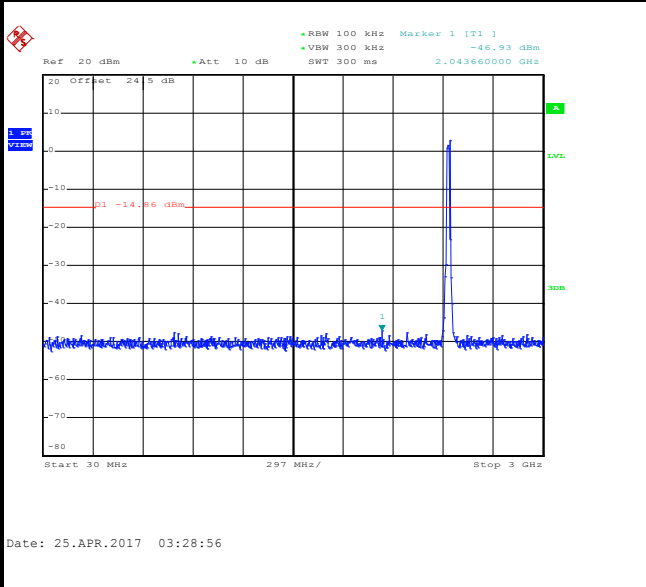



Number of TX	2	Ant. :	1
Test Mode :	802.11ac VHT20	Temperature :	21~25°C
Test Band :	2.4GHz High	Relative Humidity :	51~54%
Test Channel :	11	Test Engineer :	Shiming Liu

WLAN 802.11ac VHT20 Channel 11

100kHz PSD reference Level

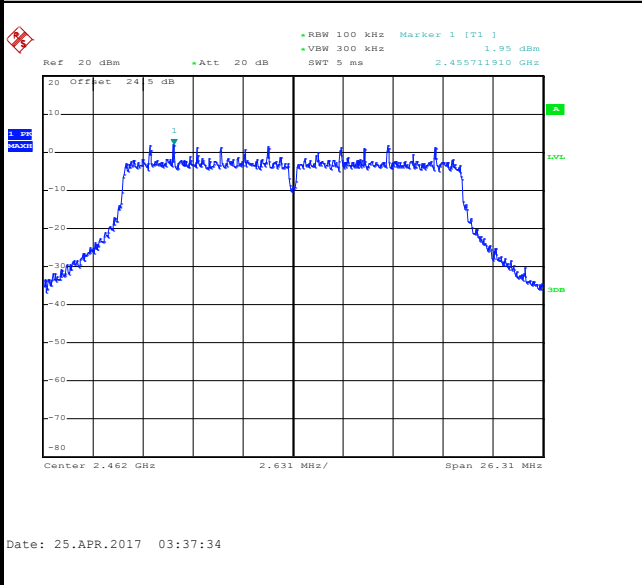

High Channel Plot

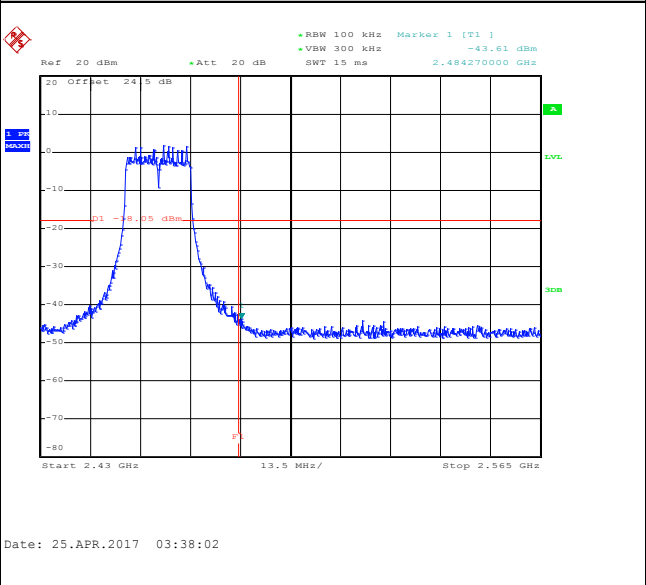

Spurious Emission 30MHz~3GHz

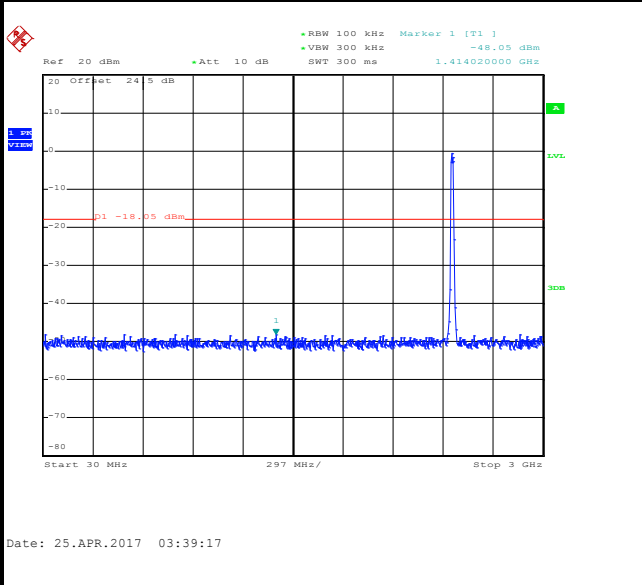

Spurious Emission 2GHz~25GHz

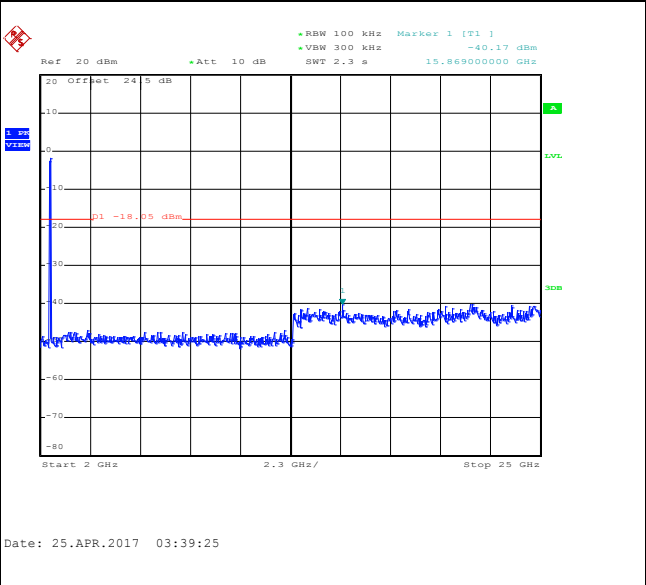



Number of TX = 2, Ant. 2 (Measured)

Number of TX	2	Ant. :	2
Test Mode :	802.11b	Temperature :	21~25°C
Test Band :	2.4GHz Low	Relative Humidity :	51~54%
Test Channel :	01	Test Engineer :	Shiming Liu

WLAN 802.11b Channel 01

100kHz PSD reference Level

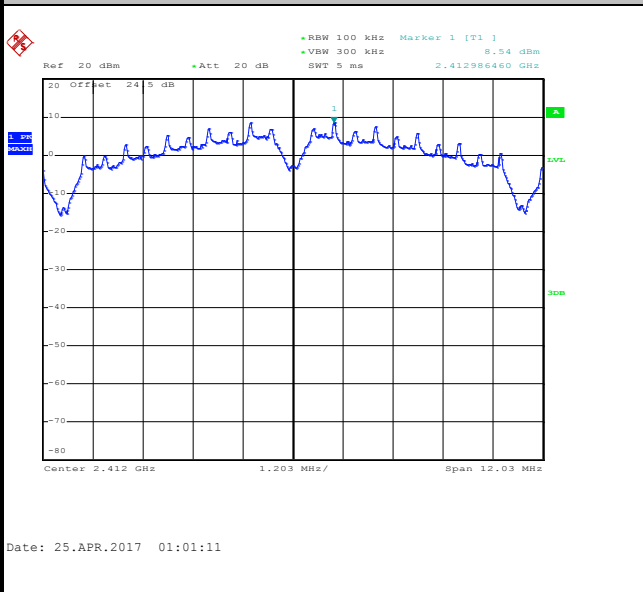

Low Channel Plot

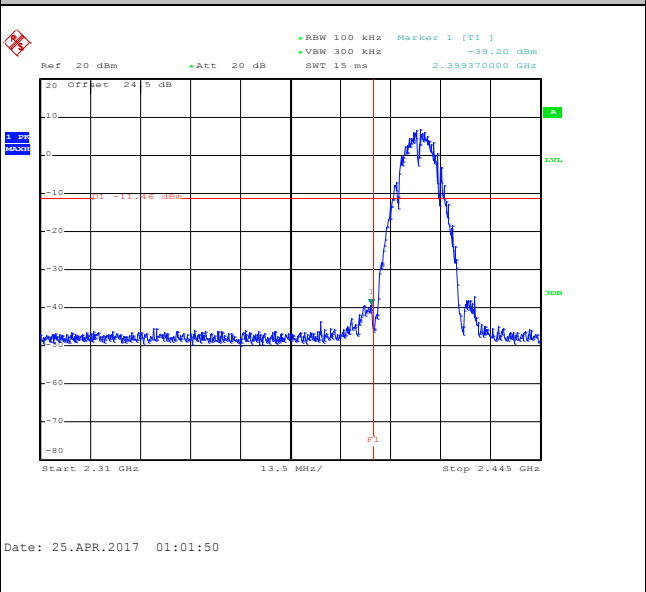

Spurious Emission 30MHz~3GHz

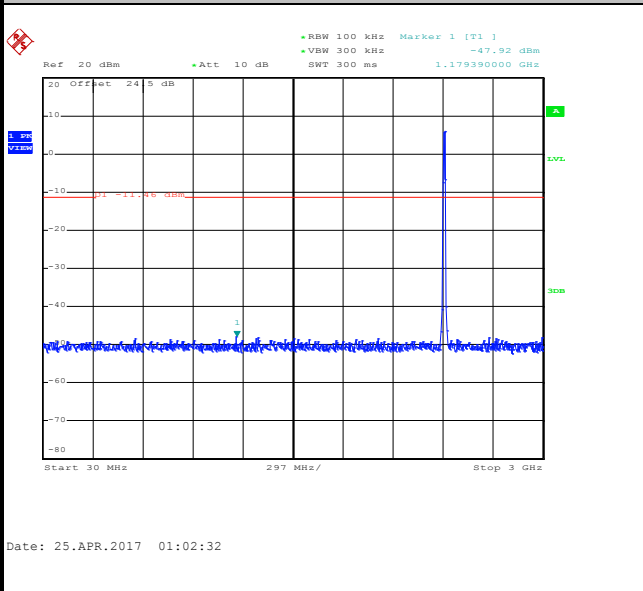

Spurious Emission 2GHz~25GHz

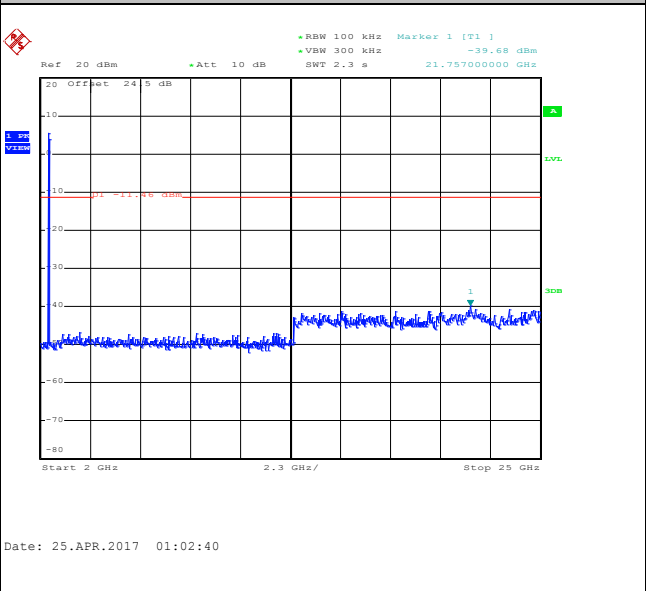



Number of TX	2	Ant. :	2
Test Mode :	802.11b	Temperature :	21~25°C
Test Band :	2.4GHz Mid	Relative Humidity :	51~54%
Test Channel :	06	Test Engineer :	Shiming Liu

WLAN 802.11b Channel 06

100kHz PSD reference Level

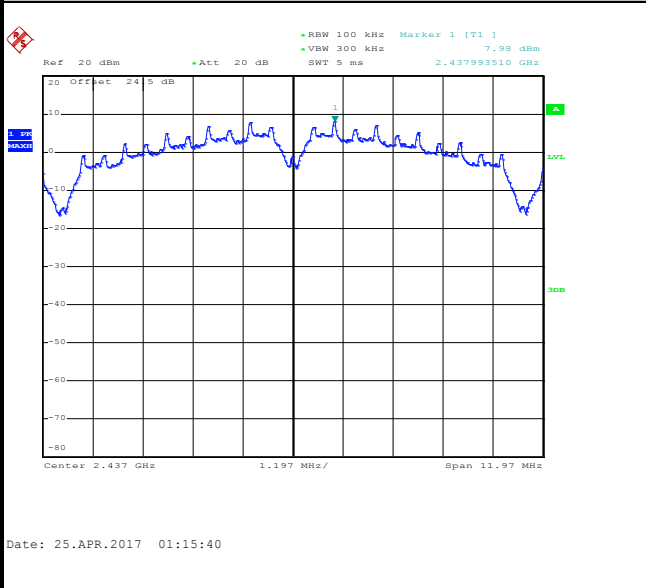

Spurious Emission 30MHz~3GHz

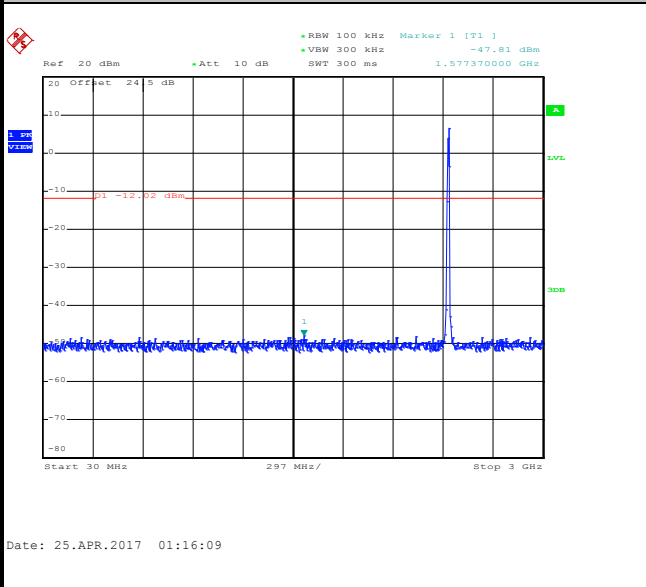

Spurious Emission 2GHz~25GHz

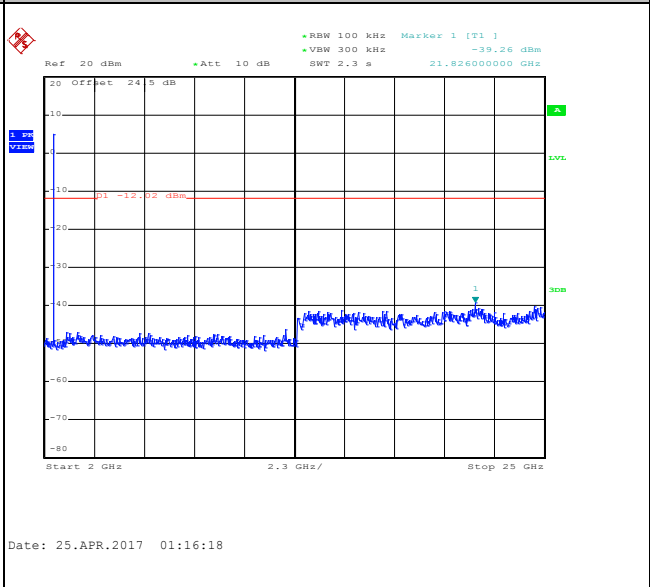



Number of TX	2	Ant. :	2
Test Mode :	802.11b	Temperature :	21~25°C
Test Band :	2.4GHz High	Relative Humidity :	51~54%
Test Channel :	11	Test Engineer :	Shiming Liu

WLAN 802.11b Channel 11

100kHz PSD reference Level

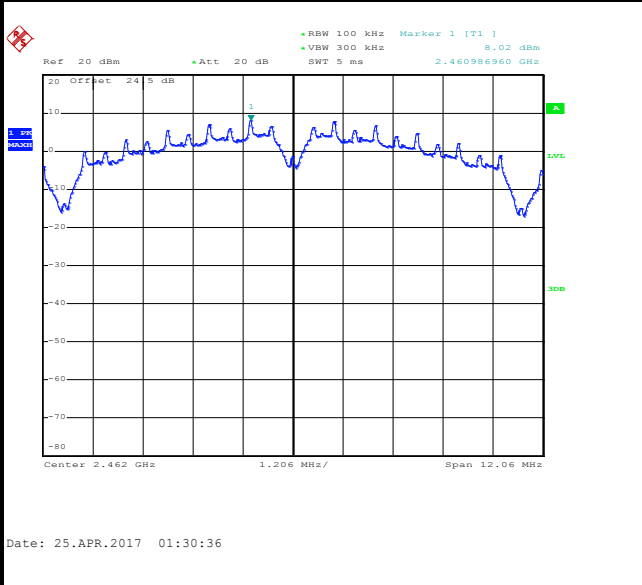

High Channel Plot

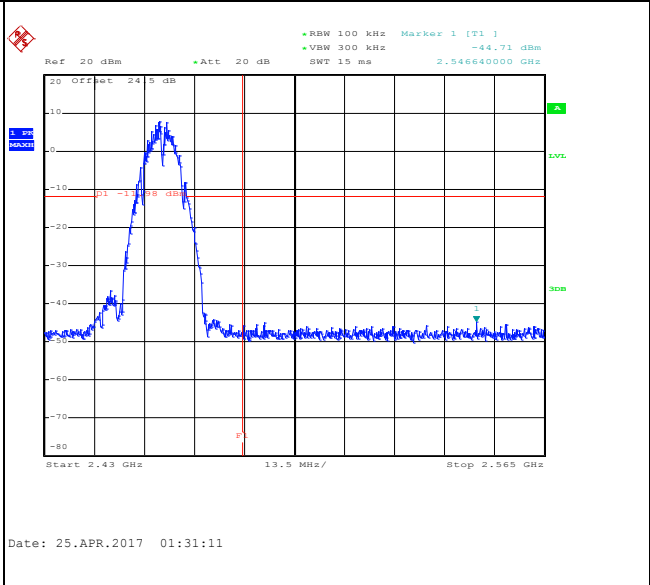

Spurious Emission 30MHz~3GHz

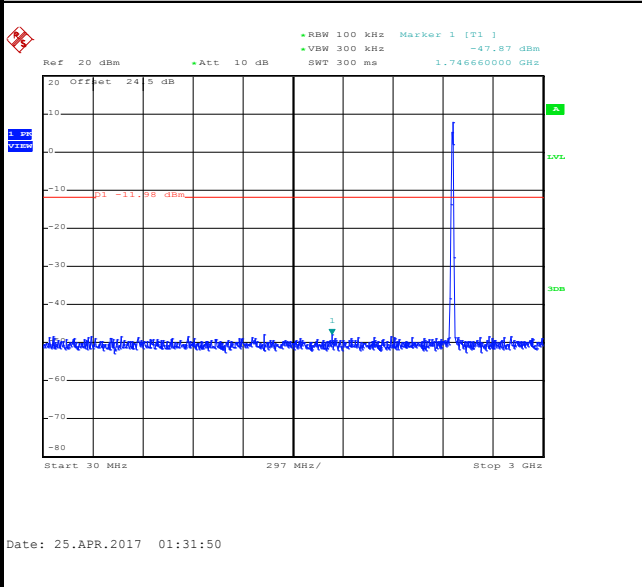

Spurious Emission 2GHz~25GHz

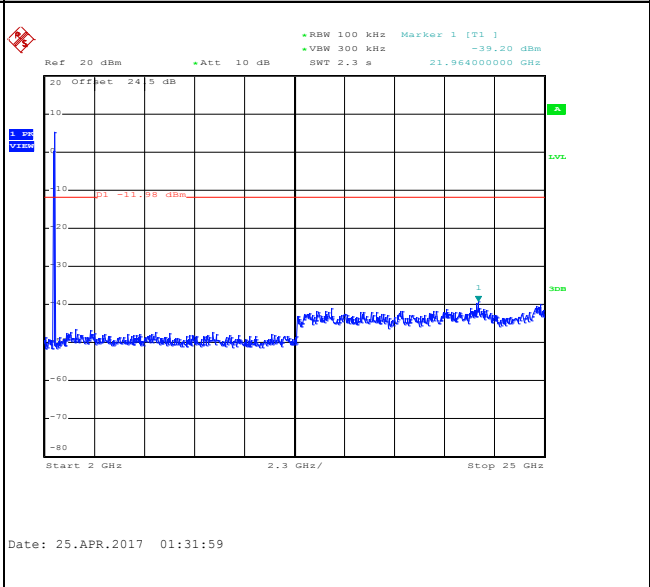



Number of TX	2	Ant. :	2
Test Mode :	802.11g	Temperature :	21~25°C
Test Band :	2.4GHz Low	Relative Humidity :	51~54%
Test Channel :	01	Test Engineer :	Shiming Liu

WLAN 802.11g Channel 01

100kHz PSD reference Level

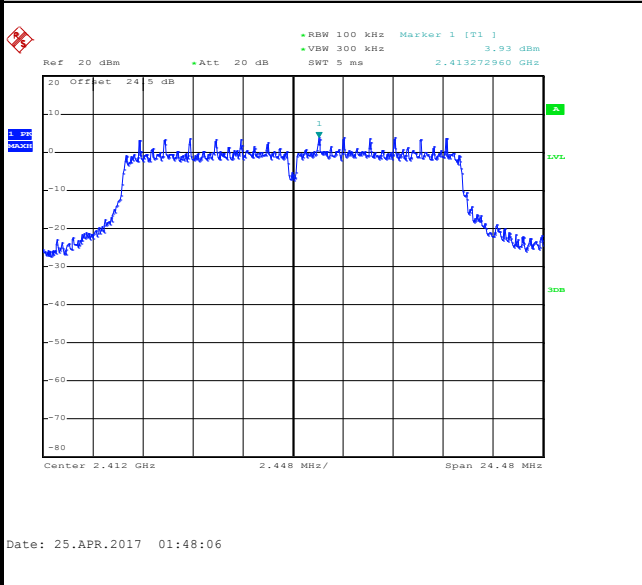

Low Channel Plot

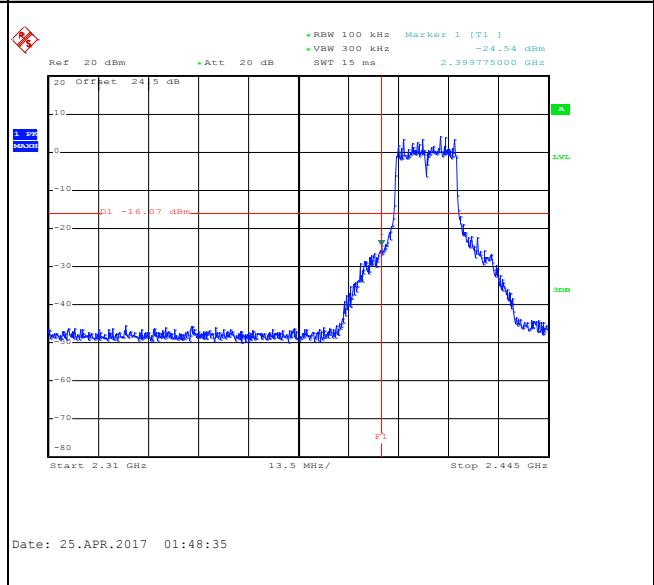

Spurious Emission 30MHz~3GHz

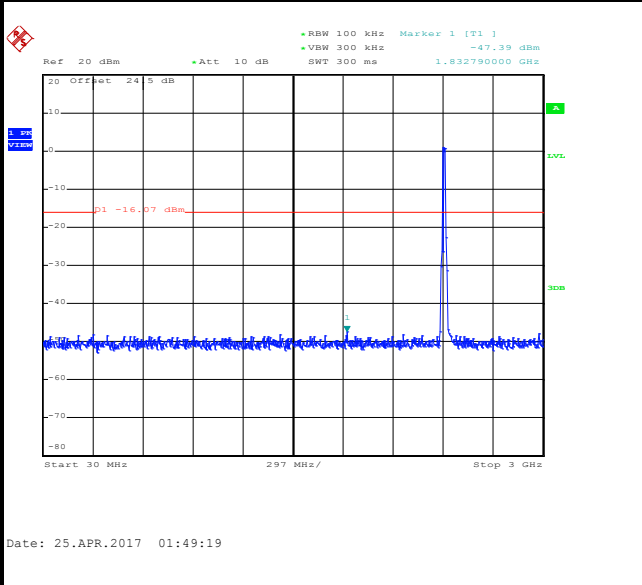

Spurious Emission 2GHz~25GHz

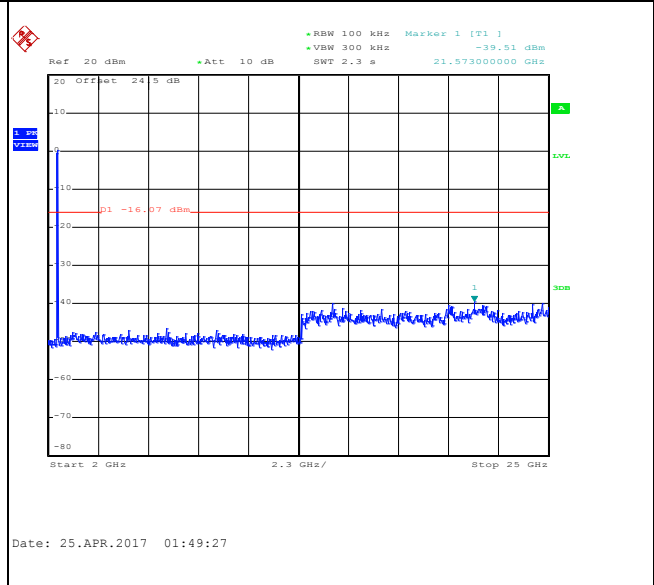



Number of TX	2	Ant. :	2
Test Mode :	802.11g	Temperature :	21~25°C
Test Band :	2.4GHz Mid	Relative Humidity :	51~54%
Test Channel :	06	Test Engineer :	Shiming Liu

WLAN 802.11g Channel 06

100kHz PSD reference Level

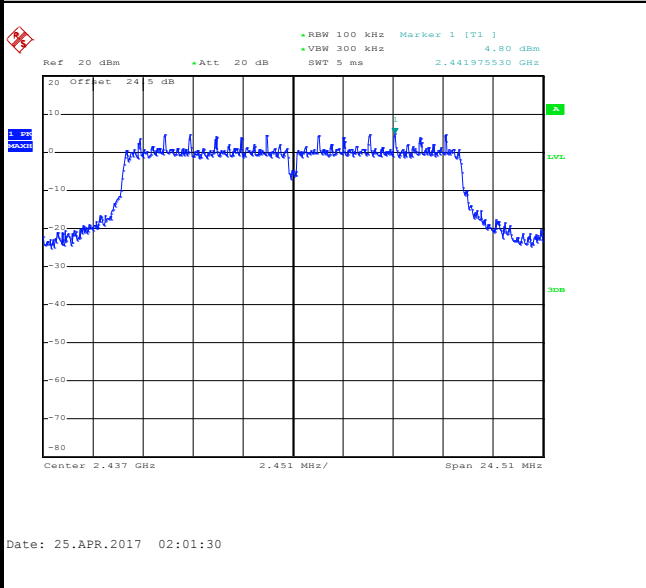

Spurious Emission 30MHz~3GHz

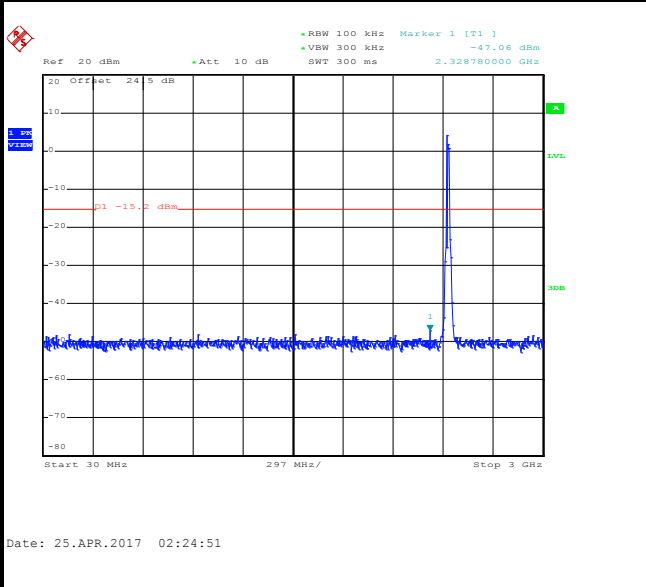

Spurious Emission 2GHz~25GHz

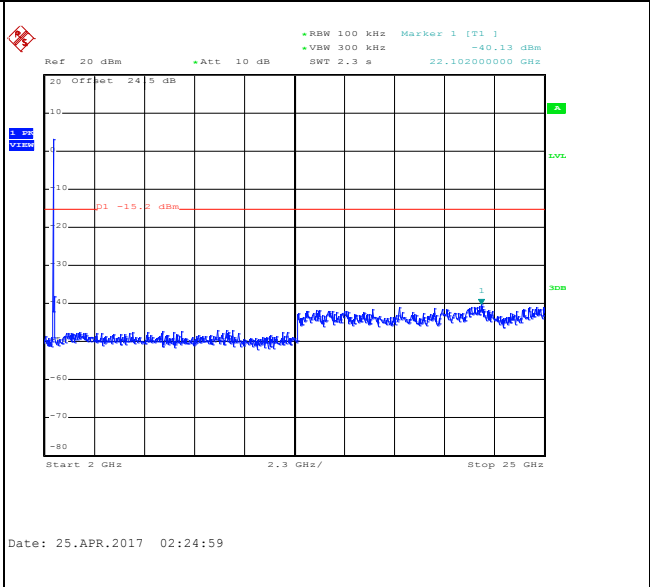



Number of TX	2	Ant. :	2
Test Mode :	802.11g	Temperature :	21~25°C
Test Band :	2.4GHz High	Relative Humidity :	51~54%
Test Channel :	11	Test Engineer :	Shiming Liu

WLAN 802.11g Channel 11

100kHz PSD reference Level

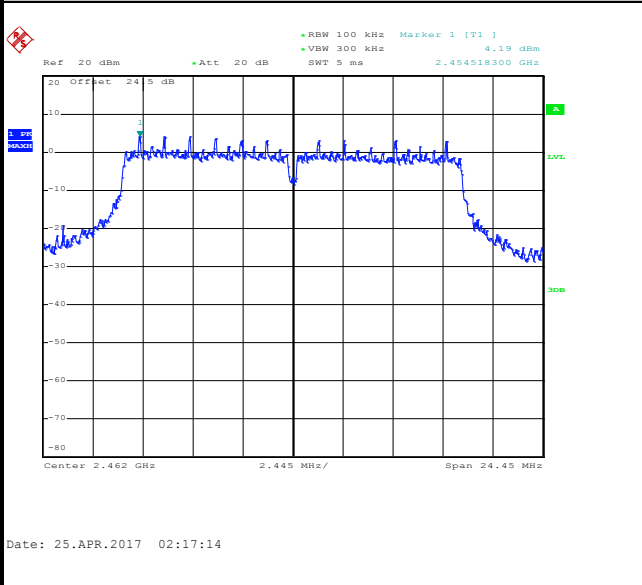

High Channel Plot

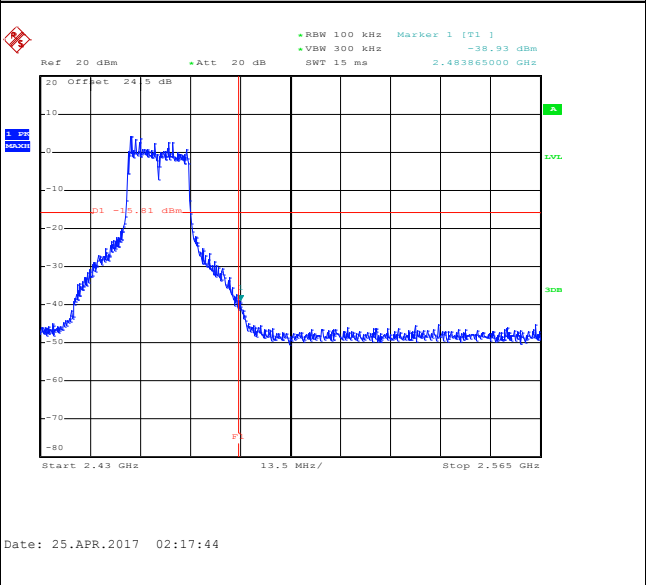

Spurious Emission 30MHz~3GHz

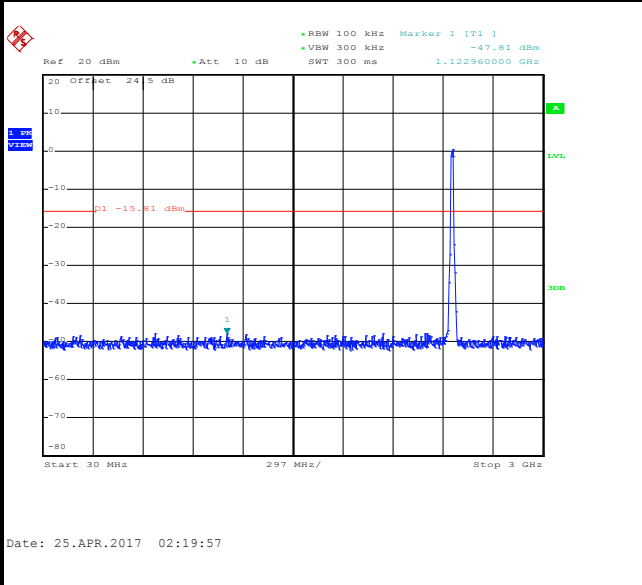

Spurious Emission 2GHz~25GHz

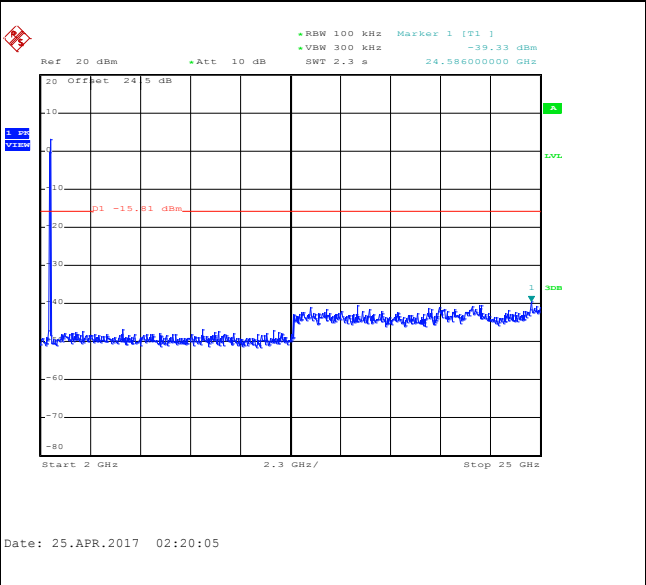



Number of TX	2	Ant. :	2
Test Mode :	802.11n HT20	Temperature :	21~25°C
Test Band :	2.4GHz Low	Relative Humidity :	51~54%
Test Channel :	01	Test Engineer :	Shiming Liu

WLAN 802.11n HT20 Channel 01

100kHz PSD reference Level

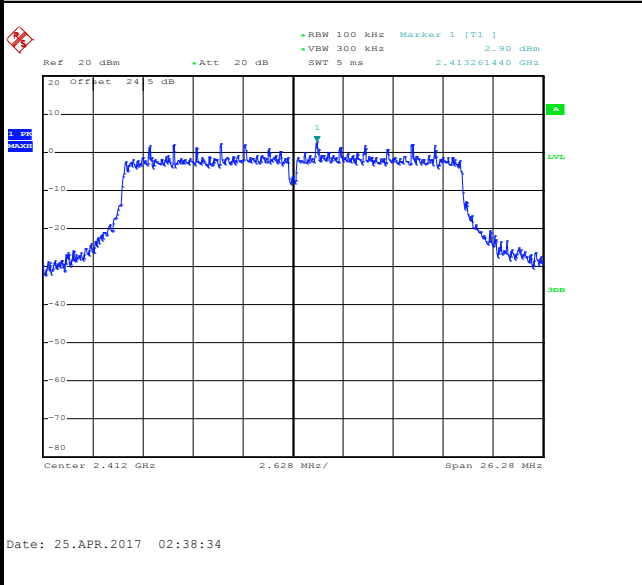

Low Channel Plot

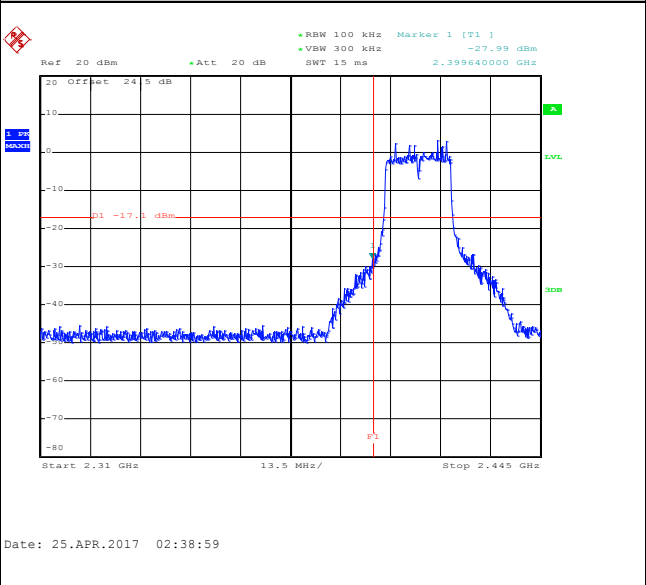

Spurious Emission 30MHz~3GHz

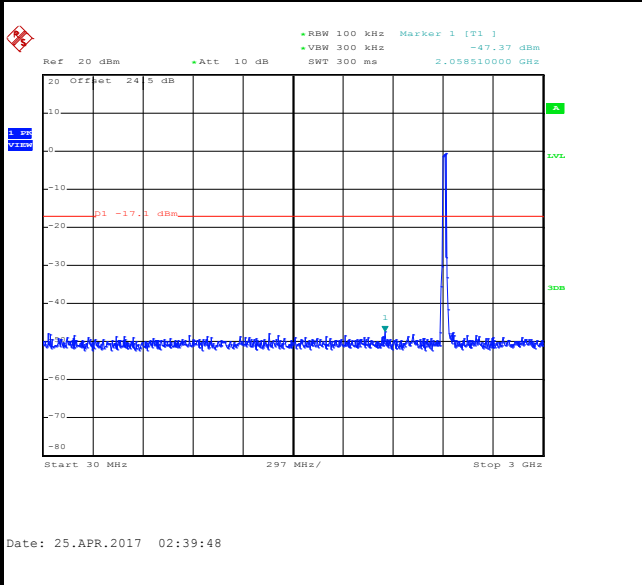

Spurious Emission 2GHz~25GHz

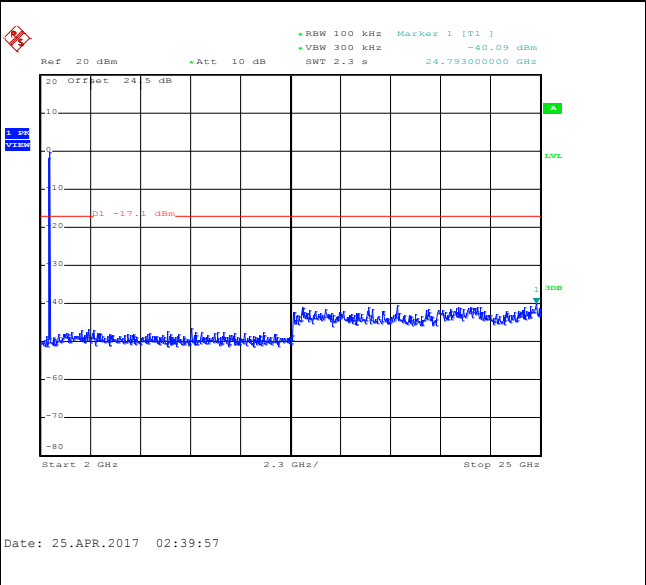



Number of TX	2	Ant. :	2
Test Mode :	802.11n HT20	Temperature :	21~25°C
Test Band :	2.4GHz Mid	Relative Humidity :	51~54%
Test Channel :	06	Test Engineer :	Shiming Liu

WLAN 802.11n HT20 Channel 06

100kHz PSD reference Level

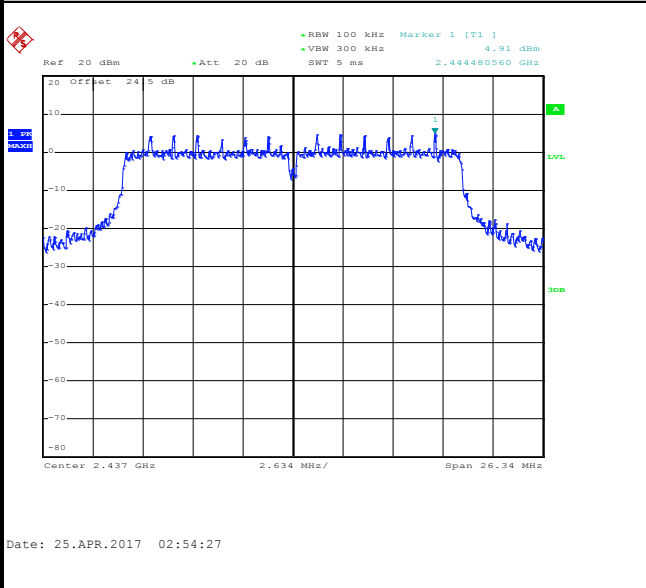

Spurious Emission 30MHz~3GHz

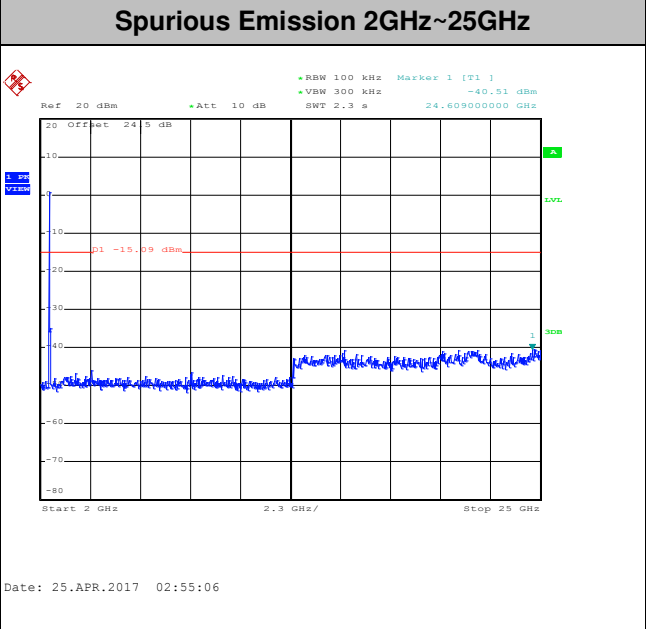
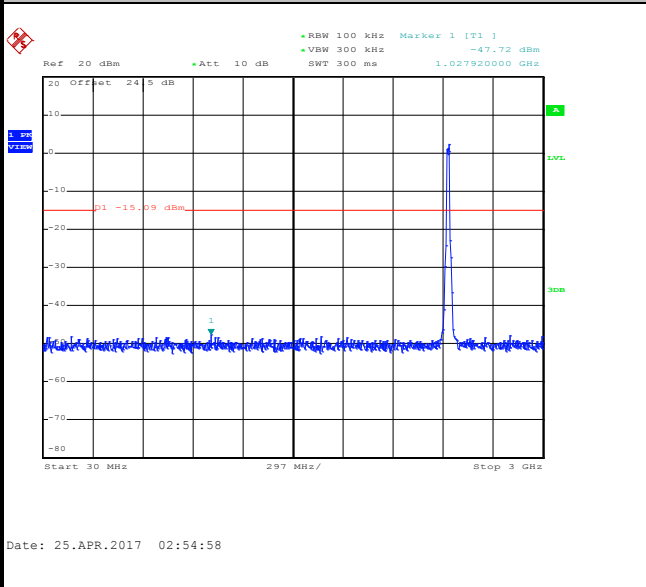



Number of TX	2	Ant. :	2
Test Mode :	802.11n HT20	Temperature :	21~25°C
Test Band :	2.4GHz High	Relative Humidity :	51~54%
Test Channel :	11	Test Engineer :	Shiming Liu

WLAN 802.11n HT20 Channel 11

100kHz PSD reference Level

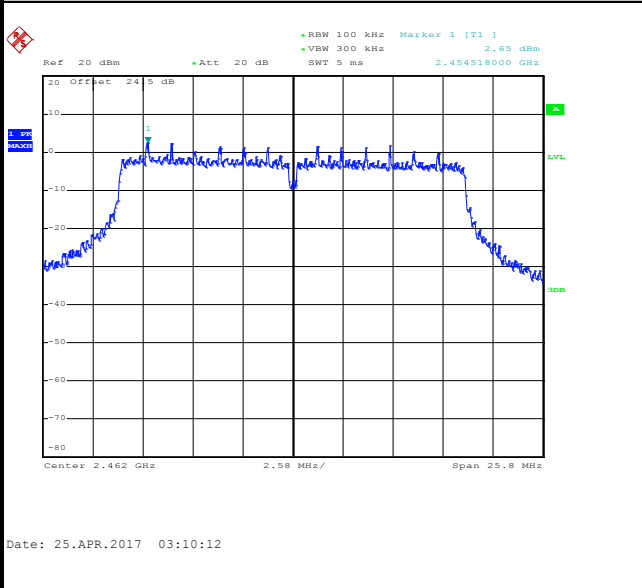

High Channel Plot

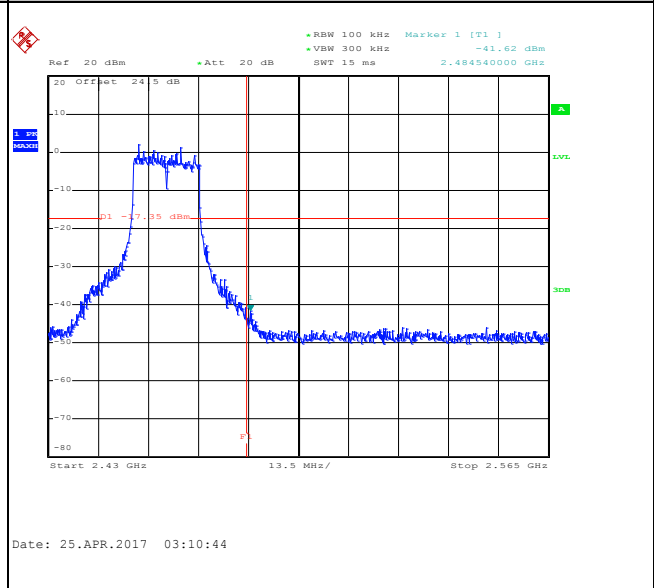

Spurious Emission 30MHz~3GHz

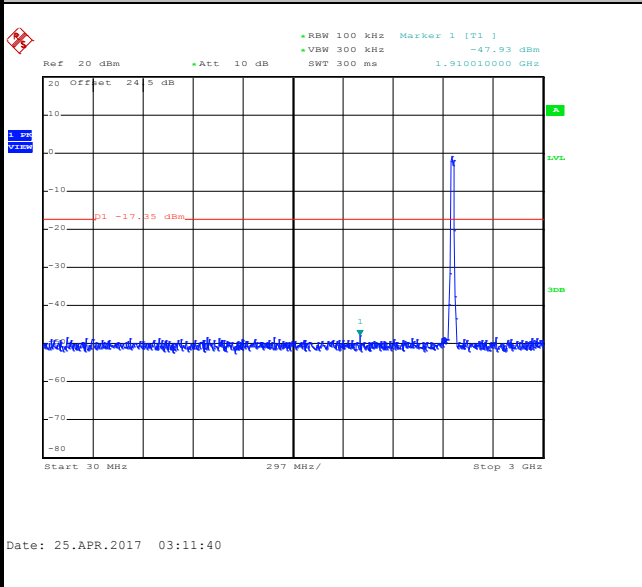

Spurious Emission 2GHz~25GHz

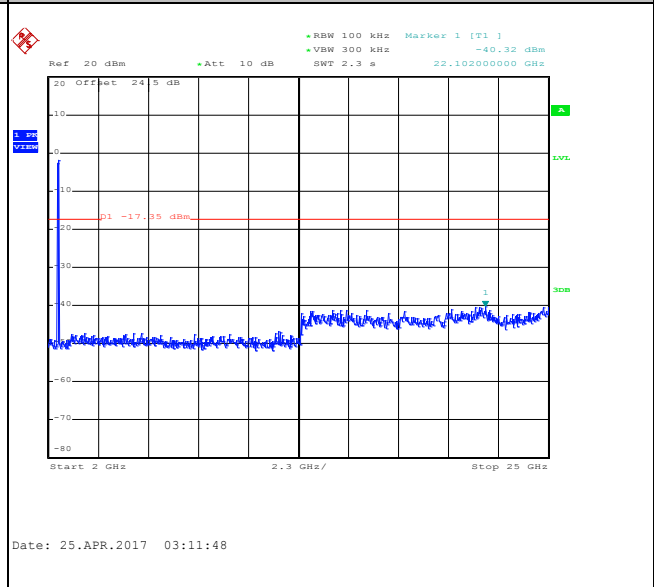



Number of TX	2	Ant. :	2
Test Mode :	802.11ac VHT20	Temperature :	21~25°C
Test Band :	2.4GHz Low	Relative Humidity :	51~54%
Test Channel :	01	Test Engineer :	Shiming Liu

WLAN 802.11ac VHT20 Channel 01

100kHz PSD reference Level

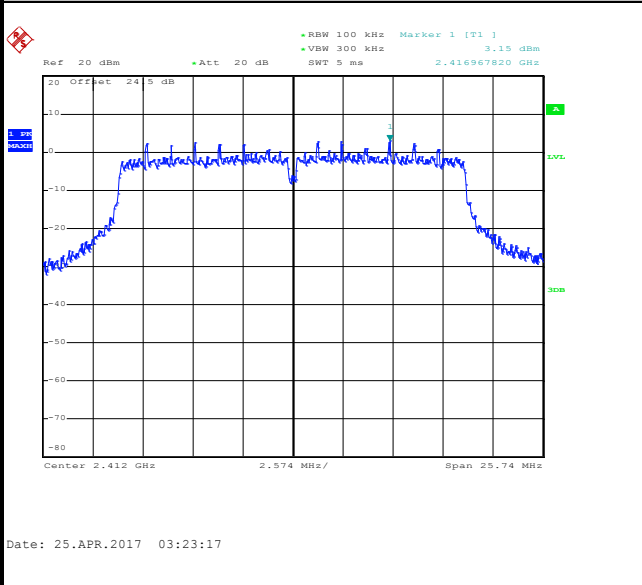

Low Channel Plot

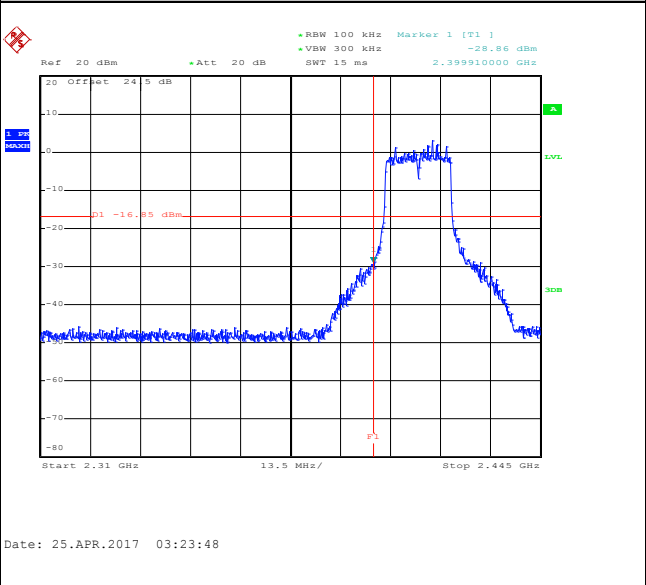

Spurious Emission 30MHz~3GHz

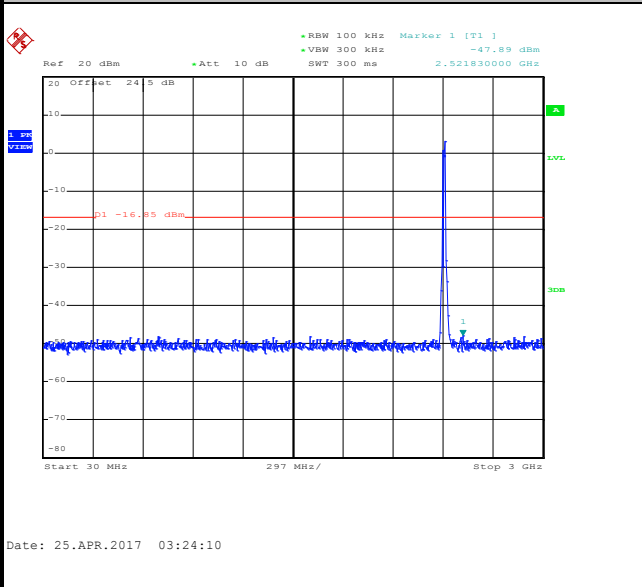

Spurious Emission 2GHz~25GHz

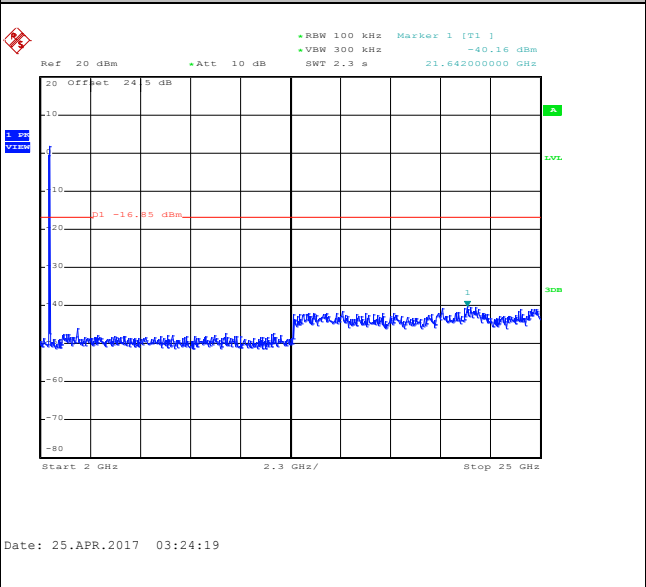



Number of TX	2	Ant. :	2
Test Mode :	802.11ac VHT20	Temperature :	21~25°C
Test Band :	2.4GHz Mid	Relative Humidity :	51~54%
Test Channel :	06	Test Engineer :	Shiming Liu

WLAN 802.11ac VHT20 Channel 06

100kHz PSD reference Level

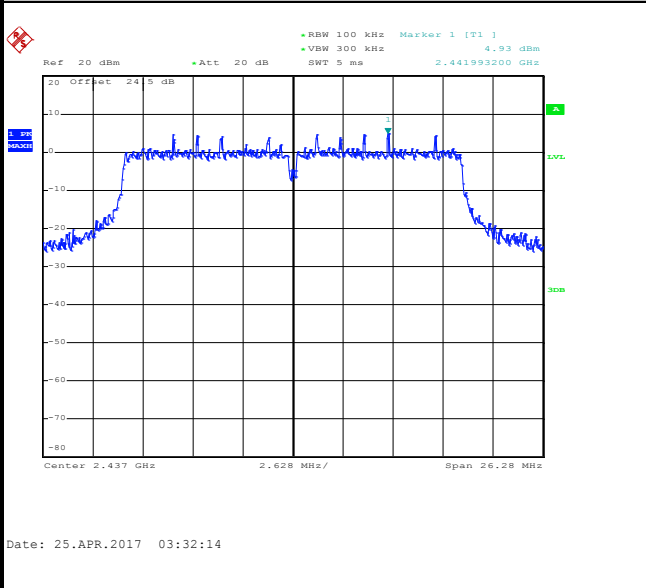

Spurious Emission 30MHz~3GHz

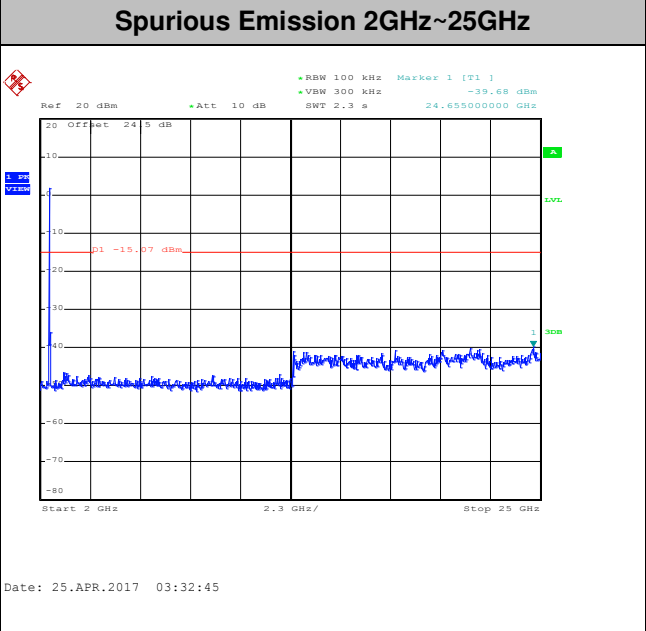
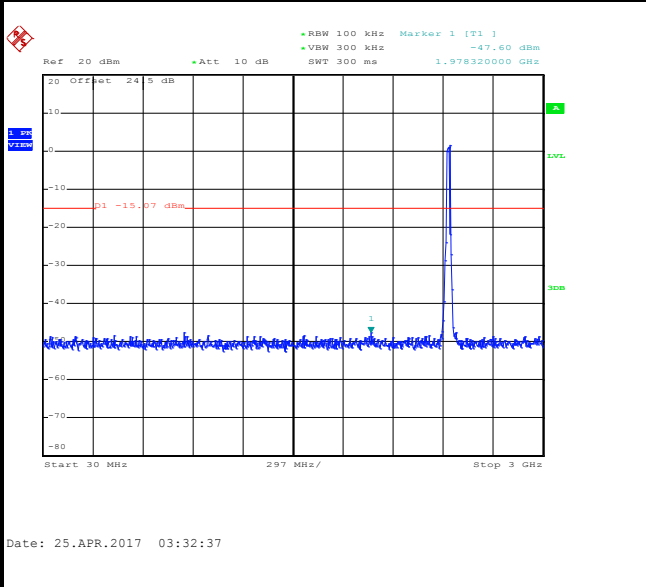



Number of TX	2	Ant. :	2
Test Mode :	802.11ac VHT20	Temperature :	21~25°C
Test Band :	2.4GHz High	Relative Humidity :	51~54%
Test Channel :	11	Test Engineer :	Shiming Liu

WLAN 802.11ac VHT20 Channel 11

100kHz PSD reference Level

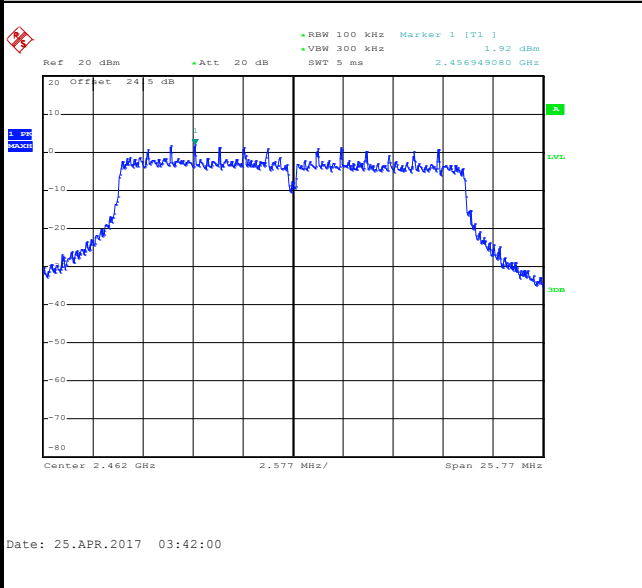

High Channel Plot

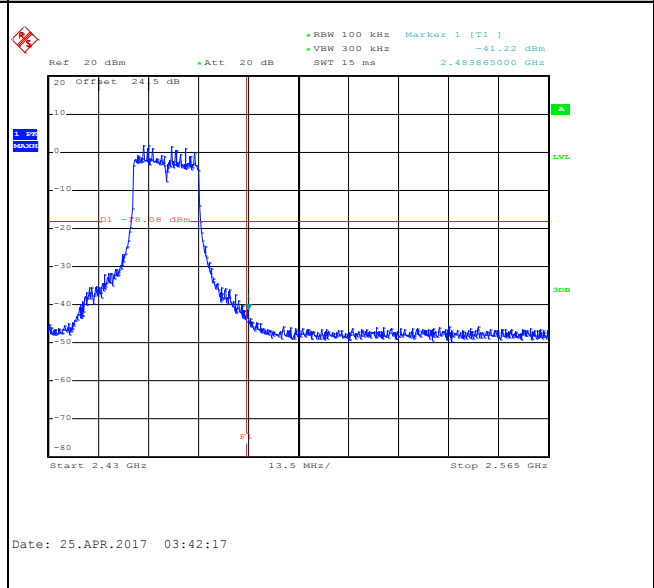

Spurious Emission 30MHz~3GHz

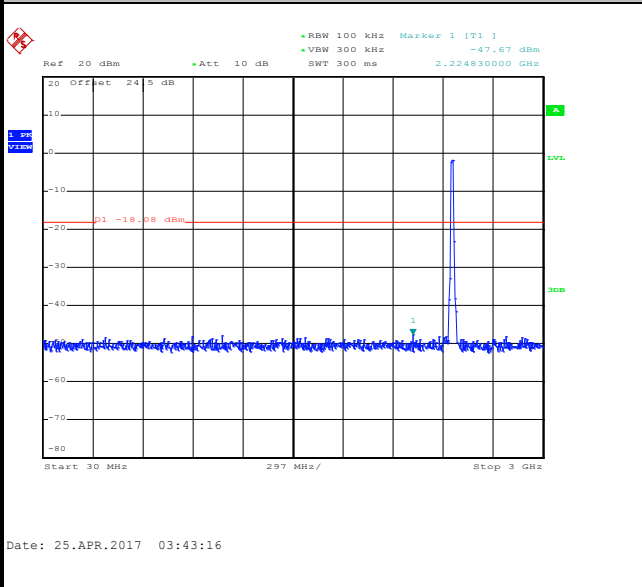

Spurious Emission 2GHz~25GHz

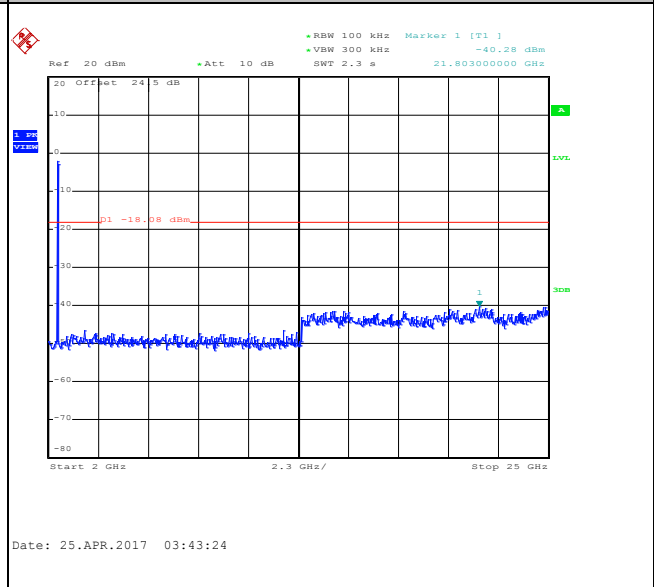



3.5 Radiated Band Edges and Spurious Emission Measurement

3.5.1 Limit of Radiated band edge and Spurious Emission Measurement

In any 100 kHz bandwidth outside the intentional radiator frequency band, all harmonics/spurious must be at least 20 dB below the highest emission level within the authorized band. If the output power of this device was measured by spectrum analyzer, the attenuation under this paragraph shall be 30 dB instead of 20 dB. In addition, radiated emissions which fall in the restricted bands must also comply with the limits as below.

Frequency (MHz)	Field Strength (microvolts/meter)	Measurement Distance (meters)
0.009 – 0.490	2400/F(kHz)	300
0.490 – 1.705	24000/F(kHz)	30
1.705 – 30.0	30	30
30 – 88	100	3
88 – 216	150	3
216 - 960	200	3
Above 960	500	3

3.5.2 Measuring Instruments

The measuring equipment is listed in the section 4 of this test report.



3.5.3 Test Procedures

1. The testing follows FCC KDB Publication No. 558074 D01 DTS Meas. Guidance v04.
2. The EUT was arranged to its worst case and then tune the antenna tower (from 1 m to 4 m) and turntable (from 0 degree to 360 degrees) to find the maximum reading. A pre-amp and a high pass filter are used for the test in order to get better signal level.
3. The EUT was placed on a turntable with 0.8 meter for frequency below 1GHz and 1.5 meter for frequency above 1GHz respectively above ground.
4. The EUT was set 3 meters from the interference receiving antenna, which was mounted on the top of a variable height antenna tower.
5. Corrected Reading: Antenna Factor + Cable Loss + Read Level - Preamp Factor = Level
6. For testing below 1GHz, if the emission level of the EUT in peak mode was 3 dB lower than the limit specified, then peak values of EUT will be reported, otherwise, the emissions will be repeated one by one using the CISPR quasi-peak method and reported.
7. For testing above 1GHz, the emission level of the EUT in peak mode was 20dB lower than average limit (that means the emission level in average mode also complies with the limit in average mode), then peak values of EUT will be reported, otherwise, the emissions will be measured in average mode again and reported.
8. Use the following spectrum analyzer settings:
 - (1) Span shall wide enough to fully capture the emission being measured;
 - (2) Set RBW=100 kHz for $f < 1$ GHz; VBW \geq RBW; Sweep = auto; Detector function = peak; Trace = max hold;
 - (3) Set RBW = 1 MHz, VBW= 3MHz for $f \geq 1$ GHz for peak measurement.
For average measurement:
 - VBW = 10 Hz, when duty cycle is no less than 98 percent.
 - VBW $\geq 1/T$, when duty cycle is less than 98 percent where T is the minimum transmission duration over which the transmitter is on and is transmitting at its maximum power control level for the tested mode of operation.

3.5.4 Test Setup

For radiated emissions below 30MHz

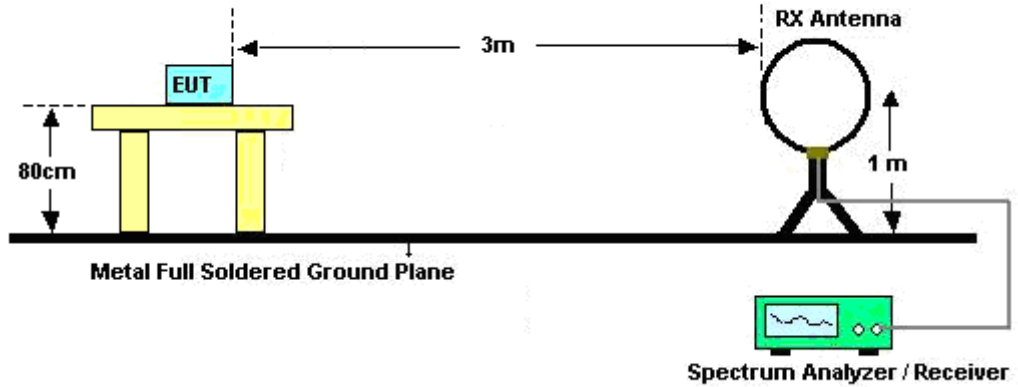

For radiated emissions from 30MHz to 1GHz

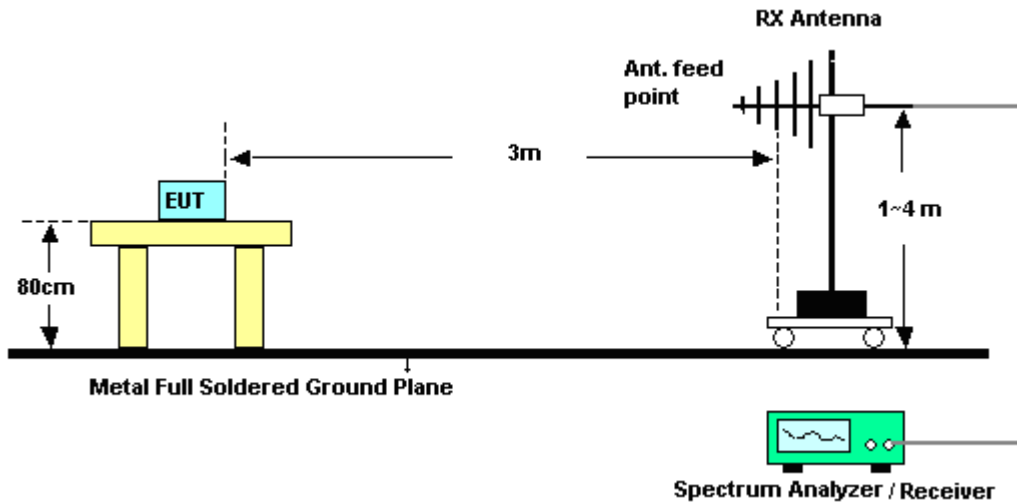

For radiated emissions above 1GHz

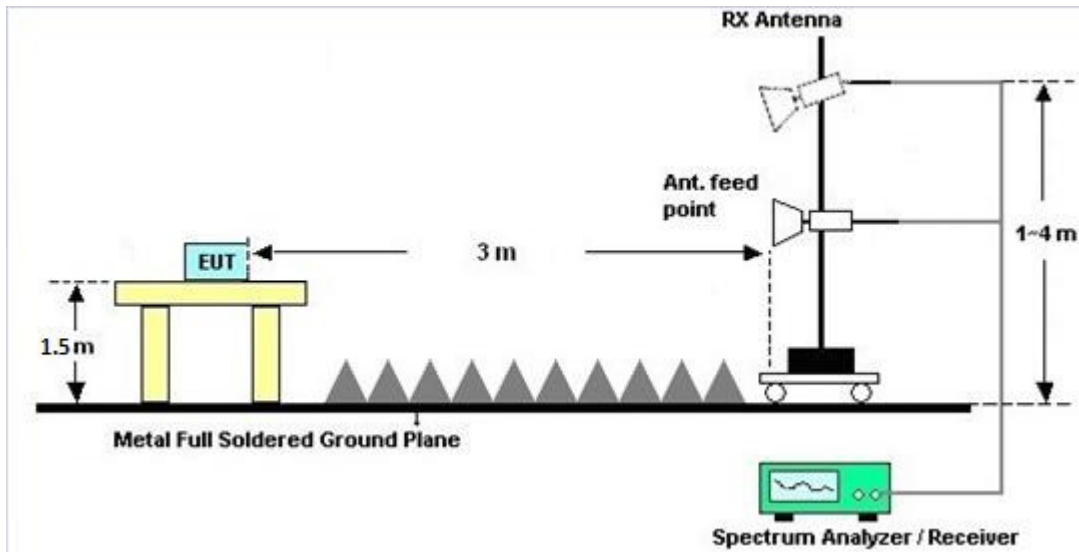

3.5.5 Test Results of Radiated Spurious Emissions (9kHz ~ 30MHz)

The low frequency, which started from 9 kHz to 30MHz, was pre-scanned and the result which was 20dB lower than the limit line was not reported.

3.5.6 Test Result of Radiated Spurious at Band Edges

Please refer to Appendix B and C.

3.5.7 Duty Cycle

Please refer to Appendix D.

3.5.8 Test Result of Radiated Spurious Emission (30MHz ~ 10th Harmonic)

Please refer to Appendix B and C.



3.6 AC Conducted Emission Measurement

3.6.1 Limit of AC Conducted Emission

For equipment that is designed to be connected to the public utility (AC) power line, the radio frequency voltage that is conducted back onto the AC power line on any frequency or frequencies within the band 150 kHz to 30 MHz shall not exceed the limits in the following table.

Frequency of Emission (MHz)	Conducted Limit (dBµV)	
	Quasi-Peak	Average
0.15-0.5	66 to 56*	56 to 46*
0.5-5	56	46
5-30	60	50

*Decreases with the logarithm of the frequency.

3.6.2 Measuring Instruments

The measuring equipment is listed in the section 4 of this test report.

3.6.3 Test Procedures

1. The EUT was placed 0.4 meter from the conducting wall of the shielding room, and it was kept at least 80 centimeters from any other grounded conducting surface.
2. Connect EUT to the power mains through a line impedance stabilization network (LISN).
3. All the support units are connecting to the other LISN.
4. The LISN provides 50 ohm coupling impedance for the measuring instrument.
5. The FCC states that a 50 ohm, 50 microhenry LISN should be used.
6. Both sides of AC line were checked for maximum conducted interference.
7. The frequency range from 150 kHz to 30 MHz was searched.
8. Set the test-receiver system to Peak Detect Function and specified bandwidth (IF bandwidth = 9kHz) with Maximum Hold Mode.

3.6.4 Test Setup

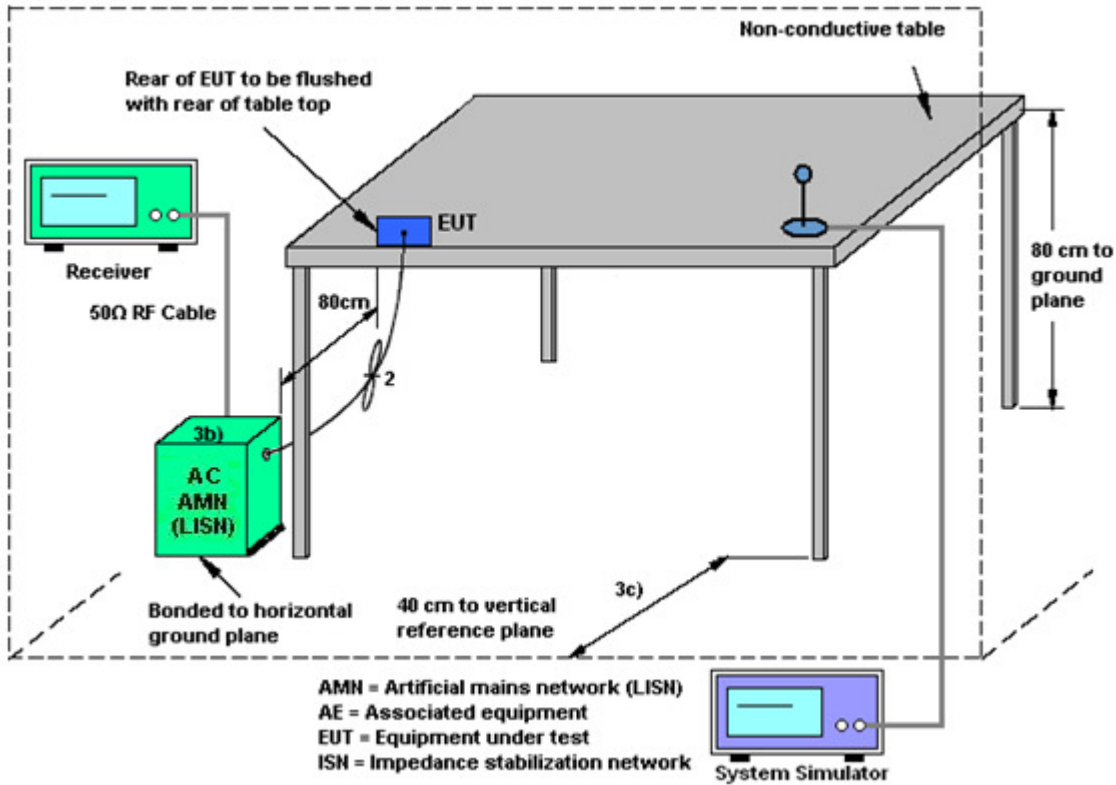

3.6.5 Test Result of AC Conducted Emission

Test Mode :	Mode 1	Temperature :	21~23°C
Test Engineer :	Eric Jeng	Relative Humidity :	52~55%
Test Voltage :	120Vac / 60Hz	Phase :	Line
Function Type :	GSM850 Idle + Bluetooth Link + WLAN (2.4GHz) Link + MP3 + Battery 2 + USB Cable (Charging from Adapter 3)		

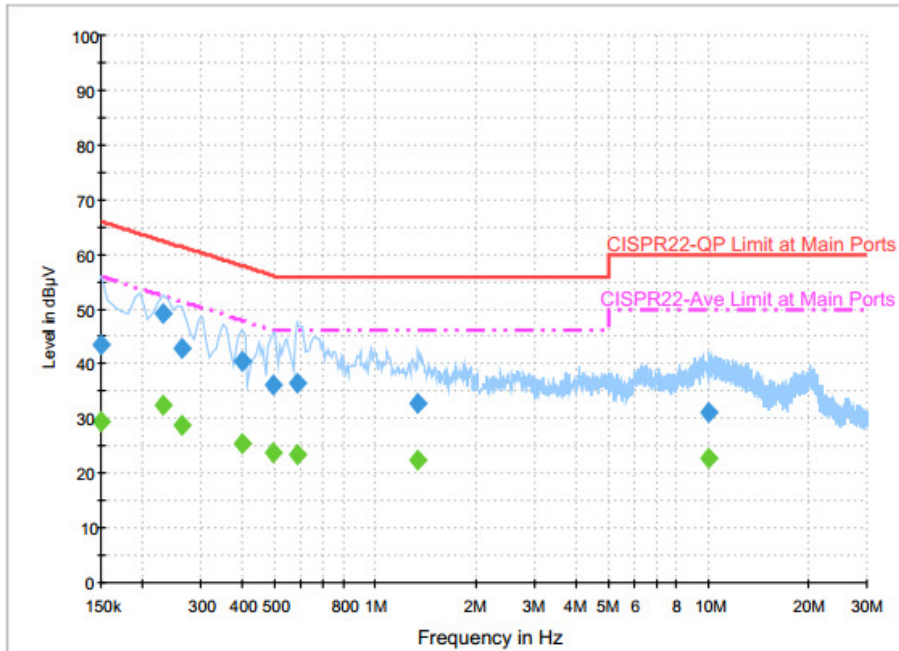

Final Result : Quasi-Peak

Frequency (MHz)	Quasi-Peak (dBµV)	Filter	Line	Corr. (dB)	Margin (dB)	Limit (dBµV)
0.150000	43.4	Off	L1	19.6	22.6	66.0
0.230000	49.1	Off	L1	19.6	13.3	62.4
0.262000	42.7	Off	L1	19.6	18.7	61.4
0.398000	40.6	Off	L1	19.6	17.3	57.9
0.494000	36.0	Off	L1	19.6	20.1	56.1
0.582000	36.5	Off	L1	19.6	19.5	56.0
1.342000	32.7	Off	L1	19.6	23.3	56.0
10.062000	31.0	Off	L1	20.0	29.0	60.0

Final Result : Average

Frequency (MHz)	Average (dBµV)	Filter	Line	Corr. (dB)	Margin (dB)	Limit (dBµV)
0.150000	29.4	Off	L1	19.6	26.6	56.0
0.230000	32.5	Off	L1	19.6	19.9	52.4
0.262000	28.8	Off	L1	19.6	22.6	51.4
0.398000	25.3	Off	L1	19.6	22.6	47.9
0.494000	23.8	Off	L1	19.6	22.3	46.1
0.582000	23.6	Off	L1	19.6	22.4	46.0
1.342000	22.5	Off	L1	19.6	23.5	46.0
10.062000	22.8	Off	L1	20.0	27.2	50.0



Test Mode :	Mode 1	Temperature :	21~23°C
Test Engineer :	Eric Jeng	Relative Humidity :	52~55%
Test Voltage :	120Vac / 60Hz	Phase :	Neutral
Function Type :	GSM850 Idle + Bluetooth Link + WLAN (2.4GHz) Link + MP3 + Battery 2 + USB Cable (Charging from Adapter 3)		

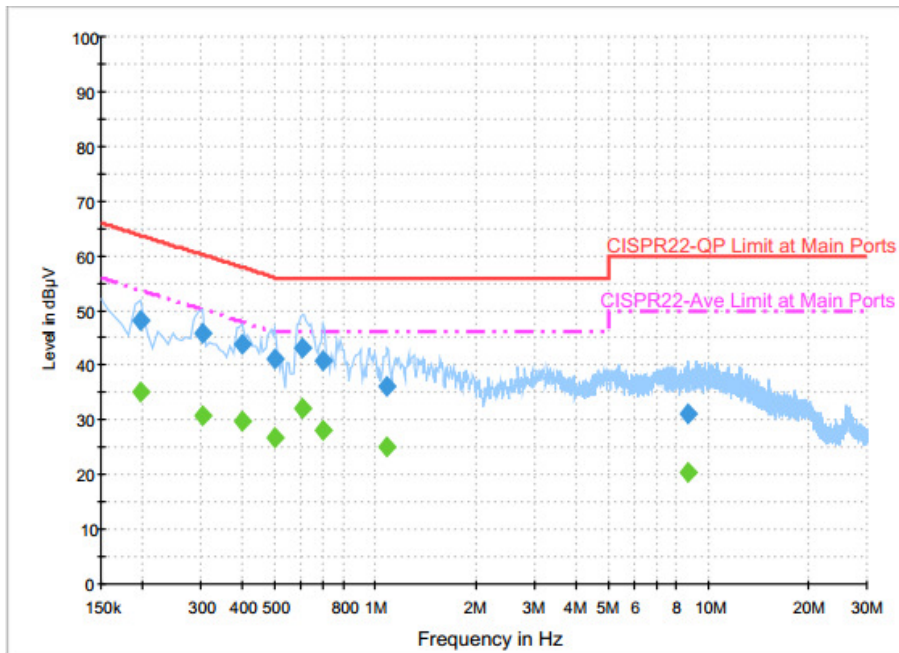

Final Result : Quasi-Peak

Frequency (MHz)	Quasi-Peak (dBµV)	Filter	Line	Corr. (dB)	Margin (dB)	Limit (dBµV)
0.198000	48.1	Off	N	19.5	15.6	63.7
0.302000	46.0	Off	N	19.5	14.2	60.2
0.398000	43.7	Off	N	19.5	14.2	57.9
0.502000	41.0	Off	N	19.5	15.0	56.0
0.606000	43.2	Off	N	19.5	12.8	56.0
0.694000	40.7	Off	N	19.5	15.3	56.0
1.086000	36.2	Off	N	19.6	19.8	56.0
8.710000	31.1	Off	N	20.0	28.9	60.0

Final Result : Average

Frequency (MHz)	Average (dBµV)	Filter	Line	Corr. (dB)	Margin (dB)	Limit (dBµV)
0.198000	35.2	Off	N	19.5	18.5	53.7
0.302000	30.9	Off	N	19.5	19.3	50.2
0.398000	29.8	Off	N	19.5	18.1	47.9
0.502000	26.8	Off	N	19.5	19.2	46.0
0.606000	32.2	Off	N	19.5	13.8	46.0
0.694000	28.0	Off	N	19.5	18.0	46.0
1.086000	25.0	Off	N	19.6	21.0	46.0
8.710000	20.3	Off	N	20.0	29.7	50.0



3.7 Antenna Requirements

3.7.1 Standard Applicable

If directional gain of transmitting antennas is greater than 6dBi, the power shall be reduced by the same level in dB comparing to gain minus 6dBi. For the fixed point-to-point operation, the power shall be reduced by one dB for every 3 dB that the directional gain of the antenna exceeds 6 dBi. The use of a permanently attached antenna or of an antenna that uses a unique coupling to the intentional radiator shall be considered sufficient to comply with the rule.

3.7.2 Antenna Anti-Replacement Construction

An embedded-in antenna design is used.

3.7.3 Antenna Gain

FCC KDB 662911 D01 Multiple Transmitter Output v02r01

For CDD transmissions, directional gain is calculated as

Directional gain = $G_{ANT} + \text{Array Gain}$, where Array Gain is as follows.

For power spectral density (PSD) measurements on all devices,

Array Gain = $10 \log(N_{ANT}/N_{SS}=1)$ dB.

For power measurements on IEEE 802.11 devices,

Array Gain = 0 dB (i.e., no array gain) for $N_{ANT} \leq 4$.

Directional gain may be calculated by using the formulas applicable to equal gain antennas with G_{ANT} set equal to the gain of the antenna having the highest gain;

The EUT supports CDD mode.

For power, the directional gain G_{ANT} is set equal to the antenna having the highest gain, i.e., F)2)f)i).

For PSD, the directional gain calculation is following F)2)f)ii) of KDB 662911 D01 v02r01.

The power and PSD limit should be modified if the directional gain of EUT is over 6 dBi,

The directional gain "DG" is calculated as following table.

			DG	DG	Power	PSD
	Ant. 1	Ant. 2	for	for	Limit	Limit
	(dBi)	(dBi)	Power	PSD	Reduction	Reduction
			(dBi)	(dBi)	(dB)	(dB)
2.4 GHz	-2.00	-0.30	-0.30	1.90	0.00	0.00

$Power\ Limit\ Reduction = DG(Power) - 6dBi, (min = 0)$

$PSD\ Limit\ Reduction = DG(PSD) - 6dBi, (min = 0)$



4 List of Measuring Equipment

Instrument	Manufacturer	Model No.	Serial No.	Characteristics	Calibration Date	Test Date	Due Date	Remark
Power Meter	Anritsu	ML2495A	0932001	300MHz~40GHz z	Sep. 29, 2016	Apr. 01, 2017~ Apr. 25, 2017	Sep. 28, 2017	Conducted (TH05-HY)
Power Sensor	Anritsu	MA2411B	0846202	300MHz~40GHz z	Sep. 29, 2016	Apr. 01, 2017~ Apr. 25, 2017	Sep. 28, 2017	Conducted (TH05-HY)
Spectrum Analyzer	Rohde & Schwarz	FSP40	100055	9kHz-40GHz	Jul. 17, 2016	Apr. 01, 2017~ Apr. 25, 2017	Jul. 16, 2017	Conducted (TH05-HY)
AC Power Source	ChainTek	APC-1000W	N/A	N/A	N/A	Apr. 05, 2017	N/A	Conduction (CO05-HY)
EMI Test Receiver	Rohde & Schwarz	ESCI 7	100724	9kHz~7GHz	Aug. 30, 2016	Apr. 05, 2017	Aug. 29, 2017	Conduction (CO05-HY)
LISN	Rohde & Schwarz	ENV216	100080	9kHz~30MHz	Nov. 29, 2016	Apr. 05, 2017	Nov. 28, 2017	Conduction (CO05-HY)
Amplifier	SONOMA	310N	187312	9kHz~1GHz	Nov. 10, 2016	Apr. 08, 2017~ Apr. 14, 2017	Nov. 09, 2017	Radiation (03CH11-HY)
Loop Antenna	Rohde & Schwarz	HFH2-Z2	100315	9 kHz~30 MHz	Sep. 02, 2015	Apr. 08, 2017~ Apr. 14, 2017	Sep. 01, 2017	Radiation (03CH11-HY)
Bilog Antenna	TESEQ	CBL 6111D	35414	30MHz~1GHz	Oct. 15, 2016	Apr. 08, 2017~ Apr. 14, 2017	Oct. 14, 2017	Radiation (03CH11-HY)
Horn Antenna	SCHWARZBECK	BBHA 9120 D	9120D-132 6	1GHz ~ 18GHz	Oct. 07, 2016	Apr. 08, 2017 ~ Apr. 14, 2017	Oct. 06, 2017	Radiation (03CH11-HY)
Preamplifier	Keysight	83017A	MY532700 80	1GHz~26.5GHz	Nov. 10, 2016	Apr. 08, 2017~ Apr. 14, 2017	Nov. 09, 2017	Radiation (03CH11-HY)
Spectrum Analyzer	Keysight	N9010A	MY542004 86	10Hz ~ 44GHz	Oct. 12, 2016	Apr. 08, 2017 ~ Apr. 14, 2017	Oct. 11, 2017	Radiation (03CH11-HY)
Antenna Mast	EMEC	AM-BS-4500-B	N/A	1~4m	N/A	Apr. 08, 2017~ Apr. 14, 2017	N/A	Radiation (03CH11-HY)
Turn Table	EMEC	TT 2000	N/A	0~360 Degree	N/A	Apr. 08, 2017~ Apr. 14, 2017	N/A	Radiation (03CH11-HY)
Preamplifier	MITEQ	AMF-7D-0010 1800-30-10P	1815698	1GHz~18GHz	Dec. 01, 2016	Apr. 08, 2017~ Apr. 14, 2017	Nov. 30, 2017	Radiation (03CH11-HY)
SHF-EHF Horn Antenna	SCHWARZBECK	BBHA 9170	BBHA9170 584	18GHz- 40GHz	Nov. 08, 2016	Apr. 08, 2017~ Apr. 14, 2017	Nov. 07, 2017	Radiation (03CH11-HY)



5 Uncertainty of Evaluation

Uncertainty of Conducted Emission Measurement (150kHz ~ 30MHz)

Measuring Uncertainty for a Level of Confidence of 95% ($U = 2Uc(y)$)	2.7
---	-----

Uncertainty of Radiated Emission Measurement (30 MHz ~ 1000 MHz)

Measuring Uncertainty for a Level of Confidence of 95% ($U = 2Uc(y)$)	5.2
---	-----

Uncertainty of Radiated Emission Measurement (1000 MHz ~ 18000 MHz)

Measuring Uncertainty for a Level of Confidence of 95% ($U = 2Uc(y)$)	5.5
---	-----

Uncertainty of Radiated Emission Measurement (18000 MHz ~ 40000 MHz)

Measuring Uncertainty for a Level of Confidence of 95% ($U = 2Uc(y)$)	5.2
---	-----

Appendix A. Test Result of Conducted Test Items

Test Engineer:	2017/4/1~2017/4/25	Temperature:	21~25	°C
Test Date:	Shiming Liu	Relative Humidity:	51~54	%

TEST RESULTS DATA
6dB and 99% Occupied Bandwidth

2.4GHz Band										
Mod.	Data Rate	NTX	CH.	Freq. (MHz)	99% Occupied BW (MHz)		6dB BW (MHz)		6dB BW Limit (MHz)	Pass/Fail
					Ant 1	Ant 2	Ant 1	Ant 2		
11b	1Mbps	2	1	2412	12.65	13.20	8.02	8.02	0.50	Pass
11b	1Mbps	2	6	2437	12.85	12.90	8.04	7.98	0.50	Pass
11b	1Mbps	2	11	2462	12.90	12.95	8.04	8.04	0.50	Pass
11g	6Mbps	2	1	2412	17.95	18.00	16.34	16.32	0.50	Pass
11g	6Mbps	2	6	2437	17.95	18.25	16.32	16.34	0.50	Pass
11g	6Mbps	2	11	2462	17.95	18.05	16.32	16.30	0.50	Pass
HT20	MCS0	2	1	2412	18.95	18.85	17.56	17.52	0.50	Pass
HT20	MCS0	2	6	2437	19.15	19.45	17.54	17.56	0.50	Pass
HT20	MCS0	2	11	2462	18.85	19.05	17.56	17.20	0.50	Pass
VHT20	MCS0	2	1	2412	18.80	19.00	17.54	17.16	0.50	Pass
VHT20	MCS0	2	6	2437	19.05	19.40	17.14	17.52	0.50	Pass
VHT20	MCS0	2	11	2462	18.80	19.00	17.54	17.18	0.50	Pass

TEST RESULTS DATA
Peak Output Power

2.4GHz Band																
Mod.	Data Rate	NTX	CH.	Freq. (MHz)	Peak Conducted Power (dBm)			Conducted Power Limit (dBm)		DG (dBi)		EIRP Power (dBm)		EIRP Power Limit (dBm)		Pass /Fail
					Ant 1	Ant 2	SUM	Ant 1	Ant 2	Ant 1	Ant 2	Ant 1	Ant 2	Ant 1	Ant 2	
11b	1Mbps	1	1	2412	18.87	18.83		30.00	30.00	-2.00	-0.30	16.87	18.53	36.00	36.00	Pass
11b	1Mbps	1	6	2437	18.77	18.54		30.00	30.00	-2.00	-0.30	16.77	18.24	36.00	36.00	Pass
11b	1Mbps	1	11	2462	18.67	18.38		30.00	30.00	-2.00	-0.30	16.67	18.08	36.00	36.00	Pass
11g	6Mbps	1	1	2412	23.50	21.90		30.00	30.00	-2.00	-0.30	21.50	21.60	36.00	36.00	Pass
11g	6Mbps	1	6	2437	23.75	22.56		30.00	30.00	-2.00	-0.30	21.75	22.26	36.00	36.00	Pass
11g	6Mbps	1	11	2462	23.35	22.05		30.00	30.00	-2.00	-0.30	21.35	21.75	36.00	36.00	Pass
HT20	MCS0	1	1	2412	22.95	21.47		30.00	30.00	-2.00	-0.30	20.95	21.17	36.00	36.00	Pass
HT20	MCS0	1	6	2437	23.65	22.55		30.00	30.00	-2.00	-0.30	21.65	22.25	36.00	36.00	Pass
HT20	MCS0	1	11	2462	22.51	21.37		30.00	30.00	-2.00	-0.30	20.51	21.07	36.00	36.00	Pass
VHT20	MCS0	1	1	2412	22.91	21.44		30.00	30.00	-2.00	-0.30	20.91	21.14	36.00	36.00	Pass
VHT20	MCS0	1	6	2437	23.70	22.57		30.00	30.00	-2.00	-0.30	21.70	22.27	36.00	36.00	Pass
VHT20	MCS0	1	11	2462	22.15	21.12		30.00	30.00	-2.00	-0.30	20.15	20.82	36.00	36.00	Pass
11b	1Mbps	2	1	2412	18.90	18.75	21.84	30.00		-0.30		21.54		36.00		Pass
11b	1Mbps	2	6	2437	18.60	18.55	21.59	30.00		-0.30		21.29		36.00		Pass
11b	1Mbps	2	11	2462	18.50	18.35	21.44	30.00		-0.30		21.14		36.00		Pass
11g	6Mbps	2	1	2412	23.41	21.73	25.66	30.00		-0.30		25.36		36.00		Pass
11g	6Mbps	2	6	2437	23.67	22.32	26.06	30.00		-0.30		25.76		36.00		Pass
11g	6Mbps	2	11	2462	23.17	21.87	25.58	30.00		-0.30		25.28		36.00		Pass
HT20	MCS0	2	1	2412	22.78	21.27	25.10	30.00		-0.30		24.80		36.00		Pass
HT20	MCS0	2	6	2437	23.48	22.32	25.95	30.00		-0.30		25.65		36.00		Pass
HT20	MCS0	2	11	2462	22.35	21.15	24.80	30.00		-0.30		24.50		36.00		Pass
VHT20	MCS0	2	1	2412	22.80	21.25	25.10	30.00		-0.30		24.80		36.00		Pass
VHT20	MCS0	2	6	2437	23.48	22.28	25.93	30.00		-0.30		25.63		36.00		Pass
VHT20	MCS0	2	11	2462	21.95	20.95	24.49	30.00		-0.30		24.19		36.00		Pass

Note: Measured power (dBm) has offset with cable loss.

TEST RESULTS DATA
Average Output Power

2.4GHz Band									
Mod.	Data Rate	NTX	CH.	Freq. (MHz)	Duty Factor (dB)		Average Conducted Power (dBm)		
					Ant 1	Ant 2	Ant 1	Ant 2	SUM
11b	1Mbps	1	1	2412	0.00	0.00	15.90	15.90	
11b	1Mbps	1	6	2437	0.00	0.00	15.90	15.66	
11b	1Mbps	1	11	2462	0.00	0.00	15.85	15.60	
11g	6Mbps	1	1	2412	0.26	0.23	15.30	15.15	
11g	6Mbps	1	6	2437	0.26	0.23	15.86	15.36	
11g	6Mbps	1	11	2462	0.26	0.23	15.26	14.83	
HT20	MCS0	1	1	2412	0.28	0.28	14.40	14.18	
HT20	MCS0	1	6	2437	0.28	0.28	15.81	15.43	
HT20	MCS0	1	11	2462	0.28	0.28	13.73	13.41	
VHT20	MCS0	1	1	2412	0.24	0.28	14.34	14.17	
VHT20	MCS0	1	6	2437	0.24	0.28	15.83	15.43	
VHT20	MCS0	1	11	2462	0.24	0.28	13.14	12.95	
11b	1Mbps	2	1	2412	0.00	0.00	15.88	15.90	18.90
11b	1Mbps	2	6	2437	0.00	0.00	15.91	15.67	18.80
11b	1Mbps	2	11	2462	0.00	0.00	15.87	15.61	18.75
11g	6Mbps	2	1	2412	0.26	0.23	15.31	15.18	18.26
11g	6Mbps	2	6	2437	0.26	0.23	15.89	15.23	18.58
11g	6Mbps	2	11	2462	0.26	0.23	15.28	14.85	18.08
HT20	MCS0	2	1	2412	0.28	0.25	14.43	14.20	17.33
HT20	MCS0	2	6	2437	0.28	0.25	15.93	15.27	18.62
HT20	MCS0	2	11	2462	0.28	0.25	13.74	13.45	16.61
VHT20	MCS0	2	1	2412	0.28	0.24	14.38	14.19	17.30
VHT20	MCS0	2	6	2437	0.28	0.24	15.88	15.24	18.58
VHT20	MCS0	2	11	2462	0.28	0.24	13.18	12.96	16.08

Note: Measured power (dBm) has offset with cable loss.

TEST RESULTS DATA
Peak Power Spectral Density

2.4GHz Band												
Mod.	Data Rate	NTX	CH.	Freq. (MHz)	Peak PSD (dBm/3kHz)			DG (dBi)		Peak PSD Limit (dBm/3kHz)		Pass/Fail
					Ant 1	Ant 2	Worse + 3.01	Ant 1	Ant 2	Ant 1	Ant 2	
11b	1Mbps	2	1	2412	-9.48	-8.92	-5.91	1.90		8.00		Pass
11b	1Mbps	2	6	2437	-8.48	-9.93	-5.47	1.90		8.00		Pass
11b	1Mbps	2	11	2462	-9.85	-9.62	-6.61	1.90		8.00		Pass
11g	6Mbps	2	1	2412	-11.75	-12.71	-8.74	1.90		8.00		Pass
11g	6Mbps	2	6	2437	-11.08	-12.46	-8.07	1.90		8.00		Pass
11g	6Mbps	2	11	2462	-13.22	-12.98	-9.97	1.90		8.00		Pass
HT20	MCS0	2	1	2412	-13.61	-13.42	-10.41	1.90		8.00		Pass
HT20	MCS0	2	6	2437	-12.65	-11.90	-8.89	1.90		8.00		Pass
HT20	MCS0	2	11	2462	-13.83	-13.17	-10.16	1.90		8.00		Pass
VHT20	MCS0	2	1	2412	-13.32	-13.27	-10.26	1.90		8.00		Pass
VHT20	MCS0	2	6	2437	-10.97	-12.02	-7.96	1.90		8.00		Pass
VHT20	MCS0	2	11	2462	-14.51	-15.05	-11.50	1.90		8.00		Pass

Measured power density (dBm) has offset with cable loss.



Appendix B. Radiated Spurious Emission

Test Engineer :	J.C. Liang, Jacky Hung, and Kan Wu	Temperature :	18~22°C
		Relative Humidity :	55~58%

2.4GHz 2400~2483.5MHz

WIFI 802.11b (Band Edge @ 3m)

WIFI	Note	Frequency	Level	Over	Limit	Read	Antenna	Cable	Preamp	Ant	Table	Peak	Pol.	
Ant.				Limit	Line	Level	Factor	Loss	Factor	Pos	Pos	Avg.		
1+2		(MHz)	(dBμV/m)	(dB)	(dBμV/m)	(dBμV)	(dB/m)	(dB)	(dB)	(cm)	(deg)	(P/A)	(H/V)	
802.11b CH 01 2412MHz		2313.15	52.56	-21.44	74	43.51	26.59	6.14	33.61	161	349	P	H	
		2389.38	41.78	-12.22	54	32.26	26.87	6.32	33.6	161	349	A	H	
	*	2412	109.31	-	-	99.68	26.92	6.37	33.59	161	349	P	H	
	*	2412	106	-	-	96.37	26.92	6.37	33.59	161	349	A	H	
													H	
														H
			2385.075	51.64	-22.36	74	42.18	26.81	6.32	33.6	226	70	P	V
			2389.17	42.12	-11.88	54	32.6	26.87	6.32	33.6	226	70	A	V
	*		2412	107.92	-	-	98.29	26.92	6.37	33.59	226	70	P	V
	*		2412	104.39	-	-	94.76	26.92	6.37	33.59	226	70	A	V
														V
														V
802.11b CH 06 2437MHz		2372.44	52.13	-21.87	74	42.72	26.81	6.27	33.6	160	187	P	H	
		2389.8	40.98	-13.02	54	31.45	26.87	6.32	33.59	160	187	A	H	
	*	2437	107.75	-	-	98.01	27.03	6.37	33.59	160	187	P	H	
	*	2437	104.14	-	-	94.4	27.03	6.37	33.59	160	187	A	H	
			2486.21	51.76	-22.24	74	41.88	27.14	6.39	33.58	160	187	P	H
			2483.83	41.34	-12.66	54	31.46	27.14	6.39	33.58	160	187	A	H
			2348.92	51.94	-22.06	74	42.68	26.7	6.23	33.6	122	105	P	V
			2389.8	41.07	-12.93	54	31.54	26.87	6.32	33.59	122	105	A	V
	*		2437	107.28	-	-	97.54	27.03	6.37	33.59	122	105	P	V
	*		2437	103.84	-	-	94.1	27.03	6.37	33.59	122	105	A	V
			2486.28	52.13	-21.87	74	42.25	27.14	6.39	33.58	122	105	P	V
			2483.83	41.35	-12.65	54	31.47	27.14	6.39	33.58	122	105	A	V



802.11b CH 11 2462MHz	*	2462	108.22	-	-	98.4	27.09	6.38	33.58	103	349	P	H
	*	2462	104.83	-	-	95.01	27.09	6.38	33.58	103	349	A	H
		2484.44	52.98	-21.02	74	43.1	27.14	6.39	33.58	103	349	P	H
		2483.52	42.78	-11.22	54	32.9	27.14	6.39	33.58	103	349	A	H
													H
													H
	*	2462	107.21	-	-	97.39	27.09	6.38	33.58	121	124	P	V
	*	2462	103.75	-	-	93.93	27.09	6.38	33.58	121	124	A	V
		2484.96	52.08	-21.92	74	42.2	27.14	6.39	33.58	121	124	P	V
		2483.52	42.77	-11.23	54	32.89	27.14	6.39	33.58	121	124	A	V
													V
													V
Remark	1. No other spurious found. 2. All results are PASS against Peak and Average limit line.												



**2.4GHz 2400~2483.5MHz
WIFI 802.11b (Harmonic @ 3m)**

WIFI Ant. 1+2	Note	Frequency (MHz)	Level (dBµV/m)	Over Limit (dB)	Limit Line (dBµV/m)	Read Level (dBµV)	Antenna Factor (dB/m)	Cable Loss (dB)	Preamp Factor (dB)	Ant Pos (cm)	Table Pos (deg)	Peak Avg. (P/A)	Pol. (H/V)
802.11b CH 01 2412MHz		4824	56.39	-17.61	74	79.19	31.62	9.89	64.74	100	187	P	H
		4824	53.18	-0.82	54	75.98	31.62	9.89	64.74	100	187	A	H
													H
													H
		4824	55.96	-18.04	74	79.19	31.62	9.89	64.74	155	11	P	V
		4824	51.77	-2.23	54	75	31.62	9.89	64.74	155	11	A	V
													V
													V
802.11b CH 06 2437MHz		4874	55.31	-18.69	74	78.01	31.71	9.86	64.7	136	145	P	H
		4874	52.61	-1.39	54	75.31	31.71	9.86	64.7	136	145	A	H
		7311	46.05	-27.95	74	61.33	37.43	11.65	64.82	100	0	P	H
													H
		4874	54.89	-19.11	74	78.02	31.71	9.86	64.7	316	36	P	V
		4874	52.42	-1.58	54	75.55	31.71	9.86	64.7	316	36	A	V
		7311	45.5	-28.5	74	61.24	37.43	11.65	64.82	100	0	P	V
													V
802.11b CH 11 2462MHz		4924	52.55	-21.45	74	75.15	31.79	9.83	64.66	100	207	P	H
		4924	49.43	-4.57	54	72.03	31.79	9.83	64.66	100	207	A	H
		7386	45.56	-28.44	74	60.59	37.82	11.63	64.86	100	0	P	H
													H
		4924	55.37	-18.63	74	77.97	31.79	9.83	64.66	135	9	P	V
		4924	52.1	-1.9	54	74.7	31.79	9.83	64.66	135	9	A	V
		7386	44.87	-29.13	74	59.9	37.82	11.63	64.86	100	0	P	V
													V
Remark	1. No other spurious found. 2. All results are PASS against Peak and Average limit line.												



**2.4GHz 2400~2483.5MHz
WIFI 802.11g (Band Edge @ 3m)**

WIFI Ant. 1+2	Note	Frequency (MHz)	Level (dBμV/m)	Over Limit (dB)	Limit Line (dBμV/m)	Read Level (dBμV)	Antenna Factor (dB/m)	Cable Loss (dB)	Preamp Factor (dB)	Ant Pos (cm)	Table Pos (deg)	Peak Avg. (P/A)	Pol. (H/V)	
802.11g CH 01 2412MHz		2389.485	66.96	-7.04	74	57.44	26.87	6.32	33.6	314	360	P	H	
		2389.905	53.22	-0.78	54	43.69	26.87	6.32	33.59	314	360	A	H	
	*	2412	107.65	-	-	98.02	26.92	6.37	33.59	314	360	P	H	
	*	2412	99.61	-	-	89.98	26.92	6.37	33.59	314	360	A	H	
													H	
														H
			2390	65.43	-8.57	74	55.9	26.87	6.32	33.59	299	100	P	V
			2389.905	52.45	-1.55	54	42.92	26.87	6.32	33.59	299	100	A	V
	*		2412	108.1	-	-	98.47	26.92	6.37	33.59	299	100	P	V
	*		2412	99.66	-	-	90.03	26.92	6.37	33.59	299	100	A	V
														V
														V
802.11g CH 06 2437MHz		2389.94	51.82	-22.18	74	42.29	26.87	6.32	33.59	340	0	P	H	
		2388.12	42.54	-11.46	54	33.02	26.87	6.32	33.6	340	0	A	H	
	*	2437	107.71	-	-	97.97	27.03	6.37	33.59	340	0	P	H	
	*	2437	99.76	-	-	90.02	27.03	6.37	33.59	340	0	A	H	
			2485.09	52.18	-21.82	74	42.3	27.14	6.39	33.58	340	0	P	H
			2484.25	43.1	-10.9	54	33.22	27.14	6.39	33.58	340	0	A	H
			2389.8	52.44	-21.56	74	42.91	26.87	6.32	33.59	337	100	P	V
			2389.38	42.72	-11.28	54	33.2	26.87	6.32	33.6	337	100	A	V
	*		2437	109.03	-	-	99.29	27.03	6.37	33.59	337	100	P	V
	*		2437	100.31	-	-	90.57	27.03	6.37	33.59	337	100	A	V
			2484.6	51.71	-22.29	74	41.83	27.14	6.39	33.58	337	100	P	V
			2484.74	42.68	-11.32	54	32.8	27.14	6.39	33.58	337	100	A	V



802.11g CH 11 2462MHz	*	2462	107.75	-	-	97.93	27.09	6.38	33.58	302	0	P	H
	*	2462	99.75	-	-	89.93	27.09	6.38	33.58	302	0	A	H
		2484.4	64.72	-9.28	74	54.84	27.14	6.39	33.58	302	0	P	H
		2484.56	50.2	-3.8	54	40.32	27.14	6.39	33.58	302	0	A	H
													H
													H
	*	2462	107.83	-	-	98.01	27.09	6.38	33.58	327	99	P	V
	*	2462	99.55	-	-	89.73	27.09	6.38	33.58	327	99	A	V
		2483.6	69.04	-4.96	74	59.16	27.14	6.39	33.58	327	99	P	V
		2484.32	53.28	-0.72	54	43.4	27.14	6.39	33.58	327	99	A	V
													V
													V
Remark	<ol style="list-style-type: none"> 1. No other spurious found. 2. All results are PASS against Peak and Average limit line. 												



**2.4GHz 2400~2483.5MHz
WIFI 802.11g (Harmonic @ 3m)**

WIFI Ant. 1+2	Note	Frequency (MHz)	Level (dBμV/m)	Over Limit (dB)	Limit Line (dBμV/m)	Read Level (dBμV)	Antenna Factor (dB/m)	Cable Loss (dB)	Preamp Factor (dB)	Ant Pos (cm)	Table Pos (deg)	Peak Avg. (P/A)	Pol. (H/V)
802.11g CH 01 2412MHz		4824	54.21	-19.79	74	77.01	31.62	9.89	64.74	256	226	P	H
		4824	43.06	-10.94	54	65.86	31.62	9.89	64.74	256	226	A	H
													H
													H
		4824	54.94	-19.06	74	77.74	31.62	9.89	64.74	163	345	P	V
		4824	44.45	-9.55	54	67.25	31.62	9.89	64.74	163	345	A	V
													V
													V
802.11g CH 06 2437MHz		4874	50.94	-23.06	74	73.64	31.71	9.86	64.7	100	0	P	H
		7311	49.93	-24.07	74	65.21	37.43	11.65	64.82	100	0	P	H
													H
													H
		4874	54.78	-19.22	74	77.91	31.71	9.86	64.7	189	360	P	V
		4874	43.36	-10.64	54	66.49	31.71	9.86	64.7	189	360	A	V
		7311	46.32	-27.68	74	62.06	37.43	11.65	64.82	100	0	P	V
													V
802.11g CH 11 2462MHz		4924	51.92	-22.08	74	74.52	31.79	9.83	64.66	398	112	P	H
		4924	41.28	-12.72	54	63.88	31.79	9.83	64.66	398	112	A	H
		7386	49.3	-24.7	74	64.33	37.82	11.63	64.86	100	0	P	H
													H
		4924	56.1	-17.9	74	79.14	31.79	9.83	64.66	152	4	P	V
		4924	44.75	-9.25	54	67.79	31.79	9.83	64.66	152	4	A	V
		7386	48.63	-25.37	74	64.04	37.82	11.63	64.86	100	0	P	V
													V
Remark	1. No other spurious found. 2. All results are PASS against Peak and Average limit line.												



**2.4GHz 2400~2483.5MHz
WIFI 802.11n HT20 (Band Edge @ 3m)**

WIFI Ant. 1+2	Note	Frequency (MHz)	Level (dBμV/m)	Over Limit (dB)	Limit Line (dBμV/m)	Read Level (dBμV)	Antenna Factor (dB/m)	Cable Loss (dB)	Preamp Factor (dB)	Ant Pos (cm)	Table Pos (deg)	Peak Avg. (P/A)	Pol. (H/V)	
802.11n HT20 CH 01 2412MHz		2390	67.84	-6.16	74	58.31	26.87	6.32	33.59	358	355	P	H	
		2389.905	53.3	-0.7	54	43.77	26.87	6.32	33.59	358	355	A	H	
	*	2412	107.93	-	-	98.3	26.92	6.37	33.59	358	355	P	H	
	*	2412	99.66	-	-	90.03	26.92	6.37	33.59	358	355	A	H	
													H	
														H
			2389.695	67.96	-6.04	74	58.44	26.87	6.32	33.6	348	102	P	V
			2390	52.21	-1.79	54	42.68	26.87	6.32	33.59	348	102	A	V
		*	2412	106.78	-	-	97.15	26.92	6.37	33.59	348	102	P	V
		*	2412	97.74	-	-	88.11	26.92	6.37	33.59	348	102	A	V
													V	
													V	
802.11n HT20 CH 06 2437MHz		2385.18	52.35	-21.65	74	42.89	26.81	6.32	33.6	339	360	P	H	
		2389.8	42.63	-11.37	54	33.1	26.87	6.32	33.59	339	360	A	H	
	*	2437	108.26	-	-	98.52	27.03	6.37	33.59	339	360	P	H	
	*	2437	99.32	-	-	89.58	27.03	6.37	33.59	339	360	A	H	
			2496.22	51.81	-22.19	74	41.86	27.2	6.39	33.57	339	360	P	H
			2483.55	42.81	-11.19	54	32.93	27.14	6.39	33.58	339	360	A	H
			2348.64	52.06	-21.94	74	42.8	26.7	6.23	33.6	344	89	P	V
			2389.66	42.57	-11.43	54	33.05	26.87	6.32	33.6	344	89	A	V
		*	2437	107.16	-	-	97.42	27.03	6.37	33.59	344	89	P	V
		*	2437	98.75	-	-	89.01	27.03	6.37	33.59	344	89	A	V
		2483.69	52.76	-21.24	74	42.88	27.14	6.39	33.58	344	89	P	V	
		2483.62	42.41	-11.59	54	32.53	27.14	6.39	33.58	344	89	A	V	



802.11n HT20 CH 11 2462MHz	*	2462	107.35	-	-	97.53	27.09	6.38	33.58	342	357	P	H
	*	2462	98.99	-	-	89.17	27.09	6.38	33.58	342	357	A	H
		2483.64	67	-7	74	57.12	27.14	6.39	33.58	342	357	P	H
		2483.52	53.7	-0.3	54	43.82	27.14	6.39	33.58	342	357	A	H
													H
													H
	*	2462	104.56	-	-	94.74	27.09	6.38	33.58	336	102	P	V
	*	2462	96.31	-	-	86.49	27.09	6.38	33.58	336	102	A	V
		2483.56	65.27	-8.73	74	55.39	27.14	6.39	33.58	336	102	P	V
		2483.56	51.05	-2.95	54	41.17	27.14	6.39	33.58	336	102	A	V
													V
												V	
Remark	1. No other spurious found. 2. All results are PASS against Peak and Average limit line.												



**2.4GHz 2400~2483.5MHz
WIFI 802.11n HT20 (Harmonic @ 3m)**

WIFI Ant. 1+2	Note	Frequency (MHz)	Level (dBμV/m)	Over Limit (dB)	Limit Line (dBμV/m)	Read Level (dBμV)	Antenna Factor (dB/m)	Cable Loss (dB)	Preamp Factor (dB)	Ant Pos (cm)	Table Pos (deg)	Peak Avg. (P/A)	Pol. (H/V)
802.11n HT20 CH 01 2412MHz		4824	54.23	-19.77	74	77.03	31.62	9.89	64.74	146	147	P	H
		4824	41.5	-12.5	54	64.3	31.62	9.89	64.74	146	147	A	H
													H
													H
		4824	54.7	-19.3	74	77.93	31.62	9.89	64.74	322	0	P	V
		4824	41.89	-12.11	54	65.12	31.62	9.89	64.74	322	0	A	V
802.11n HT20 CH 06 2437MHz		4874	50.5	-23.5	74	73.2	31.71	9.86	64.7	100	0	P	H
		7311	49.82	-24.18	74	65.1	37.43	11.65	64.82	100	0	P	H
													H
													H
		4874	53.35	-20.65	74	76.48	31.71	9.86	64.7	304	23	P	V
		4874	43.08	-10.92	54	66.21	31.71	9.86	64.7	304	23	A	V
		7311	47.08	-26.92	74	62.82	37.43	11.65	64.82	100	0	P	V
802.11n HT20 CH 11 2462MHz		4924	47.3	-26.7	74	69.9	31.79	9.83	64.66	100	0	P	H
		7386	50.84	-23.16	74	65.87	37.82	11.63	64.86	100	0	P	H
													H
													H
		4924	49.66	-24.34	74	72.7	31.79	9.83	64.66	100	0	P	V
		7386	46.86	-27.14	74	62.27	37.82	11.63	64.86	100	0	P	V
Remark	1. No other spurious found.												
	2. All results are PASS against Peak and Average limit line.												



**2.4GHz 2400~2483.5MHz
WIFI 802.11ac VHT20 (Band Edge @ 3m)**

WIFI Ant. 1+2	Note	Frequency (MHz)	Level (dBμV/m)	Over Limit (dB)	Limit Line (dBμV/m)	Read Level (dBμV)	Antenna Factor (dB/m)	Cable Loss (dB)	Preamp Factor (dB)	Ant Pos (cm)	Table Pos (deg)	Peak Avg. (P/A)	Pol. (H/V)	
802.11ac VHT20 CH 01 2412MHz		2389.905	67.03	-6.97	74	57.5	26.87	6.32	33.59	357	352	P	H	
		2390	53.23	-0.77	54	43.7	26.87	6.32	33.59	357	352	A	H	
	*	2412	108.01	-	-	98.38	26.92	6.37	33.59	357	352	P	H	
	*	2412	99.73	-	-	90.1	26.92	6.37	33.59	357	352	A	H	
													H	
														H
			2389.695	67.57	-6.43	74	58.05	26.87	6.32	33.6	347	104	P	V
			2390	51.61	-2.39	54	42.08	26.87	6.32	33.59	347	104	A	V
		*	2412	106.18	-	-	96.55	26.92	6.37	33.59	347	104	P	V
		*	2412	97.77	-	-	88.14	26.92	6.37	33.59	347	104	A	V
													V	
													V	
802.11ac VHT20 CH 06 2437MHz		2389.24	53.14	-20.86	74	43.62	26.87	6.32	33.6	345	354	P	H	
		2389.94	43.3	-10.7	54	33.77	26.87	6.32	33.59	345	354	A	H	
	*	2437	109.61	-	-	99.87	27.03	6.37	33.59	345	354	P	H	
	*	2437	101.19	-	-	91.45	27.03	6.37	33.59	345	354	A	H	
			2483.69	53.17	-20.83	74	43.29	27.14	6.39	33.58	345	354	P	H
			2483.52	43.39	-10.61	54	33.51	27.14	6.39	33.58	345	354	A	H
			2333.38	52.42	-21.58	74	43.27	26.65	6.18	33.61	334	103	P	V
			2389.8	42.9	-11.1	54	33.37	26.87	6.32	33.59	334	103	A	V
		*	2437	108.51	-	-	98.77	27.03	6.37	33.59	334	103	P	V
		*	2437	99.89	-	-	90.15	27.03	6.37	33.59	334	103	A	V
		2484.95	51.92	-22.08	74	42.04	27.14	6.39	33.58	334	103	P	V	
		2483.52	43.26	-10.74	54	33.38	27.14	6.39	33.58	334	103	A	V	



802.11ac VHT20 CH 11 2462MHz	*	2462	106.82	-	-	97	27.09	6.38	33.58	342	354	P	H
	*	2462	98.19	-	-	88.37	27.09	6.38	33.58	342	354	A	H
		2483.72	66.38	-7.62	74	56.5	27.14	6.39	33.58	342	354	P	H
		2483.56	53.11	-0.89	54	43.23	27.14	6.39	33.58	342	354	A	H
													H
													H
	*	2462	104.61	-	-	94.79	27.09	6.38	33.58	363	103	P	V
	*	2462	96.38	-	-	86.56	27.09	6.38	33.58	363	103	A	V
		2483.72	61.97	-12.03	74	52.09	27.14	6.39	33.58	363	103	P	V
		2483.52	49.35	-4.65	54	39.47	27.14	6.39	33.58	363	103	A	V
													V
												V	
Remark	1. No other spurious found. 2. All results are PASS against Peak and Average limit line.												



**2.4GHz 2400~2483.5MHz
WIFI 802.11ac VHT20 (Harmonic @ 3m)**

WIFI Ant. 1+2	Note	Frequency (MHz)	Level (dBμV/m)	Over Limit (dB)	Limit Line (dBμV/m)	Read Level (dBμV)	Antenna Factor (dB/m)	Cable Loss (dB)	Preamp Factor (dB)	Ant Pos (cm)	Table Pos (deg)	Peak Avg. (P/A)	Pol. (H/V)
802.11ac VHT20 CH 01 2412MHz		4824	54.71	-19.29	74	77.51	31.62	9.89	64.74	151	149	P	H
		4824	42.43	-11.57	54	65.23	31.62	9.89	64.74	151	149	A	H
													H
													H
		4824	54.1	-19.9	74	77.33	31.62	9.89	64.74	321	0	P	V
		4824	41.79	-12.21	54	65.02	31.62	9.89	64.74	321	0	A	V
802.11ac VHT20 CH 06 2437MHz		4874	54.98	-19.02	74	77.68	31.71	9.86	64.7	134	150	P	H
		4874	43.65	-10.35	54	66.35	31.71	9.86	64.7	134	150	A	H
		7311	50.74	-23.26	74	66.02	37.43	11.65	64.82	100	0	P	H
													H
		4874	53.6	-20.4	74	76.73	31.71	9.86	64.7	285	11	P	V
		4874	42.08	-11.92	54	65.21	31.71	9.86	64.7	285	11	A	V
		7311	47.94	-26.06	74	63.68	37.43	11.65	64.82	100	0	P	V
802.11ac VHT20 CH 11 2462MHz		4924	44.89	-29.11	74	67.49	31.79	9.83	64.66	100	0	P	H
		7386	48.8	-25.2	74	63.83	37.82	11.63	64.86	100	0	P	H
													H
													H
		4924	47.54	-26.46	74	70.58	31.79	9.83	64.66	100	0	P	V
		7386	44.59	-29.41	74	60	37.82	11.63	64.86	100	0	P	V
Remark	1. No other spurious found.												
	2. All results are PASS against Peak and Average limit line.												



Emission below 1GHz

2.4GHz WIFI 802.11n HT20 (LF)

WIFI	Note	Frequency	Level	Over	Limit	Read	Antenna	Cable	Preamp	Ant	Table	Peak	Pol.	
Ant.				Limit	Line	Level	Factor	Loss	Factor	Pos	Pos	Avg.		
1+2		(MHz)	(dBμV/m)	(dB)	(dBμV/m)	(dBμV)	(dB/m)	(dB)	(dB)	(cm)	(deg)	(P/A)	(H/V)	
2.4GHz 802.11n HT20 LF		173.64	25.31	-18.19	43.5	40.69	15.25	1.69	32.41			P	H	
		223.86	29.11	-16.89	46	43.96	15.6	1.88	32.39			P	H	
		267.6	30.95	-15.05	46	41.82	19.39	2.04	32.38			P	H	
		459.6	33.4	-12.6	46	39.59	23.38	2.75	32.36	125	247	P	H	
		896.4	32.03	-13.97	46	30.6	29.16	3.79	31.68			P	H	
		954.5	33.17	-12.83	46	29.36	30.98	3.82	31.16			P	H	
														H
														H
														H
														H
														H
														H
			43.23	34.55	-5.45	40	48.91	17.19	0.94	32.49	231	311	P	V
			67.8	25.72	-14.28	40	45.01	12.12	1.06	32.49			P	V
			195.78	29.35	-14.15	43.5	45.09	14.86	1.72	32.39			P	V
			461	36.05	-9.95	46	42.22	23.4	2.75	32.36			P	V
			559	32.04	-13.96	46	35.22	26.18	2.98	32.43			P	V
			931.4	33.62	-12.38	46	31	30.01	3.81	31.37			P	V
														V
														V
													V	
													V	
													V	
													V	
Remark	1. No other spurious found. 2. All results are PASS against limit line.													



Note symbol

*	Fundamental Frequency which can be ignored. However, the level of any unwanted emissions shall not exceed the level of the fundamental frequency.
!	Test result is over limit line.
P/A	P eak or A verage
H/V	H orizontal or V ertical



A calculation example for radiated spurious emission is shown as below:

WIFI	Note	Frequency	Level	Over	Limit	Read	Antenna	Cable	Preamp	Ant	Table	Peak	Pol.
Ant.				Limit	Line	Level	Factor	Loss	Factor	Pos	Pos	Avg.	
1+2		(MHz)	(dBμV/m)	(dB)	(dBμV/m)	(dBμV)	(dB/m)	(dB)	(dB)	(cm)	(deg)	(P/A)	(H/V)
802.11b		2390	55.45	-18.55	74	54.51	32.22	4.58	35.86	103	308	P	H
CH 01													
2412MHz		2390	43.54	-10.46	54	42.6	32.22	4.58	35.86	103	308	A	H

- Level(dBμV/m) =
Antenna Factor(dB/m) + Cable Loss(dB) + Read Level(dBμV) - Preamp Factor(dB)
- Over Limit(dB) = Level(dBμV/m) – Limit Line(dBμV/m)

For Peak Limit @ 2390MHz:

- Level(dBμV/m)
= Antenna Factor(dB/m) + Cable Loss(dB) + Read Level(dBμV) - Preamp Factor(dB)
= 32.22(dB/m) + 4.58(dB) + 54.51(dBμV) – 35.86 (dB)
= 55.45 (dBμV/m)
- Over Limit(dB)
= Level(dBμV/m) – Limit Line(dBμV/m)
= 55.45(dBμV/m) – 74(dBμV/m)
= -18.55(dB)

For Average Limit @ 2390MHz:

- Level(dBμV/m)
= Antenna Factor(dB/m) + Cable Loss(dB) + Read Level(dBμV) - Preamp Factor(dB)
= 32.22(dB/m) + 4.58(dB) + 42.6(dBμV) – 35.86 (dB)
= 43.54 (dBμV/m)
- Over Limit(dB)
= Level(dBμV/m) – Limit Line(dBμV/m)
= 43.54(dBμV/m) – 54(dBμV/m)
= -10.46(dB)

Both peak and average measured complies with the limit line, so test result is “PASS”.



Appendix C. Radiated Spurious Emission Plots

Test Engineer :	J.C. Liang, Jacky Hung, and Kan Wu	Temperature :	18~22°C
		Relative Humidity :	55~58%

Note symbol

-L	Low channel location
-R	High channel location



2.4GHz 2400~2483.5MHz
WIFI 802.11b (Band Edge @ 3m)

Table with 4 quadrants: Peak Horizontal, Peak Fundamental, Avg. Horizontal, Avg. Fundamental. Each quadrant contains a spectral plot and test conditions.



WIFI	2.4GHz 2400~2483.5MHz Band Edge @ 3m	
ANT	802.11b CH01 2412MHz	
1+2	Vertical	Fundamental
Peak	<p>Site : 03CH11-HY Condition : PEAK_BE_74 3m HORN 91200-HF VERTICAL : RBW:1000.000KHz VBW:3000.000KHz SWT:Auto</p>	<p>Site : 03CH11-HY Condition : PEAK_74 3m HORN 91200-HF VERTICAL : RBW:1000.000KHz VBW:3000.000KHz SWT:Auto</p>
Avg.	<p>Site : 03CH11-HY Condition : AVG_BE_54 3m HORN 91200-HF VERTICAL : RBW:1000.000KHz VBW:0.010KHz SWT:Auto</p>	<p>Site : 03CH11-HY Condition : AVG_54 3m HORN 91200-HF VERTICAL : RBW:1000.000KHz VBW:0.010KHz SWT:Auto</p>



WIFI	2.4GHz 2400~2483.5MHz Band Edge @ 3m	
ANT	802.11b CH06 2437MHz - L	
1+2	Horizontal	Fundamental
Peak	<p>Site : 03CH11-HY Condition : PEAK_BE_74 3m HORN 91200-HF HORIZONTAL : RBW:1000.000KHz VBW:3000.000KHz SWT:Auto</p>	<p>Site : 03CH11-HY Condition : PEAK_74 3m HORN 91200-HF HORIZONTAL : RBW:1000.000KHz VBW:3000.000KHz SWT:Auto</p>
Avg.	<p>Site : 03CH11-HY Condition : AVG_BE_54 3m HORN 91200-HF HORIZONTAL : RBW:1000.000KHz VBW:0.010KHz SWT:Auto</p>	<p>Site : 03CH11-HY Condition : AVG_54 3m HORN 91200-HF HORIZONTAL : RBW:1000.000KHz VBW:0.010KHz SWT:Auto</p>

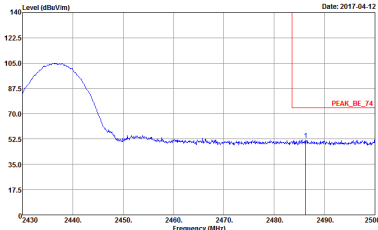
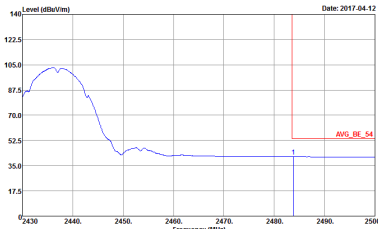

WIFI	2.4GHz 2400~2483.5MHz Band Edge @ 3m	
ANT	802.11b CH06 2437MHz - R	
1+2	Horizontal	Fundamental
Peak	 <p>Site : 03CH11-HY Condition : PEAK_BE_74 3m HORN 91200-HF HORIZONTAL : RBW:1000.000KHz VBW:3000.000KHz SWT:Auto</p>	Left blank
Avg.	 <p>Site : 03CH11-HY Condition : AVG_BE_54 3m HORN 91200-HF HORIZONTAL : RBW:1000.000KHz VBW:0.010KHz SWT:Auto</p>	Left blank



WIFI	2.4GHz 2400~2483.5MHz Band Edge @ 3m	
ANT	802.11b CH06 2437MHz - L	
1+2	Vertical	Fundamental
Peak	<p>Site : 03CH11-HY Condition : PEAK_BE_74 3m HORN 91200-HF VERTICAL : RBW:1000.000KHz VBW:3000.000KHz SWT:Auto</p>	<p>Site : 03CH11-HY Condition : PEAK_74 3m HORN 91200-HF VERTICAL : RBW:1000.000KHz VBW:3000.000KHz SWT:Auto</p>
Avg.	<p>Site : 03CH11-HY Condition : AVG_BE_54 3m HORN 91200-HF VERTICAL : RBW:1000.000KHz VBW:0.010KHz SWT:Auto</p>	<p>Site : 03CH11-HY Condition : AVG_54 3m HORN 91200-HF VERTICAL : RBW:1000.000KHz VBW:0.010KHz SWT:Auto</p>

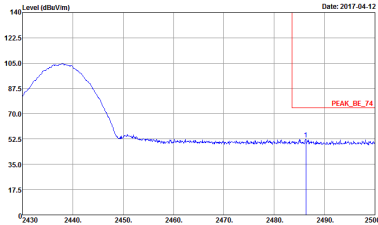
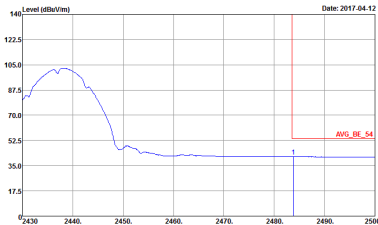

WIFI	2.4GHz 2400~2483.5MHz Band Edge @ 3m	
ANT	802.11b CH06 2437MHz - R	
1+2	Vertical	Fundamental
<p>Peak</p>	 <p>Site : 03CH11-HY Condition : PEAK_BE_74 3m HORN 91200-HF VERTICAL : RBW:1000.000KHz VBW:3000.000KHz SWT:Auto</p>	<p>Left blank</p>
<p>Avg.</p>	 <p>Site : 03CH11-HY Condition : AVG_BE_54 3m HORN 91200-HF VERTICAL : RBW:1000.000KHz VBW:0.010KHz SWT:Auto</p>	<p>Left blank</p>



WIFI	2.4GHz 2400~2483.5MHz Band Edge @ 3m	
ANT	802.11b CH11 2462MHz	
1+2	Horizontal	Fundamental
Peak	<p>Site : 03CH11-HY Condition : PEAK_BE_74 3m HORN 91200-HF HORIZONTAL : RBW:1000.000KHz VBW:3000.000KHz SWT:Auto</p>	<p>Site : 03CH11-HY Condition : PEAK_74 3m HORN 91200-HF HORIZONTAL : RBW:1000.000KHz VBW:3000.000KHz SWT:Auto</p>
Avg.	<p>Site : 03CH11-HY Condition : AVG_BE_54 3m HORN 91200-HF HORIZONTAL : RBW:1000.000KHz VBW:0.010KHz SWT:Auto</p>	<p>Site : 03CH11-HY Condition : AVG_54 3m HORN 91200-HF HORIZONTAL : RBW:1000.000KHz VBW:0.010KHz SWT:Auto</p>



WIFI	2.4GHz 2400~2483.5MHz Band Edge @ 3m	
ANT	802.11b CH11 2462MHz	
1+2	Vertical	Fundamental
Peak	<p>Site : 03CH11-HY Condition : PEAK_BE_74 3m HORN 91200-HF VERTICAL : RBW:1000.000KHz VBW:3000.000KHz SWT:Auto</p>	<p>Site : 03CH11-HY Condition : PEAK_74 3m HORN 91200-HF VERTICAL : RBW:1000.000KHz VBW:3000.000KHz SWT:Auto</p>
Avg.	<p>Site : 03CH11-HY Condition : AVG_BE_54 3m HORN 91200-HF VERTICAL : RBW:1000.000KHz VBW:0.010KHz SWT:Auto</p>	<p>Site : 03CH11-HY Condition : AVG_54 3m HORN 91200-HF VERTICAL : RBW:1000.000KHz VBW:0.010KHz SWT:Auto</p>

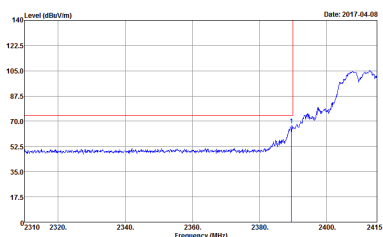
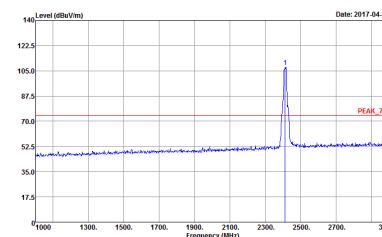
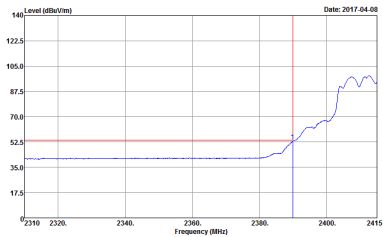
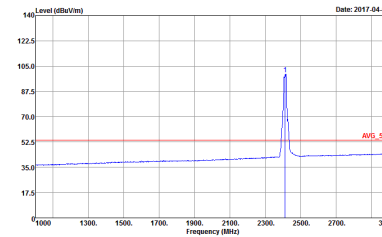

2.4GHz 2400~2483.5MHz
WIFI 802.11g (Band Edge @ 3m)

WIFI	2.4GHz 2400~2483.5MHz Band Edge @ 3m	
ANT	802.11g CH01 2412MHz	
1+2	Horizontal	Fundamental
Peak	 <p>Site : 03CH11-HY Condition : PEAK_BE_74 3m HORN 91200-HF HORIZONTAL : RBW:1000.000KHz VBW:3000.000KHz SWT:Auto</p>	 <p>Site : 03CH11-HY Condition : PEAK_74 3m HORN 91200-HF HORIZONTAL : RBW:1000.000KHz VBW:3000.000KHz SWT:Auto</p>
Avg.	 <p>Site : 03CH11-HY Condition : AVG_BE_54 3m HORN 91200-HF HORIZONTAL : RBW:1000.000KHz VBW:1000KHz SWT:Auto</p>	 <p>Site : 03CH11-HY Condition : AVG_54 3m HORN 91200-HF HORIZONTAL : RBW:1000.000KHz VBW:1000KHz SWT:Auto</p>



WIFI	2.4GHz 2400~2483.5MHz Band Edge @ 3m	
ANT	802.11g CH01 2412MHz	
1+2	Vertical	Fundamental
Peak	<p>Site : 03CH11-HY Condition : PEAK_BE_74 3m HORN 91200-HF VERTICAL : RBW:1000.000KHz VBW:3000.000KHz SWT:Auto</p>	<p>Site : 03CH11-HY Condition : PEAK_74 3m HORN 91200-HF VERTICAL : RBW:1000.000KHz VBW:3000.000KHz SWT:Auto</p>
Avg.	<p>Site : 03CH11-HY Condition : AVG_BE_54 3m HORN 91200-HF VERTICAL : RBW:1000.000KHz VBW:1.000KHz SWT:Auto</p>	<p>Site : 03CH11-HY Condition : AVG_54 3m HORN 91200-HF VERTICAL : RBW:1000.000KHz VBW:1.000KHz SWT:Auto</p>



WIFI	2.4GHz 2400~2483.5MHz Band Edge @ 3m	
ANT	802.11g CH06 2437MHz - L	
1+2	Horizontal	Fundamental
Peak	<p>Site : 03CH11-HY Condition : PEAK_BE_74 3m HORN 91200-HF HORIZONTAL : RBW:1000.000KHz VBW:3000.000KHz SWT:Auto</p>	<p>Site : 03CH11-HY Condition : PEAK_74 3m HORN 91200-HF HORIZONTAL : RBW:1000.000KHz VBW:3000.000KHz SWT:Auto</p>
Avg.	<p>Site : 03CH11-HY Condition : AVG_BE_54 3m HORN 91200-HF HORIZONTAL : RBW:1000.000KHz VBW:1.000KHz SWT:Auto</p>	<p>Site : 03CH11-HY Condition : AVG_54 3m HORN 91200-HF HORIZONTAL : RBW:1000.000KHz VBW:1.000KHz SWT:Auto</p>



WIFI	2.4GHz 2400~2483.5MHz Band Edge @ 3m	
ANT	802.11g CH06 2437MHz - R	
1+2	Horizontal	Fundamental
Peak	<p>Site : 03CH11-HY Condition : PEAK_BE_74 3m HORN 91200-HF HORIZONTAL : RBW:1000.000KHz VBW:3000.000KHz SWT:Auto</p>	Left blank
Avg.	<p>Site : 03CH11-HY Condition : AVG_BE_54 3m HORN 91200-HF HORIZONTAL : RBW:1000.000KHz VBW:1.000KHz SWT:Auto</p>	Left blank



WIFI	2.4GHz 2400~2483.5MHz Band Edge @ 3m	
ANT	802.11g CH06 2437MHz - L	
1+2	Vertical	Fundamental
Peak	<p>Site : 03CH11-HY Condition : PEAK_BE_74 3m HORN 91200-HF VERTICAL : RBW:1000.000KHz VBW:3000.000KHz SWT:Auto</p>	<p>Site : 03CH11-HY Condition : PEAK_74 3m HORN 91200-HF VERTICAL : RBW:1000.000KHz VBW:3000.000KHz SWT:Auto</p>
Avg.	<p>Site : 03CH11-HY Condition : AVG_BE_54 3m HORN 91200-HF VERTICAL : RBW:1000.000KHz VBW:1.000KHz SWT:Auto</p>	<p>Site : 03CH11-HY Condition : AVG_54 3m HORN 91200-HF VERTICAL : RBW:1000.000KHz VBW:1.000KHz SWT:Auto</p>

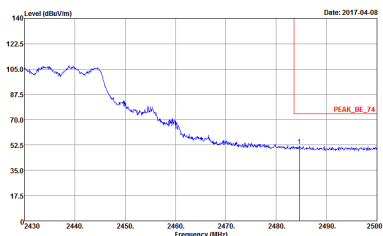
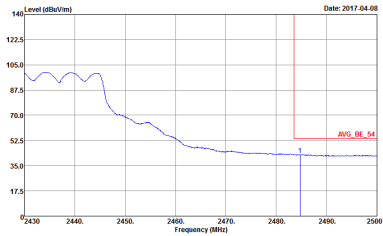

WIFI	2.4GHz 2400~2483.5MHz Band Edge @ 3m	
ANT	802.11g CH06 2437MHz - R	
1+2	Vertical	Fundamental
<p>Peak</p>	 <p>Site : 03CH11-HY Condition : PEAK_BE_74 3m HORN 91200-HF VERTICAL : RBW:1000.000KHz VBW:3000.000KHz SWT:Auto</p>	<p>Left Blank</p>
<p>Avg.</p>	 <p>Site : 03CH11-HY Condition : AVG_BE_54 3m HORN 91200-HF VERTICAL : RBW:1000.000KHz VBW:1.000KHz SWT:Auto</p>	<p>Left Blank</p>



WIFI	2.4GHz 2400~2483.5MHz Band Edge @ 3m	
ANT	802.11g CH11 2462MHz	
1+2	Horizontal	Fundamental
Peak	<p>Site : 03CH11-HY Condition : PEAK_BE_74 3m HORN 91200-HF HORIZONTAL : RBW:1000.000KHz VBW:3000.000KHz SWT:Auto</p>	<p>Site : 03CH11-HY Condition : PEAK_74 3m HORN 91200-HF HORIZONTAL : RBW:1000.000KHz VBW:3000.000KHz SWT:Auto</p>
Avg.	<p>Site : 03CH11-HY Condition : AVG_BE_54 3m HORN 91200-HF HORIZONTAL : RBW:1000.000KHz VBW:1.000KHz SWT:Auto</p>	<p>Site : 03CH11-HY Condition : AVG_54 3m HORN 91200-HF HORIZONTAL : RBW:1000.000KHz VBW:1.000KHz SWT:Auto</p>



WIFI	2.4GHz 2400~2483.5MHz Band Edge @ 3m	
ANT	802.11g CH11 2462MHz	
1+2	Vertical	Fundamental
Peak	<p>Site : 03CH11-HY Condition : PEAK_BE_74 3m HORN 91200-HF VERTICAL : RBW:1000.000KHz VBW:3000.000KHz SWT:Auto</p>	<p>Site : 03CH11-HY Condition : PEAK_74 3m HORN 91200-HF VERTICAL : RBW:1000.000KHz VBW:3000.000KHz SWT:Auto</p>
Avg.	<p>Site : 03CH11-HY Condition : AVG_BE_54 3m HORN 91200-HF VERTICAL : RBW:1000.000KHz VBW:1.000KHz SWT:Auto</p>	<p>Site : 03CH11-HY Condition : AVG_54 3m HORN 91200-HF VERTICAL : RBW:1000.000KHz VBW:1.000KHz SWT:Auto</p>

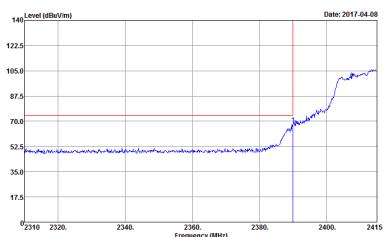
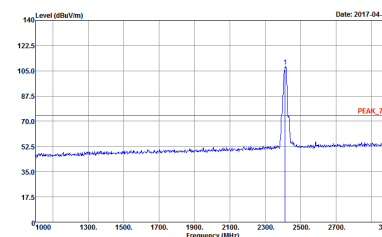
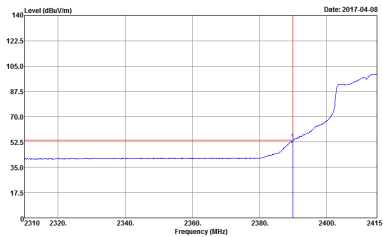
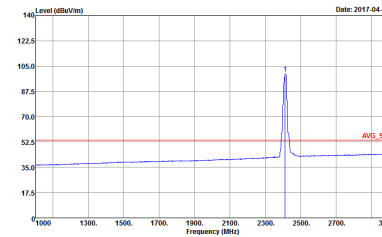

2.4GHz 2400~2483.5MHz
 WIFI 802.11n HT20 (Band Edge @ 3m)

WIFI	2.4GHz 2400~2483.5MHz Band Edge @ 3m	
ANT	802.11n HT20 CH01 2412MHz	
1+2	Horizontal	Fundamental
Peak	 <p>Site : 03CH11-HY Condition : PEAK_BE_74 3m HORN 91200-HF HORIZONTAL : RBW:1000.000KHz VBW:3000.000KHz SWT:Auto</p>	 <p>Site : 03CH11-HY Condition : PEAK_74 3m HORN 91200-HF HORIZONTAL : RBW:1000.000KHz VBW:3000.000KHz SWT:Auto</p>
Avg.	 <p>Site : 03CH11-HY Condition : AVG_BE_54 3m HORN 91200-HF HORIZONTAL : RBW:1000.000KHz VBW:1000KHz SWT:Auto</p>	 <p>Site : 03CH11-HY Condition : AVG_54 3m HORN 91200-HF HORIZONTAL : RBW:1000.000KHz VBW:1000KHz SWT:Auto</p>



WIFI	2.4GHz 2400~2483.5MHz Band Edge @ 3m	
ANT	802.11n HT20 CH01 2412MHz	
1+2	Vertical	Fundamental
Peak	<p>Site : 03CH11-HY Condition : PEAK_BE_74 3m HORN 91200-HF VERTICAL : RBW:1000.000KHz VBW:3000.000KHz SWT:Auto</p>	<p>Site : 03CH11-HY Condition : PEAK_74 3m HORN 91200-HF VERTICAL : RBW:1000.000KHz VBW:3000.000KHz SWT:Auto</p>
Avg.	<p>Site : 03CH11-HY Condition : AVG_BE_54 3m HORN 91200-HF VERTICAL : RBW:1000.000KHz VBW:1.000KHz SWT:Auto</p>	<p>Site : 03CH11-HY Condition : AVG_54 3m HORN 91200-HF VERTICAL : RBW:1000.000KHz VBW:1.000KHz SWT:Auto</p>

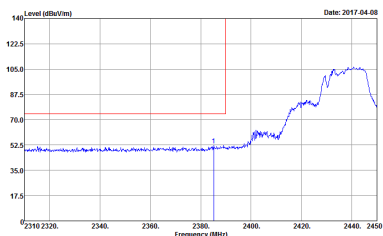
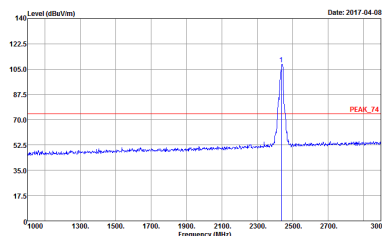
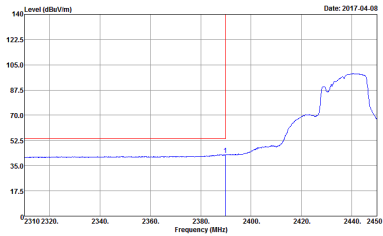
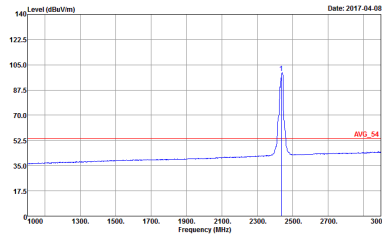

WIFI	2.4GHz 2400~2483.5MHz Band Edge @ 3m	
ANT	802.11n HT20 CH06 2437MHz - L	
1+2	Horizontal	Fundamental
Peak	 <p>Site : 03CH11-HY Condition : PEAK_BE_74 3m HORN 91200-HF HORIZONTAL : RBW:1000.000KHz VBW:3000.000KHz SWT:Auto</p>	 <p>Site : 03CH11-HY Condition : PEAK_74 3m HORN 91200-HF HORIZONTAL : RBW:1000.000KHz VBW:3000.000KHz SWT:Auto</p>
Avg.	 <p>Site : 03CH11-HY Condition : AVG_BE_54 3m HORN 91200-HF HORIZONTAL : RBW:1000.000KHz VBW:1.000KHz SWT:Auto</p>	 <p>Site : 03CH11-HY Condition : AVG_54 3m HORN 91200-HF HORIZONTAL : RBW:1000.000KHz VBW:1.000KHz SWT:Auto</p>

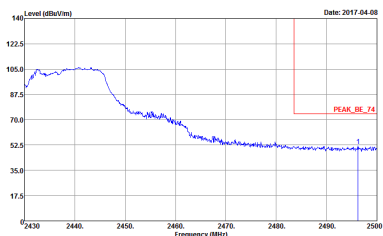
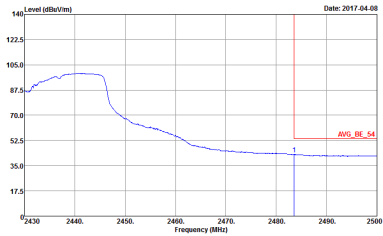

WIFI	2.4GHz 2400~2483.5MHz Band Edge @ 3m	
ANT	802.11n HT20 CH06 2437MHz - R	
1+2	Horizontal	Fundamental
<p>Peak</p>	 <p>Site : 03CHI1-HY Condition : PEAK_BE_74 3m HORN 91200-HF HORIZONTAL : RBW:1000.000KHz VBW:3000.000KHz SWT:Auto</p>	<p>Left blank</p>
<p>Avg.</p>	 <p>Site : 03CHI1-HY Condition : AVG_BE_54 3m HORN 91200-HF HORIZONTAL : RBW:1000.000KHz VBW:1.000KHz SWT:Auto</p>	<p>Left blank</p>

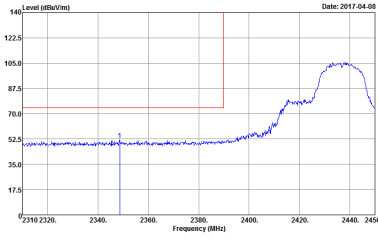
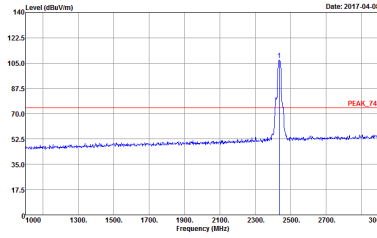
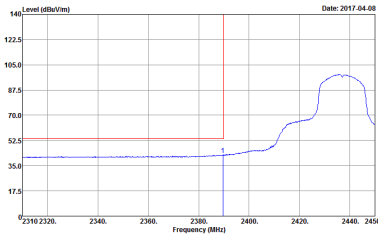
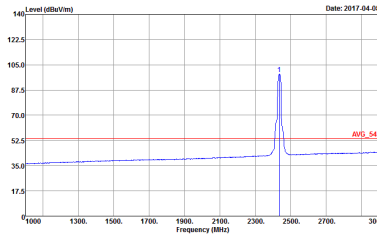

WIFI	2.4GHz 2400~2483.5MHz Band Edge @ 3m	
ANT	802.11n HT20 CH06 2437MHz - L	
1+2	Vertical	Fundamental
Peak	 <p>Site : 03CH11-HY Condition : PEAK_BE_74 3m HORN 91200-HF VERTICAL : RBW:1000.000KHz VBW:3000.000KHz SWT:Auto</p>	 <p>Site : 03CH11-HY Condition : PEAK_74 3m HORN 91200-HF VERTICAL : RBW:1000.000KHz VBW:3000.000KHz SWT:Auto</p>
Avg.	 <p>Site : 03CH11-HY Condition : AVG_BE_54 3m HORN 91200-HF VERTICAL : RBW:1000.000KHz VBW:1.000KHz SWT:Auto</p>	 <p>Site : 03CH11-HY Condition : AVG_54 3m HORN 91200-HF VERTICAL : RBW:1000.000KHz VBW:1.000KHz SWT:Auto</p>

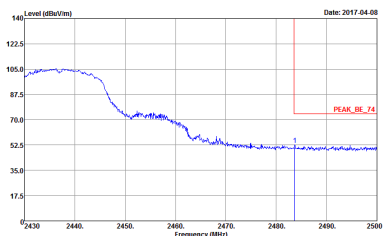
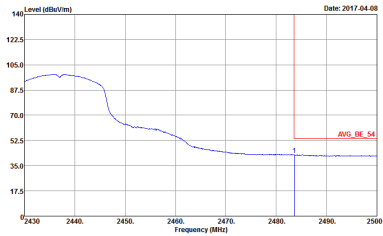

WIFI	2.4GHz 2400~2483.5MHz Band Edge @ 3m	
ANT	802.11n HT20 CH06 2437MHz - R	
1+2	Vertical	Fundamental
<p>Peak</p>	 <p>Site : 03CHI1-HY Condition : PEAK_BE_74 3m HORN 91200-HF VERTICAL : RBW:1000.000KHz VBW:3000.000KHz SWT:Auto</p>	<p>Left Blank</p>
<p>Avg.</p>	 <p>Site : 03CHI1-HY Condition : AVG_BE_54 3m HORN 91200-HF VERTICAL : RBW:1000.000KHz VBW:1.000KHz SWT:Auto</p>	<p>Left Blank</p>



WIFI	2.4GHz 2400~2483.5MHz Band Edge @ 3m	
ANT	802.11n HT20 CH11 2462MHz	
1+2	Horizontal	Fundamental
Peak	<p>Site : 03CH11-HY Condition : PEAK_BE_74 3m HORN 91200-HF HORIZONTAL : RBW:1000.000KHz VBW:3000.000KHz SWT:Auto</p>	<p>Site : 03CH11-HY Condition : PEAK_74 3m HORN 91200-HF HORIZONTAL : RBW:1000.000KHz VBW:3000.000KHz SWT:Auto</p>
Avg.	<p>Site : 03CH11-HY Condition : AVG_BE_54 3m HORN 91200-HF HORIZONTAL : RBW:1000.000KHz VBW:1.000KHz SWT:Auto</p>	<p>Site : 03CH11-HY Condition : AVG_54 3m HORN 91200-HF HORIZONTAL : RBW:1000.000KHz VBW:1.000KHz SWT:Auto</p>



WIFI	2.4GHz 2400~2483.5MHz Fundamental @ 3m	
ANT	802.11n HT20 CH11 2462MHz	
1+2	Vertical	Fundamental
Peak	<p>Site : 03CH11-HY Condition : PEAK_BE_74 3m HORN 91200-HF VERTICAL : RBW:1000.000KHz VBW:3000.000KHz SWT:Auto</p>	<p>Site : 03CH11-HY Condition : PEAK_74 3m HORN 91200-HF VERTICAL : RBW:1000.000KHz VBW:3000.000KHz SWT:Auto</p>
Avg.	<p>Site : 03CH11-HY Condition : AVG_BE_54 3m HORN 91200-HF VERTICAL : RBW:1000.000KHz VBW:1.000KHz SWT:Auto</p>	<p>Site : 03CH11-HY Condition : AVG_54 3m HORN 91200-HF VERTICAL : RBW:1000.000KHz VBW:1.000KHz SWT:Auto</p>

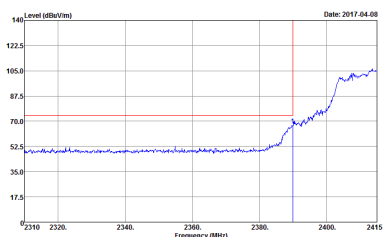
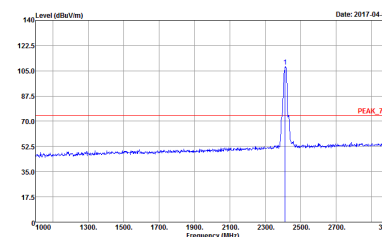
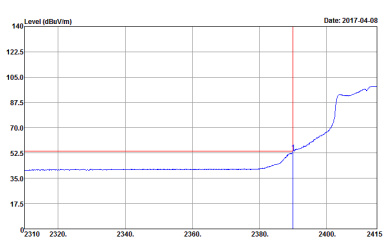
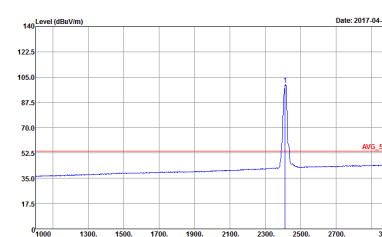

2.4GHz 2400~2483.5MHz
 WIFI 802.11ac VHT20 (Band Edge @ 3m)

WIFI	2.4GHz 2400~2483.5MHz Band Edge @ 3m	
ANT	802.11ac VHT20 CH01 2412MHz	
1+2	Horizontal	Fundamental
Peak	 <p>Site : 03CH11-HY Condition : PEAK_BE_74 3m HORN 9120D-HF HORIZONTAL : RBW:1000.000KHz VBW:3000.000KHz SWT:Auto</p>	 <p>Site : 03CH11-HY Condition : PEAK_74 3m HORN 9120D-HF HORIZONTAL : RBW:1000.000KHz VBW:3000.000KHz SWT:Auto</p>
Avg.	 <p>Site : 03CH11-HY Condition : AVG_BE_54 3m HORN 9120D-HF HORIZONTAL : RBW:1000.000KHz VBW:1000KHz SWT:Auto</p>	 <p>Site : 03CH11-HY Condition : AVG_54 3m HORN 9120D-HF HORIZONTAL : RBW:1000.000KHz VBW:1000KHz SWT:Auto</p>



WIFI	2.4GHz 2400~2483.5MHz Band Edge @ 3m	
ANT	802.11ac VHT20 CH01 2412MHz	
1+2	Vertical	Fundamental
Peak	<p>Site : 03CH11-HY Condition : PEAK_BE_74 3m HORN 91200-HF VERTICAL : RBW:1000.000KHz VBW:3000.000KHz SWT:Auto</p>	<p>Site : 03CH11-HY Condition : PEAK_74 3m HORN 91200-HF VERTICAL : RBW:1000.000KHz VBW:3000.000KHz SWT:Auto</p>
Avg.	<p>Site : 03CH11-HY Condition : AVG_BE_54 3m HORN 91200-HF VERTICAL : RBW:1000.000KHz VBW:1.000KHz SWT:Auto</p>	<p>Site : 03CH11-HY Condition : AVG_54 3m HORN 91200-HF VERTICAL : RBW:1000.000KHz VBW:1.000KHz SWT:Auto</p>



WIFI	2.4GHz 2400~2483.5MHz Band Edge @ 3m	
ANT	802.11ac VHT20 CH06 2437MHz - L	
1+2	Horizontal	Fundamental
Peak	<p>Site : 03CH11-HY Condition : PEAK_BE_74 3m HORN 91200-HF HORIZONTAL : RBW:1000.000KHz VBW:3000.000KHz SWT:Auto</p>	<p>Site : 03CH11-HY Condition : PEAK_74 3m HORN 91200-HF HORIZONTAL : RBW:1000.000KHz VBW:3000.000KHz SWT:Auto</p>
Avg.	<p>Site : 03CH11-HY Condition : AVG_BE_54 3m HORN 91200-HF HORIZONTAL : RBW:1000.000KHz VBW:1.000KHz SWT:Auto</p>	<p>Site : 03CH11-HY Condition : AVG_54 3m HORN 91200-HF HORIZONTAL : RBW:1000.000KHz VBW:1.000KHz SWT:Auto</p>

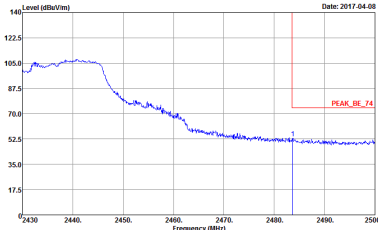
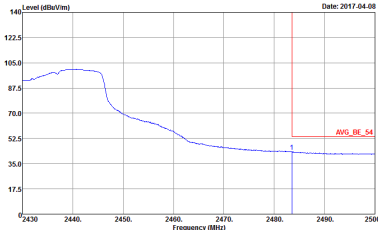

WIFI	2.4GHz 2400~2483.5MHz Band Edge @ 3m	
ANT	802.11ac VH20 CH06 2437MHz - R	
1+2	Horizontal	Fundamental
<p>Peak</p>	 <p>Site : 03CHI1-HY Condition : PEAK_BE_74 3m HORN 91200-HF HORIZONTAL : RBW:1000.000KHz VBW:3000.000KHz SWT:Auto</p>	<p>Left blank</p>
<p>Avg.</p>	 <p>Site : 03CHI1-HY Condition : AVG_BE_54 3m HORN 91200-HF HORIZONTAL : RBW:1000.000KHz VBW:1.000KHz SWT:Auto</p>	<p>Left blank</p>

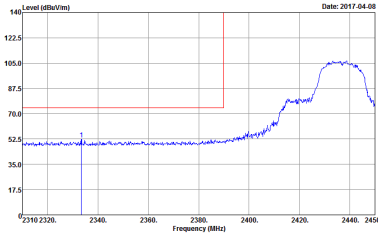
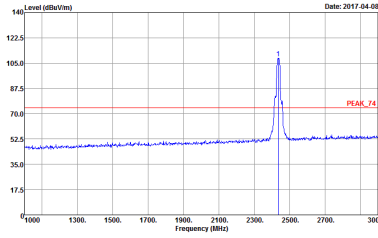
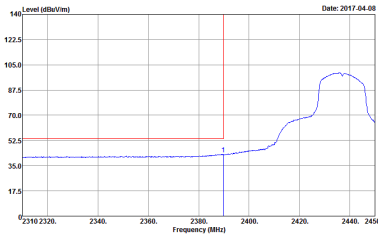
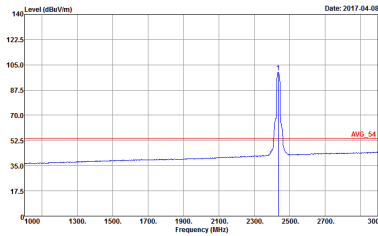

WIFI	2.4GHz 2400~2483.5MHz Band Edge @ 3m	
ANT	802.11ac VH20 CH06 2437MHz - L	
1+2	Vertical	Fundamental
Peak	 <p>Site : 03CH11-HY Condition : PEAK_BE_74 3m HORN 91200-HF VERTICAL : RBW:1000.000KHz VBW:3000.000KHz SWT:Auto</p>	 <p>Site : 03CH11-HY Condition : PEAK_74 3m HORN 91200-HF VERTICAL : RBW:1000.000KHz VBW:3000.000KHz SWT:Auto</p>
Avg.	 <p>Site : 03CH11-HY Condition : AVG_BE_54 3m HORN 91200-HF VERTICAL : RBW:1000.000KHz VBW:1.000KHz SWT:Auto</p>	 <p>Site : 03CH11-HY Condition : AVG_54 3m HORN 91200-HF VERTICAL : RBW:1000.000KHz VBW:1.000KHz SWT:Auto</p>

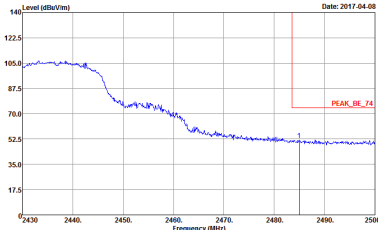
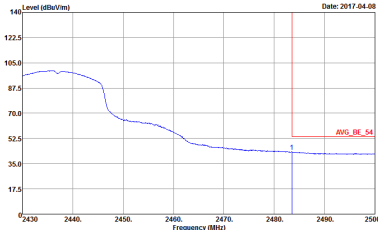

WIFI	2.4GHz 2400~2483.5MHz Band Edge @ 3m	
ANT	802.11ac VH20 CH06 2437MHz - R	
1+2	Vertical	Fundamental
<p>Peak</p>	 <p>Site : 03CHI1-HY Condition : PEAK_BE_74 3m HORN 91200-HF VERTICAL : RBW:1000.000KHz VBW:3000.000KHz SWT:Auto</p>	<p>Left blank</p>
<p>Avg.</p>	 <p>Site : 03CHI1-HY Condition : AVG_BE_54 3m HORN 91200-HF VERTICAL : RBW:1000.000KHz VBW:1.000KHz SWT:Auto</p>	<p>Left blank</p>

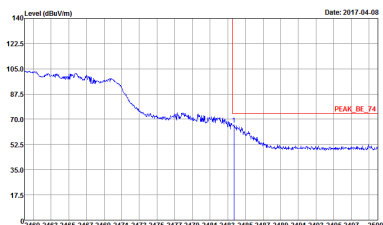
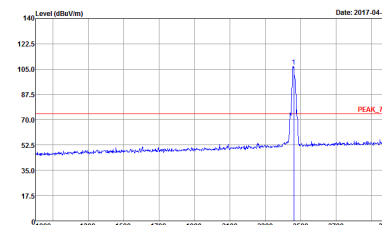
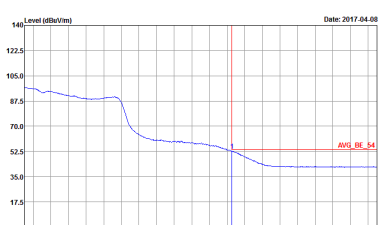
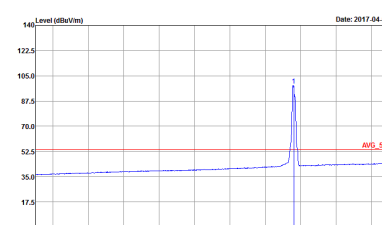

WIFI	2.4GHz 2400~2483.5MHz Band Edge @ 3m	
ANT	802.11ac VH20 CH11 2462MHz	
1+2	Horizontal	Fundamental
Peak	 <p>Site : 03CH11-HY Condition : PEAK_BE_74 3m HORN 91200-HF HORIZONTAL : RBW:1000.000KHz VBW:3000.000KHz SWT:Auto</p>	 <p>Site : 03CH11-HY Condition : PEAK_74 3m HORN 91200-HF HORIZONTAL : RBW:1000.000KHz VBW:3000.000KHz SWT:Auto</p>
Avg.	 <p>Site : 03CH11-HY Condition : AVG_BE_54 3m HORN 91200-HF HORIZONTAL : RBW:1000.000KHz VBW:1.000KHz SWT:Auto</p>	 <p>Site : 03CH11-HY Condition : AVG_54 3m HORN 91200-HF HORIZONTAL : RBW:1000.000KHz VBW:1.000KHz SWT:Auto</p>



WIFI	2.4GHz 2400~2483.5MHz Band Edge @ 3m	
ANT	802.11ac VH20 CH11 2462MHz	
1+2	Vertical	Fundamental
Peak	<p>Site : 03CH11-HY Condition : PEAK_BE_74 3m HORN 91200-HF VERTICAL : RBW:1000.000KHz VBW:3000.000KHz SWT:Auto</p>	<p>Site : 03CH11-HY Condition : PEAK_74 3m HORN 91200-HF VERTICAL : RBW:1000.000KHz VBW:3000.000KHz SWT:Auto</p>
Avg.	<p>Site : 03CH11-HY Condition : AVG_BE_54 3m HORN 91200-HF VERTICAL : RBW:1000.000KHz VBW:1.000KHz SWT:Auto</p>	<p>Site : 03CH11-HY Condition : AVG_54 3m HORN 91200-HF VERTICAL : RBW:1000.000KHz VBW:1.000KHz SWT:Auto</p>



2.4GHz 2400~2483.5MHz
WIFI 802.11b (Harmonic @ 3m)

Table with 2 columns: Horizontal and Vertical. Rows include WIFI, ANT, 1+2, and Peak Avg. Each cell contains a spectral plot of Level (dBuV/m) vs Frequency (MHz) with a peak at 5.0 MHz. Includes site and condition details for both orientations.



WIFI	2.4GHz 2400~2483.5MHz Harmonic @ 3m	
ANT	802.11b CH06 2437MHz	
1+2	Horizontal	Vertical
Peak Avg.	<p>Site : 03CH11-HY Condition : PEAK_74 3m 9170 SHF HORM_150809 HORIZONTAL Detector : Peak</p>	<p>Site : 03CH11-HY Condition : PEAK_74 3m 9170 SHF HORM_150809 VERTICAL Detector : Peak</p>



WIFI	2.4GHz 2400~2483.5MHz Harmonic @ 3m	
ANT	802.11b CH11 2462MHz	
1+2	Horizontal	Vertical
Peak Avg.	<p>Site : 03CH11-HY Condition : PEAK_74 3m HORN 91200-HF HORIZONTAL Detector : Peak</p>	<p>Site : 03CH11-HY Condition : PEAK_74 3m HORN 91200-HF VERTICAL Detector : Peak</p>



2.4GHz 2400~2483.5MHz
 WIFI 802.11g (Harmonic @ 3m)

WIFI	2.4GHz 2400~2483.5MHz Harmonic @ 3m	
ANT	802.11g CH01 2412MHz	
1+2	Horizontal	Vertical
Peak Avg.	<p>Site : 03CH11-HY Condition : PEAK_74 3m 9170 SHF HORM_150809 HORIZONTAL Detector : Peak</p>	<p>Site : 03CH11-HY Condition : PEAK_74 3m 9170 SHF HORM_150809 VERTICAL Detector : Peak</p>



WIFI	2.4GHz 2400~2483.5MHz Harmonic @ 3m	
ANT	802.11g CH06 2437MHz	
1+2	Horizontal	Vertical
Peak Avg.	<p>Site : 03CH11-HY Condition : PEAK_74 3m 9170 SHF HORM_150809 HORIZONTAL Detector : Peak</p>	<p>Site : 03CH11-HY Condition : PEAK_74 3m 9170 SHF HORM_150809 VERTICAL Detector : Peak</p>



WIFI	2.4GHz 2400~2483.5MHz Harmonic @ 3m	
ANT	802.11g CH11 2462MHz	
1+2	Horizontal	Vertical
Peak Avg.	<p>Site : 03CH11-HY Condition : PEAK_74 3m 9170 SHF HORM_150809 HORIZONTAL Detector : Peak</p>	<p>Site : 03CH11-HY Condition : PEAK_74 3m 9170 SHF HORM_150809 VERTICAL Detector : Peak</p>



2.4GHz 2400~2483.5MHz
WIFI 802.11n HT20 (Harmonic @ 3m)

WIFI	2.4GHz 2400~2483.5MHz Harmonic @ 3m	
ANT	802.11n HT20 CH01 2412MHz	
1+2	Horizontal	Vertical
Peak Avg.	<p>Site : 03CH11-HY Condition : PEAK_74 3m 9170 SHF HORM_150809 HORIZONTAL Detector : Peak</p>	<p>Site : 03CH11-HY Condition : PEAK_74 3m 9170 SHF HORM_150809 VERTICAL Detector : Peak</p>



WIFI	2.4GHz 2400~2483.5MHz Harmonic @ 3m	
ANT	802.11n HT20 CH06 2437MHz	
1+2	Horizontal	Vertical
Peak Avg.	<p>Site : 03CH11-HY Condition : PEAK_74 3m 9170 SHF HORM_150809 HORIZONTAL Detector : Peak</p>	<p>Site : 03CH11-HY Condition : PEAK_74 3m 9170 SHF HORM_150809 VERTICAL Detector : Peak</p>

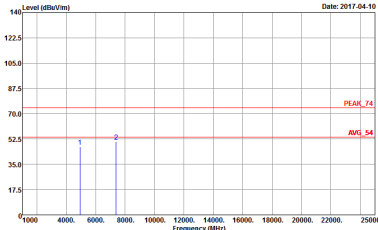
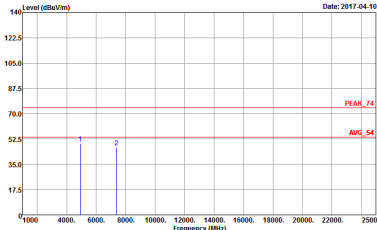

WIFI	2.4GHz 2400~2483.5MHz Harmonic @ 3m	
ANT	802.11n HT20 CH11 2462MHz	
1+2	Horizontal	Vertical
Peak Avg.	 <p>Site : 03CH11-HY Condition : PEAK_74 3m 9170 SHF HORM_150809 HORIZONTAL Detector : Peak</p>	 <p>Site : 03CH11-HY Condition : PEAK_74 3m 9170 SHF HORM_150809 VERTICAL Detector : Peak</p>



2.4GHz 2400~2483.5MHz
WIFI 802.11ac VHT20 (Harmonic @ 3m)

WIFI	2.4GHz 2400~2483.5MHz Harmonic @ 3m	
ANT	802.11ac VHT20 CH01 2412MHz	
1+2	Horizontal	Vertical
Peak Avg.	<p>Site : 03CH11-HY Condition : PEAK_74 3m 9170 SHF HORM_150809 HORIZONTAL Detector : Peak</p>	<p>Site : 03CH11-HY Condition : PEAK_74 3m 9170 SHF HORM_150809 VERTICAL Detector : Peak</p>



WIFI	2.4GHz 2400~2483.5MHz Harmonic @ 3m	
ANT	802.11ac VHT20 CH06 2437MHz	
1+2	Horizontal	Vertical
Peak Avg.	<p>Site : 03CH11-HY Condition : PEAK_74 3m 9170 SHF HORM_150809 HORIZONTAL Detector : Peak</p>	<p>Site : 03CH11-HY Condition : PEAK_74 3m 9170 SHF HORM_150809 VERTICAL Detector : Peak</p>



WIFI	2.4GHz 2400~2483.5MHz Harmonic @ 3m	
ANT	802.11ac VHT20 CH11 2462MHz	
1+2	Horizontal	Vertical
Peak Avg.	<p>Site : 03CH11-HY Condition : PEAK_74 3m 9170 SHF HORM_150809 HORIZONTAL Detector : Peak</p>	<p>Site : 03CH11-HY Condition : PEAK_74 3m 9170 SHF HORM_150809 VERTICAL Detector : Peak</p>



Emission below 1GHz
2.4GHz WIFI 802.11n HT20 (LF)

Table with 2 columns: Horizontal and Vertical. Each column contains a spectral plot showing Level (dBuV/m) vs Frequency (MHz) with a 'QP / Peak' label on the left.



Appendix D. Duty Cycle Plots

Antenna	Band	Duty Cycle(%)	T(us)	1/T(kHz)	VBW Setting
1+2	2.4GHz 802.11b for Ant 1	100	-	-	10Hz
1+2	2.4GHz 802.11b for Ant 2	100	-	-	10Hz
1+2	2.4GHz 802.11g for Ant 1	94.161	2064	0.484	1kHz
1+2	2.4GHz 802.11g for Ant 2	94.853	2064	0.484	1kHz
1+2	2.4GHz 802.11n HT20 for Ant 1	93.75	1920	0.521	1kHz
1+2	2.4GHz 802.11n HT20 for Ant 2	94.488	1920	0.521	1kHz
1+2	2.4GHz 802.11ac VHT20 for Ant 1	93.798	1936	0.517	1kHz
1+2	2.4GHz 802.11ac VHT20 for Ant 2	94.531	1936	0.517	1kHz



<MIMO Ant. 1>

2.4GHz 802.11b

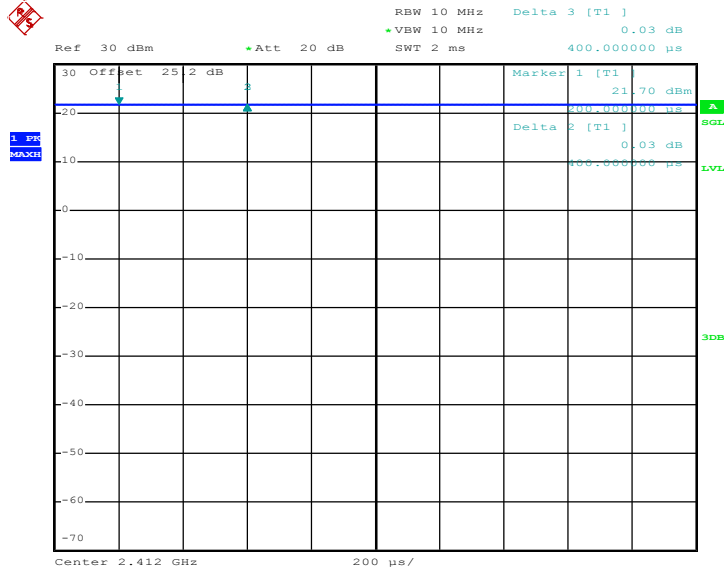

Date: 1.APR.2017 13:20:54

2.4GHz 802.11g

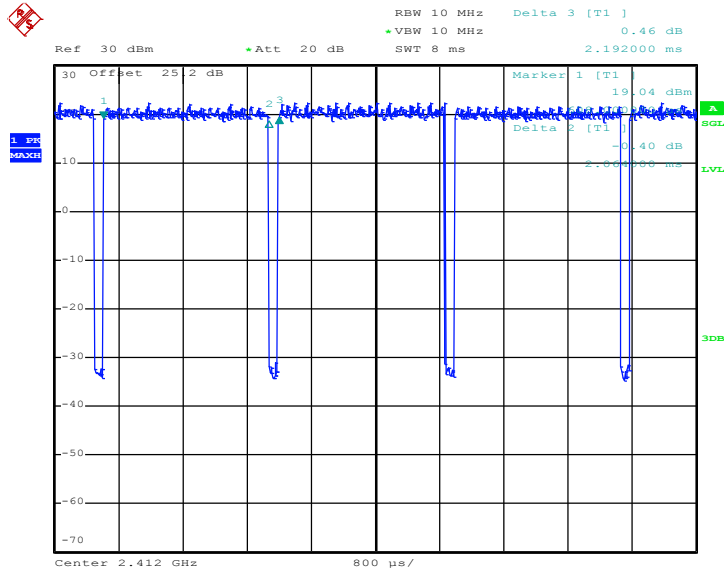

Date: 1.APR.2017 15:36:02



2.4GHz 802.11n HT20

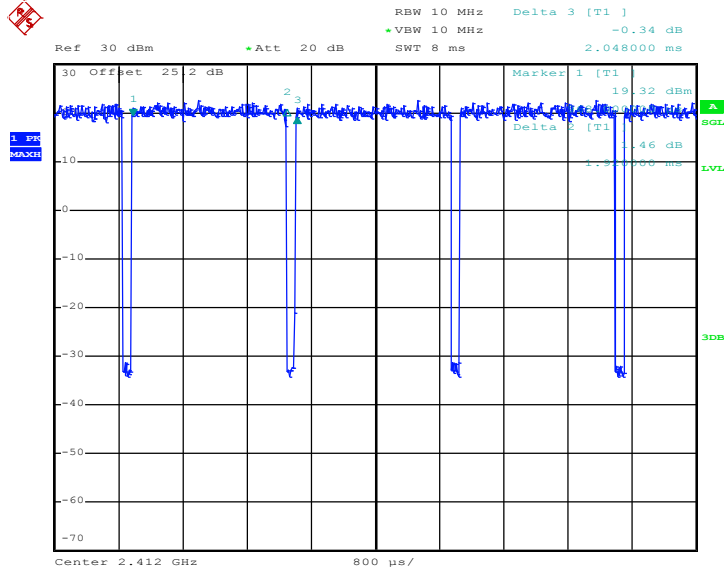

Date: 1.APR.2017 15:58:17

2.4GHz 802.11ac VHT20

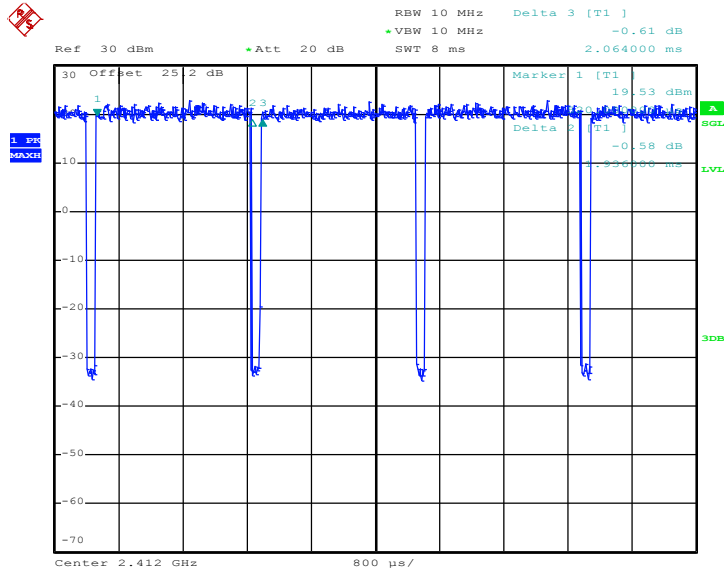

Date: 1.APR.2017 16:16:17



<MIMO Ant. 2>

2.4GHz 802.11b

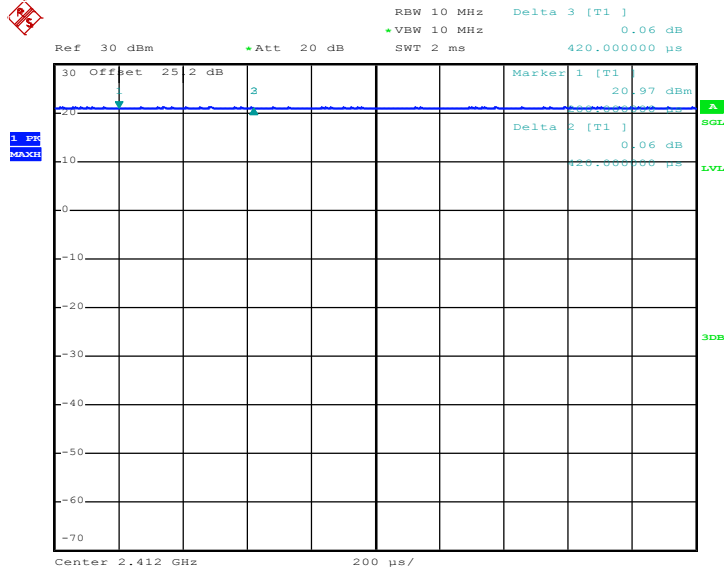

Date: 1.APR.2017 13:22:49

2.4GHz 802.11g

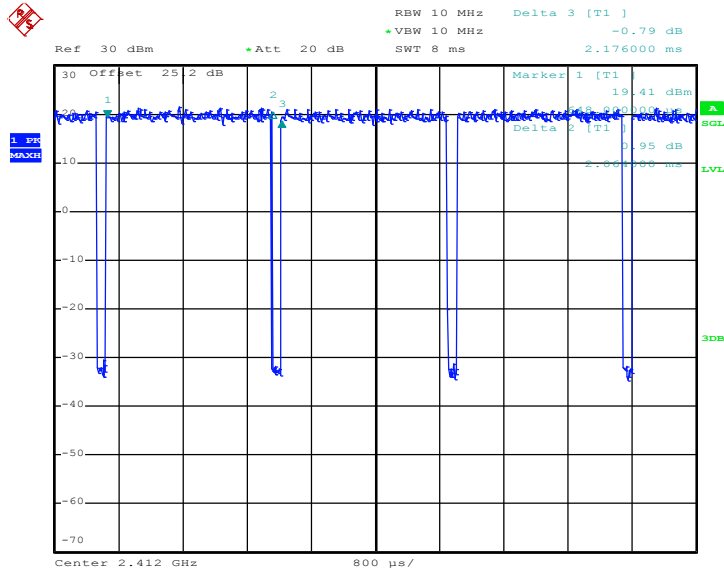

Date: 1.APR.2017 15:37:18



2.4GHz 802.11n HT20

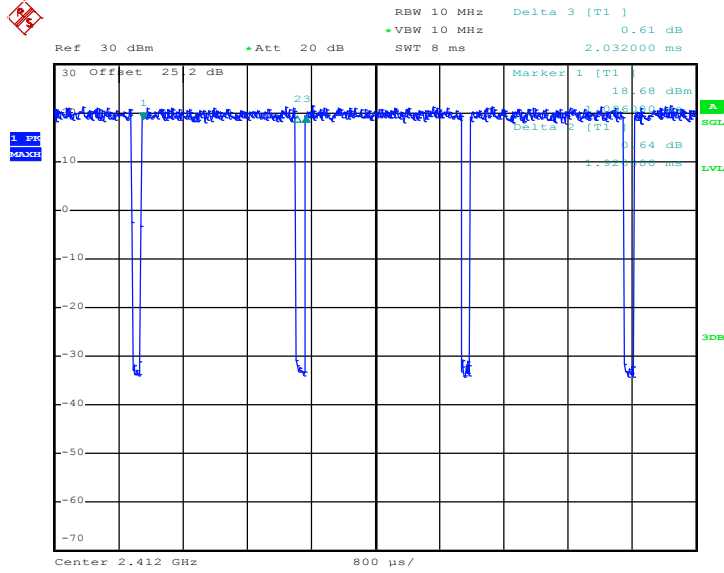

Date: 1.APR.2017 15:59:35

2.4GHz 802.11ac VHT20

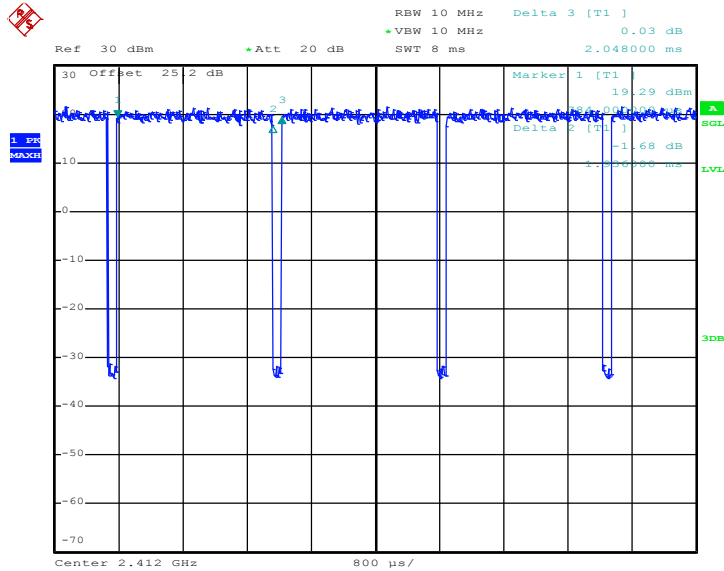

Date: 1.APR.2017 16:18:02