

SAR Compliance Test Report

Class II Permissive Change

APPLICANT NAME & ADDRESS:

 LG ELECTRONICS INC.
 Communication Terminal Research Lab
 459-9, Kasan-don, Keumchun-ku
 Seoul 153-023, Korea
 Attn: S.S. Kim , President

DATE & LOCATION OF TESTING:

 Dates of tests: Jan 26~27, 2004
 Test Site: LG ELECTRONICS, SEOUL Korea

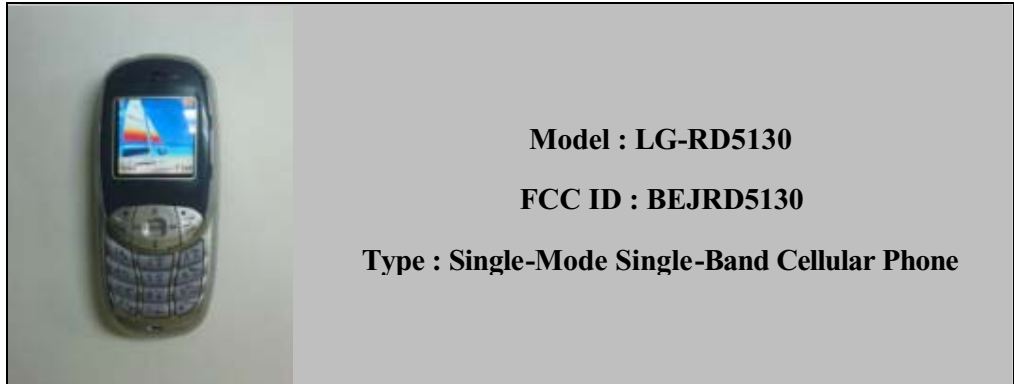
Test Device



Test Report No.	LGE-SAR2004003	Number of Page	57
Contact Person	S. S. Kim	Responsible Test Engineer	E. S. Park
Testing has been Carried out in Accordance with	IEEE P1528-200X Draft 6.4 Recommended Practice for Determining the Peak Spatial-Average Specific Absorption Rate(SAR) in the Human Body Due to Wireless Communications Device : Experimental Techniques		
Application Type	Certification		
FCC Classification	Licensed Portable Transmitter held to ear (PCE)		
FCC Rule Part(s)	§.1093; FCC/OET Bulletin 65 Supplement C (July 2001)		
Test Results	The Tested device complies with the requirements in respect of all parameters subject to the test. The test results and statements relate only to the items tested. The test report shall not be reproduced receipt in full, without written approval of the laboratory.		
Original Antenna(s)	SONY Antenna		
Permissive Change	Added Hitachi Antenna		
Date and Signatures	Feb / 02 / 2004		
Report Prepared by	 <hr style="width: 20%; margin: 0 auto;"/> Eui - Soon Park Senior Research Engineer		

Table of Contents

1. SUMMARY FOR SAR TEST REPORT	3
1.1 Head Configuration	3
1.2 Body Worn Configuration	3
1.3 Measurement Uncertainty	3
2. INTRODUCTION.....	4
3. DESCRIPTION OF THE DEVICE UNDER TEST	5
3.1 Antenna Description.....	5
3.2 Device Description.....	5
3.3 Battery Option.....	5
4. TEST CONDITIONS	6
4.1 Ambient Conditions	6
4.2 RF Characteristics of The Test Site	6
4.3 Test Signal, Frequencies, And Output Power	6
5. DESCRIPTION OF THE TEST EQUIPMENT	7
5.1 Test System Specifications	7
5.2 SAR Measurement Setup	7
5.3 DASY4 E- Field Probe System.....	8
5.4 Phantom & Equivalent Tissues	10
6. DESCRIPTION OF THE TEST PROCEDURE	12
6.1 Definition of Reference Point.....	12
6.2 Test Configuration Positions	13
6.3 Scan Procedures.....	16
6.4 SAR Averaging Methods.....	16
7. MEASUREMENT UNCERTAINTY.....	17
8. SYSTEM VERIFICATION.....	18
8.1 Tissue Verification.....	18
8.2 Test System Validation	18
9. RESULTS	19
10. REFERENCE.....	22
APPENDIX A : Validation Test Data	
APPENDIX B : SAR Test Setup Photographs	
APPENDIX C : SAR Test Data	
APPENDIX D : Calibration Certificates	

1. SUMMARY FOR SAR TEST REPORT

FCC ID	BEJRD5130
Date of Test	Jan 26~27, 2004
Responsible Test Engineer	Eui - Soon Park
Measurement Performed by	Cheol - Goo Lee
EUT Type	Single -mode Single-band Cellular Phone (CDMA)
Tx Frequency	824.820 ~ 848.190 MHz (CDMA)
Rx Frequency	869.820 ~ 893.190 MHz (CDMA)
Max. RF Output Power	0.269W ERP - CDMA (24.3 dBm)

Maximum Results Found During SAR Evaluation

1.1 Head Configuration

Max. SAR Measurement

FREQUENCY		Modulation	Power		Device test position	Antenna position	SAR (W/kg)
MHz	Ch		dBm	Battery			
836.52	384	CDMA	25	Standard	Right Cheek Touch	Fixed	1.04

1.2 Body Worn Configuration

Max. SAR Measurement

FREQUENCY		Modulation	Power		Separation Distance (cm)	Antenna position	SAR (W/kg)
MHz	Ch		dBm	Battery			
836.52	384	CDMA	25	Standard	1.5 [w/o Holster]	Fixed	0.522

1.3 Measurement Uncertainty

Combine Standard Uncertainty	10.3 (k=1)
Extended Standard Uncertainty	20.6 (k=2, 95% CONFIDENCE LEVEL)

2. INTRODUCTION

The FCC has adopted the guidelines for evaluating the environmental effects of radio frequency radiation in ET Docket 93-62 on Aug. 6, 1996 to protect the public and workers from the potential hazards of RF emissions due to FCC-regulated portable device.[1]

The safety limits used for the environmental evaluation measurements are based on the criteria published by the American National Standards Institute (ANSI) For localized specific absorption rate (SAR) in IEEE/ANSI C95.1-1992 Standard for safety Levels with Respect to Human Exposure to Radio Frequency Electronic Fields, 3 kHz to 300 GHz. (c) 1992 by the institute of Electrical and Electronics Engineers, Inc., New York, New York 10017.[2] The measurement procedure described in IEEE/ANSI C95.3-1992 Recommended Practice for the Measurement of Potentially Hazardous Electromagnetic Fields – RF and Microwave[3] is used for guidance in measuring SAR due to the RF radiation exposure from the Equipment Under Test (EUT). These criteria for SAR evaluation are similar to those recommended by the National Council on Radiation Protection and Measurements (NCRP) in Biological Effects and Exposure Criteria for Radio Frequency Electromagnetic Fields,” NCRP Report No. 86 (c) NCRP, 1986, Bethesda, MD20814.[6] SAR is a measure of the rate of energy absorption due to exposure to an RF transmitting source. SAR values have been related to threshold levels for potential biological hazards.

SAR Definition

Specific Absorption Rate (SAR) is defined as the time derivative (rate) of the incremental energy (dU) absorbed by (dissipated in) an incremental mass (dm) contained in a volume element (dV) of a given density (ρ). It is also defined as the rate of rf energy absorption per unit mass at a point in an absorbing body (see Fig. 3.1.).

$$SAR = \frac{d}{dt} \left(\frac{dU}{dm} \right) = \frac{d}{dt} \left(\frac{dU}{\rho dV} \right)$$

Figure 2.1 SAR Mathematical Equation

SAR is expressed in units of Watts per Kilogram (W/kg).

$$SAR = \sigma E^2 / \rho$$

Where:

- σ = conductivity of the tissue-simulant material (S/m)
- E = mass density of the tissue-simulant material (kg/m^3)
- ρ = Total RMS electric field strength (V/m)

3. DESCRIPTION OF THE DEVICE UNDER TEST

The FCC rules for evaluating portable devices for RF exposure compliance are contained in 47 CFR §2.1093. For purposes of RF exposure evaluation, a portable device is defined as a transmitting device designed to be used with any part of its radiating structure in direct contact with the user's body or within 20 centimeters of the body of a user or bystanders under normal operating conditions. This category of devices would include hand-held cellular and PCS telephones that incorporate the radiating antenna into the hand-piece and wireless transmitters that are carried next to the body. Portable devices are evaluated with respect to SAR limits for RF exposure. The applicable SAR limit for portable transmitters used by consumers is 1.6 watts/kg, which is averaged over any one gram of tissue defined as a tissue volume in the shape of a cube.

3.1 Antenna Description

Type	Fixed
Location	Right the back cover, the inside of the device
Configuration	Chip Type-Antenna-Module

3.2 Device Description

	FCC ID	BEJRD5130
	Serial numbers	Identical Prototype
	Exposure environment	Uncontrolled Exposure
	Device category	Portable Device
	Mode(s) of Operation	CDMA
	Modulation Mode(s)	CDMA
	Duty Cycle	1
	Transmitting Frequency Range(s)	824.820 ~ 848.190 MHz (CDMA)

3.3 Battery Options

There is only one battery option available for tested device.

4. TEST CONDITIONS

4.1 Ambient Conditions

Ambient Temperature (℃)	22 ±1
Tissue simulating liquid temperature (℃)	22 ±1
Humidity (%)	51.8

4.2 RF Characteristics of The Test Site

Tests were performed in a fully enclosed RF Shielded environment

4.3 Test Signal, Frequencies, And Output Power

The handset was placed into simulated call mode (CDMA modes) using manufacturers test codes.

In all operation bands the measurements were performed on lowest, middle and highest channels.

The phone was set to maximum power level during the all tests and at the beginning of the each test the battery was fully charged.

DASY4 system measures power drift during SAR testing by comparing e-field in the same location at the beginning and at the end of measurement. These records were used to monitor stability of power output.



Fig. 4.1 SAR Measurement System

5. DESCRIPTION OF THE TEST EQUIPMENT

An SAR measurement system usually consists of a small diameter isotropic electric field probe, a multiple axis probe positioning system, a test device holder, one or more phantom models, the field probe instrumentation, a computer and other electronic equipment for controlling the probe and making the measurements. Other supporting equipment, such as a network analyzer, power meters and RF signal generators, are also required to measure the dielectric parameters of the simulated tissue media and to verify the measurement accuracy of the SAR system.

5.1 Test System Specifications

Test Equipment	Model	Serial Number	Due date
DAE	DAE3	531	11/20/04
E-Field Probe	ET3DV6	1730	12/16/04
Dipole validation kit	D835V2	471	12/04/04
	D1900V2	5d017	09/05/04
Network analyzer	8753E	JP38451384	05/06/04
Signal generator	E4421B	MY41000199	05/06/04
RF Power meter	E4419B	MY41291298	07/09/04
Power Sensor	E9301A	US39212292	02/18/04
Dielectric Probe	HP85070B	85070-1003	04/26/04

5.2 SAR Measurement Setup

Measurement are performed using the DASY4 dosimetric assessment system. The DASY4 is made by Schmid & Partner Engineering AG(SPEAG) in Zurich, Switzerland and consists of high precision robotics system (Staubli), robot controller, Pentium IV computer, near-field probe, probe alignment sensor, and the SAM twin phantom containing the brain equivalent material. The robot is a six-axis industrial robot performing precise movements to position the probe to the location (points) of maximum electromagnetic field(EMF) (see Fig. 5.1)

A cell controller system contains the power supply, robot controller, teach pendant(Joystick), and a remote control used to drive the robot motors. The pc consists of the Intel Pentium IV 2.4 GHz computer with Windows 2000 system and SAR measurement Software DASY4, A/D interface card, monitor, mouse, and keyboard. The Staubli Robot data acquisition electronic (DAE) circuit that performs the signal amplification, signal multiplexing,

AD-conversion, offset measurements, mechanical surface detection, collision detection, etc.

5. DESCRIPTION OF THE TEST EQUIPMENT(continued)

Is connected to the Electro-optical coupler (EOC). The EOC performs the conversion from the optical into digital electric signal of the DAE and transfers data to the PC plug-in card.

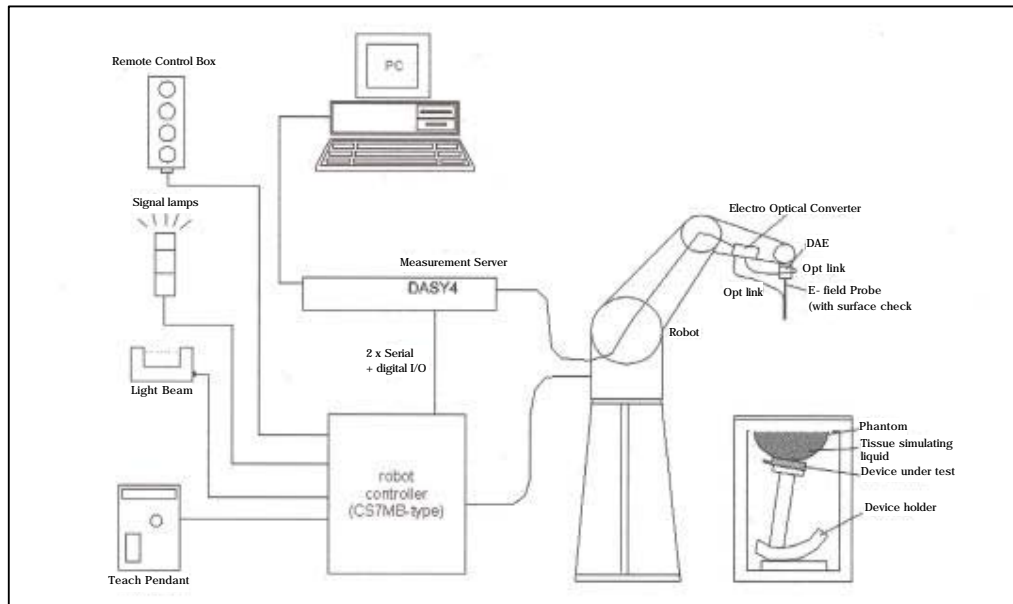

Fig. 5.1 SAR Measurement System Setup

The DAE4 consists of a highly sensitive electrometer-grade preamplifier with auto-zeroing, a channel and gain-switching multiplexer, a fast 16 bit AD-converter and a command decoder and control logic unit. Transmission to the PC-card is accomplished through an optical downlink for data and status information and an optical uplink for commands and clock lines. The mechanical probe mounting device includes two different sensor systems for frontal and sidewise probe contacts. They are also used for mechanical surface detection and probe collision detection. The robot uses its own controller with a built in VME-bus computer. The system is described in detail in [7].

5.3 DASY4 E-Field Probe System

The SAR measurements were conducted with the dosimetric probe ET3DV6, designed in the classical triangular configuration [7] (see Fig.5.2) and optimized for dosimetric evaluation. The probe is constructed using the thick film technique; with printed resistive lines on ceramic substrates. The probe is equipped with an optical multifiber line ending at the front of the probe tip. It is connected to the EOC box in the robot arm and provides an automatic detection transmitter, the other half to a synchronized receiver.

5. DESCRIPTION OF THE TEST EQUIPMENT(continued)

As the probe approach the surface, the reflection from the surface produces a coupling from the transmitting to the receiving fibers. This reflection increases first during the approach, reaches coupling is zero. The distance of the coupling maximum to the surface is probe angle. The DASY4 software reads the reflection during a software approach and looks for the maximum using a 2nd order fitting (see Table. 5.2). The approach is stopped at reaching the maximum.

Isotropic E-Field Probe for Dosimetric Measurements	
 Isotropic E-Field Probe	Construction Symmetrical design with triangular core Built-in optical fiber for surface detection system Built-in shielding against static charges PEEK enclosure material (resistant to organic solvents, e.g., glycoether)
	Calibration In air from 10 MHz to 3 GHz In brain and muscle simulating tissue at frequencies of 450 MHz, 900 MHz and 1.8 GHz (accuracy $\pm 8\%$) Calibration for other liquids and frequencies upon request
	Frequency 10 MHz to 3 GHz; Linearity: ± 0.2 dB (30 MHz to 3 GHz)
	Directivity ± 0.2 dB in HSL (rotation around probe axis) ± 0.4 dB in HSL (rotation normal to probe axis)
	Dynamic Range 5 μ W/g to > 100 mW/g; Linearity: ± 0.2 dB
	Dimensions Overall length: 330 mm Tip length: 16 mm Body diameter: 12 mm Tip diameter: 6.8 mm Distance from probe tip to dipole centers: 2.7 mm

Fig. 5.2 Probe Specifications

5. DESCRIPTION OF THE TEST EQUIPMENT(continued)

5.4 Phantom & Equivalent Tissues

SAM Phantom

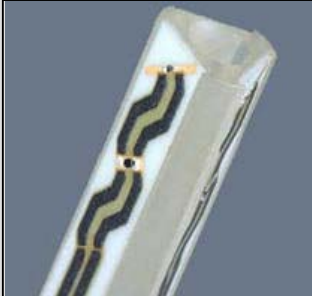
The SAM Twin Phantom V4.0 is constructed of the fiberglass shell integrated in a wooden table. The shape of the shell is based on data from an anatomical study designed to determine the maximum exposure in at least 90% of all users [11][12]. It enables the dosimetric evaluation of left and right hand phone usage as well as body mounted usage at the flat phantom region. A cover prevents the evaporation of the liquid. Reference markings on the phantom allow the complete setup of all predefined phantom positions and measurement grids by manually teaching three points in the robot.

Head & Muscle simulation Mixture Characterization

The brain and muscle mixtures consist of a viscous gel using hydroxethylcellulose(HEC) gelling agent and saline solution (see Table 5.1). Preservation with a bacteriacide is added and visual inspection is made to make sure air bubbles are not trapped during the mixing process. The mixture is calibrated to obtain proper dielectric constant (permittivity) and conductivity of the desired tissue. The head tissue dielectric parameters recommended by the IEEE SCC-34/SC-2 have been specified in P1528 are derived from the issue dielectric parameters computed from the 4-Cole-Cole equations The mixture characterizations used for the brain and muscle tissue simulation liquids are according to the data by C. Gabriel and G. Hartagrove [13]. (see Fig. 5.3)

Target Frequency (MHz)	Head		Body	
	ϵ_r	σ (S/m)	ϵ_r	σ (S/m)
150	52.3	0.76	61.9	0.80
300	45.3	0.87	58.2	0.92
450	43.5	0.87	56.7	0.94
835	41.5	0.90	55.2	0.97
900	41.5	0.97	55.0	1.05
915	41.5	0.98	55.0	1.06
1450	40.5	1.20	54.0	1.30
1610	40.3	1.29	53.8	1.40
1800 – 2000	40.0	1.40	53.3	1.52
2450	39.2	1.80	52.7	1.95
3000	38.5	2.40	52.0	2.73
5800	35.3	5.27	48.2	6.00

Fig. 5.3 Head and body tissue parameters by the IEEE SCC-34/SC-2 in P1528

5. DESCRIPTION OF THE TEST EQUIPMENT(continued)

835MHz			1900MHz		
Composition	Head	Body	Composition	Head	Body
Sugar	47.31%	34.31 %	DGBE(diethylene Glycol butyl Ether)	44.91%	29.96 %
Deionized water	51.07%	65.45 %	Deionized water	54.88%	69.91 %
Salt	1.15%	0.62 %	Salt	0.21%	0.13 %
HEC (hydroxyethyl cellulose)	0.24%	-	-	-	-
Preventol	0.24%	0.1 %	-	-	-
ϵ	41.0±5%	55.2±5%	ϵ	40.0±5%	53.3±5%
σ	0.89±10%	0.97±10%	σ	1.45±10%	1.52±10%

Fig. 5.4 Composition of the Tissue Equivalent Matter

Device Holder for Transmitters

In combination with the SAM Twin Phantom V4.0, the Mounting Device enables the rotation of the accurately, and repeatably be positioned according to the FCC specifications. The device holder can be locked at different phantom locations (left head, right head, flat phantom).

Note : A simulating human hand is not used due to the complex anatomical and geometrical structure of the hand that may produce infinite number of configurations [12]. To produce the worst-case condition (the hand absorbs antenna output power), the hand is omitted during the tests.

6. DESCRIPTION OF THE TEST PROCEDURE

6.1 Definition of Reference Point

EAR Reference point

The point "M" is the reference point for the center of the mouth, "ERP" is the ear reference point. The ERP are 15mm posterior to the entrance to the ear canal (EEP) along the B-M line (Back-Mouth), as shown in figure 6.1. The plane passing through the two ear canals and M is defined as the Reference Plane. The line N-F (Neck-Front) is perpendicular to the reference plane and passing through the ERP is called the Reference Pivoting Line (see Figure 6.1) B-M is perpendicular to the N-F line. Both N-F and B-M lines are marked on the external phantom shell to facilitate handset positioning [5].

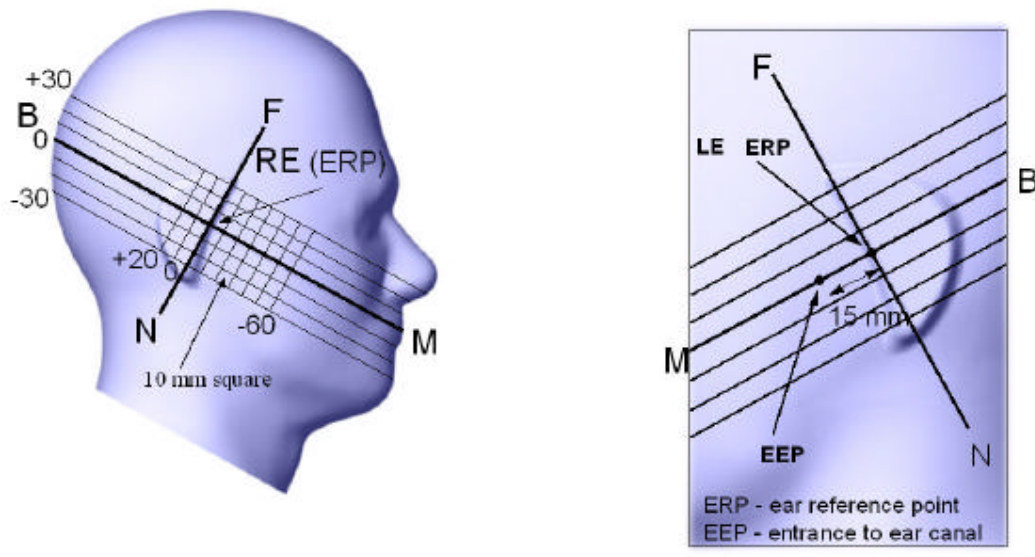

Fig. 6.1 Close-up side view of ERP

Handset Reference Points

Two imaginary lines on the handset were established: the vertical centerline and the horizontal line. The test device was placed in a normal operating position with the "test device reference point" located along the "vertical centerline" on the front of the device aligned to the "ear reference point" (see Fig. 6.2). The "test device reference point" was then located at the same level as the center of the ear reference point. The test device was positioned so that the "vertical centerline" was bisecting the front surface of the handset at its top and bottom edges, positioning the "ear reference point" on the outer surface of the both the left and right head phantoms on the ear reference point" on the outer surface of the both the left and right head phantoms on the ear reference point.

6. DESCRIPTION OF THE TEST PROCEDURE(continued)

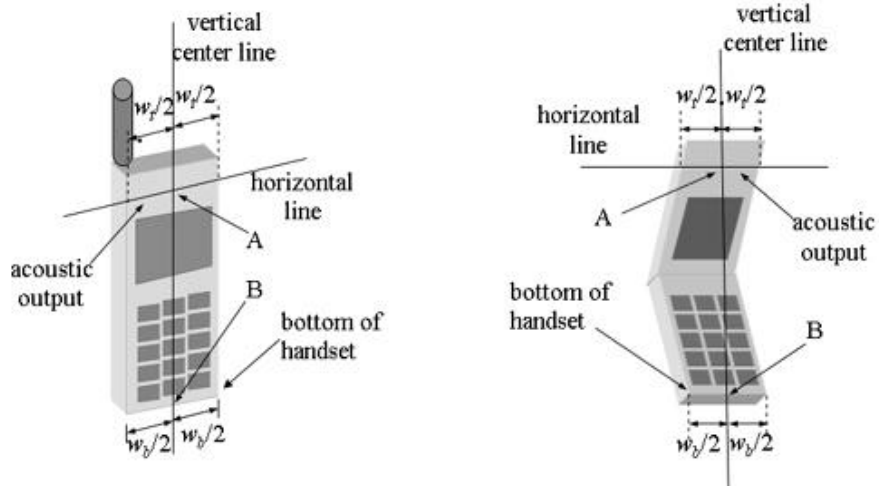

Fig. 6.2 Handset Vertical Center & Horizontal Line Reference Points

6.2 Test Configuration Positions

Positioning for Cheek/Touch

- 1) Ready the handset for talk operation, if necessary. For example, for handsets with a cover piece, open the cover . (If the phone can also be used with the cover closed ,both configurations must be tested.)
- 2) Define two imaginary lines on the handset: the vertical centerline and the horizontal line. The vertical centerline passes through two points on the front side of the handset: the midpoint of the width w_t of the handset at the level of the acoustic output (point A on Figures 6.2), and the midpoint of the width w_b of the bottom of the handset (point B). The horizontal line is perpendicular to the vertical centerline and passes through the center of the acoustic output (see Figure 6.2). The two lines intersect at point A. Note that for many handsets, point A coincides with the center of the acoustic output. However, the acoustic output may be located elsewhere on the horizontal line. Also note that the vertical centerline is not necessarily parallel to the front face of the handset (see Figure 6.2), especially for clamshell handsets, handsets with lip pieces, and other irregularly-shaped handsets.
- 3) Position the handset close to the surface of the phantom touch that point A is on the (virtual) extension of the line passing through points RE and LE on the phantom (see Figure 6.3), such that the plane defined by the vertical center line and the horizontal line of the phone is approximately parallel to the sagittal plane of the phantom.

6. DESCRIPTION OF THE TEST PROCEDURE(continued)

- 4) Translate the handset towards the phantom along the line passing through RE and LE until the handset touches the ear.
- 5) While maintaining the handset in this plane, rotate it around the LE-RE line until the vertical centerline is in the plane normal to MB-NF including the line MB (called the reference plane).
- 6) Rotate the phone around the vertical centerline until the phone (horizontal line) is symmetrical with respect to the line NF.
- 7) While maintaining the vertical centerline in the reference plane, keeping point A on the line passing through RE and LE, and maintaining the phone contact with the ear, rotate the handset about the line NF until any point on the handset is in contact with a phantom point

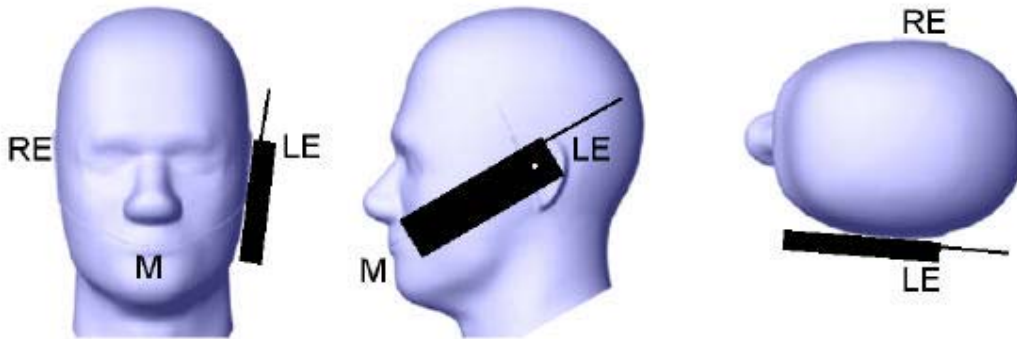

Fig. 6.3 “Cheek” or “Touch” Position.

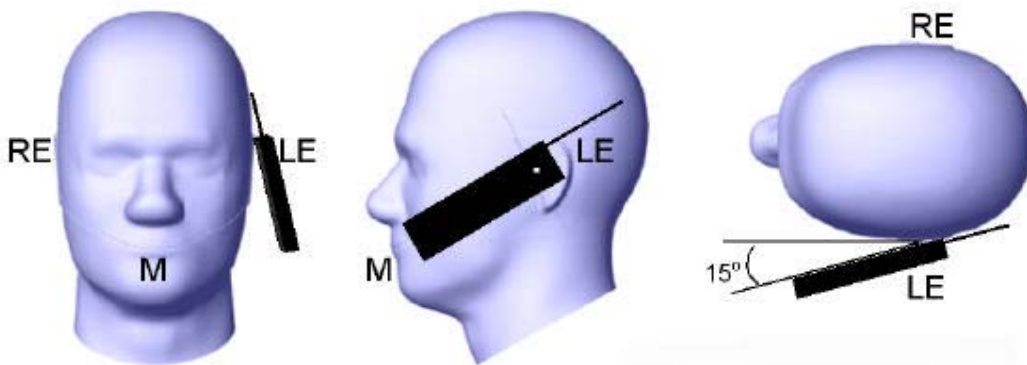

Fig. 6.4 “Tilted” Position.

6. DESCRIPTION OF THE TEST PROCEDURE(continued)

Positioning for Ear / 15 ° Tilted

- 1) Repeat steps 1 to 7 of 6.2(Positioning for Cheek/Touch) to place the device in the “cheek position.”
- 2) While maintaining the orientation of the phone retract the phone parallel to the reference plane far enough to enable a rotation of the phone by 15 degree.
- 3) Rotate the phone around the horizontal line by 15 degree.
- 4) While maintaining the orientation of the phone, move the phone parallel to the reference plane until any part of the phone touches the head. (In this position, point A will be located on the line RE-LE). The tilted position is obtained when the contact is on the pinna. If the contact is at any location other than the pinna, the angle of the phone shall be reduced. The tilted position is obtained if any part of the phone is in contact of the ear as well as a second part of the phone is contact with the head.

Body Holder / Belt Clip Configurations

Body-worn operation configurations are tested with the belt-clips and holsters attached to the device and positioned against a flat phantom in a normal use configuration. A device with a headset output is tested with a headset connected to the device. Body dielectric parameters are used.

Accessories for Body-worn operation configurations are divided into two categories: those that do not contain metallic components and those that do contain metallic components. When multiple accessories that do not contain metallic components are supplied with the device, the device is tested with only the accessory that dictates the closest spacing to the body. Then multiple accessories that contain metallic components are supplied with the device, the device is tested with each accessory that contains a unique metallic component. If multiple accessories share an identical metallic component (i.e. the same metallic belt-clip used with different holsters with no other metallic components) only the accessory that dictates the closest spacing to the body is tested.

Body-worn accessories may not always be supplied of available as options for some devices intended to be authorized for body-worn use. In this case, a test configuration where a separation distance between the back of the device and the flat phantom is used. All test position spacings are documented.

Transmitters that are designed to operate in front of a person's face, as in push-to-talk configurations, are tested for SAR compliance is tested with the accessory(ies), including headsets and microphones, attached to the device and positioned against a flat phantom in a normal use configuration. In all case SAR measurements are performed to investigate the worst case positioning. Worst-case positioning is then documented and used to perform Body SAR testing.

In order for users to be aware of the body-worn operation requirements for meeting RF exposure compliance, operation instructing instructions and cautions statements are included in the user's manual.

6. DESCRIPTION OF THE TEST PROCEDURE(continued)

6.3 Scan Procedures

First coarse scans are used for quick determination of the field distribution. Nest cube scan, 7x7x7 points; spacing between each point 5x5x5 mm, is performed around the highest Efield value to determine the averaged SAR-distribution over 1g.

6.4 SAR Averaging Methods

The maximum SAR value is averaged over its volume using interpolation and extrapolation.

The interpolation of the points is done with a 3d-Spline. The 3d-Spline is composed of three one-dimensional splines with the “Not a Knot” –condition [W.Gander, Computermathematik, p. 141-150](x, y and z –directions) [Numerical Recipes in C, Second Edition, p 123].

The extrapolation is based on least square algorithm [W.Gander, Computermathematik, p.168-180]. Through the points in the first 30 mm in all z-axis, polynomials of order four are calculated. This polynomial is then used to evaluate the points between the surface and the probe tip. The points calculated from the surface, have a distance of 1mm from one another.

7. MEASUREMENT UNCERTAINTY

Uncertainty Component	Sec.	Tol. (±%)	Prob. Dist.	Div.	Ci (1 - g)	Ci (10 - g)	1 - g ui (±%)	10 - g ui (±%)	vi
Measurement System									
Probe Calibration	E1.1	4.8	N	1	1	1	4.8	4.8	∞
Axial Isotropy	E1.2	4.7	R	/3	0.7	0.7	1.9	1.9	∞
Hemispherical Isotropy	E1.2	9.6	R	/3	0.7	0.7	3.9	3.9	∞
Boundary Effect	E1.3	1.0	R	/3	1	1	0.6	0.6	∞
Linearity	E1.4	4.7	R	/3	1	1	2.7	2.7	∞
System Detection Limits	E1.5	1.0	R	/3	1	1	0.6	0.6	∞
Readout Electronics	E1.6	1.0	N	1	1	1	1.0	1.0	∞
Response Time	E1.7	0.8	R	/3	1	1	0.5	0.5	∞
Integration Time	E1.8	2.6	R	/3	1	1	1.5	1.5	∞
RF Ambient Conditions	E5.1	3.0	R	/3	1	1	1.7	1.7	∞
Probe Positioner Mechanical Tolerance	E5.2	0.4	R	/3	1	1	0.2	0.2	∞
Probe Positioning	E5.3	2.9	R	/3	1	1	1.7	1.7	∞
Max. SAR Evaluation	E4.2	1.0	R	/3	1	1	0.6	0.6	∞
Test Sample Related									
Test Sample Positioning	E3.2.1	2.9	N	1	1	1	2.9	2.9	145
Device Holder Uncertainty	E3.1.1	3.6	N	1	1	1	3.6	3.6	5
Output Power Variation – SAR drift measurement	5.6.2	5.0	R	/3	1	1	2.9	2.9	
Phantom & Tissue Parameters									
Phantom Uncertainty (Shape & Thickness tolerances)	E2.1	4.0	R	/3	1	1	2.3	2.3	∞
Liquid Conductivity – deviation from target values	E2.2	5.0	R	/3	0.64	0.43	1.8	1.2	∞
Liquid Conductivity – measurement uncertainty	E2.2	2.5	N	1	0.64	0.43	1.6	1.1	∞
Liquid Permittivity – deviation from target values	E2.2	5.0	R	/3	0.6	0.5	1.7	1.4	∞
Liquid Permittivity – measurement uncertainty	E2.2	2.5	N	1	0.6	0.5	1.5	1.2	∞
Combined Standard Uncertainty (k=1)			RSS				10.3	10.0	
Expanded Uncertainty (k=2) (95% CONFIDENCE LEVEL)							20.6	20.1	

The above measurement uncertainties are according to IEEE Std. 1528-200x (July, 2001)

8. SYSTEM VERIFICATION

8.1 Tissue Verification

Table 8.1 Simulated Tissue Verification [5]

MEASURED TISSUE PARAMETERS								
Liquid Temperature (°C)			21.3		Liquid Depth (mm)		150	
Date	01/26/04		01/27/04		-		-	
Tissue	835MHz Brain		835MHz Muscle		1900MHz Brain		1900MHz Muscle	
	Target	Measured	Target	Measured	Target	Measured	Target	Measured
Dielectric Constant: ϵ	41.5	40.7	55.2	55.3	40.0	-	53.3	-
Conductivity: σ	0.90	0.88	0.97	0.96	1.40	-	1.52	-
Deviation (%)	ϵ : -1.93 σ : -2.22		ϵ : +0.18 σ : -1.03		-		-	

8.2 Test System Validation

Prior to assessment, the system is verified to the $\pm 10\%$ of the specifications at 835MHz and 1900MHz by using the system validation kit(s). (Graphic Plots Attached)

Table 8.2 System Validation [5]

SYSTEM DIPOLE VALIDATION TARGET & MEASURED				
Tissue	System Validation Kit:	Targeted SAR _{1g} (mW/g)	Measured SAR _{1g} (mW/g)	Deviation (%)
835MHz Brain	D835V2, S/N: 471	2.375	2.42	+1.89
1900MHz Brain	D1900V2, S/N: 5d017	-	-	-

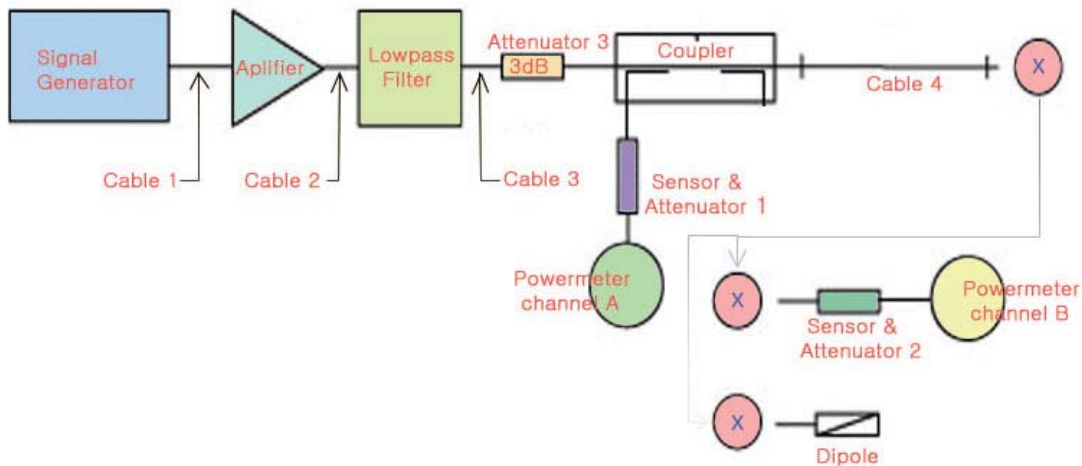
Fig. 8.1 Dipole Validation Test Setup

9. RESULTS

Ambient TEMPERATURE (C) 22.4
 Relative HUMIDITY (%) 51.8
 Mixture Type: 835MHz Brain
 Dielectric Constant: 40.7
 Conductivity: 0.88

Measurement Results (CDMA Head SAR-Touch)

ANSI / IEEE C95.1 1992 - SAFETY LIMIT Spatial Peak Uncontrolled Exposure/General Population	Brain 1.6 W/kg (mW/g) averaged over 1 gram
--	--

MEASUREMENT RESULTS (CDMA Left Head SAR — Touch)

Frequency		Modulation	Conducted Power(dBm)		Battery	Device Test position	Antenna Position	SAR (W/kg)
MHz	Ch.		Begin	End				
824.70	1013	CDMA	25.04	25.01	Standard	Cheek Touch	Fixed	0.615
836.52	384	CDMA	25.00	25.04	Standard	Cheek Touch	Fixed	0.999
848.31	777	CDMA	25.03	24.98	Standard	Cheek Touch	Fixed	0.904

MEASUREMENT RESULTS (CDMA Right Head SAR — Touch)

Frequency		Modulation	Conducted Power(dBm)		Battery	Device Test position	Antenna Position	SAR (W/kg)
MHz	Ch.		Begin	End				
824.70	1013	CDMA	25.08	25.05	Standard	Cheek Touch	Fixed	0.654
836.52	384	CDMA	25.01	24.96	Standard	Cheek Touch	Fixed	1.04
848.31	777	CDMA	25.08	24.97	Standard	Cheek Touch	Fixed	0.987

NOTES:

1. The test data reported are the worst-case SAR value with the antenna-head position set in a typical configuration.
2. All modes of operation were investigated and the worst-case are reported.
3. Battery Type : **Standard**
 Radiated measurements indicate that the Extended-life battery produces lower ERP and EIRP, therefore the Standard-life battery is used in SAR testing.
4. Power Measured : **Conducted**
5. SAR Measurement System : **SPEAG**
6. SAR Configuration : **Head**



 Eui - Soon Park
 Senior Research Engineer

9. RESULTS(continued)

Ambient TEMPERATURE (C) 22.4
 Relative HUMIDITY (%) 51.8
 Mixture Type: 835MHz Brain
 Dielectric Constant: 40.7
 Conductivity: 0.88

Measurement Results (CDMA Head SAR-Tilt)

ANSI / IEEE C95.1 1992 - SAFETY LIMIT Spatial Peak Uncontrolled Exposure/General Population	Brain 1.6 W/kg (mW/g) averaged over 1 gram
--	--

MEASUREMENT RESULTS (CDMA Left Head SAR — Tilt)

Frequency		Modulation	Conducted Power(dBm)		Battery	Device Test position	Antenna Position	SAR (W/kg)
MHz	Ch.		Begin	End				
824.70	1013	CDMA	25.03	25.01	Standard	Ear / 15 ° Tilt	Fixed	0.635
836.52	384	CDMA	25.07	24.97	Standard	Ear / 15 ° Tilt	Fixed	0.996
848.31	777	CDMA	25.00	24.92	Standard	Ear / 15 ° Tilt	Fixed	0.966

MEASUREMENT RESULTS (CDMA Right Head SAR — Tilt)

Frequency		Modulation	Conducted Power(dBm)		Battery	Device Test position	Antenna Position	SAR (W/kg)
MHz	Ch.		Begin	End				
824.70	1013	CDMA	25.02	25.00	Standard	Ear / 15 ° Tilt	Fixed	0.532
836.52	384	CDMA	25.00	24.94	Standard	Ear / 15 ° Tilt	Fixed	0.826
848.31	777	CDMA	25.04	24.95	Standard	Ear / 15 ° Tilt	Fixed	0.753

NOTES:

1. The test data reported are the worst-case SAR value with the antenna-head position set in a typical configuration.
2. All modes of operation were investigated and the worst-case are reported.
3. Battery Type : **Standard**
 Radiated measurements indicate that the Extended-life battery produces lower ERP and EIRP, therefore the Standard-life battery is used in SAR testing.
4. Power Measured : **Conducted**
5. SAR Measurement System : **SPEAG**
6. SAR Configuration : **Head**



Eui - Soon Park
 Senior Research Engineer

9. RESULTS(continued)

 Ambient TEMPERATURE (C) 22.7
 Relative HUMIDITY (%) 54.2
 Mixture Type: 835MHz Brain
 Dielectric Constant: 55.3
 Conductivity: 0.96

Measurement Results (CDMA BODY SAR w/o Holster)

ANSI / IEEE C95.1 1992 - SAFETY LIMIT Spatial Peak Uncontrolled Exposure/General Population	Muscle 1.6 W/kg (mW/g) averaged over 1 gram
--	---

MEASUREMENT RESULTS (CDMA BODY SAR Without Holster)								
Frequency		Modulation	Conducted Power(dBm)		Battery	Separation Distance(cm)	Antenna Position MHz	SAR (W/kg)
MHz	Ch.		Begin	End				
824.70	1013	CDMA	25.06	25.03	Standard	1.5 [w/o Holster]	Fixed	0.342
836.52	384	CDMA	25.00	25.09	Standard	1.5 [w/o Holster]	Fixed	0.522
848.31	777	CDMA	25.04	25.02	Standard	1.5 [w/o Holster]	Fixed	0.478

NOTES:

1. The test data reported are the worst-case SAR value with the antenna-head position set in a typical configuration.
2. All modes of operation were investigated and the worst-case are reported.
3. Battery Type : **Standard**
 Radiated measurements indicate that the Extended-life battery produces lower ERP and EIRP, therefore the Standard-life battery is used in SAR testing.
4. Power Measured : **Conducted**
5. SAR Measurement System : **SPEAG**
6. SAR Configuration : **Body**



Eui Soon Park
Senior Research Engineer

10. REFERENCE

- [1] Federal Communications Commission, ET Docket 93-62, Guidelines for Evaluating the Environmental Effects of Radio Frequency Radiation, Aug. 1996.
- [2] ANSI/IEEE C95.1 - 1991, American National Standard safety levels with respect to human exposure to radio frequency electromagnetic fields, 300kHz to 100GHz, New York: IEEE, Aug. 1992
- [3] ANSI/IEEE C95.3 - 1991, IEEE Recommended Practice for the Measurement of Potentially Hazardous Electromagnetic Fields - RF and Microwave, New York: IEEE, 1992.
- [4] Federal Communications Commission, OET Bulletin 65 (Edition 97-01), Supplement C (Edition 01-01), Evaluating Compliance with FCC Guidelines for Human Exposure to Radiofrequency Electromagnetic Fields, July 2001.
- [5] IEEE Standards Coordinating Committee 34 – IEEE Std. 1528-200X (Draft 6.5 – January, 2002), Draft Recommended Practice for Determining the Peak Spatial-Average Specific Absorption Rate (SAR) in the Human Body Due to Wireless Communications Devices: Experimental Techniques.
- [6] NCRP, National Council on Radiation Protection and Measurements, Biological Effects and Exposure Criteria for Radio Frequency Electromagnetic Fields, NCRP Report No. 86, 1986. Reprinted Feb. 1995.
- [7] T. Schmid, O. Egger, N. Kuster, Automated E-field scanning system for dosimetric assessments, IEEE Transaction on Microwave Theory and Techniques, vol. 44, Jan. 1996, pp. 105-113.
- [8] K. Pokovic, T. Schmid, N. Kuster, Robust setup for precise calibration of E-field probes in tissue simulating liquids at mobile communications frequencies, ICECOM97, Oct. 1997, pp. 120-124.
- [9] K. Pokovic, T. Schmid, and N. Kuster, E-field Probe with improved isotropy in brain simulating liquids, Proceedings of the ELMAR, Zadar, Croatia, June 23-25, 1996, pp. 172-175.
- [10] Schmid & Partner Engineering AG, Application Note: Data Storage and Evaluation, June 1998, p2.
- [11] V. Hombach, K. Meier, M. Burkhardt, E. Kuhn, N. Kuster, The Dependence of EM Energy Absorption upon Human Head Modeling at 900 MHz, IEEE Transaction on Microwave Theory and Techniques, vol. 44 no. 10, Oct. 1996, pp. 1865-1873.
- [12] N. Kuster and Q. Balzano, Energy absorption mechanism by biological bodies in the near field of dipole antennas above 300MHz, IEEE Transaction on Vehicular Technology, vol. 41, no. 1, Feb. 1992, pp. 17-23.
- [13] G. Hartsgrrove, A. Kraszewski, A. Surowiec, Simulated Biological Materials for Electromagnetic Radiation Absorption Studies, University of Ottawa, Bioelectromagnetics, Canada: 1987, pp. 29-36.
- [14] Q. Balzano, O. Garay, T. Manning Jr., Electromagnetic Energy Exposure of Simulated Users of Portable Cellular Telephones, IEEE Transactions on Vehicular Technology, vol. 44, no.3, Aug. 1995.
- [15] W. Gander, Computermathematick, Birkhaeuser, Basel, 1992.
- [16] W.H. Press, S.A. Teukolsky, W.T. Vetterling, and B.P. Flannery, Numerical Recipes in C, The Art of Scientific Computing, Second edition, Cambridge University Press, 1992.
- [17] Federal Communications Commission, OET Bulletin 65, Evaluating Compliance with FCC Guidelines for Human Exposure to Radio Frequency Electromagnetic Fields. Supplement C, Dec. 1997.
- [18] N. Kuster, R. Kastle, T. Schmid, Dosimetric evaluation of mobile communications equipment with known precision, IEEE Transaction on Communications, vol. E80-B, no. 5, May 1997, pp. 645-652.
- [19] CENELEC CLC/SC111B, European Prestandard (prENV 50166-2), Human Exposure to Electromagnetic Fields High-frequency: 10kHz-300GHz, Jan. 1995.
- [20] Prof. Dr. Niels Kuster, ETH, Eidgenössische Technische Hochschule Zürich, Dosimetric Evaluation of the Cellular Phone.

APPENDIX A : Validation Test Data

835MHz Dipole Validation

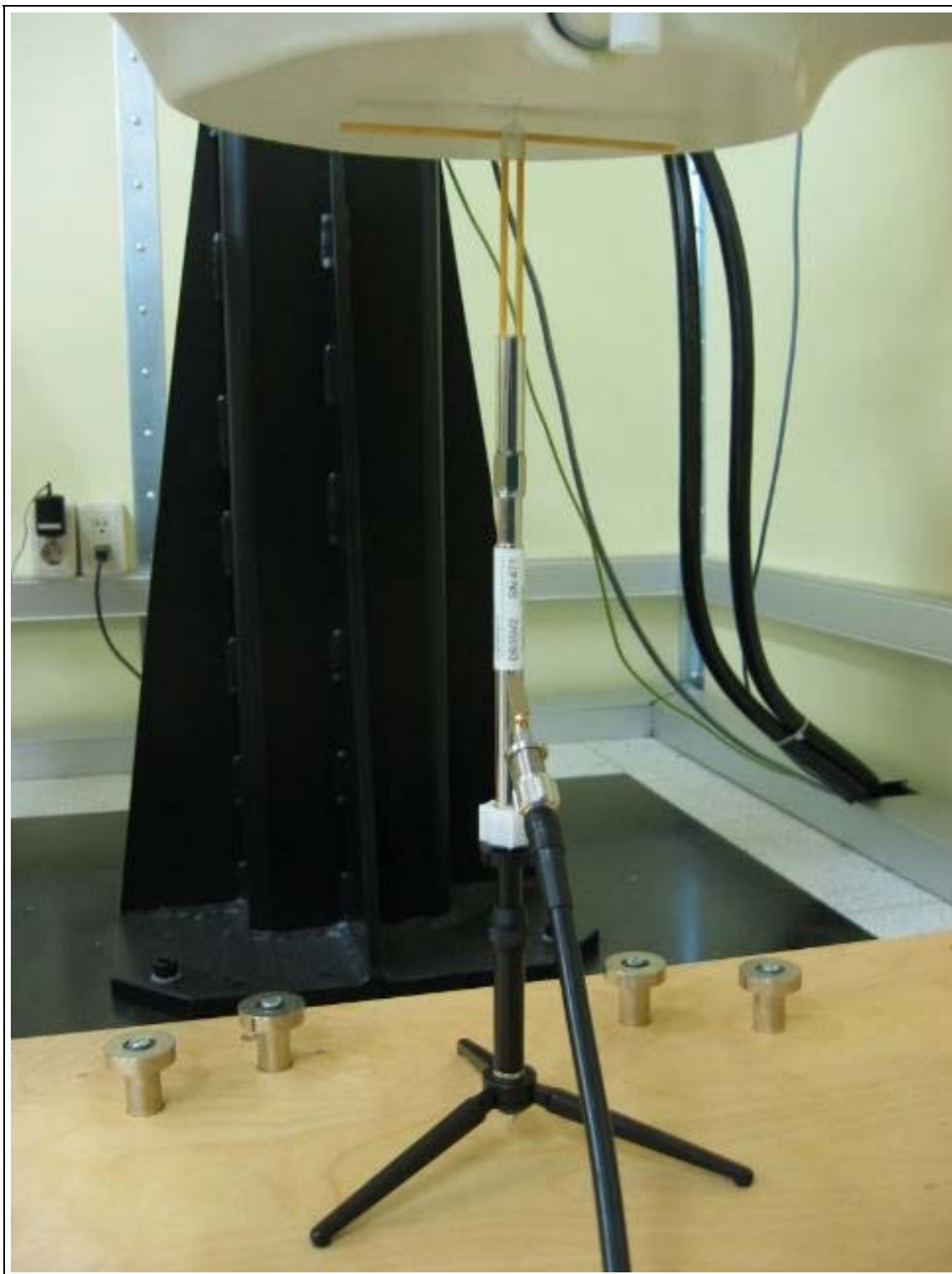

Test Laboratory: LG Electronics Inc.

DUT: Dipole 835MHz;Type: D835V2;Serial: 471

Program: 835 MHz Validation

Communication System: Validation;Frequency: 835 MHz;Duty Cycle: 1:1

Medium: Head 835 MHz; ($\sigma = 0.88$ mho/m, $\epsilon_r = 40.7$, $\rho = 1000$ kg/m³)

Phantom section: Flat Section

Test Date: 01/26/2004; Ambient Temp: 22.4 Ć; Tissue Temp:21.8 Ć

Probe: ET3DV6 - SN1730;ConvF(6.2, 6.2, 6.2);Calibrated: 2003-12-16

Sensor-Surface: 4mm (Mechanical And Optical Surface Detection)

Electronics: DAE3 Sn531;Calibrated: 2003 -11 -20

Phantom: SAM 835;Type: SAM 4.0;Serial: TP-1151

Measurement SW: DASY4, V4.1 Build 47;Postprocessing SW: SEMCAD, V1.6 Build 115

Validation 835 MHz/Area Scan (61x101x1): Measurement grid: dx=15mm, dy=15mm

Reference Value = 54.3 V/m

Power Drift = -0.02 dB

Maximum value of SAR = 2.57 mW/g

Validation 835 MHz/Zoom Scan (7x7x7)/Cube 0: Measurement grid: dx=5mm, dy=5mm, dz=5mm

Peak SAR (extrapolated) = 3.55 W/kg

SAR(1 g) = 2.42 mW/g; SAR(10 g) = 1.56 mW/g

Reference Value = 54.3 V/m

Power Drift = -0.02 dB

Maximum value of SAR = 2.6 mW/g

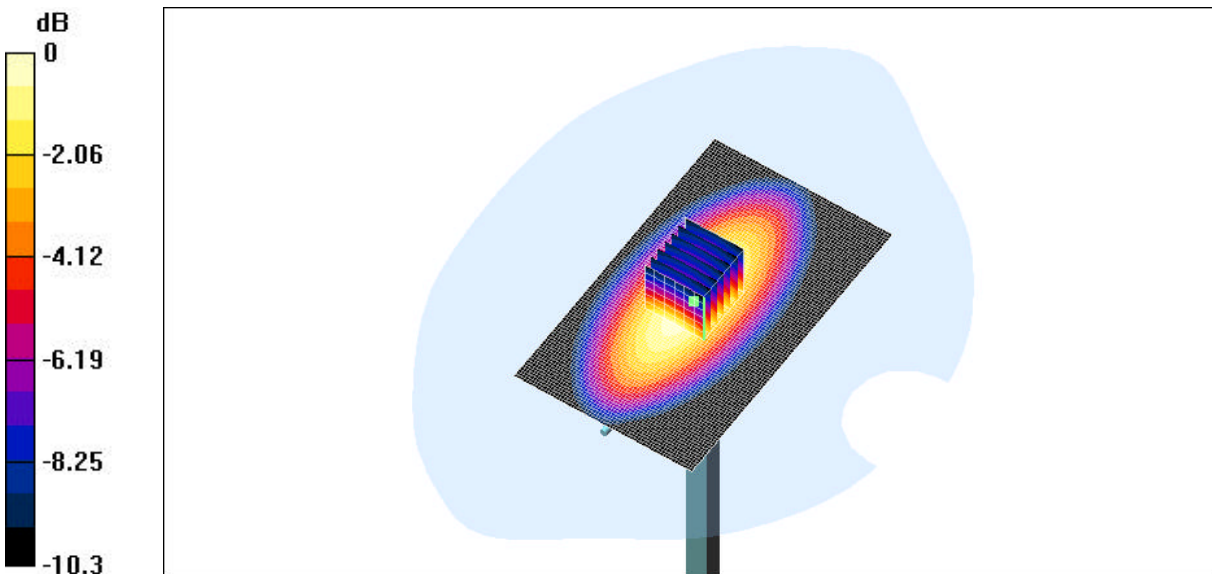

0 dB = 2.6mW/g

APPENDIX B : SAR Test Setup Photographs

Left Hand – Touch Position

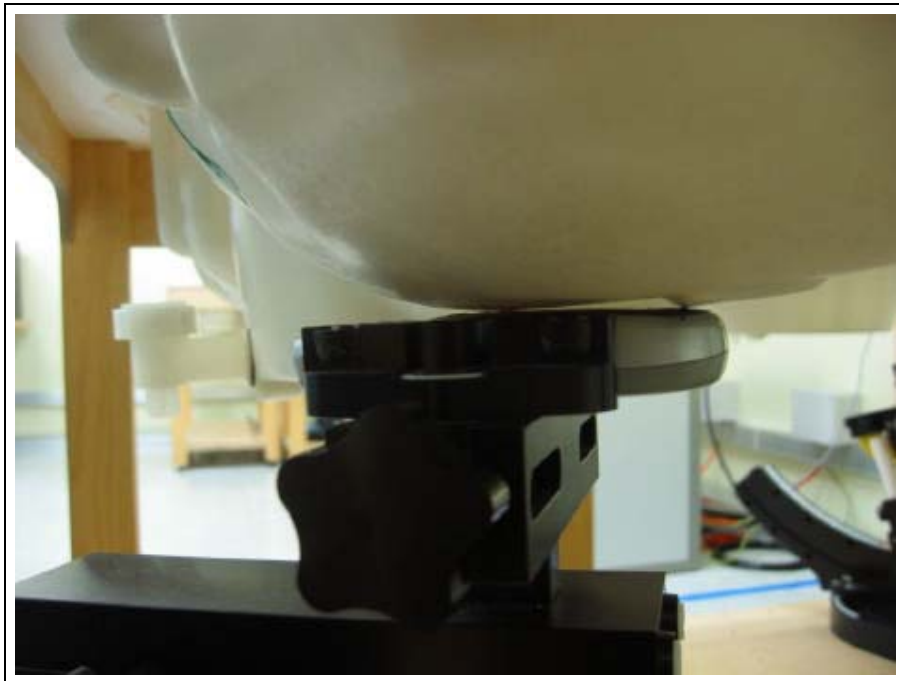

Right Hand – Touch Position

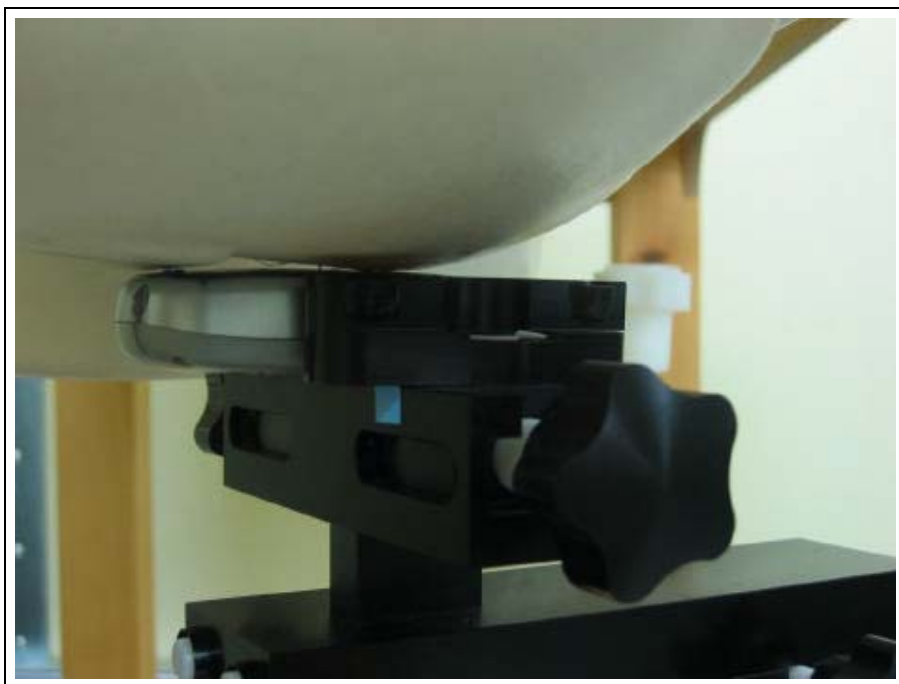

Left Hand – Tilt Position

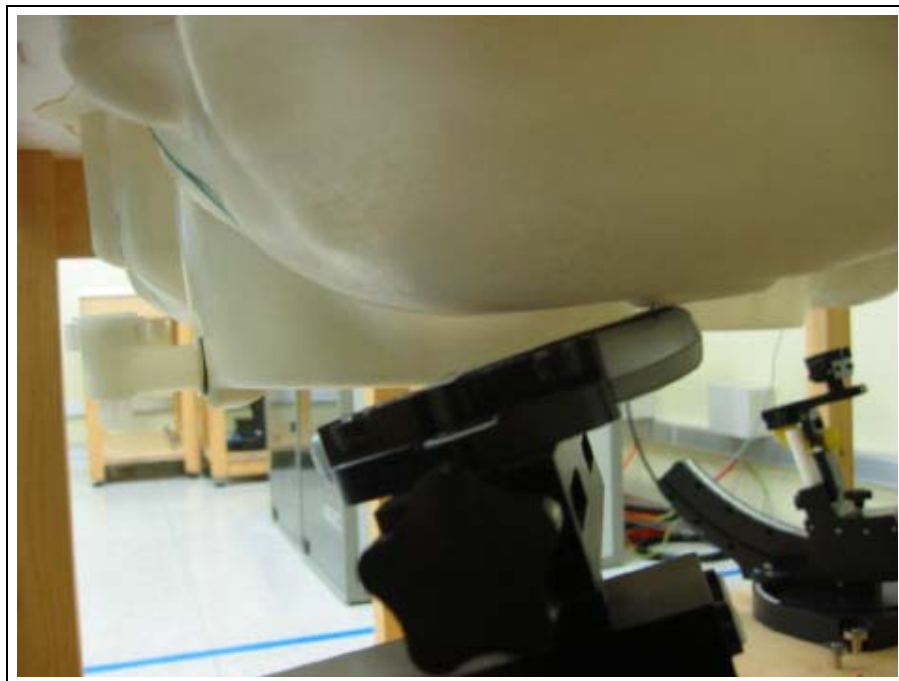

Right Hand – Tilt Position

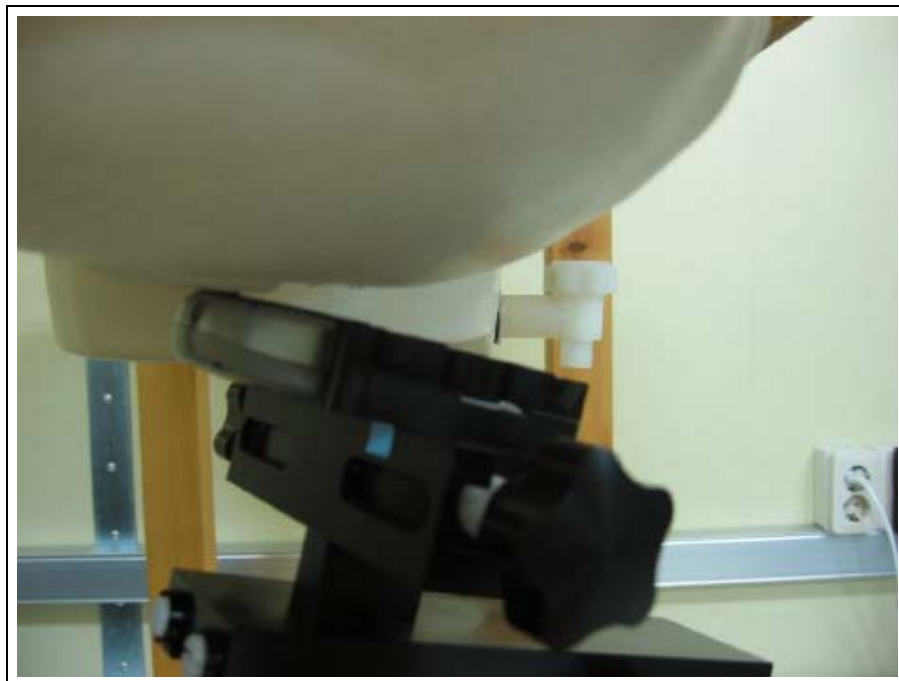

Flat – Body Side Configuration

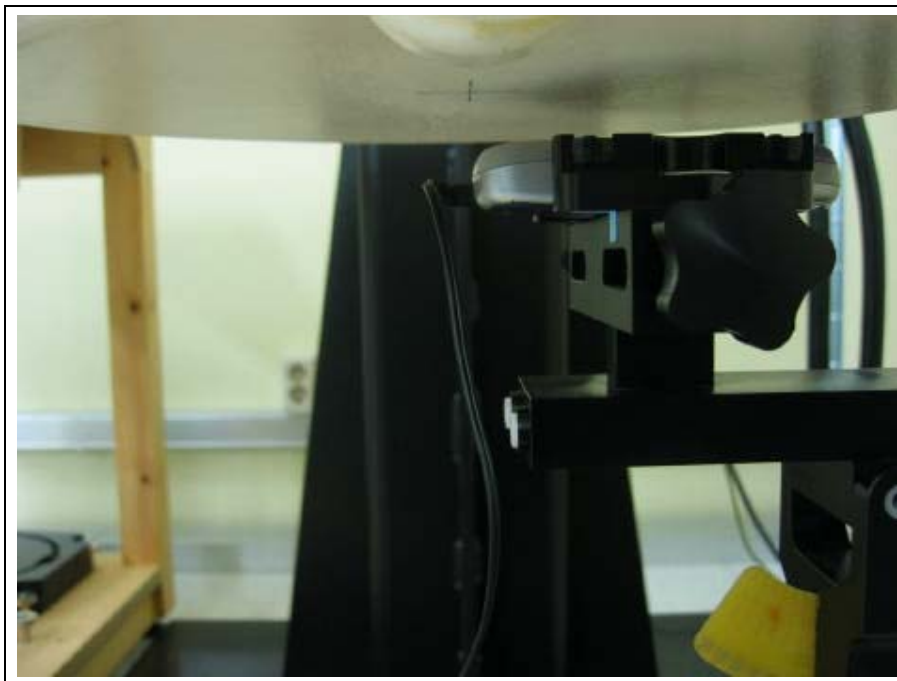

Flat – Body Front Configuration

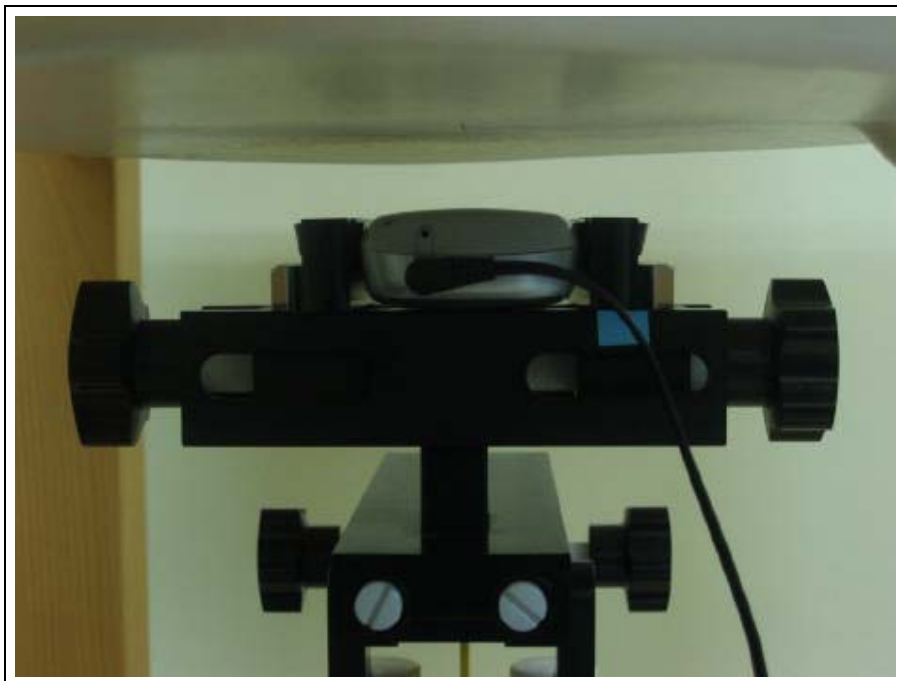







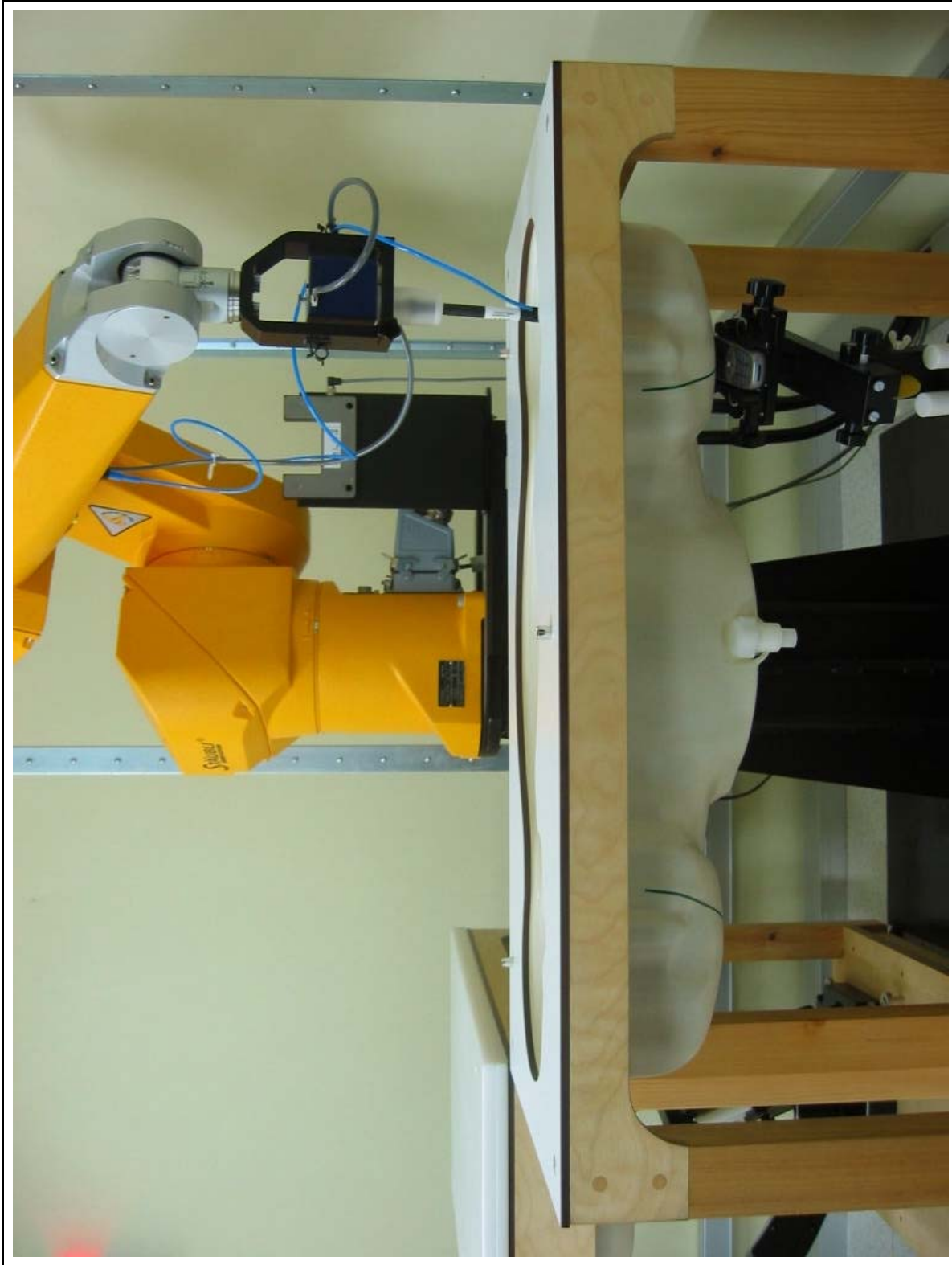

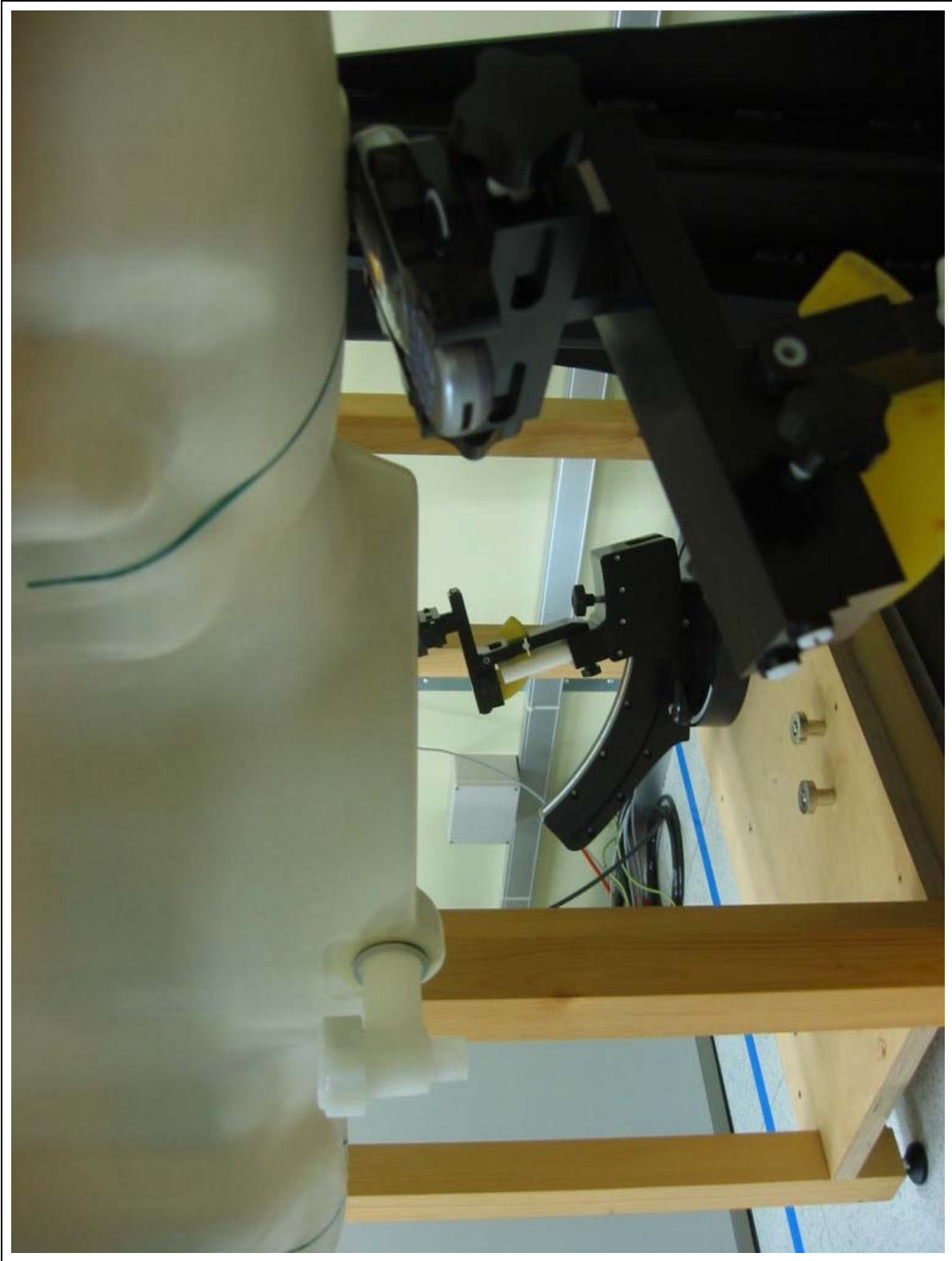



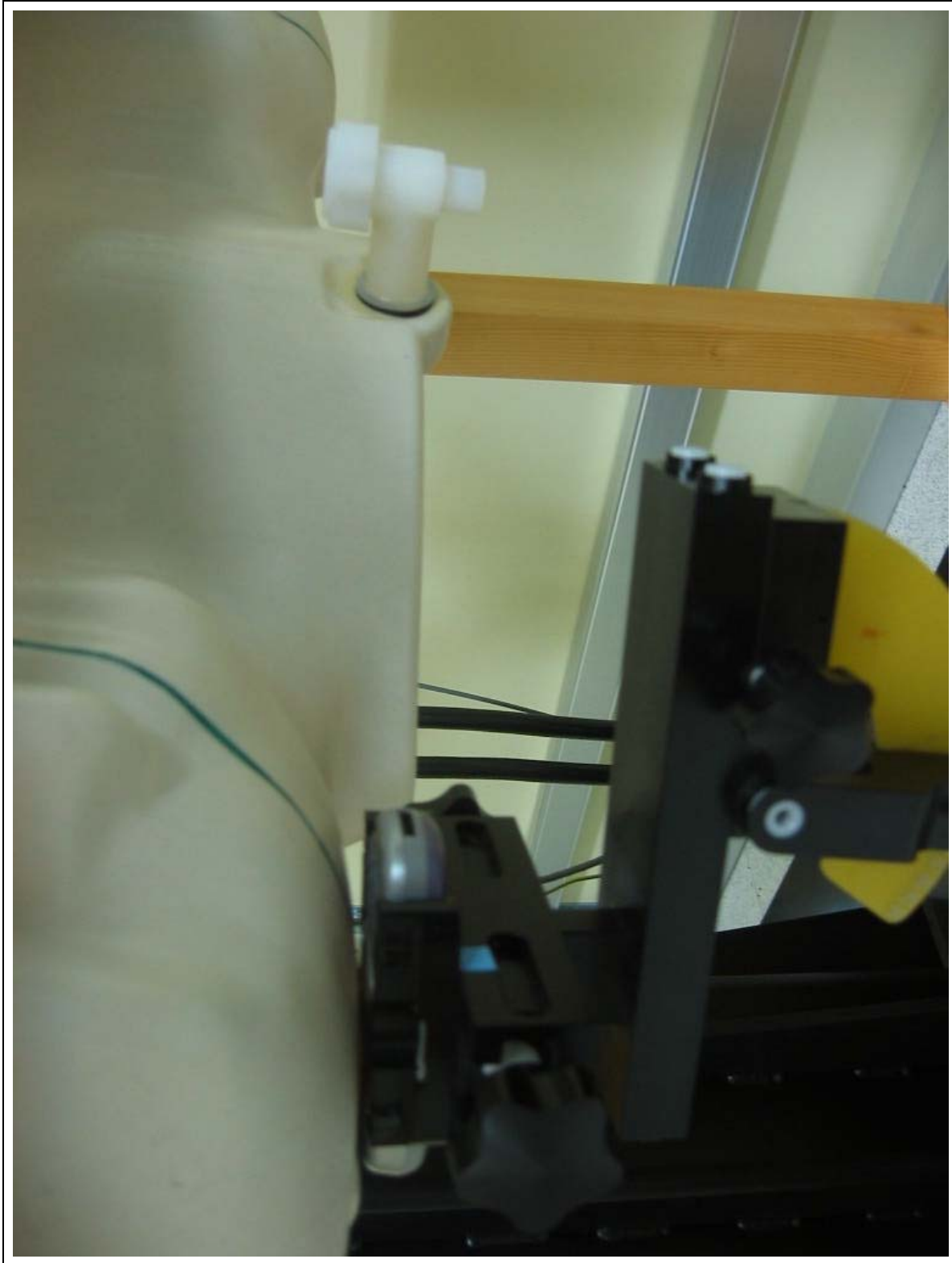



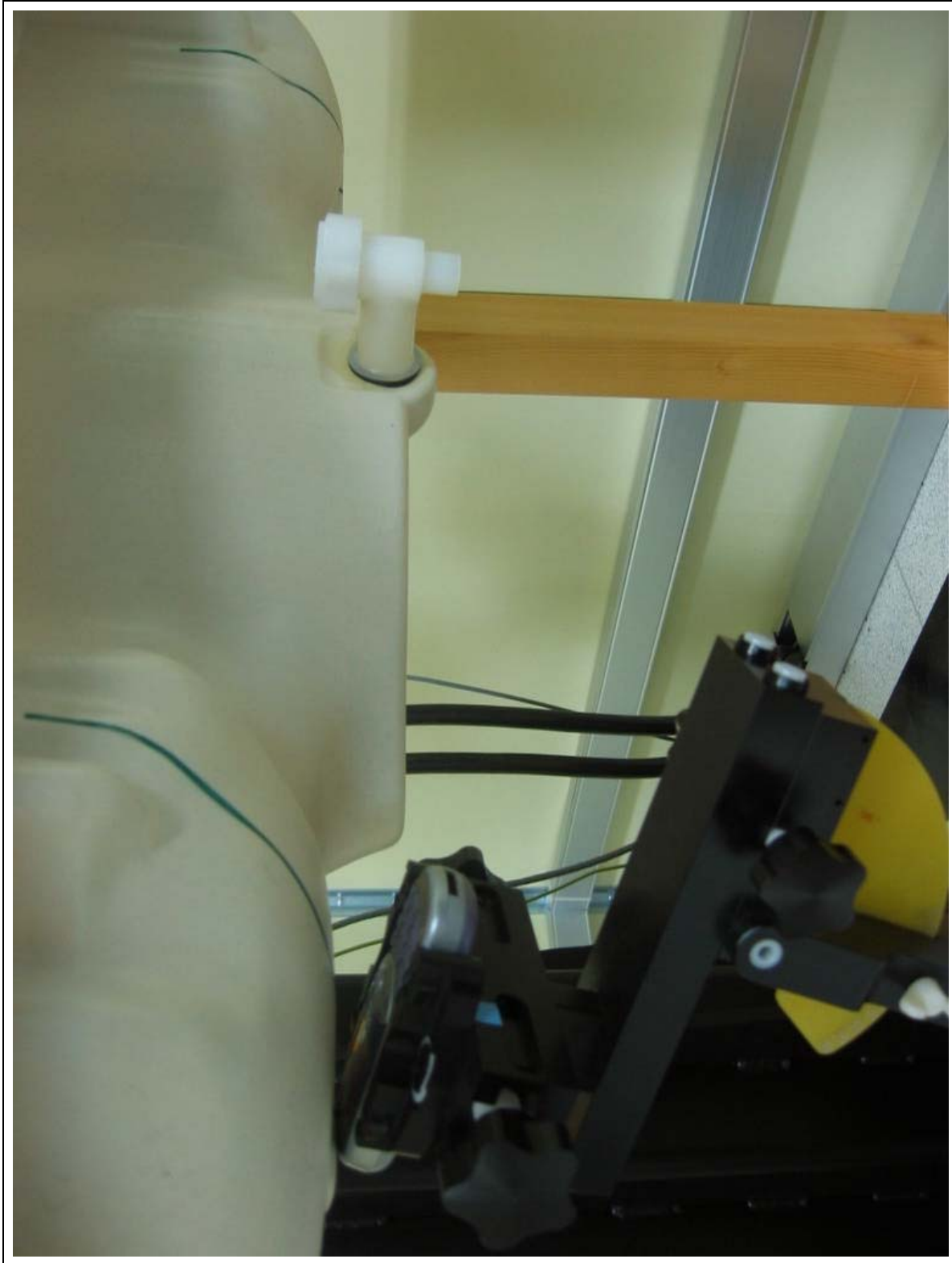





APPENDIX C : SAR Test Data

Test Laboratory: LG Electronics Inc.

DUT: LG-RD5130;Type: Single Band/Single Mode;Serial: #1 Hitachi Ant.

Program: LG-RD5130;CDMA Mode Ch: 384

Communication System: LG-RD5130;Frequency: 836.52 MHz;Duty Cycle: 1:1

Medium: Head 835 MHz; ($\sigma = 0.88$ mho/m, $\epsilon_r = 40.7$, $\rho = 1000$ kg/m³)

Phantom section: Left Section

Test Date: 01/26/2004; Ambient Temp: 22.4 °C; Tissue Temp:21.8 °C

Probe: ET3DV6 - SN1730;ConvF(6.2, 6.2, 6.2);Calibrated: 2003-12-16

Sensor-Surface: 4mm (Mechanical And Optical Surface Detection)

Electronics: DAE3 Sn531;Calibrated: 2003 -11 -20

Phantom: SAM 835;Type: SAM 4.0;Serial: TP-1151

Measurement SW: DASY4, V4.1 Build 47;Postprocessing SW: SEMCAD, V1.6 Build 115

CDMA 384 Left Head Touch/Area Scan (71x91x1): Measurement grid: dx=15mm, dy=15mm

Reference Value = 32.8 V/m

Power Drift = -0.1 dB

Maximum value of SAR = 1.12 mW/g

CDMA 384 Left Head Touch/Zoom Scan (7x7x7)/Cube 0: Measurement grid: dx=5mm, dy=5mm, dz=5mm

Peak SAR (extrapolated) = 1.77 W/kg

SAR(1 g) = 0.999 mW/g; SAR(10 g) = 0.628 mW/g

Reference Value = 32.8 V/m

Power Drift = -0.1 dB

Maximum value of SAR = 1.11 mW/g

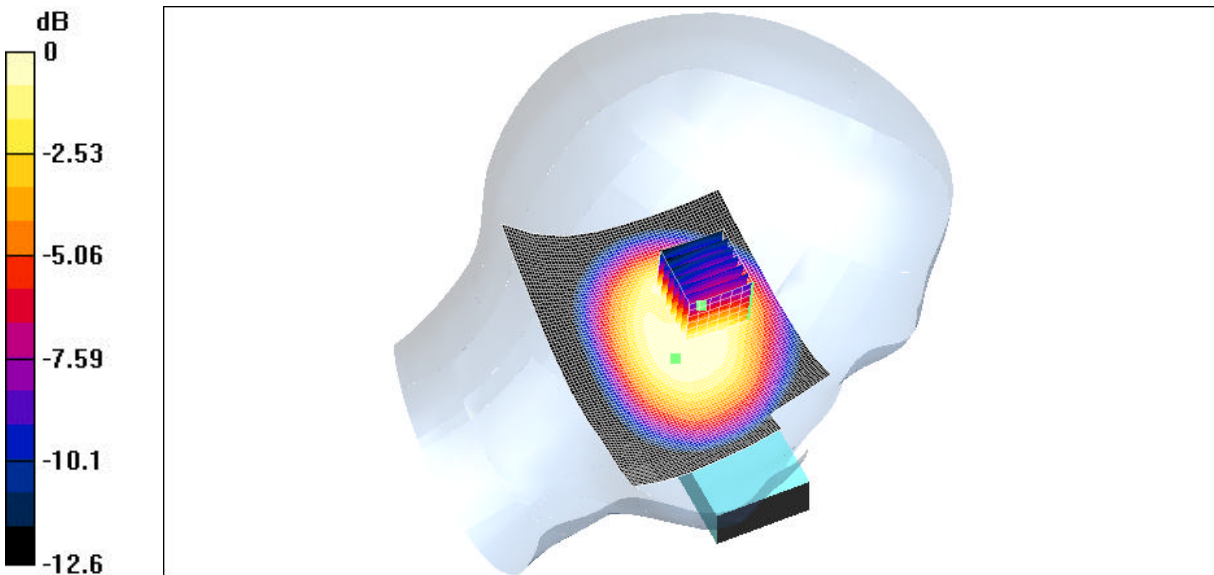

0 dB = 1.11mW/g

Test Laboratory: LG Electronics Inc.

DUT: LG-RD5130;Type: Single Band/Single Mode;Serial: #1 Hitachi Ant.

Program: LG-RD5130;CDMA Mode Ch: 384

Communication System: LG-RD5130;Frequency: 836.52 MHz;Duty Cycle: 1:1

Medium: Head 835 MHz; ($\sigma = 0.88$ mho/m, $\epsilon_r = 40.7$, $\rho = 1000$ kg/m³)

Phantom section: Left Section

Test Date: 01/26/2004; Ambient Temp: 22.4 Ć; Tissue Temp:21.8 Ć

Probe: ET3DV6 - SN1730;ConvF(6.2, 6.2, 6.2);Calibrated: 2003-12-16

Sensor-Surface: 4mm (Mechanical And Optical Surface Detection)

Electronics: DAE3 Sn531;Calibrated: 2003 -11 -20

Phantom: SAM 835;Type: SAM 4.0;Serial: TP-1151

Measurement SW: DASY4, V4.1 Build 47;Postprocessing SW: SEMCAD, V1.6 Build 115

CDMA 384 Left Head Tilt/Area Scan (71x101x1): Measurement grid: dx=15mm, dy=15mm

Reference Value = 28.9 V/m

Power Drift = -0.2 dB

Maximum value of SAR = 1.06 mW/g

CDMA 384 Left Head Tilt/Zoom Scan (7x7x7)/Cube 0: Measurement grid: dx=5mm, dy=5mm, dz=5mm

Peak SAR (extrapolated) = 2.06 W/kg

SAR(1 g) = 0.996 mW/g; SAR(10 g) = 0.529 mW/g

Reference Value = 28.9 V/m

Power Drift = -0.2 dB

Maximum value of SAR = 1.08 mW/g

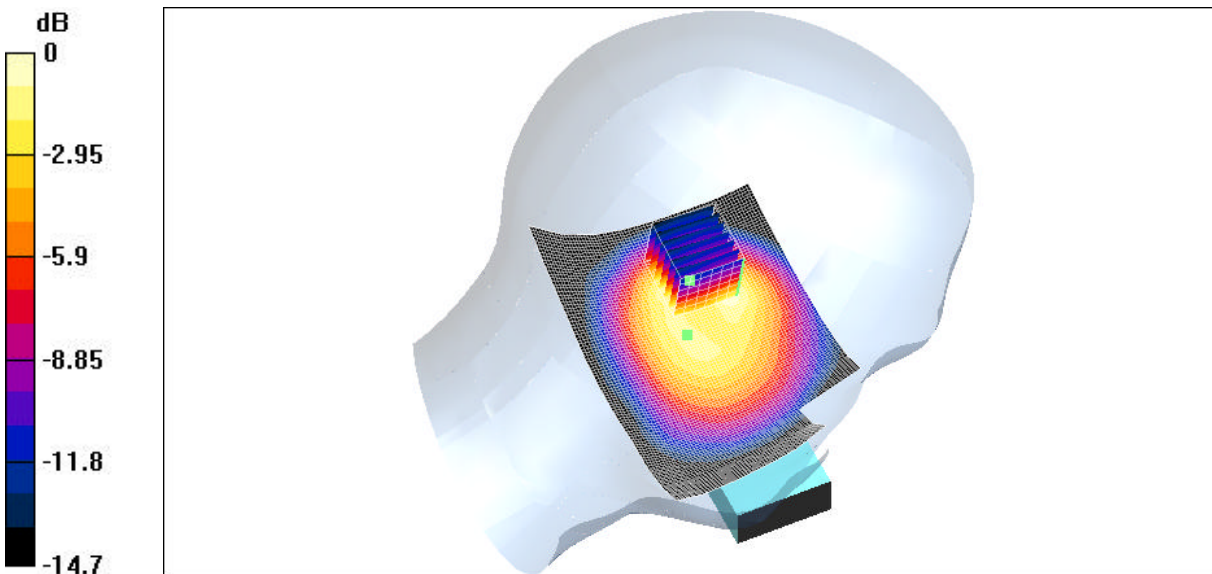

0 dB = 1.08mW/g

Test Laboratory: LG Electronics Inc.

DUT: LG-RD5130;Type: Single Band/Single Mode;Serial: #1 Hitachi Ant.

Program: LG-RD5130;CDMA Mode Ch: 384

Communication System: LG-RD5130;Frequency: 836.52 MHz;Duty Cycle: 1:1

Medium: Head 835 MHz; ($\sigma = 0.88$ mho/m, $\epsilon_r = 40.7$, $\rho = 1000$ kg/m³)

Phantom section: Right Section

Test Date: 01/26/2004; Ambient Temp: 22.4 Ć; Tissue Temp:21.8 Ć

Probe: ET3DV6 - SN1730;ConvF(6.2, 6.2, 6.2);Calibrated: 2003-12-16

Sensor-Surface: 4mm (Mechanical And Optical Surface Detection)

Electronics: DAE3 Sn531;Calibrated: 2003 -11 -20

Phantom: SAM 835;Type: SAM 4.0;Serial: TP-1151

Measurement SW: DASY4, V4.1 Build 47;Postprocessing SW: SEMCAD, V1.6 Build 115

CDMA 384 Right Head Touch/Area Scan (61x91x1): Measurement grid: dx=15mm, dy=15mm

Reference Value = 32.8 V/m

Power Drift = -0.1 dB

Maximum value of SAR = 1.2 mW/g

CDMA 384 Right Head Touch/Zoom Scan (7x7x7)/Cube 0: Measurement grid: dx=5mm, dy=5mm, dz=5mm

Peak SAR (extrapolated) = 1.8 W/kg

SAR(1 g) = 1.04 mW/g; SAR(10 g) = 0.637 mW/g

Reference Value = 32.8 V/m

Power Drift = -0.1 dB

Maximum value of SAR = 1.13 mW/g

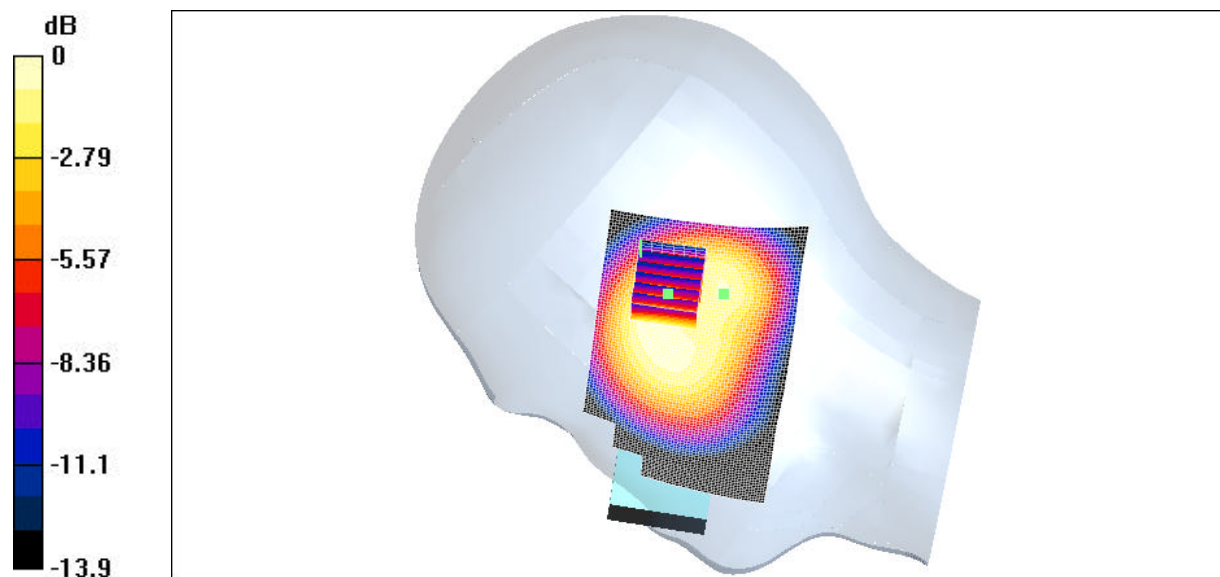

0 dB = 1.13mW/g

Test Laboratory: LG Electronics Inc.

DUT: LG-RD5130;Type: Single Band/Single Mode;Serial: #1 Hitachi Ant.

Program: LG-RD5130;CDMA Mode Ch: 384

Communication System: LG-RD5130;Frequency: 836.52 MHz;Duty Cycle: 1:1

Medium: Head 835 MHz; ($\sigma = 0.88$ mho/m, $\epsilon_r = 40.7$, $\rho = 1000$ kg/m³)

Phantom section: Right Section

Test Date: 01/26/2004; Ambient Temp: 22.4 Ć; Tissue Temp:21.8 Ć

Probe: ET3DV6 - SN1730;ConvF(6.2, 6.2, 6.2);Calibrated: 2003-12-16

Sensor-Surface: 4mm (Mechanical And Optical Surface Detection)

Electronics: DAE3 Sn531;Calibrated: 2003 -11 -20

Phantom: SAM 835;Type: SAM 4.0;Serial: TP-1151

Measurement SW: DASY4, V4.1 Build 47;Postprocessing SW: SEMCAD, V1.6 Build 115

CDMA 384 Right Head Tilt/Area Scan (71x101x1): Measurement grid: dx=15mm, dy=15mm

Reference Value = 29.6 V/m

Power Drift = -0.2 dB

Maximum value of SAR = 0.849 mW/g

CDMA 384 Right Head Tilt/Zoom Scan (7x7x7)/Cube 0: Measurement grid: dx=5mm, dy=5mm, dz=5mm

Peak SAR (extrapolated) = 1.64 W/kg

SAR(1 g) = 0.826 mW/g; SAR(10 g) = 0.445 mW/g

Reference Value = 29.6 V/m

Power Drift = -0.2 dB

Maximum value of SAR = 0.906 mW/g

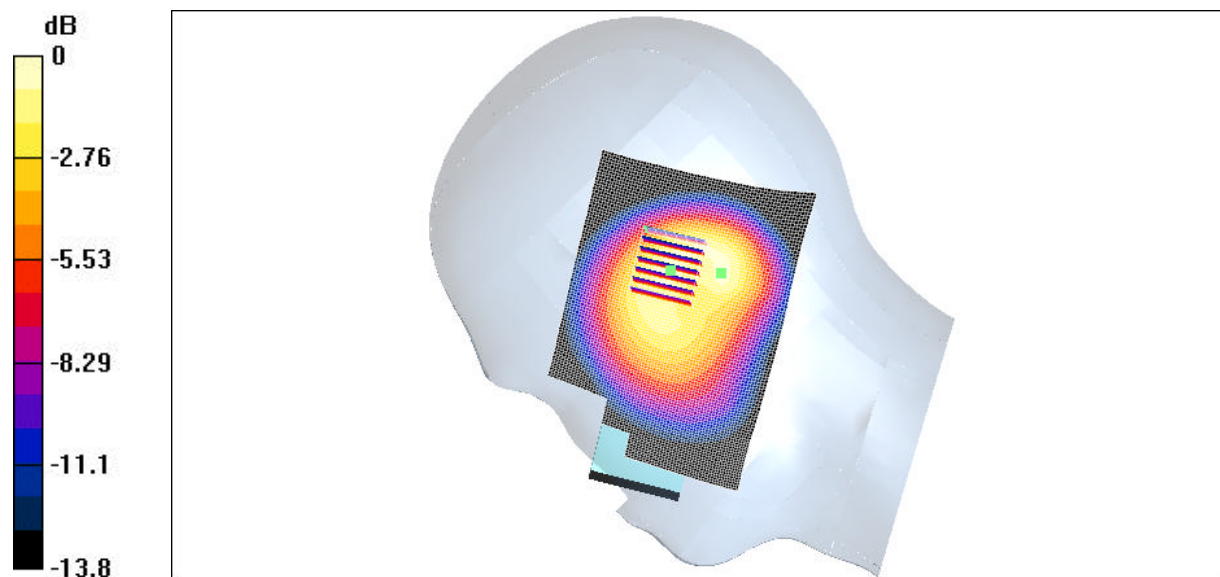

0 dB = 0.906mW/g

Test Laboratory: LG Electronics Inc.

DUT: LG-RD5130;Type: Single Band/Single Mode;Serial: #1 Hitachi Ant.

Program: LG-RD5130;CDMA Mode Ch: 384

Communication System: LG-RD5130;Frequency: 836.52 MHz;Duty Cycle: 1:1

Medium: Head 835 MHz; ($\sigma = 0.96$ mho/m, $\epsilon_r = 55.3$, $\rho = 1000$ kg/m³)

Phantom section: Flat Section

Test Date: 01/27/2004; Ambient Temp: 22.7 Ć; Tissue Temp:21.8 Ć

Probe: ET3DV6 - SN1730;ConvF(6.2, 6.2, 6.2);Calibrated: 2003-12-16

Sensor-Surface: 4mm (Mechanical And Optical Surface Detection)

Electronics: DAE3 Sn531;Calibrated: 2003 -11 -20

Phantom: SAM 835;Type: SAM 4.0;Serial: TP-1151

Measurement SW: DASY4, V4.1 Build 47;Postprocessing SW: SEMCAD, V1.6 Build 115

CDMA 384 Body / Space = 1.5cm. /Area Scan (61x81x1): Measurement grid: dx=15mm, dy=15mm

Reference Value = 17.2 V/m

Power Drift = -0.07 dB

Maximum value of SAR = 0.557 mW/g

CDMA 384 Body / Space = 1.5cm. /Zoom Scan (7x7x7)/Cube 0: Measurement grid: dx=5mm, dy=5mm, dz=5mm

Peak SAR (extrapolated) = 0.696 W/kg

SAR(1 g) = 0.522 mW/g; SAR(10 g) = 0.366 mW/g

Reference Value = 17.2 V/m

Power Drift = -0.07 dB

Maximum value of SAR = 0.557 mW/g

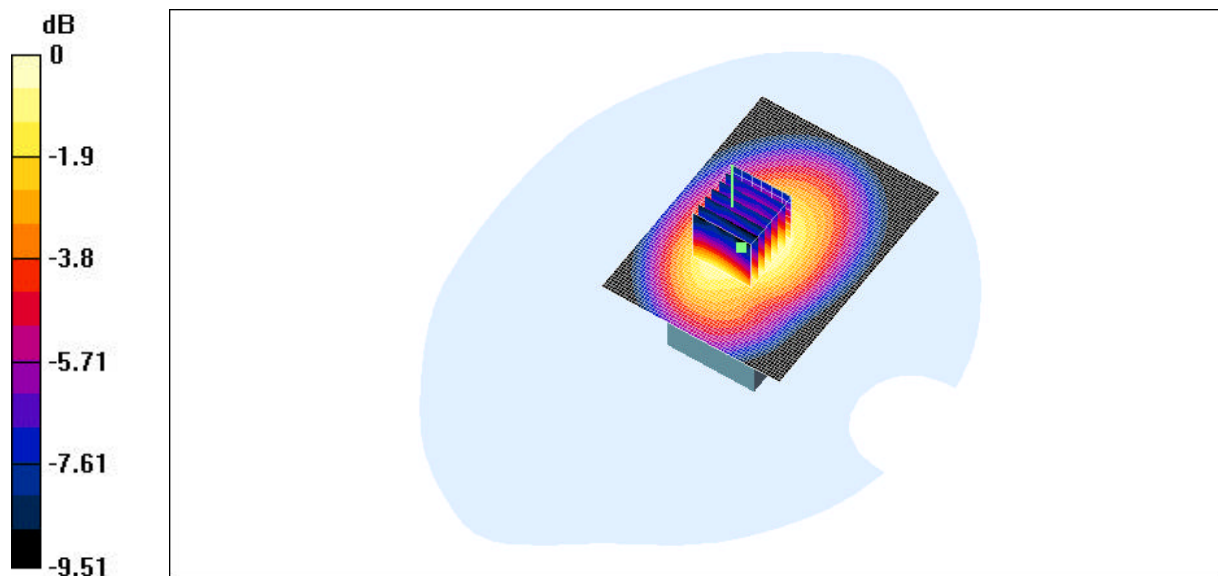

0 dB = 0.557mW/g

Test Laboratory: LG Electronics Inc.

DUT: LG-RD5130;Type: Single Band/Single Mode;Serial: #1 Hitachi Ant.

Program: LG-RD5130;CDMA Mode Ch: 384

Communication System: LG-RD5130;Frequency: 836.52 MHz;Duty Cycle: 1:1

Medium: Head 835 MHz; ($\sigma = 0.88$ mho/m, $\epsilon_r = 40.7$, $\rho = 1000$ kg/m³)

Phantom section: Right Section

Test Date: 01/26/2004; Ambient Temp: 22.4 °C; Tissue Temp: 21.8 °C

Probe: ET3DV6 - SN1730;ConvF(6.2, 6.2, 6.2);Calibrated: 2003-12-16

Sensor-Surface: 4mm (Mechanical And Optical Surface Detection)

Electronics: DAE3 Sn531;Calibrated: 2003-11-20

Phantom: SAM 835;Type: SAM 4.0;Serial: TP-1151

Measurement SW: DASY4, V4.1 Build 47;Postprocessing SW: SEMCAD, V1.6 Build 115

CDMA 384 Right Head Touch/Area Scan (61x91x1): Measurement grid: dx=15mm, dy=15mm

Reference Value = 32.8 V/m

Power Drift = -0.1 dB

Maximum value of SAR = 1.2 mW/g

CDMA 384 Right Head Touch/Zoom Scan (7x7x7)/Cube 0: Measurement grid: dx=5mm, dy=5mm, dz=5mm

Peak SAR (extrapolated) = 1.8 W/kg

SAR(1 g) = 1.04 mW/g; SAR(10 g) = 0.637 mW/g

Reference Value = 32.8 V/m

Power Drift = -0.1 dB

Maximum value of SAR = 1.13 mW/g

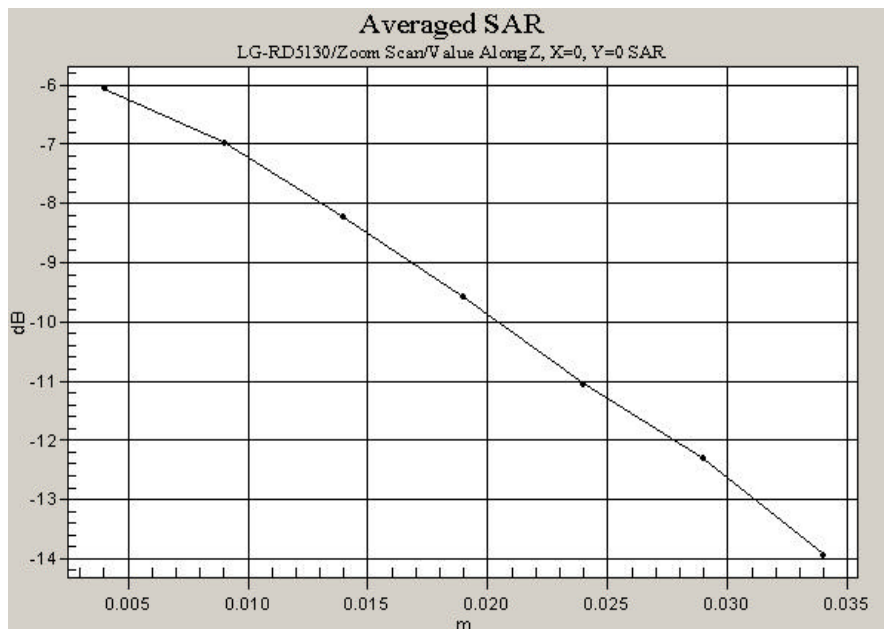

Test Laboratory: LG Electronics Inc.

DUT: LG-RD5130;Type: Single Band/Single Mode;Serial: #1 Hitachi Ant.

Program: LG-RD5130;CDMA Mode Ch: 384

Communication System: LG-RD5130;Frequency: 836.52 MHz;Duty Cycle: 1:1

Medium: Head 835 MHz; ($\sigma = 0.96$ mho/m, $\epsilon_r = 55.3$, $\rho = 1000$ kg/m³)

Phantom section: Flat Section

Test Date: 01/27/2004; Ambient Temp: 22.7 Ć; Tissue Temp:21.8 Ć

Probe: ET3DV6 - SN1730;ConvF(6.2, 6.2, 6.2);Calibrated: 2003-12-16

Sensor-Surface: 4mm (Mechanical And Optical Surface Detection)

Electronics: DAE3 Sn531;Calibrated: 2003 -11 -20

Phantom: SAM 835;Type: SAM 4.0;Serial: TP-1151

Measurement SW: DASY4, V4.1 Build 47;Postprocessing SW: SEMCAD, V1.6 Build 115

CDMA 384 Body / Space = 1.5cm. /Area Scan (61x81x1): Measurement grid: dx=15mm, dy=15mm

Reference Value = 17.2 V/m

Power Drift = -0.07 dB

Maximum value of SAR = 0.557 mW/g

CDMA 384 Body / Space = 1.5cm. /Zoom Scan (7x7x7)/Cube 0: Measurement grid: dx=5mm, dy=5mm, dz=5mm

Peak SAR (extrapolated) = 0.696 W/kg

SAR(1 g) = 0.522 mW/g; SAR(10 g) = 0.366 mW/g

Reference Value = 17.2 V/m

Power Drift = -0.07 dB

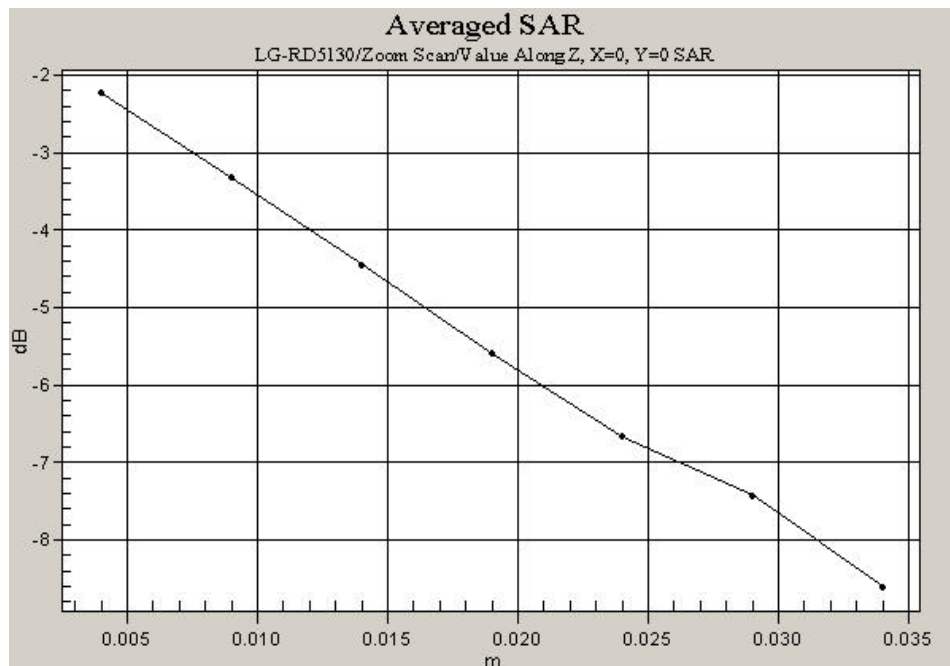

Maximum value of SAR = 0.557 mW/g



APPENDIX D : Calibration Certificates

**Calibration Laboratory of
 Schmid & Partner
 Engineering AG**
 Zeughausstrasse 43, 8004 Zurich, Switzerland

Client **LG (Dymstec)**

CALIBRATION CERTIFICATE			
Object(s)	ET3DV6 - SN:1730		
Calibration procedure(s)	QA CAL-01.v2 Calibration procedure for dosimetric E-field probes		
Calibration date:	December 16, 2003		
Condition of the calibrated item	In Tolerance (according to the specific calibration document)		
This calibration statement documents traceability of M&TE used in the calibration procedures and conformity of the procedures with the ISO/IEC 17025 international standard.			
All calibrations have been conducted in the closed laboratory facility: environment temperature 22 +/- 2 degrees Celsius and humidity < 75%.			
Calibration Equipment used (M&TE critical for calibration)			
Model Type	ID #	Cal Date (Calibrated by, Certificate No.)	Scheduled Calibration
Power meter EPM E4419B	GB41293874	2-Apr-03 (METAS, No 252-0250)	Apr-04
Power sensor E4412A	MY41495277	2-Apr-03 (METAS, No 252-0250)	Apr-04
Reference 20 dB Attenuator	SN: 5086 (20b)	3-Apr-03 (METAS No. 251-0340)	Apr-04
Fluke Process Calibrator Type 702	SN: 6295803	8-Sep-03 (Sintrel SCS No. E-030020)	Sep-04
Power sensor HP 8481A	MY41092180	18-Sep-02 (SPEAG, in house check Oct-03)	In house check: Oct 05
RF generator HP 8684C	US3642U01700	4-Aug-99 (SPEAG, in house check Aug-02)	In house check: Aug-05
Network Analyzer HP 8753E	US37390585	18-Oct-01 (SPEAG, in house check Oct-03)	In house check: Oct 05
Calibrated by:	Name Nico Vetterli	Function Technician	Signature 
Approved by:	Name Kolja Pokovic	Function Laboratory Director	Signature 
Date issued: December 16, 2003			
This calibration certificate is issued as an intermediate solution until the accreditation process (based on ISO/IEC 17025 International Standard) for Calibration Laboratory of Schmid & Partner Engineering AG is completed.			

Schmid & Partner Engineering AG

s p e a gZeughausstrasse 43, 8004 Zurich, Switzerland
Phone +41 1 245 9700, Fax +41 1 245 9779
info@speag.com, <http://www.speag.com>

Probe ET3DV6

SN:1730

Manufactured:	October 1, 2002
Last calibration:	November 20, 2002
Recalibrated:	December 16, 2003

Calibrated for DASY Systems

(Note: non-compatible with DASY2 system!)

ET3DV6 SN:1730

December 16, 2003

DASY - Parameters of Probe: ET3DV6 SN:1730
Sensitivity in Free Space

NormX	1.37 $\mu\text{V}/(\text{V}/\text{m})^2$
NormY	1.59 $\mu\text{V}/(\text{V}/\text{m})^2$
NormZ	1.75 $\mu\text{V}/(\text{V}/\text{m})^2$

Diode Compression

DCP X	94	mV
DCP Y	94	mV
DCP Z	94	mV

Sensitivity in Tissue Simulating Liquid

Head **900 MHz** $\epsilon_r = 41.5 \pm 5\%$ $\sigma = 0.97 \pm 5\%$ mho/m
 Valid for f=800-1000 MHz with Head Tissue Simulating Liquid according to EN 50361, P1528-200X

ConvF X	6.2 $\pm 9.5\%$ (k=2)	Boundary effect:
ConvF Y	6.2 $\pm 9.5\%$ (k=2)	Alpha 0.29
ConvF Z	6.2 $\pm 9.5\%$ (k=2)	Depth 2.87

Head **1800 MHz** $\epsilon_r = 40.0 \pm 5\%$ $\sigma = 1.40 \pm 5\%$ mho/m
 Valid for f=1710-1910 MHz with Head Tissue Simulating Liquid according to EN 50361, P1528-200X

ConvF X	5.1 $\pm 9.5\%$ (k=2)	Boundary effect:
ConvF Y	5.1 $\pm 9.5\%$ (k=2)	Alpha 0.44
ConvF Z	5.1 $\pm 9.5\%$ (k=2)	Depth 2.68

Boundary Effect

Head	900 MHz	Typical SAR gradient: 5 % per mm	
	Probe Tip to Boundary	1 mm	2 mm
	SAR _{be} [%] Without Correction Algorithm	9.2	5.5
	SAR _{be} [%] With Correction Algorithm	0.4	0.5

Head	1800 MHz	Typical SAR gradient: 10 % per mm	
	Probe Tip to Boundary	1 mm	2 mm
	SAR _{be} [%] Without Correction Algorithm	12.3	8.6
	SAR _{be} [%] With Correction Algorithm	0.2	0.3

Sensor Offset

Probe Tip to Sensor Center	2.7	mm
Optical Surface Detection	1.4 \pm 0.2	mm

ET3DV6 SN:1730

December 16, 2003

Receiving Pattern (ϕ), $\theta = 0^\circ$

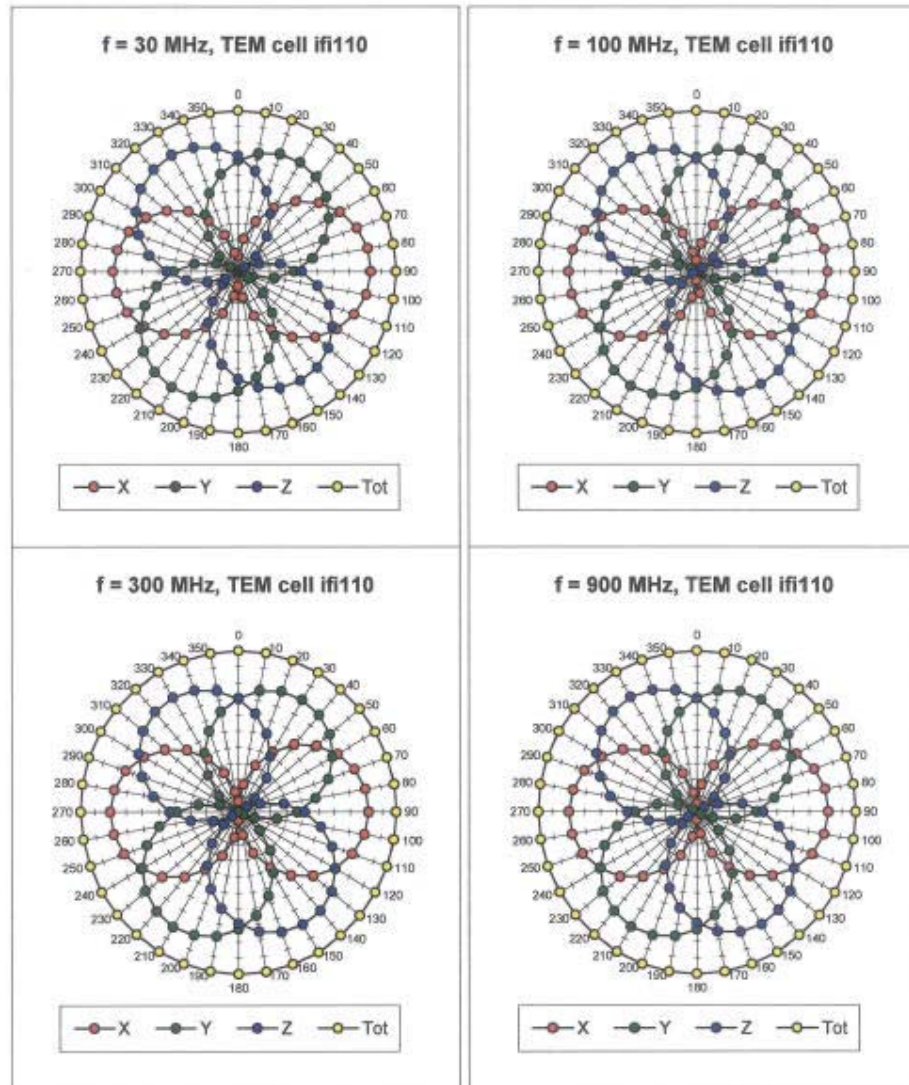

ET3DV6 SN:1730

December 16, 2003

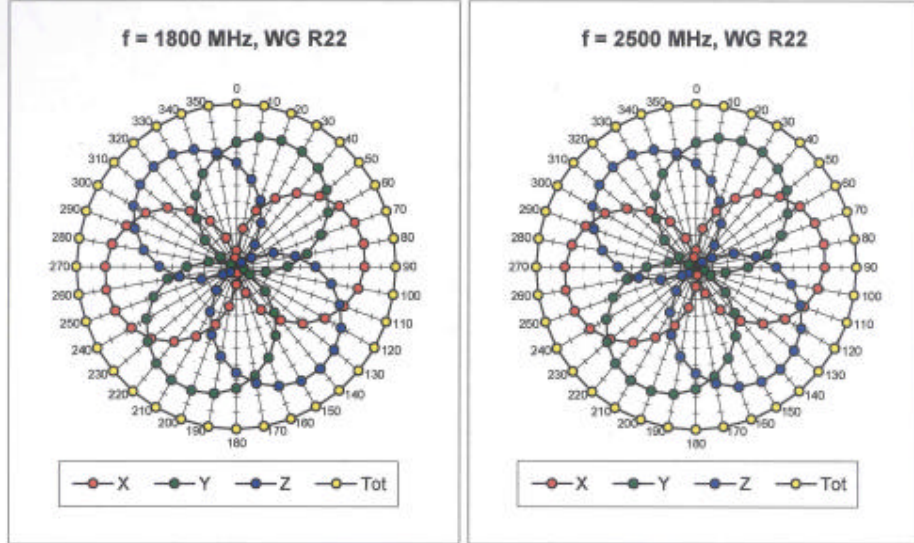

Isotropy Error (ϕ), $\theta = 0^\circ$

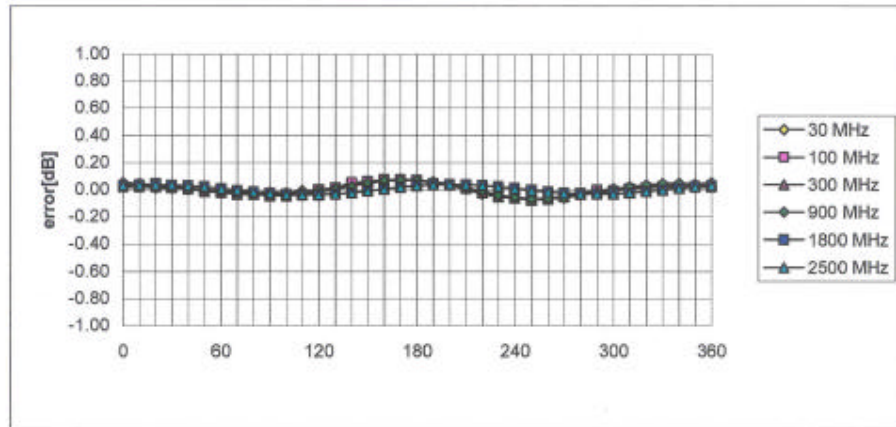

ET3DV6 SN:1730

December 16, 2003

Frequency Response of E-Field

(TEM-Cell:ifi110, Waveguide R22)

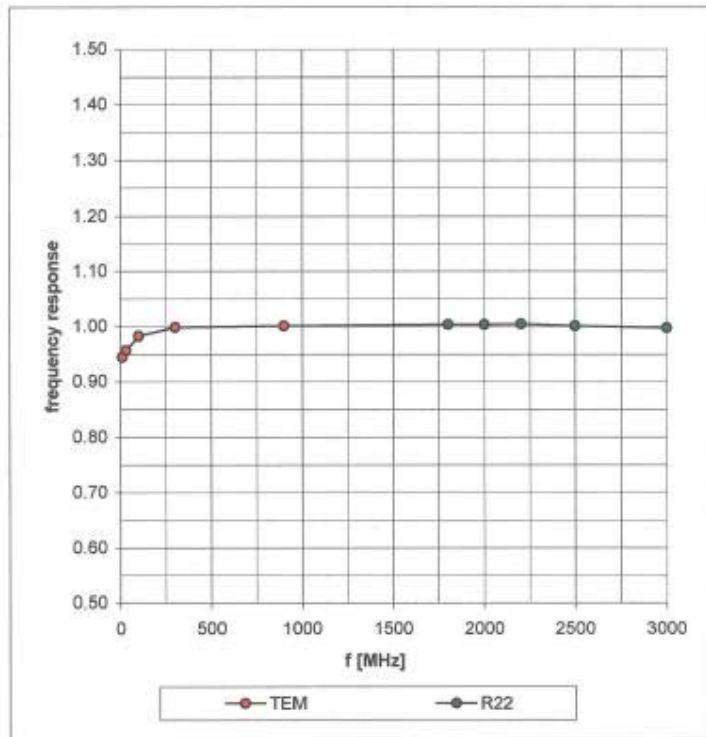

ET3DV6 SN:1730

December 16, 2003

Dynamic Range f(SAR_{brain})
 (Waveguide R22)

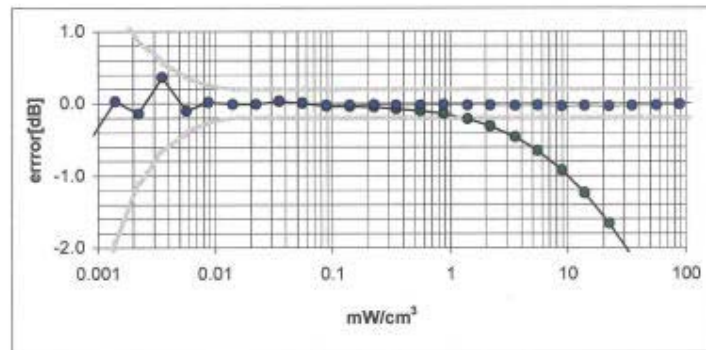
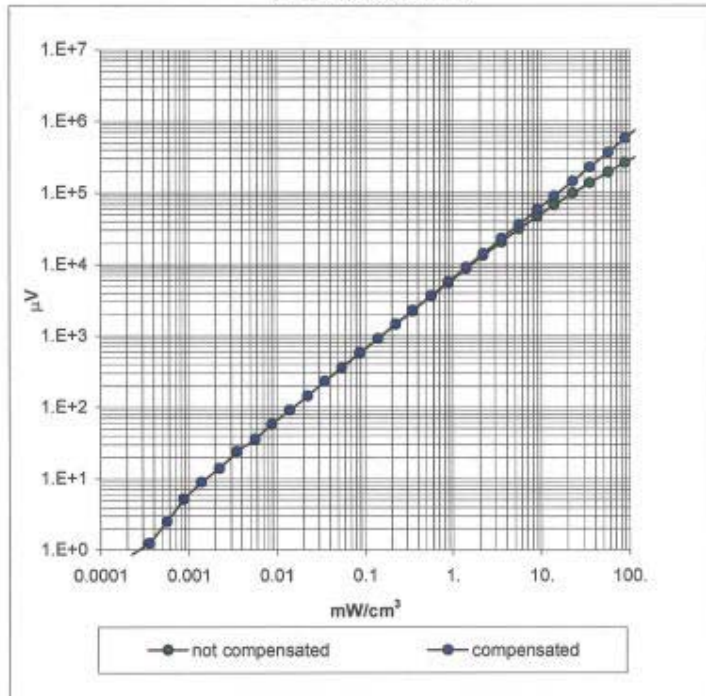

ET3DV6 SN:1730

December 16, 2003

Conversion Factor Assessment

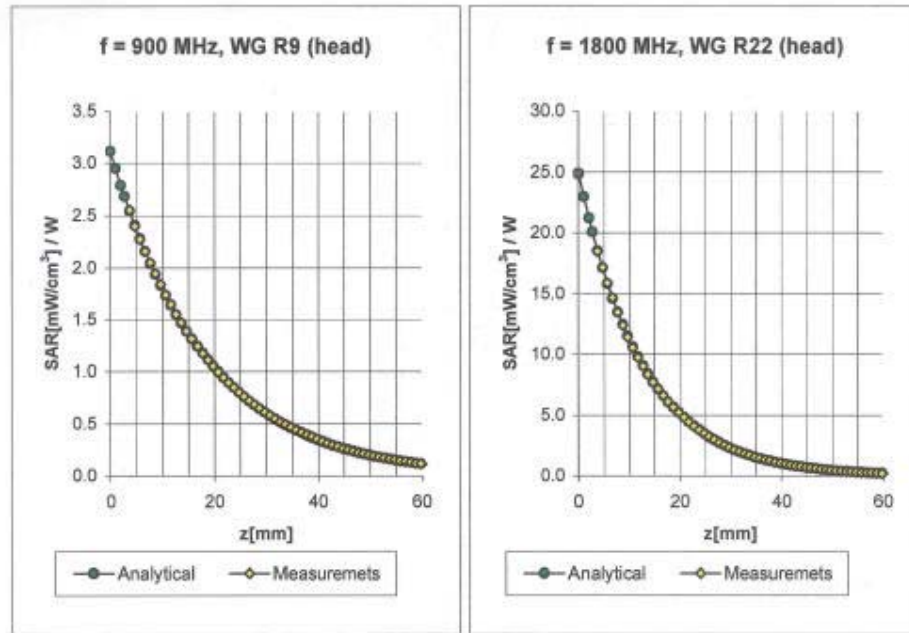

Head	900 MHz	$\epsilon_r = 41.5 \pm 5\%$	$\sigma = 0.97 \pm 5\% \text{ mho/m}$
Valid for f=800-1000 MHz with Head Tissue Simulating Liquid according to EN 50361, P1528-200X			
ConvF X	6.2	$\pm 9.5\%$ (k=2)	Boundary effect:
ConvF Y	6.2	$\pm 9.5\%$ (k=2)	Alpha 0.29
ConvF Z	6.2	$\pm 9.5\%$ (k=2)	Depth 2.87

Head	1800 MHz	$\epsilon_r = 40.0 \pm 5\%$	$\sigma = 1.40 \pm 5\% \text{ mho/m}$
Valid for f=1710-1910 MHz with Head Tissue Simulating Liquid according to EN 50361, P1528-200X			
ConvF X	5.1	$\pm 9.5\%$ (k=2)	Boundary effect:
ConvF Y	5.1	$\pm 9.5\%$ (k=2)	Alpha 0.44
ConvF Z	5.1	$\pm 9.5\%$ (k=2)	Depth 2.68

ET3DV6 SN:1730

December 16, 2003

Conversion Factor Assessment

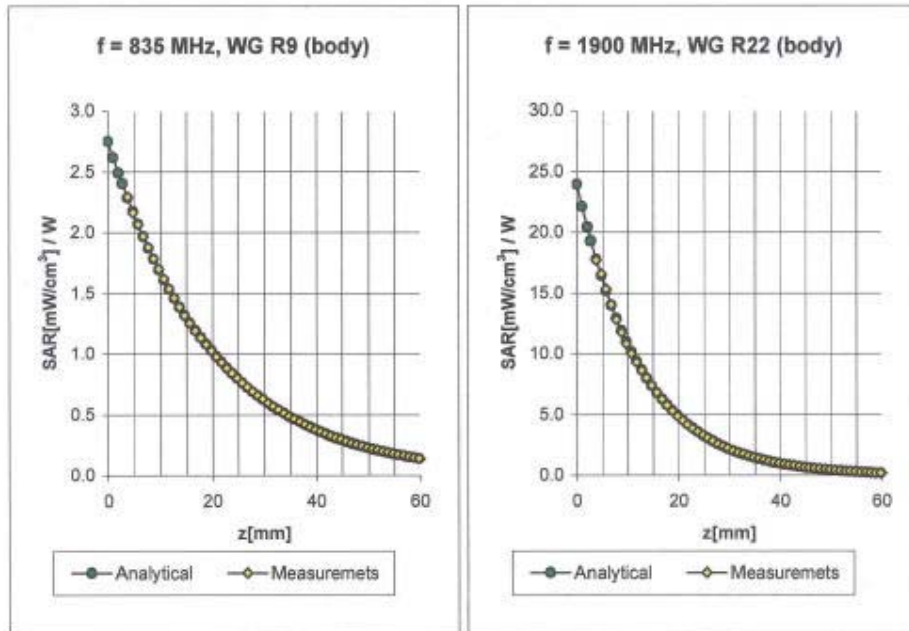

Body	835 MHz	$\epsilon_r = 55.2 \pm 5\%$	$\sigma = 0.97 \pm 5\% \text{ mho/m}$
-------------	----------------	-----------------------------	---------------------------------------

Valid for f=750-950 MHz with Body Tissue Simulating Liquid according to OET 65 Suppl. C

ConvF X	6.2 $\pm 9.5\%$ (k=2)	Boundary effect:
ConvF Y	6.2 $\pm 9.5\%$ (k=2)	Alpha 0.35
ConvF Z	6.2 $\pm 9.5\%$ (k=2)	Depth 2.52

Body	1900 MHz	$\epsilon_r = 53.3 \pm 5\%$	$\sigma = 1.52 \pm 5\% \text{ mho/m}$
-------------	-----------------	-----------------------------	---------------------------------------

Valid for f=1800-2000 MHz with Body Tissue Simulating Liquid according to OET 65 Suppl. C

ConvF X	4.4 $\pm 9.5\%$ (k=2)	Boundary effect:
ConvF Y	4.4 $\pm 9.5\%$ (k=2)	Alpha 0.62
ConvF Z	4.4 $\pm 9.5\%$ (k=2)	Depth 2.57

ET3DV6 SN:1730

December 16, 2003

Deviation from Isotropy in HSL

Error ($\theta\phi$), $f = 900$ MHz

