



CERTIFICATION TEST REPORT

Report Number. : 11724033-E4V6

Applicant : APPLE, INC.
1 INFINITE LOOP
CUPERTINO, CA 95014, U.S.A.

Model : A1898

FCC ID : BCG-E3173A

EUT Description : SMARTPHONE

Test Standard(s) : FCC 47 CFR PART 15 SUBPART E

Date Of Issue:

August 18, 2017

Prepared by:

UL Verification Services Inc.
47173 Benicia Street
Fremont, CA 94538, U.S.A.
TEL: (510) 771-1000
FAX: (510) 661-0888



NVLAP LAB CODE 200065-0

Revision History

<u>Rev.</u>	<u>Issue Date</u>	<u>Revisions</u>	<u>Revised By</u>
V1	7/14/2017	Initial Issue	Francisco Guarnero
V2	7/19/2017	Added Additional Worst Case config Info	Francisco Guarnero
V3	7/20/2017	Address TCB's questions	Chin pang
V4	7/21/2017	Addressed Additional TCB questions	Francisco Guarnero
V5	7/23/2017	Addressed Additional TCB questions	Francisco Guarnero
V6	7/25/2017	Addressed Additional TCB questions	Chin Pang

TABLE OF CONTENTS

1. ATTESTATION OF TEST RESULTS	12
2. TEST METHODOLOGY	13
3. FACILITIES AND ACCREDITATION	13
4. CALIBRATION AND UNCERTAINTY	14
4.1. MEASURING INSTRUMENT CALIBRATION	14
4.2. SAMPLE CALCULATION	14
4.3. MEASUREMENT UNCERTAINTY	14
5. EQUIPMENT UNDER TEST.....	15
5.1. DESCRIPTION OF EUT	15
5.2. MAXIMUM OUTPUT POWER	15
5.3. DESCRIPTION OF AVAILABLE ANTENNAS.....	18
5.4. SOFTWARE AND FIRMWARE	18
5.5. WORST-CASE CONFIGURATION AND MODE.....	19
5.6. DESCRIPTION OF TEST SETUP	21
6. TEST AND MEASUREMENT EQUIPMENT	27
7. ON TIME, DUTY CYCLE AND MEASUREMENT METHODS	28
7.1. ON TIME AND DUTY CYCLE.....	28
7.2. MEASUREMENT METHODS.....	32
8. ANTENNA PORT TEST RESULTS.....	33
8.1. 11n HT20 UAT 2 SISO MODE IN THE 5.2GHz BAND	33
8.1.1. 26 dB BANDWIDTH	33
8.1.2. 99% BANDWIDTH.....	36
8.1.3. AVERAGE POWER.....	39
8.1.4. OUTPUT POWER AND PPSD	40
8.2. 11n HT20 LAT 3 SISO MODE IN THE 5.2GHz BAND.....	44
8.2.1. 26 dB BANDWIDTH	44
8.2.2. 99% BANDWIDTH.....	47
8.2.3. AVERAGE POWER.....	50
8.2.4. OUTPUT POWER AND PPSD	51
8.3. 11n HT20 2TX CDD MIMO MODE IN THE 5.2GHz BAND	55
8.3.1. 26 dB BANDWIDTH	55
8.3.2. 99% BANDWIDTH.....	59
8.3.3. AVERAGE POWER.....	63
8.3.4. OUTPUT POWER AND PPSD	64
8.4. 11n HT40 UAT 2 SISO MODE IN THE 5.2GHz BAND	70

8.4.1.	26 dB BANDWIDTH	70
8.4.2.	99% BANDWIDTH.....	72
8.4.3.	AVERAGE POWER.....	74
8.4.4.	OUTPUT POWER AND PPSD	75
8.5.	<i>11n HT40 LAT 3 SISO MODE IN THE 5.2GHz BAND</i>	78
8.5.1.	26 dB BANDWIDTH	78
8.5.2.	99% BANDWIDTH.....	80
8.5.3.	AVERAGE POWER.....	82
8.5.4.	OUTPUT POWER AND PPSD	83
8.6.	<i>11n HT40 2TX CDD MIMO MODE IN THE 5.2GHz BAND</i>	86
8.6.1.	26 dB BANDWIDTH	86
8.6.2.	99% BANDWIDTH.....	89
8.6.3.	AVERAGE POWER.....	92
8.6.4.	OUTPUT POWER AND PPSD	93
8.7.	<i>11ac HT80 UAT 2 SISO MODE IN THE 5.2GHz BAND</i>	98
8.7.1.	26 dB BANDWIDTH	98
8.7.2.	99% BANDWIDTH.....	99
8.7.3.	AVERAGE POWER.....	100
8.7.4.	OUTPUT POWER AND PPSD	101
8.8.	<i>11ac HT80 LAT 3 SISO MODE IN THE 5.2GHz BAND</i>	104
8.8.1.	26 dB BANDWIDTH	104
8.8.2.	99% BANDWIDTH.....	105
8.8.3.	AVERAGE POWER.....	106
8.8.4.	OUTPUT POWER AND PPSD	107
8.9.	<i>11ac HT80 2TX CDD MIMO MODE IN THE 5.2GHz BAND</i>	110
8.9.1.	26 dB BANDWIDTH	110
8.9.2.	99% BANDWIDTH.....	112
8.9.3.	AVERAGE POWER.....	114
8.9.4.	OUTPUT POWER AND PPSD	115
8.10.	<i>11n HT20 UAT 2 SISO MODE IN THE 5.3GHz BAND</i>	119
8.10.1.	26 dB BANDWIDTH.....	119
8.10.2.	99% BANDWIDTH.....	122
8.10.3.	AVERAGE POWER	125
8.10.4.	OUTPUT POWER AND PPSD.....	126
8.11.	<i>11n HT20 LAT 3 SISO MODE IN THE 5.3GHz BAND</i>	130
8.11.1.	26 dB BANDWIDTH.....	130
8.11.2.	99% BANDWIDTH.....	133
8.11.3.	AVERAGE POWER	136
8.11.4.	OUTPUT POWER AND PPSD.....	137
8.12.	<i>11n HT20 2TX CDD MIMO MODE IN THE 5.3GHz BAND</i>	141
8.12.1.	26 dB BANDWIDTH.....	141
8.12.2.	99% BANDWIDTH.....	145
8.12.3.	AVERAGE POWER	149
8.12.4.	OUTPUT POWER AND PPSD.....	150
8.13.	<i>11n HT40 UAT 2 SISO MODE IN THE 5.3GHz BAND</i>	155
8.13.1.	26 dB BANDWIDTH.....	155
8.13.2.	99% BANDWIDTH.....	157
8.13.3.	AVERAGE POWER	159
8.13.4.	OUTPUT POWER AND PPSD.....	160

8.14.	11n HT40 LAT 3 SISO MODE IN THE 5.3GHz BAND	163
8.14.1.	26 dB BANDWIDTH.....	163
8.14.2.	99% BANDWIDTH.....	165
8.14.3.	AVERAGE POWER.....	167
8.14.4.	OUTPUT POWER AND PPSD.....	168
8.15.	11n HT40 2TX CDD MIMO MODE IN THE 5.3GHz BAND.....	171
8.15.1.	26 dB BANDWIDTH.....	171
8.15.2.	99% BANDWIDTH.....	174
8.15.3.	AVERAGE POWER.....	177
8.15.4.	OUTPUT POWER AND PPSD.....	178
8.16.	11ac HT80 UAT 2 SISO MODE IN THE 5.3GHz BAND	182
8.16.1.	26 dB BANDWIDTH.....	182
8.16.2.	99% BANDWIDTH.....	184
8.16.3.	AVERAGE POWER.....	186
8.16.4.	OUTPUT POWER AND PPSD.....	187
8.17.	11ac HT80 LAT 3 SISO MODE IN THE 5.3GHz BAND.....	190
8.17.1.	26 dB BANDWIDTH.....	190
8.17.2.	99% BANDWIDTH.....	192
8.17.3.	AVERAGE POWER.....	194
8.17.4.	OUTPUT POWER AND PPSD.....	195
8.18.	11ac HT80 2TX CDD MIMO MODE IN THE 5.3GHz BAND.....	198
8.18.1.	26 dB BANDWIDTH.....	198
8.18.2.	99% BANDWIDTH.....	200
8.18.3.	AVERAGE POWER.....	202
8.18.4.	OUTPUT POWER AND PPSD.....	203
8.19.	11n HT20 UAT 2 SISO MODE IN THE 5.6GHz BAND (5700MHz OBW low).....	206
8.19.1.	26 dB BANDWIDTH.....	206
8.19.2.	99% BANDWIDTH.....	210
8.19.3.	AVERAGE POWER.....	214
8.19.4.	OUTPUT POWER AND PPSD.....	215
8.20.	11ac HT20 UAT 2 SISO STRADDLE CHANNEL 144	220
8.20.1.	OUTPUT POWER AND PPSD.....	220
8.20.2.	6 dB BANDWIDTH.....	224
8.21.	11n HT20 LAT 3 SISO MODE IN THE 5.6GHz BAND	225
8.21.1.	26 dB BANDWIDTH.....	225
8.21.2.	99% BANDWIDTH.....	229
8.21.3.	AVERAGE POWER.....	233
8.21.4.	OUTPUT POWER AND PPSD.....	234
8.22.	11ac HT20 LAT 3 SISO STRADDLE CHANNEL 144.....	239
8.22.1.	OUTPUT POWER AND PPSD.....	239
8.22.2.	6 dB BANDWIDTH.....	243
8.23.	11n HT20 2TX CDD MIMO MODE IN THE 5.6GHz BAND.....	244
8.23.1.	26 dB BANDWIDTH.....	244
8.23.2.	99% BANDWIDTH.....	251
8.23.3.	AVERAGE POWER.....	258
8.23.4.	OUTPUT POWER AND PPSD.....	259
8.24.	11ac HT20 2TX CDD MIMO STRADDLE CHANNEL 144.....	265
8.24.1.	OUTPUT POWER AND PPSD.....	265

8.24.2.	6 dB BANDWIDTH.....	271
8.25.	<i>11n HT40 UAT 2 SISO MODE IN THE 5.6GHz BAND.....</i>	<i>273</i>
8.25.1.	26 dB BANDWIDTH.....	273
8.25.2.	99% BANDWIDTH.....	277
8.25.3.	AVERAGE POWER.....	281
8.25.4.	OUTPUT POWER AND PPSD.....	282
8.26.	<i>11ac HT40 UAT 2 SISO STRADDLE CHANNEL 142.....</i>	<i>287</i>
8.26.1.	OUTPUT POWER AND PPSD.....	287
8.26.2.	6 dB BANDWIDTH.....	291
8.27.	<i>11n HT40 LAT 3 SISO MODE IN THE 5.6GHz BAND.....</i>	<i>292</i>
8.27.1.	26 dB BANDWIDTH.....	292
8.27.2.	99% BANDWIDTH.....	296
8.27.3.	AVERAGE POWER.....	300
8.27.4.	OUTPUT POWER AND PPSD.....	301
8.28.	<i>11ac HT40 LAT 3 SISO STRADDLE CHANNEL 142.....</i>	<i>306</i>
8.28.1.	OUTPUT POWER AND PPSD.....	306
8.28.2.	6 dB BANDWIDTH.....	310
8.29.	<i>11n HT40 2TX CDD MIMO MODE IN THE 5.6GHz BAND.....</i>	<i>311</i>
8.29.1.	26 dB BANDWIDTH.....	311
8.29.2.	99% BANDWIDTH.....	318
8.29.3.	AVERAGE POWER.....	325
8.29.4.	OUTPUT POWER AND PPSD.....	326
8.30.	<i>11ac HT40 2TX CDD MIMO STRADDLE CHANNEL 142.....</i>	<i>333</i>
8.30.1.	OUTPUT POWER AND PSD.....	333
8.30.2.	6 dB BANDWIDTH.....	339
8.31.	<i>11ac HT80 UAT 2 SISO MODE IN THE 5.6GHz BAND.....</i>	<i>341</i>
8.31.1.	26 dB BANDWIDTH.....	341
8.31.2.	99% BANDWIDTH.....	344
8.31.3.	AVERAGE POWER.....	347
8.31.4.	OUTPUT POWER AND PSD.....	348
8.32.	<i>11ac HT80 UAT 2 SISO STRADDLE CHANNEL 138 RESULTS.....</i>	<i>351</i>
8.32.1.	OUTPUT POWER AND PSD.....	351
8.32.2.	6 dB BANDWIDTH.....	355
8.33.	<i>11ac HT80 LAT 3 SISO MODE IN THE 5.6GHz BAND.....</i>	<i>356</i>
8.33.1.	26 dB BANDWIDTH.....	356
8.33.2.	99% BANDWIDTH.....	359
8.33.3.	AVERAGE POWER.....	362
8.33.4.	OUTPUT POWER AND PSD.....	363
8.34.	<i>11ac HT80 LAT 3 SISO STRADDLE CHANNEL 138 RESULTS.....</i>	<i>366</i>
8.34.1.	OUTPUT POWER AND PSD.....	366
8.34.2.	6 dB BANDWIDTH.....	370
8.35.	<i>11ac HT80 2TX CDD MIMO MODE IN THE 5.6GHz BAND.....</i>	<i>371</i>
8.35.1.	26 dB BANDWIDTH.....	371
8.35.2.	99% BANDWIDTH.....	375
8.35.3.	AVERAGE POWER.....	379
8.35.4.	OUTPUT POWER AND PSD.....	380
8.36.	<i>11ac HT80 2TX CDD MIMO STRADDLE CHANNEL 138 RESULTS.....</i>	<i>384</i>

8.36.1.	OUTPUT POWER AND PSD	384
8.36.2.	6 dB BANDWIDTH.....	390
8.37.	<i>11n HT20 UAT 2 SISO MODE IN THE 5.8GHz BAND.....</i>	<i>392</i>
8.37.1.	6 dB BANDWIDTH.....	392
8.37.2.	26 dB BANDWIDTH.....	395
8.37.3.	99% BANDWIDTH.....	398
8.37.4.	AVERAGE POWER.....	401
8.37.5.	OUTPUT POWER.....	402
8.37.6.	POWER SPECTRAL DENSITY	403
8.38.	<i>11n HT20 LAT 3 SISO MODE IN THE 5.8GHz BAND</i>	<i>406</i>
8.38.1.	6 dB BANDWIDTH.....	406
8.38.2.	26 dB BANDWIDTH.....	409
8.38.3.	99% BANDWIDTH.....	412
8.38.4.	AVERAGE POWER.....	415
8.38.5.	OUTPUT POWER.....	416
8.38.6.	POWER SPECTRAL DENSITY	417
8.39.	<i>11n HT20 2TX CDD MIMO MODE IN THE 5.8GHz BAND.....</i>	<i>420</i>
8.39.1.	6 dB BANDWIDTH.....	420
8.39.2.	26 dB BANDWIDTH.....	424
8.39.3.	99% BANDWIDTH.....	428
8.39.4.	AVERAGE POWER.....	432
8.39.5.	OUTPUT POWER.....	433
8.39.6.	POWER SPECTRAL DENSITY	434
8.40.	<i>11n HT40 UAT 2 SISO MODE IN THE 5.8GHz BAND.....</i>	<i>438</i>
8.40.1.	6 dB BANDWIDTH.....	438
8.40.2.	26 dB BANDWIDTH.....	440
8.40.3.	99% BANDWIDTH.....	442
8.40.4.	AVERAGE POWER.....	444
8.40.5.	OUTPUT POWER.....	445
8.40.6.	POWER SPECTRAL DENSITY	446
8.41.	<i>11n HT40 LAT 3 SISO MODE IN THE 5.8Gz BAND.....</i>	<i>448</i>
8.41.1.	6 dB BANDWIDTH.....	448
8.41.2.	26 dB BANDWIDTH.....	450
8.41.3.	99% BANDWIDTH.....	452
8.41.4.	AVERAGE POWER.....	454
8.41.5.	OUTPUT POWER.....	455
8.41.6.	POWER SPECTRAL DENSITY	456
8.42.	<i>11n HT40 2TX CDD MIMO MODE IN THE 5.8GHz BAND.....</i>	<i>458</i>
8.42.1.	6 dB BANDWIDTH.....	458
8.42.2.	26 dB BANDWIDTH.....	461
8.42.3.	99% BANDWIDTH.....	464
8.42.4.	AVERAGE POWER.....	467
8.42.5.	OUTPUT POWER.....	468
8.42.6.	POWER SPECTRAL DENSITY	469
8.43.	<i>11ac HT80 UAT 2 SISO MODE IN THE 5.8GHz BAND.....</i>	<i>472</i>
8.43.1.	6 dB BANDWIDTH.....	472
8.43.2.	26 dB BANDWIDTH.....	473
8.43.3.	99% BANDWIDTH.....	474
8.43.4.	AVERAGE POWER.....	475
8.43.5.	OUTPUT POWER.....	476

8.43.6.	POWER SPECTRAL DENSITY	477
8.44.	<i>11ac HT80 LAT 3 SISO MODE IN THE 5.8GHz BAND</i>	479
8.44.1.	6 dB BANDWIDTH.....	479
8.44.2.	26 dB BANDWIDTH.....	480
8.44.3.	99% BANDWIDTH.....	481
8.44.4.	AVERAGE POWER.....	482
8.44.5.	OUTPUT POWER.....	483
8.44.6.	POWER SPECTRAL DENSITY	484
8.45.	<i>11ac HT80 2TX CDD MIMO MODE IN THE 5.8GHz BAND</i>	486
8.45.1.	6 dB BANDWIDTH.....	486
8.45.2.	26 dB BANDWIDTH.....	488
8.45.3.	99% BANDWIDTH.....	490
8.45.4.	AVERAGE POWER.....	492
8.45.5.	OUTPUT POWER.....	493
8.45.6.	POWER SPECTRAL DENSITY	494
9.	RADIATED TEST RESULTS	496
9.1.	<i>LIMITS AND PROCEDURE</i>	496
9.1.1.	11n HT20 UAT 2 SISO MODE IN THE 5.2GHz BAND	497
9.1.2.	11n HT20 LAT 3 SISO MODE IN THE 5.2GHz BAND.....	500
9.1.3.	11n HT20 2TX CDD MIMO MODE IN THE 5.2GHz BAND	503
9.1.4.	11n HT40 UAT 2 SISO MODE IN THE 5.2GHz BAND	511
9.1.5.	11n HT40 LAT 3 SISO MODE IN THE 5.2GHz BAND.....	514
9.1.6.	11n HT40 2TX CDD MIMO MODE IN THE 5.2GHz BAND	517
9.1.7.	11ac HT80 UAT 2 SISO MODE IN THE 5.2GHz BAND	523
9.1.8.	11ac HT80 LAT 3 SISO MODE IN THE 5.2GHz BAND	526
9.1.9.	11ac HT80 2TX CDD MIMO MODE IN THE 5.2GHz BAND	529
9.1.10.	11n HT20 UAT 2 SISO MODE IN THE 5.3GHz BAND.....	533
9.1.11.	11n HT20 LAT 3 SISO MODE IN THE 5.3GHz BAND	536
9.1.12.	11n HT20 2TX CDD MIMO MODE IN THE 5.3GHz BAND	539
9.1.13.	11n HT40 UAT 2 SISO MODE IN THE 5.3GHz BAND.....	547
9.1.14.	11n HT40 LAT 3 SISO MODE IN THE 5.3GHz BAND	550
9.1.15.	11n HT40 2TX CDD MIMO MODE IN THE 5.3GHz BAND	553
9.1.16.	11ac HT80 UAT 2 SISO MODE IN THE 5.3GHz BAND.....	559
9.1.17.	11ac HT80 LAT 3 SISO MODE IN THE 5.3GHz BAND.....	562
9.1.18.	11ac HT80 2TX CDD MIMO MODE IN THE 5.3GHz BAND.....	565
9.1.19.	11n HT20 UAT 2 SISO MODE IN THE 5.6GHz BAND.....	569
9.1.20.	11ac HT20 UAT 2 SISO STRADDLE CHANNEL 144	578
9.1.21.	11n HT20 LAT 3 SISO MODE IN THE 5.6GHz BAND	579
9.1.22.	11ac HT20 LAT 3 SISO STRADDLE CHANNEL 144.....	587
9.1.23.	11n HT20 2TX CDD MIMO MODE IN THE 5.6GHz BAND	588
9.1.24.	11n HT20 2TX CDD MIMO STRADDLE CHANNEL 144.....	602
9.1.25.	11n HT40 UAT 2 SISO MODE IN THE 5.6GHz BAND.....	604
9.1.26.	11n HT40 UAT 2 SISO STRADDLE CHANNEL 142	608
9.1.27.	11n HT40 LAT 3 SISO MODE IN THE 5.6GHz BAND	609
9.1.28.	11n HT40 LAT 3 SISO STRADDLE CHANNEL 142.....	613
9.1.29.	11n HT40 2TX CDD MIMO MODE IN THE 5.6GHz BAND	614
9.1.30.	11n HT40 2TX CDD MIMO STRADDLE CHANNEL 142.....	624
9.1.31.	11ac HT40 2TX CDD MIMO STRADDLE CHANNEL 142.....	626
9.1.32.	11ac HT80 UAT 2 SISO MODE IN THE 5.6GHz BAND.....	628
9.1.33.	11ac HT80 UAT 2 SISO STRADDLE CHANNEL 138	630
9.1.34.	11ac HT80 LAT 3 SISO MODE IN THE 5.6GHz BAND.....	631

9.1.35.	11ac HT80 LAT 3 SISO STRADDLE CHANNEL 138	633
9.1.36.	11ac VHT80 2TX CDD MIMO MODE IN THE 5.6GHz BAND	634
9.1.37.	11ac HT80 2TX CDD MIMO STRADDLE CHANNEL 138	640
9.1.38.	11n HT20 UAT 2 SISO MODE IN THE 5.8GHz BAND	642
9.1.39.	11n HT20 LAT 3 SISO MODE IN THE 5.8GHz BAND	647
9.1.40.	11n HT20 2TX CDD MIMO MODE IN THE 5.8GHz BAND	652
9.1.41.	11n HT40 UAT 2 SISO MODE IN THE 5.8GHz BAND	662
9.1.42.	11n HT40 LAT 3 SISO MODE IN THE 5.8GHz BAND	667
9.1.43.	11n HT40 2TX CDD MIMO MODE IN THE 5.8GHz BAND	672
9.1.44.	11ac HT80 UAT 2 SISO MODE IN THE 5.8GHz BAND	680
9.1.45.	11ac HT80 LAT 3 SISO MODE IN THE 5.8GHz BAND	685
9.1.46.	11ac HT80 2TX CDD MIMO MODE IN THE 5.8GHz BAND	690
9.2.	<i>WORST-CASE BELOW 1 GHz</i>	696
9.3.	<i>WORST-CASE 18 to 26 GHz</i>	698
9.4.	<i>WORST-CASE 26 to 40 GHz</i>	700
10.	AC POWER LINE CONDUCTED EMISSIONS	702
10.1.	<i>EUT POWERED BY AC/DC ADAPTER VIA USB CABLE</i>	703
10.2.	<i>EUT POWERED BY HOST PC VIA USB CABLE</i>	705
11.	DYNAMIC FREQUENCY SELECTION	707
11.1.	<i>OVERVIEW</i>	707
11.1.1.	LIMITS	707
11.1.2.	TEST AND MEASUREMENT SYSTEM	711
11.1.3.	TEST ROOM ENVIRONMENT	713
11.1.4.	TEST AND MEASUREMENT SOFTWARE	713
11.1.5.	SETUP OF EUT (CLIENT MODE)	714
11.1.6.	SETUP OF EUT (CLIENT-TO-CLIENT COMMUNICATIONS MODE)	715
11.1.7.	SETUP OF EUT (PEER TO PEER MODE)	716
11.1.8.	DESCRIPTION OF EUT	718
11.2.	<i>CLIENT MODE RESULTS FOR 20 MHz BANDWIDTH</i>	720
11.2.1.	TEST CHANNEL	720
11.2.2.	RADAR WAVEFORM AND TRAFFIC	720
11.2.3.	OVERLAPPING CHANNEL TESTS	723
11.2.4.	MOVE AND CLOSING TIME	723
11.3.	<i>CLIENT MODE RESULTS FOR 40 MHz BANDWIDTH</i>	727
11.3.1.	TEST CHANNEL	727
11.3.2.	RADAR WAVEFORM AND TRAFFIC	727
11.3.3.	OVERLAPPING CHANNEL TESTS	730
11.3.4.	MOVE AND CLOSING TIME	730
11.4.	<i>CLIENT MODE RESULTS FOR 80 MHz BANDWIDTH</i>	734
11.4.1.	TEST CHANNEL	734
11.4.2.	RADAR WAVEFORM AND TRAFFIC	734
11.4.3.	OVERLAPPING CHANNEL TESTS	737
11.4.4.	MOVE AND CLOSING TIME	737
11.4.5.	30-MINUTE NON-OCCUPANCY PERIOD	741
11.5.	<i>CLIENT-TO-CLIENT COMMUNICATIONS MODE RESULTS FOR 20 MHz BANDWIDTH</i> 742	

11.5.1.	TEST CHANNEL.....	742
11.5.2.	RADAR WAVEFORM AND TRAFFIC.....	742
11.5.3.	OVERLAPPING CHANNEL TESTS.....	745
11.5.4.	MOVE AND CLOSING TIME	745
11.6.	<i>CLIENT-TO-CLIENT COMMUNICATIONS MODE RESULTS FOR 40 MHz BANDWIDTH</i> 749	
11.6.1.	TEST CHANNEL.....	749
11.6.2.	RADAR WAVEFORM AND TRAFFIC.....	749
11.6.3.	OVERLAPPING CHANNEL TESTS.....	752
11.6.4.	MOVE AND CLOSING TIME	752
11.7.	<i>CLIENT-TO-CLIENT COMMUNICATIONS MODE RESULTS FOR 80 MHz BANDWIDTH</i> 756	
11.7.1.	TEST CHANNEL.....	756
11.7.2.	RADAR WAVEFORM AND TRAFFIC.....	756
11.7.3.	OVERLAPPING CHANNEL TESTS.....	759
11.7.4.	MOVE AND CLOSING TIME	759
11.7.5.	30-MINUTE NON-OCCUPANCY PERIOD.....	763
11.8.	<i>PEER TO PEER MODE EUT RESULTS FOR 20 MHz BANDWIDTH.....</i>	764
11.8.1.	TEST CHANNEL.....	764
11.8.2.	RADAR WAVEFORM AND TRAFFIC.....	764
11.8.3.	OVERLAPPING CHANNEL TESTS.....	767
11.8.4.	MOVE AND CLOSING TIME	767
11.9.	<i>PEER TO PEER MODE EUT RESULTS FOR 40 MHz BANDWIDTH.....</i>	771
11.9.1.	TEST CHANNEL.....	771
11.9.2.	RADAR WAVEFORM AND TRAFFIC.....	771
11.9.3.	OVERLAPPING CHANNEL TESTS.....	774
11.9.4.	MOVE AND CLOSING TIME	774
11.10.	<i>PEER TO PEER MODE EUT RESULTS FOR 80 MHz BANDWIDTH.....</i>	778
11.10.1.	TEST CHANNEL.....	778
11.10.2.	RADAR WAVEFORM AND TRAFFIC.....	778
11.10.3.	OVERLAPPING CHANNEL TESTS.....	781
11.10.4.	MOVE AND CLOSING TIME	781
11.10.5.	30-MINUTE NON-OCCUPANCY PERIOD.....	785
11.11.	<i>PEER TO PEER MODE PEER SLAVE DEVICE RESULTS FOR 20 MHz BANDWIDTH</i>	786
11.11.1.	TEST CHANNEL.....	786
11.11.2.	RADAR WAVEFORM AND TRAFFIC.....	786
11.11.3.	OVERLAPPING CHANNEL TESTS.....	789
11.11.4.	MOVE AND CLOSING TIME	789
11.12.	<i>PEER TO PEER MODE PEER SLAVE DEVICE RESULTS FOR 40 MHz BANDWIDTH</i>	793
11.12.1.	TEST CHANNEL.....	793
11.12.2.	RADAR WAVEFORM AND TRAFFIC.....	793
11.12.3.	OVERLAPPING CHANNEL TESTS.....	796
11.12.4.	MOVE AND CLOSING TIME	796
11.13.	<i>PEER TO PEER MODE PEER SLAVE DEVICE RESULTS FOR 80 MHz BANDWIDTH</i>	800
11.13.1.	TEST CHANNEL.....	800
11.13.2.	RADAR WAVEFORM AND TRAFFIC.....	800
11.13.3.	OVERLAPPING CHANNEL TESTS.....	803
11.13.4.	MOVE AND CLOSING TIME	803
11.13.5.	30-MINUTE NON-OCCUPANCY PERIOD.....	807

12. SETUP PHOTOS..... 808

1. ATTESTATION OF TEST RESULTS

COMPANY NAME: APPLE, INC.
1 INFINITE LOOP
CUPERTINO, CA 95014, U.S.A.

EUT DESCRIPTION: SMARTPHONE

MODEL: A1898

SERIAL NUMBER: C39TQ005J6LP; DFS (C39TK03PJ31G)

DATE TESTED: MARCH 03, 2017 – JULY 21, 2017

APPLICABLE STANDARDS	
STANDARD	TEST RESULTS
CFR 47 Part 15 Subpart E	Pass

UL Verification Services Inc. tested the above equipment in accordance with the requirements set forth in the above standards. All indications of Pass/Fail in this report are opinions expressed by UL Verification Services Inc. based on interpretations and/or observations of test results. Measurement Uncertainties were not taken into account and are published for informational purposes only. The test results show that the equipment tested is capable of demonstrating compliance with the requirements as documented in this report.

Note: The results documented in this report apply only to the tested sample, under the conditions and modes of operation as described herein. This document may not be altered or revised in any way unless done so by UL Verification Services Inc. and all revisions are duly noted in the revisions section. Any alteration of this document not carried out by UL Verification Services Inc. will constitute fraud and shall nullify the document. This report must not be used by the client to claim product certification, approval, or endorsement by NVLAP, NIST, any agency of the Federal Government, or any agency of any government.

Approved & Released For
UL Verification Services Inc. By:

Prepared By:



CHIN PANG
SENIOR ENGINEER
UL VERIFICATION SERVICES INC.

TRI PHAM
LAB ENGINEER
UL VERIFICATION SERVICES INC.

2. TEST METHODOLOGY

The tests documented in this report were performed in accordance with FCC CFR 47 Part 2, FCC CFR 47 Part 15, FCC 14-30, FCC KDB 662911 D01 v02r01, FCC KDB 905462 D02 v02/D03 v01r02/D04 v01/D06 v02/ D07v02, FCC KDB 789033 D02 v01r04, FCC KDB 644545 D03 v01, ANSI C63.10-2013.

3. FACILITIES AND ACCREDITATION

The test sites and measurement facilities used to collect data are located at 47173 and 47266 Benicia Street, Fremont, California, USA. Line conducted emissions are measured only at the 47173 address. The following table identifies which facilities were utilized for radiated emission measurements documented in this report. Specific facilities are also identified in the test results sections.

47173 Benicia Street	47266 Benicia Street
<input type="checkbox"/> Chamber A (IC:2324B-1)	<input type="checkbox"/> Chamber D (IC: 22541-1)
<input type="checkbox"/> Chamber B (IC:2324B-2)	<input checked="" type="checkbox"/> Chamber E (IC: 22541-2)
<input type="checkbox"/> Chamber C (IC:2324B-3)	<input checked="" type="checkbox"/> Chamber F (IC: 22541-3)
	<input type="checkbox"/> Chamber G (IC: 22541-4)
	<input checked="" type="checkbox"/> Chamber H (IC: 22541-5)

The above test sites and facilities are covered under FCC Test Firm Registration # 208313.

UL Verification Services Inc. is accredited by NVLAP, Laboratory Code 200065-0. The full scope of accreditation can be viewed at <http://ts.nist.gov/standards/scopes/2000650.htm>.

4. CALIBRATION AND UNCERTAINTY

4.1. MEASURING INSTRUMENT CALIBRATION

The measuring equipment utilized to perform the tests documented in this report has been calibrated in accordance with the manufacturer's recommendations, and is traceable to recognized national standards.

4.2. SAMPLE CALCULATION

Where relevant, the following sample calculation is provided:

$$\text{Field Strength (dBuV/m)} = \text{Measured Voltage (dBuV)} + \text{Antenna Factor (dB/m)} + \text{Cable Loss (dB)} - \text{Preamp Gain (dB)}$$

$$36.5 \text{ dBuV} + 18.7 \text{ dB/m} + 0.6 \text{ dB} - 26.9 \text{ dB} = 28.9 \text{ dBuV/m}$$

4.3. MEASUREMENT UNCERTAINTY

Where relevant, the following measurement uncertainty levels have been estimated for tests performed on the apparatus:

Where relevant, the following measurement uncertainty levels have been estimated for tests performed on the apparatus:

Parameter	Uncertainty
Worst Case Conducted Disturbance, 9KHz to 0.15 MHz	3.84 dB
Worst Case Conducted Disturbance, 0.15 to 30 MHz	3.65 dB
Worst Case Radiated Disturbance, 9KHz to 30 MHz	3.15 dB
Worst Case Radiated Disturbance, 30 to 1000 MHz	5.36 dB
Worst Case Radiated Disturbance, 1000 to 18000 MHz	4.32 dB
Worst Case Radiated Disturbance, 18000 to 26000 MHz	4.45 dB
Worst Case Radiated Disturbance, 26000 to 40000 MHz	5.24 dB
Occupied Channel Bandwidth	±0.39 %
Time	±0.02 %

Uncertainty figures are valid to a confidence level of 95%.

5. EQUIPMENT UNDER TEST

5.1. DESCRIPTION OF EUT

The equipment under Test is a mobile phone with GSM, GPRS, EGPRS, UMTS, LTE and TD-SCDMA technologies. It also supports IEEE 802.11a/b/g/n/ac, Bluetooth®, GPS and NFC. The device has a built-in inductive charging receiver which is not user accessible. The rechargeable battery is not user accessible.

5.2. MAXIMUM OUTPUT POWER

The transmitter has a maximum conducted output power as follows:

NOTE: Covered modes are test reduction modes. The output powers on the “covered modes are equal to or less than the mode referenced and use the same modulation.

5.2GHz Band

Frequency Range (MHz)	Mode	Output Power (dBm)	Output Power (mW)
5180 - 5240	802.11a	Covered by 802.11n HT20 SISO	
	802.11n HT20 SISO	20.87	122.18
	802.11n VHT20 1TX	Covered by 802.11n HT20 SISO	
	802.11n HT20 CDD 2TX	20.91	123.31
	802.11n HT20 STBC/SDM 2TX, 802.11ac VHT20 STBC/SDM 2TX	Covered by 802.11n HT20 2TX CDD	
5190 - 5230	802.11n HT40 SISO	18.46	70.15
	802.11n VHT40 1TX	Covered by 802.11n HT20 SISO	
	802.11n HT40 CDD 2TX	21.41	138.36
	802.11n HT40 STBC/SDM 2TX, 802.11ac VHT40 STBC/SDM 2TX	Covered by 802.11n HT40 2TX CDD	
5210	802.11ac VHT80 SISO	14.99	31.55
	802.11ac VHT80 CDD 2TX	16.47	44.36
	802.11ac VHT80 STBC/SDM 2TX	Covered by 802.11ac VHT80 2TX CDD	

5.3GHz Band

Frequency Range (MHz)	Mode	Output Power (dBm)	Output Power (mW)
5260 - 5320	802.11a	Covered by 802.11n HT20 SISO	
	802.11n HT20 SISO	21.00	125.89
	802.11n VHT20 1TX	Covered by 802.11n HT20 SISO	
	802.11n HT20 CDD 2TX	20.87	122.18
	802.11n HT20 STBC/SDM 2TX, 802.11ac VHT20 STBC/SDM 2TX	Covered by 802.11n HT20 2TX CDD	
5270 - 5310	802.11n HT40 SISO	18.47	70.31
	802.11n VHT40 1TX	Covered by 802.11n HT40 SISO	
	802.11n HT40 CDD 2TX	21.50	141.25
	802.11n HT40 STBC/SDM 2TX, 802.11ac VHT40 STBC/SDM 2TX	Covered by 802.11n HT40 2TX CDD	
5290	802.11ac VHT80 SISO	14.98	31.48
	802.11ac VHT80 CDD 2TX	17.40	54.95
	802.11ac VHT80 STBC/SDM 2TX	Covered by 802.11ac HT80 2TX CDD	

5.6GHz Band

Frequency Range (MHz)	Mode	Output Power (dBm)	Output Power (mW)
5500 - 5700	802.11a	Covered by 802.11n HT20 SISO	
5500 - 5700	802.11n HT20 SISO	20.84	121.34
	802.11n VHT20 1TX	Covered by 802.11n HT20 SISO	
5720	802.11ac VHT20 SISO (based on UNII-2C band output power)	20.08	101.86
5500 - 5700	802.11n HT20 CDD 2TX	20.89	122.74
	802.11n HT20 STBC/SDM 2TX, 802.11ac VHT20 STBC/SDM 2TX	Covered by 802.11n HT20 CDD 2TX	
5720	802.11ac VHT20 CDD 2TX (based on UNII-2C band output power)	20.29	106.91
	802.11ac VHT20 STBC SISO/2TX (based on UNII-2C band output power)	Covered by 802.11n HT20 2TX CDD	
5510 - 5670	802.11n HT40 SISO	19.34	85.90
	802.11n HT40 1TX	Covered by 802.11n HT40 SISO	
5710	802.11ac VHT40 SISO (based on UNII-2C band output power)	18.19	65.92
5510 - 5670	802.11n HT40 CDD 2TX	22.33	171.00
	802.11n HT40 STBC/SDM 2TX, 802.11ac VHT40 STBC/SDM 2TX	Covered by 802.11n HT40 CDD 2TX	
5710	802.11ac VHT40 CDD 2TX (based on UNII-2C band output power)	21.66	146.55
	802.11ac VHT40 STBC/SDM 2TX	Covered by 802.11ac VHT40 CDD 2TX	
5530-5610	802.11ac VHT80 SISO	18.79	75.68
5690	802.11ac VHT80 SISO (based on UNII-2C band output power)	18.94	78.34
5530-5610	802.11ac VHT80 CDD 2TX	21.87	153.82
	802.11ac VHT80 STBC/SDM 2TX	Covered by 802.11ac VHT80 CDD 2TX	
5690	802.11ac VHT80 CDD 2TX (based on UNII-2C band output power)	22.13	163.31
	802.11ac VHT80 STBC/SDM 2TX	Covered by 802.11ac VHT80 CDD 2TX	

5.8GHz Band

Frequency Range (MHz)	Mode	Output Power (dBm)	Output Power (mW)
5745 - 5825	802.11a	Covered by 802.11n HT20 SISO	
	802.11n HT20 SISO	20.76	119.12
	802.11n VHT20 1TX	Covered by 802.11n HT20 SISO	
	802.11n HT20 CDD 2TX	23.80	239.88
	802.11n HT20 STBC/SDM 2TX, 802.11ac VHT20 STBC/SDM 2TX	Covered by 802.11n HT20 CDD 2TX	
5755 - 5795	802.11n HT40 SISO	19.43	87.70
	802.11n VHT40 1TX	Covered by 802.11n HT40 SISO	
	802.11n HT40 CDD 2TX	22.36	172.19
	802.11n HT40 STBC/SDM 2TX, 802.11ac VHT40 STBC/SDM 2TX	Covered by 802.11n HT40 CDD 2TX	
5775	802.11ac VHT80 SISO	18.83	76.38
	802.11ac VHT80 CDD 2TX	20.42	110.15
	802.11ac VHT80 STBC/SDM 2TX	Covered by 802.11ac VHT80 CDD 2TX	

5.3. DESCRIPTION OF AVAILABLE ANTENNAS

Frequency Band (GHz)	Antenna Gain (dBi)	
	UAT 2	LAT 3
5.2	-4.61	-0.98
5.3	-3.74	-1.09
5.5	-0.75	-0.96
5.8	0.68	-0.93

5.4. SOFTWARE AND FIRMWARE

The firmware installed in the EUT during testing was version 13.10.452.12

5.5. WORST-CASE CONFIGURATION AND MODE

For radiated harmonics spurious below 1GHz, 1-18GHz L/M/H channels, 18-40GHz, and power line conducted emissions were performed with the EUT set at the CDD mode among the CDD/STBC/SDM modes with power setting equal or higher than SISO modes as worst-case scenario.

Radiated band edge, harmonic, and spurious emissions from 1GHz to 18GHz were performed with the EUT set to transmit at highest power on Low/Middle/High channels.

Radiated emissions below 30MHz, below 1GHz, above 18GHz and power line conducted emissions were performed with the EUT transmits at the channel with the highest output power as worst-case scenario.

For SISO modes, there are two transmission antennas. The antenna used in any given time can be either UAT 2 or LAT 3. Both antenna ports have the same power; output power and PSD measurement for SISO modes on both antennas are reported. For MIMO modes, both UAT 2 and LAT 3 used at the same time.

The fundamental of the EUT was investigated in three orthogonal orientations X (Flatbed), Y (Landscape), Z (Portrait), on both UAT 2 and LAT 3 antennas. In addition, the EUT was also investigated with and without AC/DC charger, headphones & laptop. It was determined that (see table below) was the worst-case orientation for both antennas without AC/DC charger, headphones, or laptop; therefore, all final radiated testing was performed with EUT only in (see table below) orientation for 1 - 18GHz, 18 - 26GHz, and 26 – 40GHz and for 30 – 1000MHz, the EUT was tested with AC/DC charger.

All radiated harmonic 1-18GHz emissions on SISO mode, straddle channels are covered by 2TX MIMO mode with power setting equal or higher than SISO among the CDD/STBC/SDM modes.

Frequency Band (GHz)	Mode	Antenna Port	Worst-case Orientation
5.2-5.8	1TX SISO	UAT 2	Y-Landscape
		LAT 3	Y-Landscape
	2TX MIMO	UAT 2 + LAT 3	Y-Landscape

Worst-case data rates as provided by the client were:

- 802.11a mode: 6 Mbps
- 802.11n HT20 mode: MCS0
- 802.11n HT40 mode: MCS0
- 802.11ac VHT20 mode: MCS0
- 802.11ac VHT40 mode: MCS0
- 802.11ac VHT80 mode: MCS0

802.11ac VHT20 and VHT40 mode are different from 802.11nHT20 and HT40 only in control messages and have the same power settings.

There are two vendors of the WiFi/Bluetooth radio modules: variant 1 and variant 2. The WiFi/Bluetooth radio modules have the same mechanical outline (e.g., the same package dimension and pin-out layout), use the same on-board antenna matching circuit, have an identical antenna structure, and are built and tested to conform to the same specifications and to operate within the same tolerances.

Baseline testing was performed on the two variants to determine the worst case on all conducted power and radiated emissions.

For simultaneous transmission of multiple channels from the same antenna LAT 3 in the 2.4GHz BT/BLE and 5GHz bands, tests were conducted for various configurations having the highest power. No noticeable new emission was found.

5.6. DESCRIPTION OF TEST SETUP

SUPPORT EQUIPMENT

Support Equipment List				
Description	Manufacturer	Model	Serial Number	FCC ID
Laptop AC/DC adapter	Liteon Technology	PA-1450-BA1	B123	NA
Laptop	Apple	MackBook Air 4	NA	NA
Dongle	N/A	N/A	HDG1409226823	NA

I/O CABLES (CONDUCTED TEST)

I/O Cable List						
Cable No	Port	# of identical ports	Connector Type	Cable Type	Cable Length (m)	Remarks
1	Antenna	1	SMA	Un-Shielded	0.2	To spectrum Analyzer
2	USB	1	USB	Shielded	1	N/A
3	AC	1	AC	Un-shielded	3	N/A

I/O CABLES (RADIATED ABOVE 1 GHZ)

I/O Cable List						
Cable No	Port	# of identical ports	Connector Type	Cable Type	Cable Length (m)	Remarks
None Used						

I/O CABLES (AC POWER CONDUCTED TEST AND BELOW 1 GHZ)

I/O Cable List						
Cable No	Port	# of identical ports	Connector Type	Cable Type	Cable Length (m)	Remarks
1	AC	1	AC	Un-shielded	3	N/A

TEST SETUP

The EUT was tested connected to a host Laptop via USB cable adapter and spectrum analyzer to antenna port. Test software exercised the EUT.

SETUP DIAGRAM

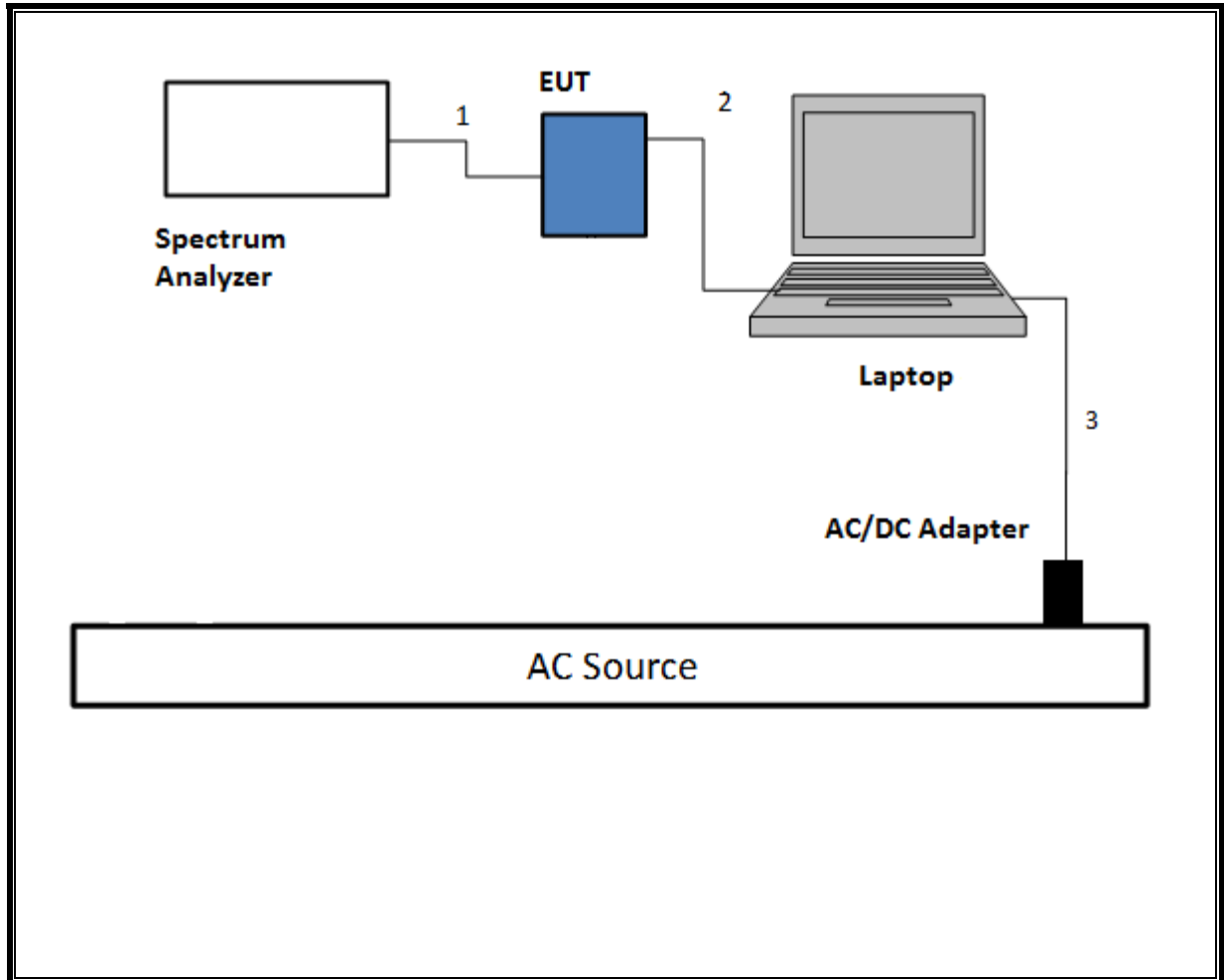

TEST SETUP- RADIATED-ABOVE 1 GHZ

The EUT was tested battery powered. Test software exercised the EUT.

SETUP DIAGRAM

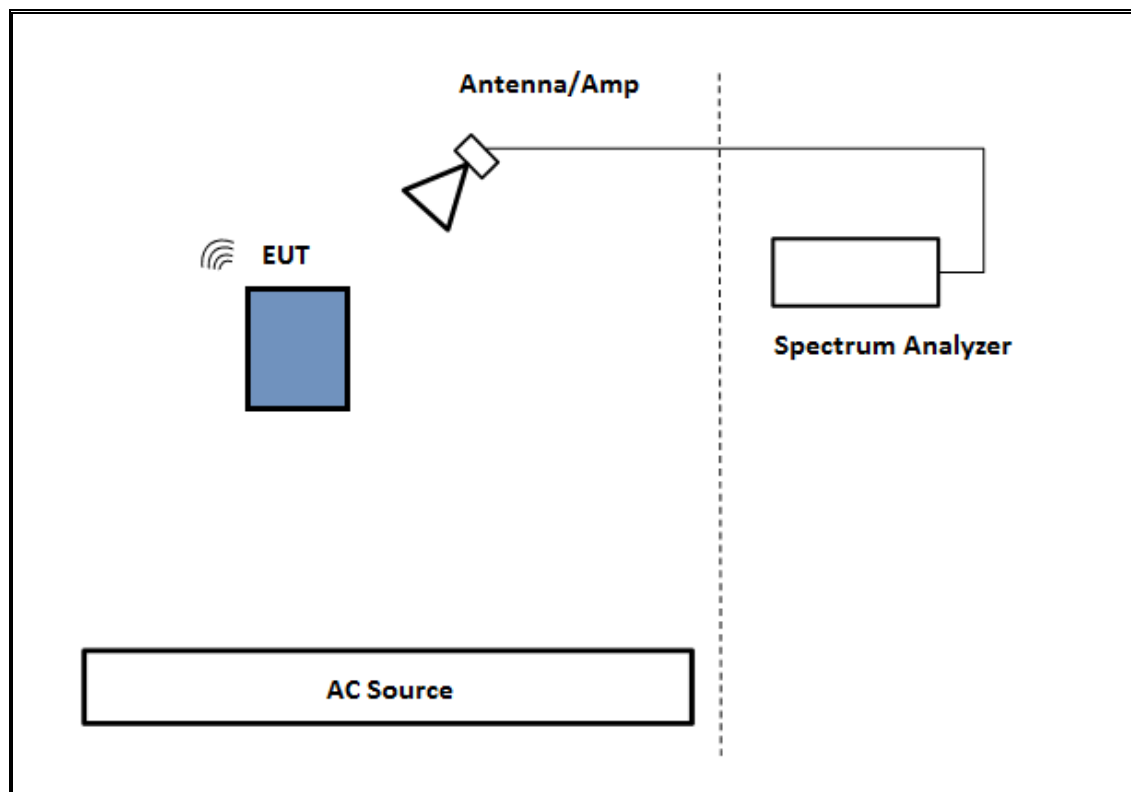

TEST SETUP- BELOW 1GHZ

The EUT was tested with powered by AC/DC adapter via USB cable. Test software exercised the EUT.

SETUP DIAGRAM

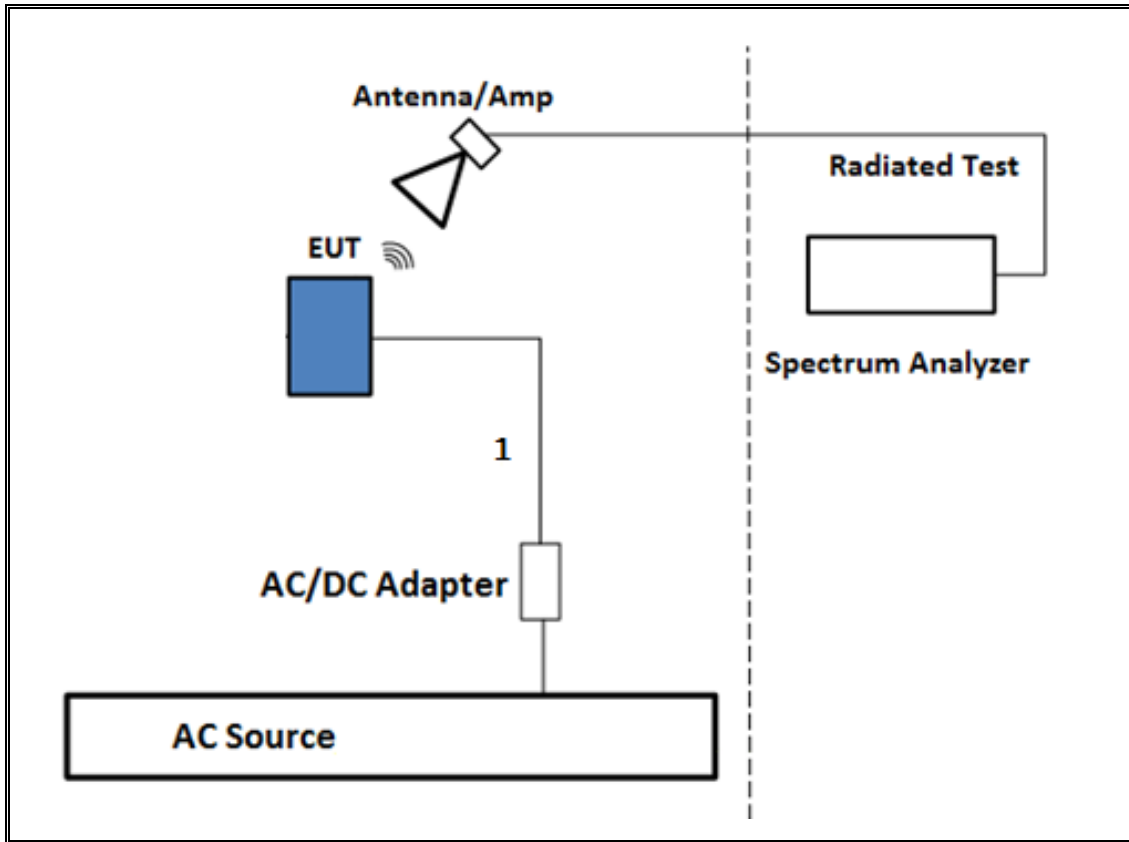

TEST SETUP- AC LINE CONDUCTED: AC/DC ADAPTER

The EUT was tested with powered by AC/DC adapter via USB cable. Test software exercised the EUT.

SETUP DIAGRAM

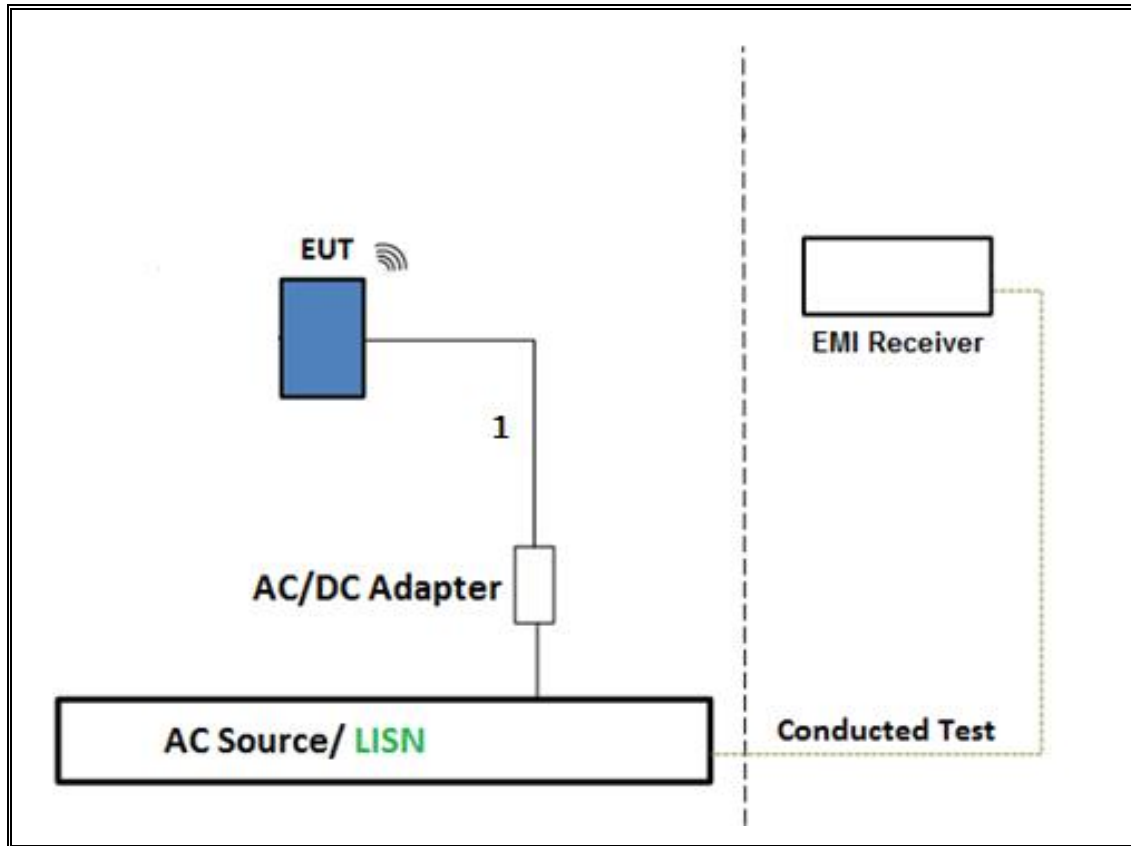

TEST SETUP- AC LINE CONDUCTED: LAPTOP CONFIGURATION

The EUT was tested with powered by host PC via USB cable. Test software exercised the EUT.

SETUP DIAGRAM

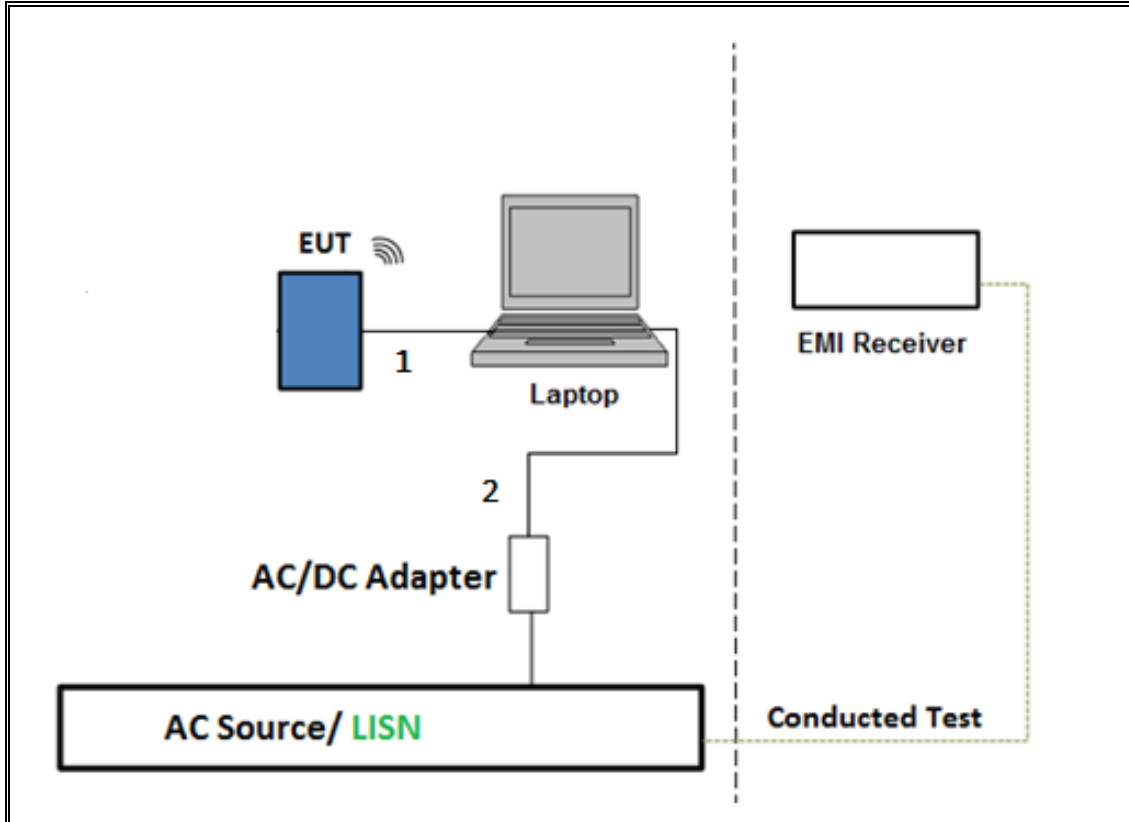

6. TEST AND MEASUREMENT EQUIPMENT

The following test and measurement equipment was utilized for the tests documented in this report:

TEST EQUIPMENT LIST				
Description	Manufacturer	Model	Asset	Cal Due
Antenna, Horn 1-18GHz	ETS Lindgren	3117	T300	11/10/17
Amplifier, 1 to 18GHz	Miteq	AFS42-00101800-25-S-42	T243	10/11/2017
Spectrum Analyzer, PSA, 3Hz to 44GHz	Agilent (Keysight) Technologies	E4446A	T177	03/20/2018
Antenna, Horn 1-18GHz	ETS Lindgren	3117	T345	4/14/2018
*Amplifier, 1 to 18GHz	Miteq	AFS42-00101800-25-S-42	T491	5/31/2017
Spectrum Analyzer, PXA 3Hz to 44GHz	Keysight	N9030A-544	T341	10/25/2017
Antenna, Broadband Hybrid, 30MHz to 2000MHz	Sunol Sciences	JB3	T122	1/31/2018
*Amplifier, 10KHz to 1GHz, 32dB	Sonoma	310N	T173	6/17/2017
Power Meter, P-series single channel	Agilent (Keysight) Technologies	N1911A	T1245	01/05/2018
Spectrum Analyzer, PXA 3Hz to 44GHz	Keysight	N9030A	T340	12/14/2017
Amplifier, 1 to 18GHz	Miteq	AFS42-00101800-25-S-42	T740	11/29/17
Antenna, Horn 1-18GHz	ETS Lindgren	3117	T862	4/20/2018
Antenna, Horn 1-18GHz	ETS Lindgren	3117	T119	3/28/2018
Amplifier, 1 to 18GHz	Miteq	AFS42-00101800-25-S-42	T742	11/29/2017
Spectrum Analyzer, PXA 3Hz to 44GHz	Keysight	N9030A	T1113	12/20/2017
Power Sensor	Keysight	N1921A	T750	10/1/2017
Spectrum Analyzer, PXA, 3Hz to 44GHz	Agilent (Keysight) Technologies	N9030A	T339	09/22/2017
*Antenna Horn, 18 to 26GHz	ARA	MWH-1826	T447	6/16/2017
Antenna Horn 26-40GHz	ARA	MWH-2640	T90	8/19/2017
*Amplifier, 26.5GHz to 40GHz	Miteq	NSP 4000 SP2	T88	4/07/2017
Spectrum Analyzer, 40GHz	Agilent	8564E	T106	9/7/2017
Amplifier, 1 to 26.5GHz 23.5dB gain Minimum	Keysight	8449B	T402	7/5/2017
AC Line Conducted				
EMI Test Receiver 9KHz-7GHz	Rohde & Schwarz	ESCI7	T1436	01/06/2018
*LISN for Conducted Emissions CISPR-16	Fischer	50/250-25-2-01	T1310	06/08/2017
Power Cable, Line Conducted Emissions	UL	PG1	T861	9/1/2017
UL AUTOMATION SOFTWARE				
Radiated Software	UL	UL EMC	Ver 9.5, April 26, 2016	
Conducted Software	UL	UL EMC	Ver 5.4, October 13, 2016	
AC Line Conducted Software	UL	UL EMC	Ver 9.5, May 26, 2015	

NOTE: *testing is completed before equipment calibration expiration date.

7. ON TIME, DUTY CYCLE AND MEASUREMENT METHODS

7.1. ON TIME AND DUTY CYCLE

LIMITS

None; for reporting purposes only.

PROCEDURE

KDB 789033 Zero-Span Spectrum Analyzer Method.

RESULTS

Mode	ON Time B (msec)	Period (msec)	Duty Cycle x (linear)	Duty Cycle (%)	Duty Cycle Correction Factor (dB)	1/B Minimum VBW (kHz)
802.11n HT20 1TX	1.920	1.940	0.990	98.97%	0.00	0.010
802.11n HT40 1TX	0.9442	0.9645	0.979	97.90%	0.09	1.059
802.11ac HT80 1TX	0.4598	0.4803	0.957	95.73%	0.19	2.175
802.11n HT20 2TX CDD	1.920	1.940	0.990	98.97%	0.00	0.010
802.11n HT40 2TX CDD	0.9442	0.9645	0.979	97.87%	0.09	1.059
802.11ac VHT80 2TX CDD	0.4597	0.480	0.958	95.77	0.19	2.175

DUTY CYCLE PLOTS

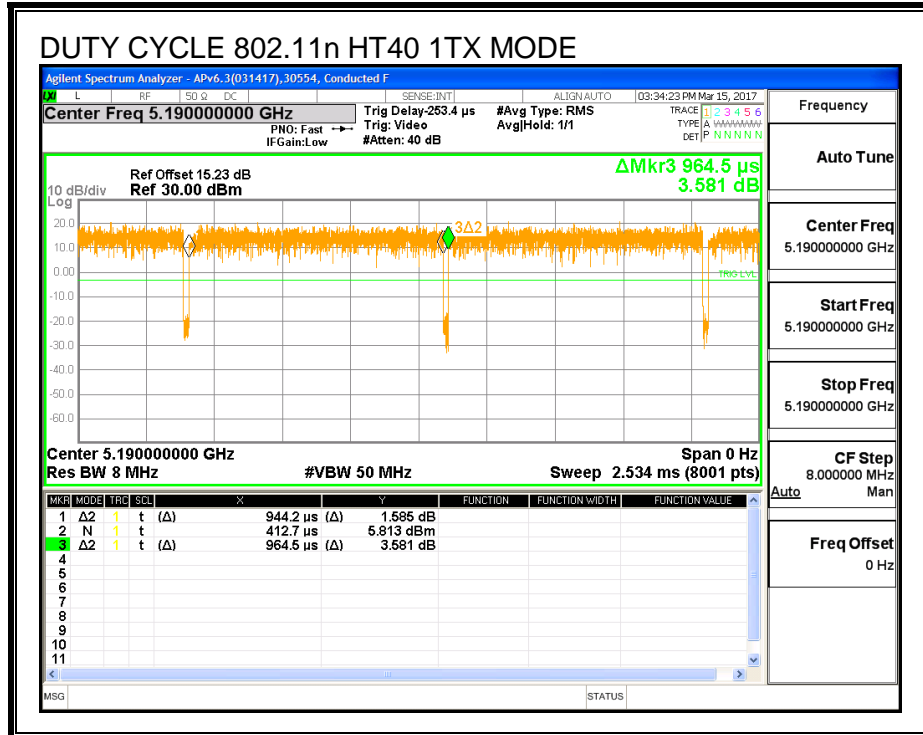
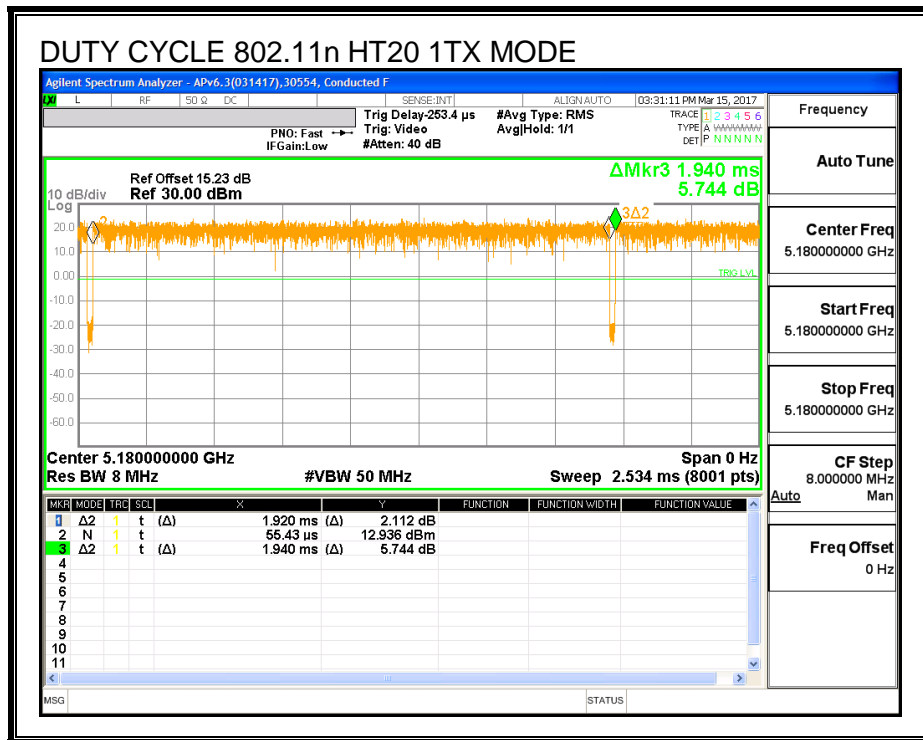

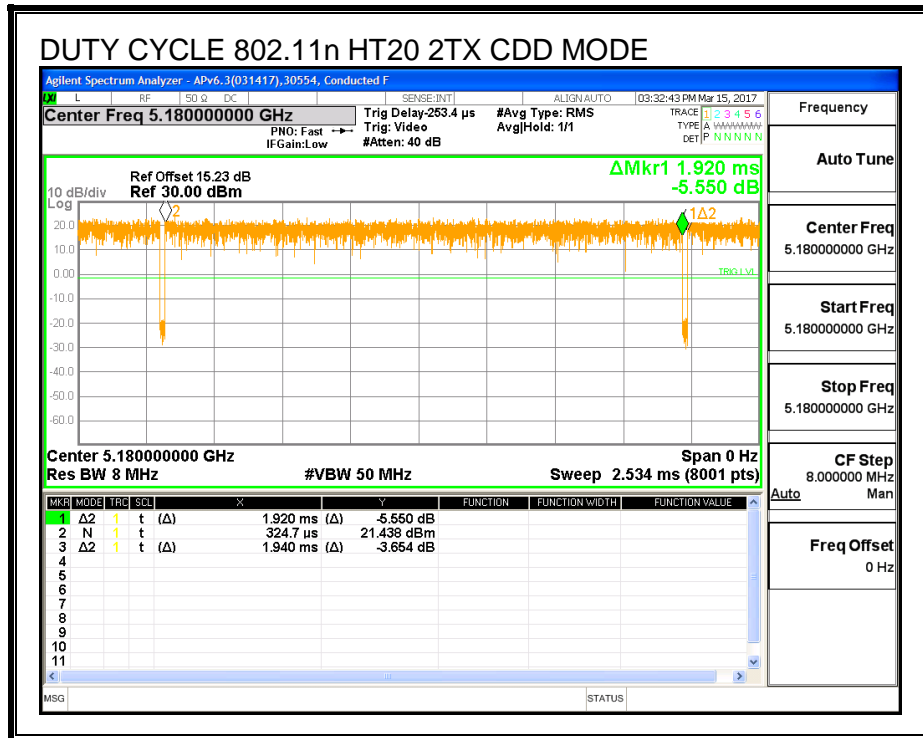
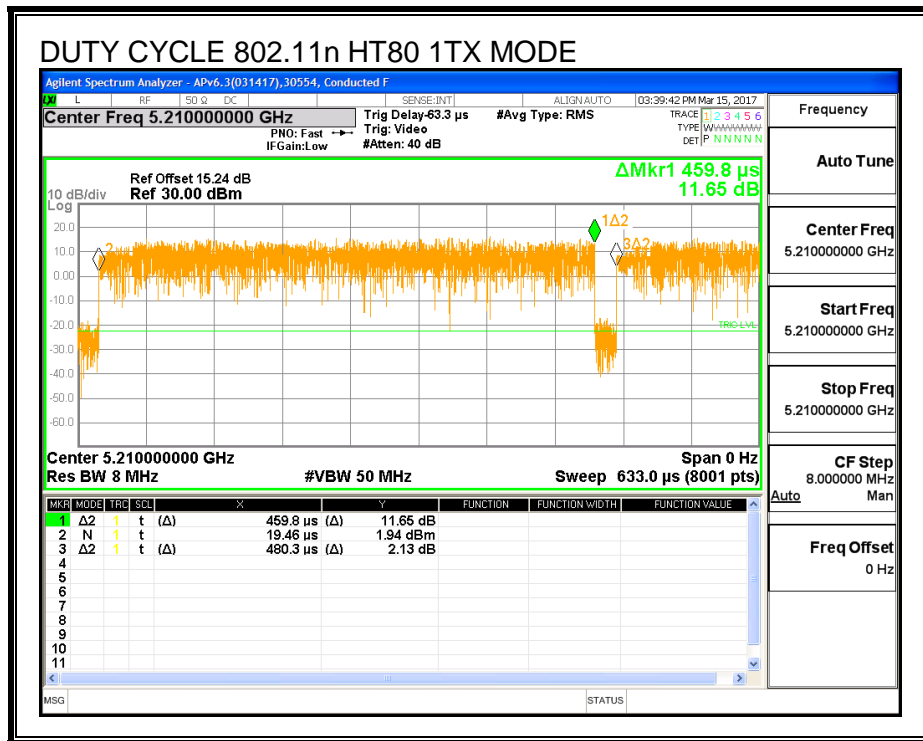

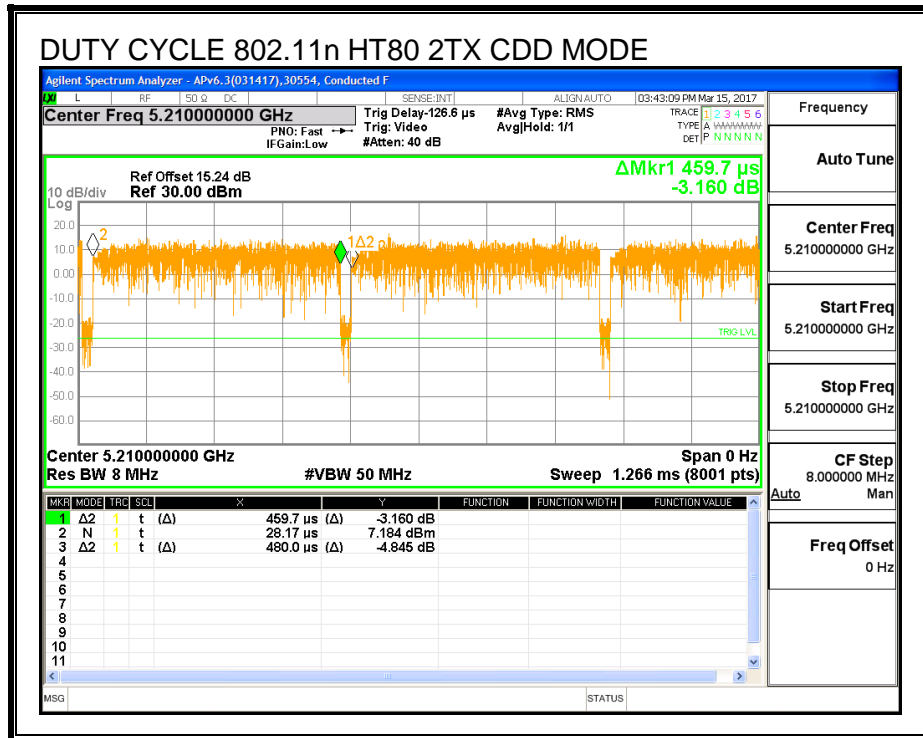
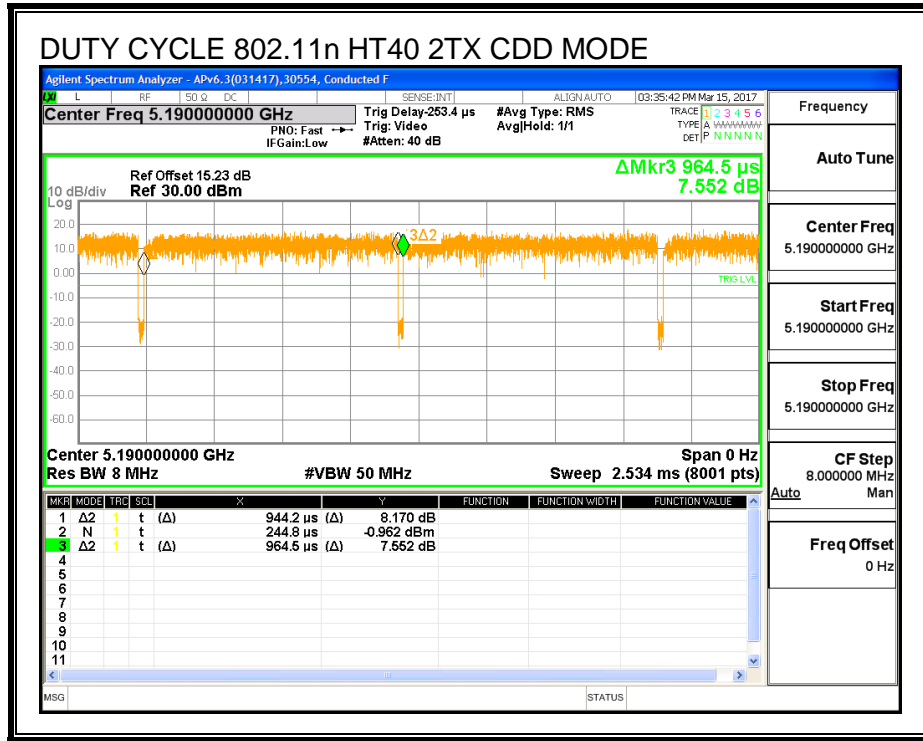

7.2. MEASUREMENT METHODS

6 dB Emission BW: KDB 789033 D02 v01r04, Section C.

26 dB Emission BW: KDB 789033 D02 v01r04, Section C.

99% Occupied BW: KDB 789033 D02 v01r04, Section D.

Conducted Output Power: KDB 789033 D02 v01r04, Section E.3.b (Method PM-G).

Power Spectral Density: KDB 789033 D02 v01r04, Section F (Method SA-2).

Unwanted emissions in restricted bands: KDB 789033 D02 v01r04, Sections G.3, G.4, G.5, and G.6.

Unwanted emissions in non-restricted bands: KDB 789033 D02 v01r04, Sections G.3, G.4, and G.5.

Conducted line emissions: C63.10, Clause 6.2

8. ANTENNA PORT TEST RESULTS

8.1. 11n HT20 UAT 2 SISO MODE IN THE 5.2GHz BAND

8.1.1. 26 dB BANDWIDTH

LIMITS

None; for reporting purposes only.

RESULTS

Channel	Frequency	26 dB BW UAT 2 (MHz)
Low	5180	21.85
Mid	5200	21.85
High	5240	21.95

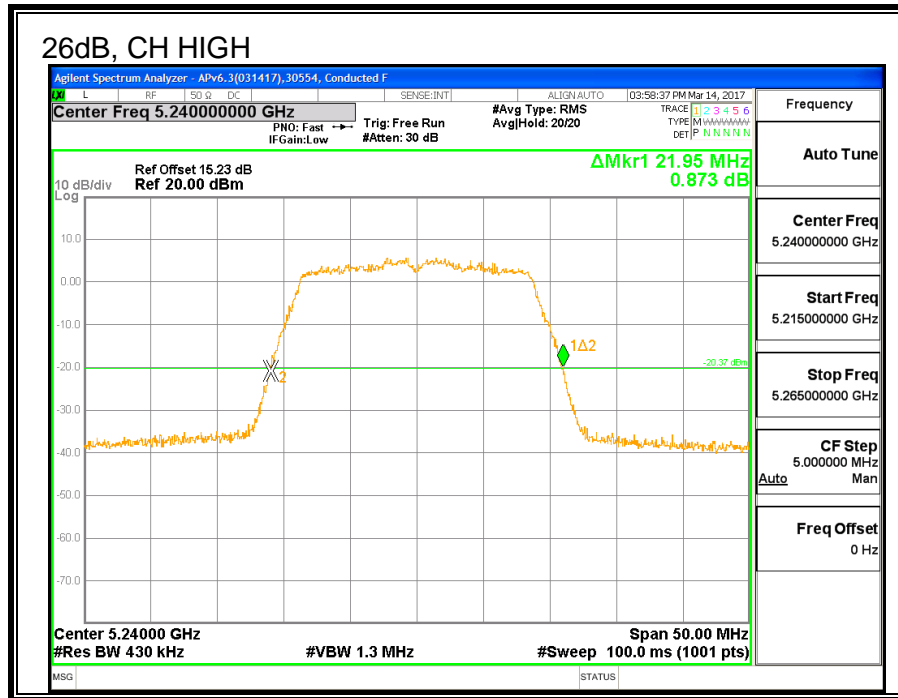

8.1.2. 99% BANDWIDTH

LIMITS

None; for reporting purposes only.

RESULTS

Channel	Frequency	99% BW UAT 2 (MHz)
Low	5180	17.751
Mid	5200	17.648
High	5240	17.737

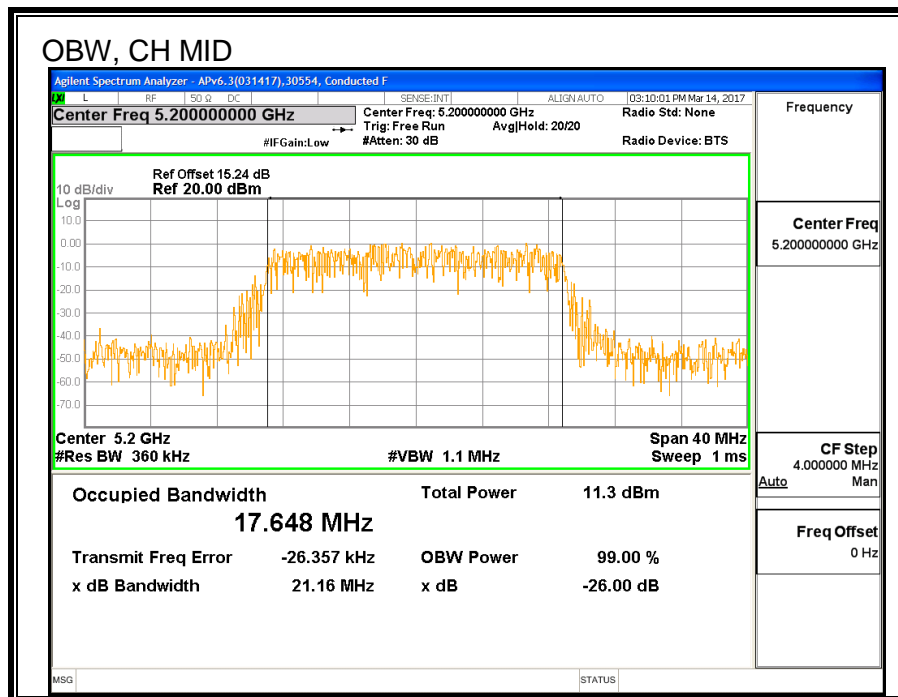
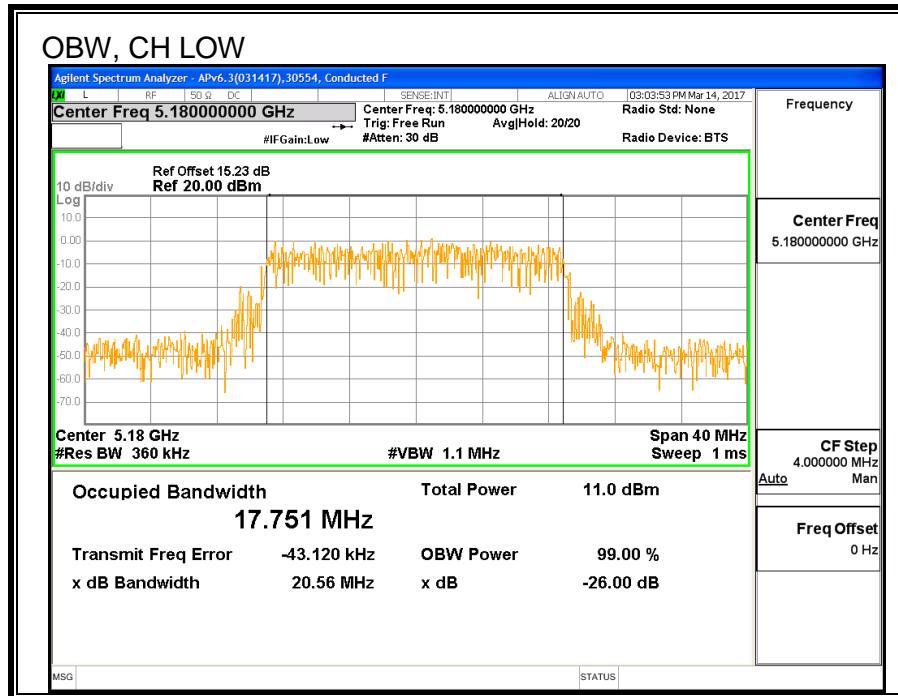

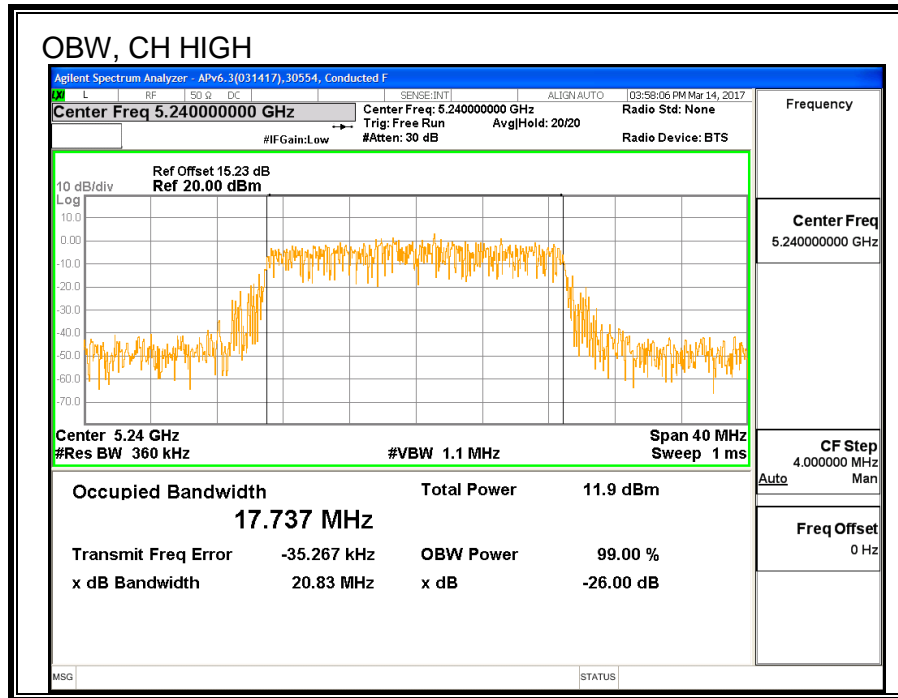

8.1.3. AVERAGE POWER

ID:	39472	Date:	6/11/17
------------	-------	--------------	---------

LIMITS

None; for reporting purposes only.

TEST PROCEDURE

Measurements perform using a wideband gated RF power meter.

RESULTS

Channel	Frequency	Power UAT 2 (dBm)
Low	5180	17.49
Mid	5200	19.40
High	5240	20.87

8.1.4. OUTPUT POWER AND PPSD

LIMITS

FCC §15.407 (a) (1)

(i) For an outdoor access point operating in the band 5.15-5.25 GHz, the maximum conducted output power over the frequency band of operation shall not exceed 1 W provided the maximum antenna gain does not exceed 6 dBi. In addition, the maximum power spectral density shall not exceed 17 dBm in any 1 megahertz band. If transmitting antennas of directional gain greater than 6 dBi are used, both the maximum conducted output power and the maximum power spectral density shall be reduced by the amount in dB that the directional gain of the antenna exceeds 6 dBi. The maximum e.i.r.p. at any elevation angle above 30 degrees as measured from the horizon must not exceed 125 mW (21 dBm).

(ii) For an indoor access point operating in the band 5.15-5.25 GHz, the maximum conducted output power over the frequency band of operation shall not exceed 1 W provided the maximum antenna gain does not exceed 6 dBi. In addition, the maximum power spectral density shall not exceed 17 dBm in any 1 megahertz band. If transmitting antennas of directional gain greater than 6 dBi are used, both the maximum conducted output power and the maximum power spectral density shall be reduced by the amount in dB that the directional gain of the antenna exceeds 6 dBi.

(iii) For fixed point-to-point access points operating in the band 5.15-5.25 GHz, the maximum conducted output power over the frequency band of operation shall not exceed 1 W. Fixed point-to-point U-NII devices may employ antennas with directional gain up to 23 dBi without any corresponding reduction in the maximum conducted output power or maximum power spectral density. For fixed point-to-point transmitters that employ a directional antenna gain greater than 23 dBi, a 1 dB reduction in maximum conducted output power and maximum power spectral density is required for each 1 dB of antenna gain in excess of 23 dBi. Fixed, point-to-point operations exclude the use of point-to-multipoint systems, omnidirectional applications, and multiple collocated transmitters transmitting the same information. The operator of the U-NII device, or if the equipment is professionally installed, the installer, is responsible for ensuring that systems employing high gain directional antennas are used exclusively for fixed, point-to-point operations.

(iv) For mobile and portable client devices in the 5.15-5.25 GHz band, the maximum conducted output power over the frequency band of operation shall not exceed 250 mW provided the maximum antenna gain does not exceed 6 dBi. In addition, the maximum power spectral density shall not exceed 11 dBm in any 1 megahertz band. If transmitting antennas of directional gain greater than 6 dBi are used, both the maximum conducted output power and the maximum power spectral density shall be reduced by the amount in dB that the directional gain of the antenna exceeds 6 dBi.

TEST PROCEDURE

Measurements perform using a wideband gated RF power meter provided that the gate parameters are adjusted such that the power is measured only when the EUT is transmitting at its maximum power control level. Since the measurement is made only during the ON time of the transmitter, no duty cycle correction factor is required.

PSD test procedure: KDB 789033 D02 v01r04 Section F (SA-2 method)

DIRECTIONAL ANTENNA GAIN

There is only one transmitter output therefore the directional gain is equal to the antenna gain.

RESULTS

Antenna Gain and Limits

Channel	Frequency (MHz)	Directional Gain for Power (dBi)	Directional Gain for PSD (dBi)	Power Limit (dBm)	PSD Limit (dBm)
Low	5180	-4.61	-4.61	24.00	11.00
Mid	5200	-4.61	-4.61	24.00	11.00
High	5240	-4.61	-4.61	24.00	11.00

Duty Cycle CF (dB)	0.00	Included in Calculations of Corr'd PSD
---------------------------	------	-----------------------------------------------

Output Power Results

Channel	Frequency (MHz)	UAT 2 Meas Power (dBm)	Total Corr'd Power (dBm)	Power Limit (dBm)	Power Margin (dB)
Low	5180	17.49	17.49	24.00	-6.51
Mid	5200	19.40	19.40	24.00	-4.60
High	5240	20.87	20.87	24.00	-3.13

PSD Results

Channel	Frequency (MHz)	UAT 2 Meas PSD (dBm)	Total Corr'd PSD (dBm)	PSD Limit (dBm)	PSD Margin (dB)
Low	5180	8.535	8.535	11.00	-2.47
Mid	5200	8.640	8.640	11.00	-2.36
High	5240	10.687	10.687	11.00	-0.31

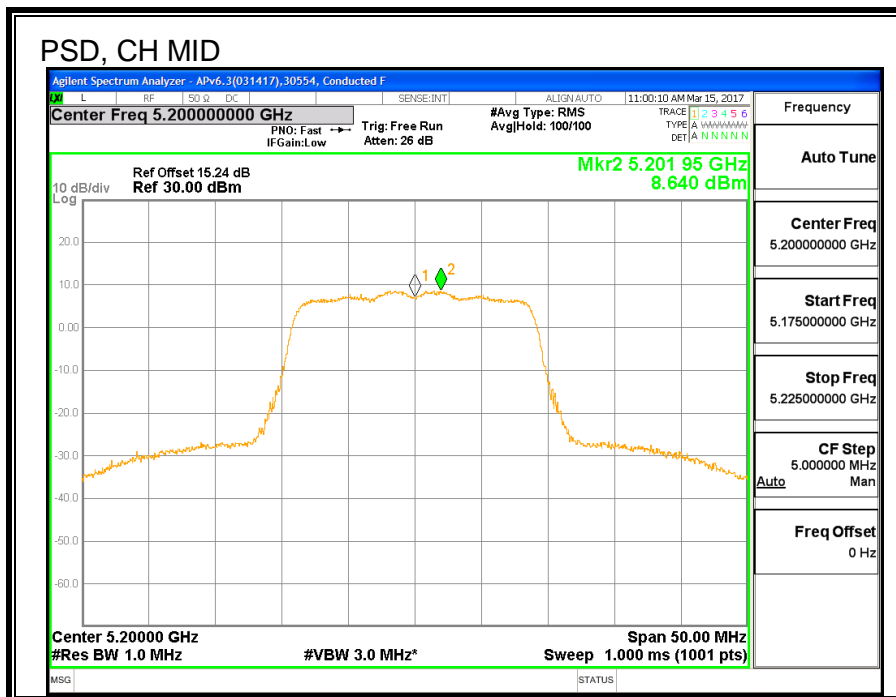
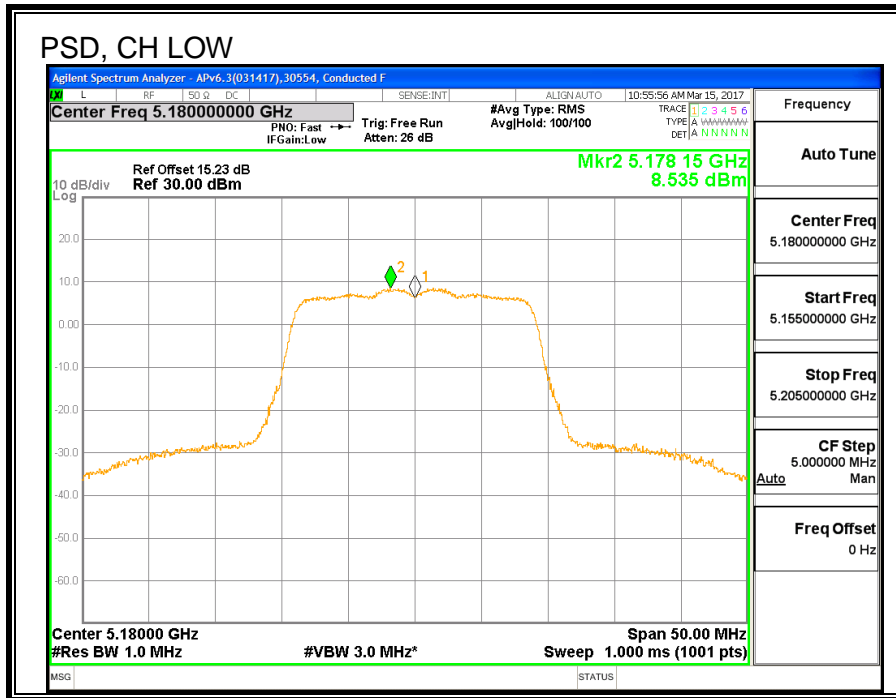

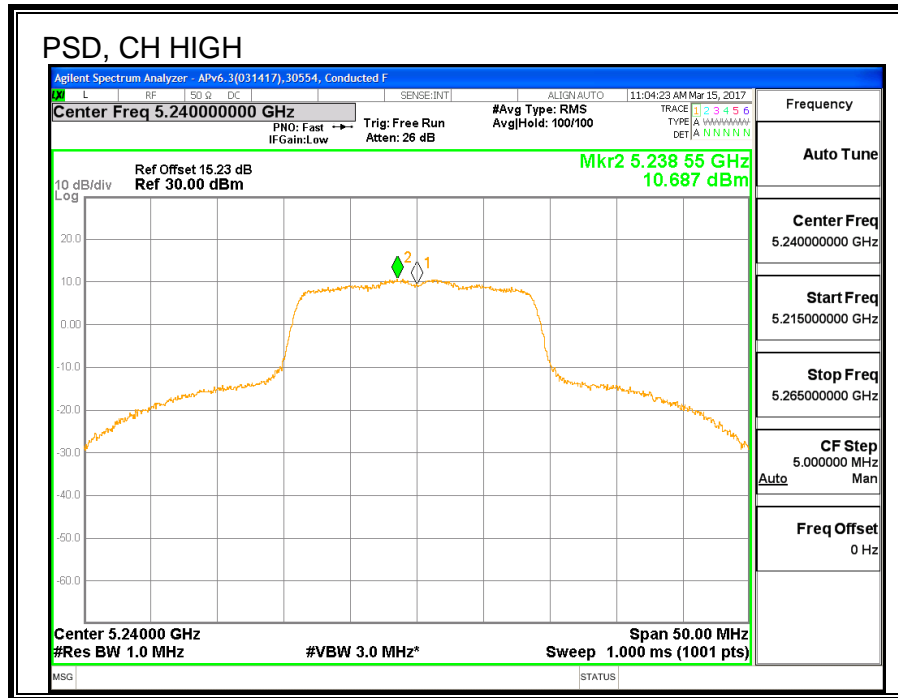

8.2. 11n HT20 LAT 3 SISO MODE IN THE 5.2GHz BAND

8.2.1. 26 dB BANDWIDTH

LIMITS

None; for reporting purposes only.

RESULTS

Channel	Frequency	26 dB BW LAT 3 (MHz)
Low	5180	22.00
Mid	5200	21.90
High	5240	22.10

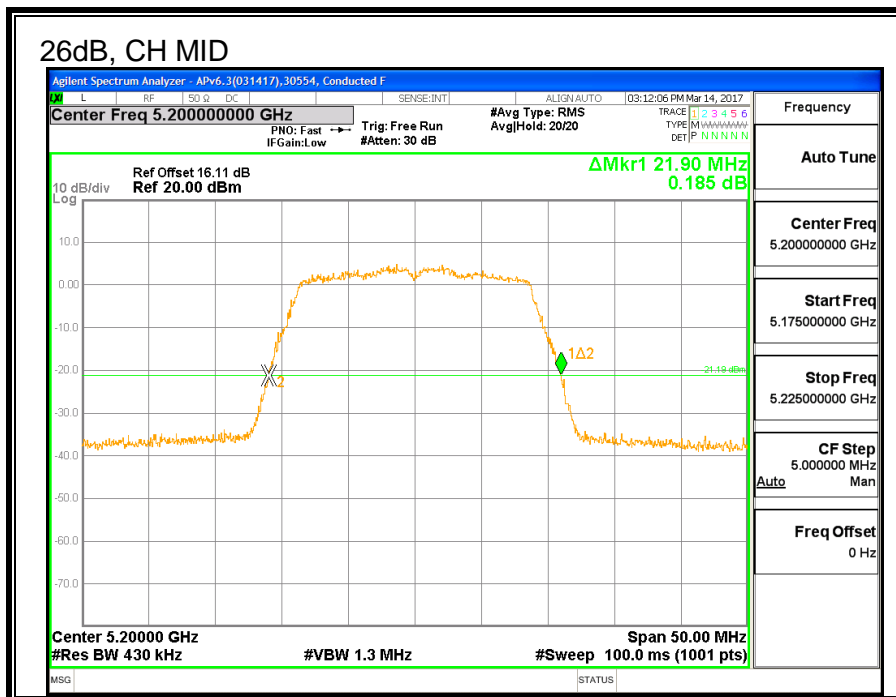
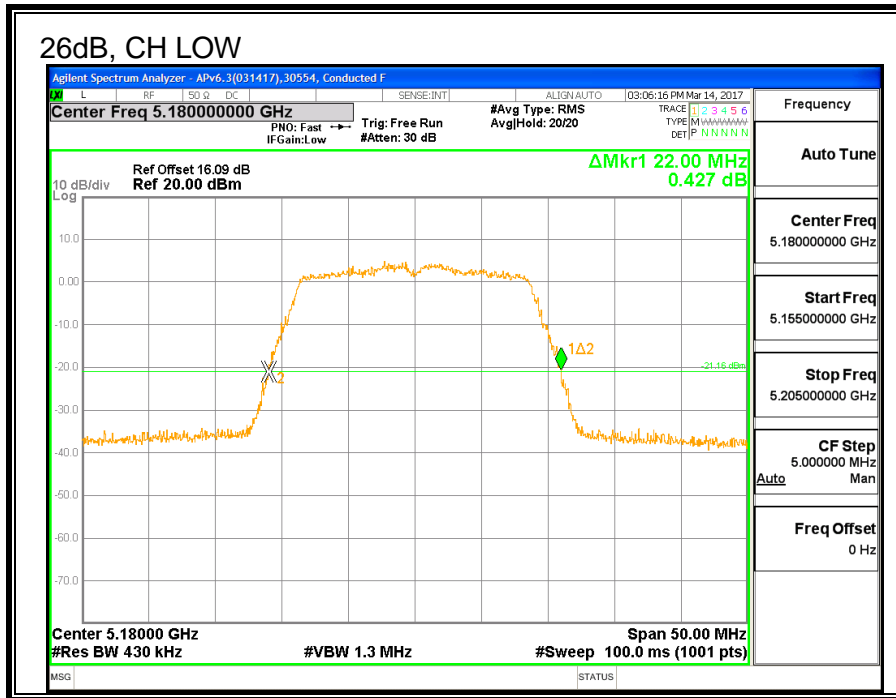

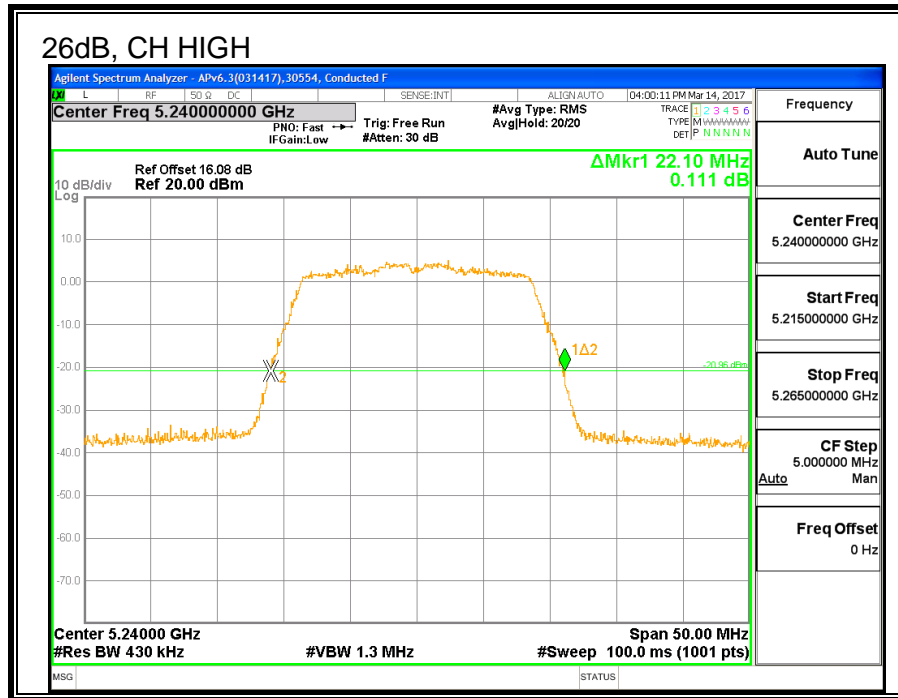

8.2.2. 99% BANDWIDTH

LIMITS

None; for reporting purposes only.

RESULTS

Channel	Frequency	99% BW LAT 3 (MHz)
Low	5180	17.699
Mid	5200	17.743
High	5240	17.648

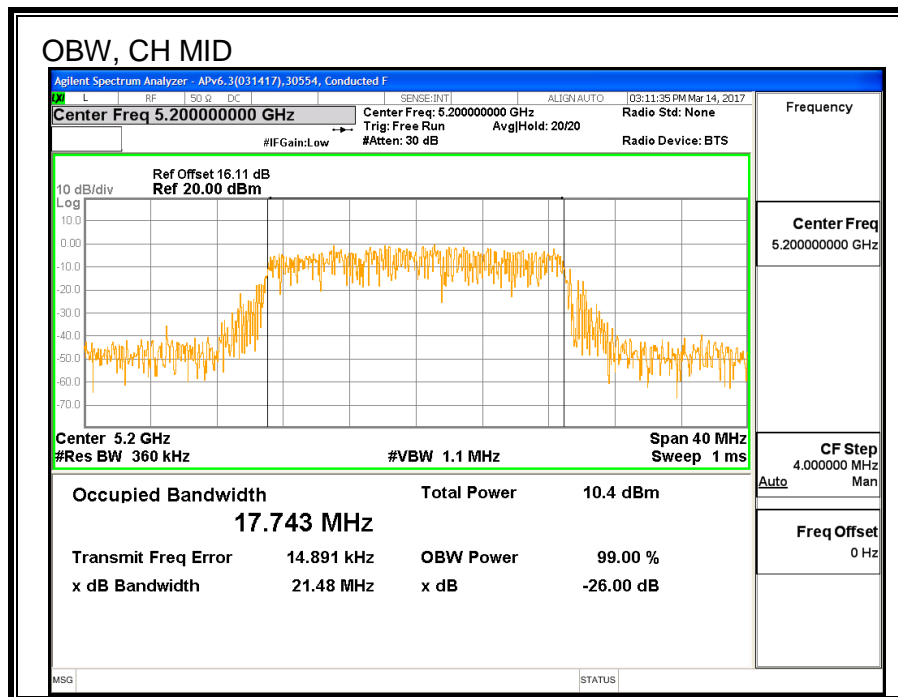
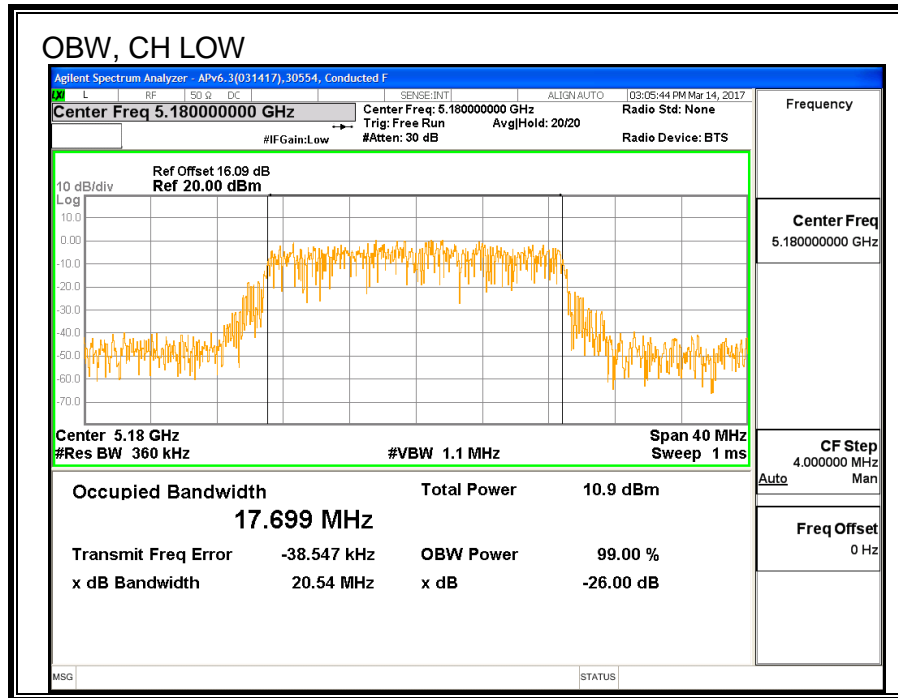

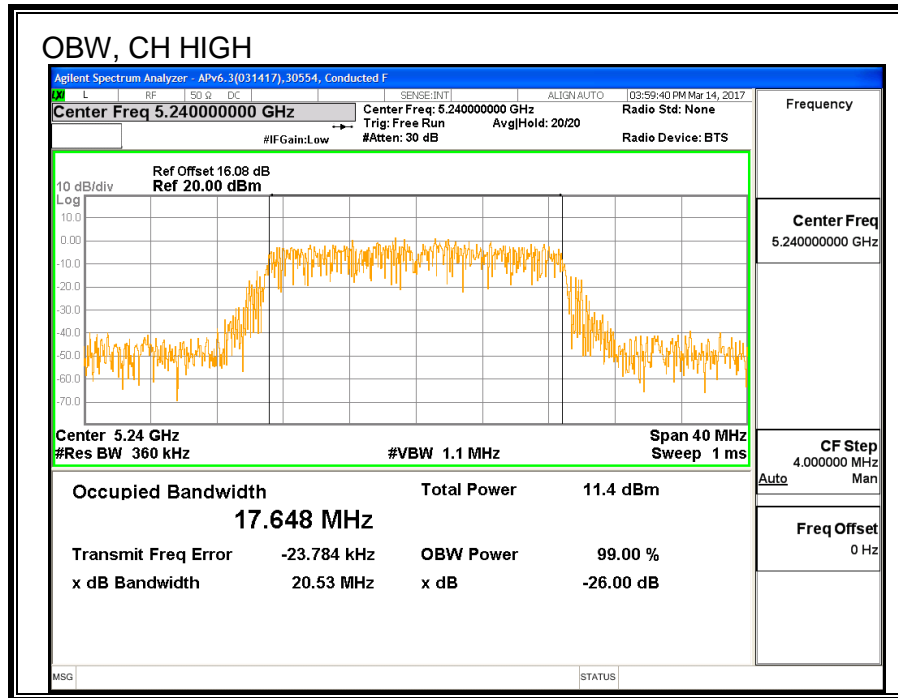

8.2.3. AVERAGE POWER

ID:	39472	Date:	6/11/17
------------	-------	--------------	---------

LIMITS

None; for reporting purposes only.

TEST PROCEDURE

Measurements perform using a wideband gated RF power meter.

RESULTS

Channel	Frequency	Power LAT 3 (dBm)
Low	5180	17.39
Mid	5200	19.48
High	5240	20.83

8.2.4. OUTPUT POWER AND PPSD

LIMITS

FCC §15.407 (a) (1)

(i) For an outdoor access point operating in the band 5.15-5.25 GHz, the maximum conducted output power over the frequency band of operation shall not exceed 1 W provided the maximum antenna gain does not exceed 6 dBi. In addition, the maximum power spectral density shall not exceed 17 dBm in any 1 megahertz band. If transmitting antennas of directional gain greater than 6 dBi are used, both the maximum conducted output power and the maximum power spectral density shall be reduced by the amount in dB that the directional gain of the antenna exceeds 6 dBi. The maximum e.i.r.p. at any elevation angle above 30 degrees as measured from the horizon must not exceed 125 mW (21 dBm).

(ii) For an indoor access point operating in the band 5.15-5.25 GHz, the maximum conducted output power over the frequency band of operation shall not exceed 1 W provided the maximum antenna gain does not exceed 6 dBi. In addition, the maximum power spectral density shall not exceed 17 dBm in any 1 megahertz band. If transmitting antennas of directional gain greater than 6 dBi are used, both the maximum conducted output power and the maximum power spectral density shall be reduced by the amount in dB that the directional gain of the antenna exceeds 6 dBi.

(iii) For fixed point-to-point access points operating in the band 5.15-5.25 GHz, the maximum conducted output power over the frequency band of operation shall not exceed 1 W. Fixed point-to-point U-NII devices may employ antennas with directional gain up to 23 dBi without any corresponding reduction in the maximum conducted output power or maximum power spectral density. For fixed point-to-point transmitters that employ a directional antenna gain greater than 23 dBi, a 1 dB reduction in maximum conducted output power and maximum power spectral density is required for each 1 dB of antenna gain in excess of 23 dBi. Fixed, point-to-point operations exclude the use of point-to-multipoint systems, omnidirectional applications, and multiple collocated transmitters transmitting the same information. The operator of the U-NII device, or if the equipment is professionally installed, the installer, is responsible for ensuring that systems employing high gain directional antennas are used exclusively for fixed, point-to-point operations.

(iv) For mobile and portable client devices in the 5.15-5.25 GHz band, the maximum conducted output power over the frequency band of operation shall not exceed 250 mW provided the maximum antenna gain does not exceed 6 dBi. In addition, the maximum power spectral density shall not exceed 11 dBm in any 1 megahertz band. If transmitting antennas of directional gain greater than 6 dBi are used, both the maximum conducted output power and the maximum power spectral density shall be reduced by the amount in dB that the directional gain of the antenna exceeds 6 dBi.

TEST PROCEDURE

Measurements perform using a wideband gated RF power meter provided that the gate parameters are adjusted such that the power is measured only when the EUT is transmitting at its maximum power control level. Since the measurement is made only during the ON time of the transmitter, no duty cycle correction factor is required.

PSD test procedure: KDB 789033 D02 v01r04 Section F (SA-2 method)

DIRECTIONAL ANTENNA GAIN

There is only one transmitter output therefore the directional gain is equal to the antenna gain.

RESULTS

Antenna Gain and Limits

Channel	Frequency (MHz)	Directional Gain for Power (dBi)	Directional Gain for PSD (dBi)	Power Limit (dBm)	PSD Limit (dBm)
Low	5180	-0.98	-0.98	24.00	11.00
Mid	5200	-0.98	-0.98	24.00	11.00
High	5240	-0.98	-0.98	24.00	11.00

Duty Cycle CF (dB)	0.00	Included in Calculations of Corr'd PSD
---------------------------	------	-----------------------------------------------

Output Power Results

Channel	Frequency (MHz)	LAT 3 Meas Power (dBm)	Total Corr'd Power (dBm)	Power Limit (dBm)	Power Margin (dB)
Low	5180	17.39	17.39	24.00	-6.61
Mid	5200	19.48	19.48	24.00	-4.52
High	5240	20.83	20.83	24.00	-3.17

PSD Results

Channel	Frequency (MHz)	LAT 3 Meas PSD (dBm)	Total Corr'd PSD (dBm)	PSD Limit (dBm)	PSD Margin (dB)
Low	5180	8.376	8.376	11.00	-2.62
Mid	5200	8.629	8.629	11.00	-2.37
High	5240	10.230	10.230	11.00	-0.77

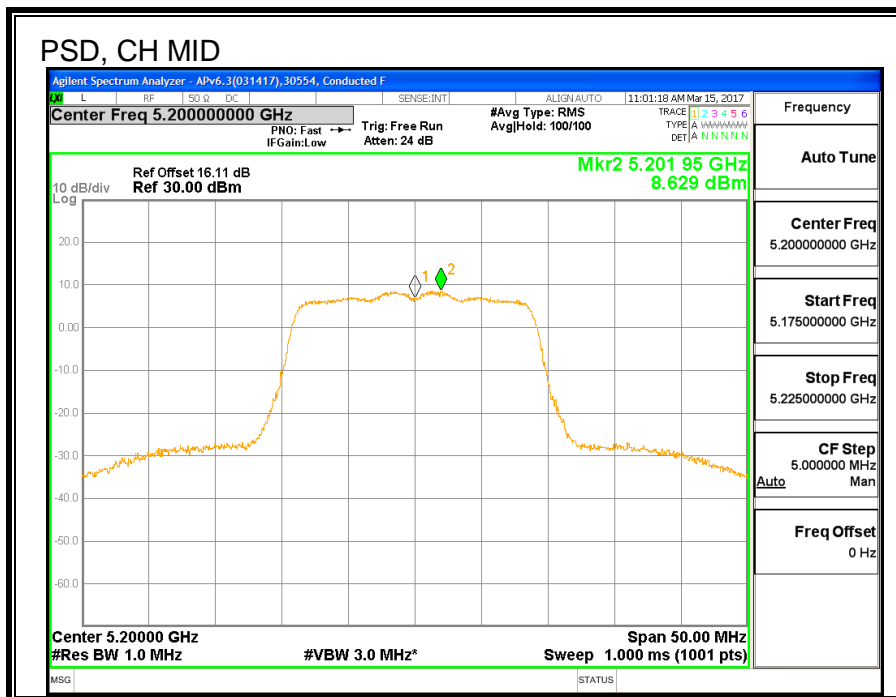
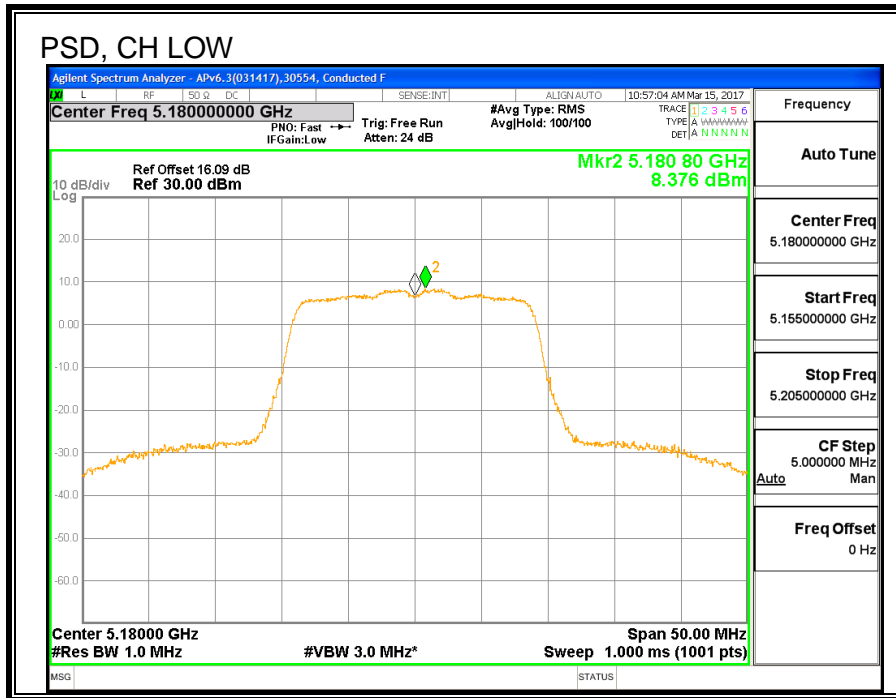

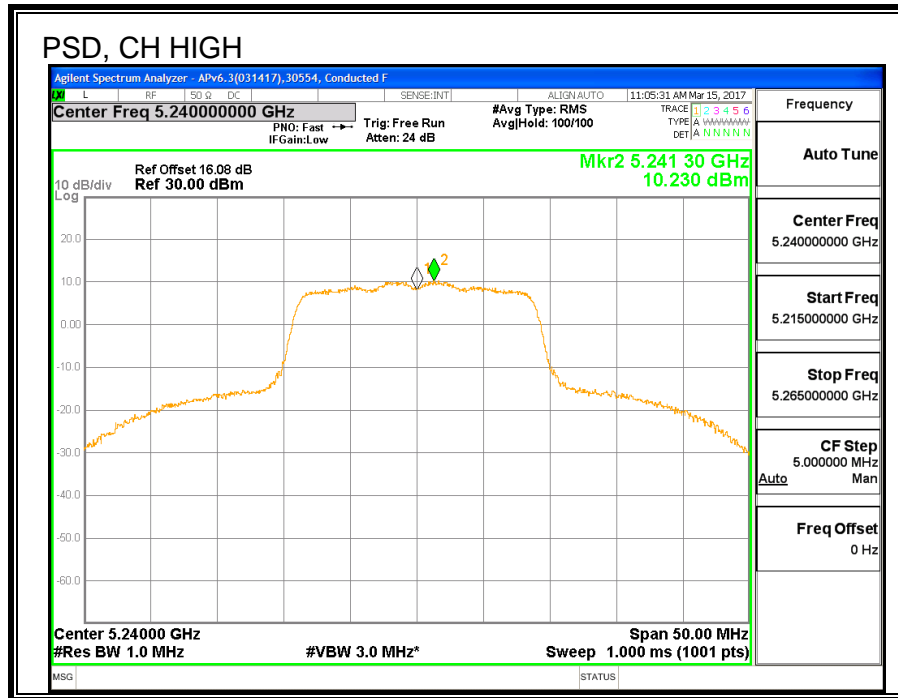

8.3. 11n HT20 2TX CDD MIMO MODE IN THE 5.2GHz BAND

8.3.1. 26 dB BANDWIDTH

LIMITS

None; for reporting purposes only.

RESULTS

Channel	Frequency	26 dB BW UAT 2 (MHz)	26 dB BW LAT 3 (MHz)
Low	5180	22.00	21.65
Mid	5200	22.00	22.05
High	5240	21.90	21.50

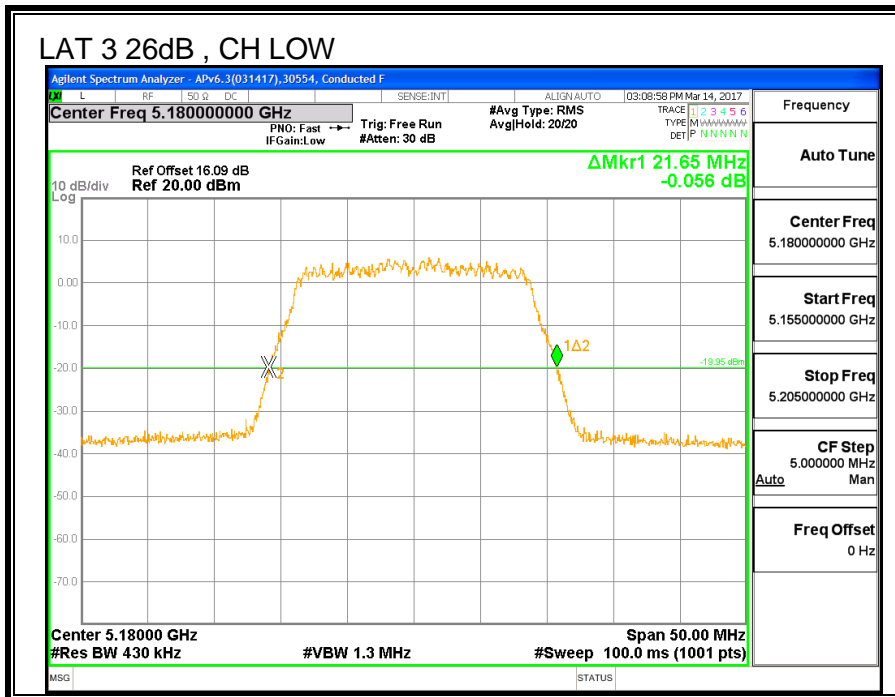
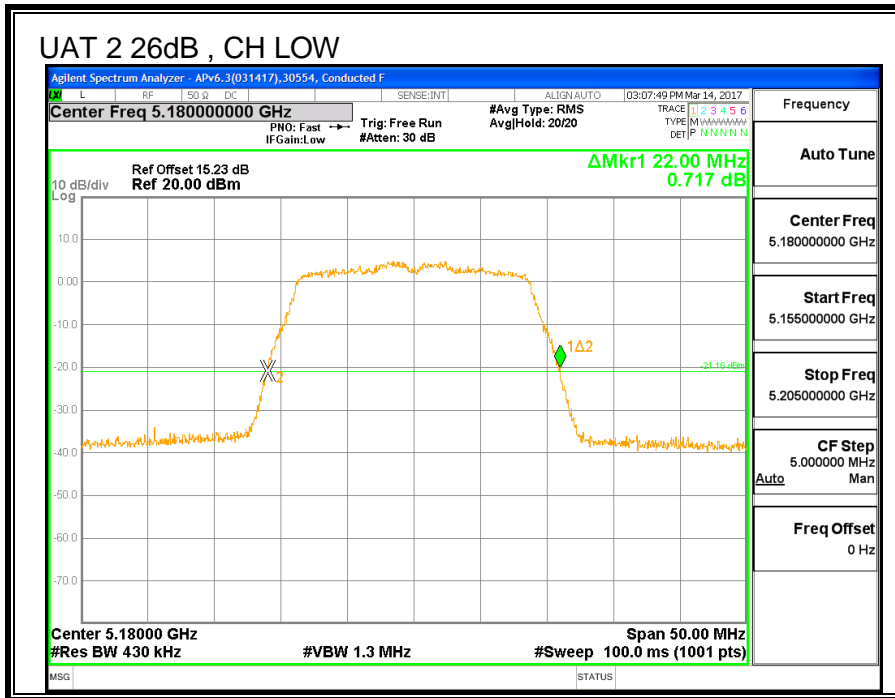

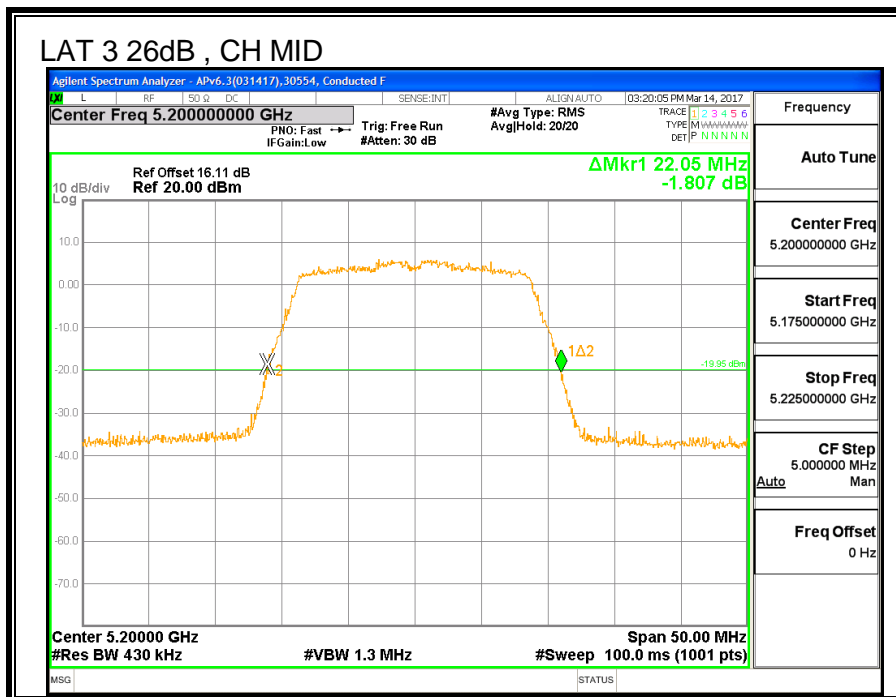
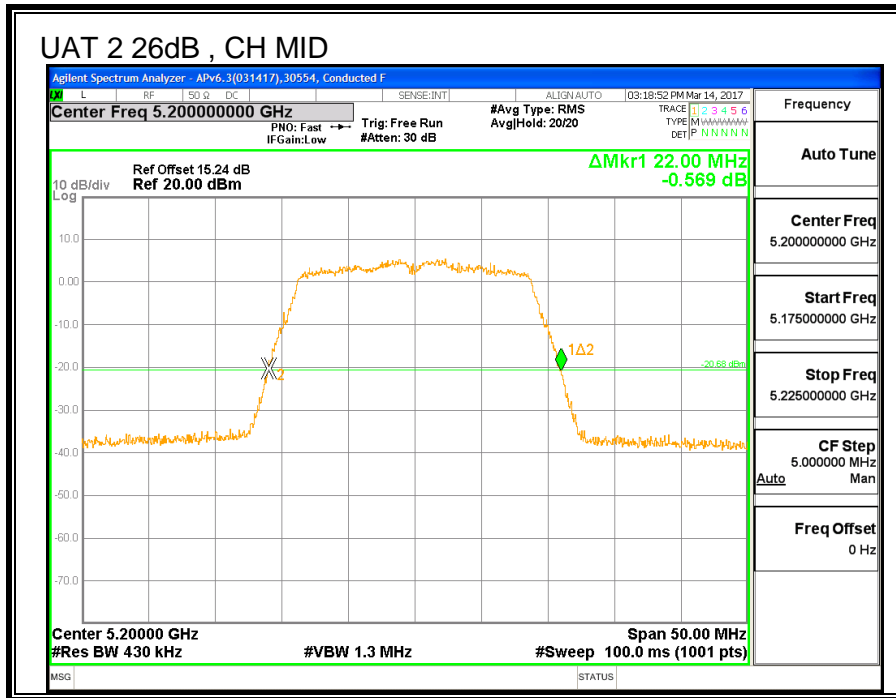

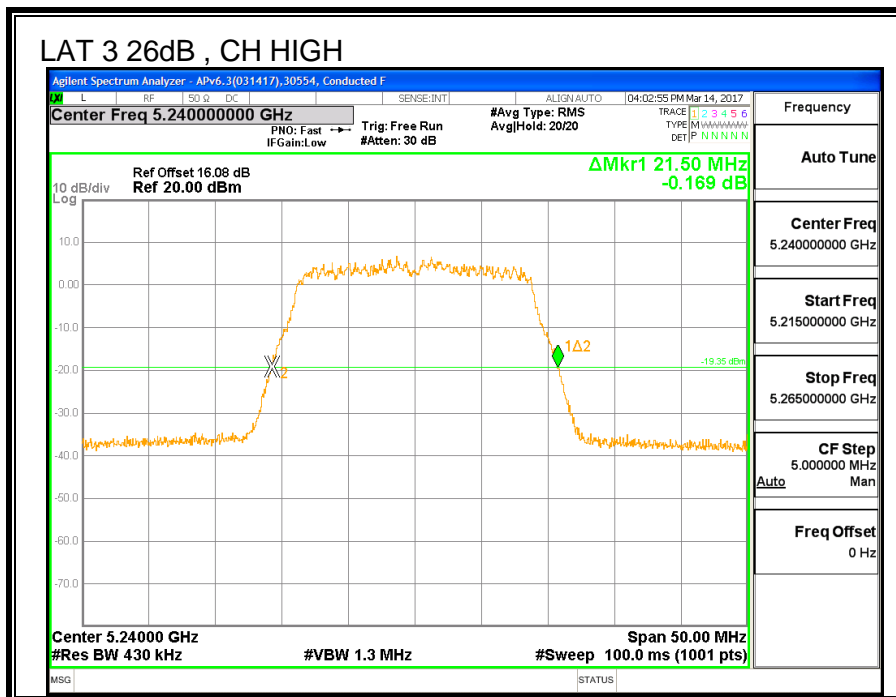
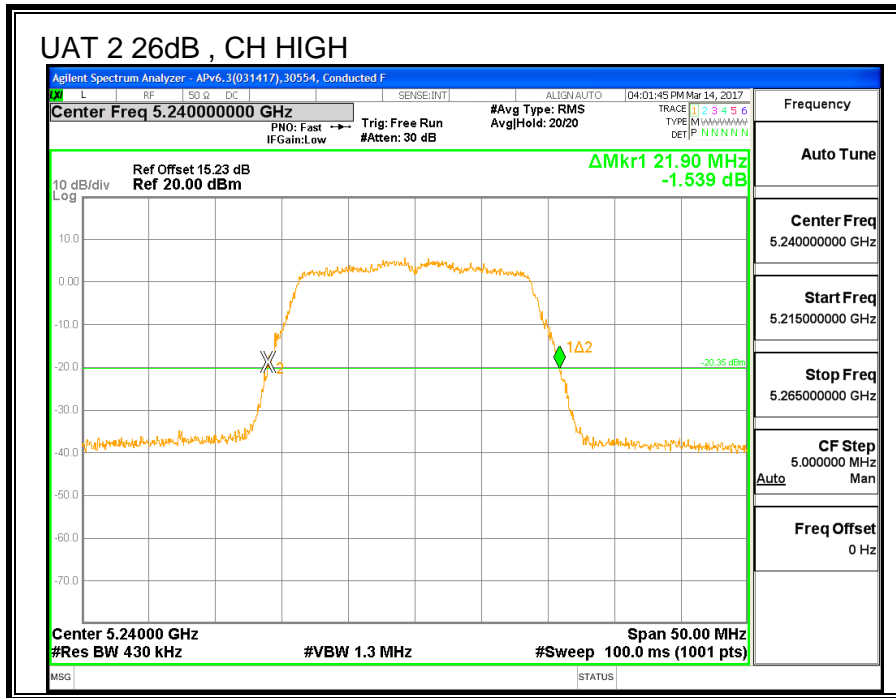

8.3.2. 99% BANDWIDTH

LIMITS

None; for reporting purposes only.

RESULTS

Channel	Frequency	99% BW UAT 2 (MHz)	99% BW LAT 3 (MHz)
Low	5180	17.708	17.908
Mid	5200	17.724	17.649
High	5240	17.656	17.789

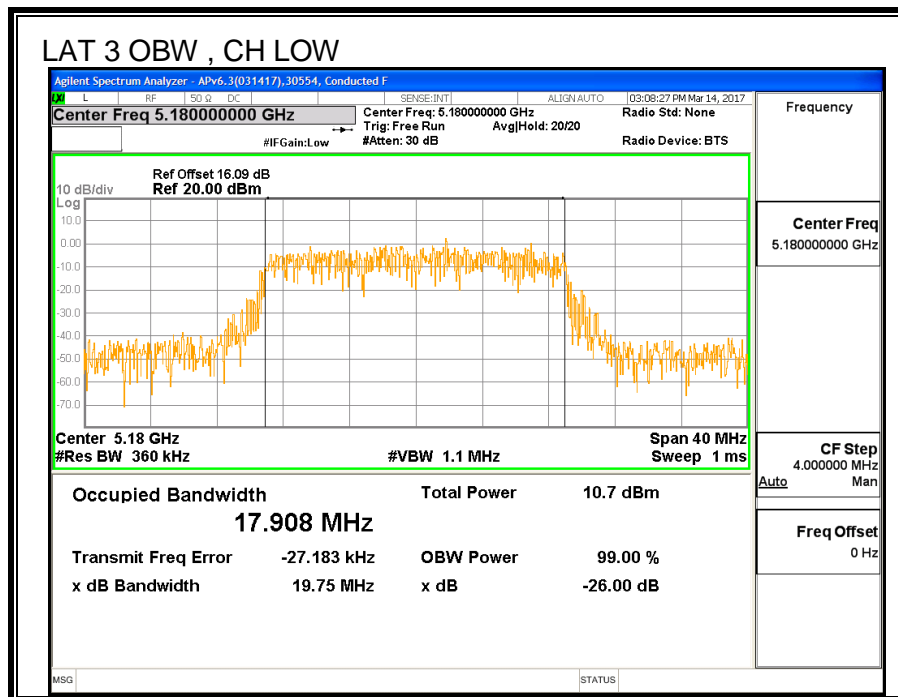
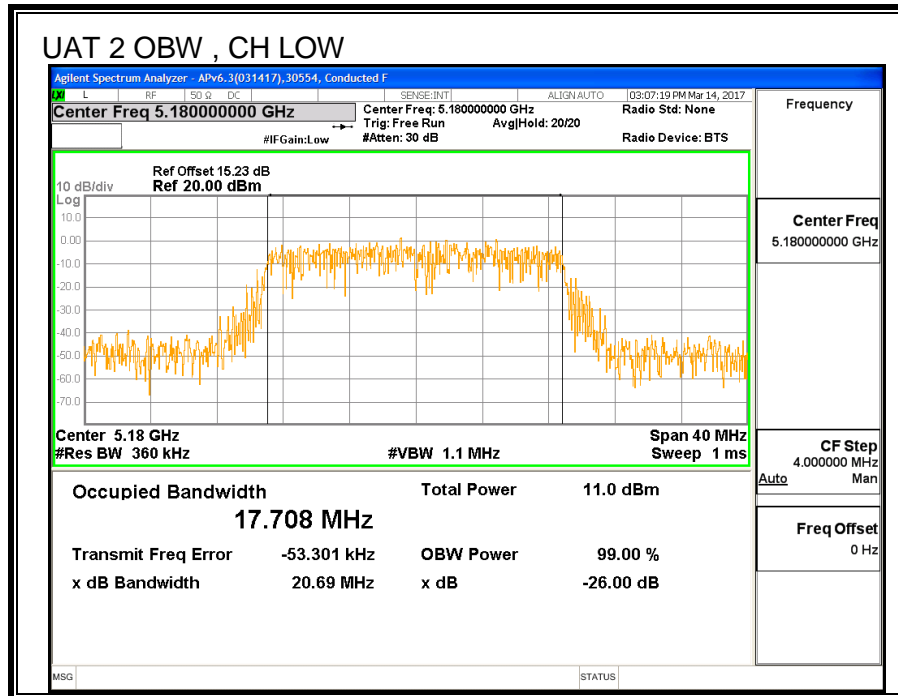

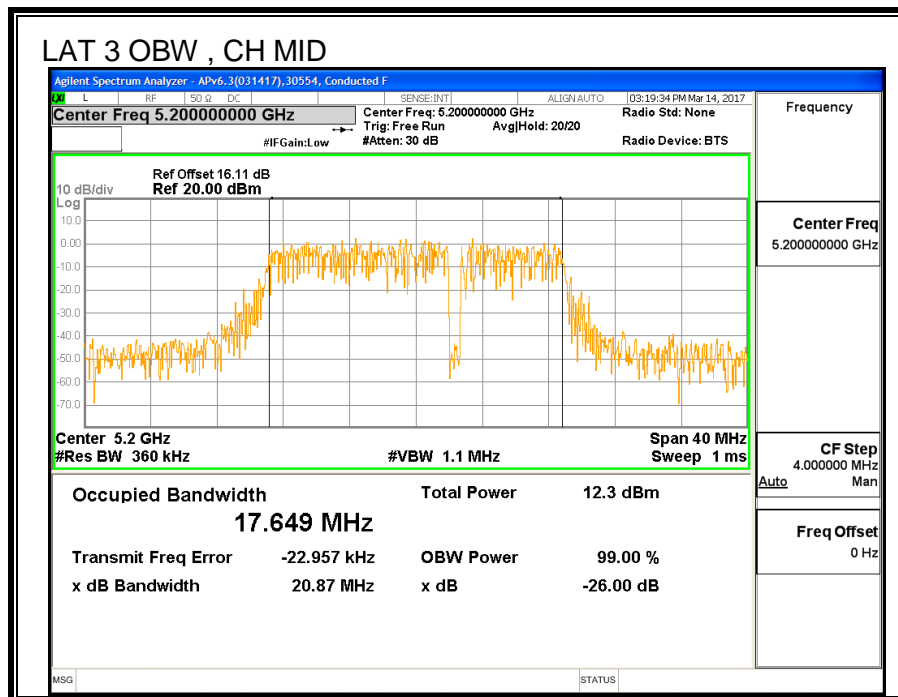
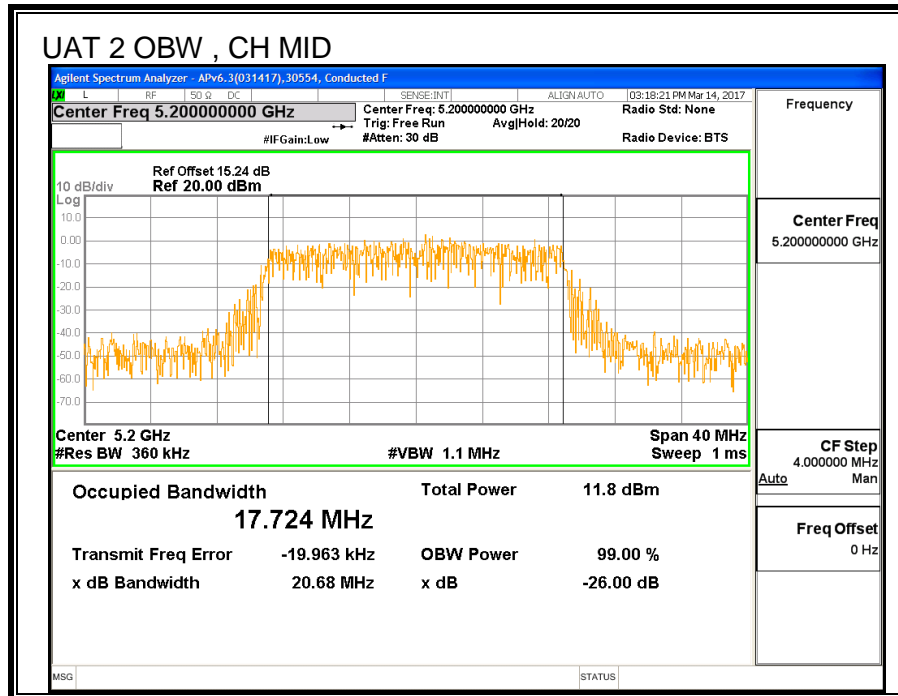

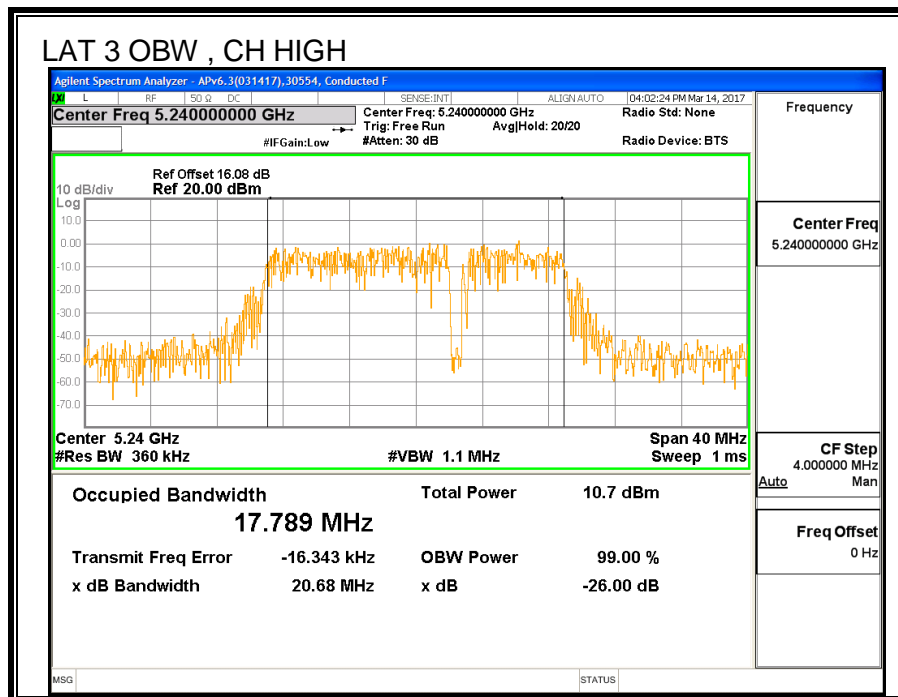
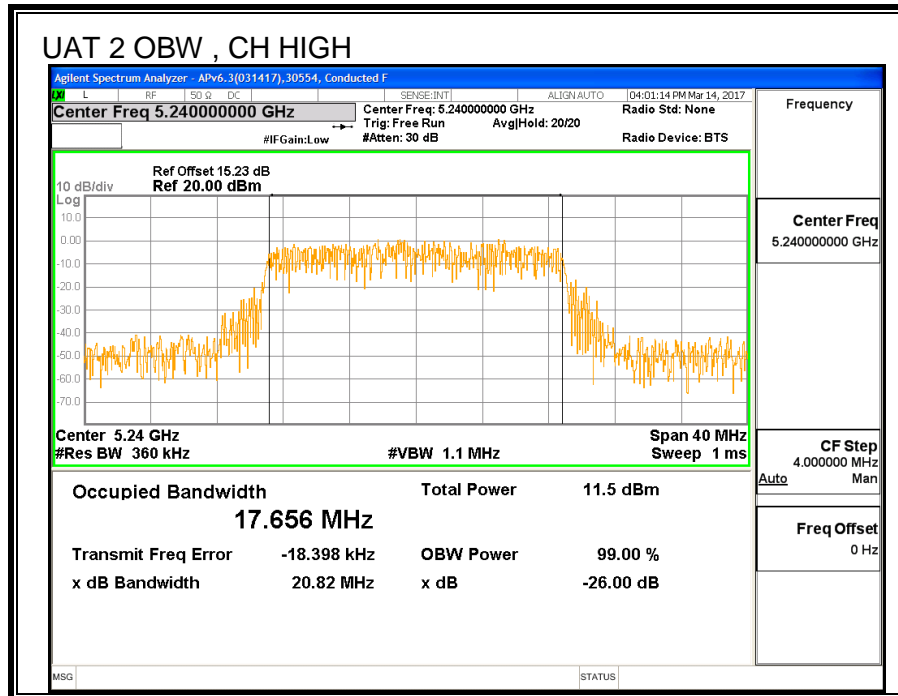

8.3.3. AVERAGE POWER

ID:	39472	Date:	6/11/17
------------	-------	--------------	---------

LIMITS

None; for reporting purposes only.

TEST PROCEDURE

Measurements perform using a wideband gated RF power meter.

RESULTS

Channel	Frequency	Power UAT 2 (dBm)	Power LAT 3 (dBm)	Total Power (dBm)
Low	5180	16.78	16.88	19.84
Mid	5200	17.82	17.98	20.91
High	5240	17.84	17.90	20.88

8.3.4. OUTPUT POWER AND PPSD

LIMITS

FCC §15.407 (a) (1)

(i) For an outdoor access point operating in the band 5.15-5.25 GHz, the maximum conducted output power over the frequency band of operation shall not exceed 1 W provided the maximum antenna gain does not exceed 6 dBi. In addition, the maximum power spectral density shall not exceed 17 dBm in any 1 megahertz band. If transmitting antennas of directional gain greater than 6 dBi are used, both the maximum conducted output power and the maximum power spectral density shall be reduced by the amount in dB that the directional gain of the antenna exceeds 6 dBi. The maximum e.i.r.p. at any elevation angle above 30 degrees as measured from the horizon must not exceed 125 mW (21 dBm).

(ii) For an indoor access point operating in the band 5.15-5.25 GHz, the maximum conducted output power over the frequency band of operation shall not exceed 1 W provided the maximum antenna gain does not exceed 6 dBi. In addition, the maximum power spectral density shall not exceed 17 dBm in any 1 megahertz band. If transmitting antennas of directional gain greater than 6 dBi are used, both the maximum conducted output power and the maximum power spectral density shall be reduced by the amount in dB that the directional gain of the antenna exceeds 6 dBi.

(iii) For fixed point-to-point access points operating in the band 5.15-5.25 GHz, the maximum conducted output power over the frequency band of operation shall not exceed 1 W. Fixed point-to-point U-NII devices may employ antennas with directional gain up to 23 dBi without any corresponding reduction in the maximum conducted output power or maximum power spectral density. For fixed point-to-point transmitters that employ a directional antenna gain greater than 23 dBi, a 1 dB reduction in maximum conducted output power and maximum power spectral density is required for each 1 dB of antenna gain in excess of 23 dBi. Fixed, point-to-point operations exclude the use of point-to-multipoint systems, omnidirectional applications, and multiple collocated transmitters transmitting the same information. The operator of the U-NII device, or if the equipment is professionally installed, the installer, is responsible for ensuring that systems employing high gain directional antennas are used exclusively for fixed, point-to-point operations.

(iv) For mobile and portable client devices in the 5.15-5.25 GHz band, the maximum conducted output power over the frequency band of operation shall not exceed 250 mW provided the maximum antenna gain does not exceed 6 dBi. In addition, the maximum power spectral density shall not exceed 11 dBm in any 1 megahertz band. If transmitting antennas of directional gain greater than 6 dBi are used, both the maximum conducted output power and the maximum power spectral density shall be reduced by the amount in dB that the directional gain of the antenna exceeds 6 dBi.

TEST PROCEDURE

Measurements perform using a wideband gated RF power meter provided that the gate parameters are adjusted such that the power is measured only when the EUT is transmitting at its maximum power control level. Since the measurement is made only during the ON time of the transmitter, no duty cycle correction factor is required.

PSD test procedure: KDB 789033 D02 v01r04 Section F (SA-2 method)

DIRECTIONAL ANTENNA GAIN

For Power used uncorrelated gain: The TX chains are uncorrelated and the antenna gain is unequal among the chains. The directional gain is:

UAT 2 Antenna Gain (dBi)	LAT 3 Antenna Gain (dBi)	Uncorrelated Chains Directional Gain (dBi)
-4.61	-0.98	-2.43

For PSD used correlated gain: The TX chains are correlated and the antenna gain is unequal among the chains. The directional gain is:

UAT 2 Antenna Gain (dBi)	LAT 3 Antenna Gain (dBi)	Correlated Chains Directional Gain (dBi)
-4.61	-0.98	0.40

RESULTS

Antenna Gain and Limits

Channel	Frequency (MHz)	Directional Gain for Power (dBi)	Directional Gain for PSD (dBi)	Power Limit (dBm)	PSD Limit (dBm)
Low	5180	-2.43	0.40	24.00	11.00
Mid	5200	-2.43	0.40	24.00	11.00
High	5240	-2.43	0.40	24.00	11.00

Duty Cycle CF (dB)	0.00	Included in Calculations of Corr'd PSD
---------------------------	------	-----------------------------------------------

Output Power Results

Channel	Frequency (MHz)	UAT 2 Meas Power (dBm)	LAT 3 Meas Power (dBm)	Total Corr'd Power (dBm)	Power Limit (dBm)	Power Margin (dB)
Low	5180	16.78	16.88	19.84	24.00	-4.16
Mid	5200	17.82	17.98	20.91	24.00	-3.09
High	5240	17.84	17.90	20.88	24.00	-3.12

PSD Results

Channel	Frequency (MHz)	UAT 2 Meas PSD (dBm)	LAT 3 Meas PSD (dBm)	Total Corr'd PSD (dBm)	PSD Limit (dBm)	PSD Margin (dB)
Low	5180	7.160	7.461	10.32	11.00	-0.68
Mid	5200	7.180	7.242	10.22	11.00	-0.78
High	5240	7.066	7.179	10.13	11.00	-0.87

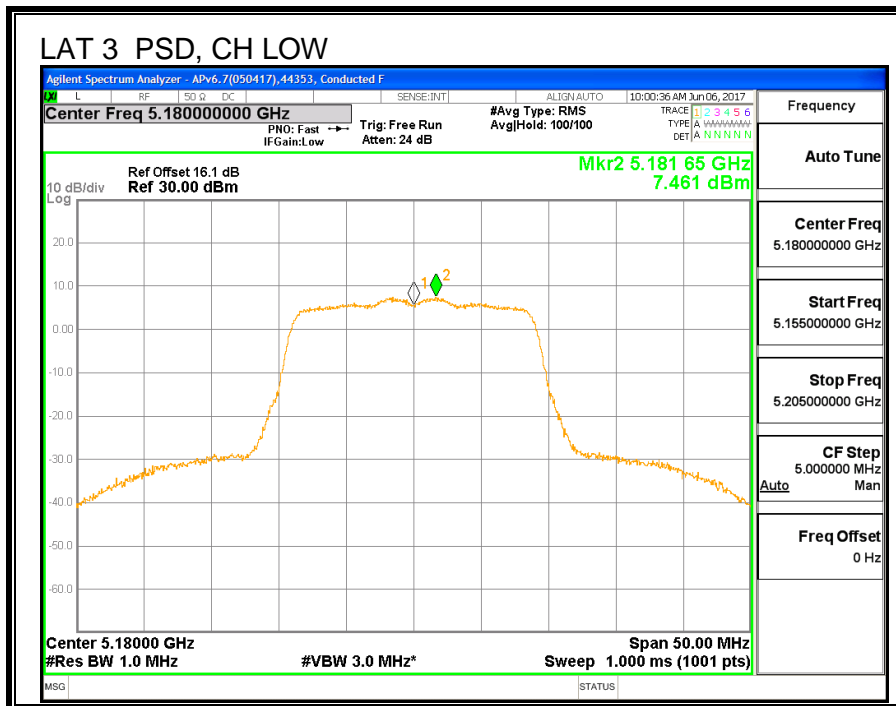
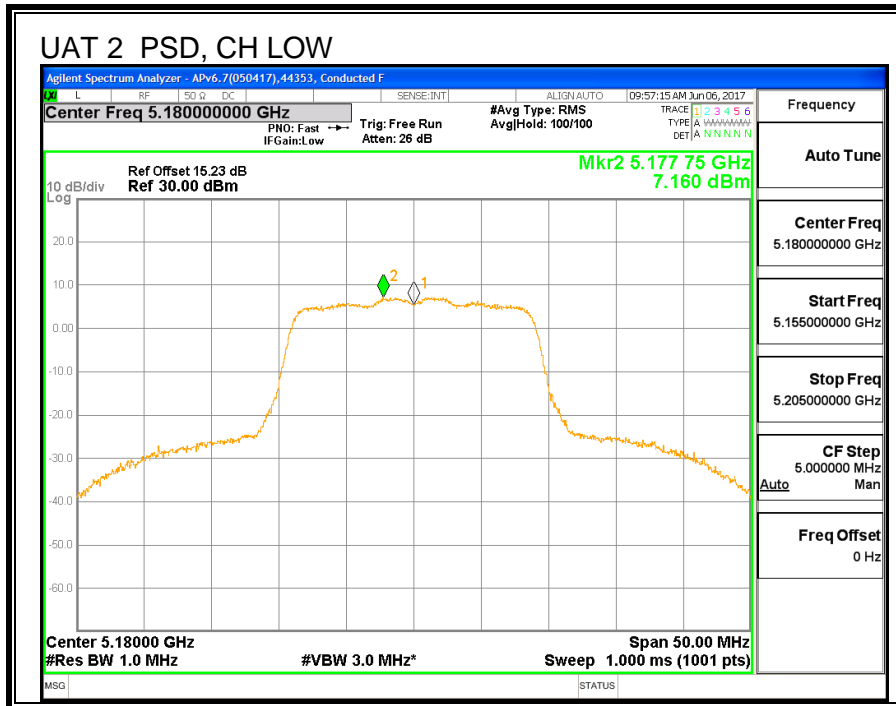

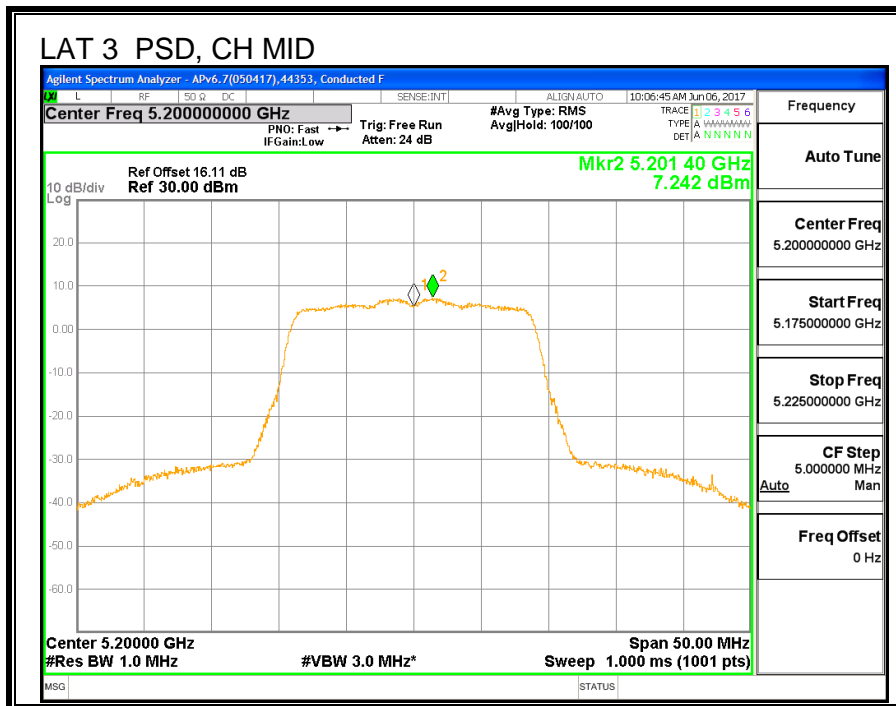
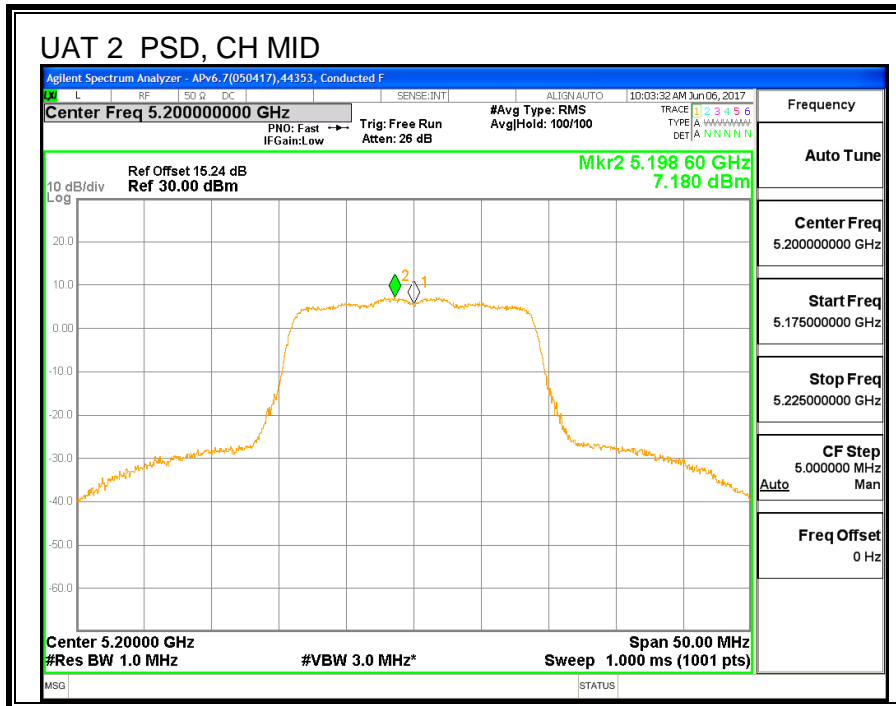

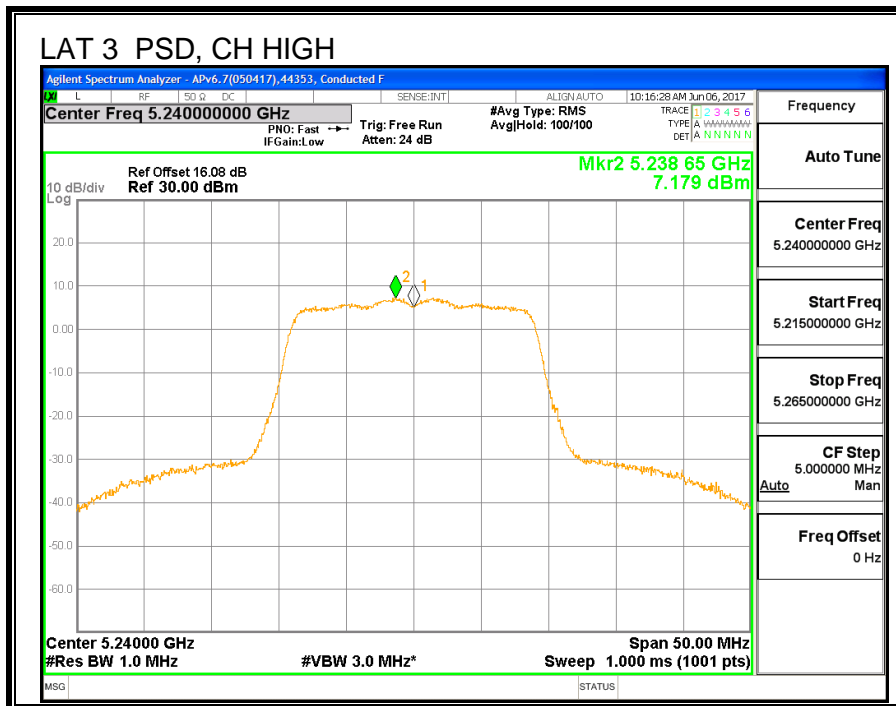
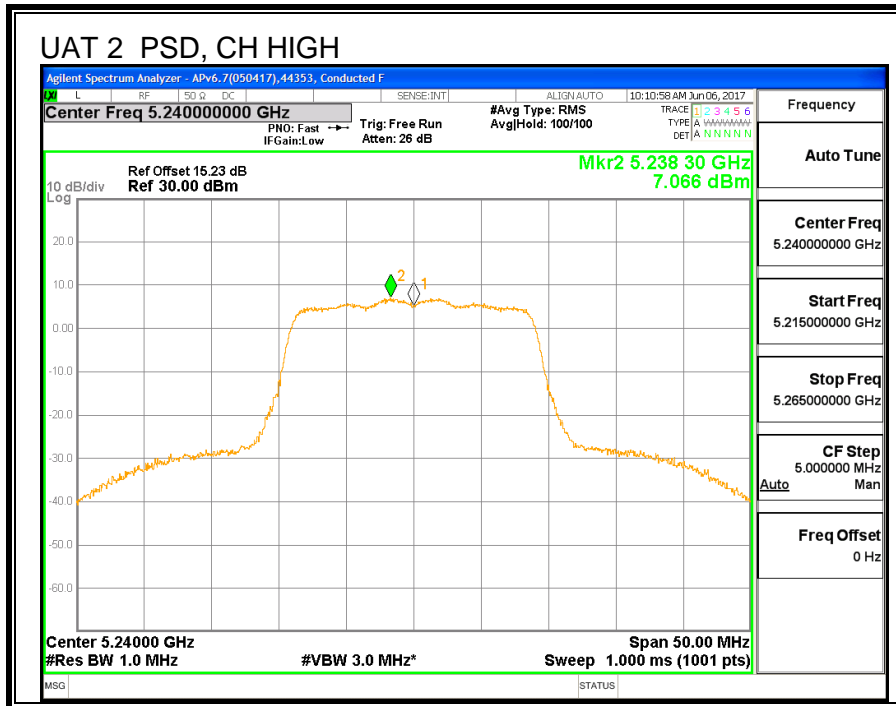

8.4. 11n HT40 UAT 2 SISO MODE IN THE 5.2GHz BAND

8.4.1. 26 dB BANDWIDTH

LIMITS

None; for reporting purposes only.

RESULTS

Channel	Frequency	26 dB BW UAT 2 (MHz)
Low	5190	40.7
High	5230	40.5

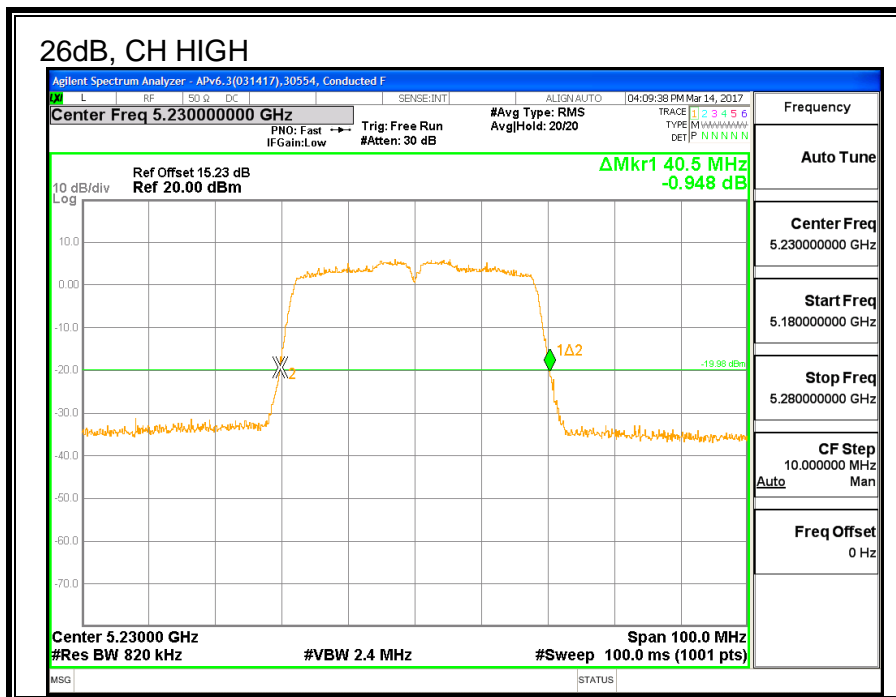
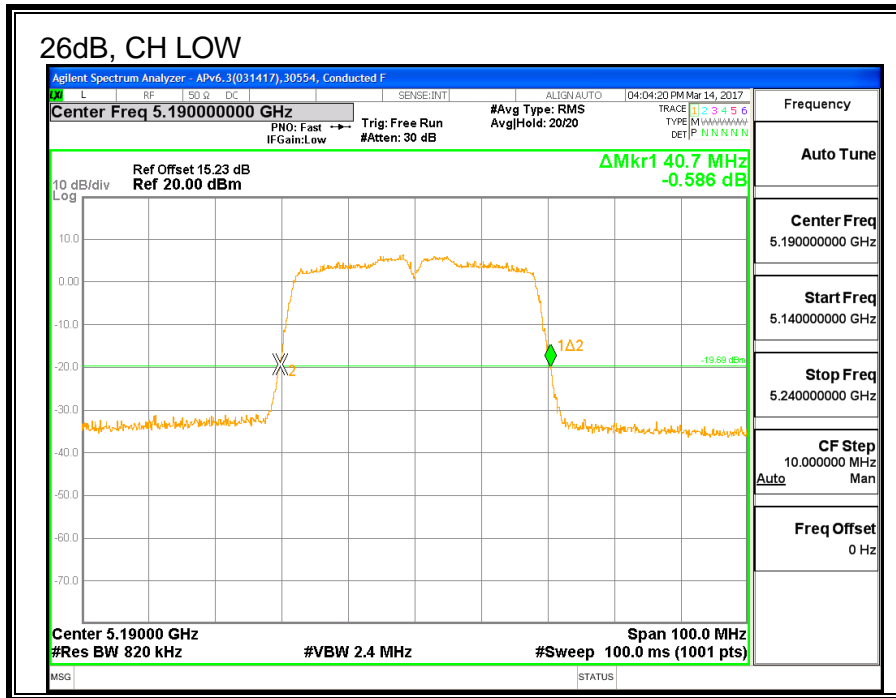

8.4.2. 99% BANDWIDTH

LIMITS

None; for reporting purposes only.

RESULTS

Channel	Frequency	99% BW UAT 2 (MHz)
Low	5190	36.187
High	5230	36.253

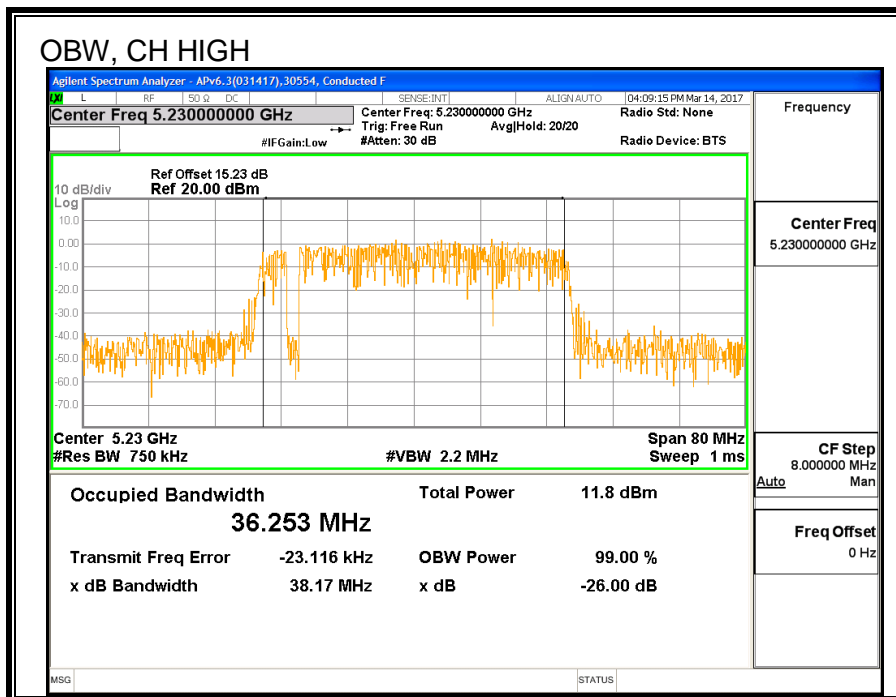
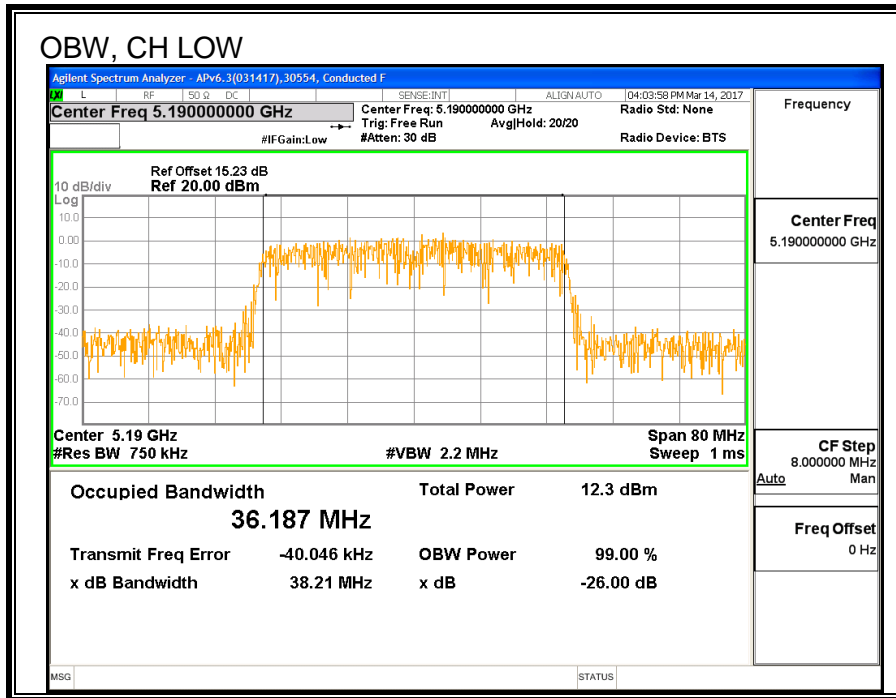

8.4.3. AVERAGE POWER

ID:	39472	Date:	6/11/17
------------	-------	--------------	---------

LIMITS

None; for reporting purposes only.

TEST PROCEDURE

Measurements perform using a wideband gated RF power meter.

RESULTS

Channel	Frequency	Power UAT 2 (dBm)
Low	5190	15.46
High	5230	18.38

8.4.4. OUTPUT POWER AND PPSD

LIMITS

FCC §15.407 (a) (1)

(i) For an outdoor access point operating in the band 5.15-5.25 GHz, the maximum conducted output power over the frequency band of operation shall not exceed 1 W provided the maximum antenna gain does not exceed 6 dBi. In addition, the maximum power spectral density shall not exceed 17 dBm in any 1 megahertz band. If transmitting antennas of directional gain greater than 6 dBi are used, both the maximum conducted output power and the maximum power spectral density shall be reduced by the amount in dB that the directional gain of the antenna exceeds 6 dBi. The maximum e.i.r.p. at any elevation angle above 30 degrees as measured from the horizon must not exceed 125 mW (21 dBm).

(ii) For an indoor access point operating in the band 5.15-5.25 GHz, the maximum conducted output power over the frequency band of operation shall not exceed 1 W provided the maximum antenna gain does not exceed 6 dBi. In addition, the maximum power spectral density shall not exceed 17 dBm in any 1 megahertz band. If transmitting antennas of directional gain greater than 6 dBi are used, both the maximum conducted output power and the maximum power spectral density shall be reduced by the amount in dB that the directional gain of the antenna exceeds 6 dBi.

(iii) For fixed point-to-point access points operating in the band 5.15-5.25 GHz, the maximum conducted output power over the frequency band of operation shall not exceed 1 W. Fixed point-to-point U-NII devices may employ antennas with directional gain up to 23 dBi without any corresponding reduction in the maximum conducted output power or maximum power spectral density. For fixed point-to-point transmitters that employ a directional antenna gain greater than 23 dBi, a 1 dB reduction in maximum conducted output power and maximum power spectral density is required for each 1 dB of antenna gain in excess of 23 dBi. Fixed, point-to-point operations exclude the use of point-to-multipoint systems, omnidirectional applications, and multiple collocated transmitters transmitting the same information. The operator of the U-NII device, or if the equipment is professionally installed, the installer, is responsible for ensuring that systems employing high gain directional antennas are used exclusively for fixed, point-to-point operations.

(iv) For mobile and portable client devices in the 5.15-5.25 GHz band, the maximum conducted output power over the frequency band of operation shall not exceed 250 mW provided the maximum antenna gain does not exceed 6 dBi. In addition, the maximum power spectral density shall not exceed 11 dBm in any 1 megahertz band. If transmitting antennas of directional gain greater than 6 dBi are used, both the maximum conducted output power and the maximum power spectral density shall be reduced by the amount in dB that the directional gain of the antenna exceeds 6 dBi.

TEST PROCEDURE

Measurements perform using a wideband gated RF power meter provided that the gate parameters are adjusted such that the power is measured only when the EUT is transmitting at its maximum power control level. Since the measurement is made only during the ON time of the transmitter, no duty cycle correction factor is required.

PSD test procedure: KDB 789033 D02 v01r04 Section F (SA-2 method)

DIRECTIONAL ANTENNA GAIN

There is only one transmitter output therefore the directional gain is equal to the antenna gain.

RESULTS

Antenna Gain and Limits

Channel	Frequency (MHz)	Directional Gain for Power (dBi)	Directional Gain for PSD (dBi)	Power Limit (dBm)	PSD Limit (dBm)
Low	5190	-4.61	-4.61	24.00	11.00
High	5230	-4.61	-4.61	24.00	11.00

Duty Cycle CF (dB)	0.09	Included in Calculations of Corr'PSD
---------------------------	------	---------------------------------------------

Output Power Results

Channel	Frequency (MHz)	UAT 2 Meas Power (dBm)	Total Corr'd Power (dBm)	Power Limit (dBm)	Power Margin (dB)
Low	5190	15.46	15.46	24.00	-8.54
High	5230	18.38	18.38	24.00	-5.62

PSD Results

Channel	Frequency (MHz)	UAT 2 Meas PSD (dBm)	Total Corr'd PSD (dBm)	PSD Limit (dBm)	PSD Margin (dB)
Low	5190	3.976	4.07	11.00	-6.93
High	5230	6.828	6.92	11.00	-4.08

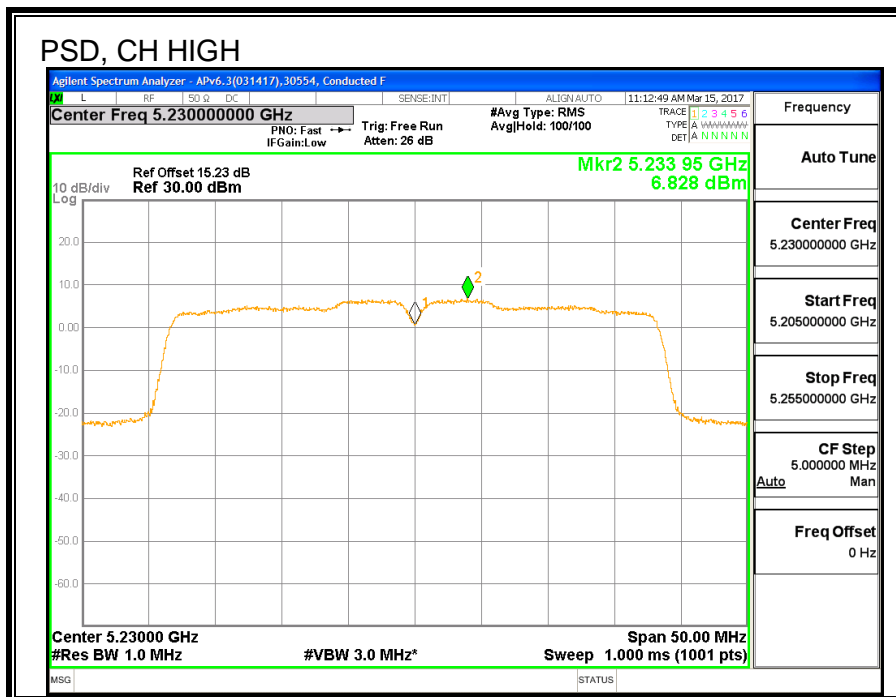
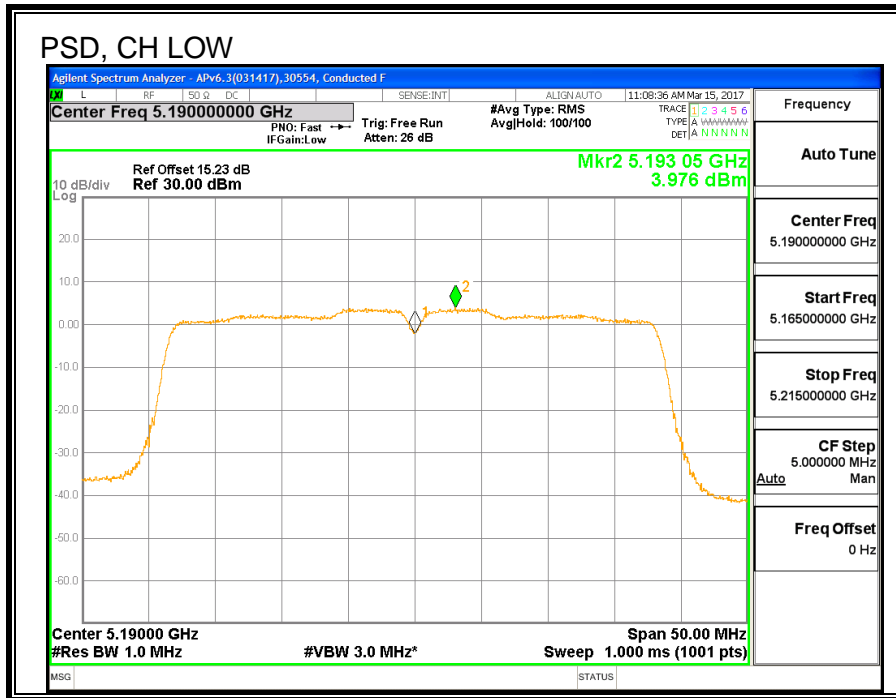

8.5. 11n HT40 LAT 3 SISO MODE IN THE 5.2GHz BAND

8.5.1. 26 dB BANDWIDTH

LIMITS

None; for reporting purposes only.

RESULTS

Channel	Frequency	26 dB BW LAT 3 (MHz)
Low	5190	40.7
High	5230	40.5

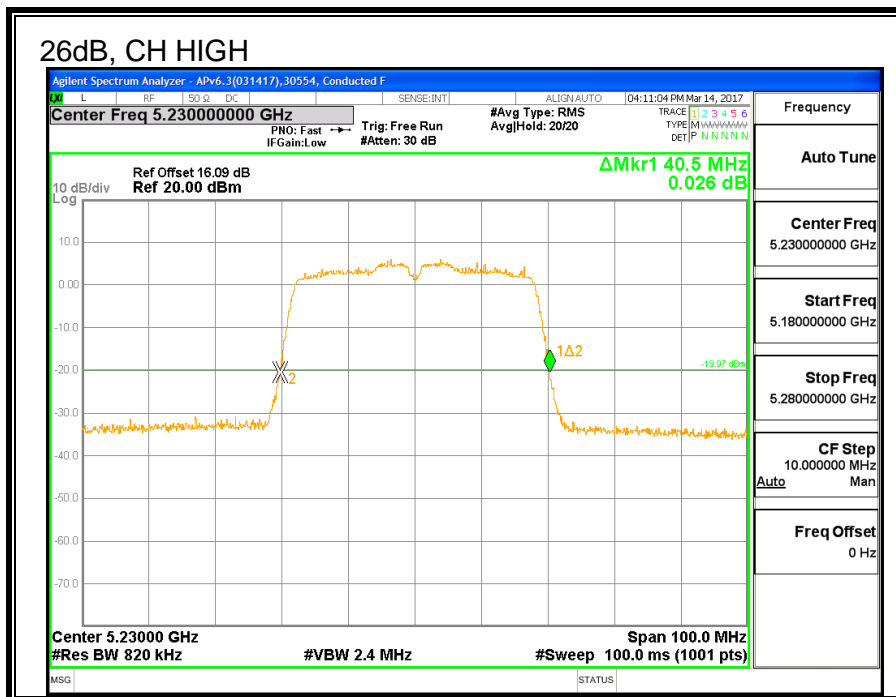
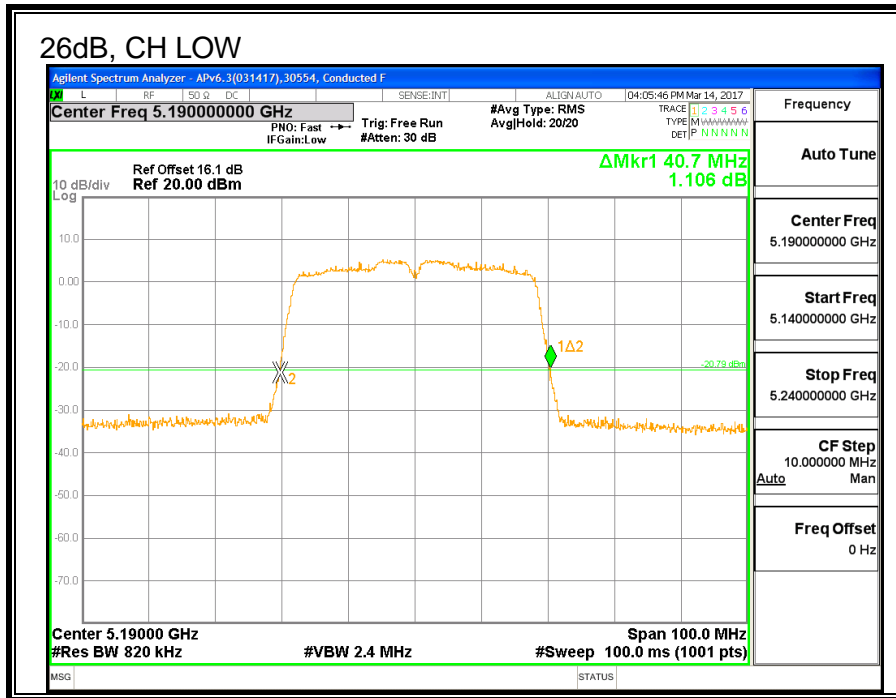

8.5.2. 99% BANDWIDTH

LIMITS

None; for reporting purposes only.

RESULTS

Channel	Frequency	99% BW LAT 3 (MHz)
Low	5190	36.132
High	5230	36.198

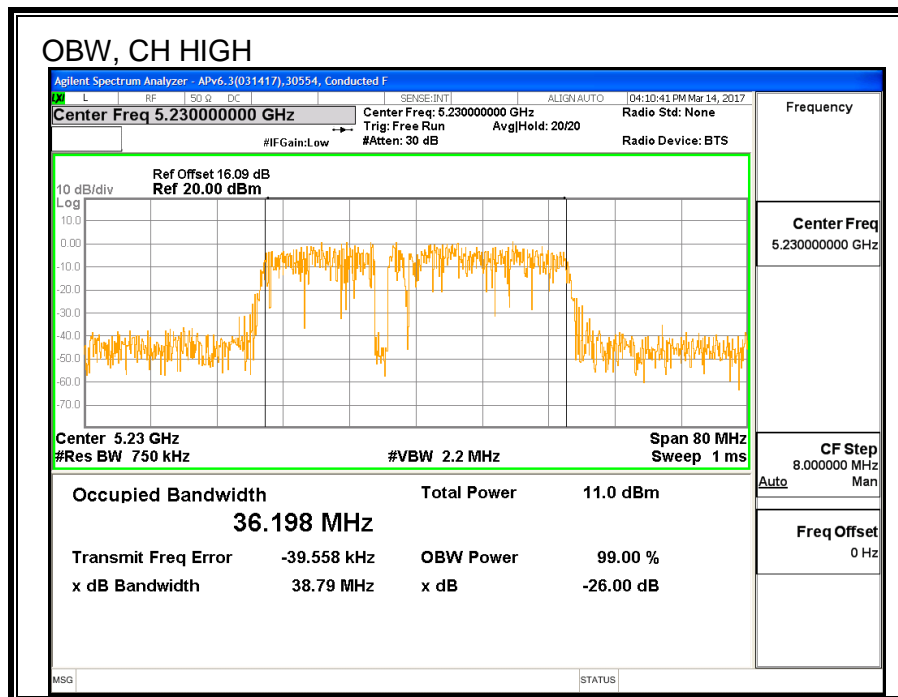
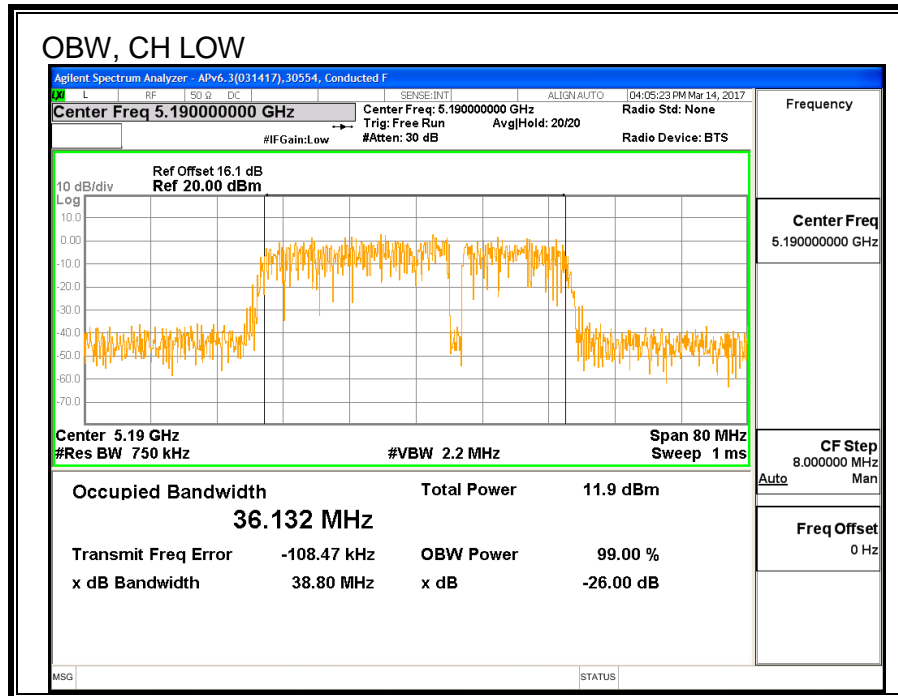

8.5.3. AVERAGE POWER

ID:	39472	Date:	6/11/17
------------	-------	--------------	---------

LIMITS

None; for reporting purposes only.

TEST PROCEDURE

Measurements perform using a wideband gated RF power meter.

RESULTS

Channel	Frequency	Power LAT 3 (dBm)
Low	5190	15.48
High	5230	18.46

8.5.4. OUTPUT POWER AND PPSD

LIMITS

FCC §15.407 (a) (1)

(i) For an outdoor access point operating in the band 5.15-5.25 GHz, the maximum conducted output power over the frequency band of operation shall not exceed 1 W provided the maximum antenna gain does not exceed 6 dBi. In addition, the maximum power spectral density shall not exceed 17 dBm in any 1 megahertz band. If transmitting antennas of directional gain greater than 6 dBi are used, both the maximum conducted output power and the maximum power spectral density shall be reduced by the amount in dB that the directional gain of the antenna exceeds 6 dBi. The maximum e.i.r.p. at any elevation angle above 30 degrees as measured from the horizon must not exceed 125 mW (21 dBm).

(ii) For an indoor access point operating in the band 5.15-5.25 GHz, the maximum conducted output power over the frequency band of operation shall not exceed 1 W provided the maximum antenna gain does not exceed 6 dBi. In addition, the maximum power spectral density shall not exceed 17 dBm in any 1 megahertz band. If transmitting antennas of directional gain greater than 6 dBi are used, both the maximum conducted output power and the maximum power spectral density shall be reduced by the amount in dB that the directional gain of the antenna exceeds 6 dBi.

(iii) For fixed point-to-point access points operating in the band 5.15-5.25 GHz, the maximum conducted output power over the frequency band of operation shall not exceed 1 W. Fixed point-to-point U-NII devices may employ antennas with directional gain up to 23 dBi without any corresponding reduction in the maximum conducted output power or maximum power spectral density. For fixed point-to-point transmitters that employ a directional antenna gain greater than 23 dBi, a 1 dB reduction in maximum conducted output power and maximum power spectral density is required for each 1 dB of antenna gain in excess of 23 dBi. Fixed, point-to-point operations exclude the use of point-to-multipoint systems, omnidirectional applications, and multiple collocated transmitters transmitting the same information. The operator of the U-NII device, or if the equipment is professionally installed, the installer, is responsible for ensuring that systems employing high gain directional antennas are used exclusively for fixed, point-to-point operations.

(iv) For mobile and portable client devices in the 5.15-5.25 GHz band, the maximum conducted output power over the frequency band of operation shall not exceed 250 mW provided the maximum antenna gain does not exceed 6 dBi. In addition, the maximum power spectral density shall not exceed 11 dBm in any 1 megahertz band. If transmitting antennas of directional gain greater than 6 dBi are used, both the maximum conducted output power and the maximum power spectral density shall be reduced by the amount in dB that the directional gain of the antenna exceeds 6 dBi.

TEST PROCEDURE

Measurements perform using a wideband gated RF power meter provided that the gate parameters are adjusted such that the power is measured only when the EUT is transmitting at its maximum power control level. Since the measurement is made only during the ON time of the transmitter, no duty cycle correction factor is required.

PSD test procedure: KDB 789033 D02 v01r04 Section F (SA-2 method)

DIRECTIONAL ANTENNA GAIN

There is only one transmitter output therefore the directional gain is equal to the antenna gain.

RESULTS

Antenna Gain and Limits

Channel	Frequency (MHz)	Directional Gain for Power (dBi)	Directional Gain for PSD (dBi)	Power Limit (dBm)	PSD Limit (dBm)
Low	5190	-0.98	-0.98	24.00	11.00
High	5230	-0.98	-0.98	24.00	11.00

Duty Cycle CF (dB)	0.09	Included in Calculations of Corr'PSD
---------------------------	------	---------------------------------------------

Output Power Results

Channel	Frequency (MHz)	LAT 3 Meas Power (dBm)	Total Corr'd Power (dBm)	Power Limit (dBm)	Power Margin (dB)
Low	5190	15.48	15.48	24.00	-8.52
High	5230	18.46	18.46	24.00	-5.54

PSD Results

Channel	Frequency (MHz)	LAT 3 Meas PSD (dBm)	Total Corr'd PSD (dBm)	PSD Limit (dBm)	PSD Margin (dB)
Low	5190	3.652	3.74	11.00	-7.26
High	5230	6.426	6.52	11.00	-4.48

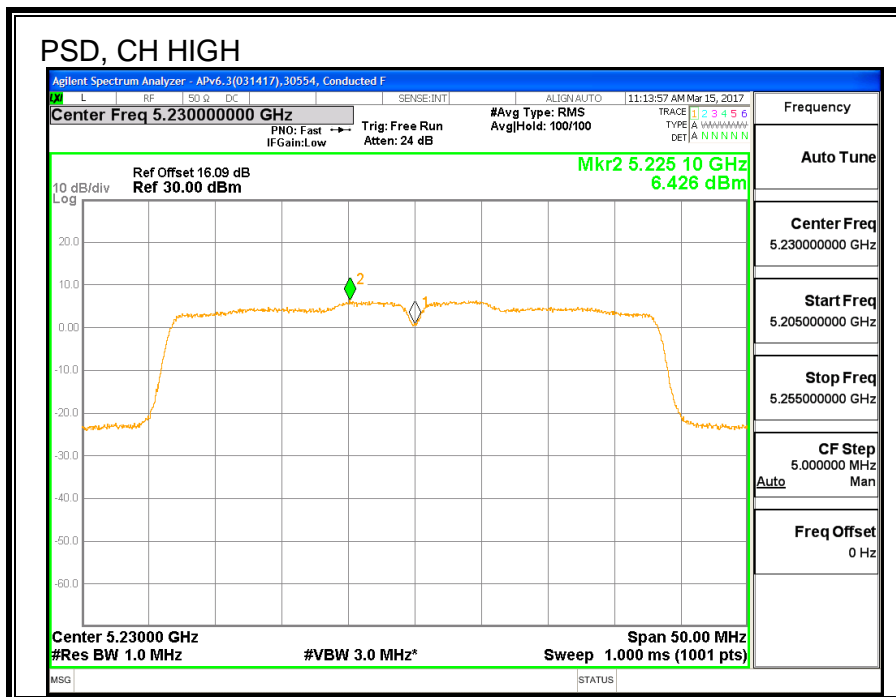
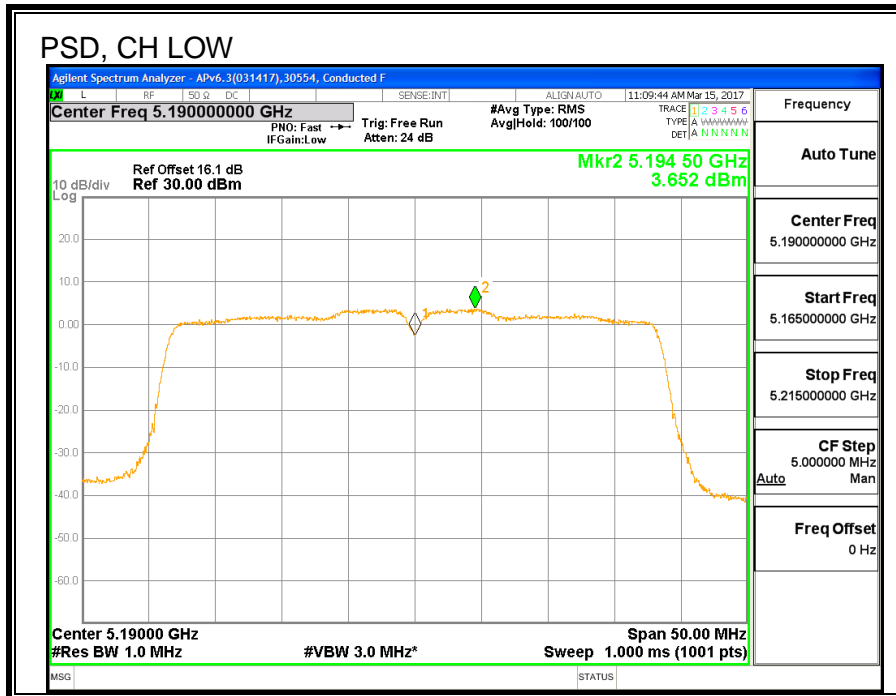

8.6. 11n HT40 2TX CDD MIMO MODE IN THE 5.2GHz BAND

8.6.1. 26 dB BANDWIDTH

LIMITS

None; for reporting purposes only.

RESULTS

Channel	Frequency	26 dB BW UAT 2 (MHz)	26 dB BW LAT 3 (MHz)
Low	5190	40.5	40.2
High	5230	40.4	40.2

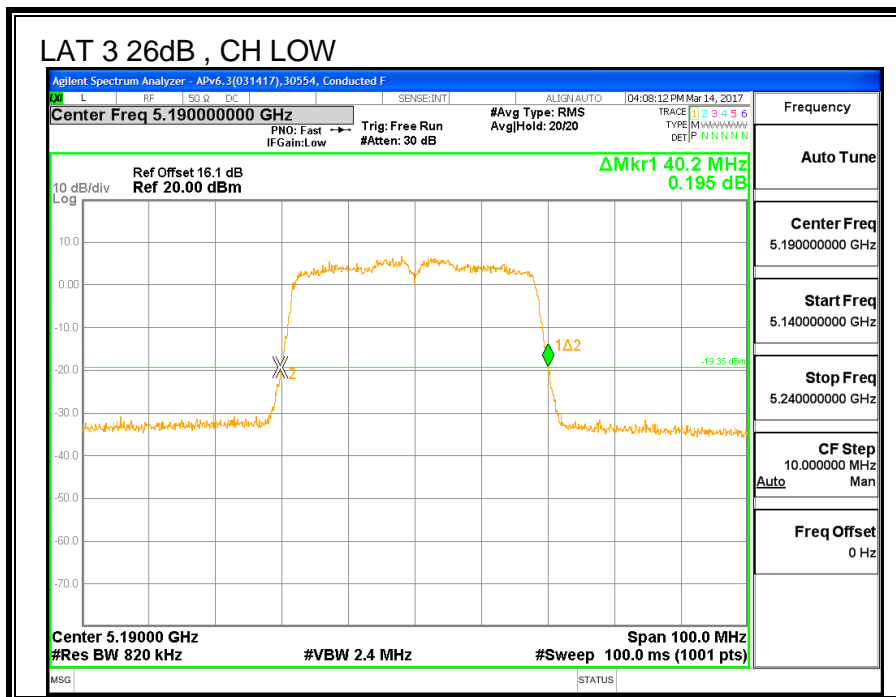
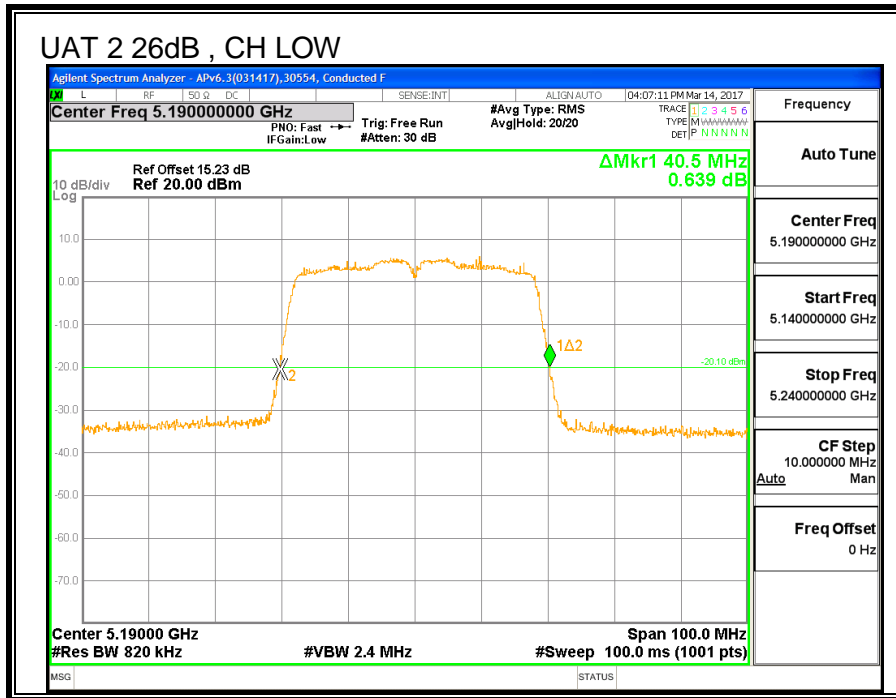

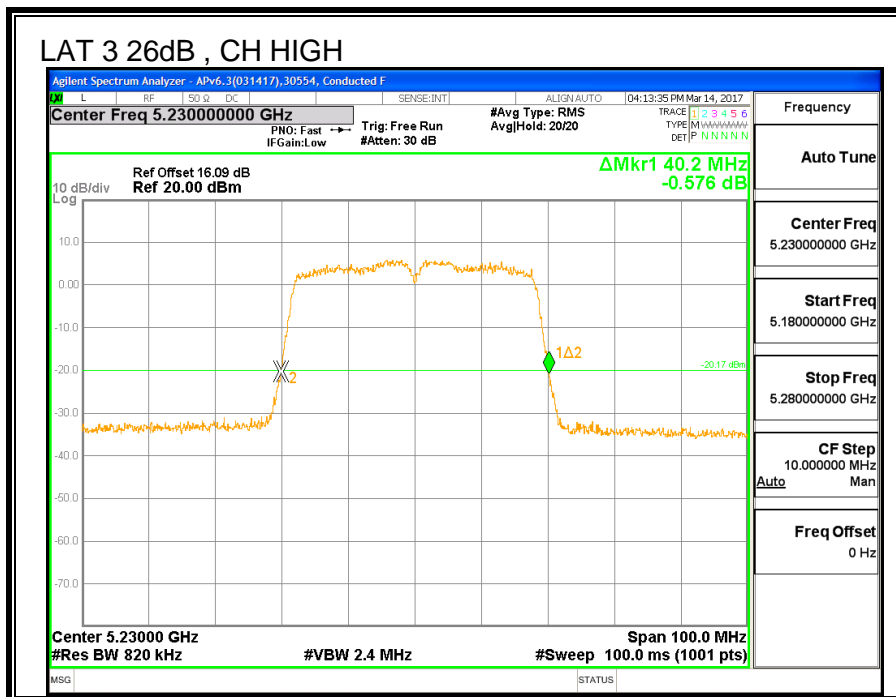
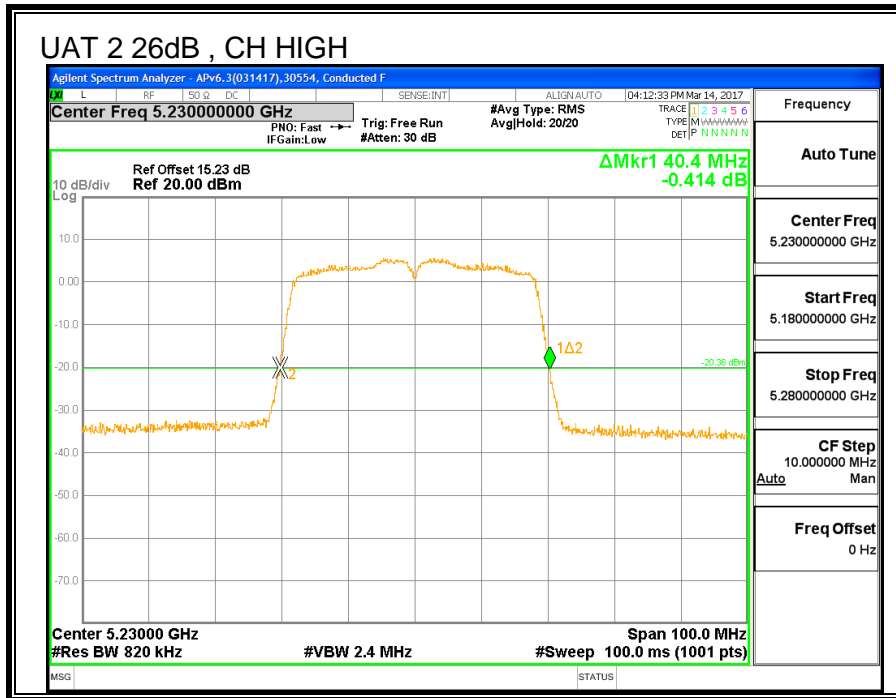

8.6.2. 99% BANDWIDTH

LIMITS

None; for reporting purposes only.

RESULTS

Channel	Frequency	99% BW UAT 2 (MHz)	99% BW LAT 3 (MHz)
Low	5190	36.179	36.250
High	5230	36.221	36.136

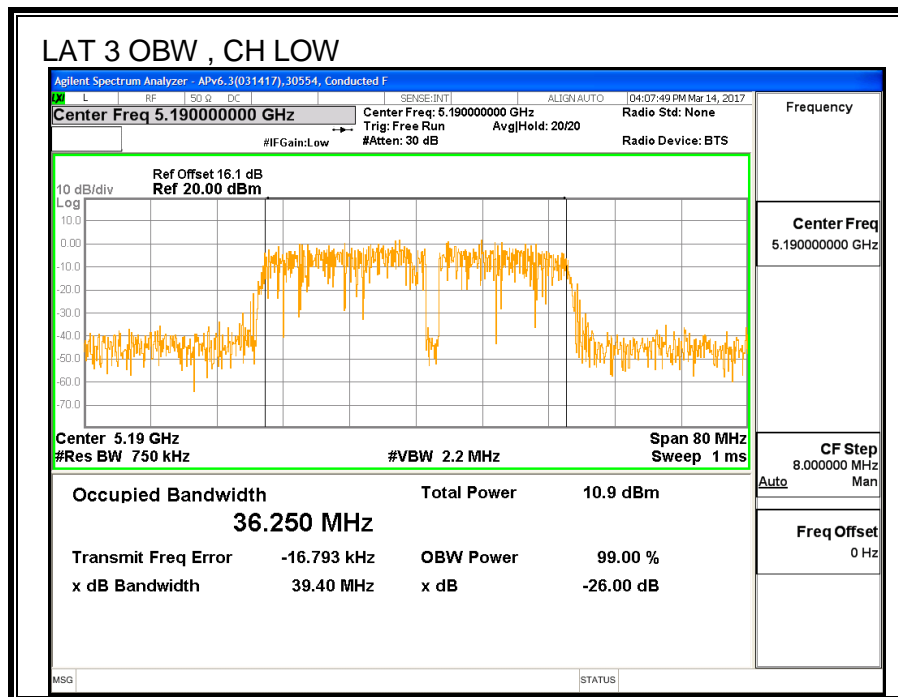
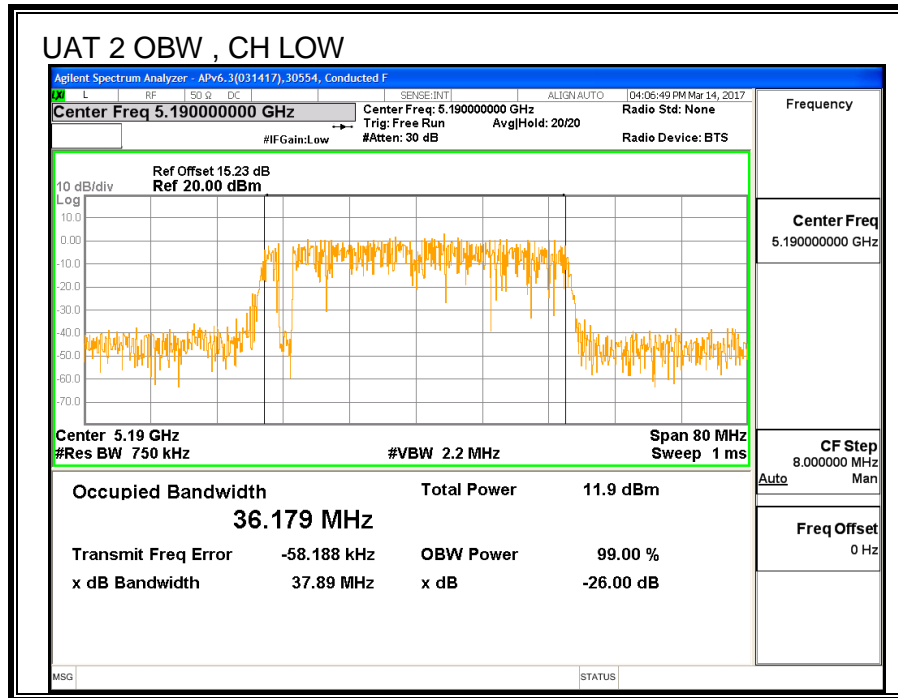

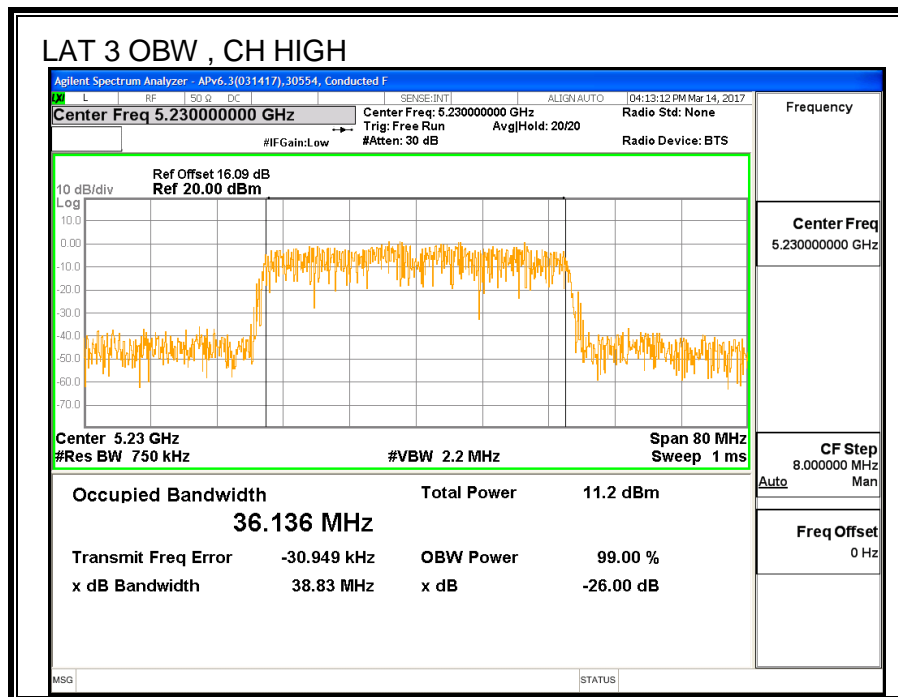
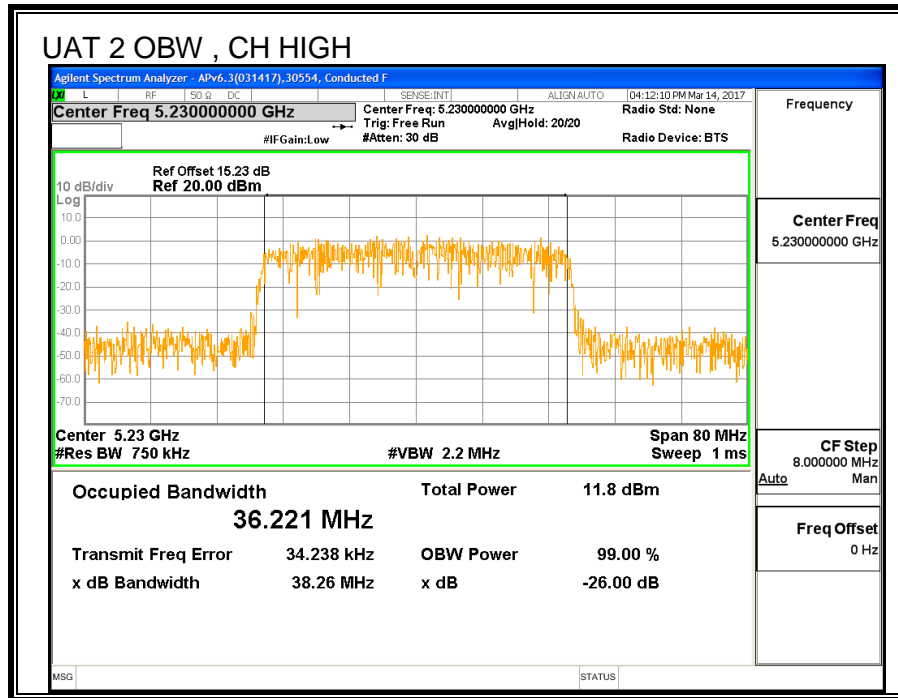

8.6.3. AVERAGE POWER

ID:	39472	Date:	6/11/17
------------	-------	--------------	---------

LIMITS

None; for reporting purposes only.

TEST PROCEDURE

Measurements perform using a wideband gated RF power meter.

RESULTS

Channel	Frequency	Power UAT 2 (dBm)	Power LAT 3 (dBm)	Total Power (dBm)
Low	5190	13.78	13.82	16.81
High	5230	18.31	18.50	21.41

8.6.4. OUTPUT POWER AND PPSD

LIMITS

FCC §15.407 (a) (1)

(i) For an outdoor access point operating in the band 5.15-5.25 GHz, the maximum conducted output power over the frequency band of operation shall not exceed 1 W provided the maximum antenna gain does not exceed 6 dBi. In addition, the maximum power spectral density shall not exceed 17 dBm in any 1 megahertz band. If transmitting antennas of directional gain greater than 6 dBi are used, both the maximum conducted output power and the maximum power spectral density shall be reduced by the amount in dB that the directional gain of the antenna exceeds 6 dBi. The maximum e.i.r.p. at any elevation angle above 30 degrees as measured from the horizon must not exceed 125 mW (21 dBm).

(ii) For an indoor access point operating in the band 5.15-5.25 GHz, the maximum conducted output power over the frequency band of operation shall not exceed 1 W provided the maximum antenna gain does not exceed 6 dBi. In addition, the maximum power spectral density shall not exceed 17 dBm in any 1 megahertz band. If transmitting antennas of directional gain greater than 6 dBi are used, both the maximum conducted output power and the maximum power spectral density shall be reduced by the amount in dB that the directional gain of the antenna exceeds 6 dBi.

(iii) For fixed point-to-point access points operating in the band 5.15-5.25 GHz, the maximum conducted output power over the frequency band of operation shall not exceed 1 W. Fixed point-to-point U-NII devices may employ antennas with directional gain up to 23 dBi without any corresponding reduction in the maximum conducted output power or maximum power spectral density. For fixed point-to-point transmitters that employ a directional antenna gain greater than 23 dBi, a 1 dB reduction in maximum conducted output power and maximum power spectral density is required for each 1 dB of antenna gain in excess of 23 dBi. Fixed, point-to-point operations exclude the use of point-to-multipoint systems, omnidirectional applications, and multiple collocated transmitters transmitting the same information. The operator of the U-NII device, or if the equipment is professionally installed, the installer, is responsible for ensuring that systems employing high gain directional antennas are used exclusively for fixed, point-to-point operations.

(iv) For mobile and portable client devices in the 5.15-5.25 GHz band, the maximum conducted output power over the frequency band of operation shall not exceed 250 mW provided the maximum antenna gain does not exceed 6 dBi. In addition, the maximum power spectral density shall not exceed 11 dBm in any 1 megahertz band. If transmitting antennas of directional gain greater than 6 dBi are used, both the maximum conducted output power and the maximum power spectral density shall be reduced by the amount in dB that the directional gain of the antenna exceeds 6 dBi.

TEST PROCEDURE

Measurements perform using a wideband gated RF power meter provided that the gate parameters are adjusted such that the power is measured only when the EUT is transmitting at its maximum power control level. Since the measurement is made only during the ON time of the transmitter, no duty cycle correction factor is required.

PSD test procedure: KDB 789033 D02 v01r04 Section F (SA-2 method)

DIRECTIONAL ANTENNA GAIN

For Power used uncorrelated gain: The TX chains are uncorrelated and the antenna gain is unequal among the chains. The directional gain is:

UAT 2 Antenna Gain (dBi)	LAT 3 Antenna Gain (dBi)	Uncorrelated Chains Directional Gain (dBi)
-4.61	-0.98	-2.43

For PSD used correlated gain: The TX chains are correlated and the antenna gain is unequal among the chains. The directional gain is:

UAT 2 Antenna Gain (dBi)	LAT 3 Antenna Gain (dBi)	Correlated Chains Directional Gain (dBi)
-4.61	-0.98	0.40

RESULTS

Antenna Gain and Limits

Channel	Frequency (MHz)	Directional Gain for Power (dBi)	Directional Gain for PSD (dBi)	Power Limit (dBm)	PSD Limit (dBm)
Low	5190	-2.43	0.40	24.00	11.00
High	5230	-2.43	0.40	24.00	11.00

Duty Cycle CF (dB)	0.09	Included in Calculations of Corr'd PSD
---------------------------	------	-----------------------------------------------

Output Power Results

Channel	Frequency (MHz)	UAT 2 Meas Power (dBm)	LAT 3 Meas Power (dBm)	Total Corr'd Power (dBm)	Power Limit (dBm)	Power Margin (dB)
Low	5190	13.78	13.82	16.81	24.00	-7.19
High	5230	18.31	18.49	21.41	24.00	-2.59

PSD Results

Channel	Frequency (MHz)	UAT 2 Meas PSD (dBm)	LAT 3 Meas PSD (dBm)	Total Corr'd PSD (dBm)	PSD Limit (dBm)	PSD Margin (dB)
Low	5190	1.86	2.41	5.24	11.00	-5.76
High	5230	5.90	6.36	9.24	11.00	-1.76

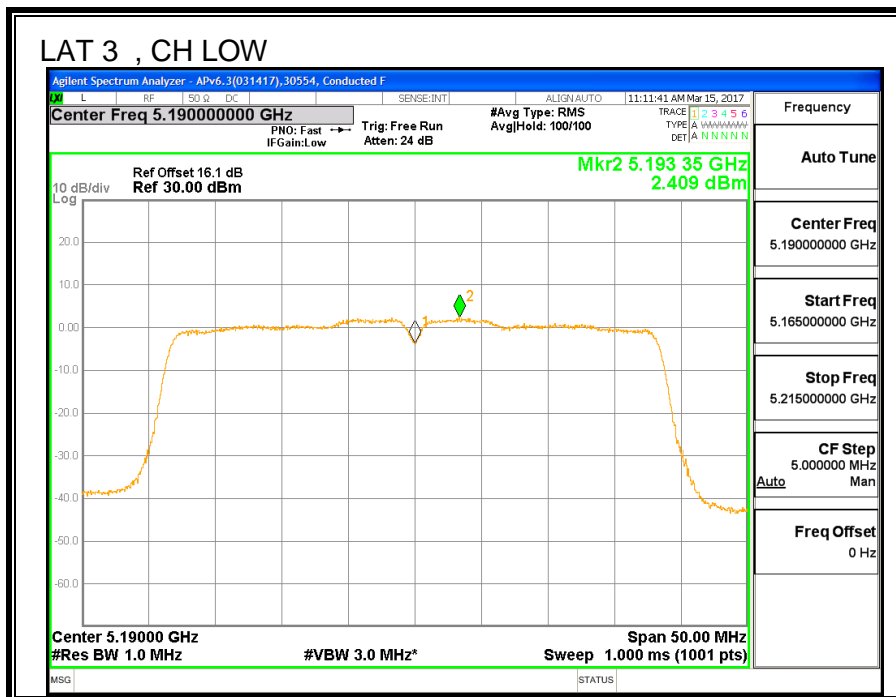
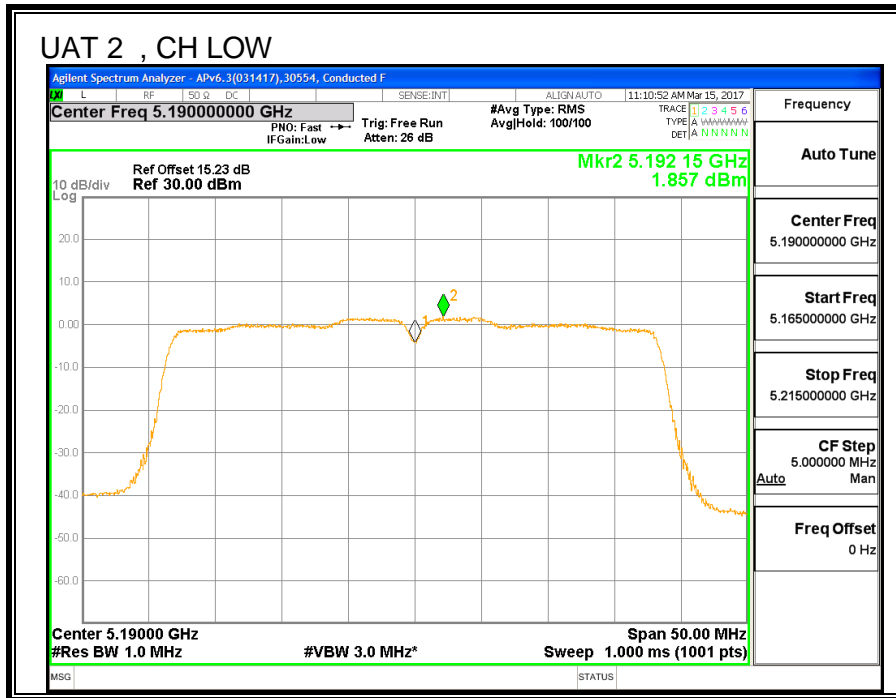

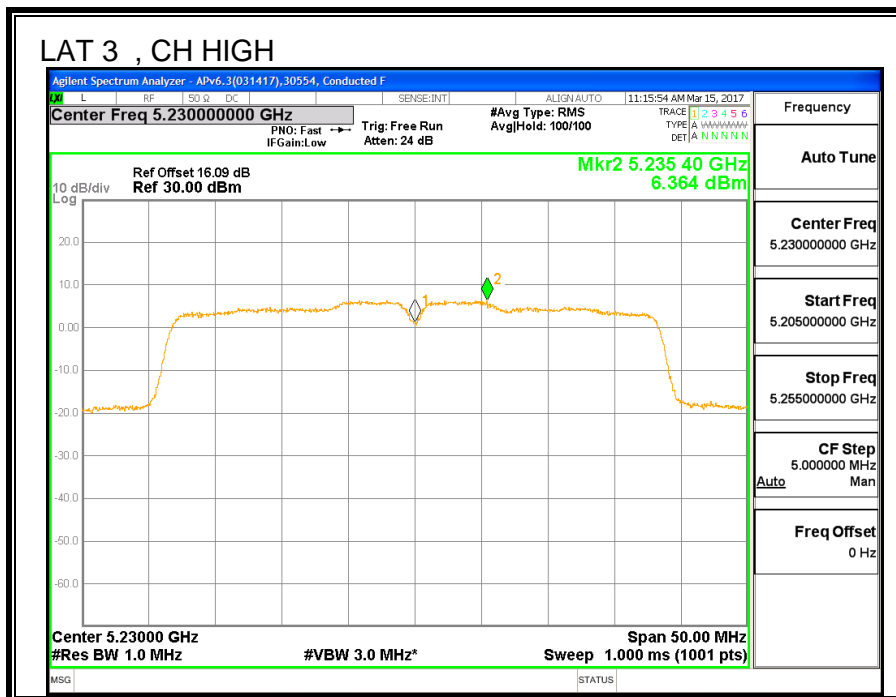
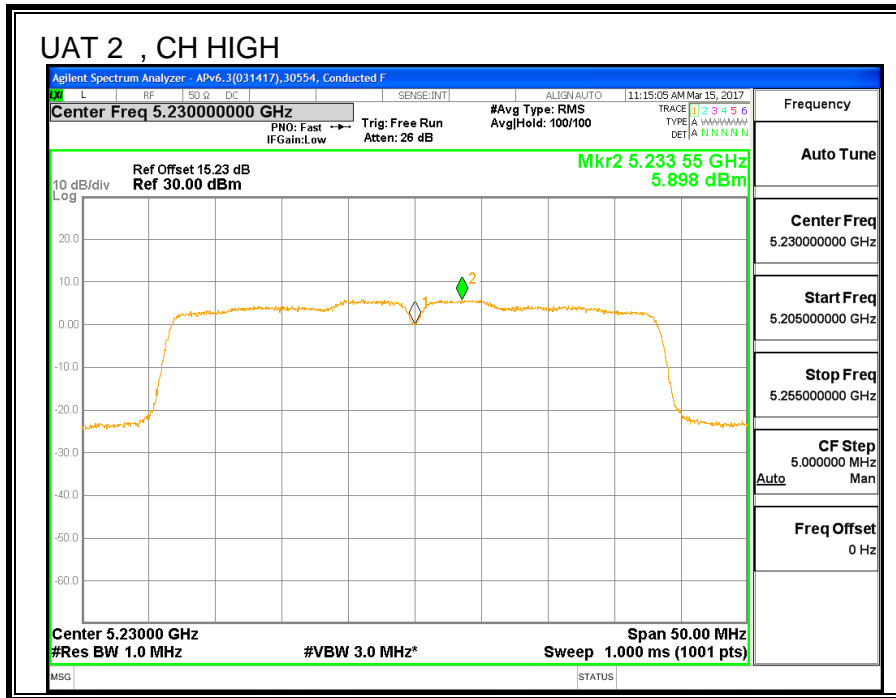

8.7. 11ac HT80 UAT 2 SISO MODE IN THE 5.2GHz BAND

8.7.1. 26 dB BANDWIDTH

LIMITS

None; for reporting purposes only.

RESULTS

Channel	Frequency	26 dB BW UAT 2 (MHz)
Mid	5210	82.4

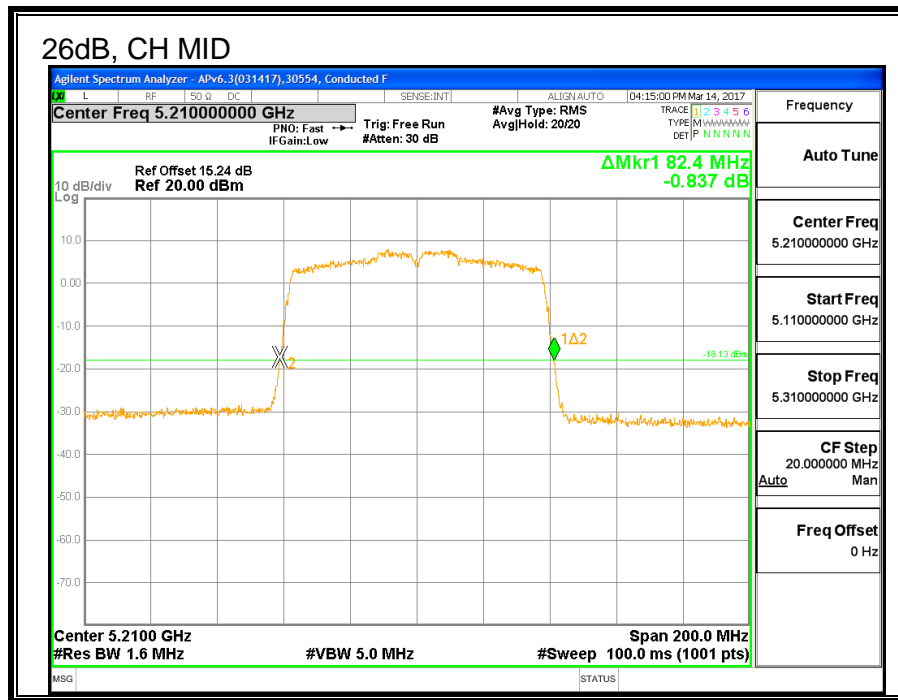

8.7.2. 99% BANDWIDTH

LIMITS

None; for reporting purposes only.

RESULTS

Channel	Frequency	99% BW UAT 2 (MHz)
Mid	5210	75.378

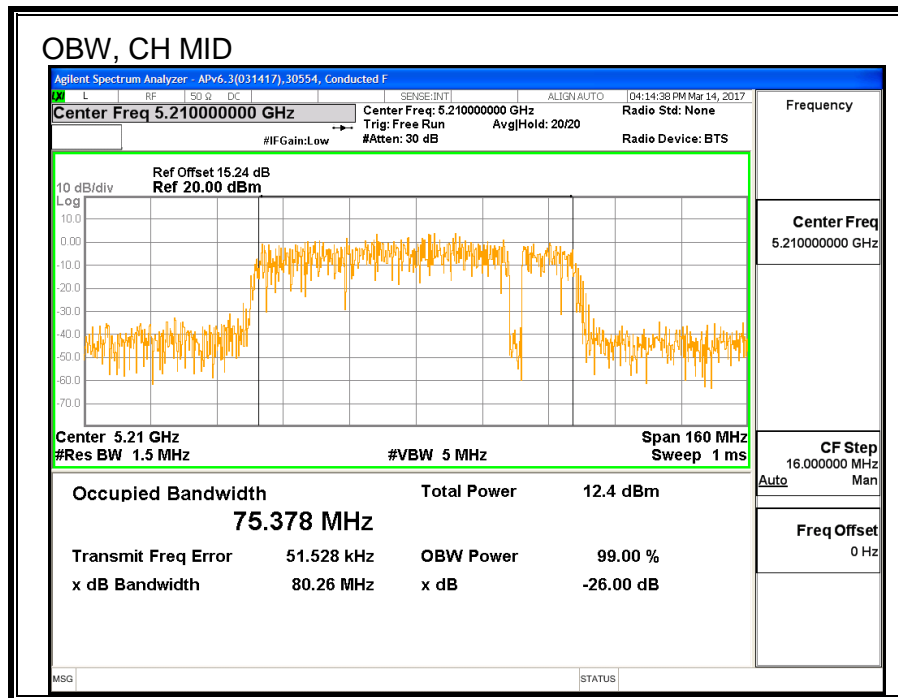

8.7.3. AVERAGE POWER

ID:	39472	Date:	6/11/17
------------	-------	--------------	---------

LIMITS

None; for reporting purposes only.

TEST PROCEDURE

Measurements perform using a wideband gated RF power meter.

RESULTS

Channel	Frequency	Power UAT 2 (dBm)
Mid	5210	14.91

8.7.4. OUTPUT POWER AND PPSD

LIMITS

FCC §15.407 (a) (1)

(i) For an outdoor access point operating in the band 5.15-5.25 GHz, the maximum conducted output power over the frequency band of operation shall not exceed 1 W provided the maximum antenna gain does not exceed 6 dBi. In addition, the maximum power spectral density shall not exceed 17 dBm in any 1 megahertz band. If transmitting antennas of directional gain greater than 6 dBi are used, both the maximum conducted output power and the maximum power spectral density shall be reduced by the amount in dB that the directional gain of the antenna exceeds 6 dBi. The maximum e.i.r.p. at any elevation angle above 30 degrees as measured from the horizon must not exceed 125 mW (21 dBm).

(ii) For an indoor access point operating in the band 5.15-5.25 GHz, the maximum conducted output power over the frequency band of operation shall not exceed 1 W provided the maximum antenna gain does not exceed 6 dBi. In addition, the maximum power spectral density shall not exceed 17 dBm in any 1 megahertz band. If transmitting antennas of directional gain greater than 6 dBi are used, both the maximum conducted output power and the maximum power spectral density shall be reduced by the amount in dB that the directional gain of the antenna exceeds 6 dBi.

(iii) For fixed point-to-point access points operating in the band 5.15-5.25 GHz, the maximum conducted output power over the frequency band of operation shall not exceed 1 W. Fixed point-to-point U-NII devices may employ antennas with directional gain up to 23 dBi without any corresponding reduction in the maximum conducted output power or maximum power spectral density. For fixed point-to-point transmitters that employ a directional antenna gain greater than 23 dBi, a 1 dB reduction in maximum conducted output power and maximum power spectral density is required for each 1 dB of antenna gain in excess of 23 dBi. Fixed, point-to-point operations exclude the use of point-to-multipoint systems, omnidirectional applications, and multiple collocated transmitters transmitting the same information. The operator of the U-NII device, or if the equipment is professionally installed, the installer, is responsible for ensuring that systems employing high gain directional antennas are used exclusively for fixed, point-to-point operations.

(iv) For mobile and portable client devices in the 5.15-5.25 GHz band, the maximum conducted output power over the frequency band of operation shall not exceed 250 mW provided the maximum antenna gain does not exceed 6 dBi. In addition, the maximum power spectral density shall not exceed 11 dBm in any 1 megahertz band. If transmitting antennas of directional gain greater than 6 dBi are used, both the maximum conducted output power and the maximum power spectral density shall be reduced by the amount in dB that the directional gain of the antenna exceeds 6 dBi.

TEST PROCEDURE

Measurements perform using a wideband gated RF power meter provided that the gate parameters are adjusted such that the power is measured only when the EUT is transmitting at its maximum power control level. Since the measurement is made only during the ON time of the transmitter, no duty cycle correction factor is required.

PSD test procedure: KDB 789033 D02 v01r04 Section F (SA-2 method)

DIRECTIONAL ANTENNA GAIN

There is only one transmitter output therefore the directional gain is equal to the antenna gain.

RESULTS

Antenna Gain and Limits

Channel	Frequency (MHz)	Directional Gain for Power (dBi)	Directional Gain for PSD (dBi)	Power Limit (dBm)	PSD Limit (dBm)
Mid	5210	-4.61	-4.61	24.00	11.00

Duty Cycle CF (dB)	0.19	Included in Calculations of Corr'd PSD
---------------------------	------	----------------------------------------

Output Power Results

Channel	Frequency (MHz)	UAT 2 Meas Power (dBm)	Total Corr'd Power (dBm)	Power Limit (dBm)	Power Margin (dB)
Mid	5210	14.91	14.91	24.00	-9.09

PSD Results

Channel	Frequency (MHz)	UAT 2 Meas PSD (dBm)	Total Corr'd PSD (dBm)	PSD Limit (dBm)	PSD Margin (dB)
Mid	5210	0.646	0.84	11.00	-10.16

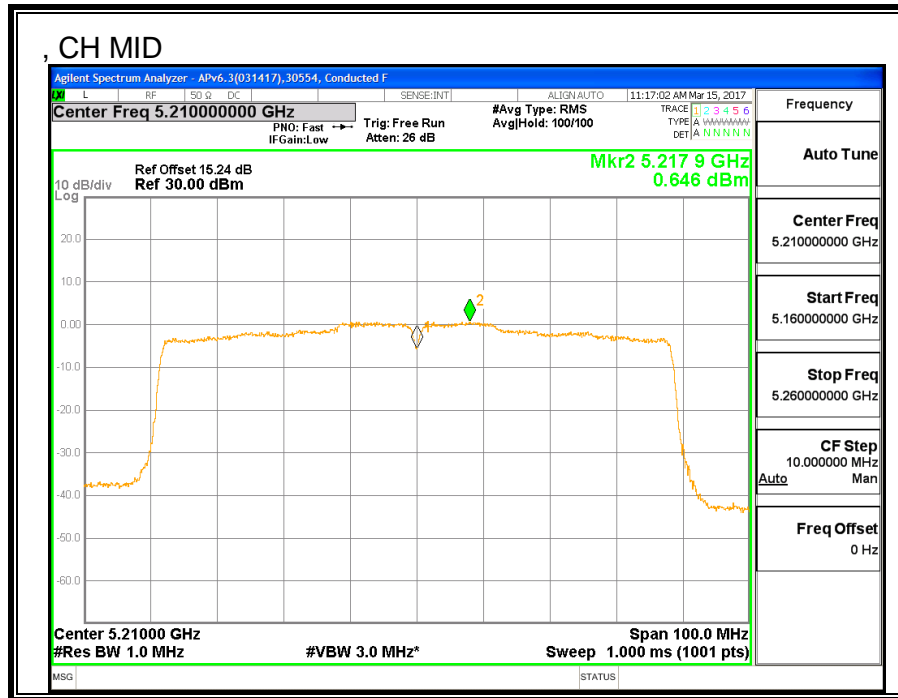

8.8. 11ac HT80 LAT 3 SISO MODE IN THE 5.2GHZ BAND

8.8.1. 26 dB BANDWIDTH

LIMITS

None; for reporting purposes only.

RESULTS

Channel	Frequency	26 dB BW LAT 3 (MHz)
Mid	5210	82.00

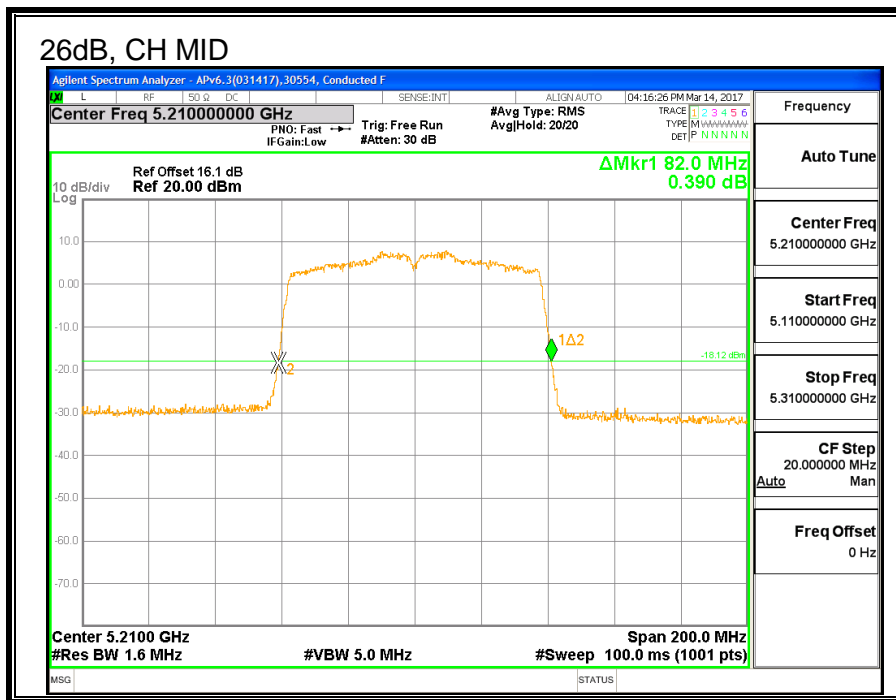

8.8.2. 99% BANDWIDTH

LIMITS

None; for reporting purposes only.

RESULTS

Channel	Frequency	99% BW LAT 3 (MHz)
Mid	5210	74.824

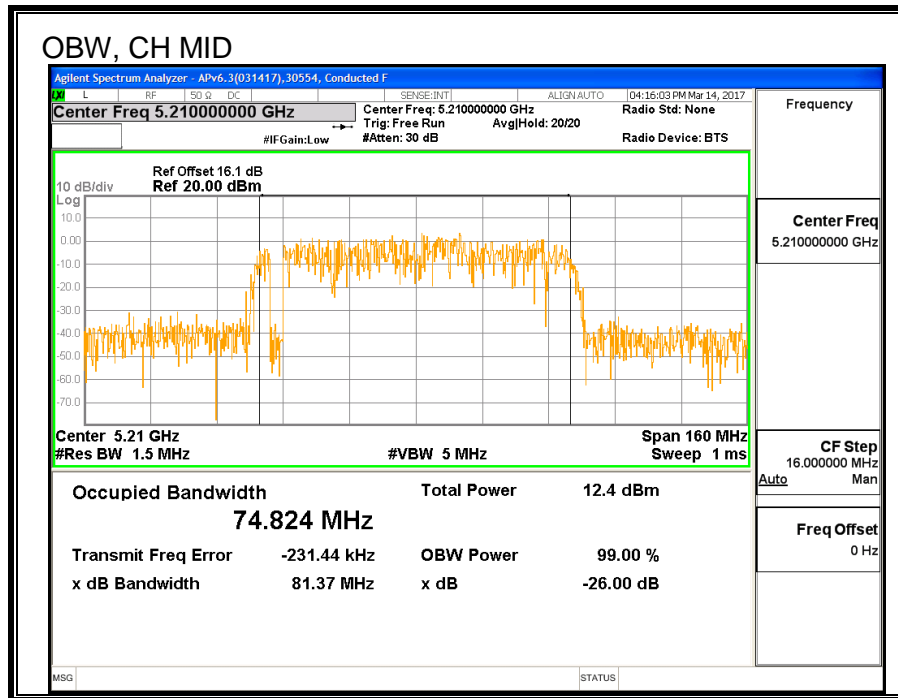

8.8.3. AVERAGE POWER

ID:	39472	Date:	6/11/17
------------	-------	--------------	---------

LIMITS

None; for reporting purposes only.

TEST PROCEDURE

Measurements perform using a wideband gated RF power meter.

RESULTS

Channel	Frequency	Power LAT 3 (dBm)
Mid	5210	14.99

8.8.4. OUTPUT POWER AND PPSD

LIMITS

FCC §15.407 (a) (1)

(i) For an outdoor access point operating in the band 5.15-5.25 GHz, the maximum conducted output power over the frequency band of operation shall not exceed 1 W provided the maximum antenna gain does not exceed 6 dBi. In addition, the maximum power spectral density shall not exceed 17 dBm in any 1 megahertz band. If transmitting antennas of directional gain greater than 6 dBi are used, both the maximum conducted output power and the maximum power spectral density shall be reduced by the amount in dB that the directional gain of the antenna exceeds 6 dBi. The maximum e.i.r.p. at any elevation angle above 30 degrees as measured from the horizon must not exceed 125 mW (21 dBm).

(ii) For an indoor access point operating in the band 5.15-5.25 GHz, the maximum conducted output power over the frequency band of operation shall not exceed 1 W provided the maximum antenna gain does not exceed 6 dBi. In addition, the maximum power spectral density shall not exceed 17 dBm in any 1 megahertz band. If transmitting antennas of directional gain greater than 6 dBi are used, both the maximum conducted output power and the maximum power spectral density shall be reduced by the amount in dB that the directional gain of the antenna exceeds 6 dBi.

(iii) For fixed point-to-point access points operating in the band 5.15-5.25 GHz, the maximum conducted output power over the frequency band of operation shall not exceed 1 W. Fixed point-to-point U-NII devices may employ antennas with directional gain up to 23 dBi without any corresponding reduction in the maximum conducted output power or maximum power spectral density. For fixed point-to-point transmitters that employ a directional antenna gain greater than 23 dBi, a 1 dB reduction in maximum conducted output power and maximum power spectral density is required for each 1 dB of antenna gain in excess of 23 dBi. Fixed, point-to-point operations exclude the use of point-to-multipoint systems, omnidirectional applications, and multiple collocated transmitters transmitting the same information. The operator of the U-NII device, or if the equipment is professionally installed, the installer, is responsible for ensuring that systems employing high gain directional antennas are used exclusively for fixed, point-to-point operations.

(iv) For mobile and portable client devices in the 5.15-5.25 GHz band, the maximum conducted output power over the frequency band of operation shall not exceed 250 mW provided the maximum antenna gain does not exceed 6 dBi. In addition, the maximum power spectral density shall not exceed 11 dBm in any 1 megahertz band. If transmitting antennas of directional gain greater than 6 dBi are used, both the maximum conducted output power and the maximum power spectral density shall be reduced by the amount in dB that the directional gain of the antenna exceeds 6 dBi.

TEST PROCEDURE

Measurements perform using a wideband gated RF power meter provided that the gate parameters are adjusted such that the power is measured only when the EUT is transmitting at its maximum power control level. Since the measurement is made only during the ON time of the transmitter, no duty cycle correction factor is required.

PSD test procedure: KDB 789033 D02 v01r04 Section F (SA-2 method)

DIRECTIONAL ANTENNA GAIN

There is only one transmitter output therefore the directional gain is equal to the antenna gain.

RESULTS

Antenna Gain and Limits

Channel	Frequency (MHz)	Directional Gain for Power (dBi)	Directional Gain for PSD (dBi)	Power Limit (dBm)	PSD Limit (dBm)
Mid	5210	-0.98	-0.98	24.00	11.00

Duty Cycle CF (dB)	0.19	Included in Calculations of Corr'd PSD
---------------------------	------	-----------------------------------------------

Output Power Results

Channel	Frequency (MHz)	LAT 3 Meas Power (dBm)	Total Corr'd Power (dBm)	Power Limit (dBm)	Power Margin (dB)
Mid	5210	14.99	14.99	24.00	-9.01

PSD Results

Channel	Frequency (MHz)	LAT 3 Meas PSD (dBm)	Total Corr'd PSD (dBm)	PSD Limit (dBm)	PSD Margin (dB)
Mid	5210	0.294	0.48	11.00	-10.52

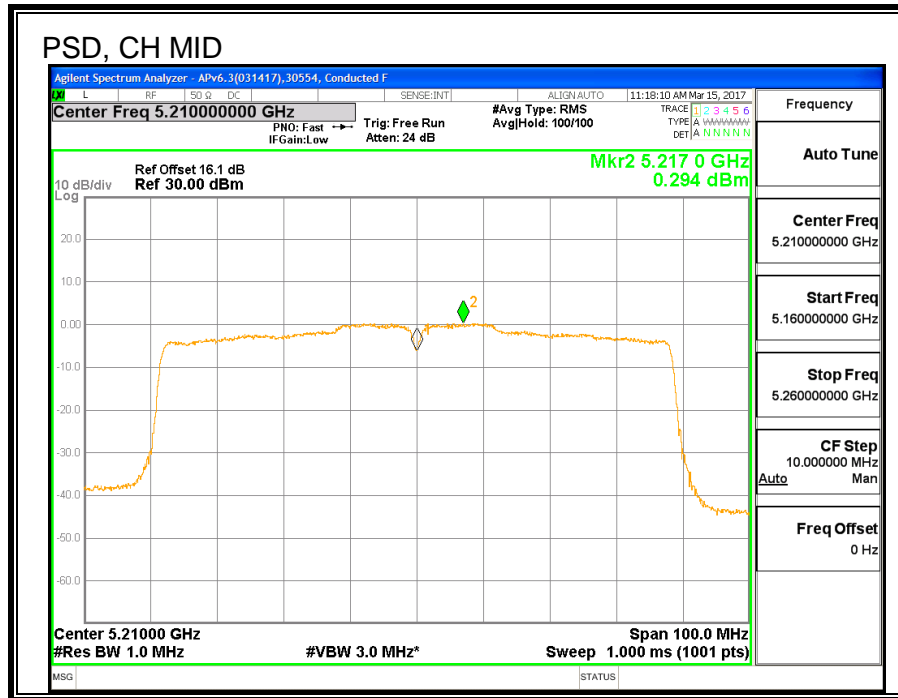

8.9. 11ac HT80 2TX CDD MIMO MODE IN THE 5.2GHz BAND

8.9.1. 26 dB BANDWIDTH

LIMITS

None; for reporting purposes only.

RESULTS

Channel	Frequency	26 dB BW UAT 2 (MHz)	26 dB BW LAT 3 (MHz)
Mid	5210	82.2	82.2

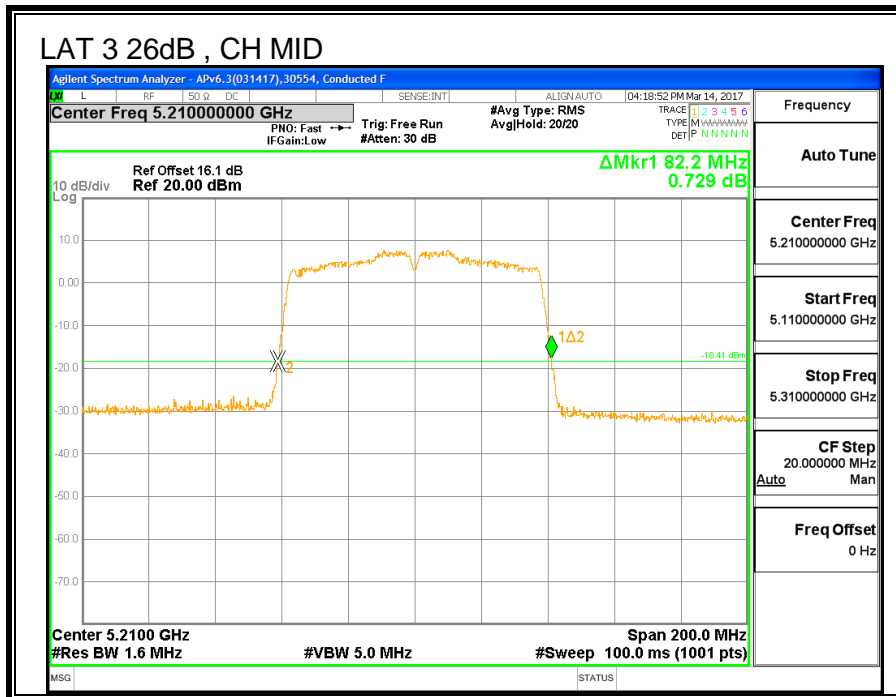
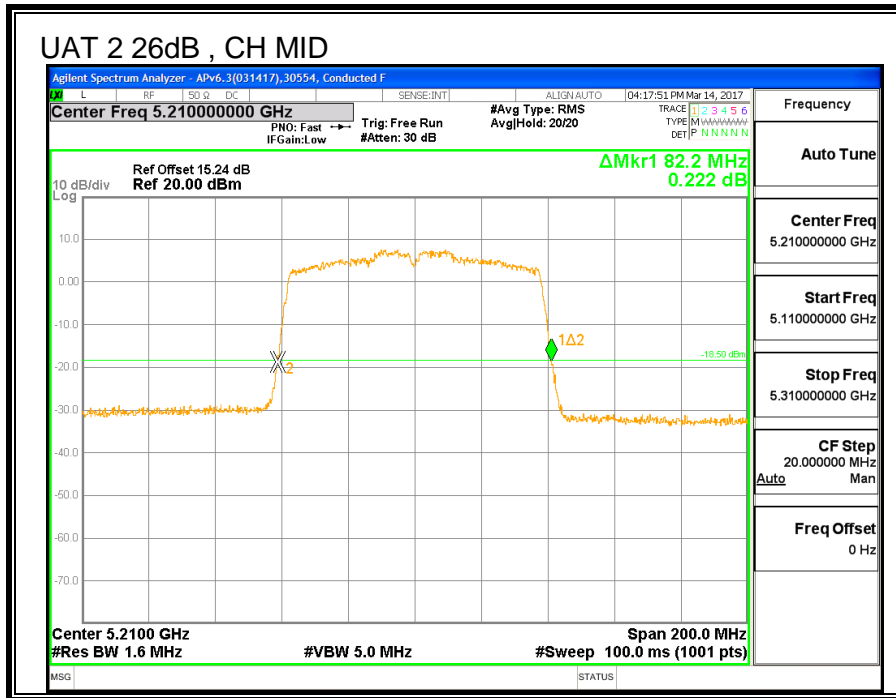

8.9.2. 99% BANDWIDTH

LIMITS

None; for reporting purposes only.

RESULTS

Channel	Frequency	99% BW UAT 2 (MHz)	99% BW LAT 3 (MHz)
Mid	5210	74.863	75.400

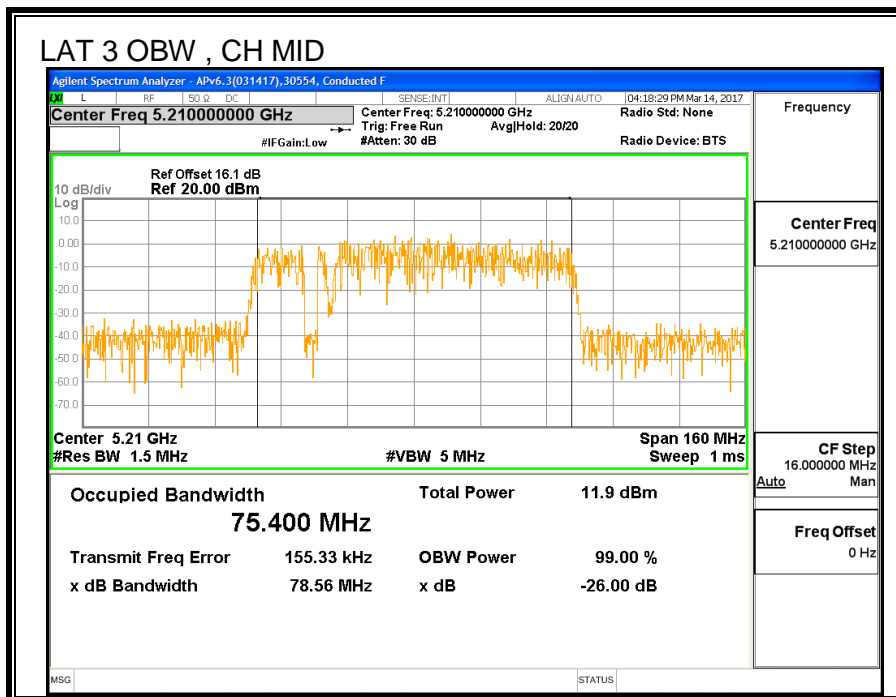
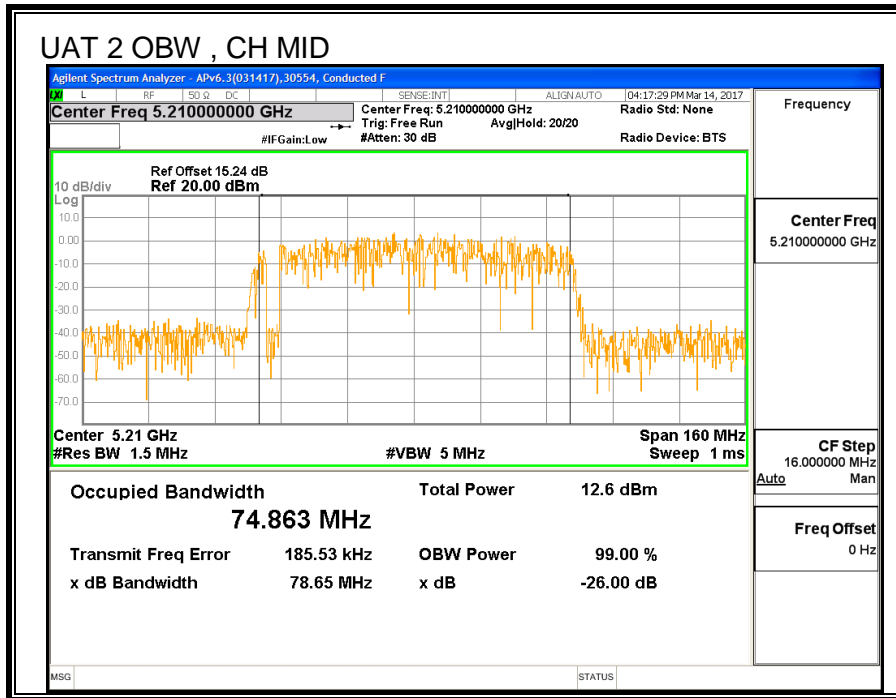

8.9.3. AVERAGE POWER

ID:	39472	Date:	6/11/17
------------	-------	--------------	---------

LIMITS

None; for reporting purposes only.

TEST PROCEDURE

Measurements perform using a wideband gated RF power meter.

RESULTS

Channel	Frequency	Power UAT 2 (dBm)	Power LAT 3 (dBm)	Total Power (dBm)
Mid	5210	13.43	13.49	16.47

8.9.4. OUTPUT POWER AND PPSD

LIMITS

FCC §15.407 (a) (1)

(i) For an outdoor access point operating in the band 5.15-5.25 GHz, the maximum conducted output power over the frequency band of operation shall not exceed 1 W provided the maximum antenna gain does not exceed 6 dBi. In addition, the maximum power spectral density shall not exceed 17 dBm in any 1 megahertz band. If transmitting antennas of directional gain greater than 6 dBi are used, both the maximum conducted output power and the maximum power spectral density shall be reduced by the amount in dB that the directional gain of the antenna exceeds 6 dBi. The maximum e.i.r.p. at any elevation angle above 30 degrees as measured from the horizon must not exceed 125 mW (21 dBm).

(ii) For an indoor access point operating in the band 5.15-5.25 GHz, the maximum conducted output power over the frequency band of operation shall not exceed 1 W provided the maximum antenna gain does not exceed 6 dBi. In addition, the maximum power spectral density shall not exceed 17 dBm in any 1 megahertz band. If transmitting antennas of directional gain greater than 6 dBi are used, both the maximum conducted output power and the maximum power spectral density shall be reduced by the amount in dB that the directional gain of the antenna exceeds 6 dBi.

(iii) For fixed point-to-point access points operating in the band 5.15-5.25 GHz, the maximum conducted output power over the frequency band of operation shall not exceed 1 W. Fixed point-to-point U-NII devices may employ antennas with directional gain up to 23 dBi without any corresponding reduction in the maximum conducted output power or maximum power spectral density. For fixed point-to-point transmitters that employ a directional antenna gain greater than 23 dBi, a 1 dB reduction in maximum conducted output power and maximum power spectral density is required for each 1 dB of antenna gain in excess of 23 dBi. Fixed, point-to-point operations exclude the use of point-to-multipoint systems, omnidirectional applications, and multiple collocated transmitters transmitting the same information. The operator of the U-NII device, or if the equipment is professionally installed, the installer, is responsible for ensuring that systems employing high gain directional antennas are used exclusively for fixed, point-to-point operations.

(iv) For mobile and portable client devices in the 5.15-5.25 GHz band, the maximum conducted output power over the frequency band of operation shall not exceed 250 mW provided the maximum antenna gain does not exceed 6 dBi. In addition, the maximum power spectral density shall not exceed 11 dBm in any 1 megahertz band. If transmitting antennas of directional gain greater than 6 dBi are used, both the maximum conducted output power and the maximum power spectral density shall be reduced by the amount in dB that the directional gain of the antenna exceeds 6 dBi.

TEST PROCEDURE

Measurements perform using a wideband gated RF power meter provided that the gate parameters are adjusted such that the power is measured only when the EUT is transmitting at its maximum power control level. Since the measurement is made only during the ON time of the transmitter, no duty cycle correction factor is required.

PSD test procedure: KDB 789033 D02 v01r04 Section F (SA-2 method)

DIRECTIONAL ANTENNA GAIN

For Power used uncorrelated gain: The TX chains are uncorrelated and the antenna gain is unequal among the chains. The directional gain is:

UAT 2 Antenna Gain (dBi)	LAT 3 Antenna Gain (dBi)	Uncorrelated Chains Directional Gain (dBi)
-4.61	-0.98	-2.43

For PSD used correlated gain: The TX chains are correlated and the antenna gain is unequal among the chains. The directional gain is:

UAT 2 Antenna Gain (dBi)	LAT 3 Antenna Gain (dBi)	Correlated Chains Directional Gain (dBi)
-4.61	-0.98	0.40

RESULTS

Antenna Gain and Limits

Channel	Frequency (MHz)	Directional Gain for Power (dBi)	Directional Gain for PSD (dBi)	Power Limit (dBm)	PSD Limit (dBm)
Mid	5210	-2.43	0.40	24.00	11.00

Duty Cycle CF (dB)	0.19	Included in Calculations of Corr'd PSD
---------------------------	------	-----------------------------------------------

Output Power Results

Channel	Frequency (MHz)	UAT 2 Meas Power (dBm)	LAT 3 Meas Power (dBm)	Total Corr'd Power (dBm)	Power Limit (dBm)	Power Margin (dB)
Mid	5210	13.43	13.49	16.47	24.00	-7.53

PSD Results

Channel	Frequency (MHz)	UAT 2 Meas PSD (dBm)	LAT 3 Meas PSD (dBm)	Total Corr'd PSD (dBm)	PSD Limit (dBm)	PSD Margin (dB)
Mid	5210	-0.988	-0.775	2.32	11.00	-8.68

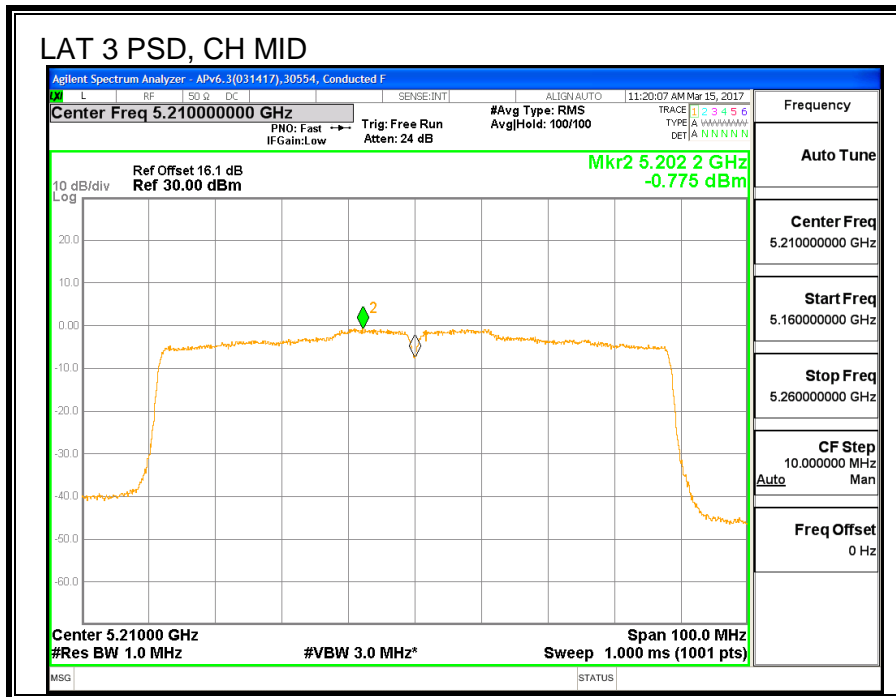
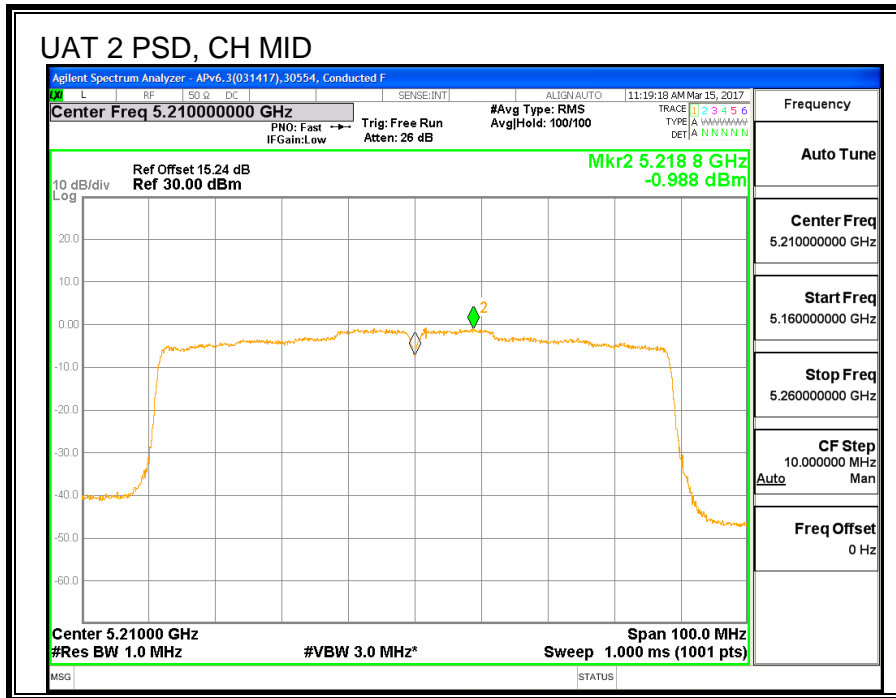

8.10. 11n HT20 UAT 2 SISO MODE IN THE 5.3GHz BAND

8.10.1. 26 dB BANDWIDTH

LIMITS

None; for reporting purposes only.

RESULTS

Channel	Frequency	26 dB BW UAT 2 (MHz)
Low	5260	22.15
Mid	5300	22.00
High	5320	22.10

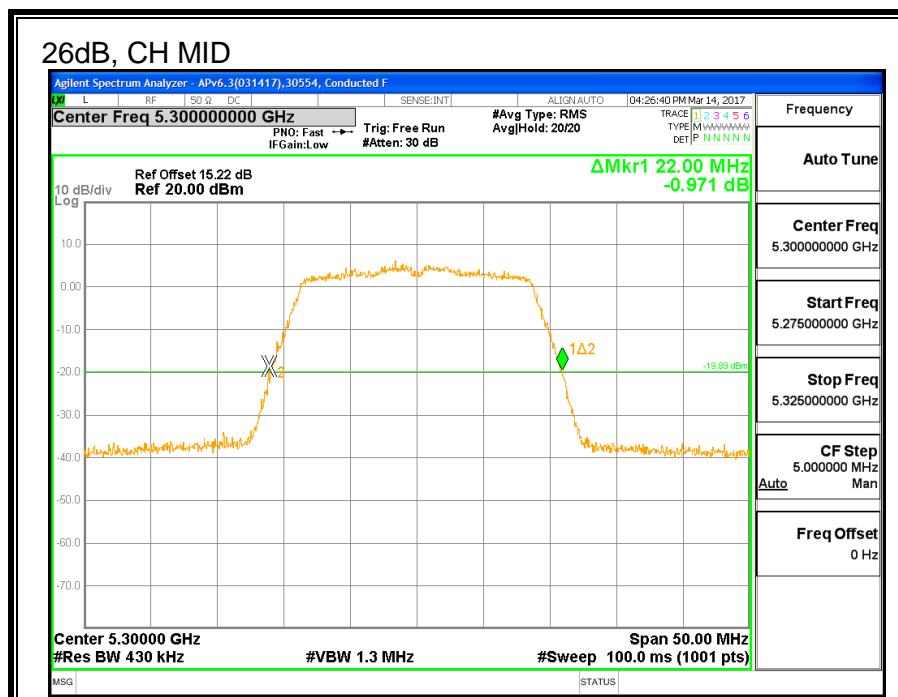
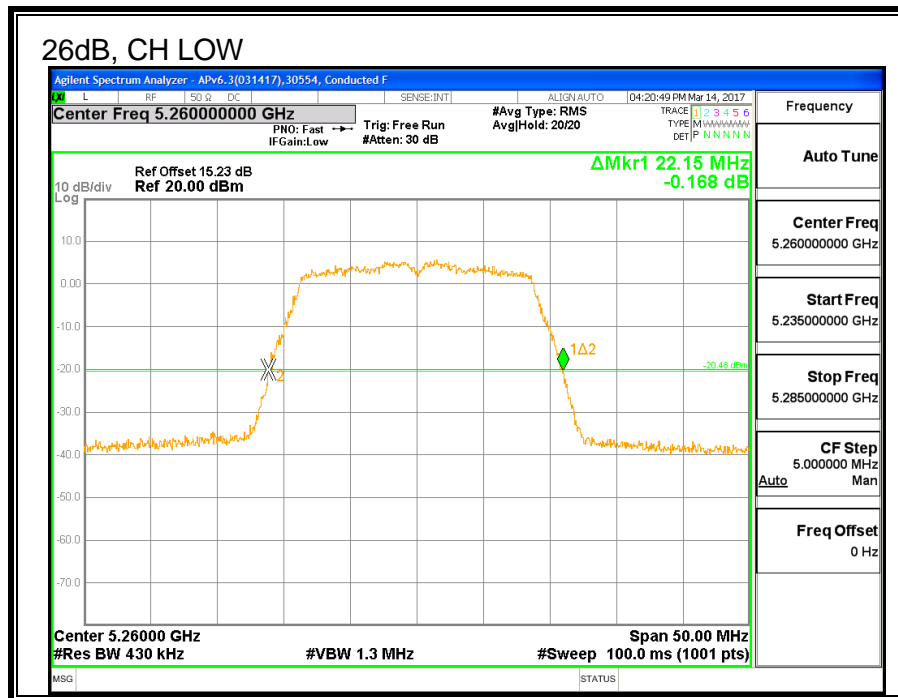

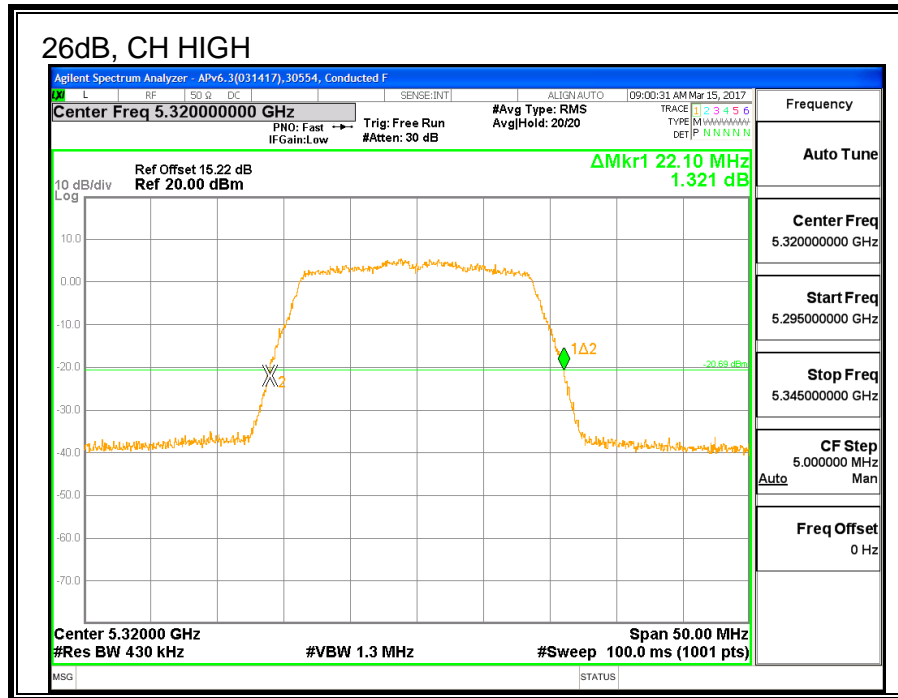

8.10.2. 99% BANDWIDTH

LIMITS

None; for reporting purposes only.

RESULTS

Channel	Frequency	99% BW UAT 2 (MHz)
Low	5260	17.822
Mid	5300	17.770
High	5320	17.728

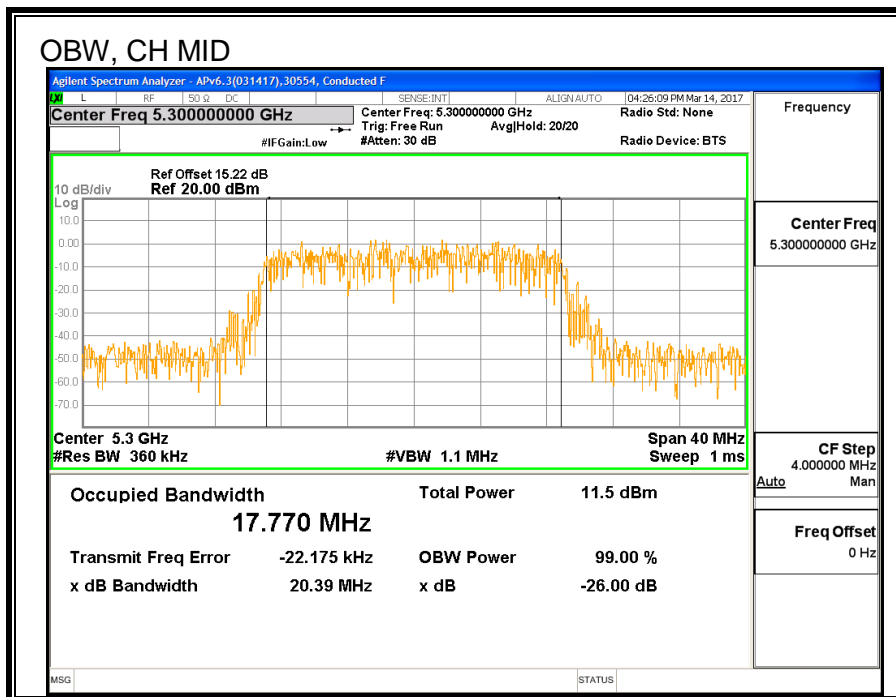
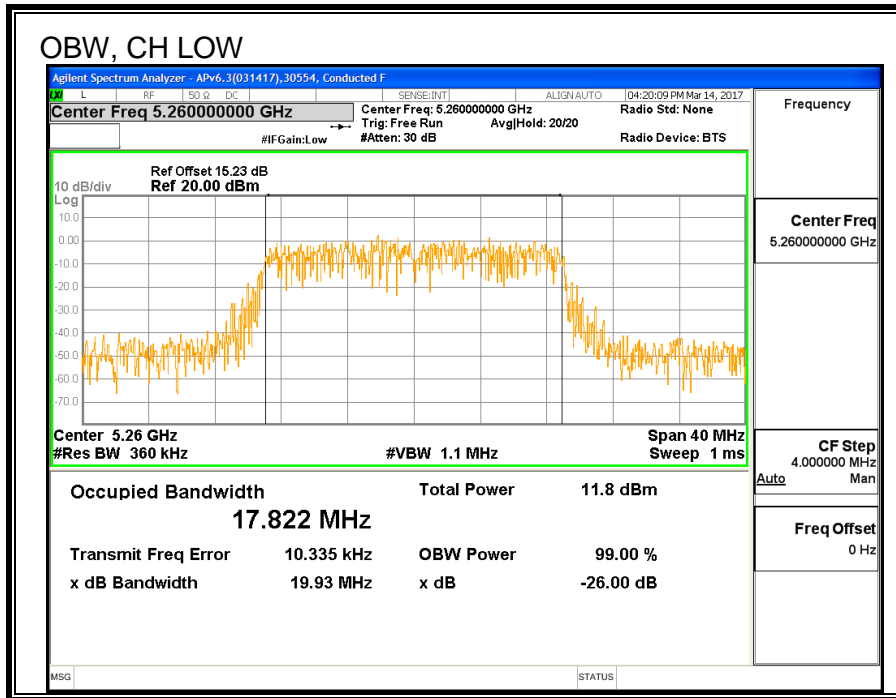

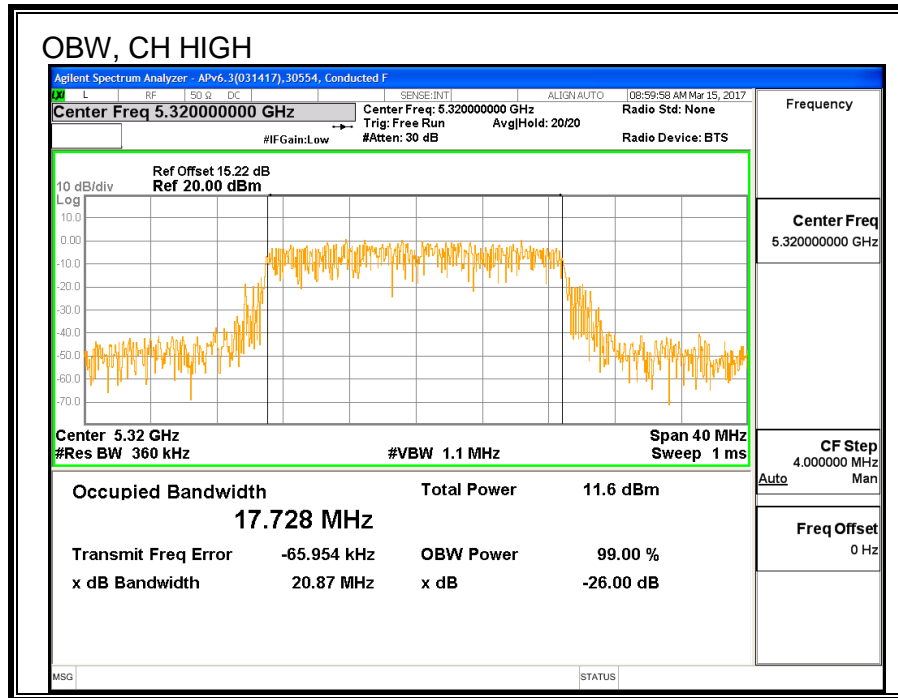

8.10.3. AVERAGE POWER

ID:	39472	Date:	6/11/17
------------	-------	--------------	---------

LIMITS

None; for reporting purposes only.

TEST PROCEDURE

Measurements perform using a wideband gated RF power meter.

RESULTS

Channel	Frequency	Power UAT 2 (dBm)
Low	5260	20.82
Mid	5300	19.33
High	5320	16.97

8.10.4. OUTPUT POWER AND PPSD

LIMITS

FCC §15.407 (a) (2)

For the band 5.25–5.35 GHz, the maximum conducted output power over the frequency band of operation shall not exceed the lesser of 250 mW or $11 \text{ dBm} + 10 \log B$, where B is the 26-dB emission bandwidth in MHz. In addition, the maximum power spectral density shall not exceed 11 dBm in any 1-MHz band. If transmitting antennas of directional gain greater than 6 dBi are used, both the maximum conducted output power and the peak power spectral density shall be reduced by the amount in dB that the directional gain of the antenna exceeds 6 dBi.

TEST PROCEDURE

Measurements perform using a wideband gated RF power meter provided that the gate parameters are adjusted such that the power is measured only when the EUT is transmitting at its maximum power control level. Since the measurement is made only during the ON time of the transmitter, no duty cycle correction factor is required.

PSD test procedure: KDB 789033 D02 v01r04 Section F (SA-2 method)

DIRECTIONAL ANTENNA GAIN

There is only one transmitter output therefore the directional gain is equal to the antenna gain.

RESULTS

Bandwidth, Antenna Gain, and Limits

Channel	Frequency (MHz)	Min 26 dB BW (MHz)	Min 99% BW (MHz)	Directional Gain (dBi)	Power Limit (dBm)	PSD Limit (dBm)
Low	5260	22.150	17.822	-3.74	23.51	11.00
Mid	5300	22.000	17.770	-3.74	23.50	11.00
High	5320	22.100	17.728	-3.74	23.49	11.00

Duty Cycle CF (dB)	0.00	Included in Calculations of Corr'd PSD
---------------------------	------	-----------------------------------------------

Output Power Results

Channel	Frequency (MHz)	UAT 2 Meas Power (dBm)	Total Corr'd Power (dBm)	Power Limit (dBm)	Power Margin (dB)
Low	5260	20.82	20.82	23.51	-2.69
Mid	5300	19.33	19.33	23.50	-4.17
High	5320	16.97	16.97	23.49	-6.52

PSD Results

Channel	Frequency (MHz)	UAT 2 Meas PSD (dBm)	Total Corr'd PSD (dBm)	PSD Limit (dBm)	PSD Margin (dB)
Low	5260	10.568	10.57	11.00	-0.43
Mid	5300	9.711	9.71	11.00	-1.29
High	5320	6.986	6.99	11.00	-4.01

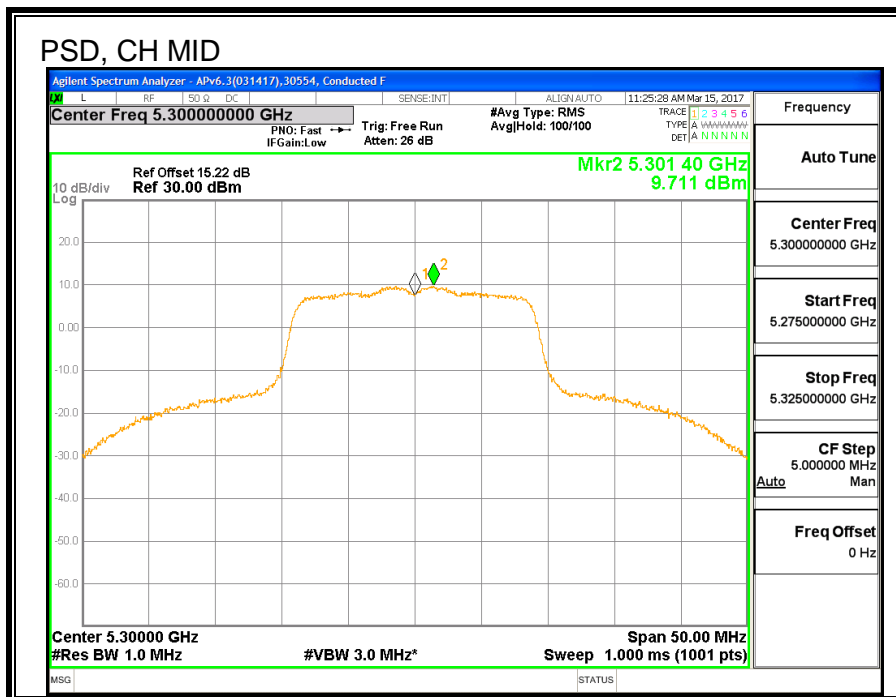
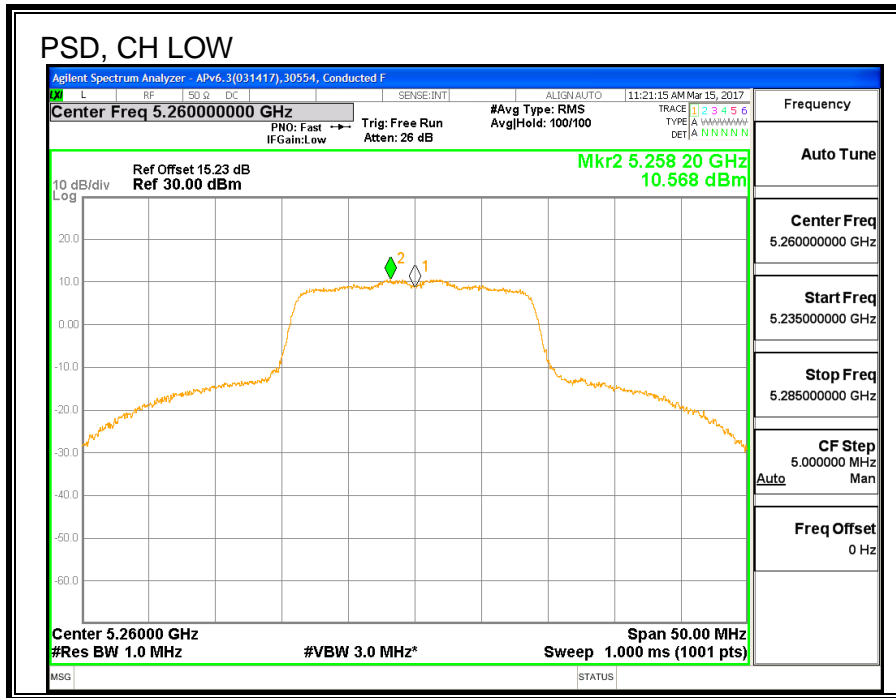

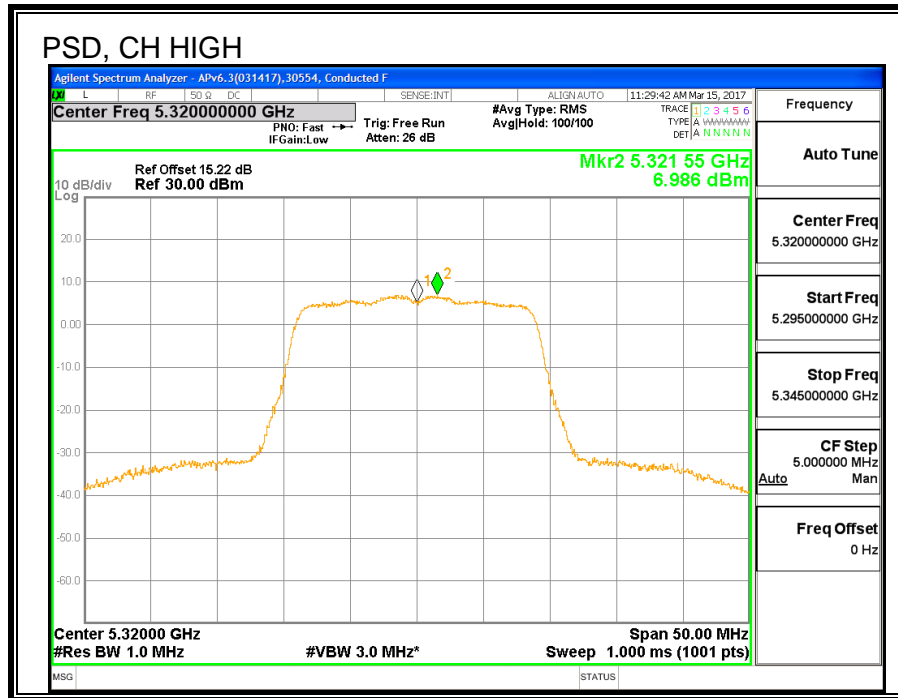

8.11. 11n HT20 LAT 3 SISO MODE IN THE 5.3GHz BAND

8.11.1. 26 dB BANDWIDTH

LIMITS

None; for reporting purposes only.

RESULTS

Channel	Frequency	26 dB BW LAT 3 (MHz)
Low	5260	22.00
Mid	5300	22.05
High	5320	22.00

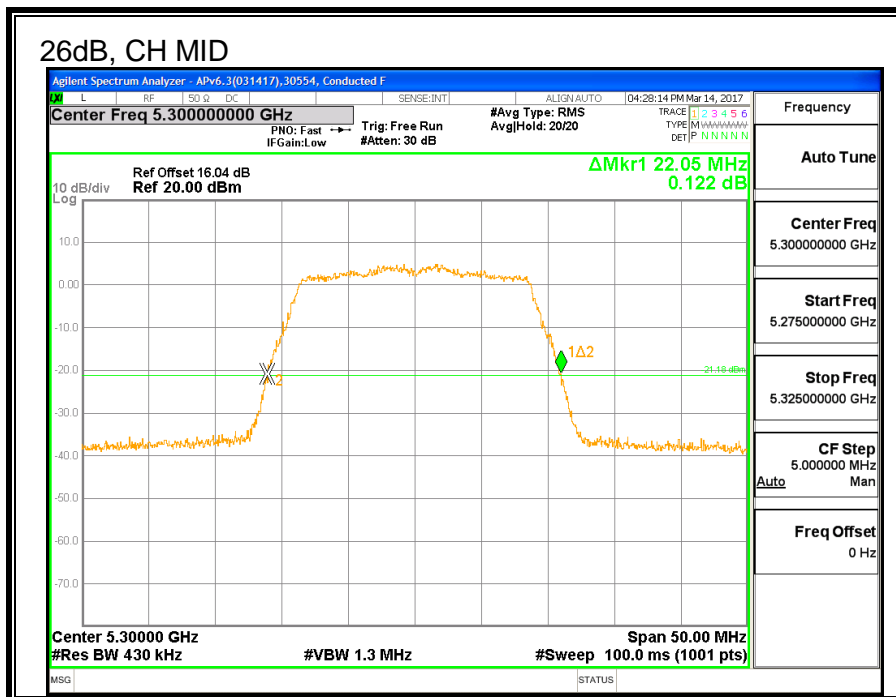
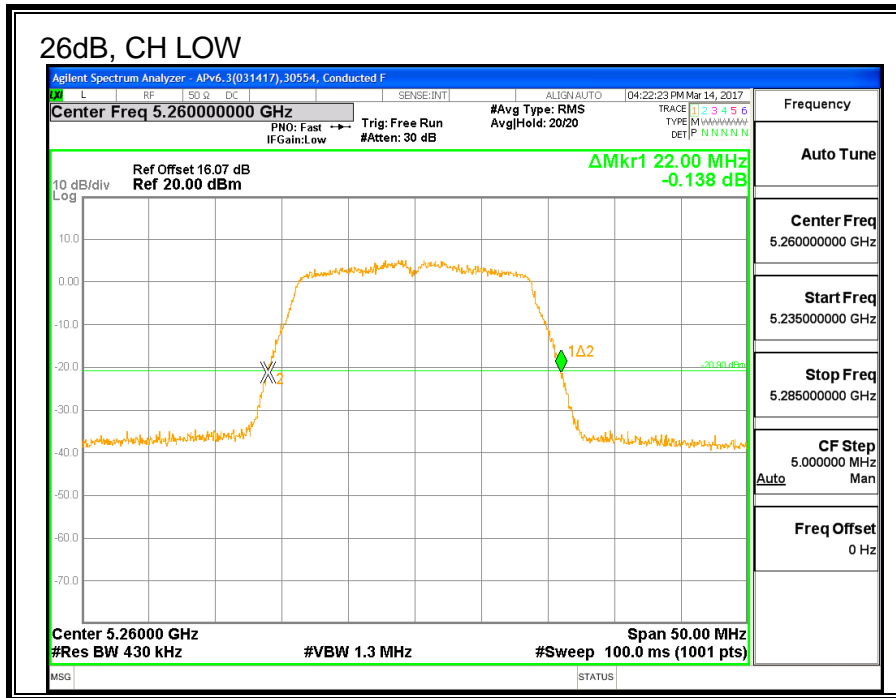

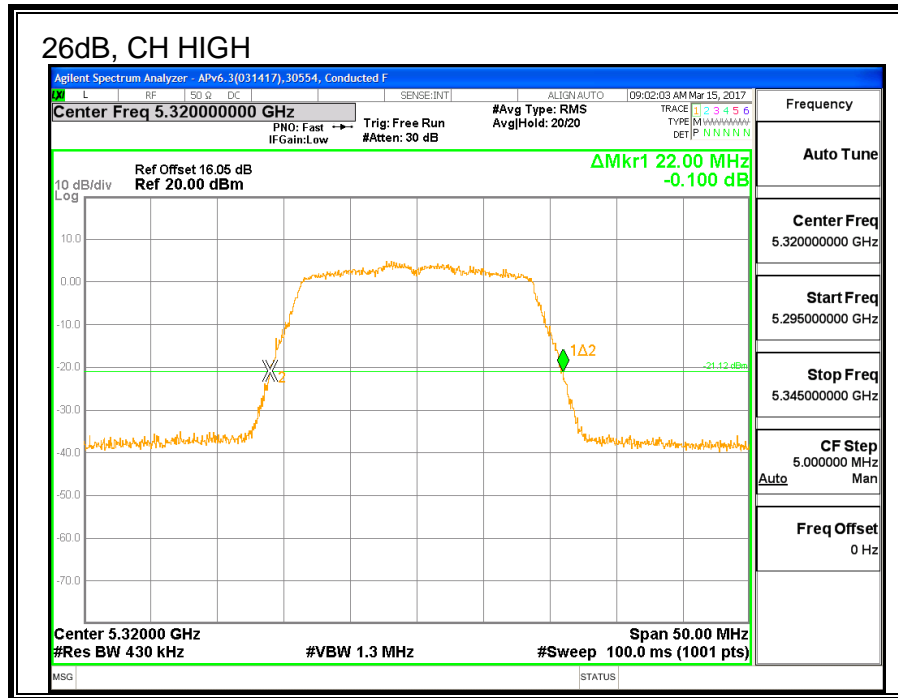

8.11.2. 99% BANDWIDTH

LIMITS

None; for reporting purposes only.

RESULTS

Channel	Frequency	99% BW LAT 3 (MHz)
Low	5260	17.828
Mid	5300	17.645
High	5320	17.686

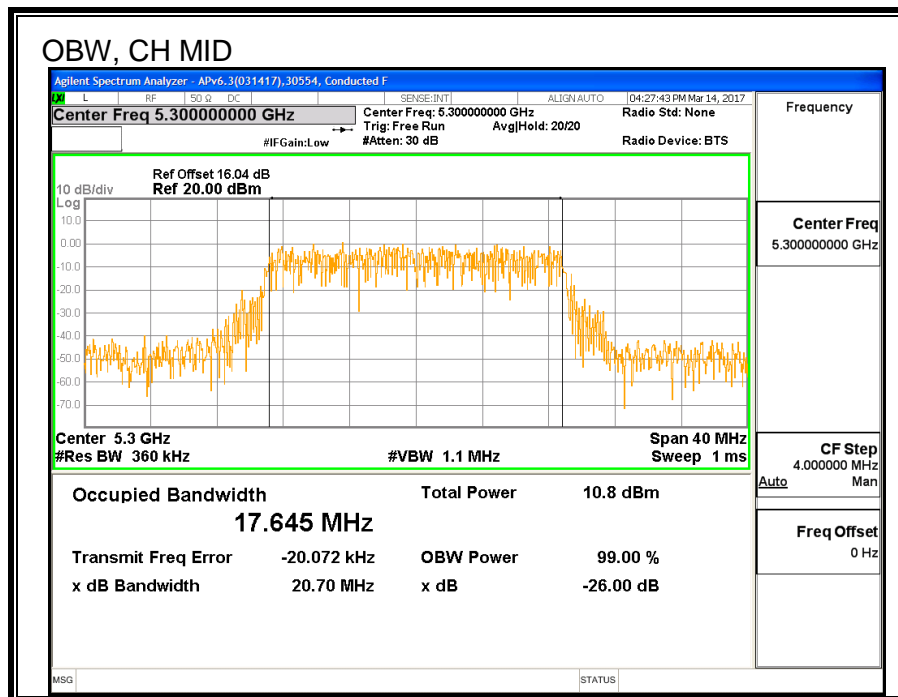
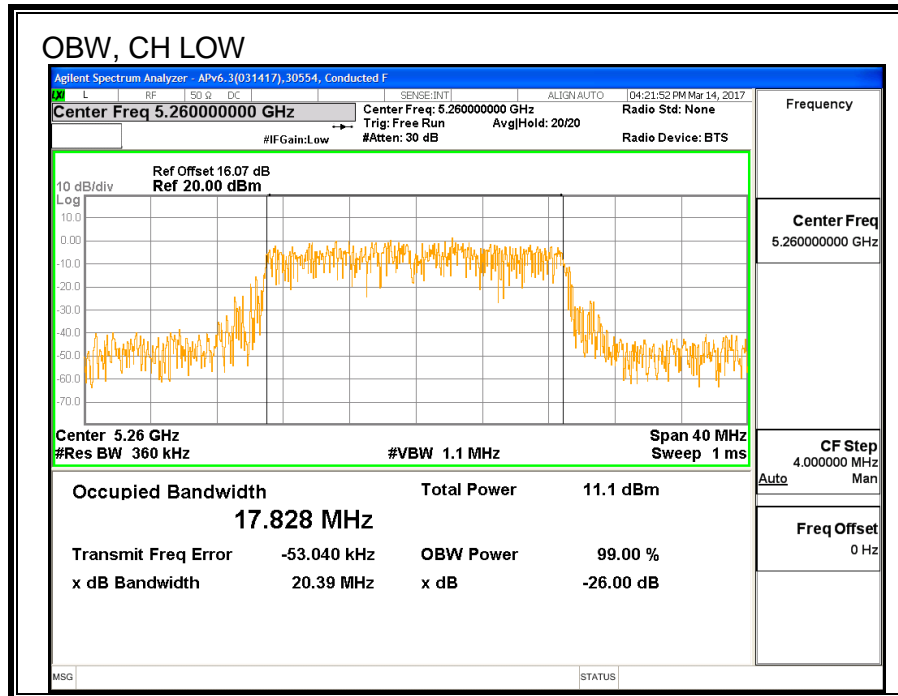

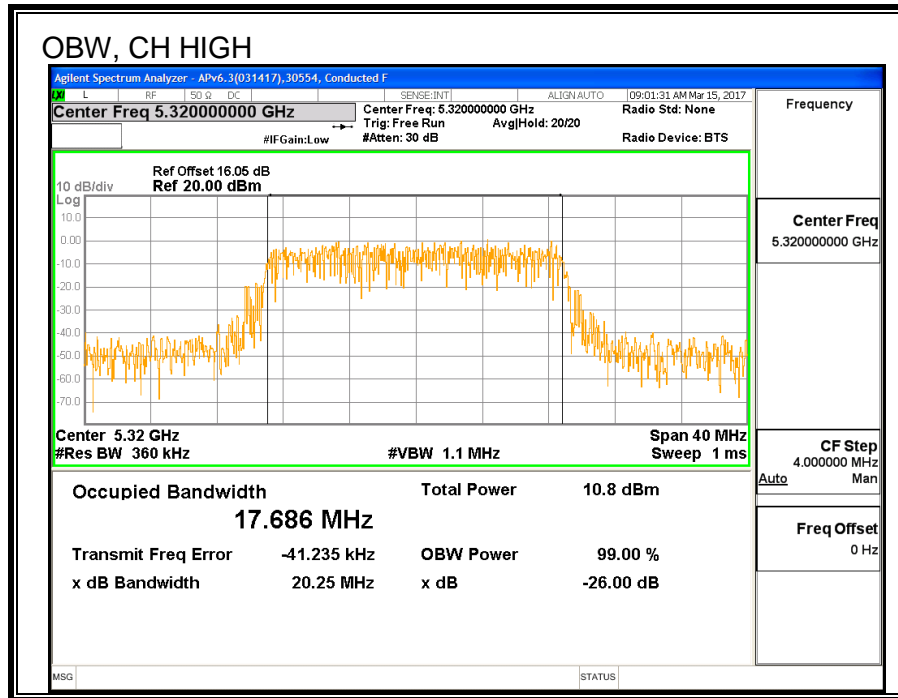

8.11.3. AVERAGE POWER

ID:	39472	Date:	3/11/17
------------	-------	--------------	---------

LIMITS

None; for reporting purposes only.

TEST PROCEDURE

Measurements perform using a wideband gated RF power meter.

RESULTS

Channel	Frequency	Power LAT 3 (dBm)
Low	5260	21.00
Mid	5300	19.45
High	5320	16.93

8.11.4. OUTPUT POWER AND PPSD

LIMITS

FCC §15.407 (a) (2)

For the band 5.25–5.35 GHz, the maximum conducted output power over the frequency band of operation shall not exceed the lesser of 250 mW or $11 \text{ dBm} + 10 \log B$, where B is the 26–dB emission bandwidth in MHz. In addition, the maximum power spectral density shall not exceed 11 dBm in any 1–MHz band. If transmitting antennas of directional gain greater than 6 dBi are used, both the maximum conducted output power and the peak power spectral density shall be reduced by the amount in dB that the directional gain of the antenna exceeds 6 dBi.

TEST PROCEDURE

Measurements perform using a wideband gated RF power meter provided that the gate parameters are adjusted such that the power is measured only when the EUT is transmitting at its maximum power control level. Since the measurement is made only during the ON time of the transmitter, no duty cycle correction factor is required.

PSD test procedure: KDB 789033 D02 v01r04 Section F (SA-2 method)

DIRECTIONAL ANTENNA GAIN

There is only one transmitter output therefore the directional gain is equal to the antenna gain.

RESULTS

Bandwidth, Antenna Gain, and Limits

Channel	Frequency (MHz)	Min 26 dB BW (MHz)	Min 99% BW (MHz)	Directional Gain (dBi)	Power Limit (dBm)	PSD Limit (dBm)
Low	5260	22.000	17.828	-1.09	23.51	11.00
Mid	5300	22.050	17.645	-1.09	23.47	11.00
High	5320	22.000	17.686	-1.09	23.48	11.00

Duty Cycle CF (dB)	0.00	Included in Calculations of Corr'd PSD
---------------------------	------	-----------------------------------------------

Output Power Results

Channel	Frequency (MHz)	LAT 3 Meas Power (dBm)	Total Corr'd Power (dBm)	Power Limit (dBm)	Power Margin (dB)
Low	5260	21.00	21.00	23.51	-2.51
Mid	5300	19.45	19.45	23.47	-4.02
High	5320	16.93	16.93	23.48	-6.55

PSD Results

Channel	Frequency (MHz)	LAT 3 Meas PSD (dBm)	Total Corr'd PSD (dBm)	PSD Limit (dBm)	PSD Margin (dB)
Low	5260	10.087	10.09	11.00	-0.91
Mid	5300	9.246	9.25	11.00	-1.75
High	5320	6.783	6.78	11.00	-4.22

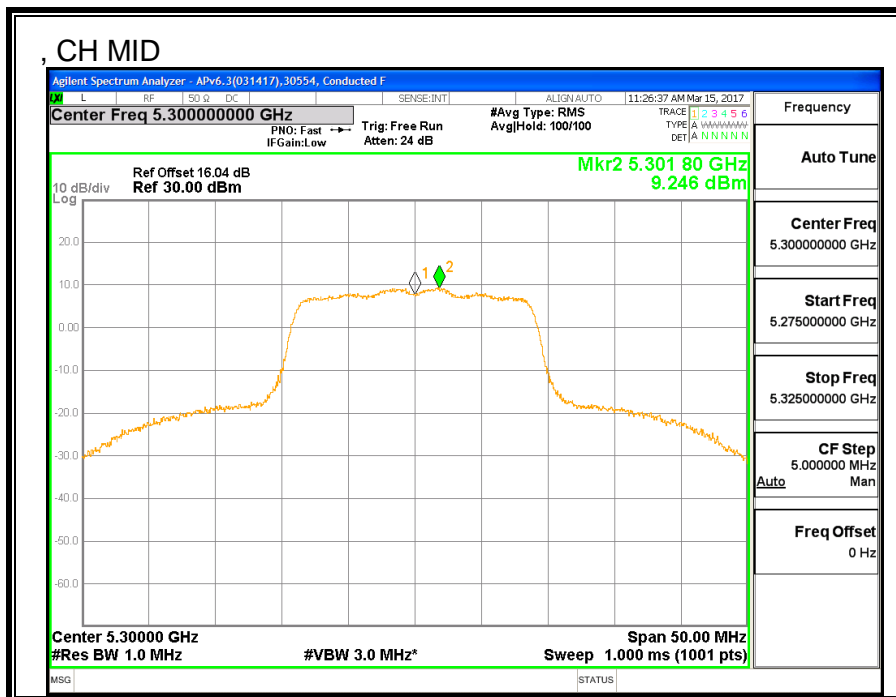
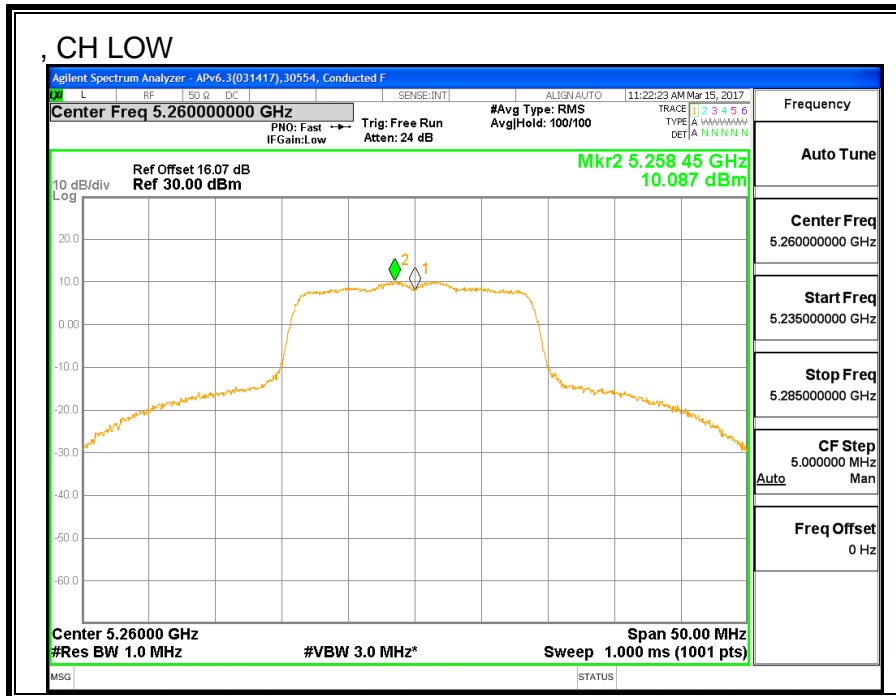

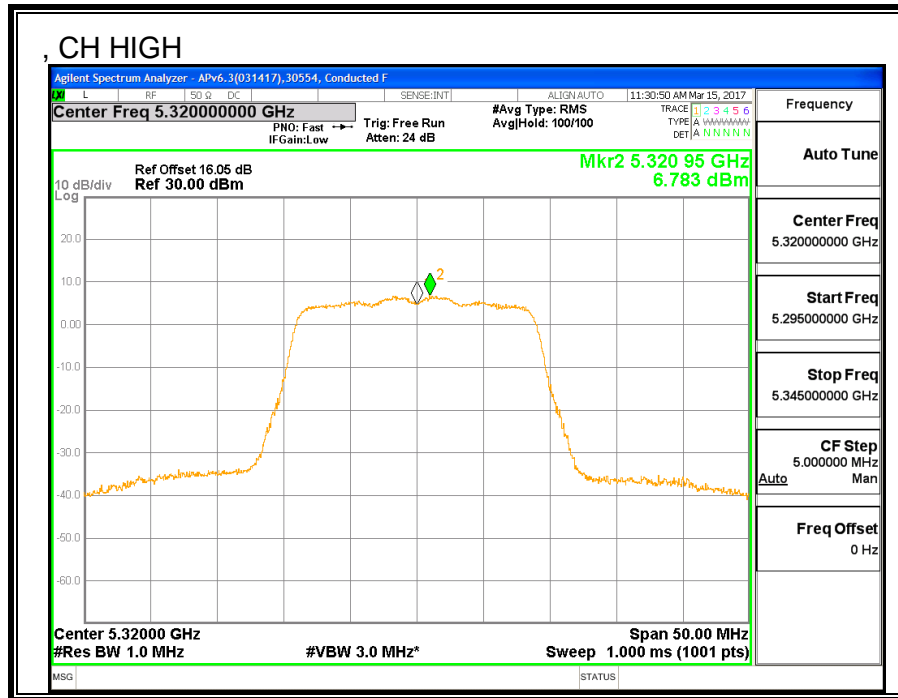

8.12. 11n HT20 2TX CDD MIMO MODE IN THE 5.3GHz BAND

8.12.1. 26 dB BANDWIDTH

LIMITS

None; for reporting purposes only.

RESULTS

Channel	Frequency	26 dB BW UAT 2 (MHz)	26 dB BW LAT 3 (MHz)
Low	5260	22.05	21.50
Mid	5300	22.15	21.70
High	5320	21.95	21.65

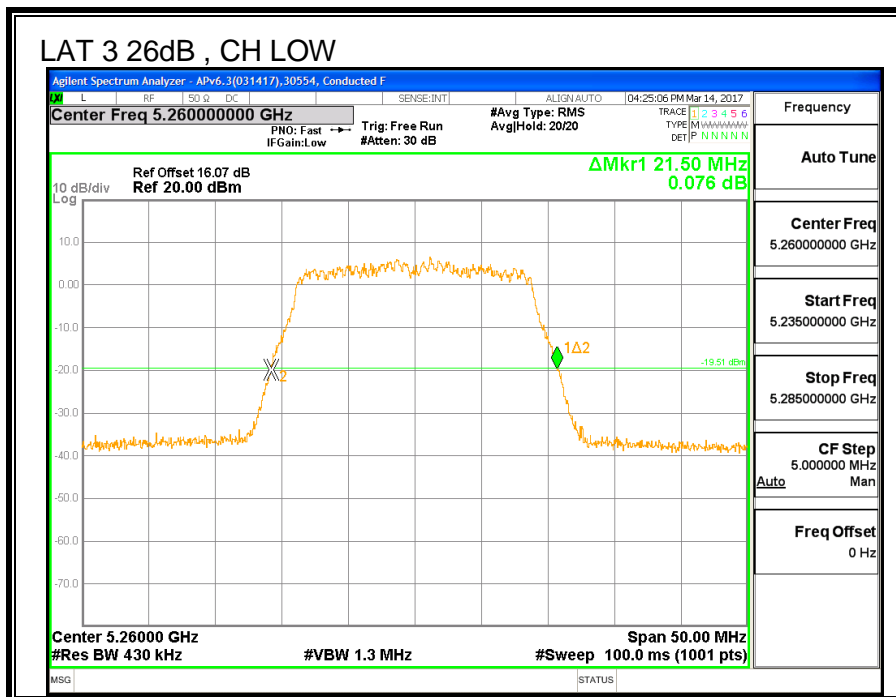
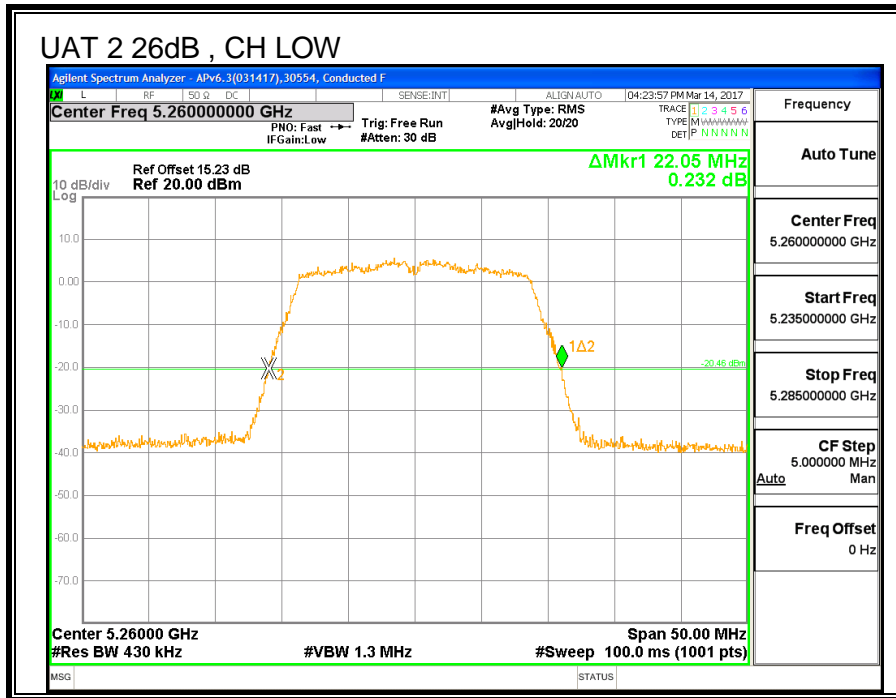

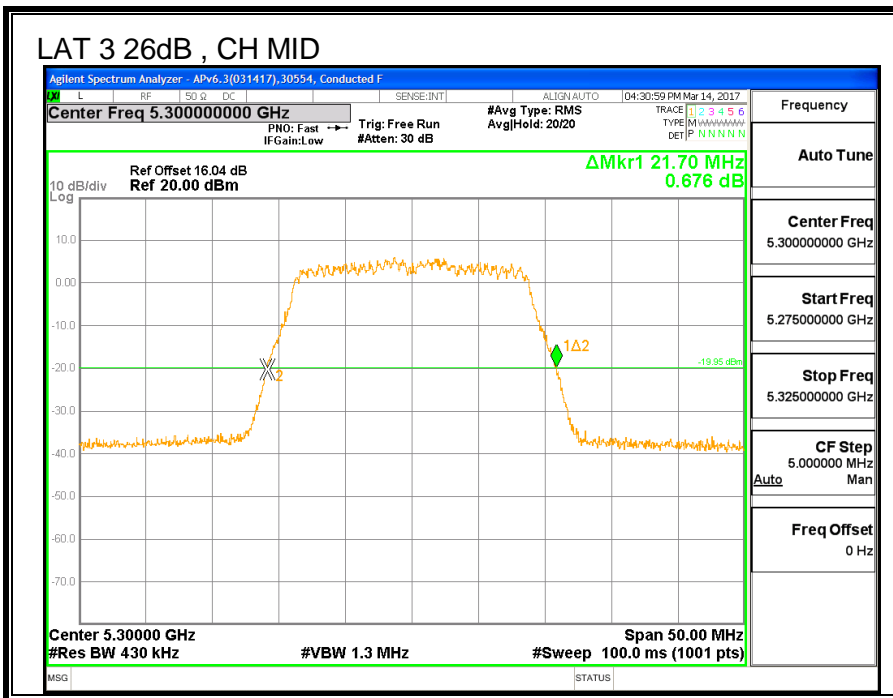
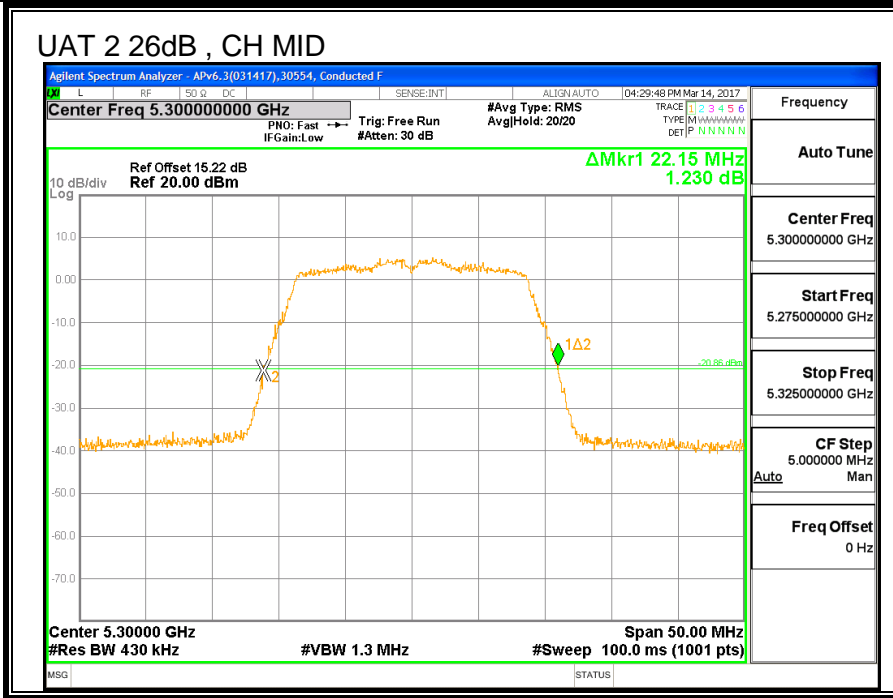

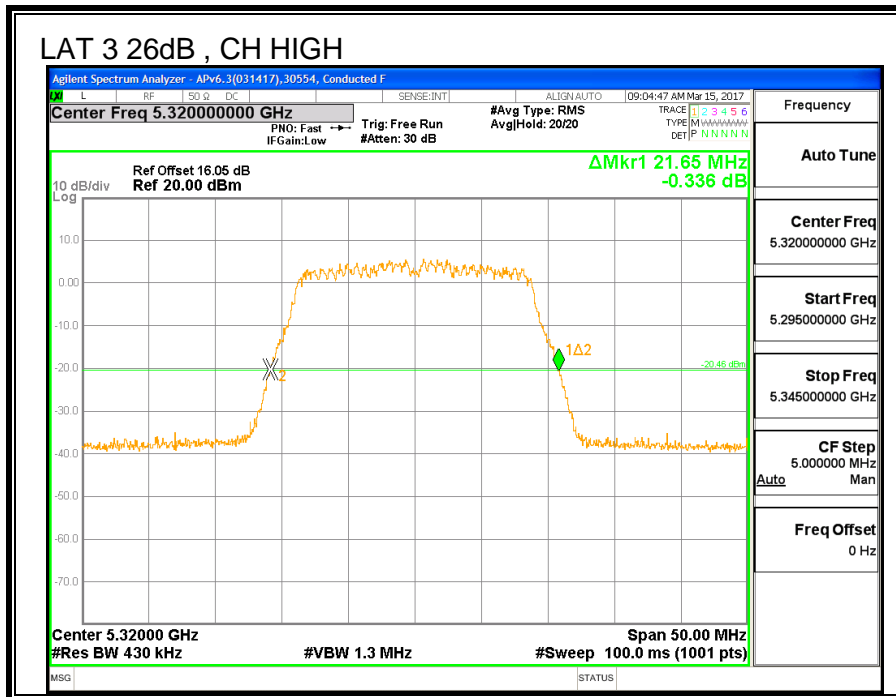
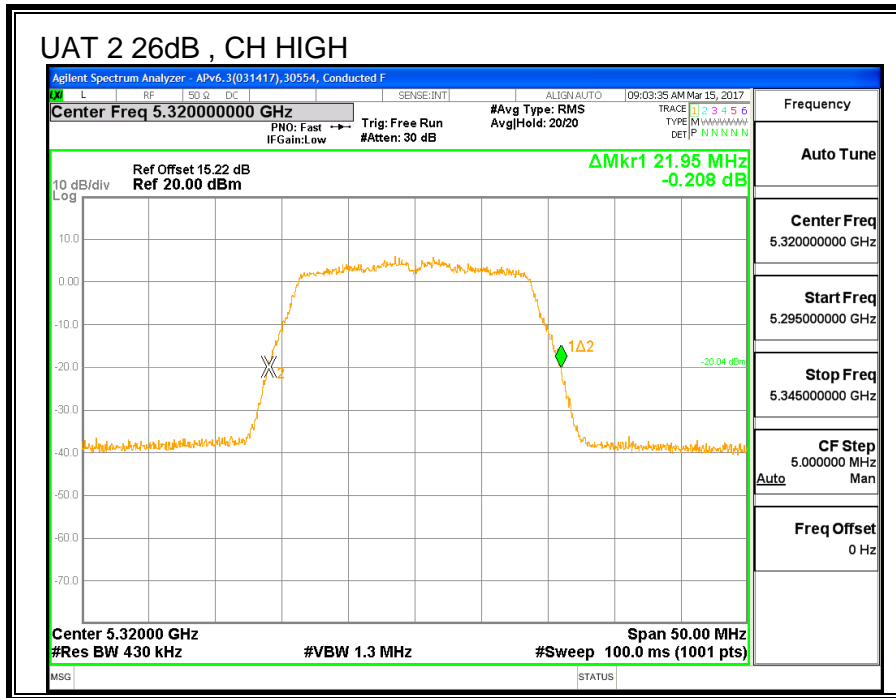

8.12.2. 99% BANDWIDTH

LIMITS

None; for reporting purposes only.

RESULTS

Channel	Frequency	99% BW UAT 2 (MHz)	99% BW LAT 3 (MHz)
Low	5260	17.683	17.837
Mid	5300	17.708	17.666
High	5320	17.683	17.834

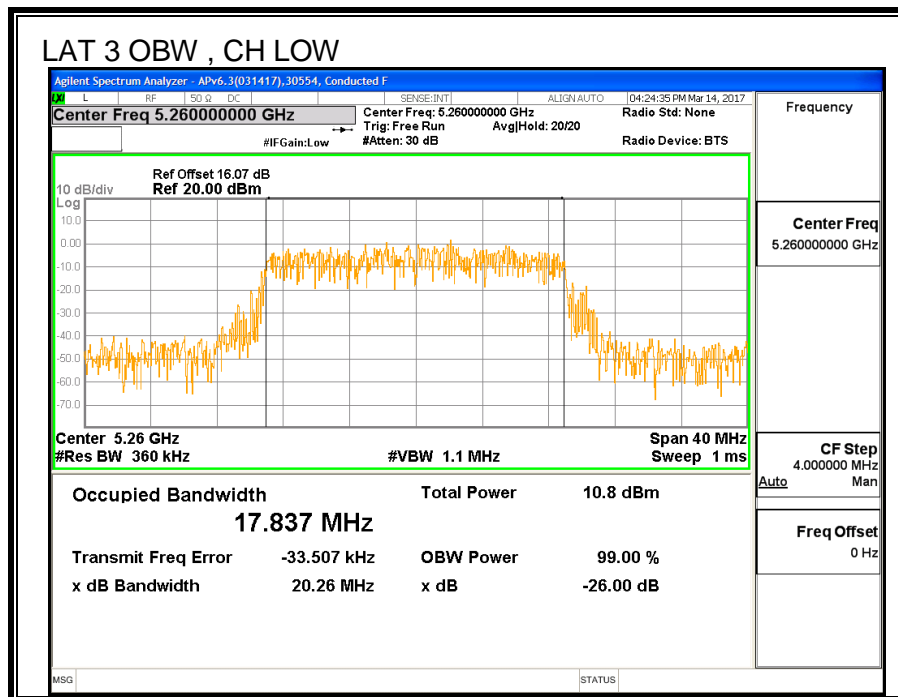
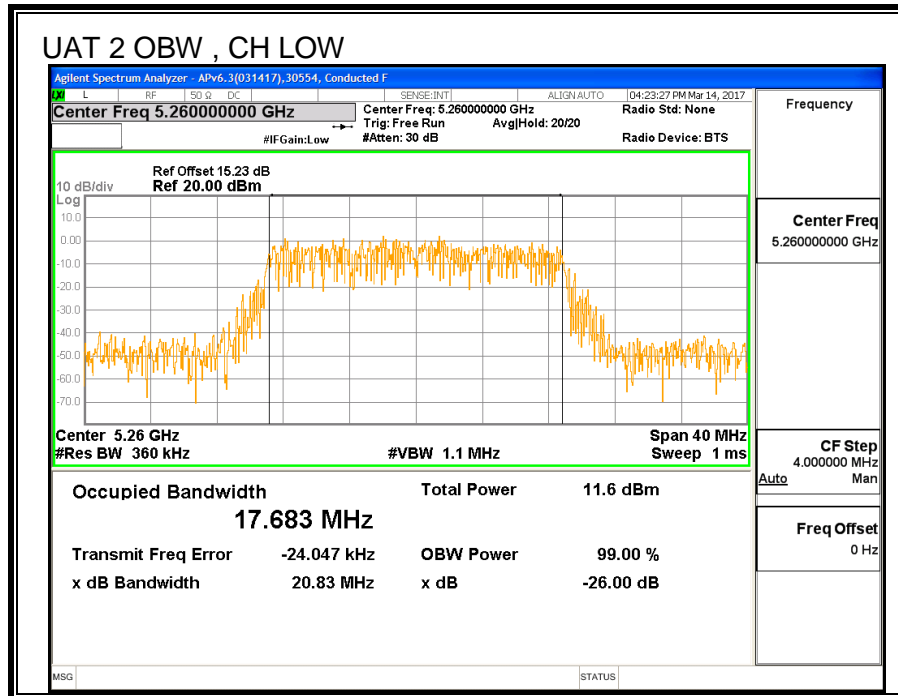

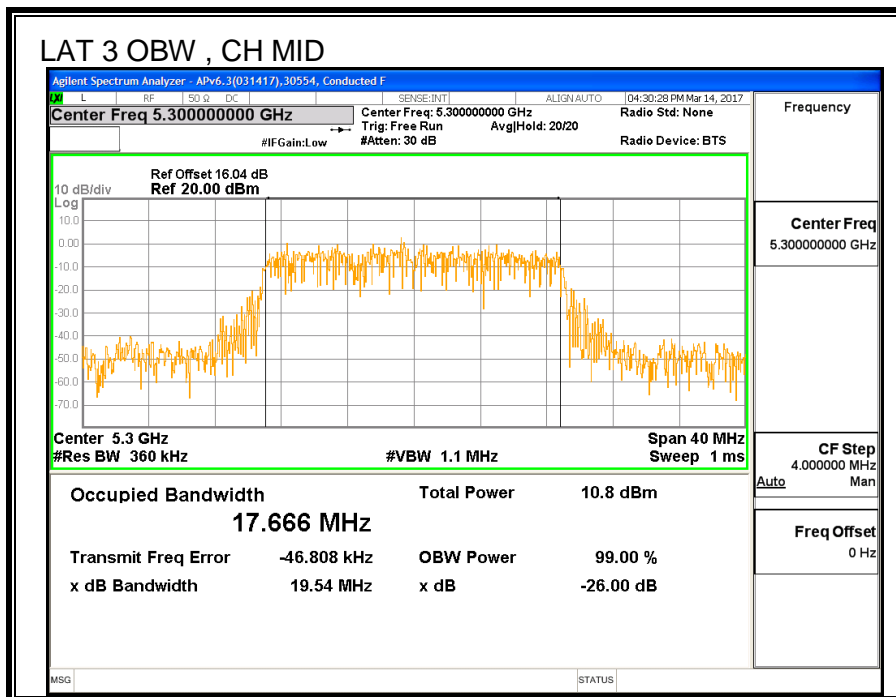
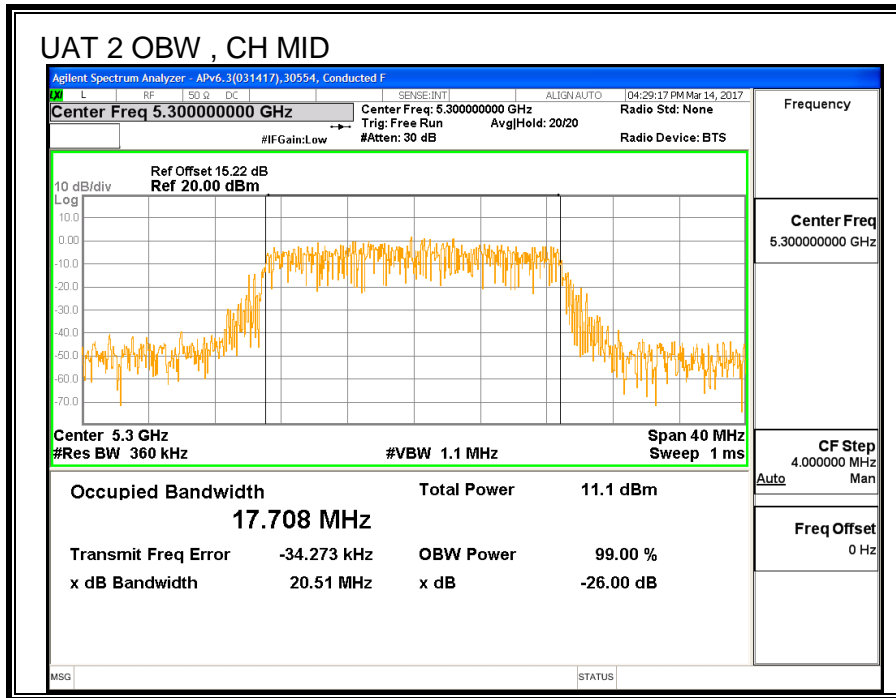

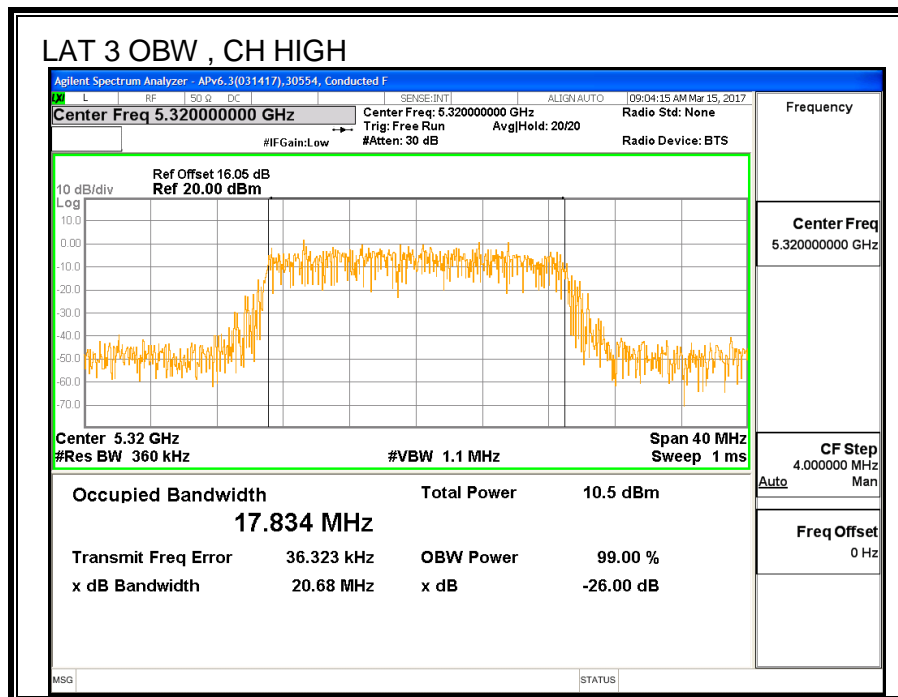
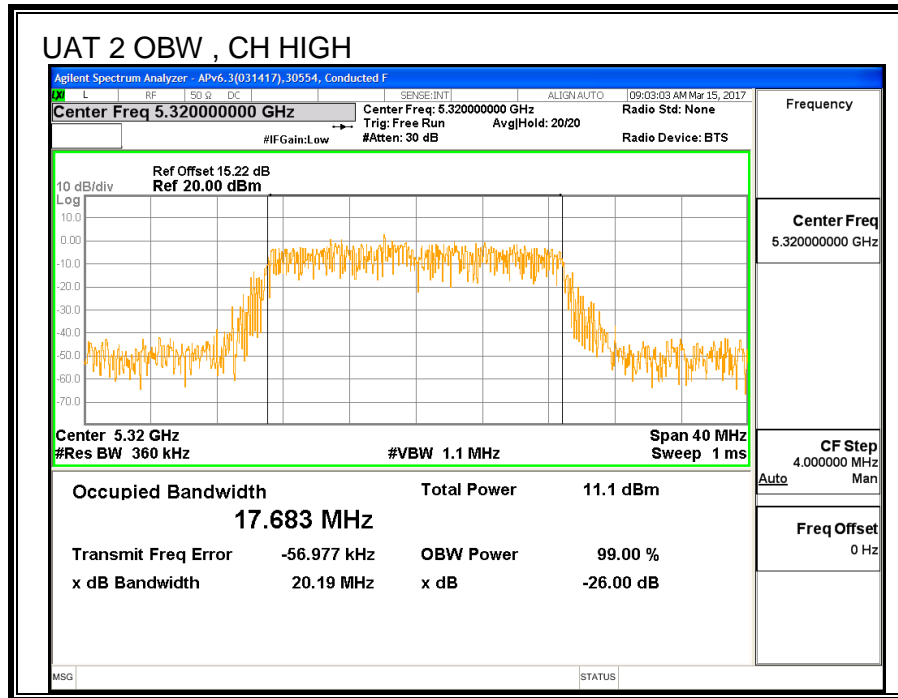

8.12.3. AVERAGE POWER

ID:	39472	Date:	6/11/17
------------	-------	--------------	---------

LIMITS

None; for reporting purposes only.

TEST PROCEDURE

Measurements perform using a wideband gated RF power meter.

RESULTS

Channel	Frequency	Power UAT 2 (dBm)	Power LAT 3 (dBm)	Total Power (dBm)
Low	5260	17.74	17.89	20.83
Mid	5300	17.80	17.92	20.87
High	5320	16.88	16.96	19.93

8.12.4. OUTPUT POWER AND PPSD

LIMITS

FCC §15.407 (a) (2)

For the band 5.25–5.35 GHz, the maximum conducted output power over the frequency band of operation shall not exceed the lesser of 250 mW or $11 \text{ dBm} + 10 \log B$, where B is the 26-dB emission bandwidth in MHz. In addition, the maximum power spectral density shall not exceed 11 dBm in any 1-MHz band. If transmitting antennas of directional gain greater than 6 dBi are used, both the maximum conducted output power and the peak power spectral density shall be reduced by the amount in dB that the directional gain of the antenna exceeds 6 dBi.

TEST PROCEDURE

Measurements perform using a wideband gated RF power meter provided that the gate parameters are adjusted such that the power is measured only when the EUT is transmitting at its maximum power control level. Since the measurement is made only during the ON time of the transmitter, no duty cycle correction factor is required.

PSD test procedure: KDB 789033 D02 v01r04 Section F (SA-2 method)

DIRECTIONAL ANTENNA GAIN

For Power used uncorrelated gain: The TX chains are uncorrelated and the antenna gain is unequal among the chains. The directional gain is:

UAT 2 Antenna Gain (dBi)	LAT 3 Antenna Gain (dBi)	Uncorrelated Chains Directional Gain (dBi)
-3.74	-1.09	-2.22

For PSD used correlated gain: The TX chains are correlated and the antenna gain is unequal among the chains. The directional gain is:

UAT 2 Antenna Gain (dBi)	LAT 3 Antenna Gain (dBi)	Correlated Chains Directional Gain (dBi)
-3.74	-1.09	0.70

RESULTS

Bandwidth, Antenna Gain and Limits

Channel	Frequency (MHz)	Min 26 dB BW (MHz)	Min 99% BW (MHz)	Directional Gain for Power (dBi)	Directional Gain for PSD (dBi)	Power Limit (dBm)	PSD Limit (dBm)
Low	5260	22.05	17.837	-2.22	0.70	23.51	11.00
Mid	5300	22.15	17.666	-2.22	0.70	23.47	11.00
High	5320	21.95	17.834	-2.22	0.70	23.51	11.00

Duty Cycle CF (dB)	0.00	Included in Calculations of Corr'd PSD
---------------------------	------	-----------------------------------------------

Output Power Results

Channel	Frequency (MHz)	UAT 2 Meas Power (dBm)	LAT 3 Meas Power (dBm)	Total Corr'd Power (dBm)	Power Limit (dBm)	Power Margin (dB)
Low	5260	17.74	17.89	20.83	23.51	-2.69
Mid	5300	17.80	17.92	20.87	23.47	-2.60
High	5320	16.88	16.96	19.93	23.51	-3.58

PSD Results

Channel	Frequency (MHz)	UAT 2 Meas PSD (dBm)	LAT 3 Meas PSD (dBm)	Total Corr'd PSD (dBm)	PSD Limit (dBm)	PSD Margin (dB)
Low	5260	7.575	8.023	10.82	11.00	-0.18
Mid	5300	7.317	7.773	10.56	11.00	-0.44
High	5320	7.427	7.582	10.52	11.00	-0.48

