



**FCC 47 CFR PART 15 SUBPART C
INDUSTRY CANADA RSS-247 ISSUE 1**

**BLUETOOTH LOW ENERGY
CERTIFICATION TEST REPORT**

FOR

CELLULAR PHONE WITH BLUETOOTH AND WLAN RADIOS

MODEL NUMBER: A1779

**FCC ID: BCG-E3086A
IC: 579C-E3086A**

REPORT NUMBER: 16U23310-E6V1

ISSUE DATE: AUGUST 26, 2016

Prepared for
**APPLE, INC.
1 INFINITE LOOP
CUPERTINO, CA 95014, U.S.A.**

Prepared by
**UL VERIFICATION SERVICES INC.
47173 BENICIA STREET
FREMONT, CA 94538, U.S.A.
TEL: (510) 771-1000
FAX: (510) 661-0888**



NVLAP LAB CODE 200065-0

Revision History

<u>Rev.</u>	<u>Issue Date</u>	<u>Revisions</u>	<u>Revised By</u>
V1	8/26/2016	Initial Issue	Chin Pang

TABLE OF CONTENTS

1. ATTESTATION OF TEST RESULTS	5
2. TEST METHODOLOGY	6
3. FACILITIES AND ACCREDITATION	6
4. CALIBRATION AND UNCERTAINTY	7
4.1. MEASURING INSTRUMENT CALIBRATION	7
4.2. SAMPLE CALCULATION	7
4.3. MEASUREMENT UNCERTAINTY.....	7
5. EQUIPMENT UNDER TEST	8
5.1. DESCRIPTION OF EUT	8
5.2. MAXIMUM OUTPUT POWER.....	8
5.3. DESCRIPTION OF AVAILABLE ANTENNAS	8
5.4. SOFTWARE AND FIRMWARE.....	8
5.5. WORST-CASE CONFIGURATION AND MODE.....	9
5.6. DESCRIPTION OF TEST SETUP.....	10
6. TEST AND MEASUREMENT EQUIPMENT	16
7. ANTENNA PORT TEST RESULTS	17
7.1. MEASUREMENT METHODS	17
7.2. ON TIME, DUTY CYCLE	18
7.3. 6 dB BANDWIDTH.....	20
7.4. 99% BANDWIDTH.....	22
7.5. AVERAGE POWER.....	24
7.6. OUTPUT POWER.....	25
7.7. POWER SPECTRAL DENSITY	26
7.8. CONDUCTED SPURIOUS EMISSIONS.....	28
8. RADIATED TEST RESULTS.....	32
8.1. LIMITS AND PROCEDURE	32
8.2. TRANSMITTER ABOVE 1 GHz	33
8.2.1. RESTRICTED BANDEDGE	33
8.2.2. HARMONICS AND SPURIOUS EMISSIONS	37
8.3. WORST-CASE BELOW 1 GHz.....	43
8.4. WORST-CASE 18 to 26 GHz.....	45
9. AC POWER LINE CONDUCTED EMISSIONS.....	47
9.1. EUT POWERED BY AC/DC ADAPTER VIA USB CABLE	48

9.2. EUT POWERED BY HOST PC VIA USB CABLE50

10. SETUP PHOTOS52

1. ATTESTATION OF TEST RESULTS

COMPANY NAME: APPLE, INC.
1 INFINITE LOOP
CUPERTINO, CA 95014, U.S.A.

EUT DESCRIPTION: CELLULAR PHONE WITH BLUETOOTH AND WLAN RADIOS

MODEL: A1779

SERIAL NUMBER: C7CS100ZHGC (Conducted), C7CS100DHGC (Radiated)

DATE TESTED: AUGUST 24 TO 26, 2016

APPLICABLE STANDARDS	
STANDARD	TEST RESULTS
CFR 47 Part 15 Subpart C	Pass
INDUSTRY CANADA RSS-247 Issue 1	Pass
INDUSTRY CANADA RSS-GEN Issue 4	Pass

UL Verification Services Inc. tested the above equipment in accordance with the requirements set forth in the above standards. All indications of Pass/Fail in this report are opinions expressed by UL Verification Services Inc. based on interpretations and/or observations of test results. Measurement Uncertainties were not taken into account and are published for informational purposes only. The test results show that the equipment tested is capable of demonstrating compliance with the requirements as documented in this report.

Note: The results documented in this report apply only to the tested sample, under the conditions and modes of operation as described herein. This document may not be altered or revised in any way unless done so by UL Verification Services Inc. and all revisions are duly noted in the revisions section. Any alteration of this document not carried out by UL Verification Services Inc. will constitute fraud and shall nullify the document. This report must not be used by the client to claim product certification, approval, or endorsement by NVLAP, NIST, any agency of the Federal Government, or any agency of any government.

Approved & Released For
UL Verification Services Inc. By:

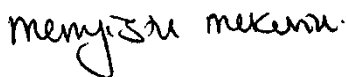

MENGISTU MEKURIA
SENIOR ENGINEER
UL VERIFICATION SERVICES INC.

Prepared By:



HUNG THAI
EMC TECHNICIAN
UL VERIFICATION SERVICES INC.

2. TEST METHODOLOGY

The tests documented in this report were performed in accordance with FCC CFR 47 Part 2, FCC CFR 47 Part 15, KDB 558074 D01 v03r05, ANSI C63.10-2013, RSS-GEN Issue 4, and RSS-247 Issue 1.

3. FACILITIES AND ACCREDITATION

The test sites and measurement facilities used to collect data are located at 47173 and 47266 Benicia Street, Fremont, California, USA. Line conducted emissions are measured only at the 47173 address. The following table identifies which facilities were utilized for radiated emission measurements documented in this report. Specific facilities are also identified in the test results sections.

47173 Benicia Street	47266 Benicia Street
<input type="checkbox"/> Chamber A	<input type="checkbox"/> Chamber D
<input type="checkbox"/> Chamber B	<input checked="" type="checkbox"/> Chamber E
<input type="checkbox"/> Chamber C	<input type="checkbox"/> Chamber F
	<input type="checkbox"/> Chamber G
	<input checked="" type="checkbox"/> Chamber H

The above test sites and facilities are covered under FCC Test Firm Registration # 208313. Chambers A through H are covered under Industry Canada company address code 2324B with site numbers 2324B -1 through 2324B-8, respectively.

UL Verification Services Inc. is accredited by NVLAP, Laboratory Code 200065-0. The full scope of accreditation can be viewed at <http://ts.nist.gov/standards/scopes/2000650.htm>.

4. CALIBRATION AND UNCERTAINTY

4.1. MEASURING INSTRUMENT CALIBRATION

The measuring equipment utilized to perform the tests documented in this report has been calibrated in accordance with the manufacturer's recommendations, and is traceable to recognized national standards.

4.2. SAMPLE CALCULATION

Where relevant, the following sample calculation is provided:

$$\begin{aligned} \text{Field Strength (dBuV/m)} &= \text{Measured Voltage (dBuV)} + \text{Antenna Factor (dB/m)} + \\ &\text{Cable Loss (dB)} - \text{Preamp Gain (dB)} \\ 36.5 \text{ dBuV} + 18.7 \text{ dB/m} + 0.6 \text{ dB} - 26.9 \text{ dB} &= 28.9 \text{ dBuV/m} \end{aligned}$$

4.3. MEASUREMENT UNCERTAINTY

Where relevant, the following measurement uncertainty levels have been estimated for tests performed on the apparatus:

PARAMETER	UNCERTAINTY
Conducted Disturbance, 9KHz to 0.15 MHz	± 3.84dB
Conducted Disturbance, 0.15 to 30 MHz	± 3.65 dB
Radiated Disturbance, 9KHz to 30 MHz	± 3.15 dB
Radiated Disturbance, 30 to 1000 MHz	± 5.36 dB
Radiated Disturbance, 1000 to 18000 MHz	± 4.32 dB
Radiated Disturbance, 18000 to 26000 MHz	± 4.45 dB
Radiated Disturbance, 26000 to 40000 MHz	± 5.24dB

Uncertainty figures are valid to a confidence level of 95%.

5. EQUIPMENT UNDER TEST

5.1. DESCRIPTION OF EUT

The EUT Model A1779 is a mobile phone with multimedia functions (music, application support, and video), cellular GSM/GPRS/EGPRS/CDMA/WCDMA/HSPA+/DC-HSDPA/LTE-radio, IEEE 802.11a/b/g/n/ac, NFC and Bluetooth radio. The rechargeable battery is not user accessible.

5.2. MAXIMUM OUTPUT POWER

The transmitter has a maximum peak conducted output power as follows:

Frequency Range (MHz)	Mode	Output Power (dBm)	Output Power (mW)
2402 - 2480	BLE	16.25	42.17

5.3. DESCRIPTION OF AVAILABLE ANTENNAS

Frequency Band (GHz)	Antenna Gain (dBi)
2.4	-1.80

5.4. SOFTWARE AND FIRMWARE

The firmware version installed in the EUT during testing was 14.1.39.180
The test utility software used during testing was BlueTool.

5.5. WORST-CASE CONFIGURATION AND MODE

Radiated emission and power line conducted emission were performed with the EUT set to transmit at the channel with highest output power as worst-case scenario.

The fundamental of the EUT was investigated in three orthogonal orientations X/Y/Z, it was determined that X orientation was worst-case orientation. Therefore, all final radiated testing was performed with the EUT in X orientation.

BLE: 1 Mbps.

There are two vendors of the WiFi/Bluetooth radio modules: variant 1 and variant 2. The WiFi/Bluetooth radio modules have the same mechanical outline (e.g., the same package dimension and pin-out layout), use the same on-board antenna matching circuit, have an identical antenna structure, and are built and tested to conform to the same specifications and to operate within the same tolerances.

Baseline testing was performed on the two variants to determine the worst case on all conducted power and radiated emissions.

For simultaneous transmission of multiple channels from the same antenna in the 2.4GHz and 5GHz bands, tests were conducted for various configurations having the highest power. No noticeable new emission was found.

5.6. DESCRIPTION OF TEST SETUP

SUPPORT EQUIPMENT

Support Equipment List				
Description	Manufacturer	Model	Serial Number	FCC ID
Laptop	Dell	Latitude 3540	9J6WQZ1	NA
Laptop Power Supply	Dell	LA65NM130	0JNKWD	NA

I/O CABLES (CONDUCTED TEST)

I/O Cable List						
Cable No	Port	# of identical ports	Connector Type	Cable Type	Cable Length (m)	Remarks
1	Antenna	1	SMA	Un-Shielded	0.2	To spectrum Analyzer
2	USB	2	USB	Shielded	1	N/A

I/O CABLES (RADIATED ABOVE 1 GHZ)

I/O Cable List						
Cable No	Port	# of identical ports	Connector Type	Cable Type	Cable Length (m)	Remarks
None Used						

I/O CABLES (AC POWER CONDUCTED TEST AND BELOW 1 GHZ)

I/O Cable List						
Cable No	Port	# of identical ports	Connector Type	Cable Type	Cable Length (m)	Remarks
1	AC	1	AC	Un-shielded	3	N/A

I/O CABLES (AC LINE CONDUCTED: AC/DC ADAPTER)

I/O Cable List						
Cable No	Port	# of identical	Connector Type	Cable Type	Cable Length (m)	Remarks
1	AC	1	AC	Un-shielded	3	N/A
2	Power Adapter	1	AC	Un-shielded	3	N/A

TEST SETUP- CONDUCTED PORT

The EUT was tested connected to a host Laptop via USB cable adapter and spectrum analyzer to antenna port. Test software exercised the EUT.

SETUP DIAGRAM

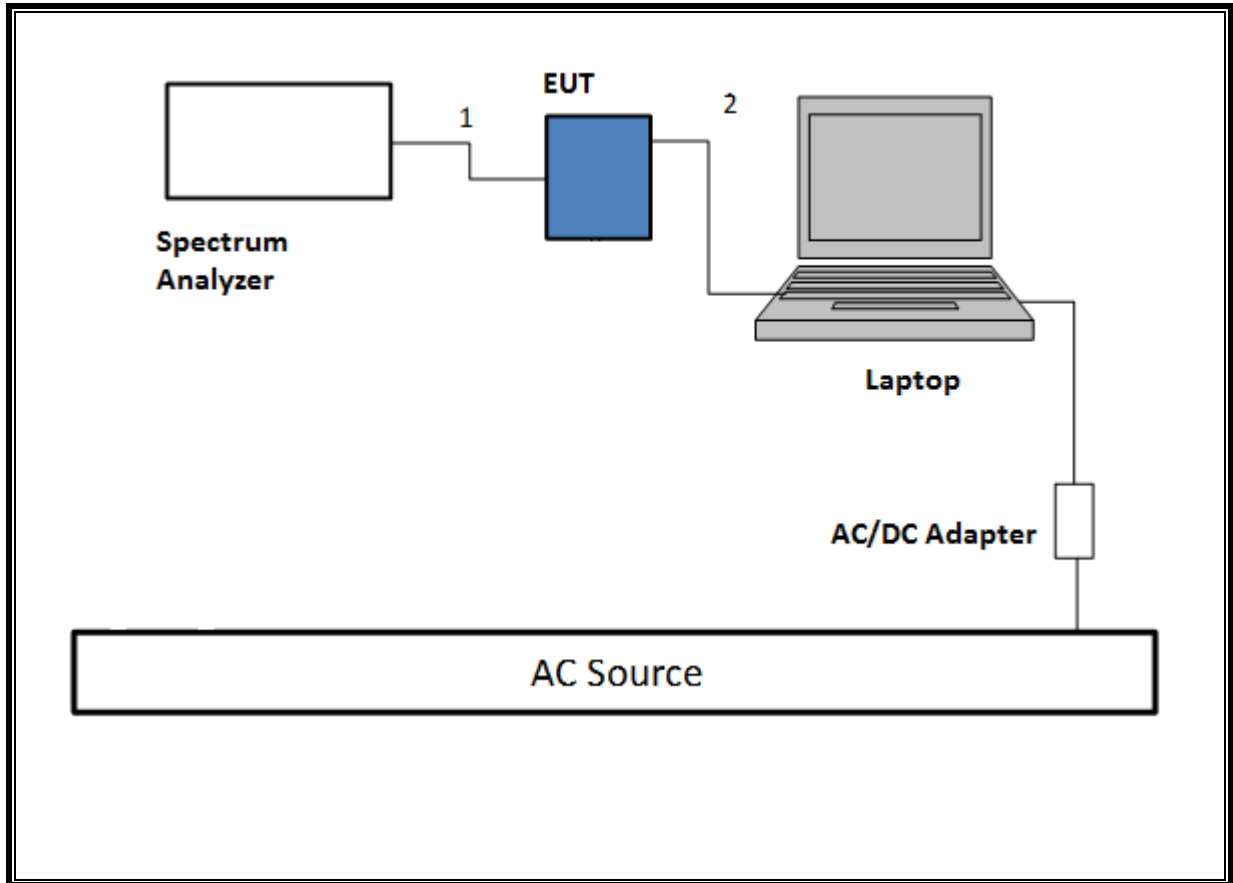

TEST SETUP- RADIATED-ABOVE 1 GHZ

The EUT was powered by battery. Test software exercised the EUT.

SETUP DIAGRAM

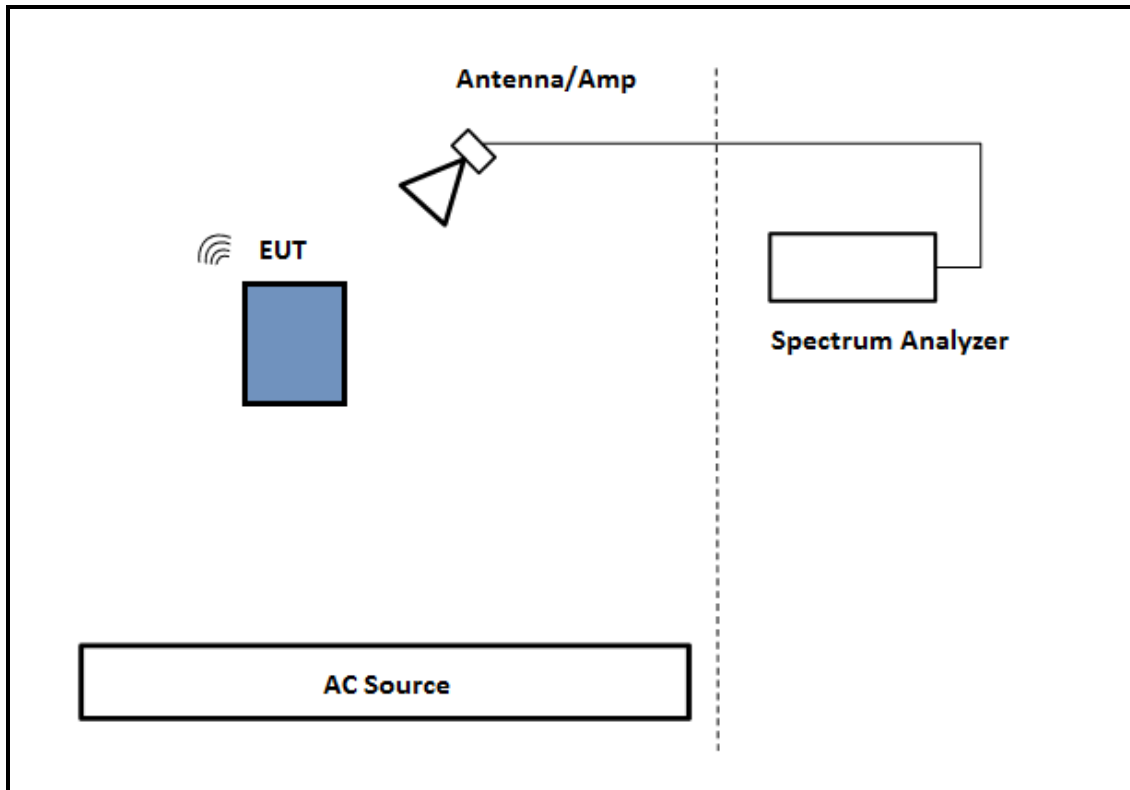

TEST SETUP- BELOW 1GHZ

The EUT was powered by AC cord. Test software exercised the EUT.

SETUP DIAGRAM

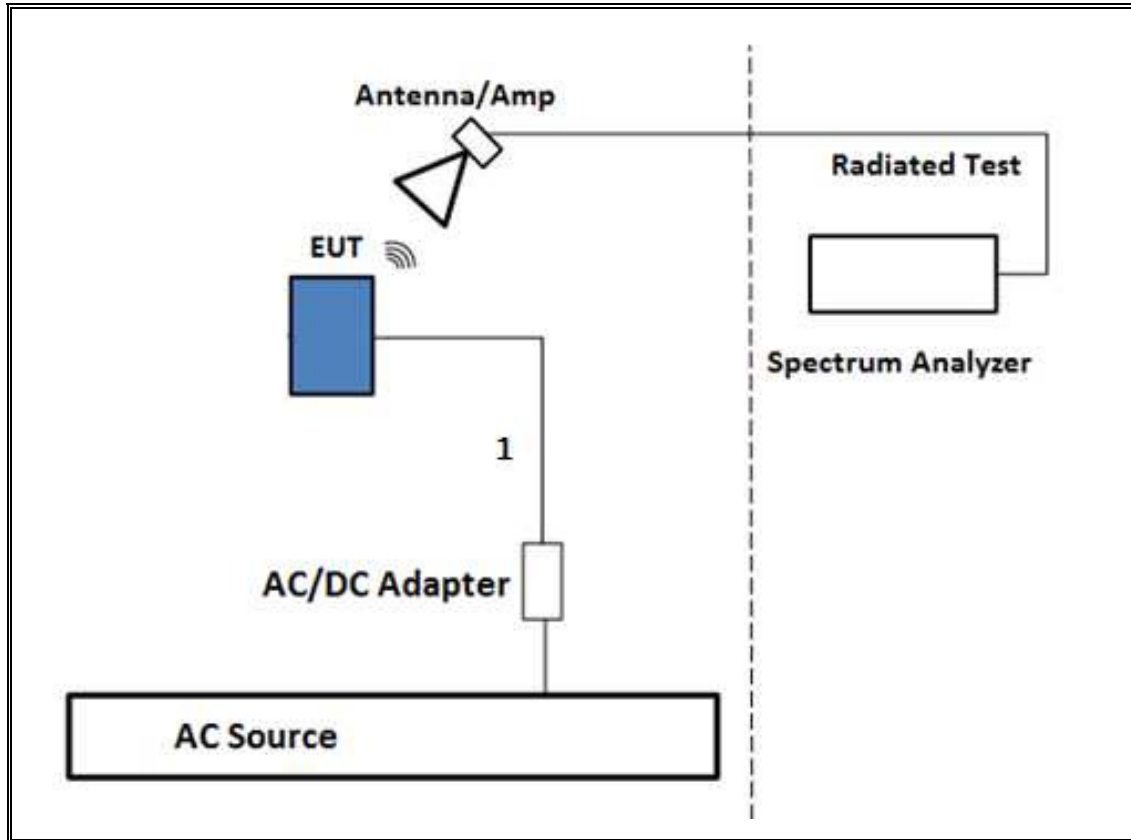

TEST SETUP- AC LINE CONDUCTED: AC/DC ADAPTER

The EUT was tested with powered by AC/DC adapter via USB cable. Test software exercised the EUT.

SETUP DIAGRAM

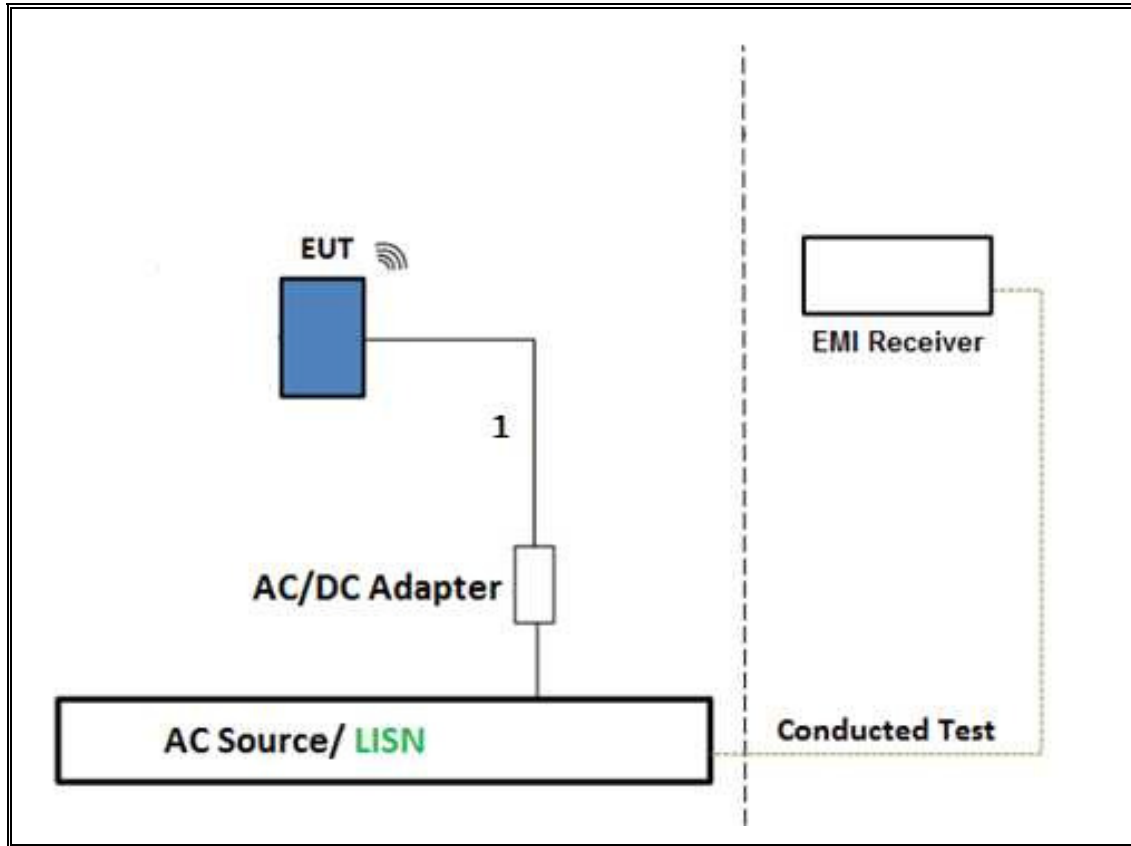

TEST SETUP- AC LINE CONDUCTED: LAPTOP CONFIGURATION

The EUT was tested with powered by host PC via USB cable. Test software exercised the EUT.

SETUP DIAGRAM

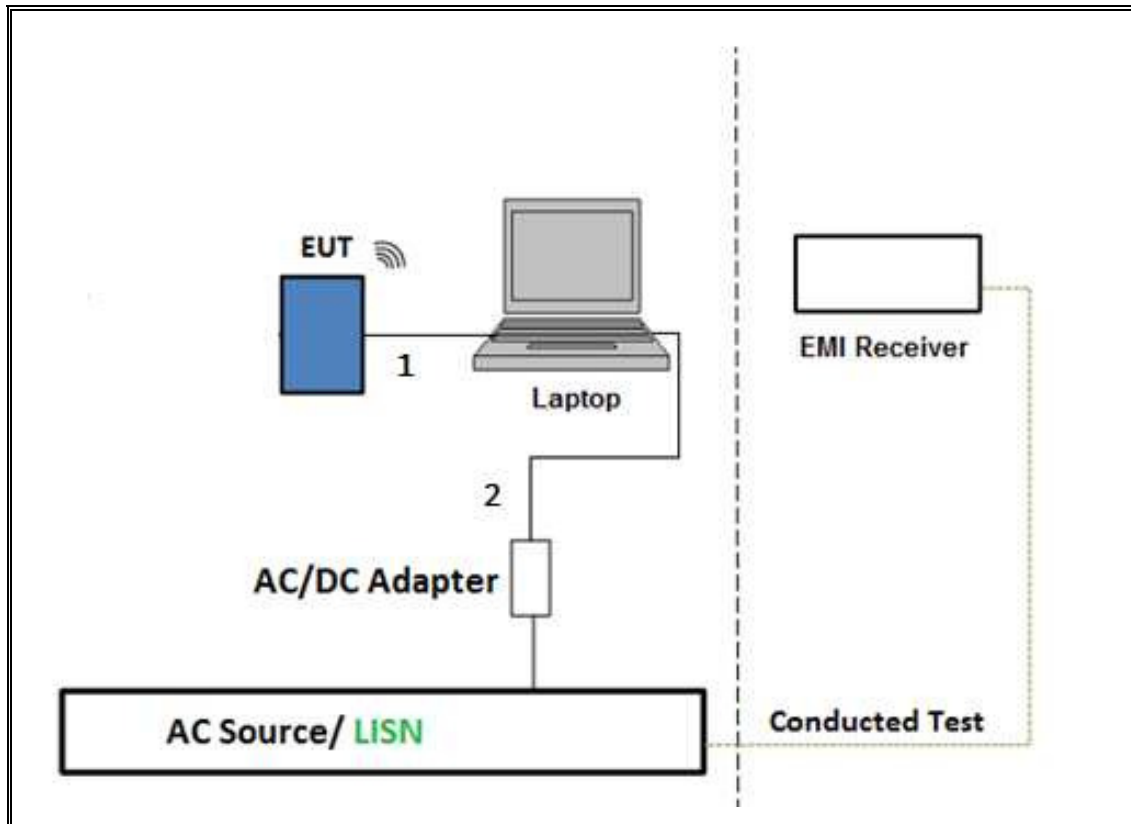

6. TEST AND MEASUREMENT EQUIPMENT

The following test and measurement equipment was utilized for the tests documented in this report:

Test Equipment List				
Description	Manufacturer	Model	T Number	Cal Due
Antenna, Horn 1-18GHz	ETS Lindgren	3117	T120	4/5/2017
Antenna, Broadband Hybrid, 30MHz to 2000MHz	Sunol Sciences	JB3	T122	1/29/2017
Amplifier, 10KHz to 1GHz, 32dB	Sonoma	310N	T173	6/17/2017
Spectrum Analyzer, PXA, 3Hz to 44GHz	Agilent	N9030A	T341	10/14/2016
Antenna, Horn 1-18GHz	ETS Lindgren	3117	T862	4/18/2017
Antenna, Broadband Hybrid, 30MHz to 2000MHz	Sunol Sciences	JB3	T899	5/26/2017
Amplifier, 1 - 18GHz	Miteq	AFS42-00101800-25-S-42	T491	5/31/2017
Amplifier, 10KHz to 1GHz, 32dB	Sonoma	310N	T834	6/17/2017
Power Meter, P-series single channel	Agilent	N1911A	T1271	7/8/2017
Power Sensor, P - series, 50MHz to 18GHz, Wideband	Agilent	N1921A	T1228	6/20/2017
Antenna, Horn 18 to 26.5GHz	ARA	MWH-1826	T447	6/16/2017
Spectrum Analyzer, 40 GHz	Agilent	8564E	T106	8/13/2016
Amplifier, 1 to 26.5GHz, 23.5dB Gain minimum	Keysight	8449B	T402	7/5/2017
AC Line Conducted				
EMI Test Receiver 9KHz-7GHz	Rohde & Schwarz	ESCI7	100935	9/16/2016
LISN for Conducted Emissions CISPR-16	Fischer	50/250-25-2	161124	9/16/2016
Power Cable, Line Conducted Emissions	UL	PG1	N/A	7/28/2016
UL SOFTWARE				
* Radiated Software	UL	UL EMC	Ver 9.5, June 24, 2015	
* Conducted Software	UL	UL EMC	Ver 4.0, January 11, 2016	

Note: * indicates automation software version used in the compliance certification testing

**Testing is completed before equipment expiration date

7. ANTENNA PORT TEST RESULTS

7.1. MEASUREMENT METHODS

6 dB BW: KDB 558074 D01 v03r05, Section 8.1.

Output Power: KDB 558074 D01 v03r05, Section 9.1.2.

Power Spectral Density: KDB 558074 D01 v03r05, Section 10.2.

Out-of-band emissions in non-restricted bands: KDB 558074 D01 v03r05, Section 11.0.

Out-of-band emissions in restricted bands: KDB 558074 D01 v03r05, Section 12.1.

Band-edge: KDB 558074 D01 v03r05, Section 12.1.

7.2. ON TIME, DUTY CYCLE

LIMITS

None; for reporting purposes only.

PROCEDURE

KDB 558074 Zero-Span Spectrum Analyzer Method.

ON TIME AND DUTY CYCLE RESULTS

Mode	ON Time B (msec)	Period (msec)	Duty Cycle x (linear)	Duty Cycle (%)	Duty Cycle Correction Factor (dB)	1/B Minimum VBW (kHz)
BLE HIGH POWER	1.000	1.000	1.000	100.00%	0.00	0.010

DUTY CYCLE PLOTS

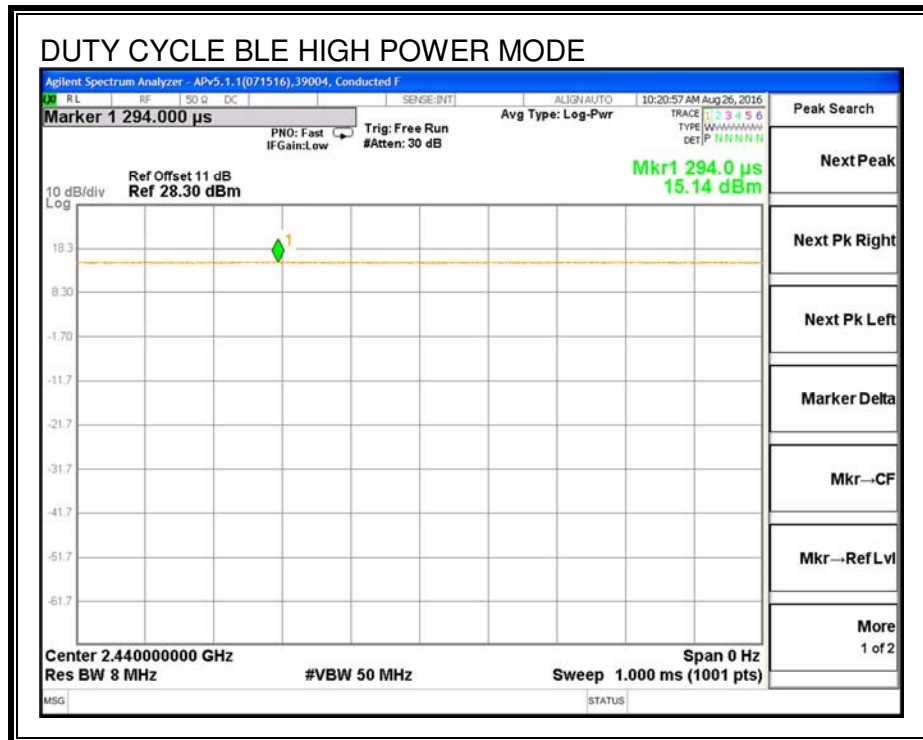

7.3. 6 dB BANDWIDTH

LIMITS

FCC §15.247 (a) (2)

IC RSS-247 (5.2) (1)

The minimum 6 dB bandwidth shall be at least 500 kHz.

RESULTS

Channel	Frequency (MHz)	6 dB Bandwidth (MHz)	Minimum Limit (MHz)
Low	2402	0.716	0.5
Middle	2440	0.718	0.5
High	2480	0.736	0.5

6 dB BANDWIDTH

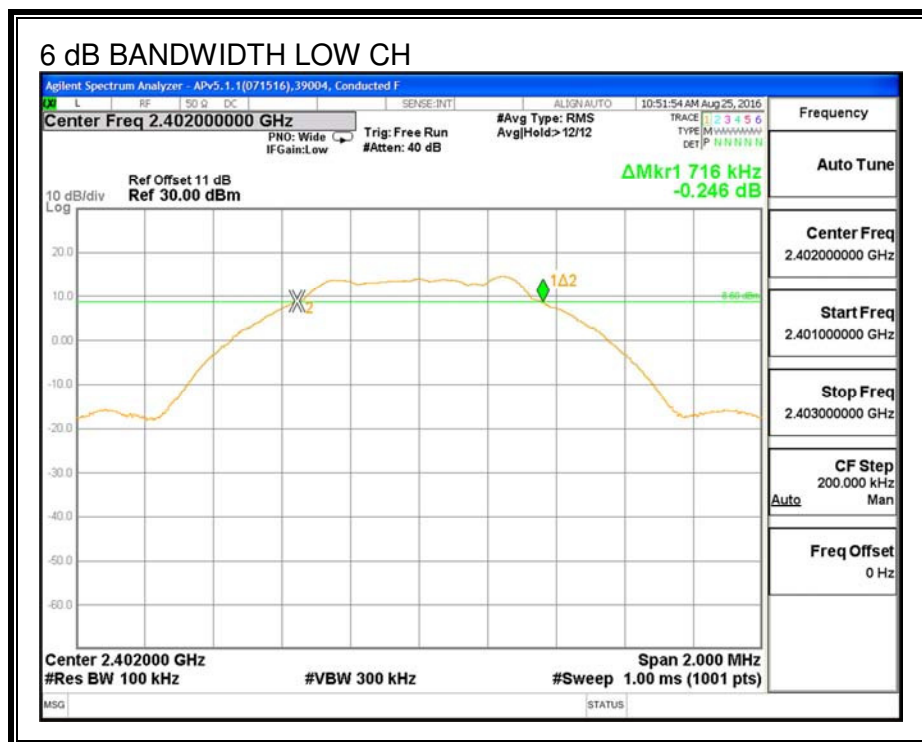

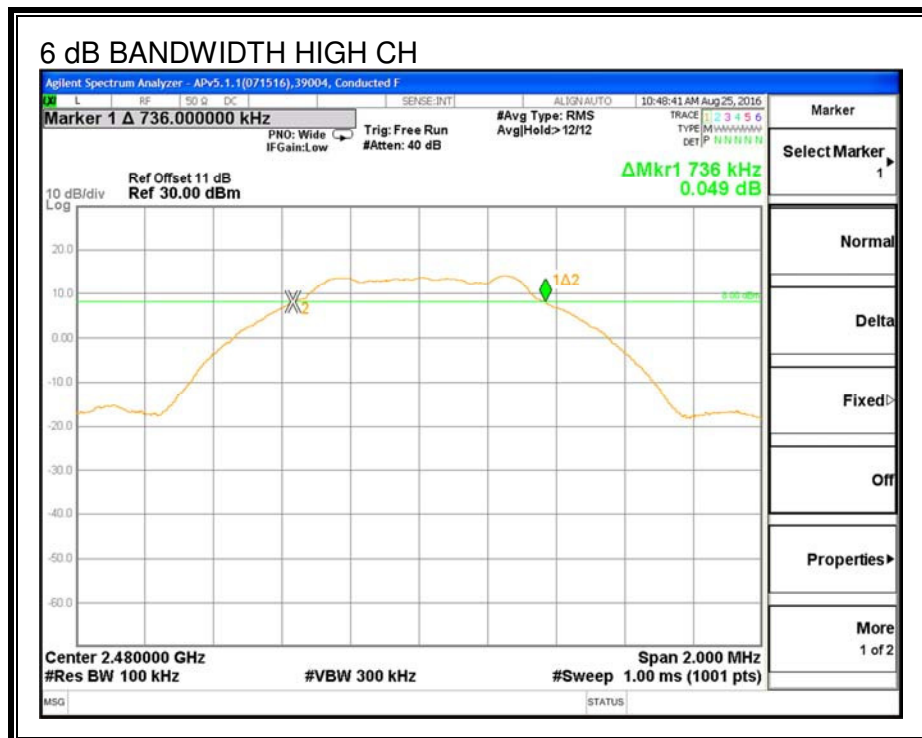
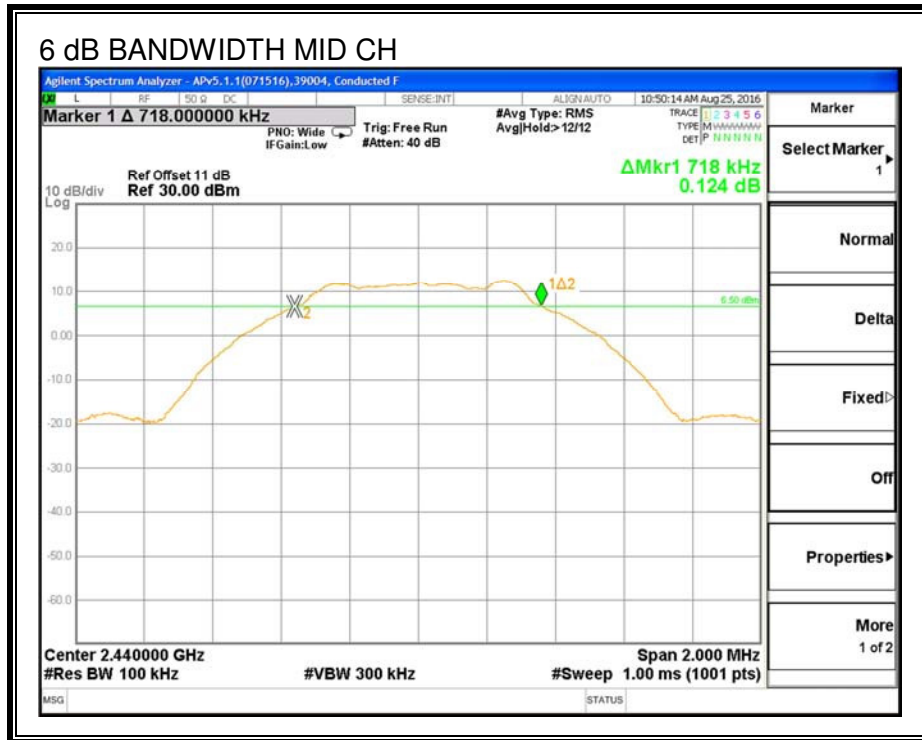

7.4. 99% BANDWIDTH

LIMITS

None; for reporting purposes only.

TEST PROCEDURE

The transmitter output is connected to the spectrum analyzer. The RBW is set to 1% to 3% of the 99 % bandwidth and to 1% of the span. The VBW is set to 3 times the RBW. The sweep time is coupled. The spectrum analyzer internal 99% bandwidth function is utilized.

RESULTS

Channel	Frequency (MHz)	99% Bandwidth (MHz)
Low	2402	1.0582
Middle	2440	1.0638
High	2480	1.0487

99% BANDWIDTH HIGH POWER

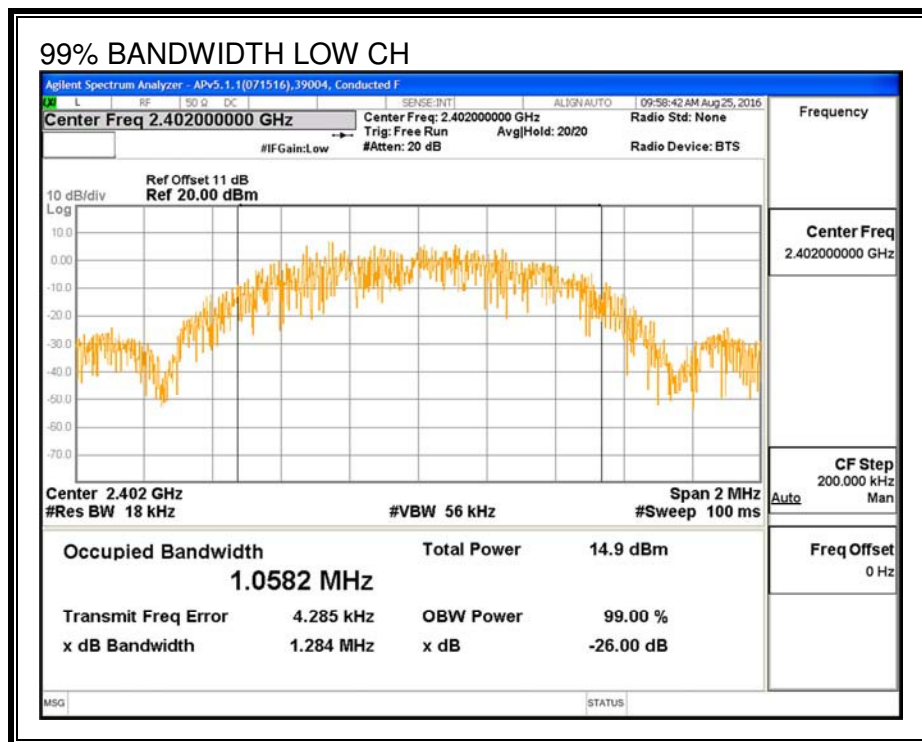

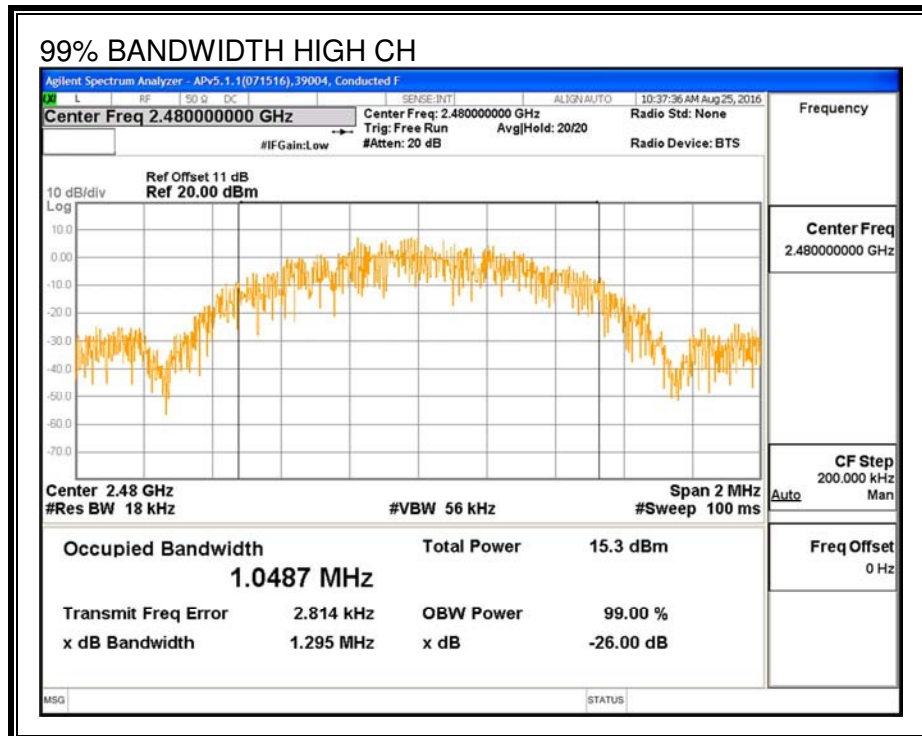
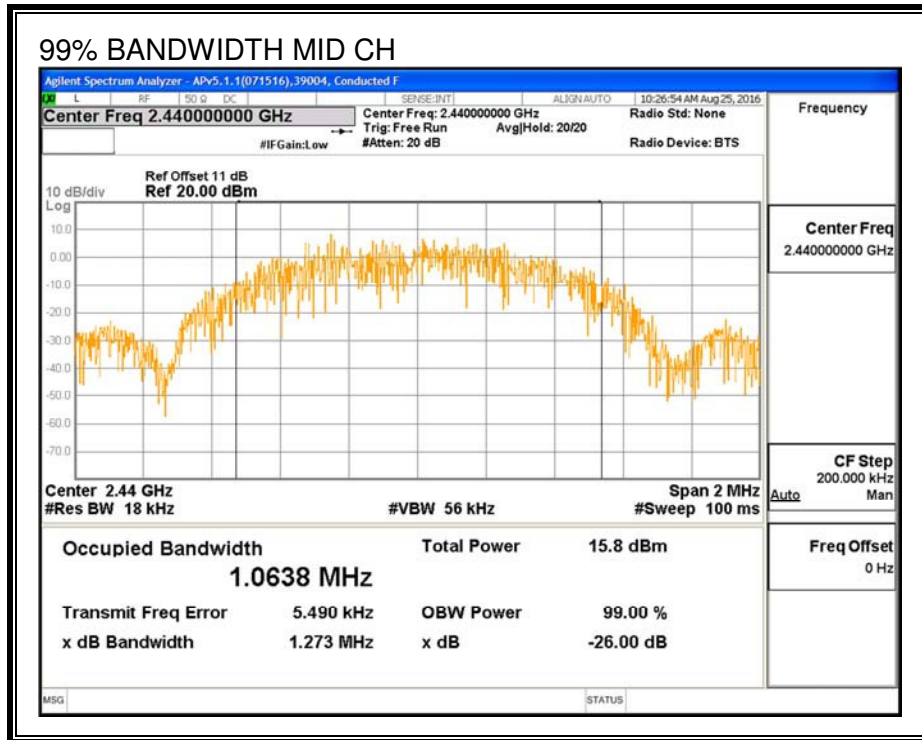

7.5. AVERAGE POWER

LIMITS

None; for reporting purposes only.

RESULTS

The cable assembly insertion loss of 11 dB (including 10 dB pad and 1 dB cable) was entered as an offset in the power meter to allow for direct reading of power.

ID:	39004	Date:	8/26/16
------------	-------	--------------	---------

Channel	Frequency (MHz)	AV power (dBm)
Low	2402	16.10
Middle	2440	16.18
High	2480	16.03

7.6. OUTPUT POWER

LIMITS

FCC §15.247 (b)

IC RSS-247 (5.4) (4)

The maximum antenna gain is less than or equal to 6 dBi, therefore the limit is 30 dBm.

RESULTS

ID:	39004	Date:	8/26/16
------------	-------	--------------	---------

Channel	Frequency (MHz)	Peak Power Reading (dBm)	Limit (dBm)	Margin (dB)
Low	2402	16.12	30	-13.880
Middle	2440	16.25	30	-13.750
High	2480	16.08	30	-13.920

7.7. POWER SPECTRAL DENSITY

LIMITS

FCC §15.247 (e)

IC RSS-247 (5.2) (2)

The power spectral density conducted from the transmitter to the antenna shall not be greater than 8 dBm in any 3 kHz band during any time interval of continuous transmission.

RESULTS

Channel	Frequency (MHz)	PSD (dBm)	Limit (dBm)	Margin (dB)
Low	2402	-1.17	8	-9.17
Middle	2440	-0.32	8	-8.32
High	2480	-1.85	8	-9.85

Note: Power spectral density to high power mode was originally tested with high power than recorded under average power data.

POWER SPECTRAL DENSITY HIGH POWER

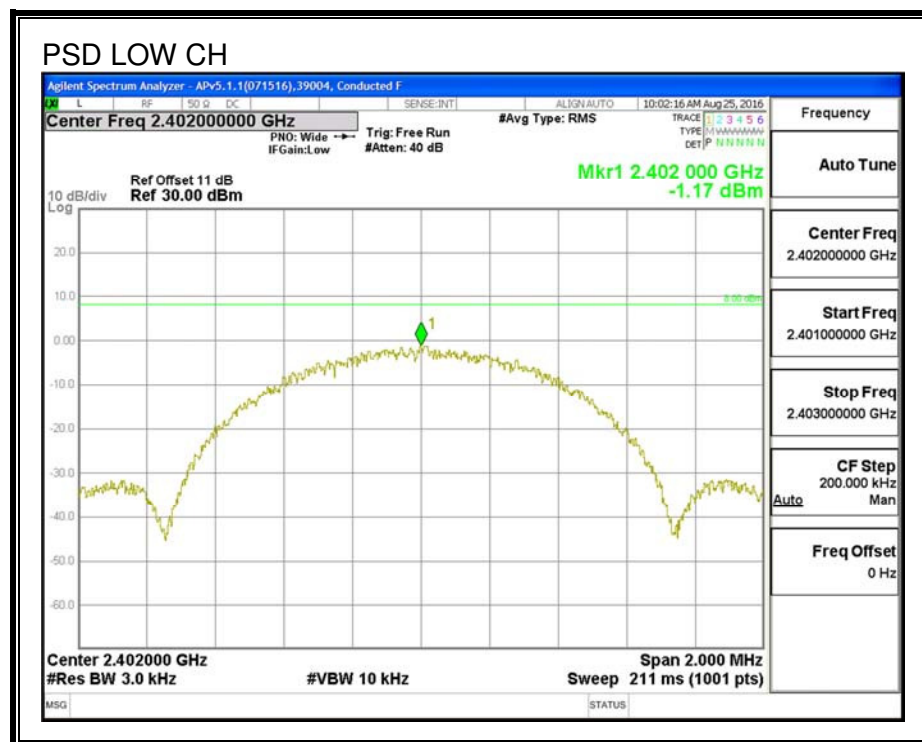

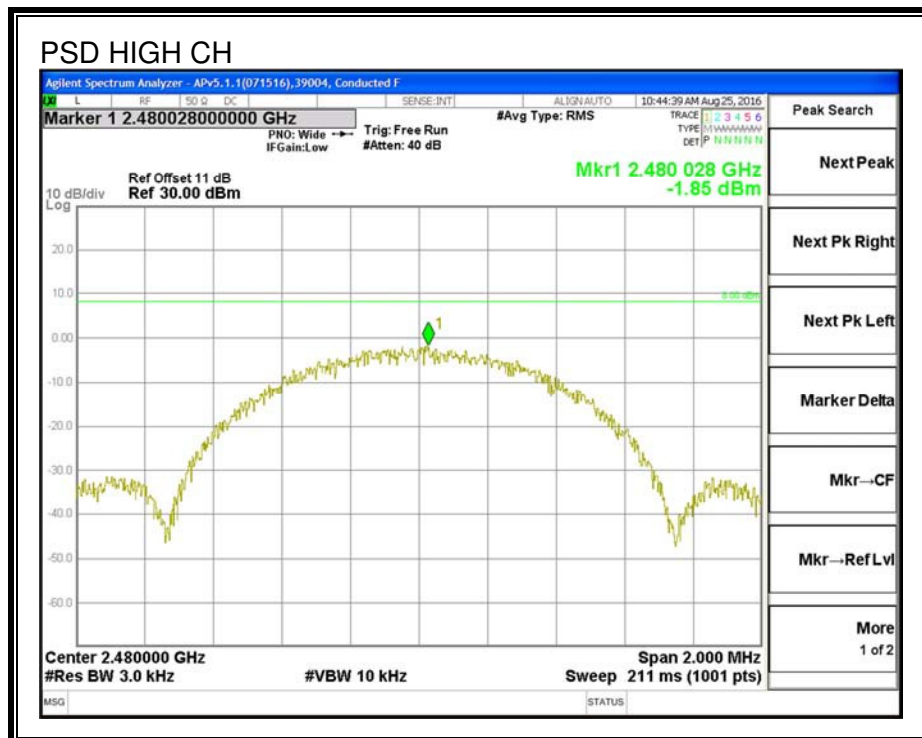
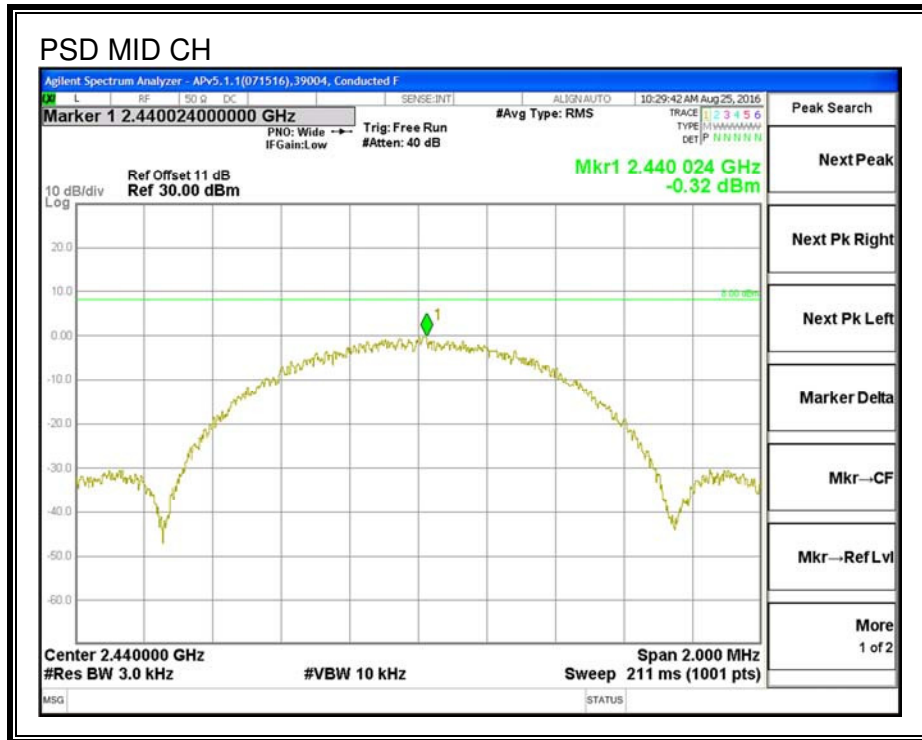

7.8. CONDUCTED SPURIOUS EMISSIONS

LIMITS

FCC §15.247 (d)

IC RSS-247 (5.5)

Output power was measured based on the use of a peak measurement, therefore the required attenuation is 20 dB.

RESULTS

Note: Conducted Spurious Emissions to high power mode was originally tested with high power than recorded under average power data.

SPURIOUS EMISSIONS

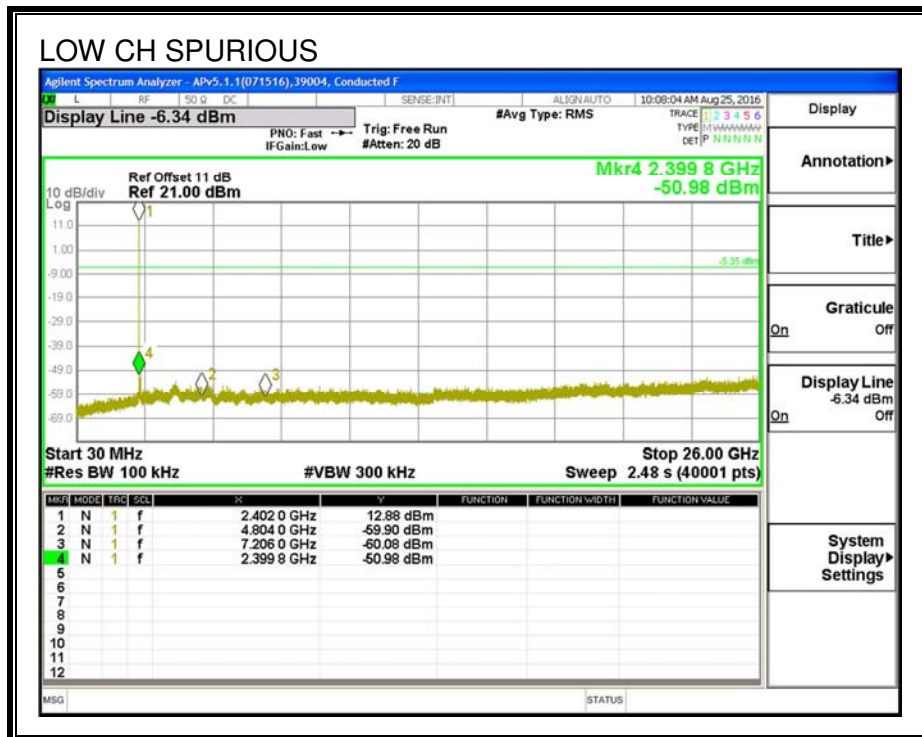
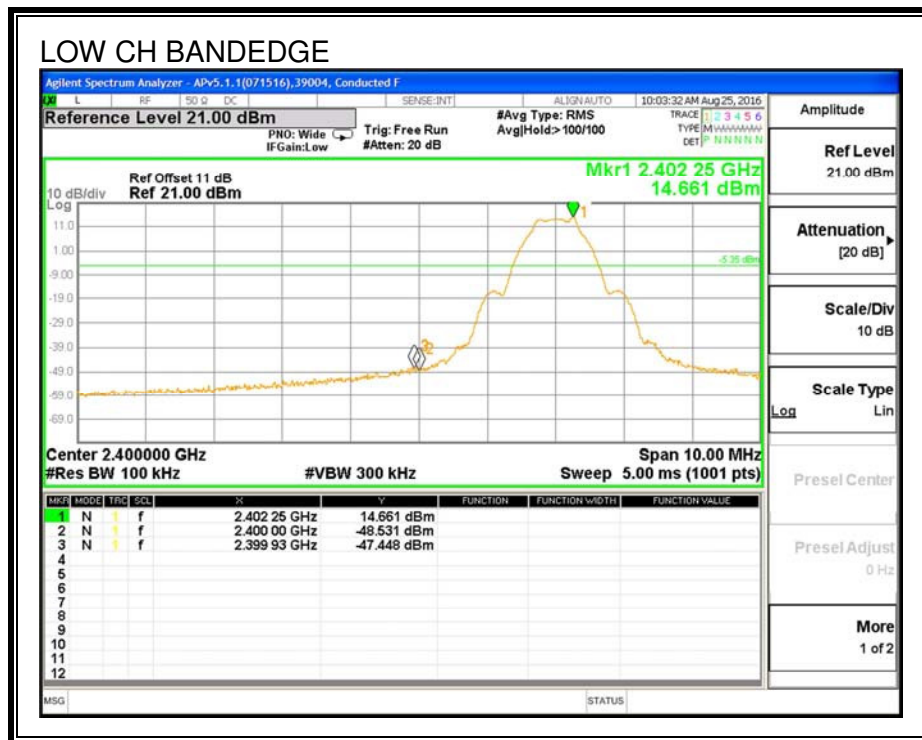

SPURIOUS EMISSIONS, MID CHANNEL

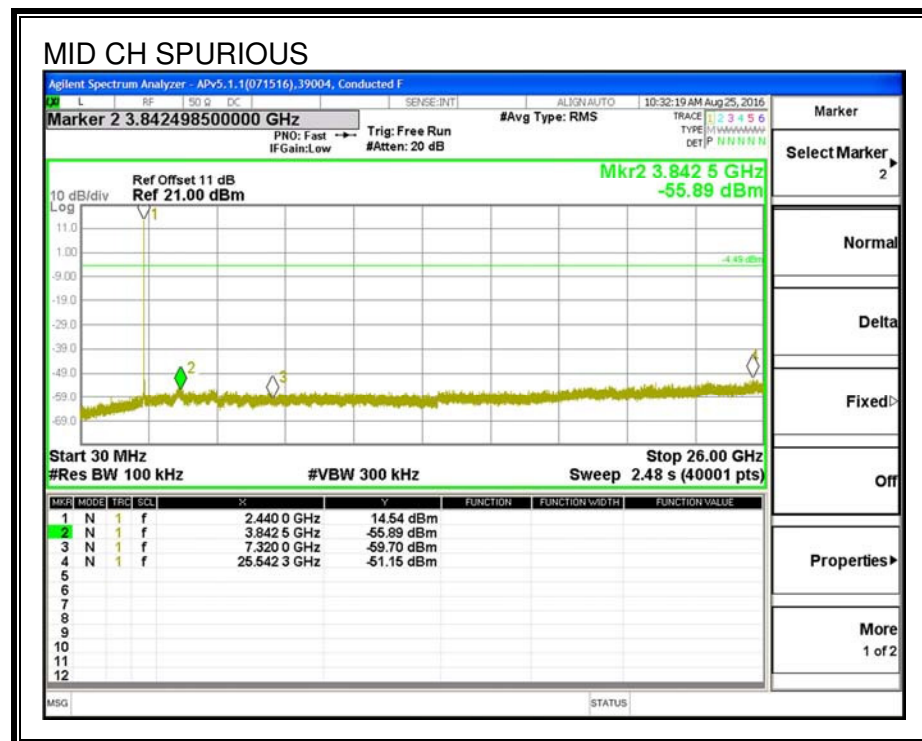
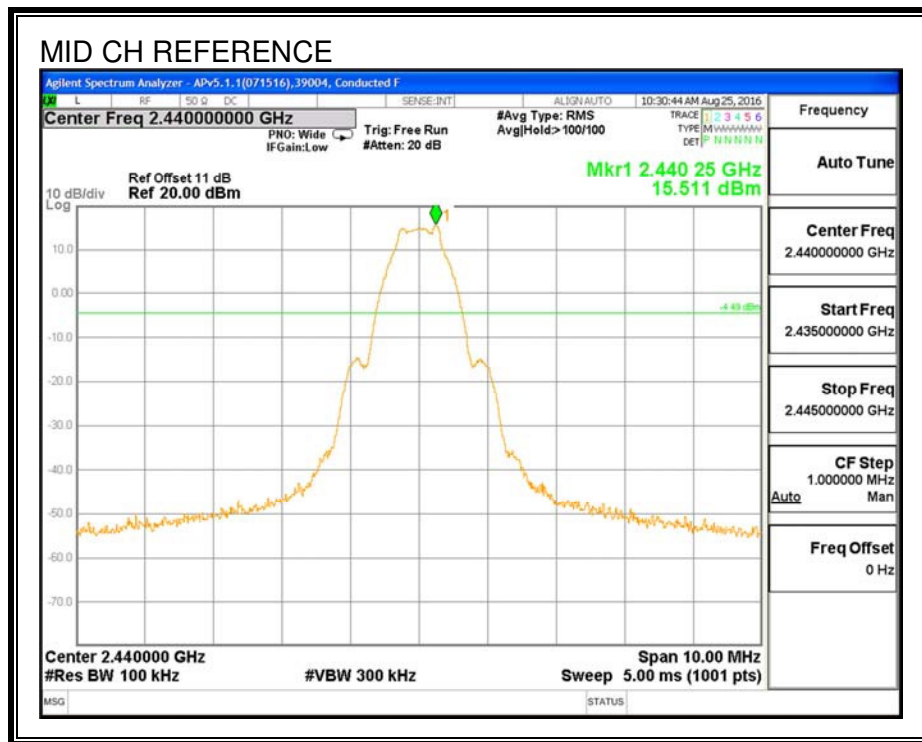

SPURIOUS EMISSIONS, HIGH CHANNEL

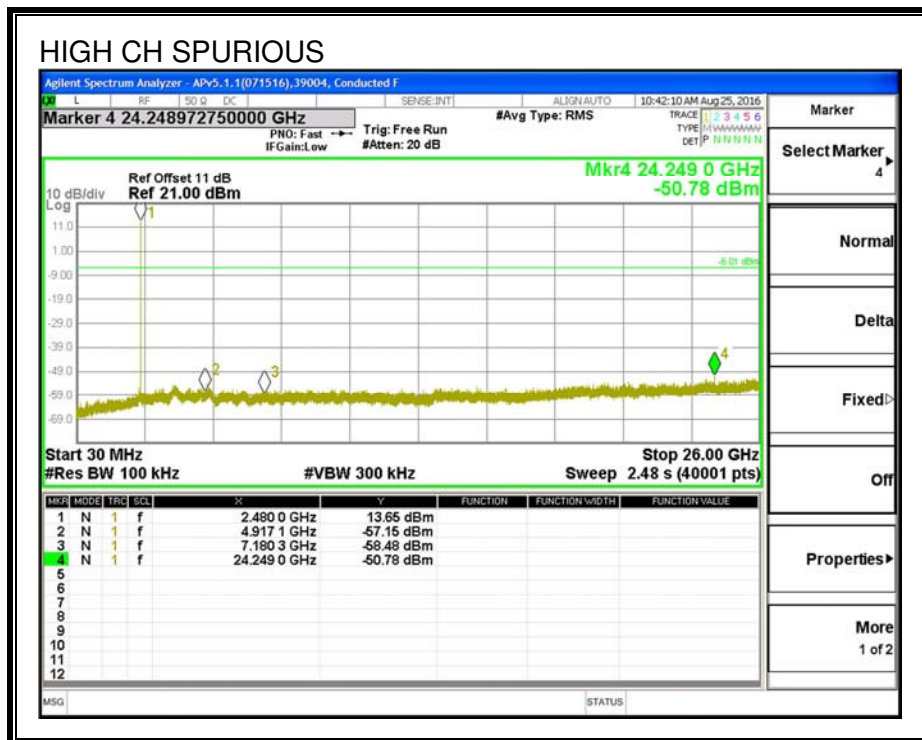
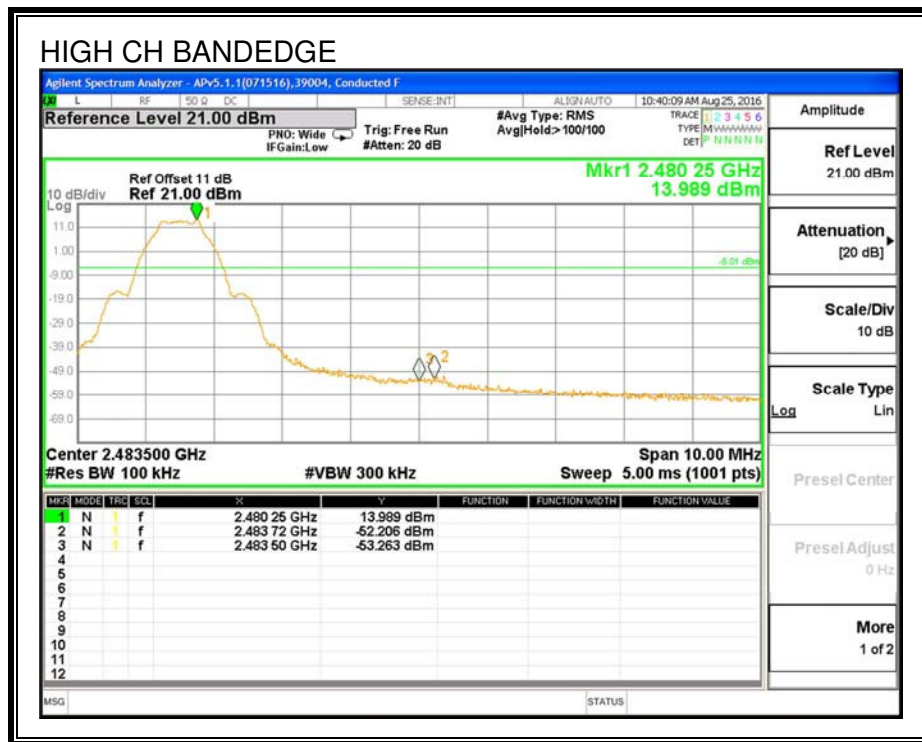

8. RADIATED TEST RESULTS

8.1. LIMITS AND PROCEDURE

LIMITS

FCC §15.205 and §15.209

IC RSS-GEN, Section 8.9 and 8.10.

Frequency Range (MHz)	Field Strength Limit (uV/m) at 3 m	Field Strength Limit (dBuV/m) at 3 m
30 - 88	100	40
88 - 216	150	43.5
216 - 960	200	46
Above 960	500	54

TEST PROCEDURE

The EUT is placed on a non-conducting table 80 cm above the ground plane for measurement below 1GHz; 1.5 m above the ground plane for measurement above 1GHz. The antenna to EUT distance is 3 meters. The EUT is configured in accordance with ANSI C63.10. The EUT is set to transmit in a continuous mode.

For measurements below 1 GHz the resolution bandwidth is set to 100 kHz for peak detection measurements or 120 kHz for quasi-peak detection measurements. Peak detection is used unless otherwise noted as quasi-peak.

For measurements above 1 GHz the resolution bandwidth is set to 1 MHz, the video bandwidth is set to 3 MHz for peak measurements and 1 MHz resolution bandwidth with 3MHz video bandwidth with average detector for average measurements.

For harmonics and Spurious Emission”, the setting is RBW/VBW = 1 MHz/30kHz for pre-test before the final testing

The spectrum from 30 MHz to 26 GHz is investigated with the transmitter set to the lowest, middle, and highest channels in the 2.4 GHz band.

The frequency range of interest is monitored at a fixed antenna height and EUT azimuth. The EUT is rotated through 360 degrees to maximize emissions received. The antenna is scanned from 1 to 4 meters above the ground plane to further maximize the emission. Measurements are made with the antenna polarized in both the vertical and the horizontal positions.

8.2. TRANSMITTER ABOVE 1 GHz

8.2.1. RESTRICTED BANDEGE

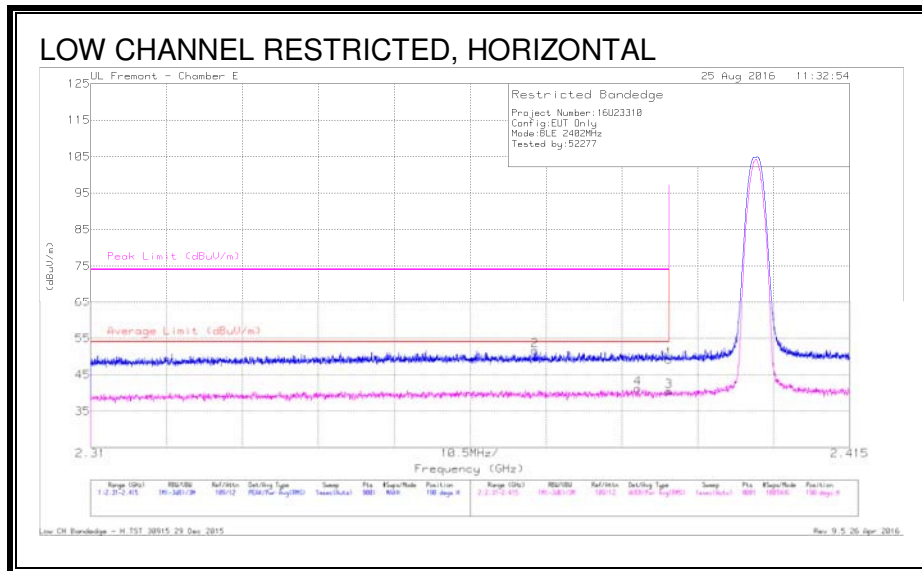

DATA

Marker	Frequency (GHz)	Meter Reading (dBuV)	Det	AFT711 (dB/m)	Amp/Cb/Ftr/Pa d (dB)	Corrected Reading (dBuV/m)	Average Limit (dBuV/m)	Margin (dB)	Peak Limit (dBuV/m)	PK Margin (dB)	Azimuth (Degs)	Height (cm)	Polarity
1	* 2.39	36.94	Pk	32.1	-19.9	49.14	-	-	74	-24.86	190	157	H
2	* 2.371	39.67	Pk	32	-20	51.67	-	-	74	-22.33	190	157	H
3	* 2.39	28.31	RMS	32.1	-19.9	40.51	54	-13.49	-	-	190	157	H
4	* 2.386	29.02	RMS	32.1	-19.9	41.22	54	-12.78	-	-	190	157	H

* - indicates frequency in CFR47 Pt 15 / IC RSS-Restricted Band

Pk - Peak detector

RMS - RMS detection

Low CH Bandedge - H.TST 30915 29 Dec 2015

Rev 9.5.26 Apr 2016

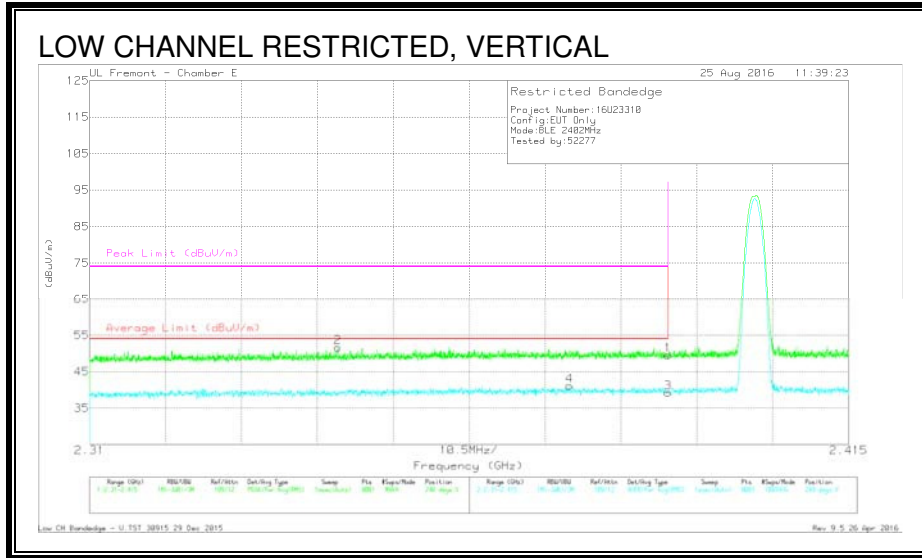

DATA

Trace Markers

Marker	Frequency (GHz)	Meter Reading (dBuV)	Det	AF T711 (dB/m)	Amp/Cbl/Fitr/Pa d (dB)	Corrected Reading (dBuV/m)	Average Limit (dBuV/m)	Margin (dB)	Peak Limit (dBuV/m)	PK Margin (dB)	Azimuth (Degs)	Height (cm)	Polarity
1	* 2.39	37.29	Pk	32.1	-19.9	49.49	-	-	74	-24.51	248	388	V
2	* 2.344	39.92	Pk	31.8	-20.1	51.62	-	-	74	-22.38	248	388	V
3	* 2.39	27.01	RMS	32.1	-19.9	39.21	54	-14.79	-	-	248	388	V
4	* 2.376	29.16	RMS	32	-20	41.16	54	-12.84	-	-	248	388	V

* - indicates frequency in CFR47 Pt 15 / IC RSS-Restricted Band

Pk - Peak detector

RMS - RMS detection

Low CH Bandedge - V.TST 30915 29 Dec 2015

Rev 9.5 26 Apr 2016

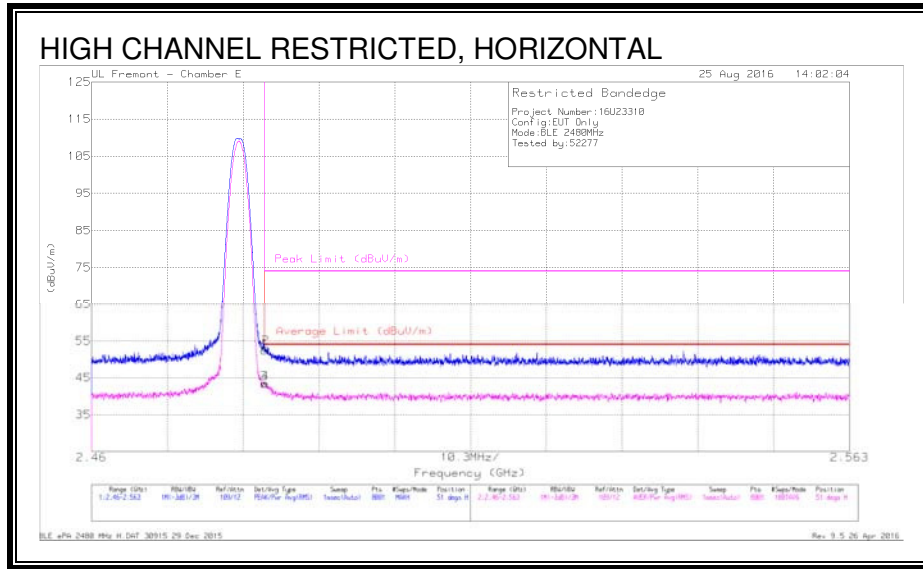

DATA

Trace Markers

Marker	Frequency (GHz)	Meter Reading (dBuV)	Det	AF T711 (dB/m)	Amp/Cb1/Filtr/Pad (dB)	Corrected Reading (dBuV/m)	Average Limit (dBuV/m)	Margin (dB)	Peak Limit (dBuV/m)	PK Margin (dB)	Azimuth (Degs)	Height (cm)	Polarity
1	* 2.484	40.1	Pk	32.3	-20	52.4	-	-	74	-21.6	51	130	H
2	* 2.484	40.81	Pk	32.3	-20	53.11	-	-	74	-20.89	51	130	H
3	* 2.484	31.15	RMS	32.3	-20	43.45	54	-10.55	-	-	51	130	H
4	* 2.484	31.12	RMS	32.3	-20	43.42	54	-10.58	-	-	51	130	H

* - indicates frequency in CFR47 Pt 15 / IC RSS-Restricted Band

Pk - Peak detector

RMS - RMS detection

High CH Bandedge - H.TST 30915 29 Dec 2015

Rev 9.5 26 Apr 2016

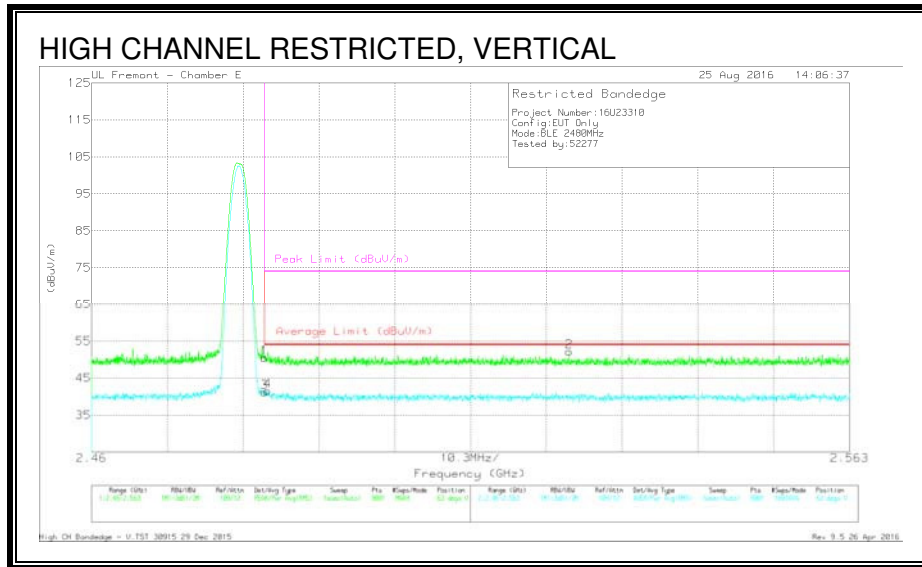

DATA

Trace Markers

Marker	Frequency (GHz)	Meter Reading (dBuV)	Det	AF T711 (dB/m)	Amp/Cb/Filtr/Pad (dB)	Corrected Reading (dBuV/m)	Average Limit (dBuV/m)	Margin (dB)	Peak Limit (dBuV/m)	PK Margin (dB)	Azimuth (Degs)	Height (cm)	Polarity
1	* 2.484	38.18	Pk	32.3	-20	50.48	-	-	74	-23.52	63	358	V
3	* 2.484	28.89	RMS	32.3	-20	41.19	54	-12.81	-	-	63	358	V
4	* 2.484	29.24	RMS	32.3	-20	41.54	54	-12.46	-	-	63	358	V
2	2.525	39.95	Pk	32.4	-20.2	52.15	-	-	74	-21.85	63	358	V

* - indicates frequency in CFR47 Pt 15 / IC RSS-Restricted Band

Pk - Peak detector

RMS - RMS detection

High CH Bandedge - V.TST 30915 29 Dec 2015

Rev 9.5 26 Apr 2016

8.2.2. HARMONICS AND SPURIOUS EMISSIONS

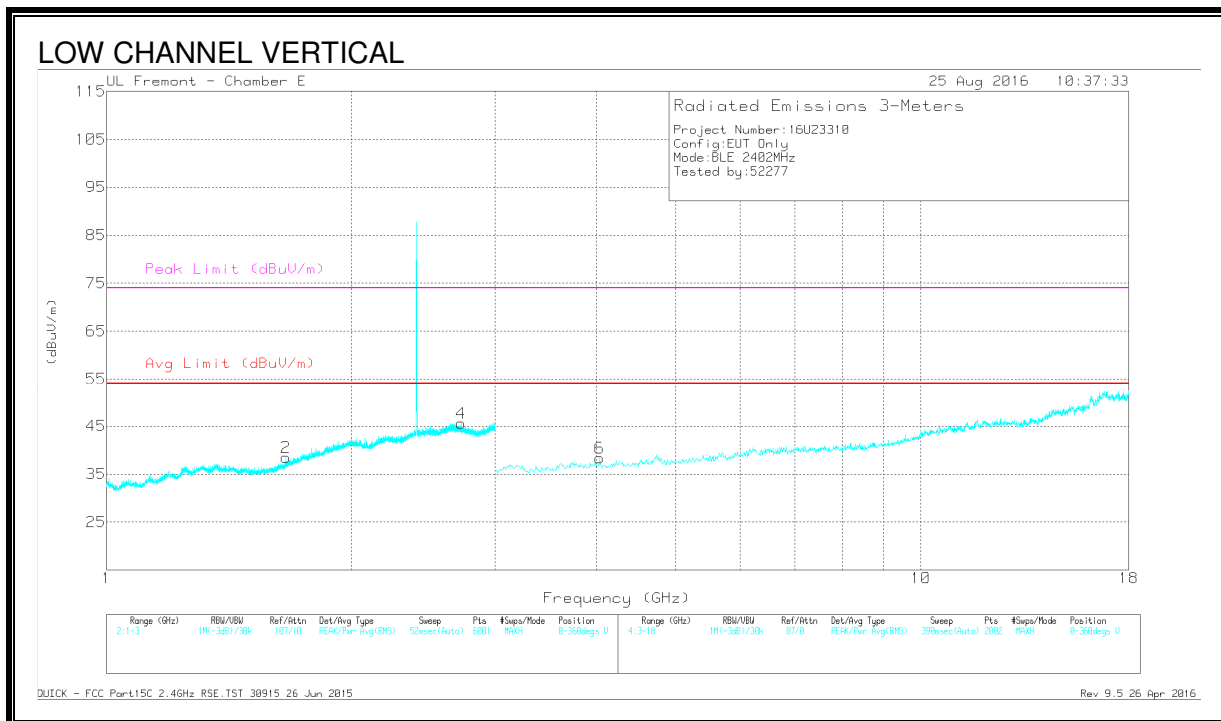
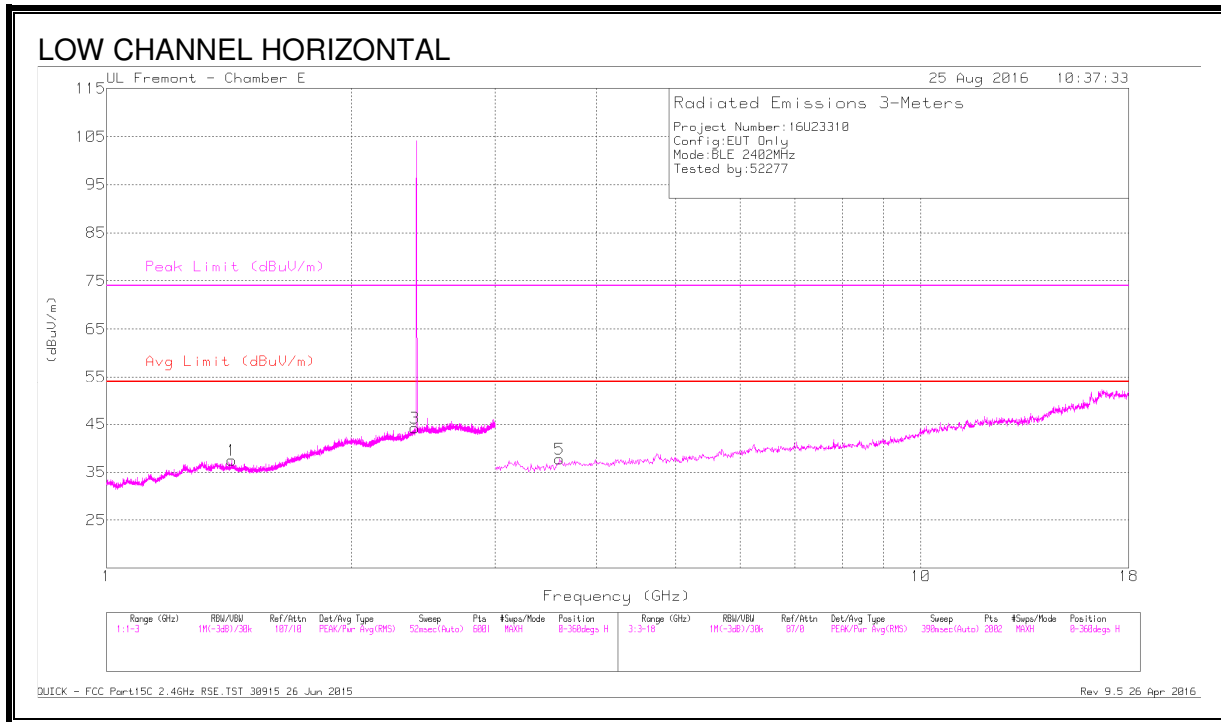

DATA

Radiated Emissions

Frequency (GHz)	Meter Reading (dBuV)	Det	AF T711 (dB/m)	Amp/Cb/Filtr/P ad (dB)	Corrected Reading (dBuV/m)	Avg Limit (dBuV/m)	Margin (dB)	Peak Limit (dBuV/m)	PK Margin (dB)	Azimuth (Degs)	Height (cm)	Polarity
* 1.422	35.93	PK2	28.8	-22	42.73	-	-	74	-31.27	360	101	H
* 1.425	25.75	MAv1	28.7	-21.9	32.55	54	-21.45	-	-	360	101	H
* 2.723	37.51	PK2	32.5	-19.7	50.31	-	-	74	-23.69	360	101	V
* 2.724	27.15	MAv1	32.5	-19.8	39.85	54	-14.15	-	-	360	101	V
* 3.6	41.29	PK2	33	-30.7	43.59	-	-	74	-30.41	360	101	H
* 3.6	30.26	MAv1	33	-30.7	32.56	54	-21.44	-	-	360	101	H
* 4.034	40.65	PK2	33.2	-30.5	43.35	-	-	74	-30.65	360	101	V
* 4.035	29.86	MAv1	33.2	-30.5	32.56	54	-21.44	-	-	360	101	V
1.66	36.48	PK2	28.6	-21.3	43.78	-	-	-	-	360	101	V
1.66	25.55	MAv1	28.6	-21.3	32.85	-	-	-	-	360	101	V
2.39	27.08	MAv1	32.1	-19.9	39.28	-	-	-	-	360	101	H
2.391	38.41	PK2	32.1	-19.9	50.61	-	-	-	-	360	101	H

* - indicates frequency in CFR47 Pt 15 / IC RSS-Restricted Band

PK2 - KDB558074 Method: Maximum Peak

MAv1 - KDB558074 Option 1 Maximum RMS Average

QUICK - FCC Part15C 2.4GHz RSE.TST 30915 26 Jun 2015

Rev 9.5 26 Apr 2016

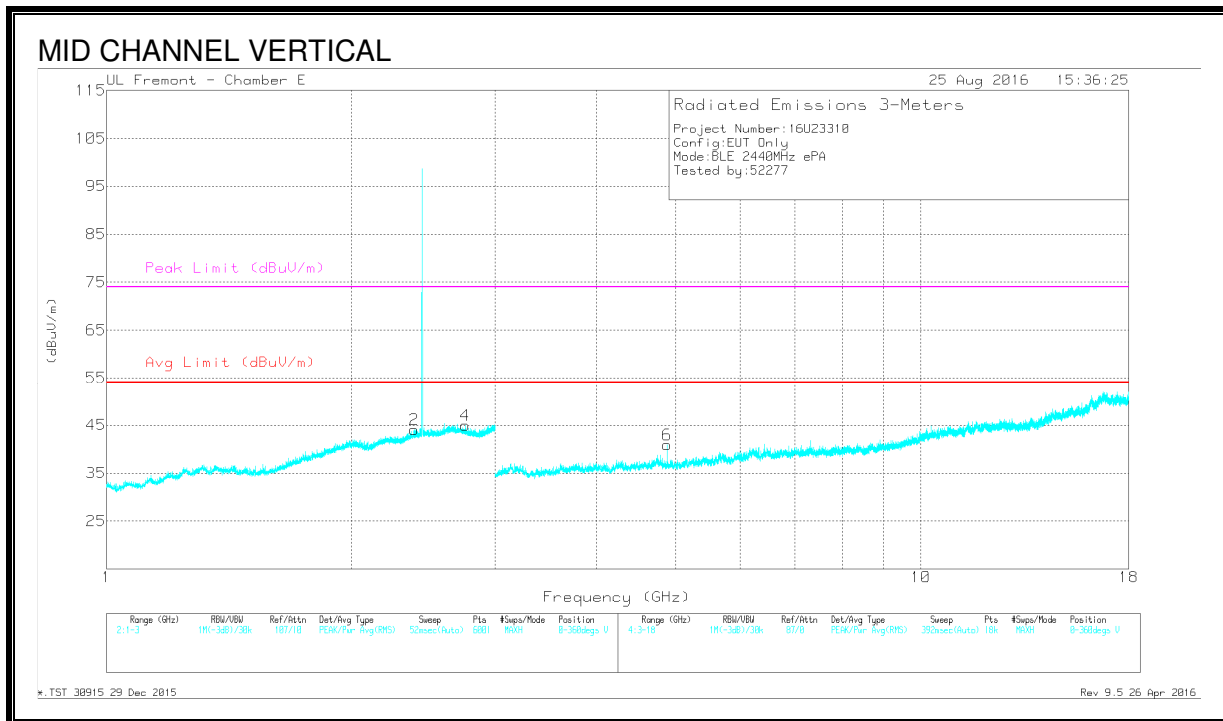
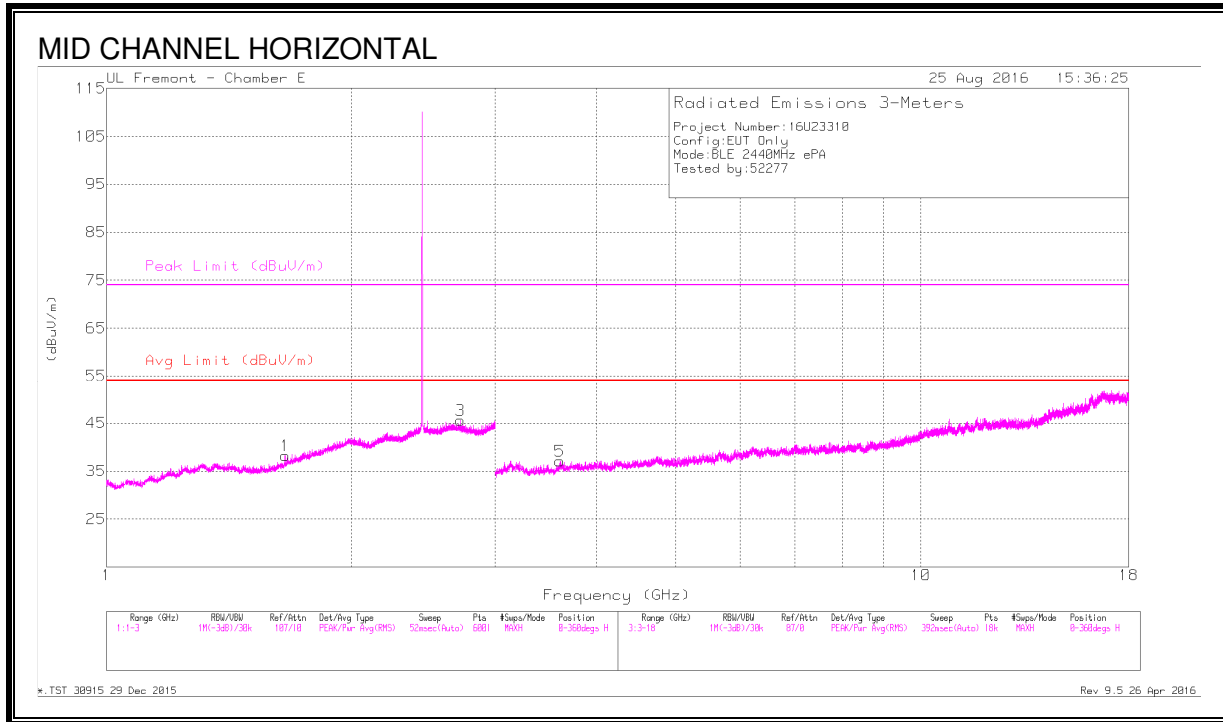

DATA

Radiated Emissions

Markers	Frequency (GHz)	Meter Reading (dBuV)	Det	AF T711 (dB/m)	Amp/Cb/Filtr/P ad (dB)	Corrected Reading (dBuV/m)	Avg Limit (dBuV/m)	Margin (dB)	Peak Limit (dBuV/m)	PK Margin (dB)	Azimuth (Degs)	Height (cm)	Polarity
3	* 2.719	37.91	PK2	32.6	-19.7	50.81	-	-	74	-23.19	101	141	H
	* 2.717	26.6	MAv1	32.6	-19.7	39.5	54	-14.5	-	-	101	141	H
2	* 2.389	38.49	PK2	32.1	-19.9	50.69	-	-	74	-23.31	114	252	V
	* 2.389	26.33	MAv1	32.1	-19.9	38.53	54	-15.47	-	-	114	252	V
4	* 2.756	37.91	PK2	32.5	-19.9	50.51	-	-	74	-23.49	350	249	V
	* 2.759	26.58	MAv1	32.5	-20	39.08	54	-14.92	-	-	350	249	V
5	* 3.604	41.25	PK2	33	-30.6	43.65	-	-	74	-30.35	281	392	H
	* 3.603	29.49	MAv1	33	-30.7	31.79	54	-22.21	-	-	281	392	H
6	* 4.881	43.71	PK2	34	-30.4	47.31	-	-	74	-26.69	360	299	V
	* 4.88	37.07	MAv1	34	-30.4	40.67	54	-13.33	-	-	360	299	V
1	1.656	36.9	PK2	28.6	-21.3	44.2	-	-	-	-	59	248	H
	1.658	25.01	MAv1	28.6	-21.3	32.31	-	-	-	-	59	248	H

* - indicates frequency in CFR47 Pt 15 / IC RSS-Restricted Band

PK2 - KDB558074 Method: Maximum Peak

MAv1 - KDB558074 Option 1 Maximum RMS Average

*.TST 30915 29 Dec 2015

Rev 9.5 26 Apr 2016

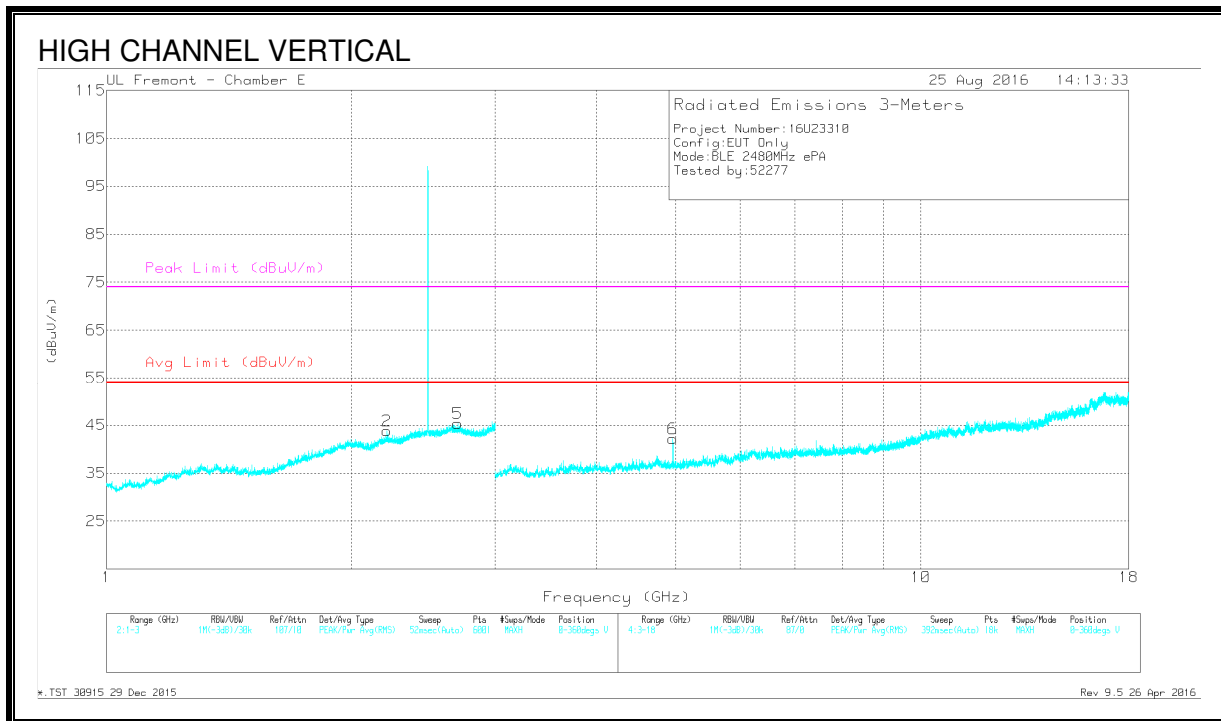
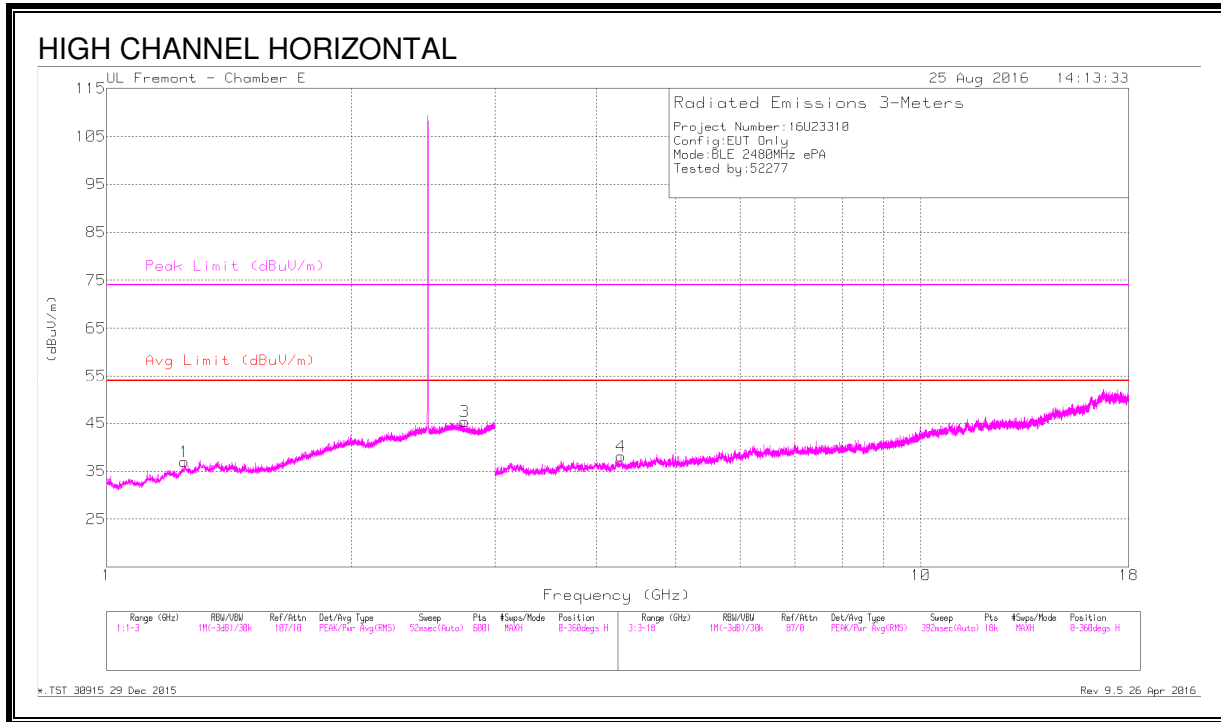

DATA

Radiated Emissions

Markers	Frequency (GHz)	Meter Reading (dBuV)	Det	AF T711 (dB/m)	Amp/Cb/Filtr/P ad (dB)	Corrected Reading (dBuV/m)	Avg Limit (dBuV/m)	Margin (dB)	Peak Limit (dBuV/m)	PK Margin (dB)	Azimuth (Degs)	Height (cm)	Polarity
1	* 1.248	36.26	PK2	28.9	-22.5	42.66	-	-	74	-31.34	287	107	H
	* 1.25	25.09	MAv1	28.9	-22.6	31.39	54	-22.61	-	-	287	107	H
3	* 2.755	37.86	PK2	32.5	-19.9	50.46	-	-	74	-23.54	158	192	H
	* 2.752	26.5	MAv1	32.5	-19.9	39.1	54	-14.9	-	-	158	192	H
2	* 2.211	36.76	PK2	31.8	-20	48.56	-	-	74	-25.44	360	398	V
	* 2.212	25.84	MAv1	31.8	-20	37.64	54	-16.36	-	-	360	398	V
5	* 2.699	38.65	PK2	32.6	-19.7	51.55	-	-	74	-22.45	91	354	V
	* 2.697	26.52	MAv1	32.6	-19.7	39.42	54	-14.58	-	-	91	354	V
4	* 4.282	39.25	PK2	33.3	-29.4	43.15	-	-	74	-30.85	5	358	H
	* 4.281	29.09	MAv1	33.3	-29.4	32.99	54	-21.01	-	-	5	358	H
6	* 4.961	45.19	PK2	34	-30.5	48.69	-	-	74	-25.31	88	267	V
	* 4.96	38.1	MAv1	34	-30.5	41.6	54	-12.4	-	-	88	267	V

* - indicates frequency in CFR47 Pt 15 / IC RSS-Restricted Band

PK2 - KDB558074 Method: Maximum Peak

MAv1 - KDB558074 Option 1 Maximum RMS Average

*.TST 30915 29 Dec 2015

Rev 9.5 26 Apr 2016

8.3. WORST-CASE BELOW 1 GHz

SPURIOUS EMISSIONS 30 TO 1000 MHz (WORST-CASE CONFIGURATION)

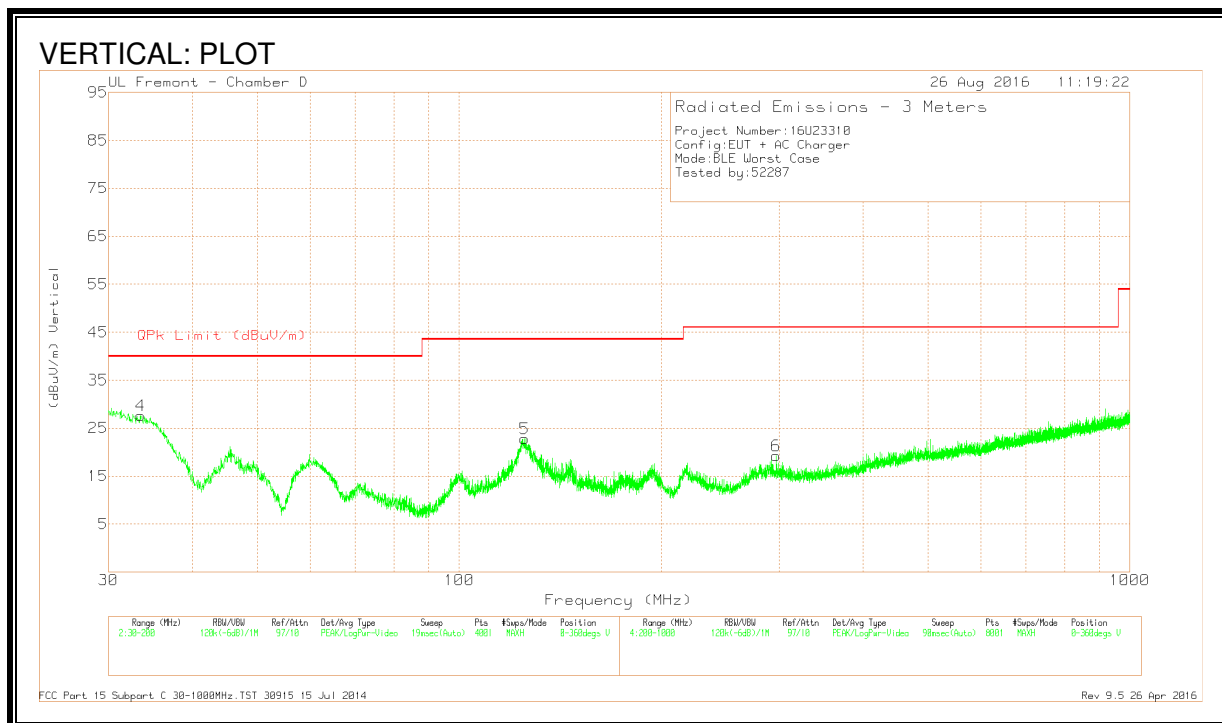
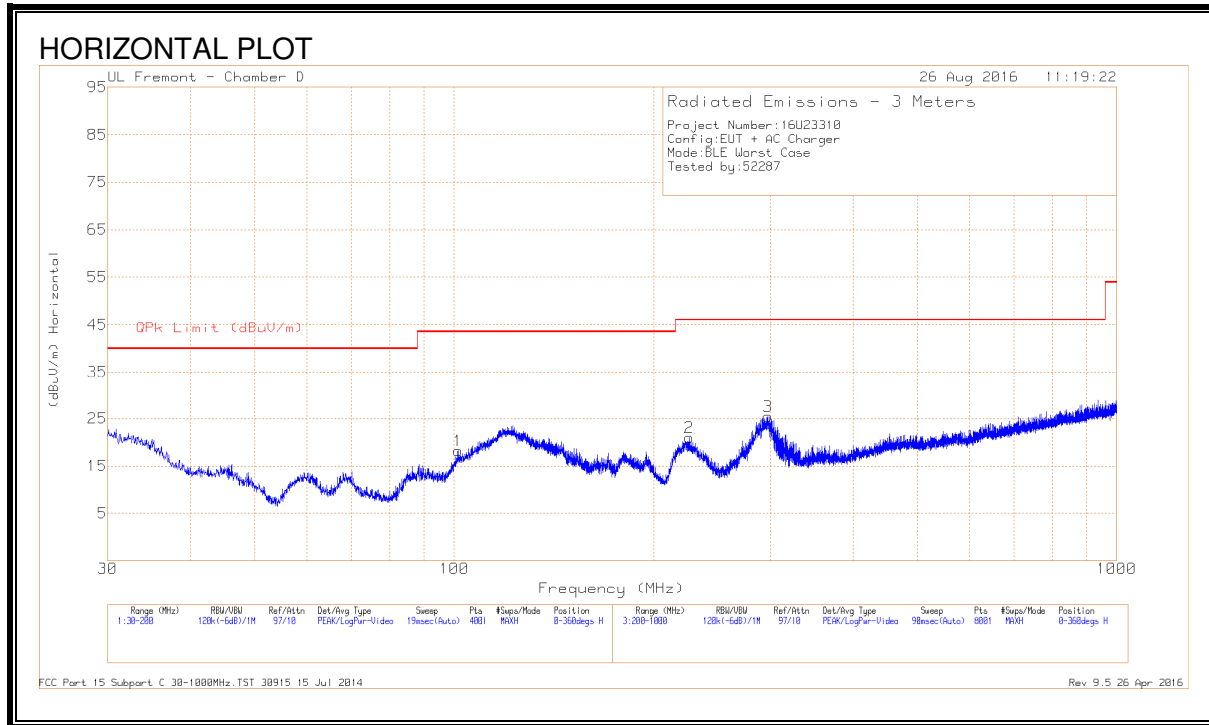

DATA

Trace Markers

Marker	Frequency (MHz)	Meter Reading (dBuV)	Det	AF T408 (dB/m)	Amp/Cbl (dB)	Corrected Reading (dBuV/m)	QPk Limit (dBuV/m)	Margin (dB)	Azimuth (Degs)	Height (cm)	Polarity
5	* 125.2425	36.25	Pk	17.8	-31.2	22.85	43.52	-20.67	0-360	100	V
4	33.5275	36.71	Pk	22.7	-31.8	27.61	40	-12.39	0-360	100	V
1	101.315	35.17	Pk	14.4	-31.3	18.27	43.52	-25.25	0-360	299	H
2	226.5	36.96	Pk	14.8	-30.7	21.06	46.02	-24.96	0-360	100	H
6	296.9	32.51	Pk	17.2	-30.4	19.31	46.02	-26.71	0-360	301	V
3	297.3	38.64	Pk	17.2	-30.4	25.44	46.02	-20.58	0-360	100	H

* - indicates frequency in CFR47 Pt 15 / IC RSS-Restricted Band

Pk - Peak detector

FCC Part 15 Subpart C 30-1000MHz.TST 30915 15 Jul 2014

Rev 9.5 26 Apr 2016

8.4. WORST-CASE 18 to 26 GHz

SPURIOUS EMISSIONS 18 to 26 GHz

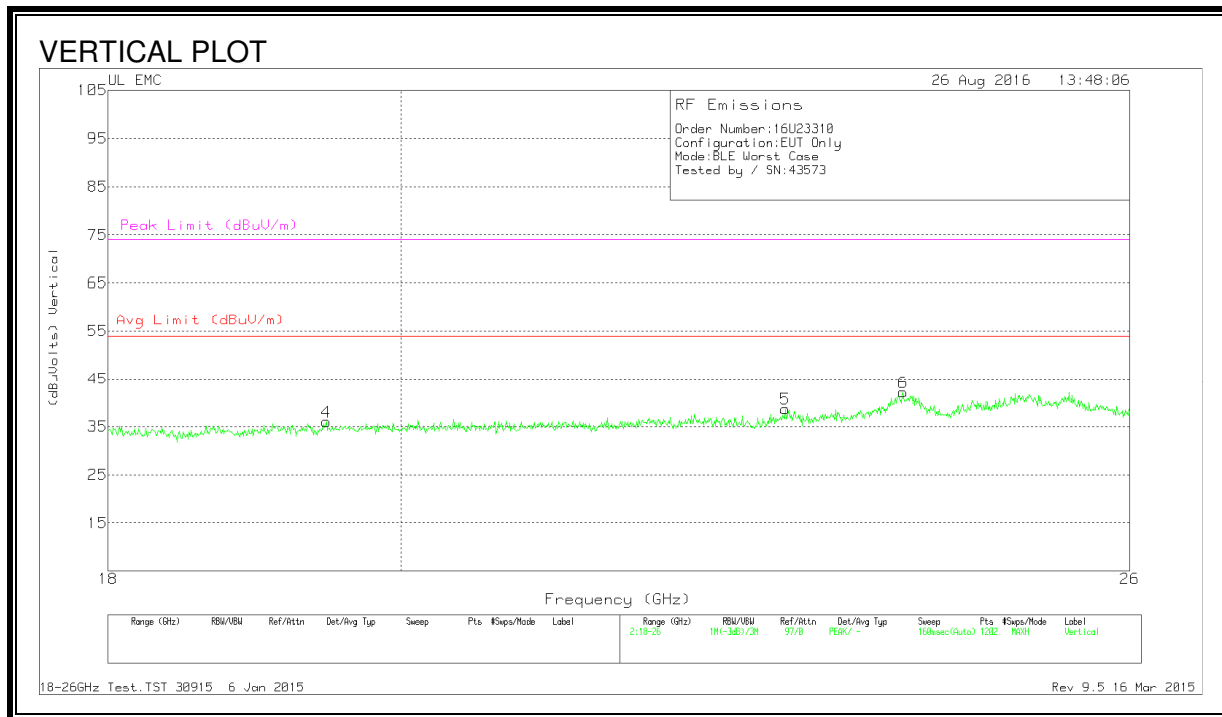
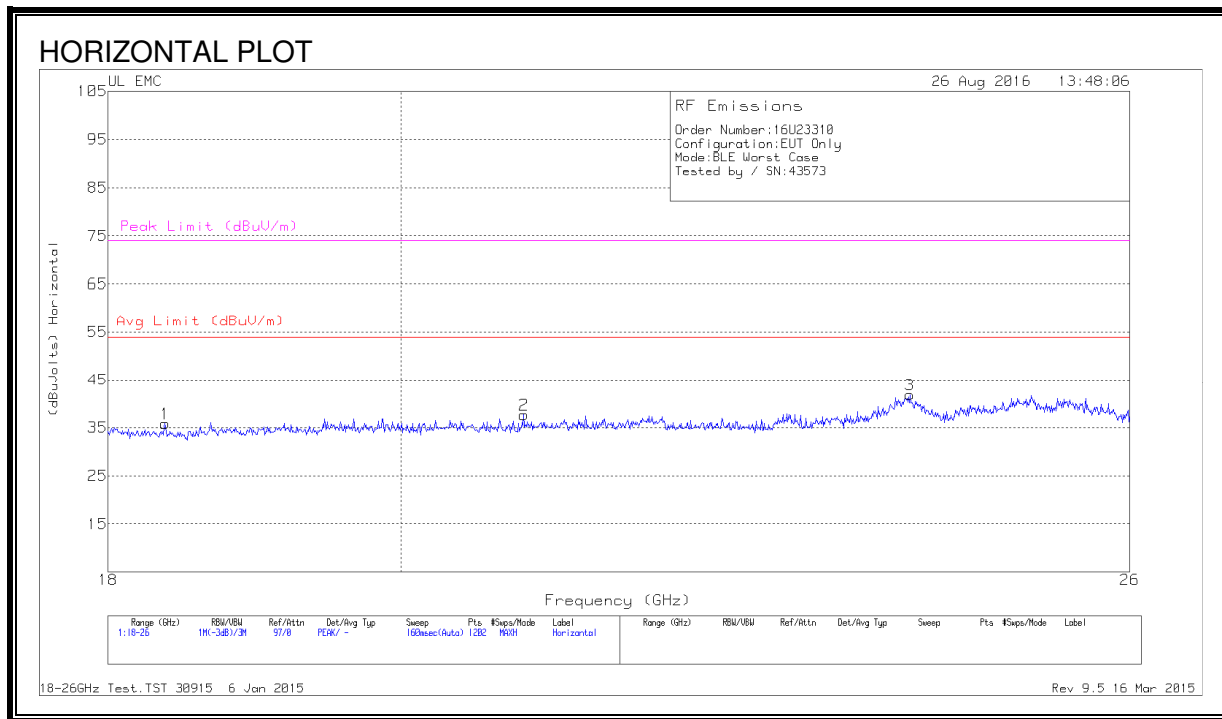

DATA

Marker	Frequency (GHz)	Meter Reading (dBuV)	Det	AF T449 (dB/m)	Amp/Cbl (dB)	Dist Corr (dB)	Corrected Reading (dBuVolts)	Avg Limit (dBuV/m)	Margin (dB)	Peak Limit (dBuV/m)	PK Margin (dB)
1	18.373	38.03	Pk	32.4	-25.1	-9.5	35.83	54	-18.17	74	-38.167
2	20.904	39.27	Pk	33.1	-25.2	-9.5	37.67	54	-16.33	74	-36.33
3	24.022	41.53	Pk	34	-24.2	-9.5	41.83	54	-12.17	74	-32.167
4	19.472	37.6	Pk	32.7	-24.8	-9.5	36	54	-18	74	-38
5	22.969	39.97	Pk	33.4	-25.2	-9.5	38.67	54	-15.33	74	-35.33
6	23.962	41.87	Pk	34	-24.2	-9.5	42.167	54	-11.83	74	-31.83

Pk - Peak detector

9. AC POWER LINE CONDUCTED EMISSIONS

LIMITS

FCC §15.207 (a)

RSS-Gen 8.8

Frequency of Emission (MHz)	Conducted Limit (dB μ V)	
	Quasi-peak	Average
0.15-0.5	66 to 56 *	56 to 46 *
0.5-5	56	46
5-30	60	50

*Decreases with the logarithm of the frequency.

TEST PROCEDURE

The EUT is placed on a non-conducting table 40 cm from the vertical ground plane and 80 cm above the horizontal ground plane. The EUT is configured in accordance with ANSI C63.10-2013

The receiver is set to a resolution bandwidth of 9 kHz. Peak detection is used unless otherwise noted as quasi-peak or average.

Line conducted data is recorded for both NEUTRAL and HOT lines.

RESULTS

9.1. EUT POWERED BY AC/DC ADAPTER VIA USB CABLE

LINE 1 RESULTS

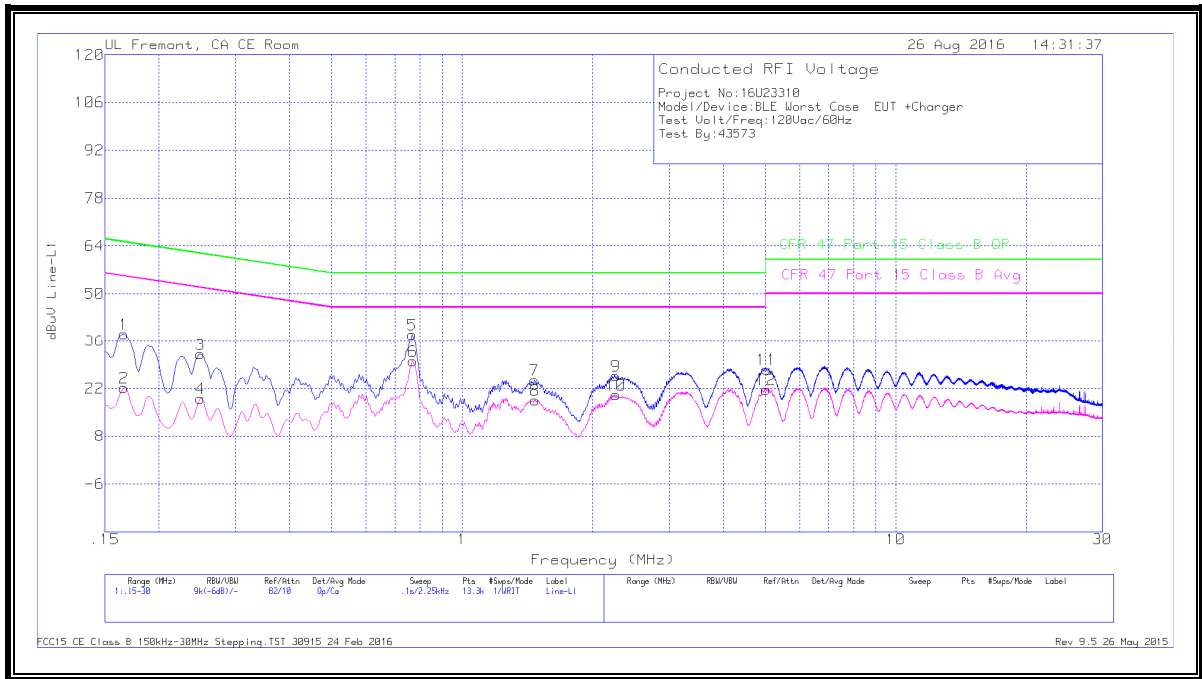

LINE 2 RESULTS

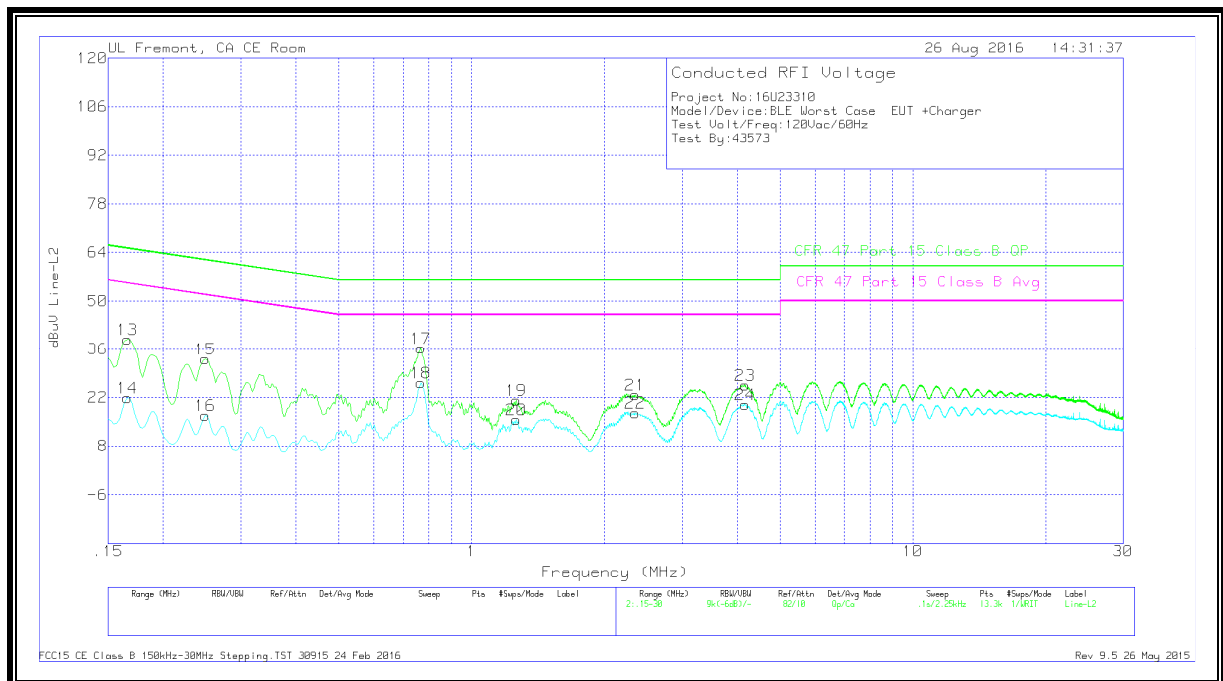

WORST EMISSIONS

Range 1: Line-L1 .15 - 30MHz

Marker	Frequency (MHz)	Meter Reading (dBuV)	Det	LISN L1	LC Cables 1&3	Limiters (dB)	Corrected Reading dBuV	CFR 47 Part 15 Class B QP	QP Margin (dB)	CFR 47 Part 15 Class B Avg	Av(CISPR) Margin (dB)
1	.16575	28.01	Qp	0	0	10.1	38.11	65.17	-27.06	-	-
2	.16575	12.09	Ca	0	0	10.1	22.19	-	-	55.17	-32.98
3	.249	22.05	Qp	0	0	10.1	32.15	61.79	-29.64	-	-
4	.249	9.02	Ca	0	0	10.1	19.12	-	-	51.79	-32.67
5	.7665	27.84	Qp	0	0	10.1	37.94	56	-18.06	-	-
6	.76875	19.96	Ca	0	0	10.1	30.06	-	-	46	-15.94
7	1.47075	14.2	Qp	0	.1	10.1	24.4	56	-31.6	-	-
8	1.473	8.4	Ca	0	.1	10.1	18.6	-	-	46	-27.4
9	2.26275	15.43	Qp	0	.1	10.1	25.63	56	-30.37	-	-
10	2.26275	9.95	Ca	0	.1	10.1	20.15	-	-	46	-25.85
11	5.03475	17.41	Qp	0	.1	10.1	27.61	60	-32.39	-	-
12	5.02575	11.39	Ca	0	.1	10.1	21.59	-	-	50	-28.41

Qp - Quasi-Peak detector

Ca - CISPR average detection

Range 2: Line-L2 .15 - 30MHz

Marker	Frequency (MHz)	Meter Reading (dBuV)	Det	LISN L2	LC Cables 2&3	Limiters (dB)	Corrected Reading dBuV	CFR 47 Part 15 Class B QP	QP Margin (dB)	CFR 47 Part 15 Class B Avg	Av(CISPR) Margin (dB)
13	.16575	28.77	Qp	0	0	10.1	38.87	65.17	-26.3	-	-
14	.16575	11.69	Ca	0	0	10.1	21.79	-	-	55.17	-33.38
15	.249	22.99	Qp	0	0	10.1	33.09	61.79	-28.7	-	-
16	.249	6.65	Ca	0	0	10.1	16.75	-	-	51.79	-35.04
17	.7665	26.2	Qp	0	0	10.1	36.3	56	-19.7	-	-
18	.7665	16.06	Ca	0	0	10.1	26.16	-	-	46	-19.84
19	1.2615	10.89	Qp	0	.1	10.1	21.09	56	-34.91	-	-
20	1.2615	5.34	Ca	0	.1	10.1	15.54	-	-	46	-30.46
21	2.346	12.45	Qp	0	.1	10.1	22.65	56	-33.35	-	-
22	2.346	7.38	Ca	0	.1	10.1	17.58	-	-	46	-28.42
23	4.17075	15.27	Qp	0	.1	10.1	25.47	56	-30.53	-	-
24	4.17075	9.71	Ca	0	.1	10.1	19.91	-	-	46	-26.09

Qp - Quasi-Peak detector

Ca - CISPR average detection

9.2. EUT POWERED BY HOST PC VIA USB CABLE

LINE 1 RESULTS

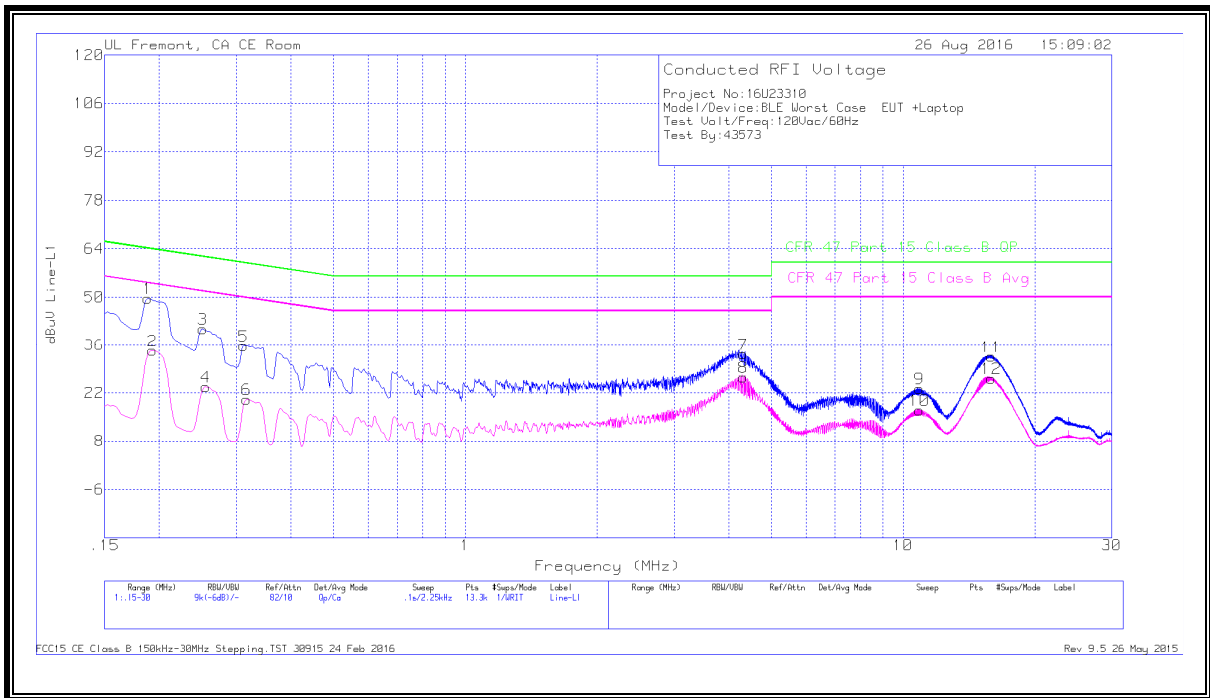

LINE 2 RESULTS

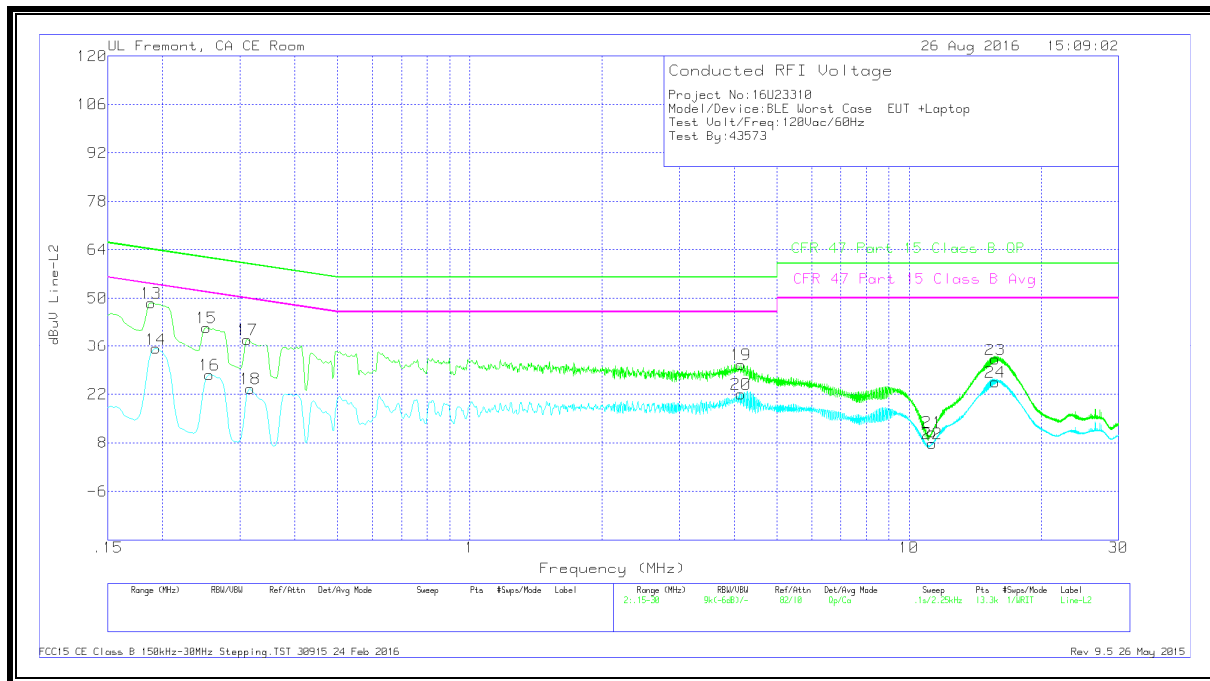

WORST EMISSIONS

Range 1: Line-L1 .15 - 30MHz

Marker	Frequency (MHz)	Meter Reading (dBuV)	Det	LISN L1	LC Cables 1&3	Limiters (dB)	Corrected Reading dBuV	CFR 47 Part 15 Class B QP	QP Margin (dB)	CFR 47 Part 15 Class B Avg	Av(CISPR) Margin (dB)
1	.18825	39.5	Qp	0	0	10.1	49.6	64.11	-14.51	-	-
2	.19275	24.33	Ca	0	0	10.1	34.43	-	-	53.92	-19.49
3	.25125	30.62	Qp	0	0	10.1	40.72	61.72	-21	-	-
4	.25575	13.65	Ca	0	0	10.1	23.75	-	-	51.57	-27.82
5	.312	25.7	Qp	0	0	10.1	35.8	59.92	-24.12	-	-
6	.3165	9.97	Ca	0	0	10.1	20.07	-	-	49.8	-29.73
7	4.31475	23.06	Qp	0	.1	10.1	33.26	56	-22.74	-	-
8	4.31475	16.28	Ca	0	.1	10.1	26.48	-	-	46	-19.52
9	10.914	12.83	Qp	0	.2	10.2	23.23	60	-36.77	-	-
10	10.914	6.64	Ca	0	.2	10.2	17.04	-	-	50	-32.96
11	15.90225	22.18	Qp	0	.2	10.2	32.58	60	-27.42	-	-
12	15.90225	15.84	Ca	0	.2	10.2	26.24	-	-	50	-23.76

Qp - Quasi-Peak detector

Ca - CISPR average detection

Range 2: Line-L2 .15 - 30MHz

Marker	Frequency (MHz)	Meter Reading (dBuV)	Det	LISN L2	LC Cables 2&3	Limiters (dB)	Corrected Reading dBuV	CFR 47 Part 15 Class B QP	QP Margin (dB)	CFR 47 Part 15 Class B Avg	Av(CISPR) Margin (dB)
13	.18825	38.5	Qp	0	0	10.1	48.6	64.11	-15.51	-	-
14	.19275	25.11	Ca	0	0	10.1	35.21	-	-	53.92	-18.71
15	.25125	31.37	Qp	0	0	10.1	41.47	61.72	-20.25	-	-
16	.25575	17.51	Ca	0	0	10.1	27.61	-	-	51.57	-23.96
17	.312	27.95	Qp	0	0	10.1	38.05	59.92	-21.87	-	-
18	.3165	13.41	Ca	0	0	10.1	23.51	-	-	49.8	-26.29
19	4.146	20.26	Qp	0	.1	10.1	30.46	56	-25.54	-	-
20	4.14825	11.85	Ca	0	.1	10.1	22.05	-	-	46	-23.95
21	11.29875	.61	Qp	0	.2	10.2	11.01	60	-48.99	-	-
22	11.29875	-2.64	Ca	0	.2	10.2	7.76	-	-	50	-42.24
23	15.702	21.63	Qp	0	.2	10.2	32.03	60	-27.97	-	-
24	15.702	15.05	Ca	0	.2	10.2	25.45	-	-	50	-24.55

Qp - Quasi-Peak detector

Ca - CISPR average detection