

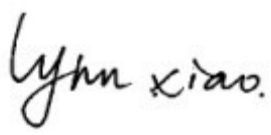



TEST REPORT

| | | | |
|--|---|---|------------|
| Report No.: | EM201300277-5 | Application No.: | ZJ00029362 |
| Client: | Harman International Industries, Incorporated | | |
| Address: | 8500 Balboa Blvd, Northridge, CA 91329, UNITED STATES | | |
| Sample Description: | Blu-RAY DISC SYSTEM | | |
| Model: | BDS 580 | | |
| Adding Model: | / | | |
| FCC ID | APIBDS580 | | |
| Test Specification: | FCC Part 15,Subpart C:2013 | | |
| Test Date: | 2013-05-15 to 2013-06-04 | | |
| Issue Date: | 2013-06-04 | | |
| Test Result: | Pass. | | |
| Prepared By: | Reviewed By: | Approved By: | |
| Lynn Xiao / Test Engineer | Jane Cao / Test Engineer | Gavin Wu / Manager | |
|  |  |  | |
| Date:2013-06-04 | Date:2013-06-04 | Date:2013-06-04 | |
| Other Aspects: | | | |
| / | | | |
| Abbreviations: ok / P = passed; fail / F = failed; n.a. / N = not applicable | | | |
| The test result in this test report refers exclusively to the presented test sample. This report shall not be reproduced except in full, without the written approval of GRGT. | | | |

DIRECTIONS OF TEST

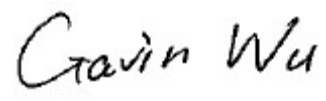
1. This station carries out test task according to the national regulation of verifications which can be traced to National Primary Standards and BIPM.
2. The test report merely corresponds to the test sample. It is not permitted to copy extracts of these test result without the written permission of the test laboratory.
3. If there is any objection concerning the test, the client should inform the laboratory within 15 days from the date of receiving the test report.

Table of Contents

- 1. TEST RESULT SUMMARY 5**
- 2. GENERAL DESCRIPTION OF EUT..... 6**
 - 2.1 APPLICANT 6
 - 2.2 MANUFACTURER 6
 - 2.3 BASIC DESCRIPTION OF EQUIPMENT UNDER TEST 6
- 3. LABORATORY AND ACCREDITATIONS..... 7**
 - 3.1 LABORATORY 7
 - 3.2 ACCREDITATIONS 7
 - 3.3 MEASUREMENT UNCERTAINTY 7
 - 3.4 LIST OF USED TEST EQUIPMENT AT GRGT 8
- 4. TEST RESULTS 9**
 - 4.1 E.U.T. TEST CONDITIONS 9
 - 4.2 ANTENNA REQUIREMENT 11
 - 4.3 OCCUPIED BANDWIDTH 12
 - 4.3.1 LIMITS..... 12
 - 4.3.2 TEST PROCEDURES..... 12
 - 4.3.3 TEST SETUP 12
 - 4.3.4 TEST RESULTS..... 12
 - 4.4 CARRIER FREQUENCIES SEPARATED 16
 - 4.4.1 LIMITS..... 16
 - 4.4.2 TEST PROCEDURES..... 16
 - 4.4.3 TEST SETUP 16
 - 4.4.4 TEST RESULTS..... 16
 - 4.5 HOPPING CHANNEL NUMBER 20
 - 4.5.1 LIMITS..... 20
 - 4.5.2 TEST PROCEDURES..... 20
 - 4.5.3 TEST SETUP 20
 - 4.5.4 TEST RESULTS..... 20
 - 4.6 DWELL TIME..... 22
 - 4.6.1 LIMITS..... 22
 - 4.6.2 TEST PROCEDURES..... 22
 - 4.6.3 TEST SETUP 22
 - 4.6.4 TEST RESULTS..... 22
 - 4.7 CONDUCTED EMISSION MEASUREMENT 39
 - 4.7.1 LIMITS..... 39
 - 4.7.2 TEST PROCEDURES..... 39
 - 4.7.3 TEST SETUP 40
 - 4.7.4 TEST RESULTS..... 41
 - 4.8 MAXIMUM PEAK OUTPUT POWER 43
 - 4.8.1 LIMITS..... 43
 - 4.8.2 TEST PROCEDURES..... 43
 - 4.8.3 TEST SETUP 43
 - 4.8.4 TEST RESULTS..... 43
- FUNDAMENTAL FREQUENCY (GHZ) 43**
 - 4.9 CONDUCTED SPURIOUS EMISSIONS..... 47
 - 4.9.1 LIMITS..... 47
 - 4.9.2 TEST PROCEDURES..... 47
 - 4.9.3 TEST SETUP 47
 - 4.9.4 TEST RESULTS..... 47
 - 4.10 RADIATED SPURIOUS EMISSIONS 57
 - 4.10.1 LIMITS..... 57
 - 4.10.2 TEST PROCEDURES..... 57
 - 4.10.3 TEST SETUP 58
 - 4.10.4 TEST RESULTS..... 60
 - 4.11 BAND EDGES REQUIREMENT 64

4.11.1 LIMITS..... 64
4.11.2 TEST PROCEDURES..... 64
4.11.3 TEST SETUP 64
4.11.4 TEST RESULTS..... 64
4.11.5 Radiated Emissions which fall in the restricted bands..... 67

1. TEST RESULT SUMMARY

| Section B of FCC Part 15.247:2013 | | | |
|--|--|----------------------------|---------------|
| Standard | Item | Limit / Severity | Result |
| FCC Part 15,Subpart C (15.247) | Antenna Requirement | Section 15.247 (c) | PASS |
| | Occupied Bandwidth | Section 15.247 (a1) | PASS |
| | Carrier Frequencies Separated | Section 15.247(a)(1) | PASS |
| | Hopping Channel Number | Section 15.247(a)(1)(iii) | PASS |
| | Dwell Time | Section 15.247(a)(1)(iii) | PASS |
| | Maximum Peak Output Power | Section 15.247(b)(1) | PASS |
| | Conducted Emission | Section 15.207 | PASS |
| | Conducted Spurious Emission (30MHz to 25GHz) | Section 15.209 &15.247(d) | PASS |
| | Radiated Spurious Emission (30MHz to 25GHz) | Section 15.209 &15.247(d) | PASS |
| | Band Edges Measurement | Section 15.247 (d) &15.205 | PASS |

2. GENERAL DESCRIPTION OF EUT

2.1 APPLICANT

Name: Harman International Industries, Incorporated
Address: 8500 Balboa Blvd, Northridge, CA 91329, UNITED STATES

2.2 MANUFACTURER

Name: TCL TECHNOLOGY ELECTRONICS (HUIZHOU) CO., LTD
Address: Section 37, Zhongkai High-tech Development Zone, Huizhou City, Guang Dong Province, China.

2.3 BASIC DESCRIPTION OF EQUIPMENT UNDER TEST

Equipment: Blu-RAY DISC SYSTEM
Model No.: BDS 580
Adding Model: /
Trade Name: harman/kardon
Power supply AC 100-240V,50/60Hz
Frequency Range 2402MHz~2480MHz
Number of Channels: 79 Channels
Channel Separation: Channels with 1MHz step
Type of Modulation GFSK, 8DPSK, Pi/4 QPSK
Dwell time Per channel is less than 0.4s.
Antenna Type PCB antenna
Antenna gain 2dBi

3. LABORATORY AND ACCREDITATIONS

3.1 LABORATORY

The tests and measurements refer to this report were performed by Guangzhou GRG Metrology and Test CO., LTD.

Add. : 163 Pingyun Rd, West of Huangpu Ave, Guangzhou, 510656, P. R. China

Telephone: +86-20-38699959, 38699960, 38699961

Fax : +86-20-38695185

3.2 ACCREDITATIONS

Our laboratories are accredited and approved by the following approval agencies according to ISO/IEC 17025.

| | |
|---------------|-----------------------------|
| USA | FCC Listed Lab (No. 688188) |
| China | CNAS (No.L0446) |
| China | DILAC (No.DL175) |
| Canada | Registration No.:8355A-1 |

3.3 MEASUREMENT UNCERTAINTY

Where relevant, the following measurement uncertainty levels have been estimated for tests performed on the EUT as specified in CISPR 16-4-2:

| Measurement | | Frequency | Uncertainty |
|--------------------|------------|---------------|-------------|
| Radiated Emission | Horizontal | 30MHz~1000MHz | 4.2dB |
| | | 1GHz~26.5GHz | 4.2dB |
| | Vertical | 30MHz~1000MHz | 4.4dB |
| | | 1GHz~26.5GHz | 4.4dB |
| Conducted Emission | | 9kHz~30MHz | 3.1 dB |

This uncertainty represents an expanded uncertainty factor of $k=2$.

3.4 LIST OF USED TEST EQUIPMENT AT GRGT

| Name of Equipment | Manufacturer | Model | Serial Number | Calibration Due |
|--|--------------|-----------|---------------|-----------------|
| Conducted Emissions | | | | |
| EMI Receiver | R&S | ESU40 | 100529 | 2014-01-24 |
| L.I.S.N | SCHWARZBECK | NSLK 8127 | 8127450 | 2013-08-05 |
| Spurious Emissions at Antenna Port | | | | |
| Receiver | R&S | ESU40 | 100106 | 2014-01-24 |
| Restricted Bands | | | | |
| Receiver | R&S | ESU40 | 100106 | 2014-01-24 |
| Spurious Emissions | | | | |
| Receiver | R&S | ESU40 | 100106 | 2014-01-24 |
| Signal Generator | R&S | SML03 | 103002 | 2013-11-13 |
| Biconical Log-periodic Antenna | ETS.LINDGREN | 3142C | 00075971 | 2014-05-26 |
| Horn antenna | SCHWARZBECK | BBHA9120D | D752 | 2013-10-14 |
| 6 dB Bandwidth | | | | |
| Receiver | R&S | ESU40 | 100106 | 2014-01-24 |
| Maximum Peak Output Power | | | | |
| Receiver | R&S | ESU40 | 100106 | 2014-01-24 |
| 100kHz Bandwidth of Frequency Band Edge | | | | |
| Receiver | R&S | ESU40 | 100106 | 2014-01-24 |
| Power Spectral Density | | | | |
| Receiver | R&S | ESU40 | 100106 | 2014-01-24 |

NOTE: The calibration interval of the above test instruments is 12 months.

4. TEST RESULTS

4.1 E.U.T. TEST CONDITIONS

Type of antenna: Integral

Temperature: 22.0 °C

Humidity: 54 % RH

Atmospheric Pressure: 1011 mbar

Test frequencies: According to the 15.31(m) Measurements on intentional radiators or receivers, other than TV broadcast receivers, shall be performed and, if required, reported for each band in which the device can be operated with the device operating at the number of frequencies in each band specified in the following table:

| Frequency range over which device operates | Number of frequencies | Location in the range of operation |
|--|-----------------------|---|
| 1 MHz or less | 1 | Middle |
| 1 to 10 MHz | 2 | 1 near top and 1 near bottom |
| More than 10 MHz | 3 | 1 near top, 1 near middle and 1 near bottom |

EUT channels and frequencies list:

| Channel | Frequency (MHz) | Channel | Frequency (MHz) | Channel | Frequency (MHz) |
|---------|-----------------|---------|-----------------|---------|-----------------|
| 0 | 2402 | 14 | 2416 | 28 | 2430 |
| 1 | 2403 | 15 | 2417 | 29 | 2431 |
| 2 | 2404 | 16 | 2418 | 30 | 2432 |
| 3 | 2405 | 17 | 2419 | 31 | 2433 |
| 4 | 2406 | 18 | 2420 | 32 | 2434 |
| 5 | 2407 | 19 | 2421 | 33 | 2435 |
| 6 | 2408 | 20 | 2422 | 34 | 2436 |
| 7 | 2409 | 21 | 2423 | 35 | 2437 |
| 8 | 2410 | 22 | 2424 | 36 | 2438 |
| 9 | 2411 | 23 | 2425 | 37 | 2439 |
| 10 | 2412 | 24 | 2426 | 38 | 2440 |
| 11 | 2413 | 25 | 2427 | 39 | 2441 |
| 12 | 2414 | 26 | 2428 | 40 | 2442 |
| 13 | 2415 | 27 | 2429 | 41 | 2443 |

| Channel | Frequency (MHz) | Channel | Frequency (MHz) | Channel | Frequency (MHz) |
|----------------|------------------------|----------------|------------------------|----------------|------------------------|
| 42 | 2444 | 55 | 2457 | 68 | 2470 |
| 43 | 2445 | 56 | 2458 | 69 | 2471 |
| 44 | 2446 | 57 | 2459 | 70 | 2472 |
| 45 | 2447 | 58 | 2460 | 71 | 2473 |
| 46 | 2448 | 59 | 2461 | 72 | 2474 |
| 47 | 2449 | 60 | 2462 | 73 | 2475 |
| 48 | 2450 | 61 | 2463 | 74 | 2476 |
| 49 | 2451 | 62 | 2464 | 75 | 2477 |
| 50 | 2452 | 63 | 2465 | 76 | 2478 |
| 51 | 2453 | 64 | 2466 | 77 | 2479 |
| 52 | 2454 | 65 | 2467 | 78 | 2480 |
| 53 | 2455 | 66 | 2468 | | |
| 54 | 2456 | 67 | 2469 | | |

Test frequency is the lowest channel: 0 channel(2402MHz), middle channel: 39 channel(2441MHz) and highest channel: 78 channel(2480MHz)

4.2 ANTENNA REQUIREMENT

The EUT antenna is PCB Printed antenna. Antenna gain is 2dBi .which accordance 15.203.is considered sufficient to comply with the provisions of this section

4.3 OCCUPIED BANDWIDTH

4.3.1 LIMITS

Frequency hopping systems operating in the 2400-2483.5 MHz band may have hopping channel carrier frequencies that are separated by 25 kHz or two-thirds of the 20 dB bandwidth of the hopping channel, whichever is greater, provided the systems operate with an output power no greater than 125 mW.

4.3.2 TEST PROCEDURES

1. Remove the antenna from the EUT and then connect a low RF cable from the antenna port to the spectrum;
2. Set the spectrum analyzer: Span = approximately 2 to 3 times the 20dB bandwidth, center on a hopping channel;
3. Set the spectrum analyzer: RBW \geq 1% of the 20dB bandwidth (set 10kHz). VBW \geq RBW. Sweep = auto; Detector Function = Peak. Trace = Max Hold.
4. Mark the peak frequency and -20dB bandwidth.
5. bandwidth value is OBW value.

Remark:

Pre-test the 3 modulation to find GFSK and 8DPSK is worse case, so only record GFSK and 8DPSK test data.

4.3.3 TEST SETUP

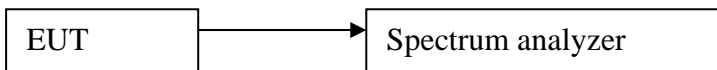

4.3.4 TEST RESULTS

For GFSK

| Frequency (GHz) | Test Channel | bandwidth |
|-----------------|--------------|-----------|
| 2.402 | Lowest | 1.134MHz |
| 2.441 | Middle | 1.134MHz |
| 2.480 | Highest | 1.128MHz |

For 8DPSK

| Frequency (GHz) | Test Channel | bandwidth |
|-----------------|--------------|-----------|
| 2.402 | Lowest | 1.320MHz |
| 2.441 | Middle | 1.320MHz |
| 2.480 | Highest | 1.320MHz |

Result plot as follows:

GFSK Lowest Channel:

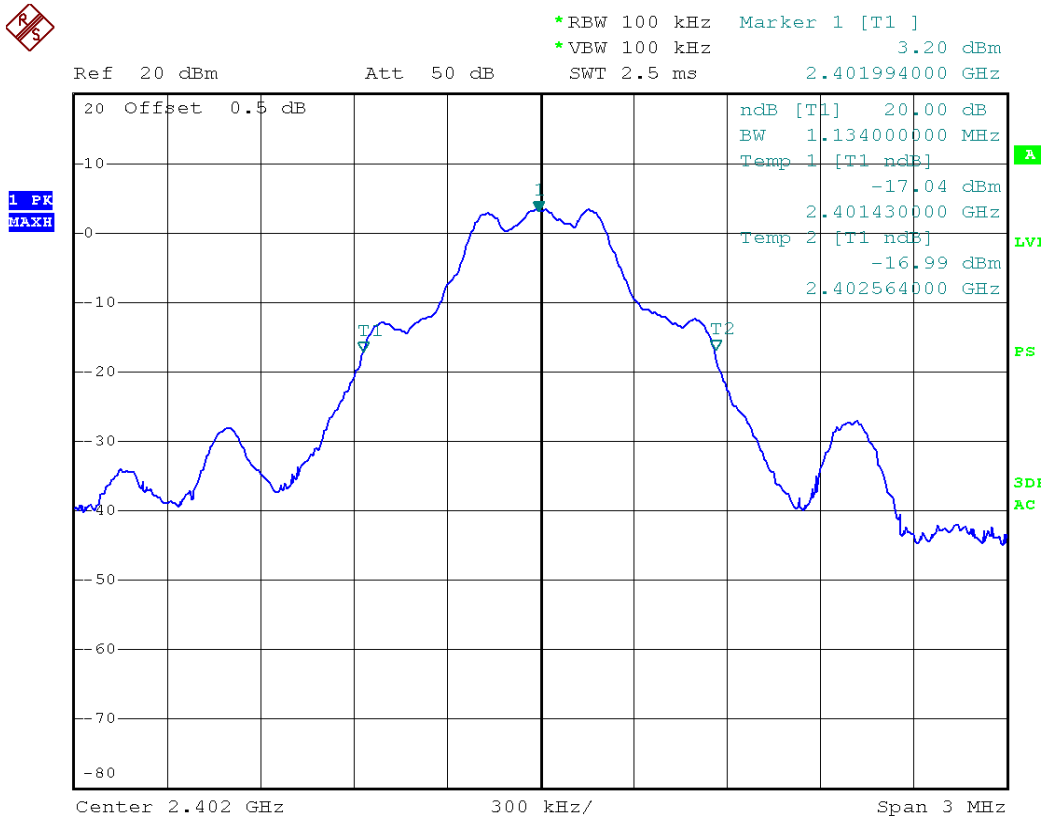

GFSK Middle Channel:

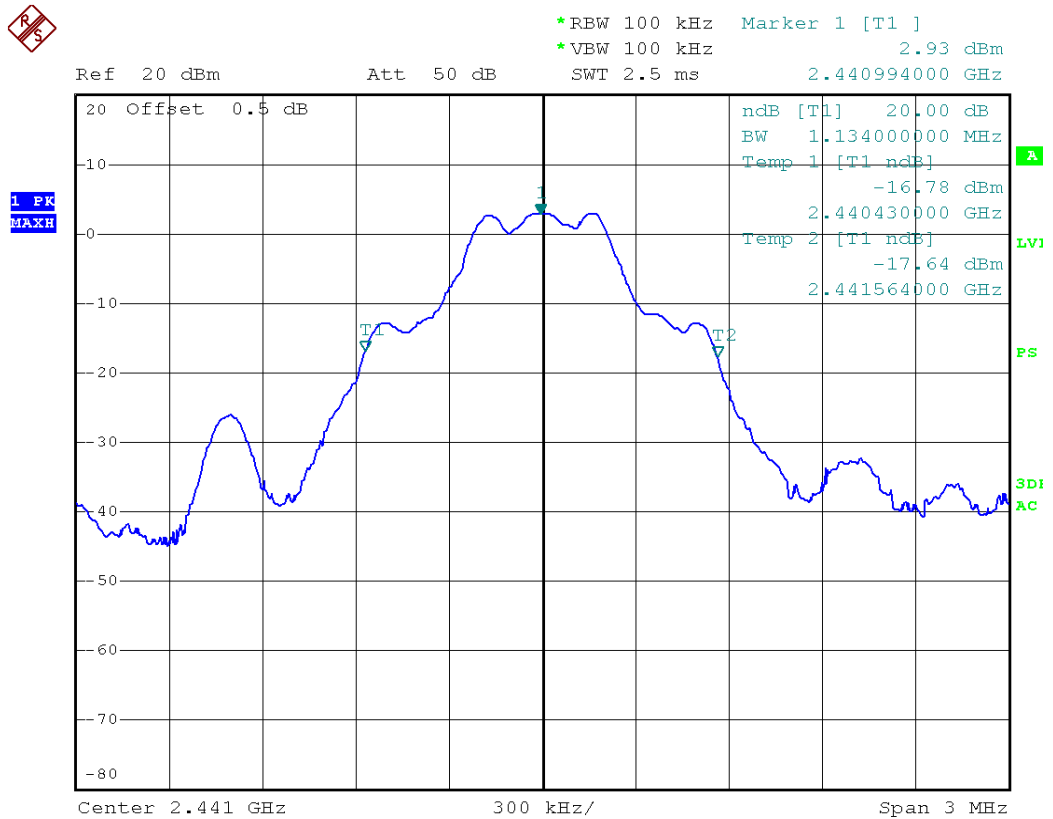

GFSK Highest Channel:

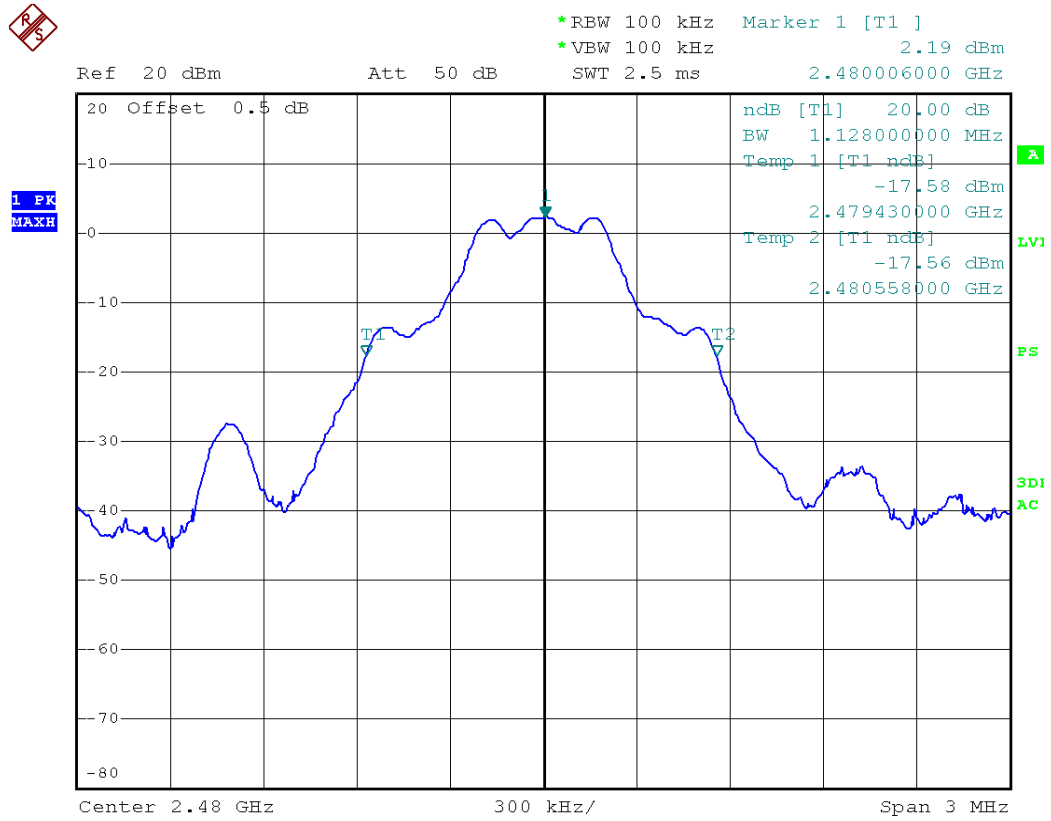

8DPSK Lowest Channel:

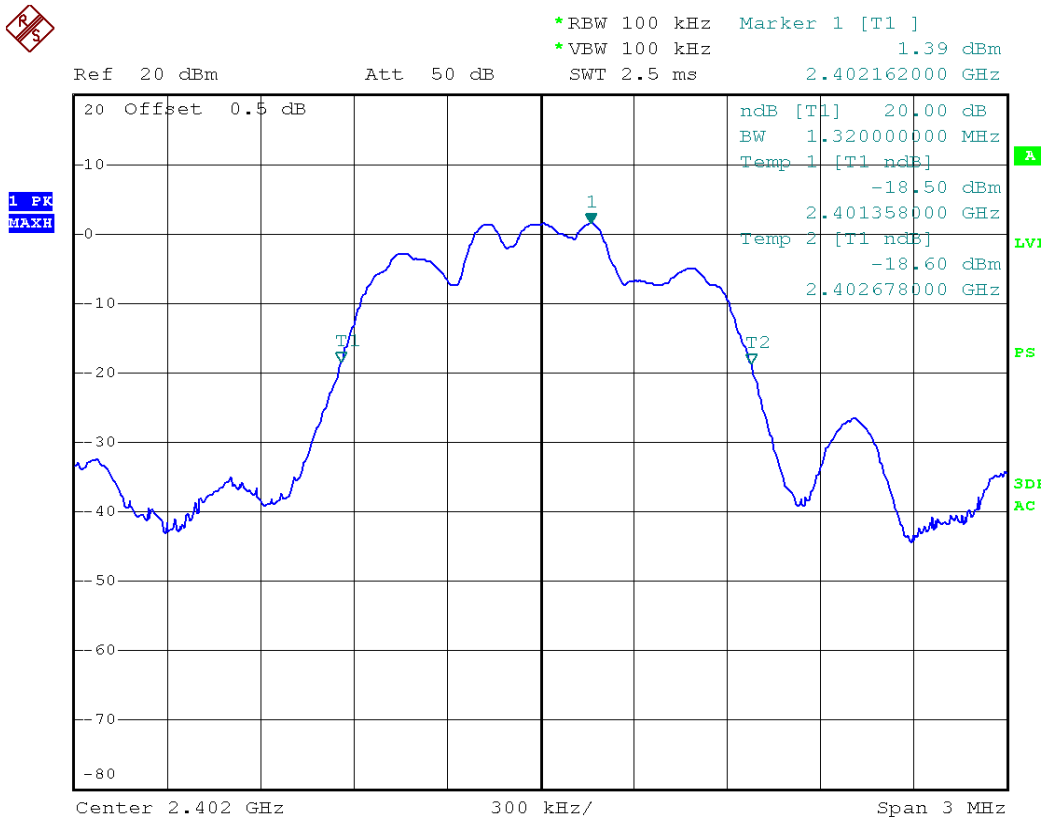

8DPSK Middle Channel:

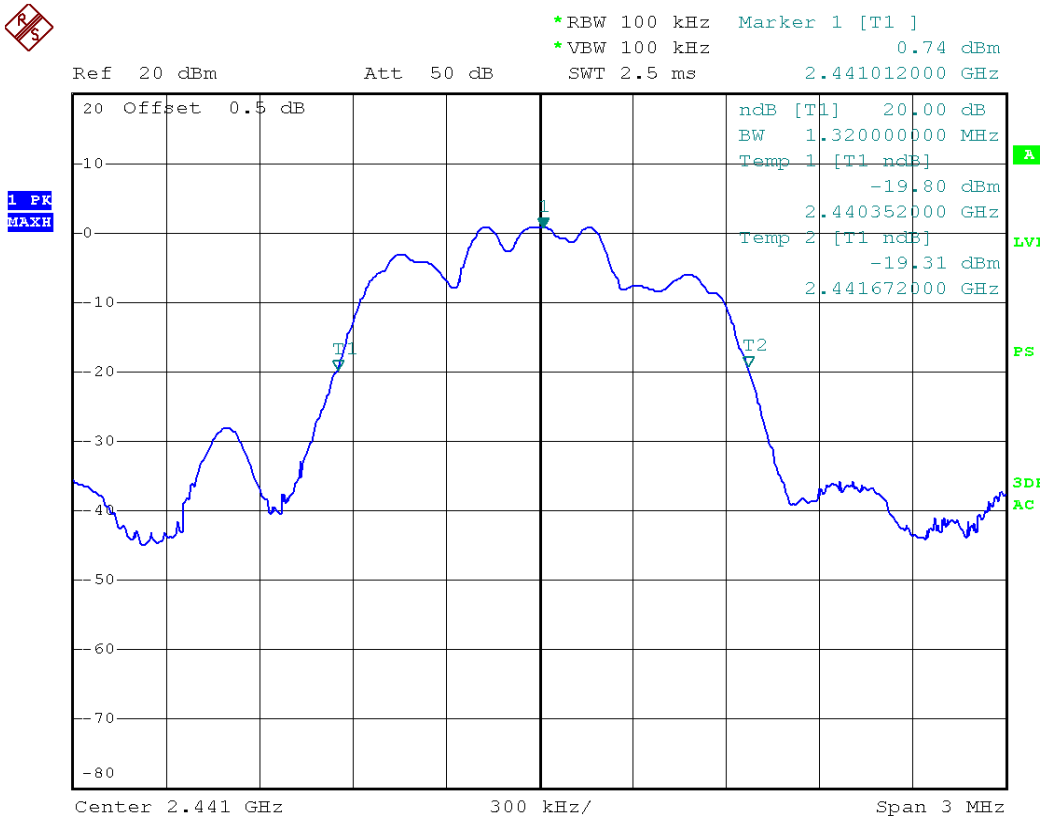

8DPSK Highest Channel:

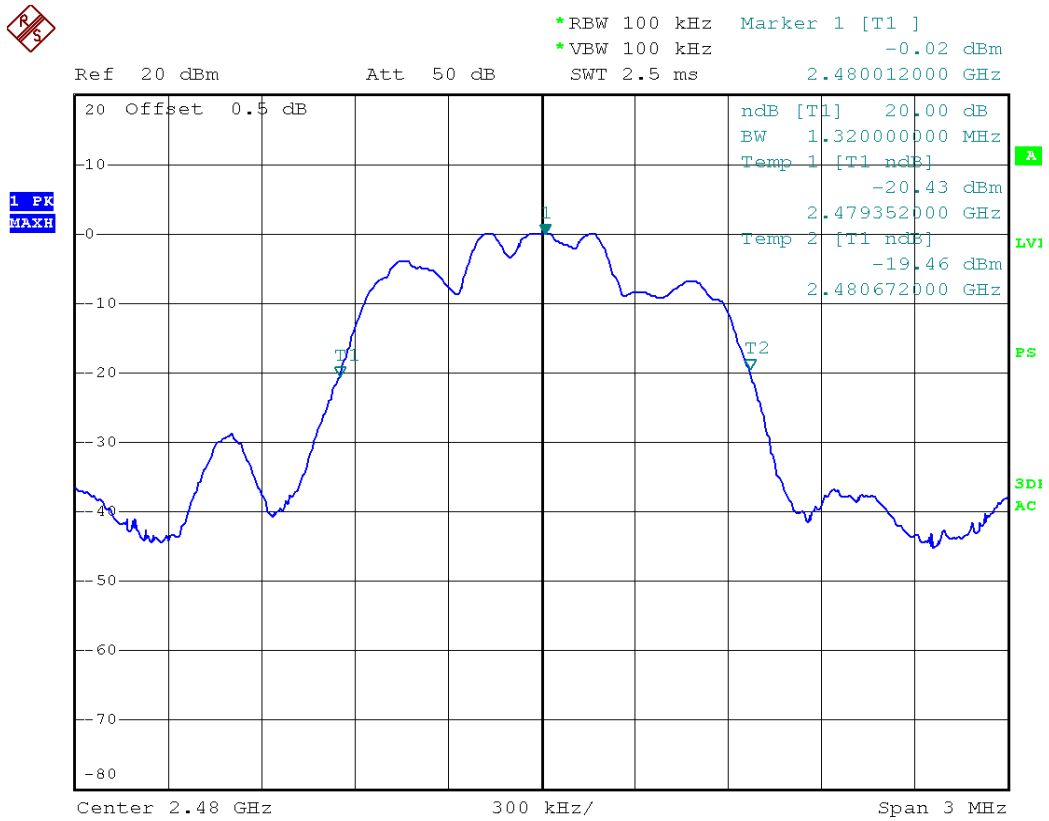

4.4 CARRIER FREQUENCIES SEPARATED

4.4.1 LIMITS

Frequency hopping systems operating in the 2400-2483.5 MHz band may have hopping channel carrier frequencies that are separated by 25 kHz or two-thirds of the 20 dB bandwidth of the hopping channel, whichever is greater, provided the systems operate with an output power no greater than 125 mW.

4.4.2 TEST PROCEDURES

1. Remove the antenna from the EUT and then connect a low RF cable from the antenna port to the spectrum.
2. Set the spectrum analyzer: RBW >= 1% of the span (set 100 kHz). VBW >= RBW , Span = 6MHz. Sweep = auto; Detector Function = Peak. Trace = Max,hold.
3. Allow the trace to stabilize. Use the marker-delta function to determine the separation between the peaks of the adjacent channels. The limit is specified in one of the subparagraphs of this Section. Submit this plot.

Remark :

Pre-test the 3 modulation to find GFSK and 8DPSK is worse case, so only record GFSK and 8DPSK test data.

4.4.3 TEST SETUP

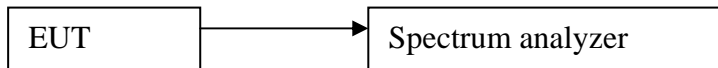

4.4.4 TEST RESULTS

| Mode | Test Channel | Carrier Frequencies Separated | 2/3 20 dB bandwidth | PASS/FAIL |
|-------|---|-------------------------------|---------------------|-----------|
| GFSK | Lower Channels (channel 0 and channel 1) | 0.998MHz | 0.756 MHz | Pass |
| | Middle Channels (channel 39 and channel 40) | 1.002MHz | 0.756 MHz | Pass |
| | Upper Channels (channel 77 and channel 78) | 1.002MHz | 0.752 MHz | Pass |
| 8DPSK | Lower Channels (channel 0 and channel 1) | 1.004MHz | 0.88 MHz | Pass |
| | Middle Channels (channel 39 and channel 40) | 1.002MHz | 0.88 MHz | Pass |
| | Upper Channels (channel 77 and channel 78) | 1.002MHz | 0.88 MHz | Pass |

Result plot as follows:

GFSK Lowest Channels:

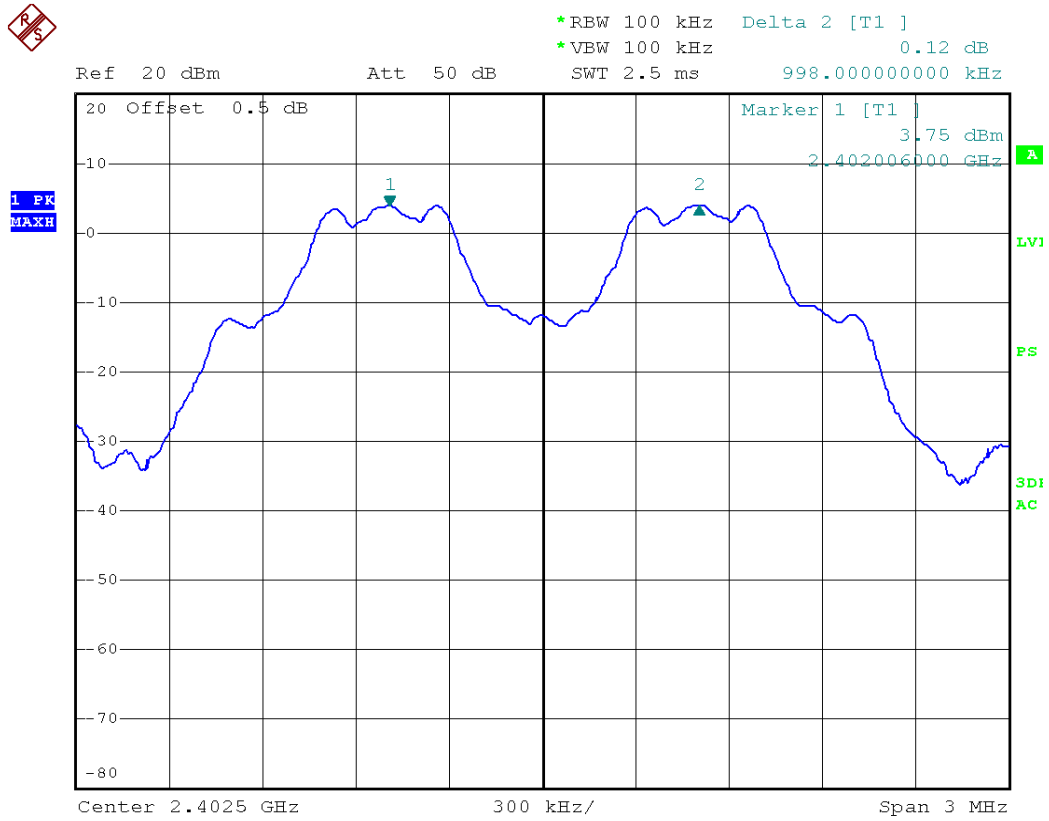

GFSK Middle Channels:

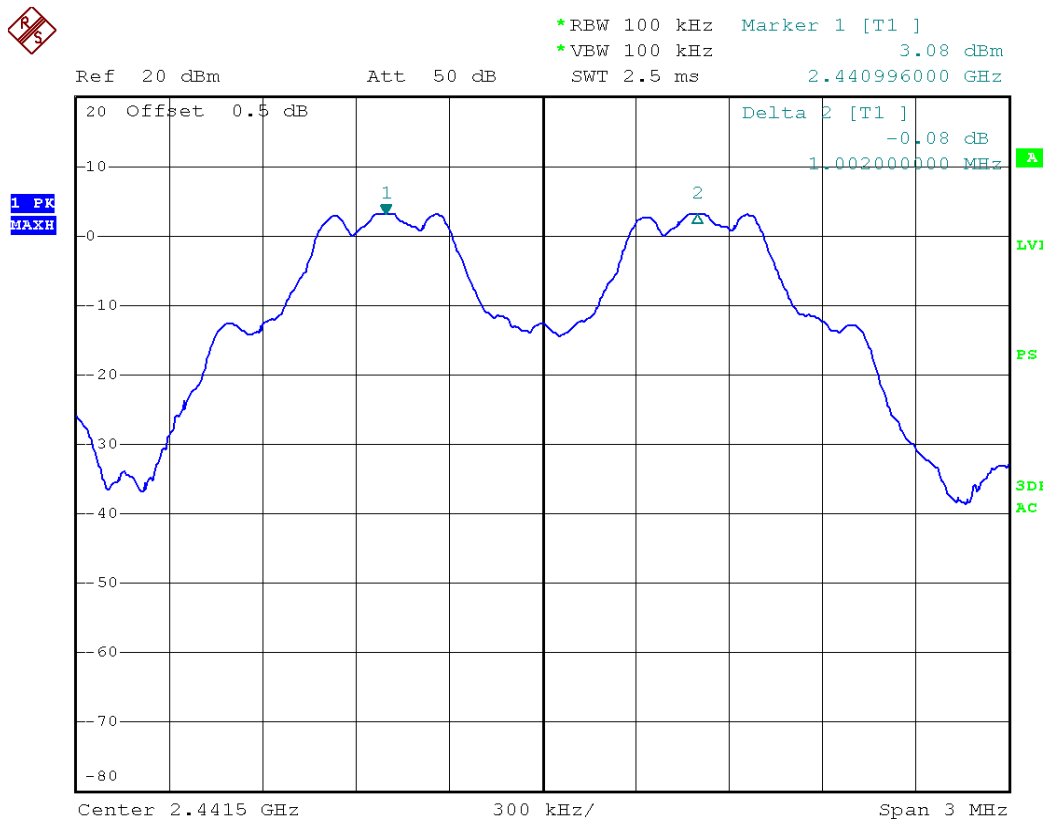

GFSK Highest Channels:

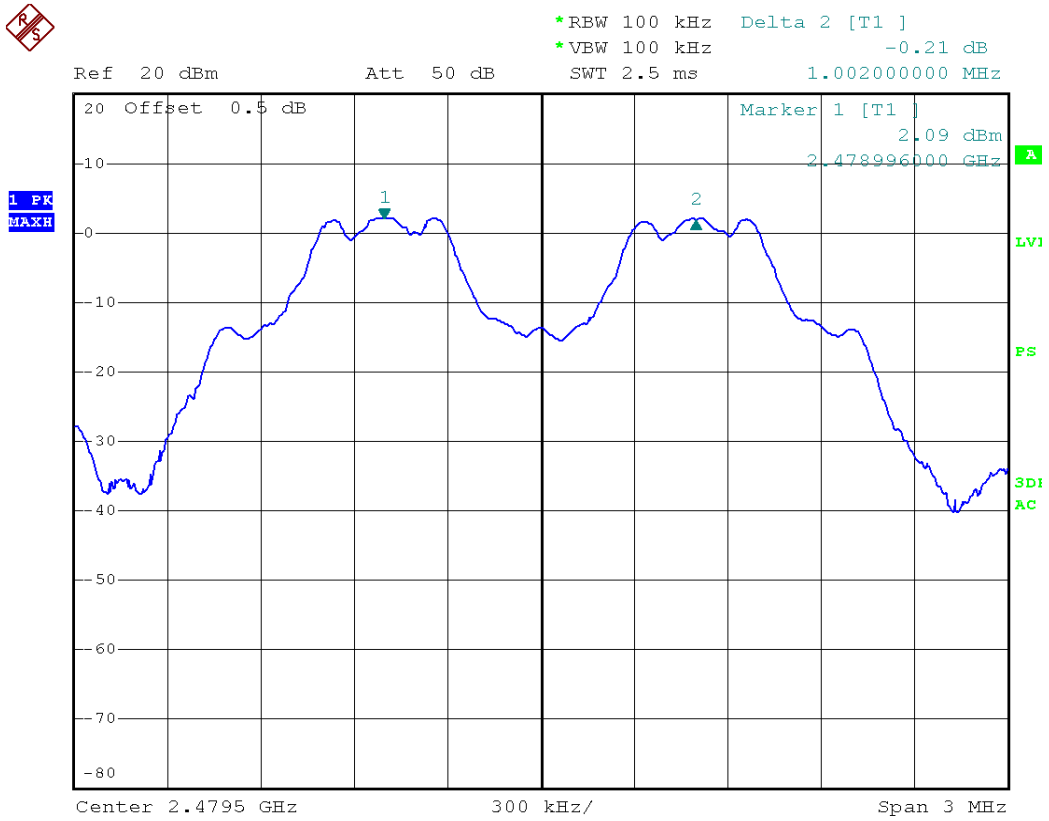

8DPSK Lowest Channels:

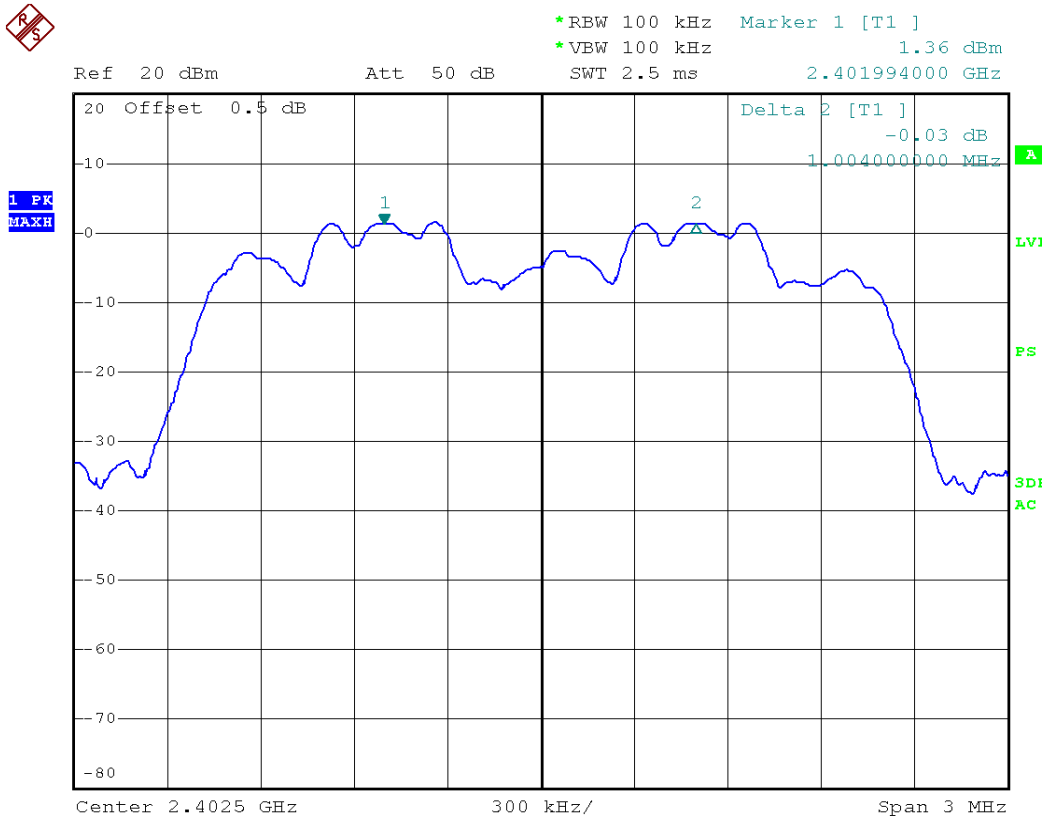

8DPSK Middle Channels:

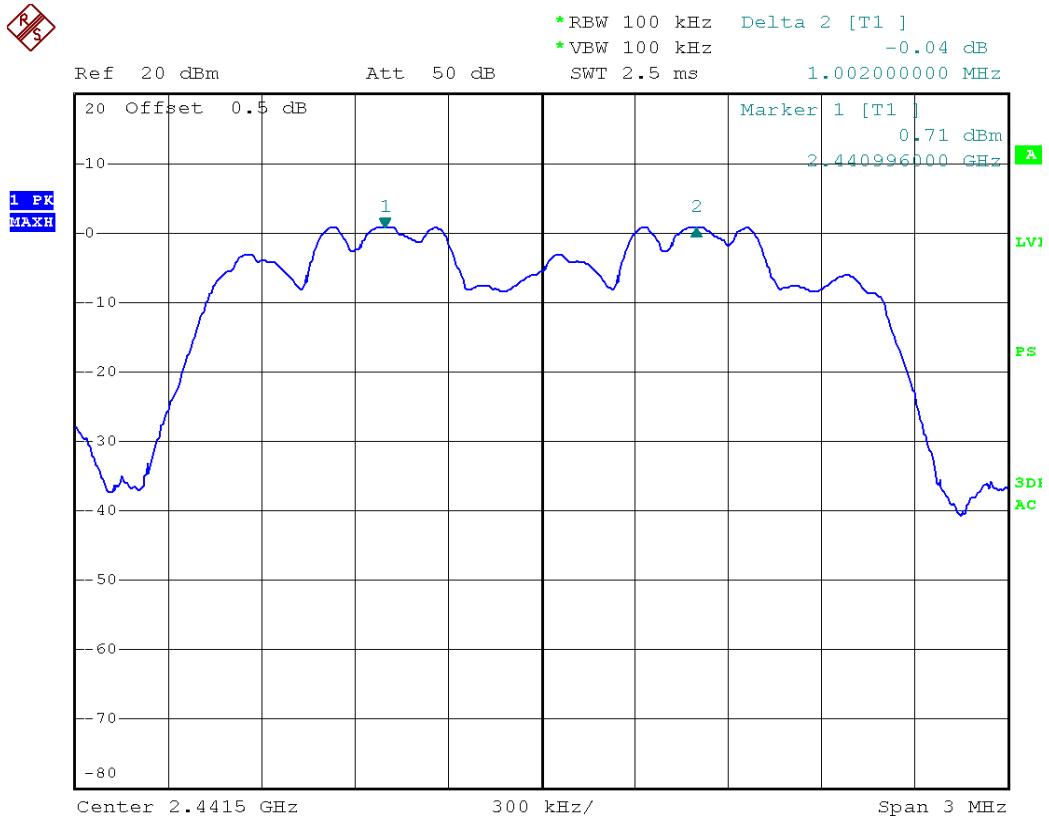

8DPSK Highest Channels:

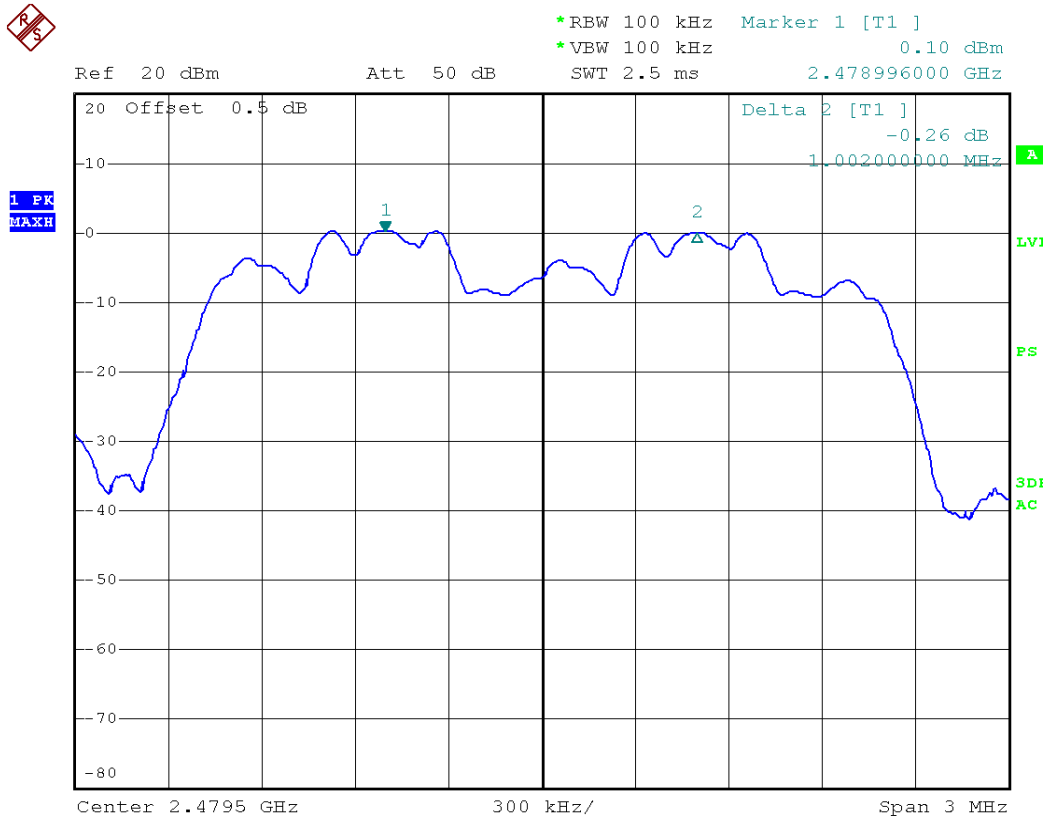

Test result: The unit does meet the FCC requirements.

4.5 HOPPING CHANNEL NUMBER

4.5.1 LIMITS

Regulation 15.247 (a) (1)(iii) Frequency hopping systems in the 2400-2483.5 MHz band shall use at least 15 channels.

4.5.2 TEST PROCEDURES

1. Remove the antenna from the EUT and then connect a low RF cable from the antenna port to the spectrum.
2. Set the spectrum analyzer: RBW = 100 kHz. VBW = 300 kHz. Sweep = auto; Detector Function = Peak. Trace = Max hold.
3. Allow the trace to stabilize. It may prove necessary to break the span up to sections. in order to clearly show all of the hopping frequencies. The limit is specified in one of the subparagraphs of this Section.
4. Set the spectrum analyzer: start frequency = 2400MHz. stop frequency = 2483.5MHz. Submit the test result graph.

4.5.3 TEST SETUP

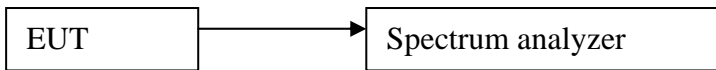

4.5.4 TEST RESULTS

Test result: Total channels are 79 channels.

Result plot as follows:

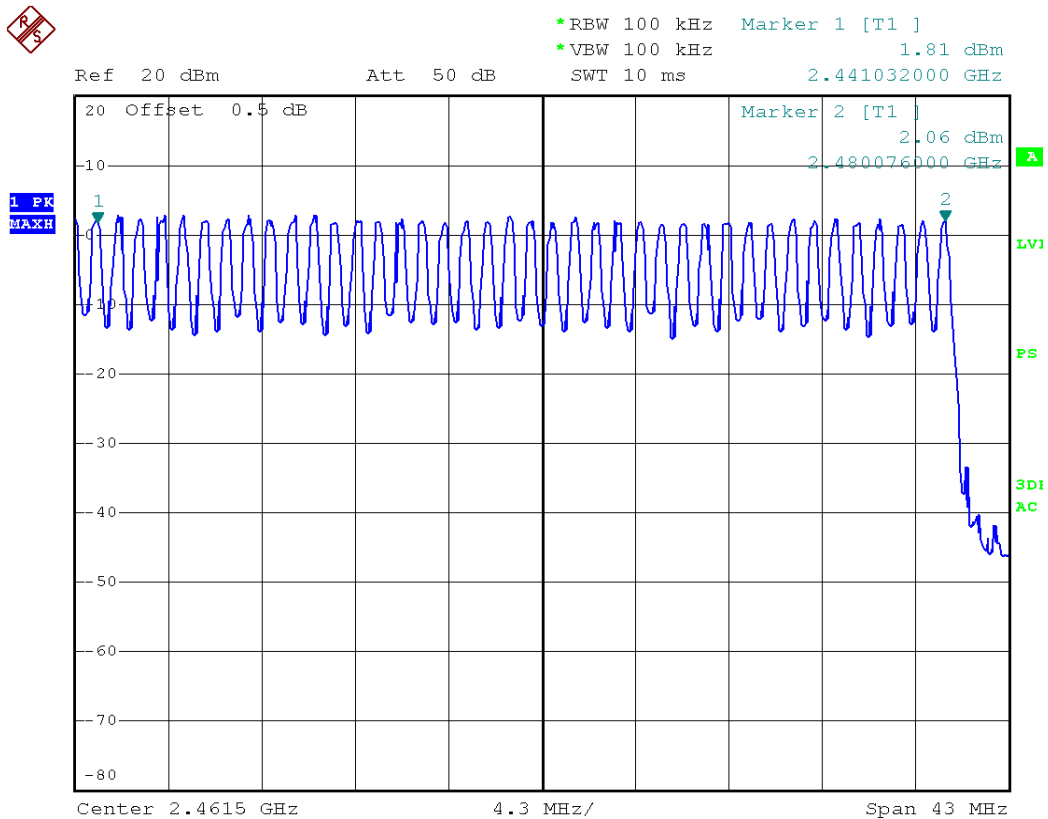
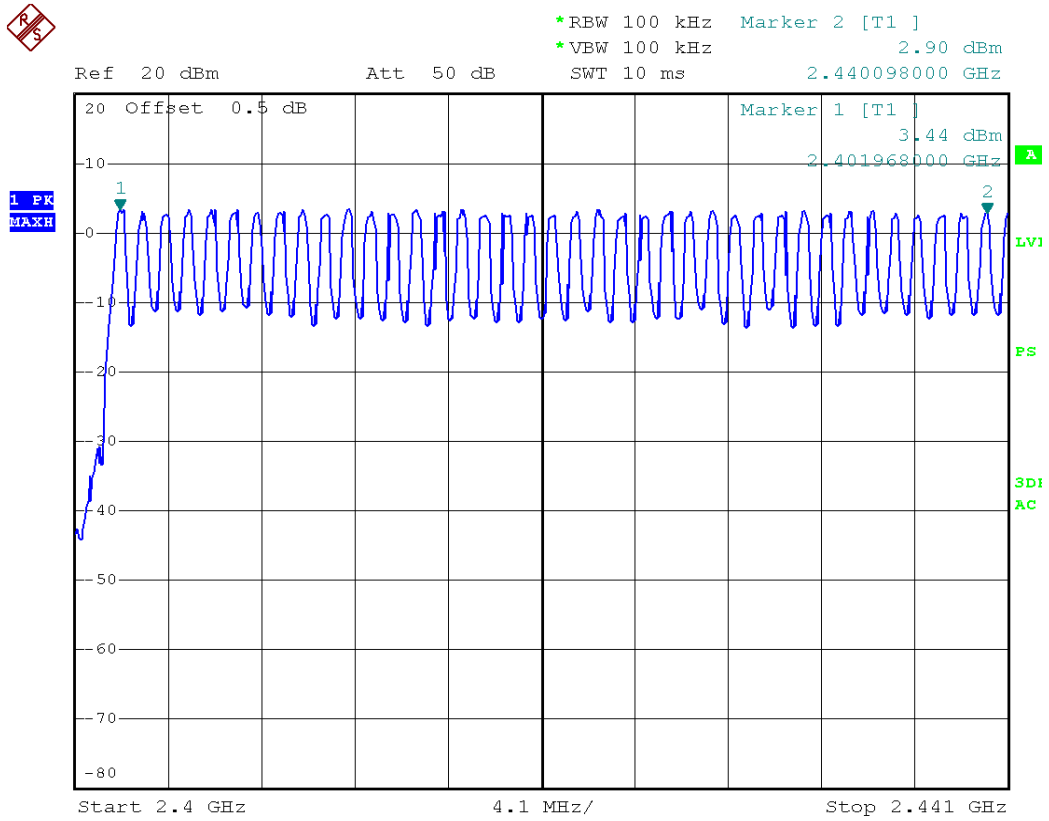

Test result: The unit does meet the FCC requirements.

4.6 DWELL TIME

4.6.1 LIMITS

Regulation 15.247(a)(1)(iii) Frequency hopping systems in the 2400-2483.5 MHz band shall use at least 15 channels. The average time of occupancy on any channel shall not be greater than 0.4 seconds within a period of 0.4 seconds multiplied by the number of hopping channels employed. Frequency hopping systems may avoid or suppress transmissions on a particular hopping frequency provided that a minimum of 15 channels are used.

4.6.2 TEST PROCEDURES

1. Remove the antenna from the EUT and then connect a low RF cable from the antenna port to the spectrum.
2. Set spectrum analyzer span = 0. centered on a hopping channel;
3. Set RBW = 1MHz and VBW = 3MHz.Sweep = as necessary to capture the entire dwell time per hopping channel. Detector Function = Peak. Trace = Max hold;
4. Use the marker-delta function to determine the dwell time. If this value varies with different modes of operation (e.g., data rate, modulation format, etc.), repeat this test for each variation. The limit is specified in one of the subparagraphs of this Section. Submit this plot(s). An oscilloscope may be used instead of a spectrum analyzer.

4.6.3 TEST SETUP

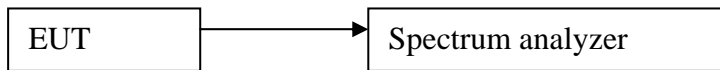

4.6.4 TEST RESULTS

The test period: $T = 0.4 \text{ Second/Channel} \times 79 \text{ Channel} = 31.6 \text{ s}$

1. Channel 0: 2.402GHz

| | | | | | | | | | |
|------|------------|-------|-------|-----------------|---|------|---|-------|----|
| DH1 | time slot= | 0.4 | (ms)* | $(1600/(2*79))$ | * | 31.6 | = | 128.0 | ms |
| DH3 | time slot= | 1.657 | (ms)* | $(1600/(4*79))$ | * | 31.6 | = | 265.1 | ms |
| DH5 | time slot= | 2.905 | (ms)* | $(1600/(6*79))$ | * | 31.6 | = | 309.9 | ms |
| 2DH1 | time slot= | 0.409 | (ms)* | $(1600/(2*79))$ | * | 31.6 | = | 130.9 | ms |
| 2DH3 | time slot= | 1.657 | (ms)* | $(1600/(4*79))$ | * | 31.6 | = | 265.1 | ms |
| 2DH5 | time slot= | 2.91 | (ms)* | $(1600/(6*79))$ | * | 31.6 | = | 310.4 | ms |
| 3DH1 | time slot= | 0.418 | (ms)* | $(1600/(2*79))$ | * | 31.6 | = | 133.8 | ms |
| 3DH3 | time slot= | 1.673 | (ms)* | $(1600/(4*79))$ | * | 31.6 | = | 267.7 | ms |
| 3DH5 | time slot= | 2.921 | (ms)* | $(1600/(6*79))$ | * | 31.6 | = | 311.6 | ms |

2. Channel 39: 2.441GHz

| | | | | | | | | | |
|------|------------|-------|-------|---------------|---|------|---|-------|----|
| DH1 | time slot= | 0.4 | (ms)* | (1600/(2*79)) | * | 31.6 | = | 128.0 | ms |
| DH3 | time slot= | 1.657 | (ms)* | (1600/(4*79)) | * | 31.6 | = | 265.1 | ms |
| DH5 | time slot= | 2.905 | (ms)* | (1600/(6*79)) | * | 31.6 | = | 309.9 | ms |
| 2DH1 | time slot= | 0.409 | (ms)* | (1600/(2*79)) | * | 31.6 | = | 130.9 | ms |
| 2DH3 | time slot= | 1.657 | (ms)* | (1600/(4*79)) | * | 31.6 | = | 265.1 | ms |
| 2DH5 | time slot= | 2.91 | (ms)* | (1600/(6*79)) | * | 31.6 | = | 310.4 | ms |
| 3DH1 | time slot= | 0.409 | (ms)* | (1600/(2*79)) | * | 31.6 | = | 130.9 | ms |
| 3DH3 | time slot= | 1.657 | (ms)* | (1600/(4*79)) | * | 31.6 | = | 265.1 | ms |
| 3DH5 | time slot= | 2.921 | (ms)* | (1600/(6*79)) | * | 31.6 | = | 311.6 | ms |

3. Channel 78: 2.480GHz

| | | | | | | | | | |
|------|------------|-------|-------|---------------|---|------|---|-------|----|
| DH1 | time slot= | 0.392 | (ms)* | (1600/(2*79)) | * | 31.6 | = | 125.4 | ms |
| DH3 | time slot= | 1.657 | (ms)* | (1600/(4*79)) | * | 31.6 | = | 265.1 | ms |
| DH5 | time slot= | 2.906 | (ms)* | (1600/(6*79)) | * | 31.6 | = | 310.0 | ms |
| 2DH1 | time slot= | 0.409 | (ms)* | (1600/(2*79)) | * | 31.6 | = | 130.9 | ms |
| 2DH3 | time slot= | 1.674 | (ms)* | (1600/(4*79)) | * | 31.6 | = | 267.8 | ms |
| 2DH5 | time slot= | 2.894 | (ms)* | (1600/(6*79)) | * | 31.6 | = | 308.7 | ms |
| 3DH1 | time slot= | 0.409 | (ms)* | (1600/(2*79)) | * | 31.6 | = | 130.9 | ms |
| 3DH3 | time slot= | 1.674 | (ms)* | (1600/(4*79)) | * | 31.6 | = | 267.8 | ms |
| 3DH5 | time slot= | 2.912 | (ms)* | (1600/(6*79)) | * | 31.6 | = | 310.6 | ms |

The results are not greater than 0.4 seconds.

The unit does meet the requirements.

Please refer the graph as below:

1. Lowest channel (2.402 GHz):

DH1

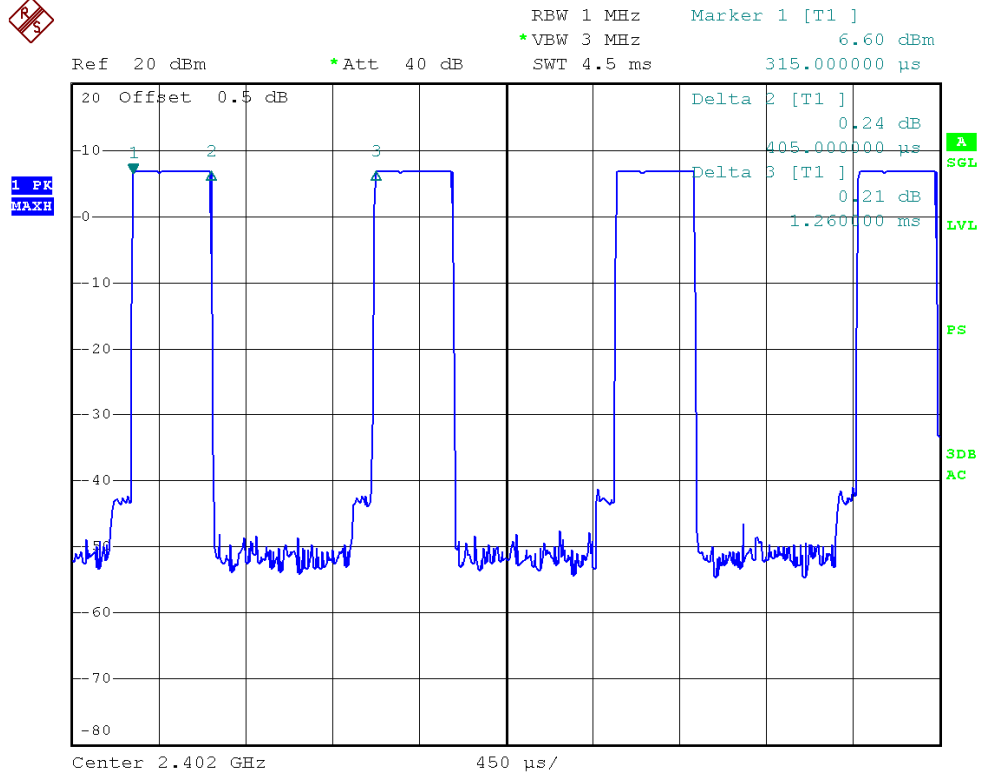

DH3:

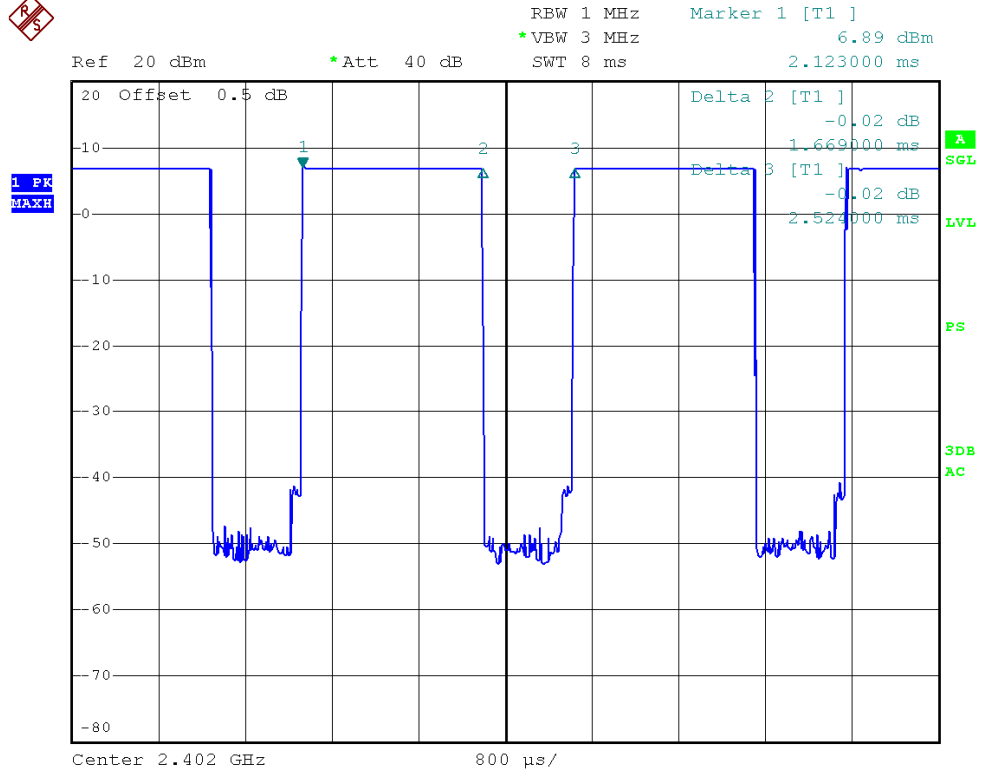

DH5:

2DH3

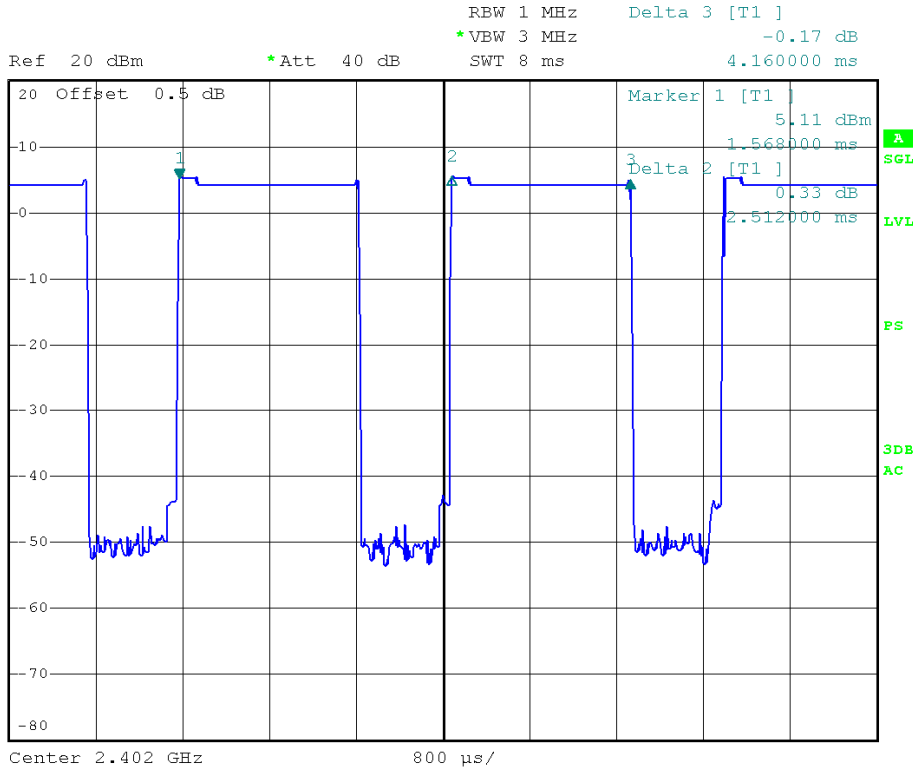

2DH5

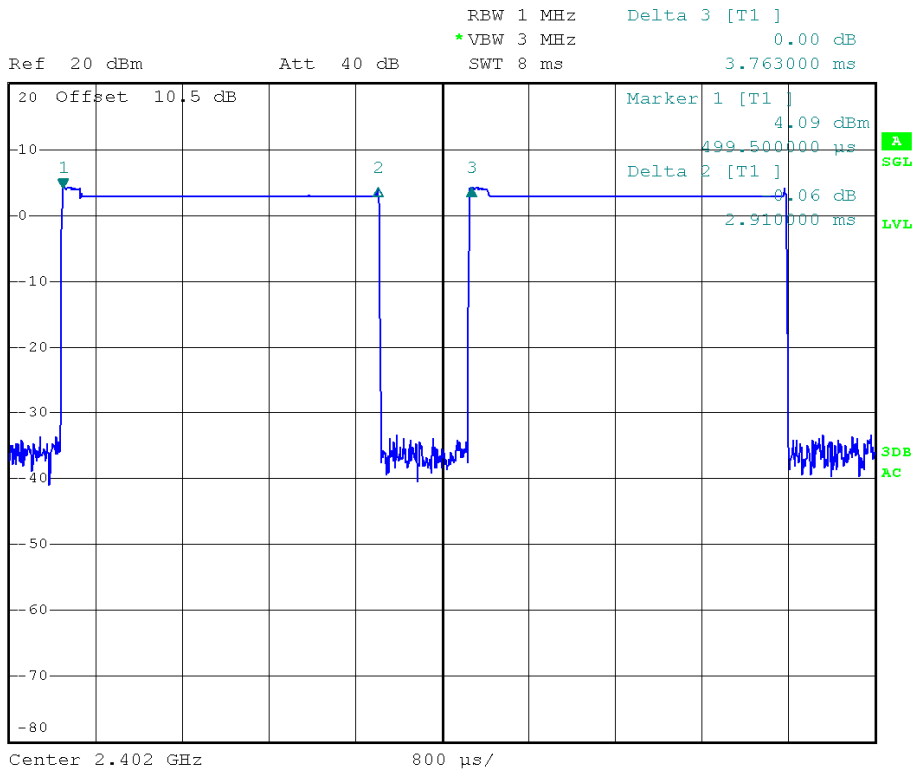

3DH1

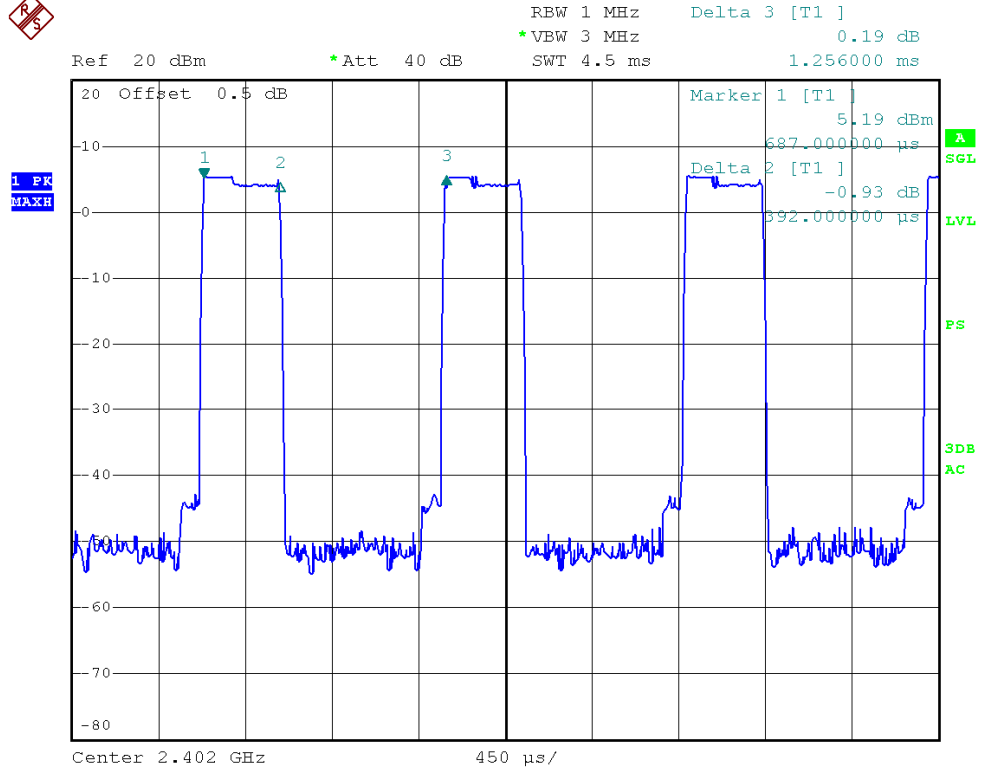

3DH3

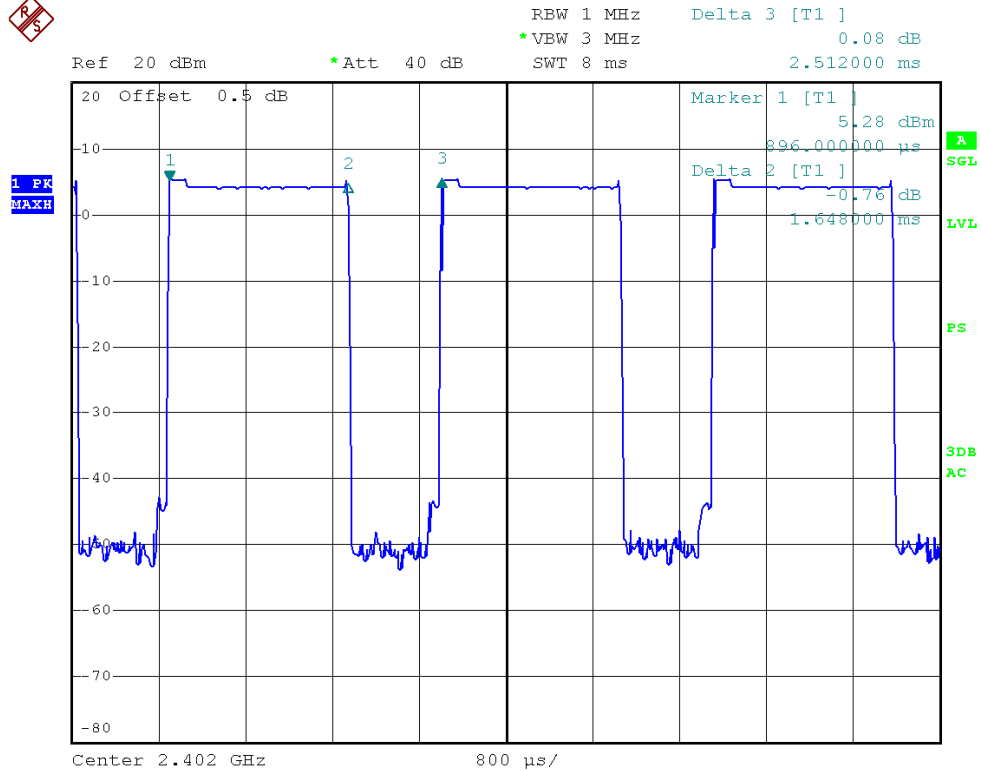

3DH5



RBW 1 MHz Delta 3 [T1]
*VBW 3 MHz -0.03 dB
SWT 8 ms 3.776000 ms

Ref 20 dBm *Att 40 dB

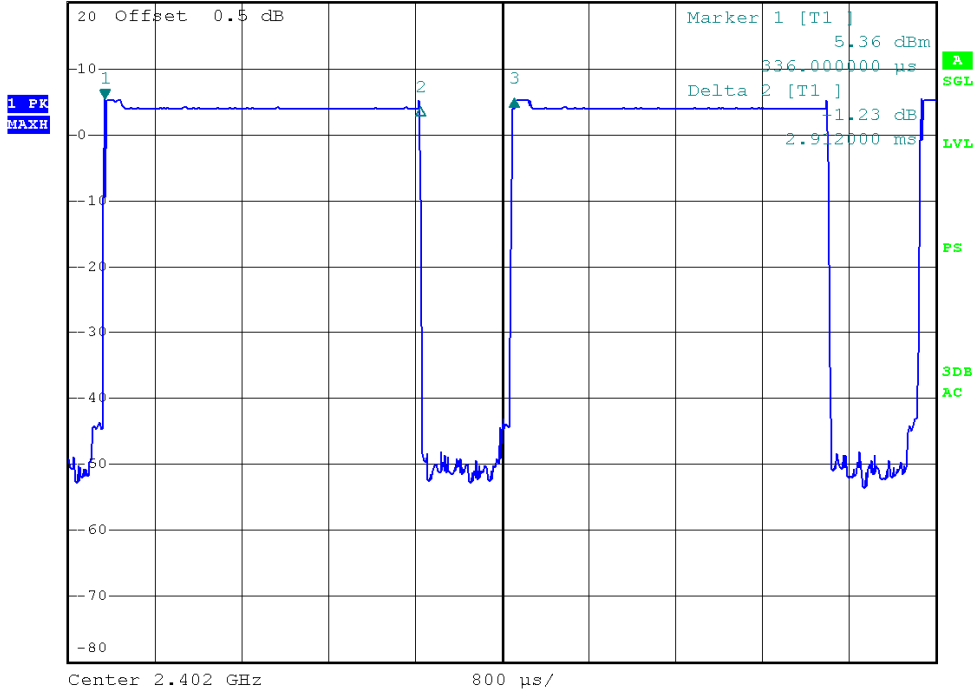

2. Middle Channel (2.441GHz)

DH1

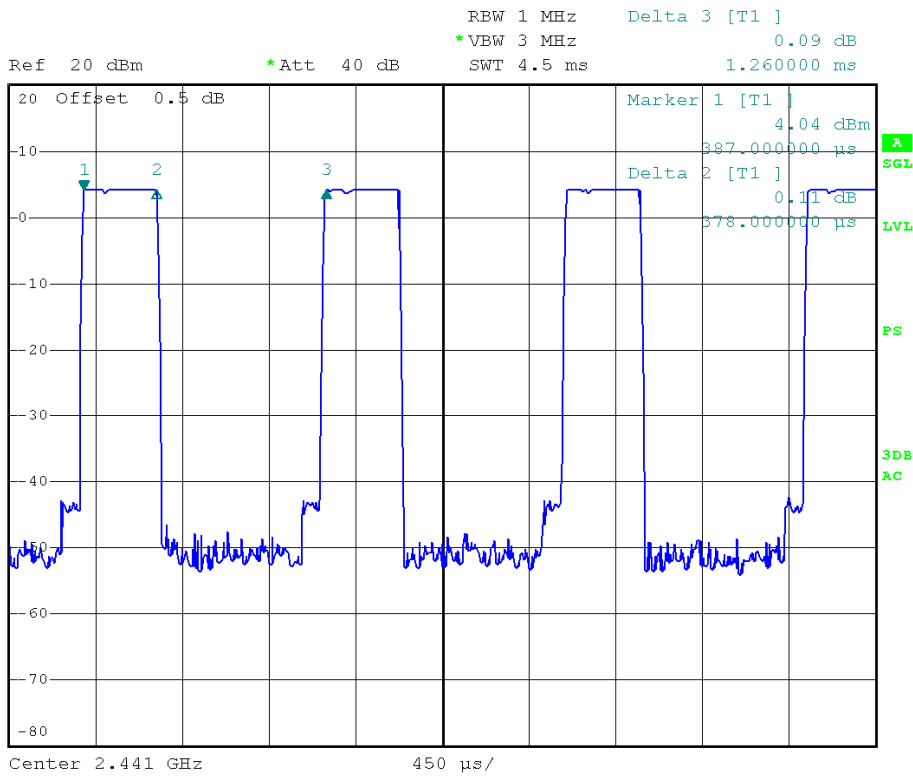

DH3

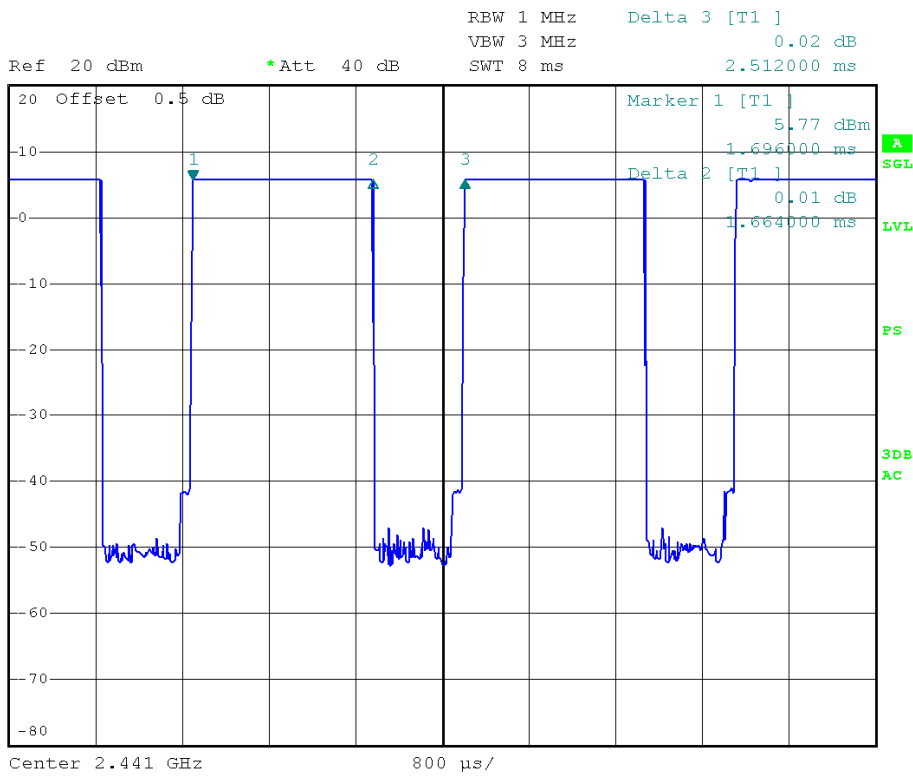

DH5



RBW 1 MHz Marker 1 [T1]
VBW 3 MHz 3.18 dBm
SWT 8 ms 1.760000 ms

Ref 20 dBm *Att 40 dB

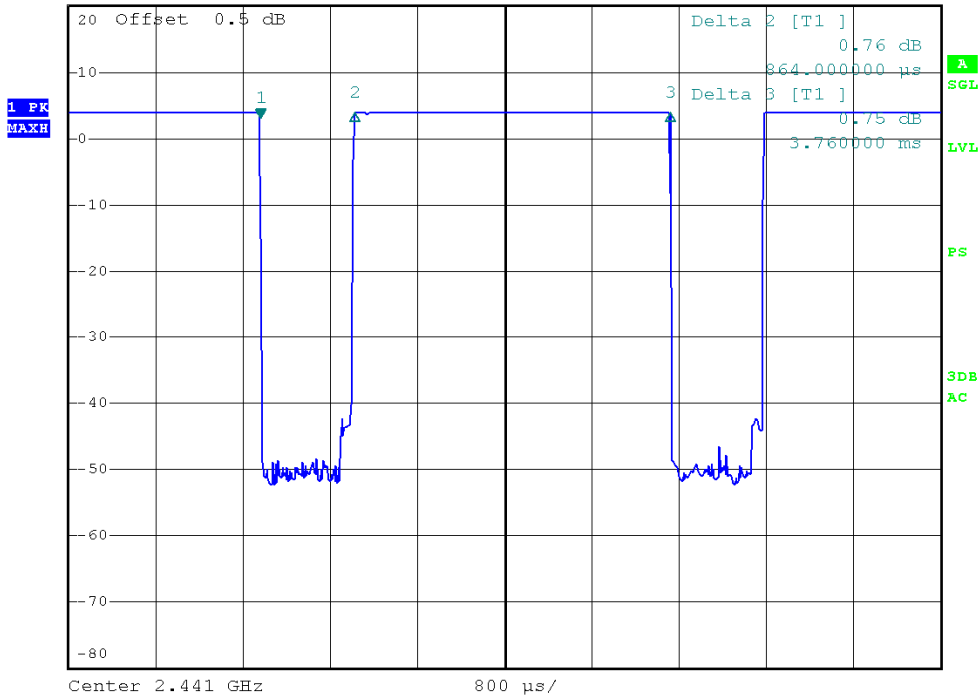

2DH1



RBW 1 MHz Delta 3 [T1]
*VBW 3 MHz 0.06 dB
SWT 4.5 ms 1.260000 ms

Ref 20 dBm *Att 40 dB

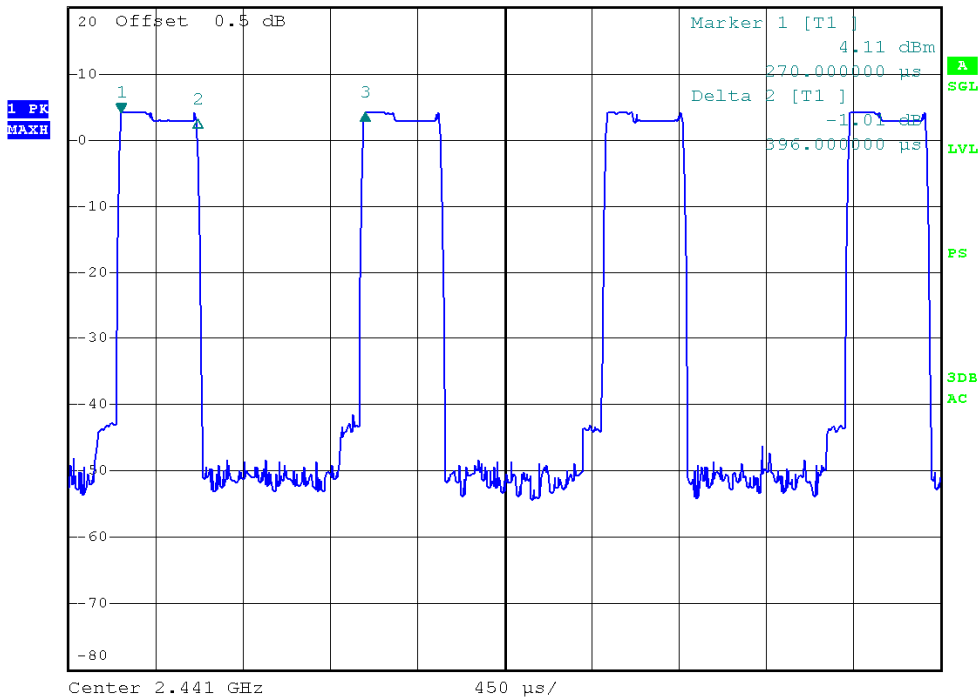

2DH3



RBW 1 MHz Delta 3 [T1]
VBW 3 MHz 0.01 dB
SWT 8 ms 2.512000 ms

Ref 20 dBm *Att 40 dB

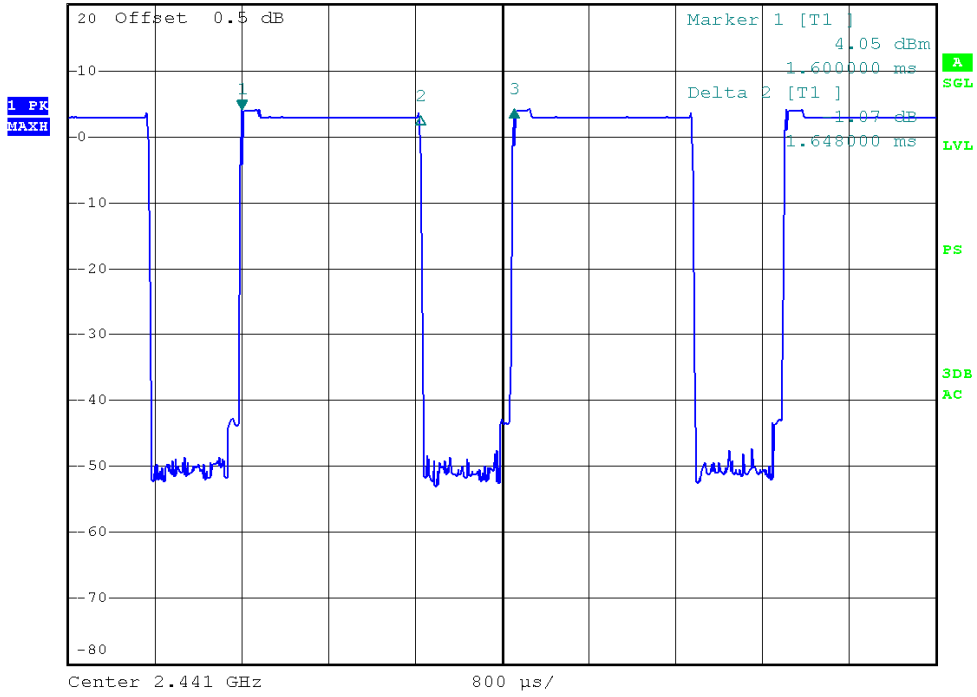

2DH5



RBW 1 MHz Delta 3 [T1]
*VBW 3 MHz 0.03 dB
SWT 8 ms 3.763000 ms

Ref 20 dBm Att 40 dB

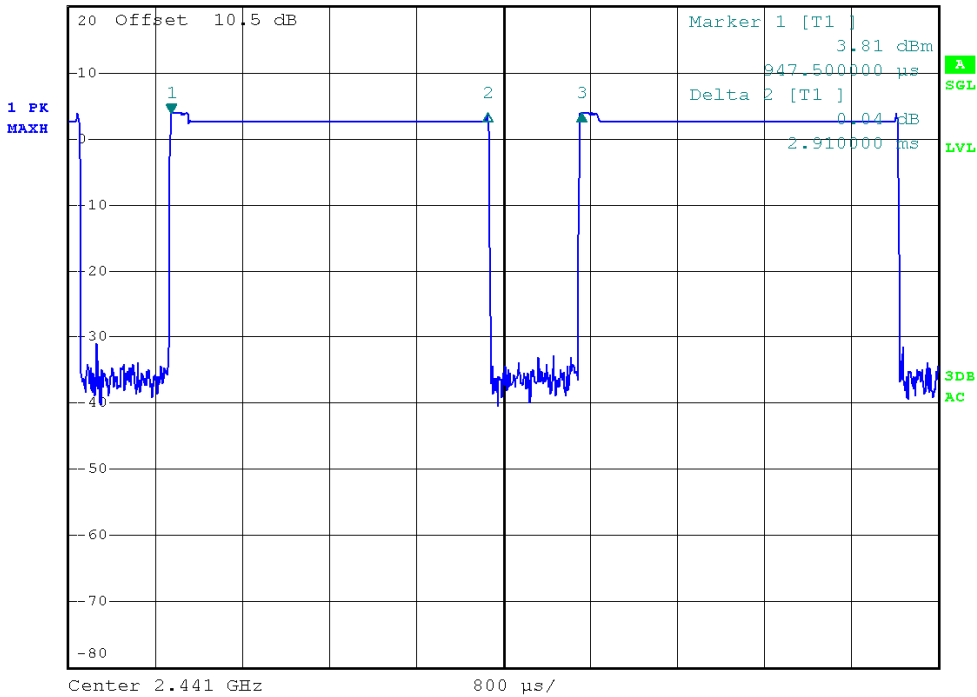

3DH1

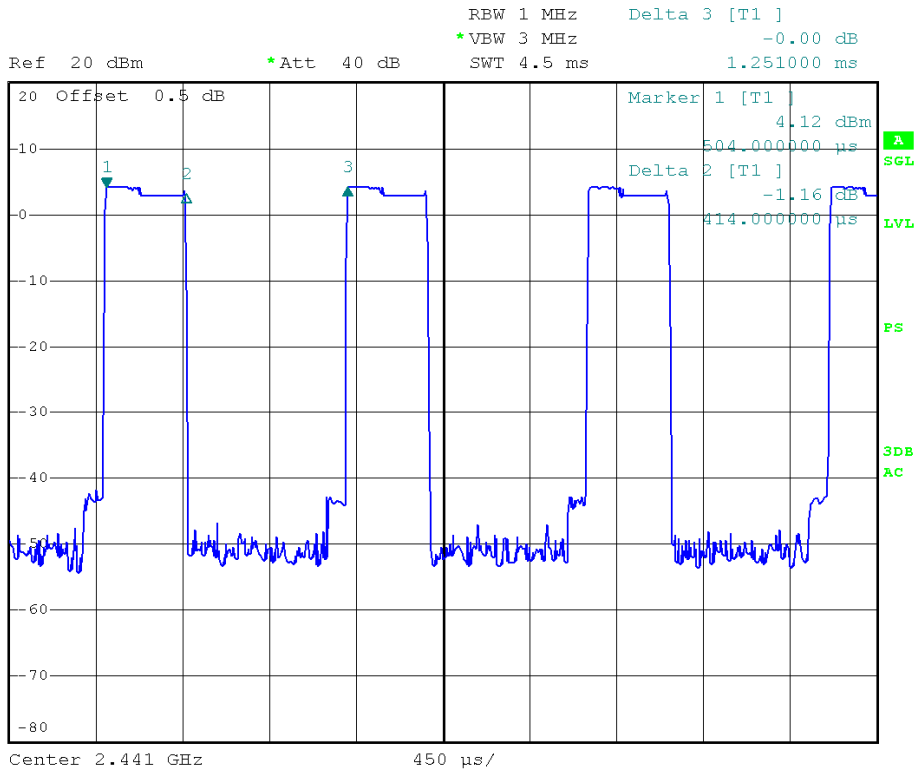

3DH3

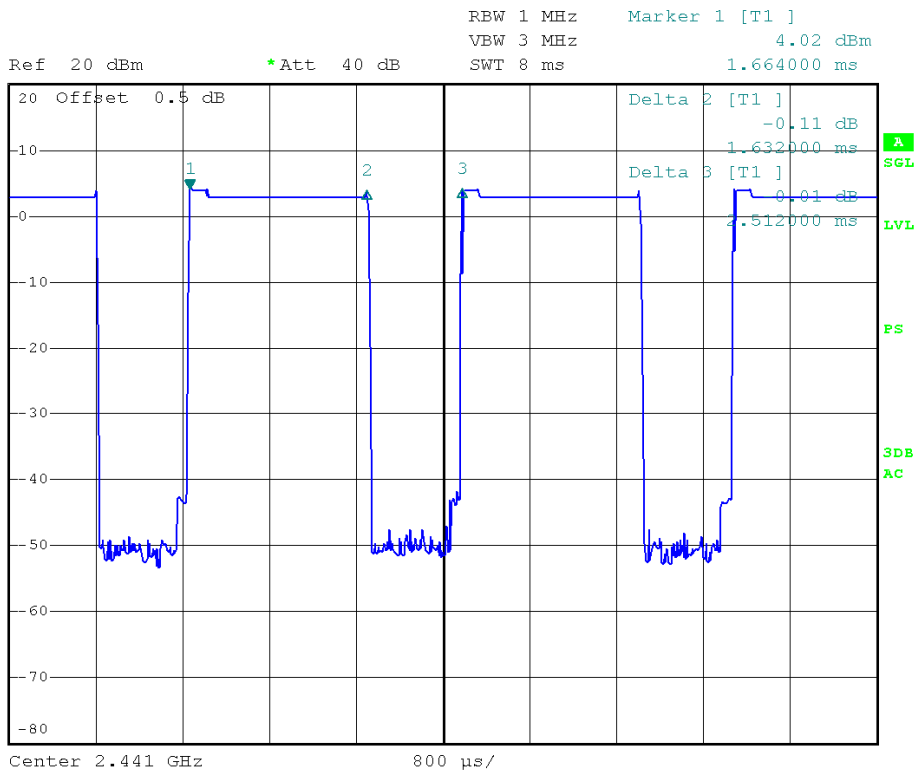

3DH5



RBW 1 MHz Delta 3 [T1]
VBW 3 MHz -0.28 dB
SWT 8 ms 3.760000 ms

Ref 20 dBm *Att 40 dB

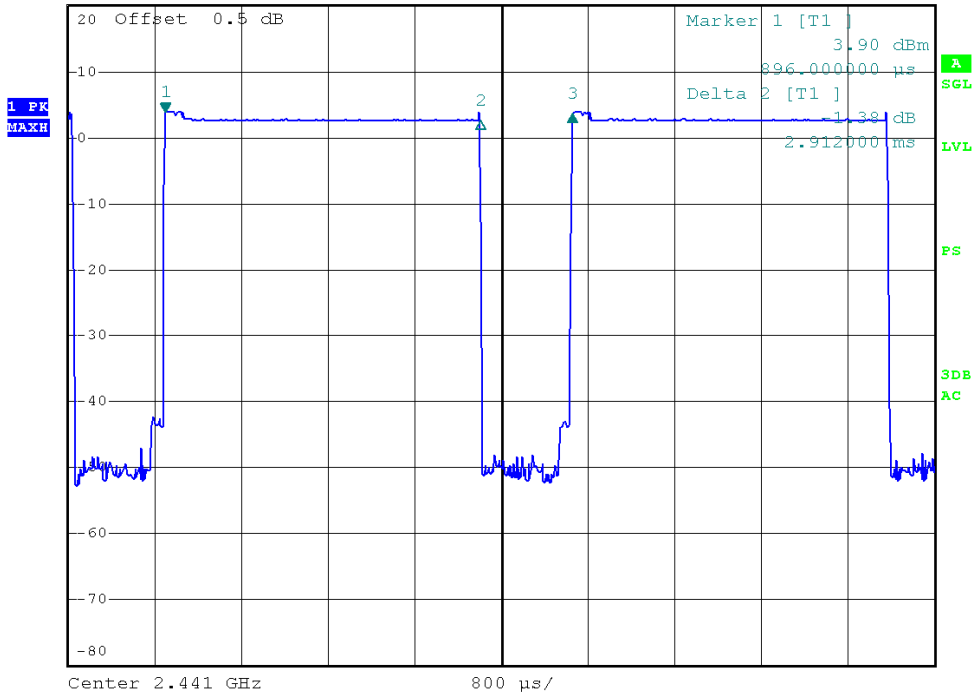

3. Highest channel (2.480GHz)

DH1

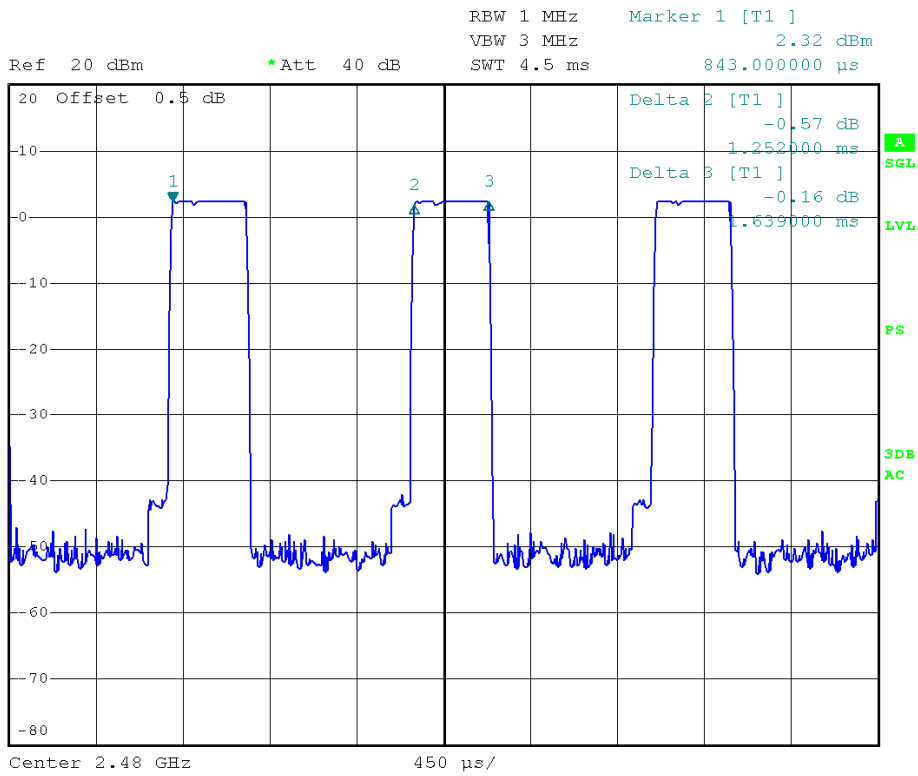

DH3

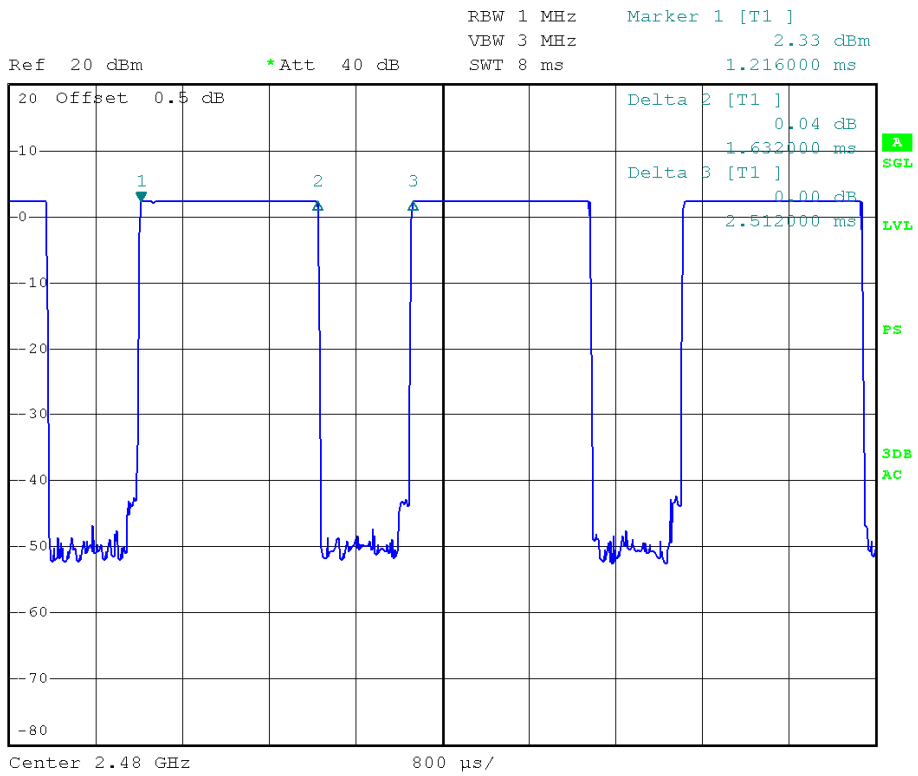

DH5



RBW 1 MHz Marker 1 [T1]
VBW 3 MHz 2.33 dBm
SWT 8 ms 576.000000 μ s

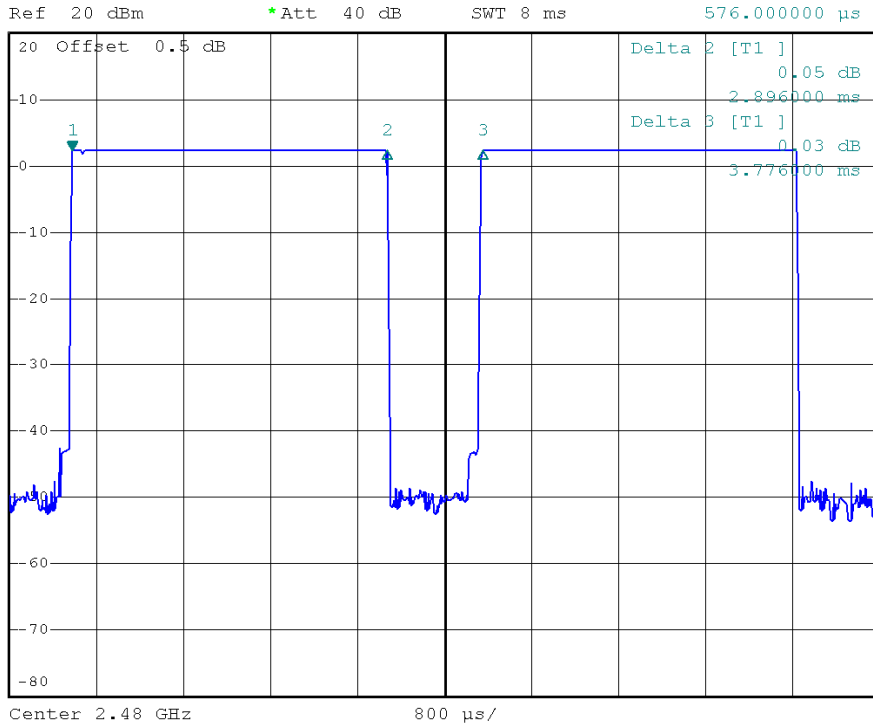

2DH1



RBW 1 MHz Marker 1 [T1]
VBW 3 MHz 2.27 dBm
SWT 4.5 ms 630.000000 μ s

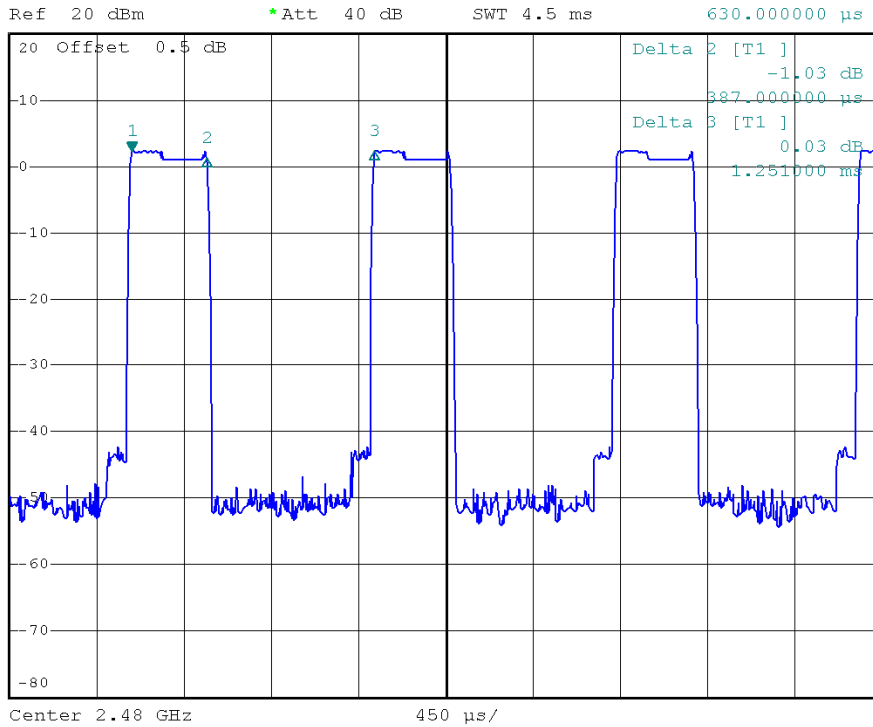

2DH3

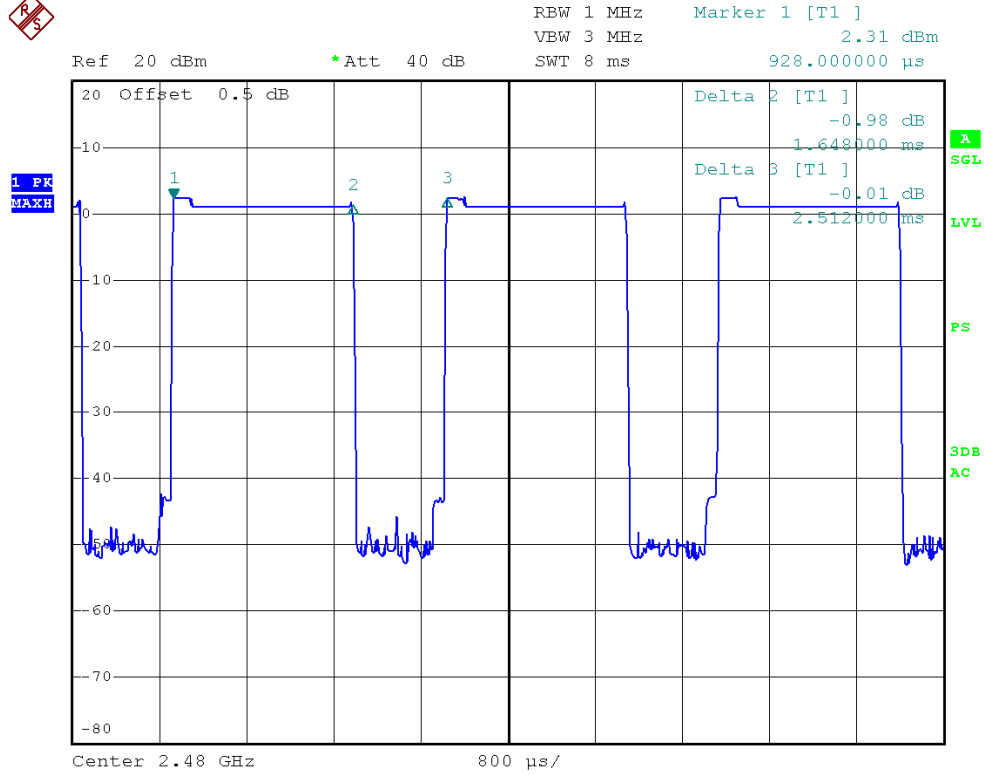

2DH5

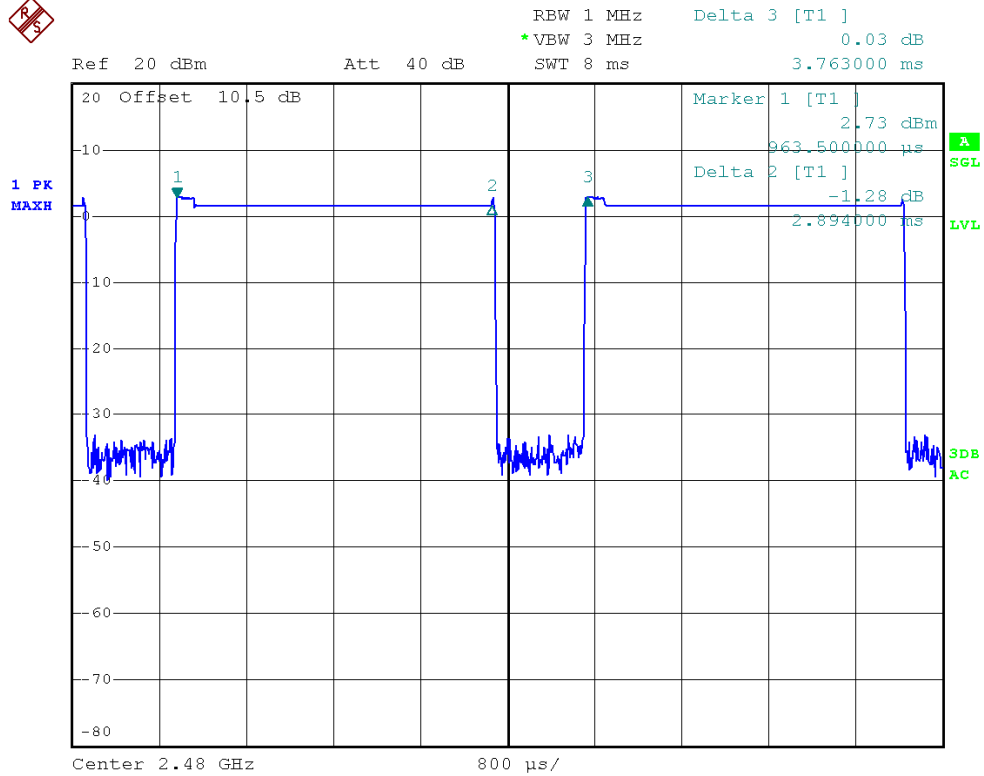

3DH1

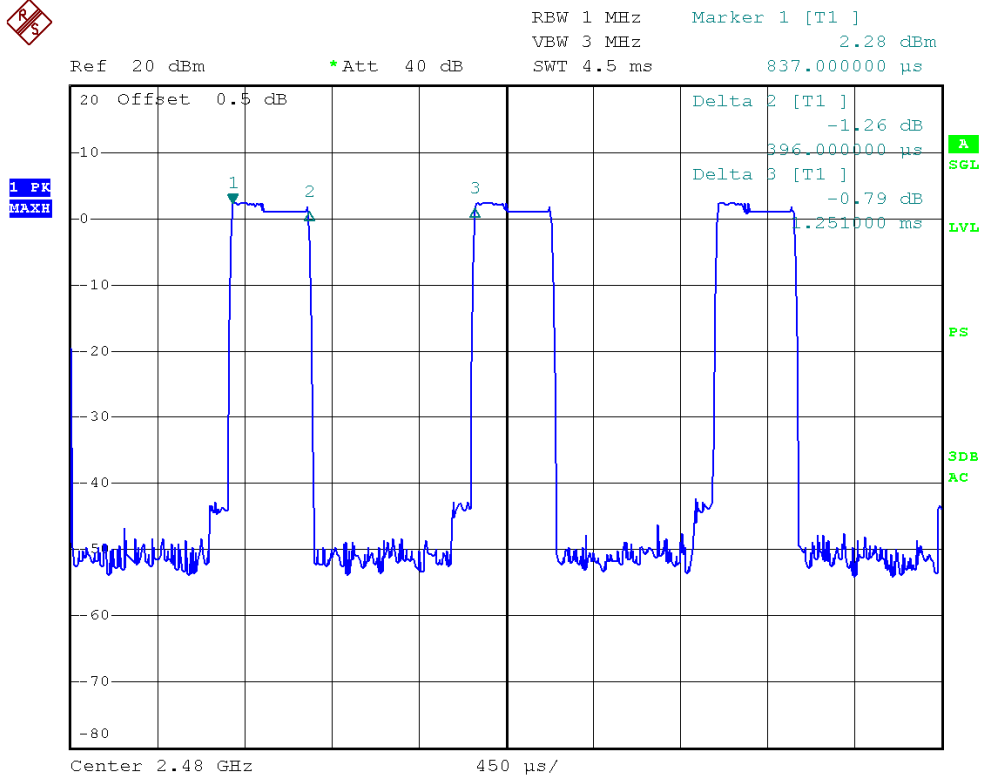

3DH3

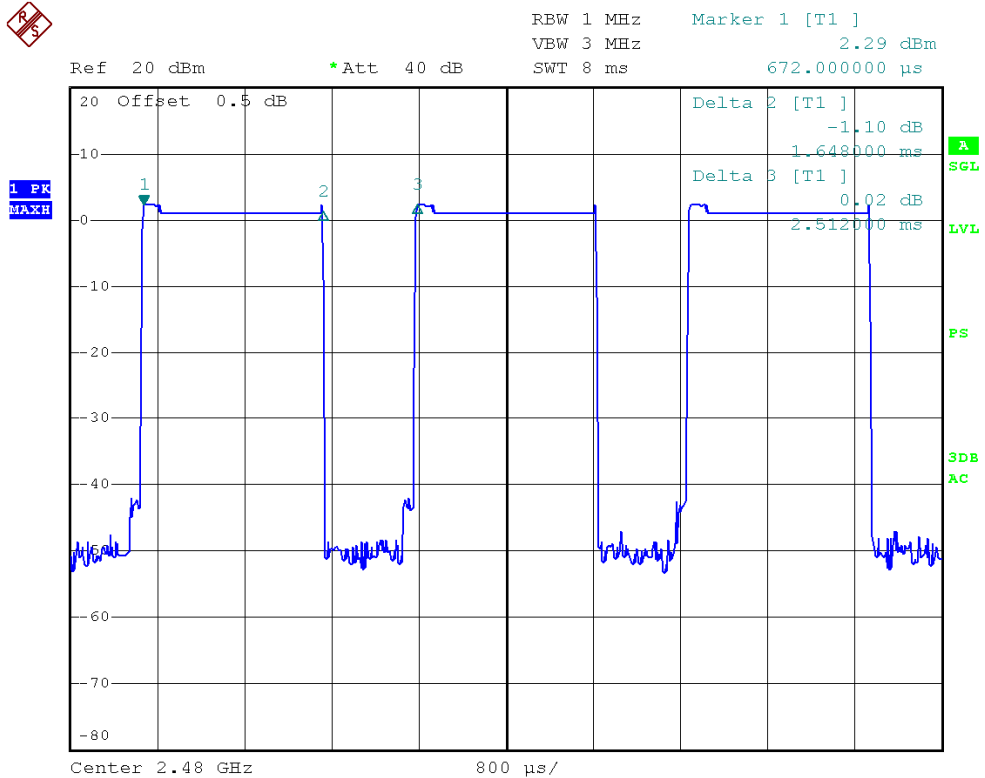

3DH5



RBW 1 MHz Marker 1 [T1]
VBW 3 MHz 2.34 dBm
SWT 8 ms 1.360000 ms

Ref 20 dBm

*Att 40 dB

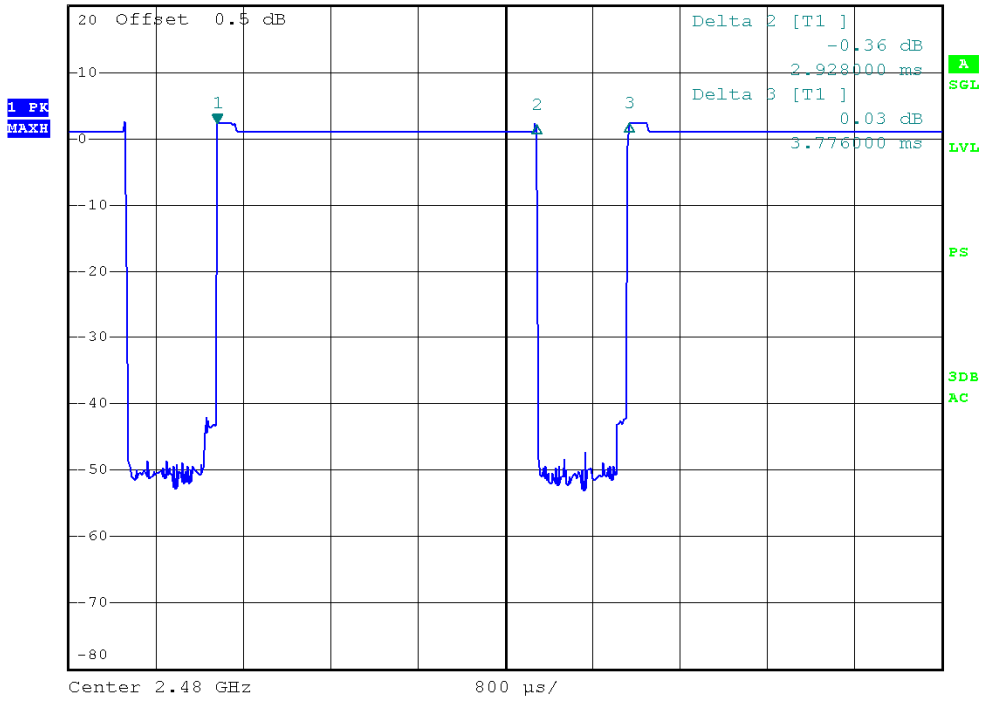

4.7 CONDUCTED EMISSION MEASUREMENT

4.7.1 LIMITS

| Frequency range | Limits (dB μ V) | |
|-----------------|---------------------|---------|
| | Quasi-peak | Average |
| 150kHz ~ 0.5MHz | 66~56 | 56~46 |
| 0.5 MHz ~ 5 MHz | 56 | 46 |
| 5 MHz ~ 30 MHz | 60 | 50 |

4.7.2 TEST PROCEDURES

Procedure of Preliminary Test

For measurement of the disturbance voltage the equipment under test (EUT) is connected to the power supply mains and any other extended network via one or more artificial network(s). An EUT, whether intended to be grounded or not, and which is to be used on a table is configured as follows:

- Either the bottom or the rear of the EUT shall be at a controlled distance of 40 cm from a reference ground plane. This ground plane is normally the wall or floor of a shielded room. It may also be a grounded metal plane of at least 2 m by 2 m. This is physically accomplished as follows:

- 1) place the EUT on a table of non-conducting material which is at least 80 cm high. Place the EUT so that it is 40 cm from the wall of the shielded room, or

- 2) place the EUT on a table of non-conducting material which is 40 cm high so that the bottom of the EUT is 40 cm above the ground plane;

- All other conductive surfaces of the EUT shall be at least 80 cm from the reference ground plane;

- The EUT are placed on the floor that one side of the housings is 40 cm from the vertical reference ground plane and other metallic parts;

- Interconnecting cables that hang closer than 40 cm to the ground plane shall be folded back and forth forming a bundle 30 cm to 40 cm long, hanging approximately in the middle between the ground plane and the table.

- I/O cables that are connected to a peripheral shall be bundled in the centre. The end of the cable may be terminated if required using correct terminating impedance. The total length shall not exceed 1 m.

The test mode(s) described in Item 2.4 were scanned during the preliminary test. After the preliminary scan, we found the test mode described in Item 2.4 producing the highest emission level. The EUT configuration and cable configuration of the above highest emission levels were recorded for reference of the final test.

Procedure of Final Test

EUT and support equipment were set up on the test bench as per the configuration with highest emission level in the preliminary test. A scan was taken on both power lines, recording at least the six highest emissions. Emission frequency and amplitude were recorded into a computer in which correction factors were used to calculate the emission level and compare reading to the applicable limit. The test data of the worst-case condition(s) was recorded.

4.7.3 TEST SETUP

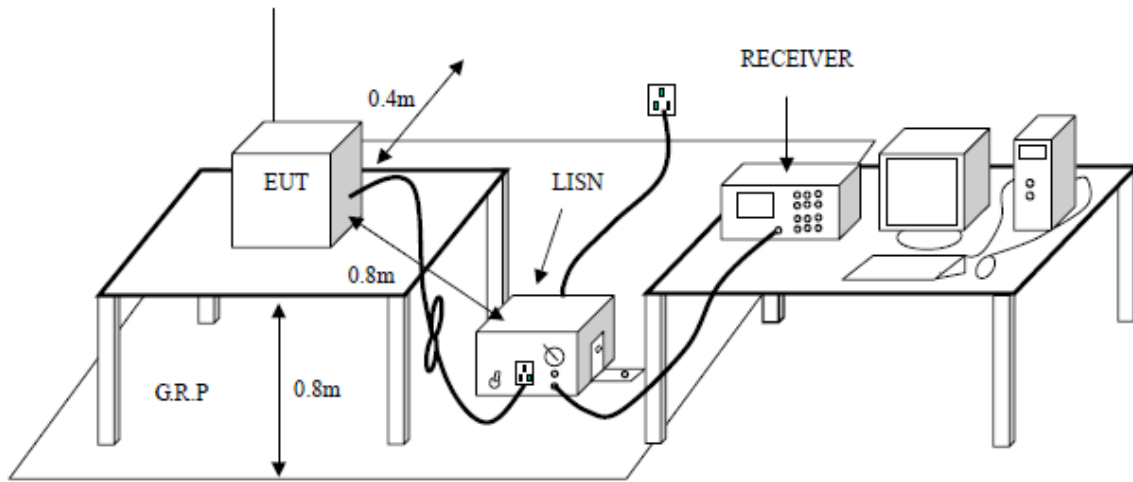

4.7.4 TEST RESULTS

| | | | |
|-------------------------|-----------------------------------|----------------------|---------------------|
| Project No.: | ZJ00029362 | Probe: | L1 |
| Standard: | (CE)FCC PART 15 class B_QP | Power Source: | AC 120V/60Hz |
| Test item: | Conduction Test | Date: | 2013-6-8 |
| Temp./Hum.(%RH): | 23/61%RH | Time: | 23:11:26 |
| EUT: | Blu-RAY DISC SYSTEM | Test Result: | Pass |
| Model: | BDS580 | | |
| Note: | BT Transmitting | | |

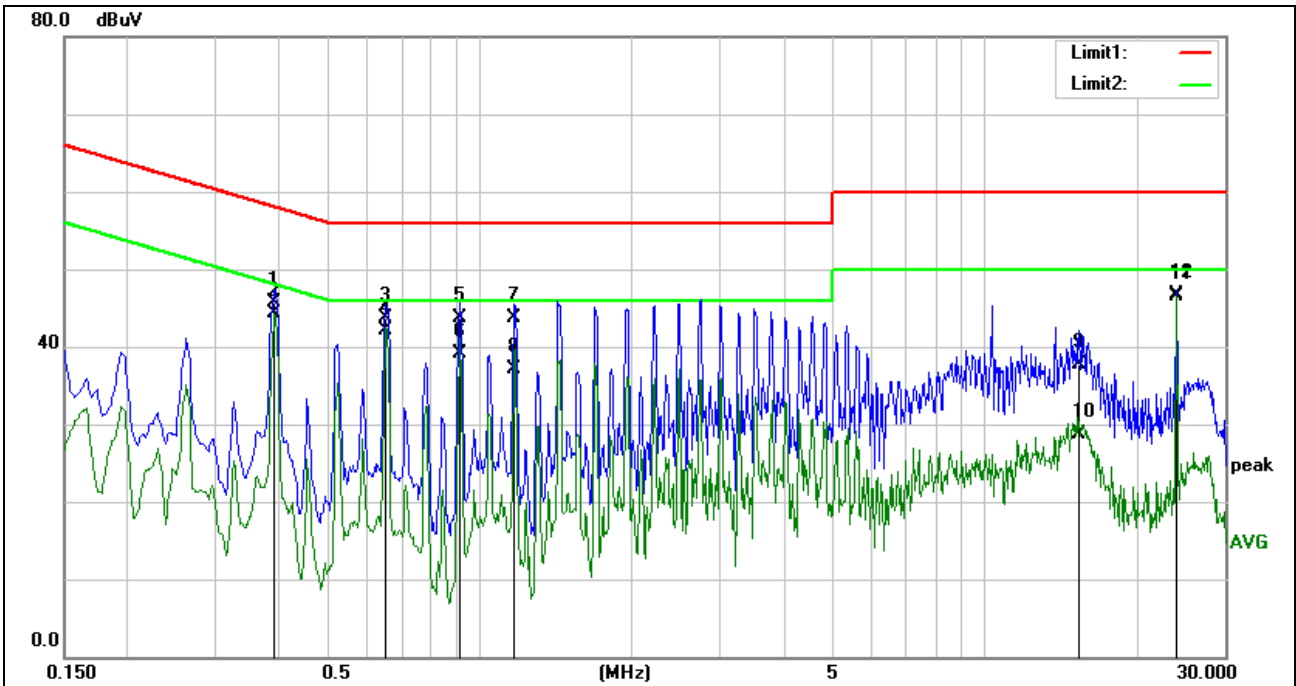

| No. | Frequency (MHz) | Reading (dBuV) | Correct Factor(dB) | Result (dBuV) | Limit (dBuV) | Margin (dB) | Remark |
|-----|-----------------|----------------|--------------------|---------------|--------------|-------------|--------|
| 1 | 0.3905 | 42.12 | 3.51 | 45.63 | 58.05 | -12.42 | QP |
| 2 | 0.3905 | 40.85 | 3.51 | 44.36 | 48.05 | -3.69 | AVG |
| 3 | 0.6530 | 40.32 | 3.48 | 43.80 | 56.00 | -12.20 | QP |
| 4 | 0.6530 | 38.54 | 3.48 | 42.02 | 46.00 | -3.98 | AVG |
| 5 | 0.9111 | 40.26 | 3.46 | 43.72 | 56.00 | -12.28 | QP |
| 6 | 0.9111 | 35.56 | 3.46 | 39.02 | 46.00 | -6.98 | AVG |
| 7 | 1.1703 | 40.17 | 3.52 | 43.69 | 56.00 | -12.31 | QP |
| 8 | 1.1703 | 33.56 | 3.52 | 37.08 | 46.00 | -8.92 | AVG |
| 9 | 15.3958 | 33.79 | 3.88 | 37.67 | 60.00 | -22.33 | QP |
| 10 | 15.3958 | 24.79 | 3.88 | 28.67 | 50.00 | -21.33 | AVG |
| 11 | 24.0416 | 42.63 | 3.93 | 46.56 | 60.00 | -13.44 | QP |
| 12 | 24.0416 | 42.68 | 3.93 | 46.61 | 50.00 | -3.39 | AVG |

| | | | |
|-------------------------|-----------------------------------|----------------------|---------------------|
| Project No.: | ZJ00029362 | Probe: | N |
| Standard: | (CE)FCC PART 15 class B_QP | Power Source: | AC 120V/60Hz |
| Test item: | Conduction Test | Date: | 2013-6-8 |
| Temp./Hum.(%RH): | 23/61%RH | Time: | 23:16:17 |
| EUT: | Blu-RAY DISC SYSTEM | Test Result: | Pass |
| Model: | BDS580 | | |
| Note: | BT Transmitting | | |

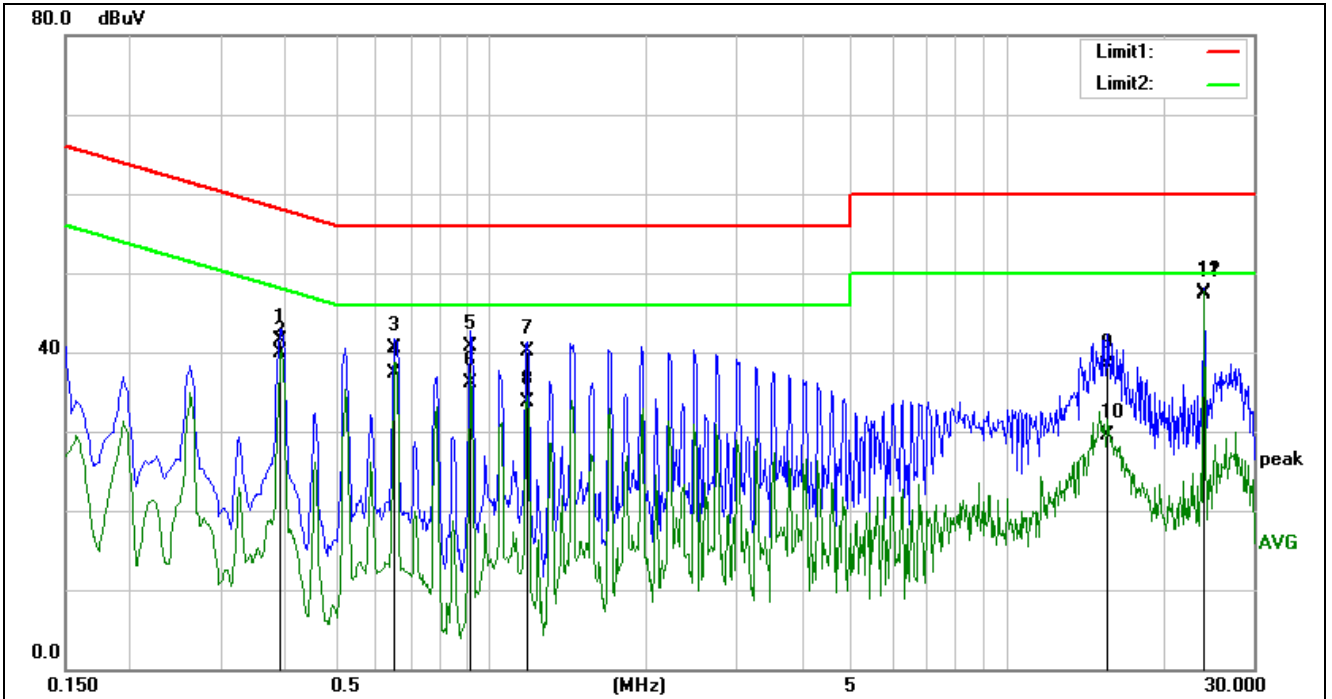

| No. | Frequency (MHz) | Reading (dBuV) | Correct Factor(dB) | Result (dBuV) | Limit (dBuV) | Margin (dB) | Remark |
|-----|-----------------|----------------|--------------------|---------------|--------------|-------------|--------|
| 1 | 0.3913 | 37.95 | 3.51 | 41.46 | 58.03 | -16.57 | QP |
| 2 | 0.3913 | 36.41 | 3.51 | 39.92 | 48.03 | -8.11 | AVG |
| 3 | 0.6515 | 37.07 | 3.48 | 40.55 | 56.00 | -15.45 | QP |
| 4 | 0.6515 | 33.78 | 3.48 | 37.26 | 46.00 | -8.74 | AVG |
| 5 | 0.9132 | 37.18 | 3.46 | 40.64 | 56.00 | -15.36 | QP |
| 6 | 0.9132 | 32.74 | 3.46 | 36.20 | 46.00 | -9.80 | AVG |
| 7 | 1.1725 | 36.49 | 3.52 | 40.01 | 56.00 | -15.99 | QP |
| 8 | 1.1725 | 30.21 | 3.52 | 33.73 | 46.00 | -12.27 | AVG |
| 9 | 15.6387 | 34.54 | 3.85 | 38.39 | 60.00 | -21.61 | QP |
| 10 | 15.6387 | 25.75 | 3.85 | 29.60 | 50.00 | -20.40 | AVG |
| 11 | 24.0412 | 43.39 | 3.93 | 47.32 | 60.00 | -12.68 | QP |
| 12 | 24.0412 | 43.57 | 3.93 | 47.50 | 50.00 | -2.50 | AVG |

4.8 MAXIMUM PEAK OUTPUT POWER

4.8.1 LIMITS

Regulation 15.247 (b)(1) For frequency hopping systems operating in the 2400-2483.5 MHz band employing at least 75 non-overlapping hopping channels, and all frequency hopping systems in the 5725-5850 MHz band: 1 watt. For all other frequency hopping systems in the 2400-2483.5 MHz band: 0.125 watts. Refer to the result “Hopping channel number” of this document. The 1 watt (30.0dBm) limit applies.

4.8.2 TEST PROCEDURES

1. Remove the antenna from the EUT and then connect a low RF cable from the antenna port to the spectrum.
2. Set the spectrum analyzer: RBW = 3 MHz. VBW = 3 MHz. Sweep = auto; Detector Function = Peak.
3. Keep the EUT in transmitting at lowest, medium and highest channel individually. Record the max value.

Remark:

1. Pre-test the 3 modulation to find GFSK and 8DPSK is worse case, so only record GFSK and 8DPSK test data.
2. Cable loss = 1dB, the receiver offset loss 1dB

4.8.3 TEST SETUP

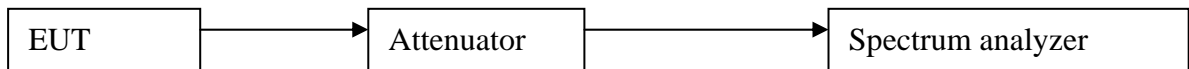

4.8.4 TEST RESULTS

For GFSK:

| Test Channel | Fundamental Frequency (GHz) | Max Output Power(dBm) | Antenna Gain(dBi) | e. r.p. (dBm) | Limit (dBm) | Pass/Fail |
|--------------|-----------------------------|-----------------------|-------------------|---------------|-------------|-----------|
| Lowest | 2.402 | 6.85 | 2 | 8.85 | 30.0 | Pass |
| Middle | 2.441 | 6.43 | 2 | 8.43 | 30.0 | Pass |
| Highest | 2.480 | 5.98 | 2 | 7.98 | 30.0 | Pass |

For 8DPSK:

| Test Channel | Fundamental Frequency (GHz) | Max Output Power(dBm) | Antenna Gain(dBi) | e. r.p. (dBm) | Limit (dBm) | Pass/Fail |
|--------------|-----------------------------|-----------------------|-------------------|---------------|-------------|-----------|
| Lowest | 2.402 | 5.44 | 2 | 7.44 | 30.0 | Pass |
| Middle | 2.441 | 4.99 | 2 | 6.99 | 30.0 | Pass |
| Highest | 2.480 | 4.35 | 2 | 6.35 | 30.0 | Pass |

Test result: The unit does meet the FCC requirements.

Test result plot as follows:

GFSK Lowest Channel:

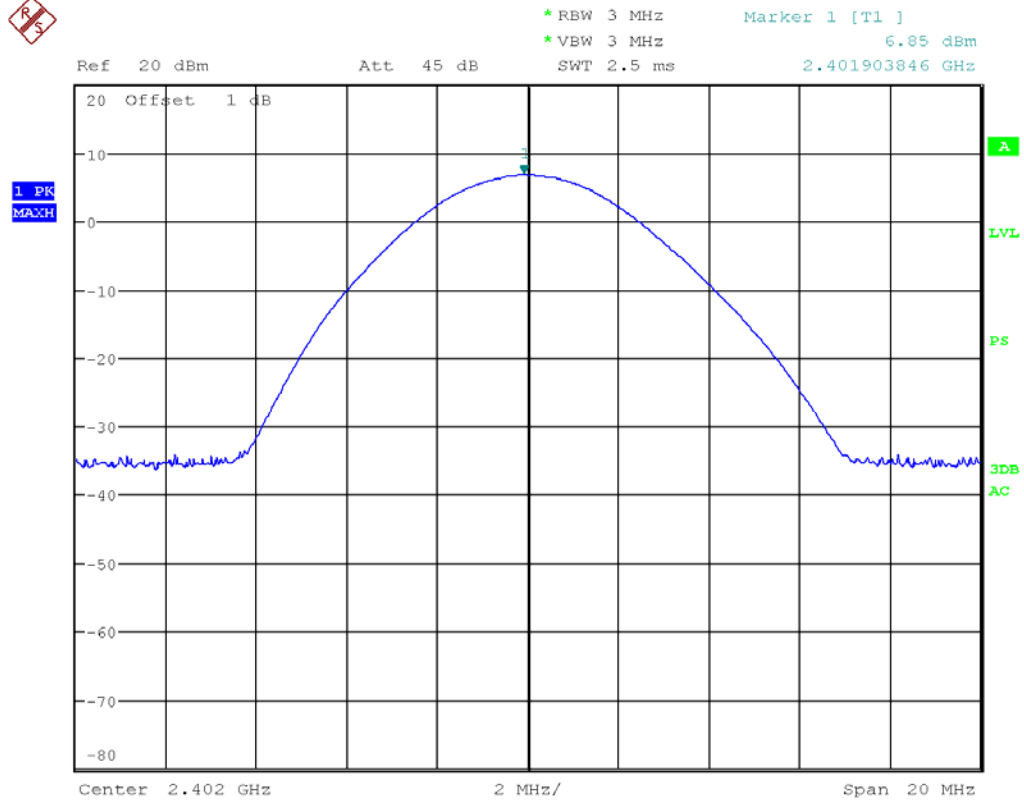

GFSK Middle Channel:

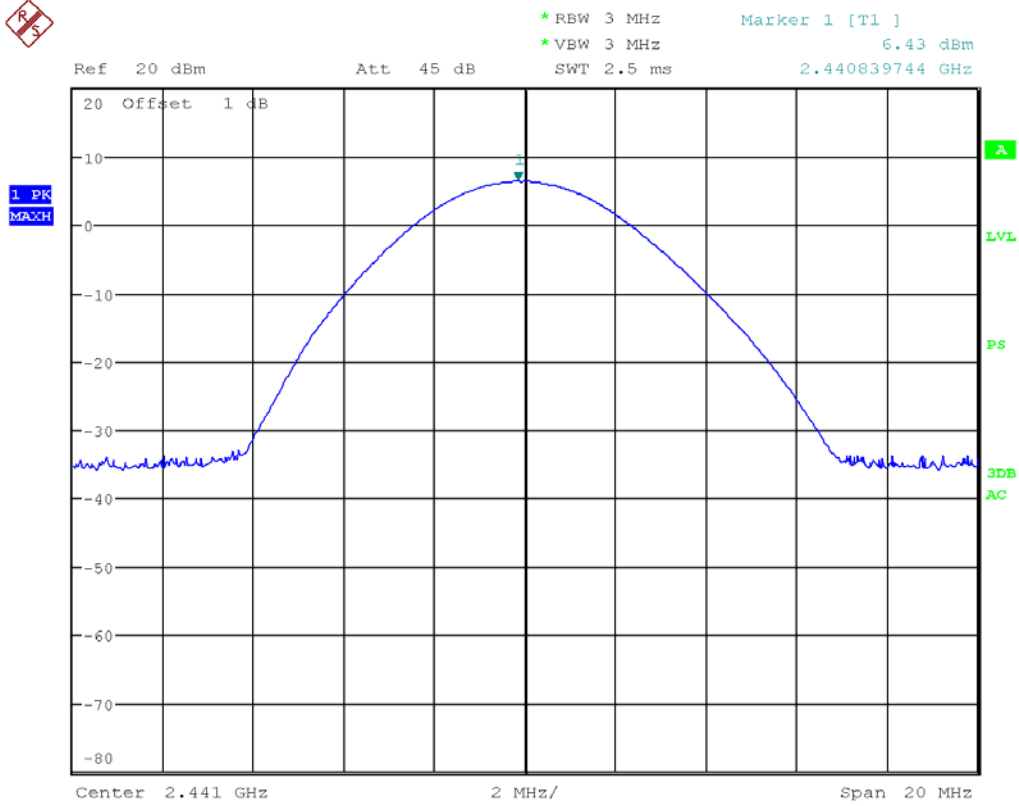

GFSK Highest Channel:

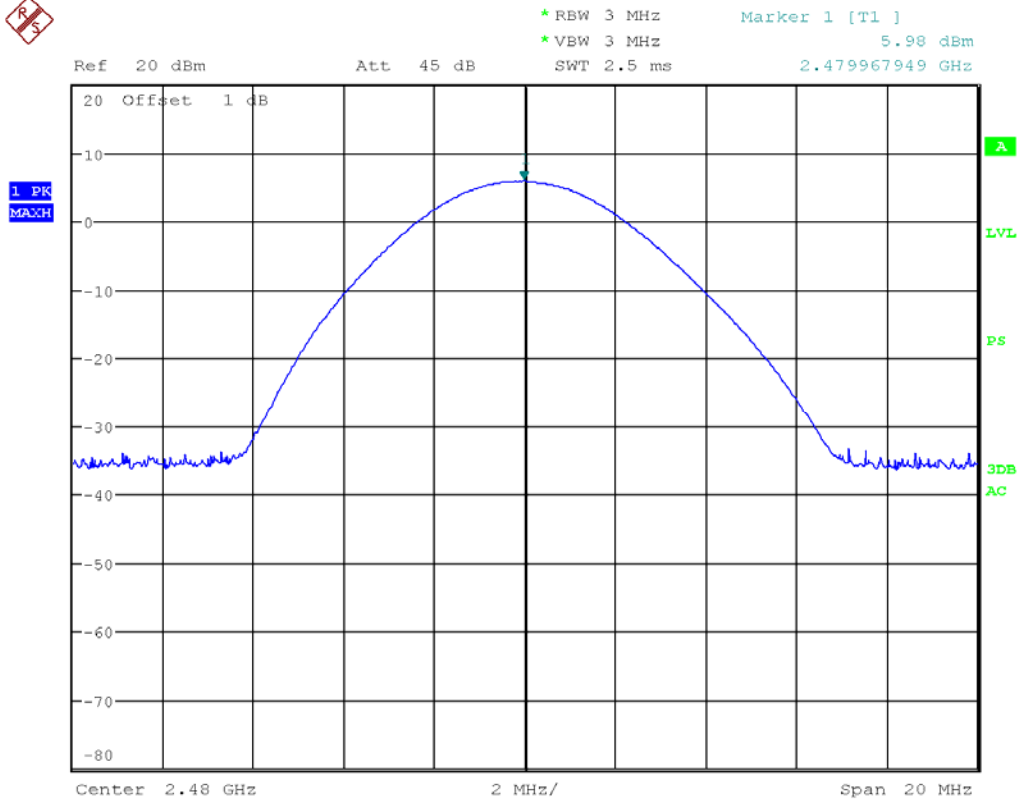

8DPSK Lowest Channel:

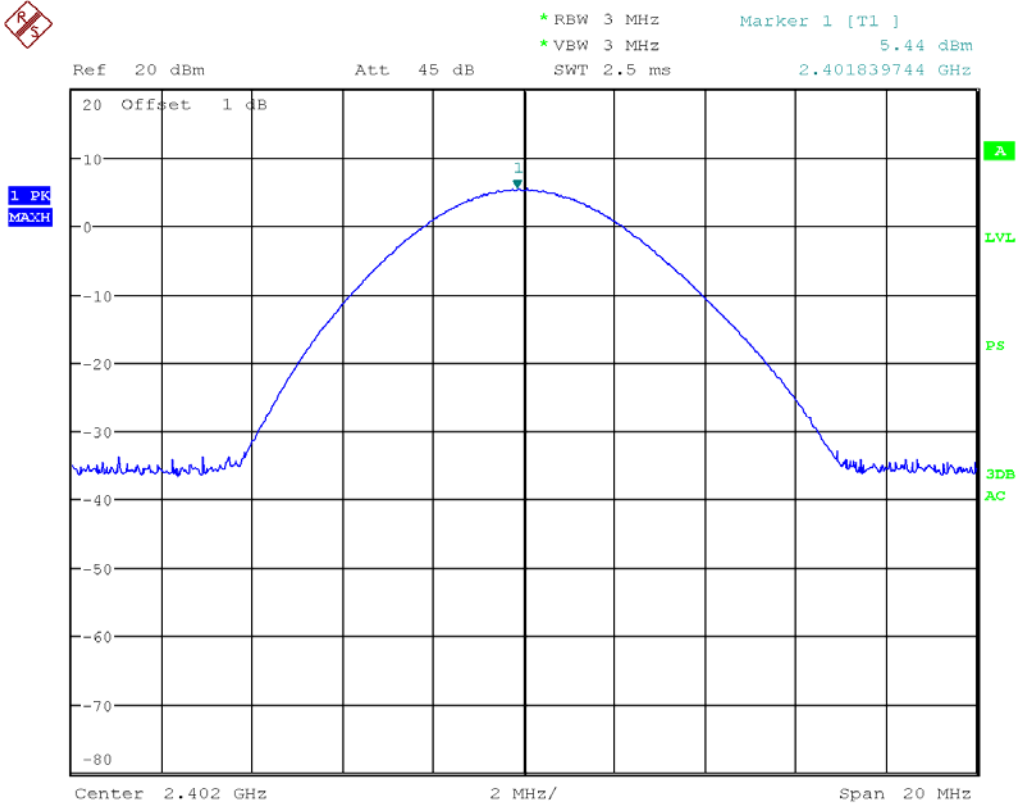

8DPSK Middle Channel:

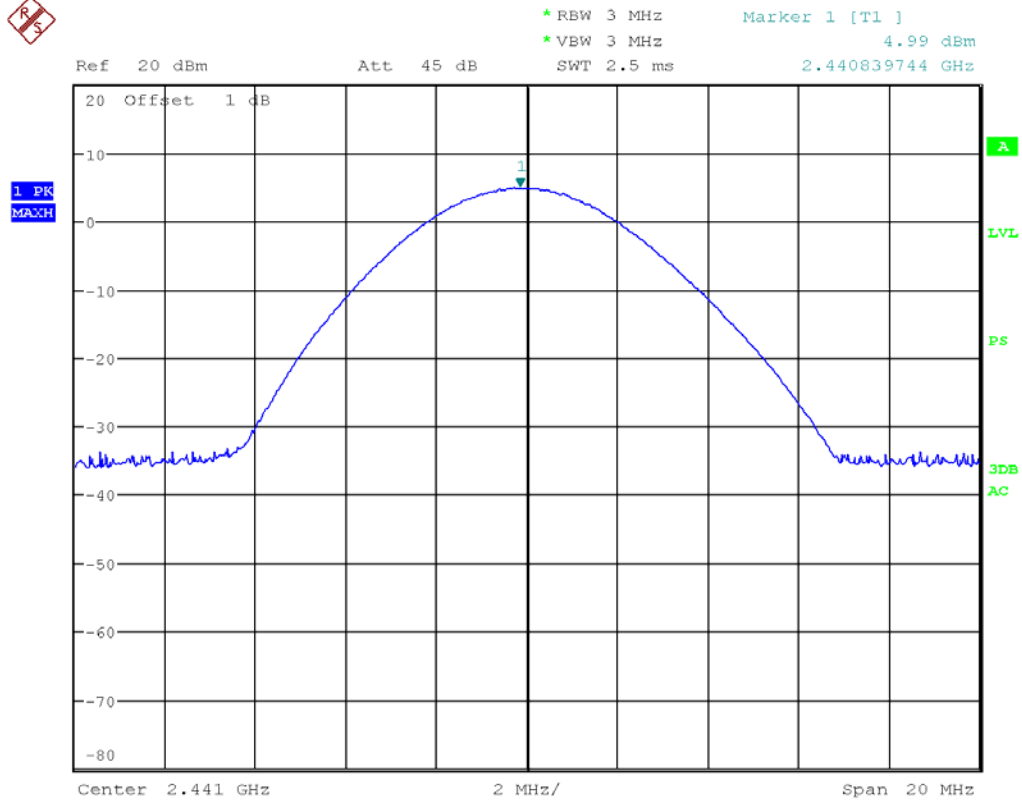

8DPSK Highest Channel:

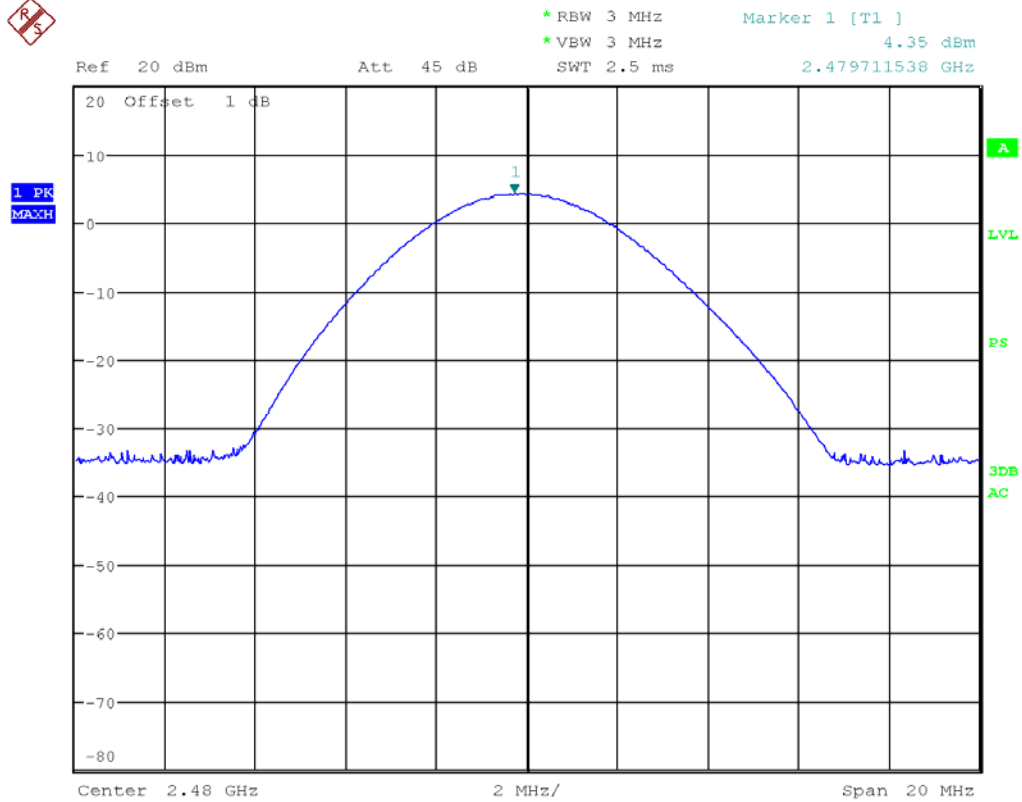

4.9 CONDUCTED SPURIOUS EMISSIONS

4.9.1 LIMITS

(d) In any 100 kHz bandwidth outside the frequency band in which the spread spectrum or digitally modulated intentional radiator is operating. The radio frequency power that is produced by the intentional radiator shall be at least 20 dB below that in the 100 kHz bandwidth within the band that contains the highest level of the desired power. based on either an RF conducted or a radiated measurement. Provided the transmitter demonstrates compliance with the peak conducted power limits.

4.9.2 TEST PROCEDURES

Remove the antenna from the EUT and then connect a low attenuation cable from the antenna port to the spectrum.

Below 1GHz Set the spectrum analyzer: RBW =100KHz VBW \geq RBW, Span = enough to catch the trace. Sweep = auto; Detector Function = Peak. Trace = Max,hold.

Above 1GHz Set the spectrum analyzer: RBW =1MHz VBW \geq RBW , Span = enough to catch the trace. Sweep = auto; Detector Function = Peak. Trace = Max,hold.

4.9.3 TEST SETUP



4.9.4 TEST RESULTS

The unit does meet the FCC requirements.

Test result plot as follows:

For GFSK

Lowest Channel:

30M to 1GHz

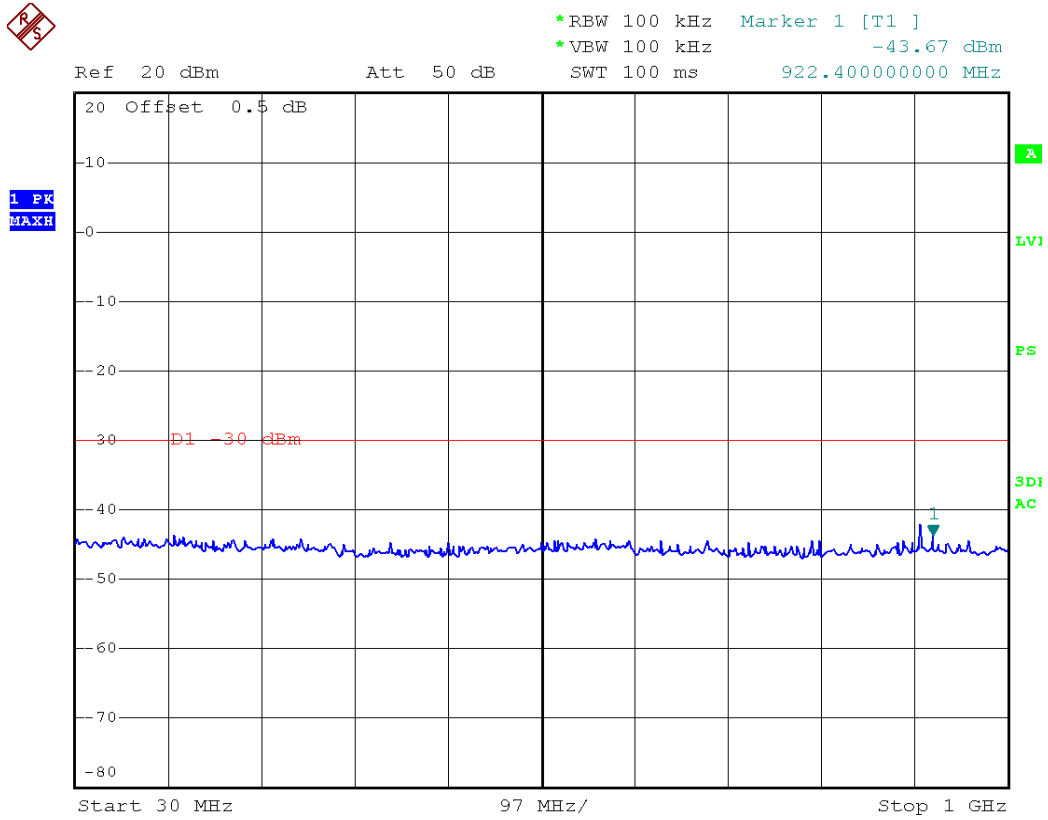

1G to 10GHz

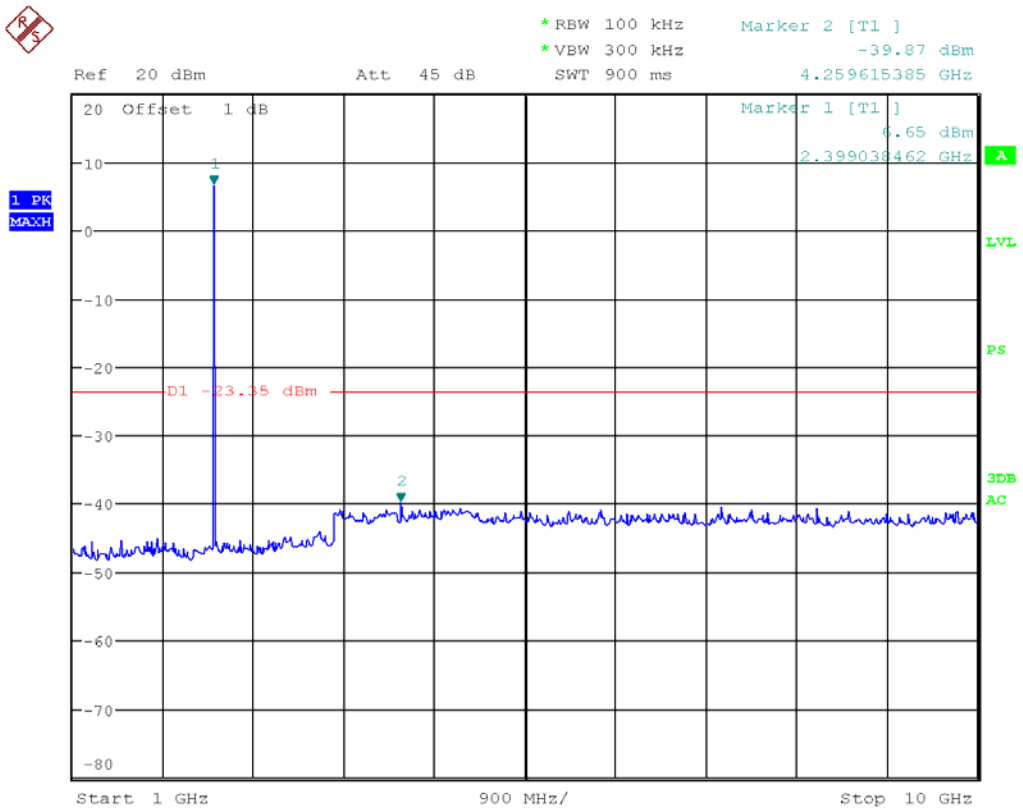

10G to 25GHz

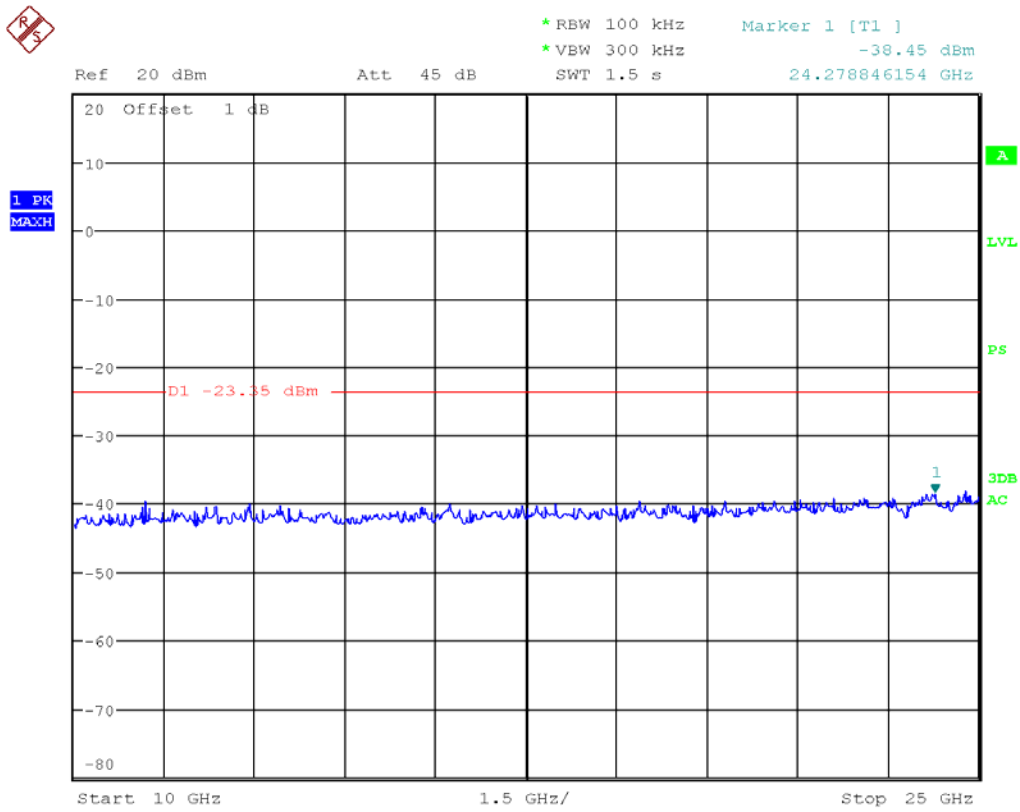

Middle Channel:

30M to 1GHz

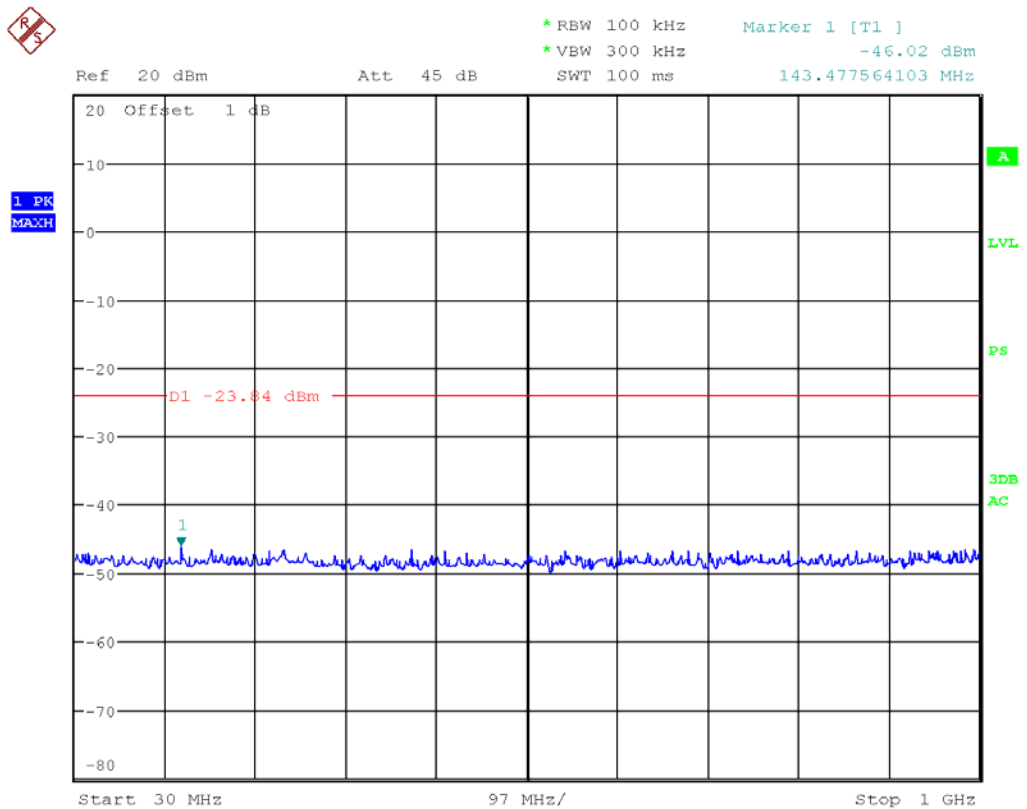

1G to 10GHz

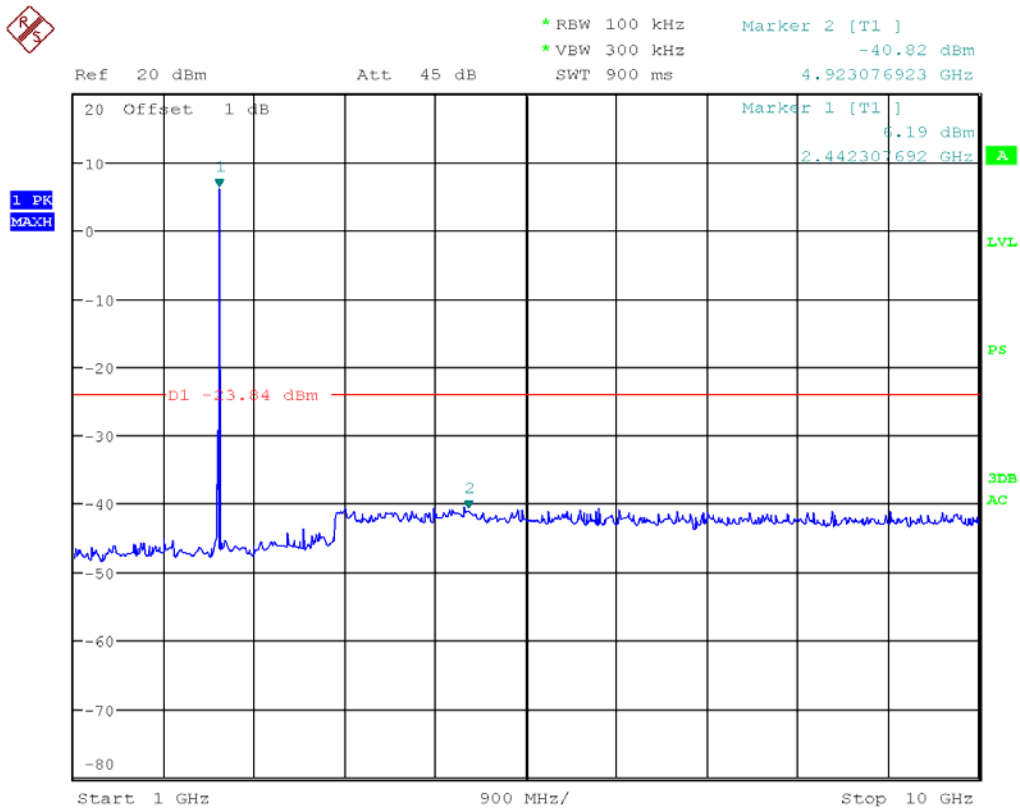

10G to 25GHz

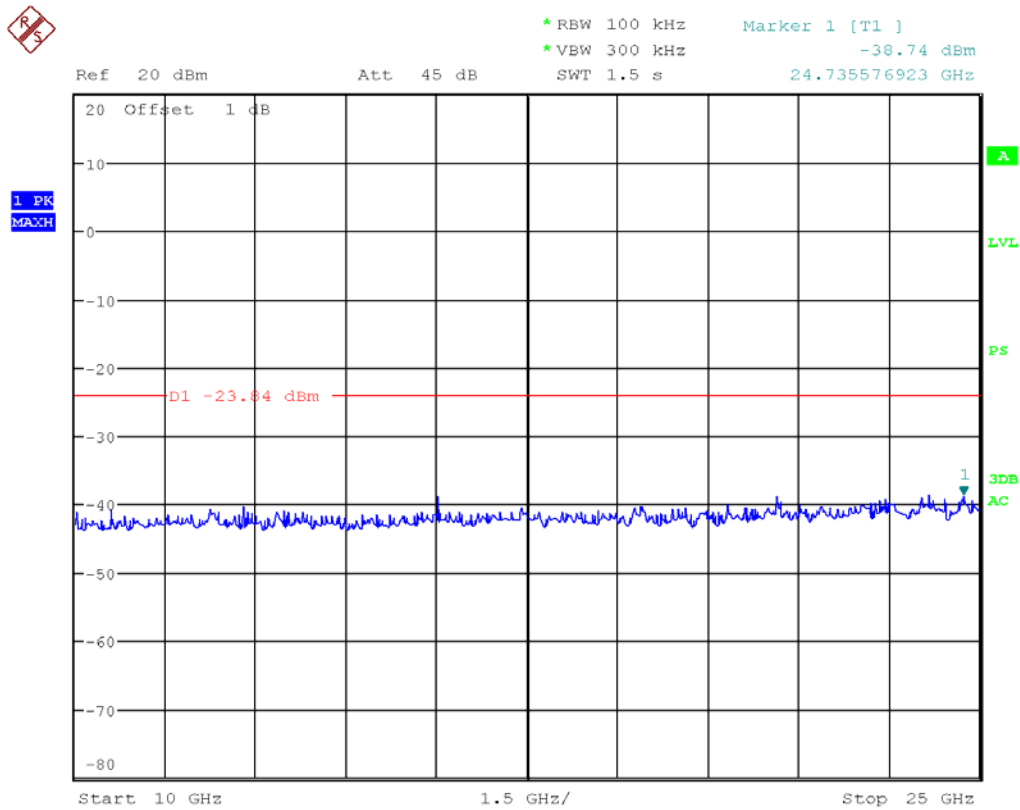

Highest Channel

30M to 1GHz

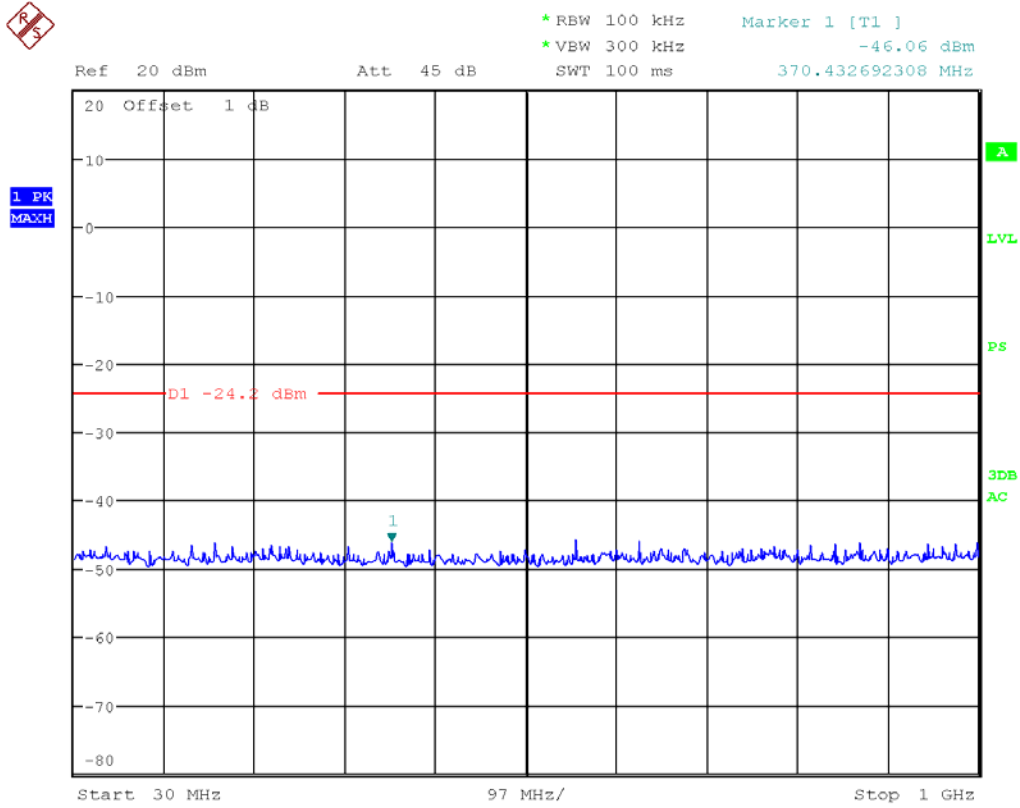

1G to 10GHz

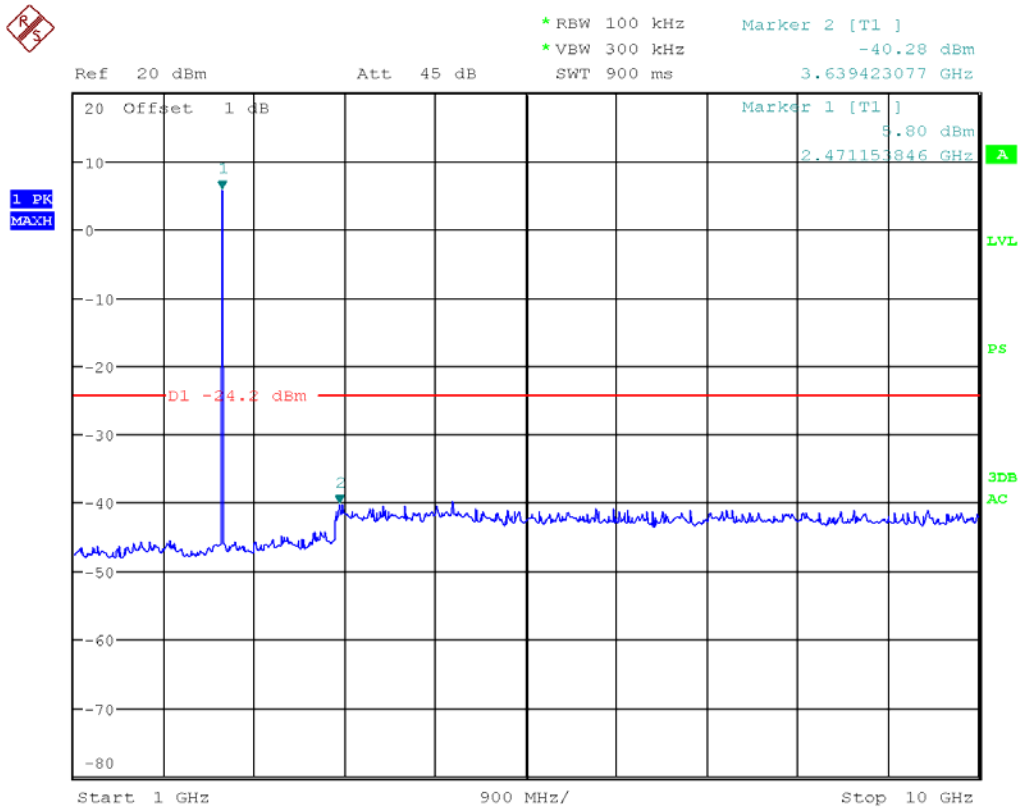

10G to 25GHz

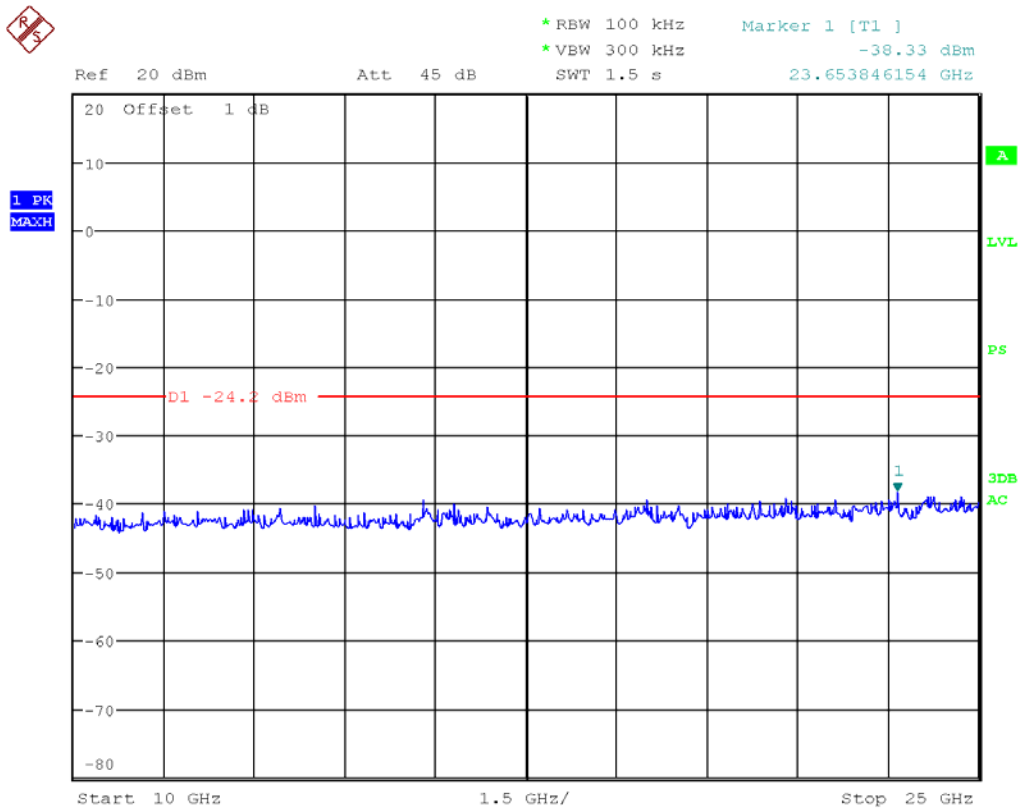

For 8DPSK

Lowest Channel:

30M to 1GHz

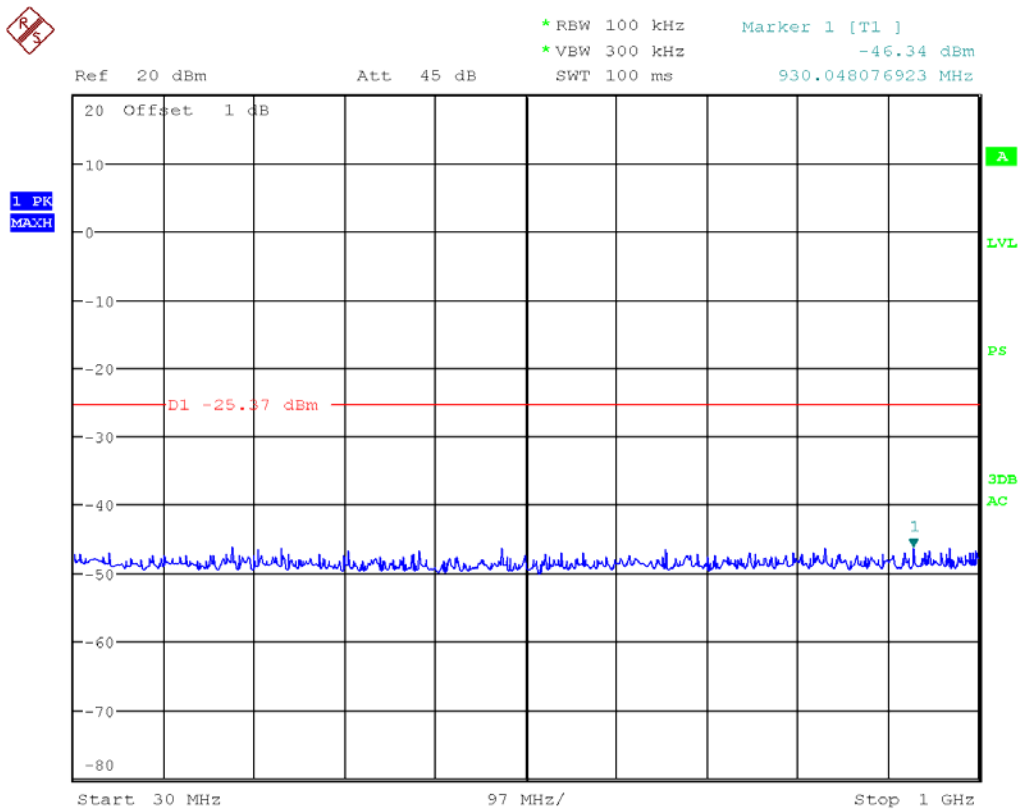

1G to 10GHz

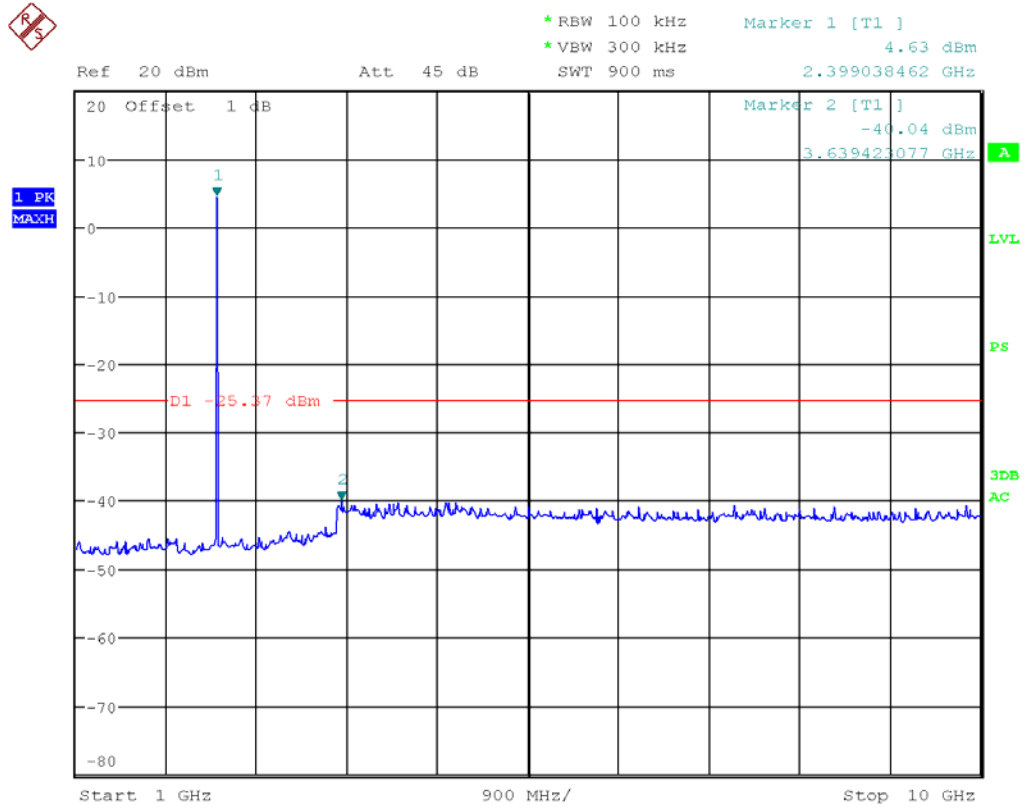

10G to 25GHz

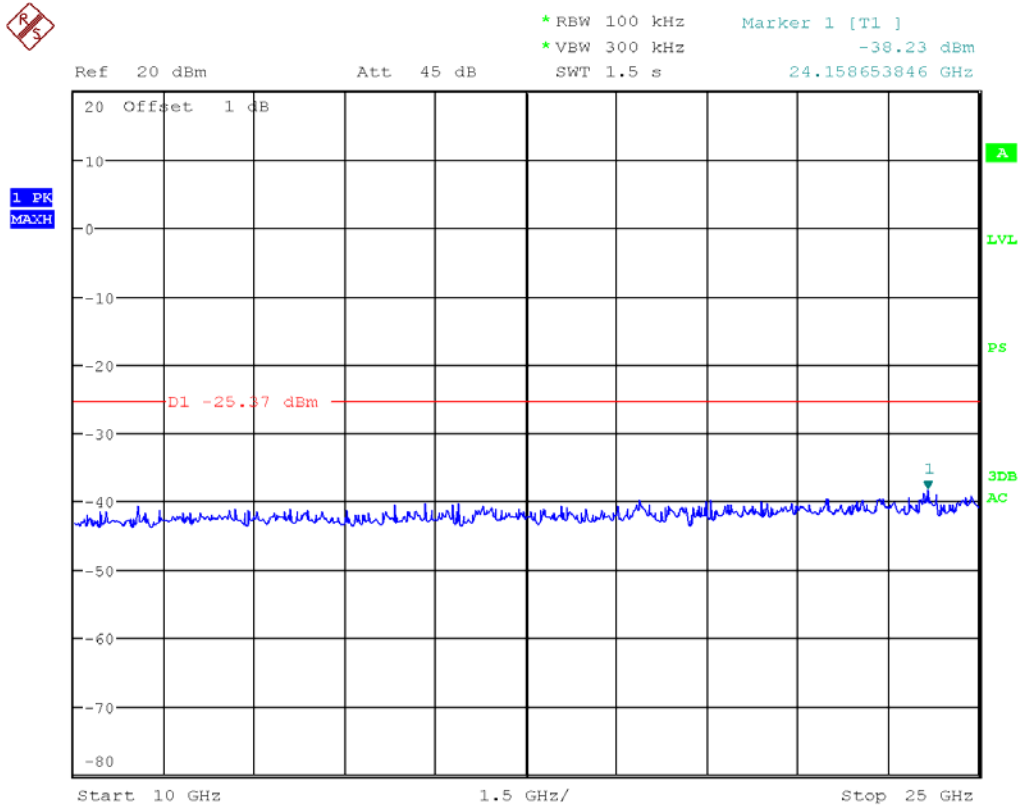

Middle Channel:

30M to 1GHz

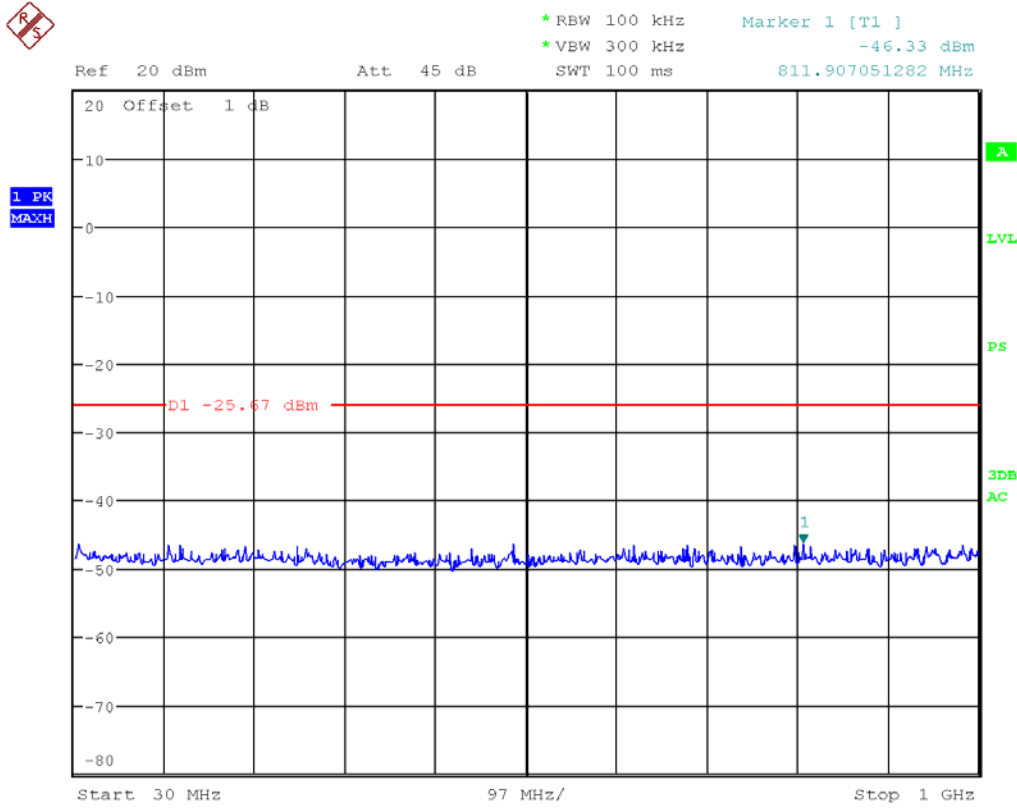

1G to 10GHz

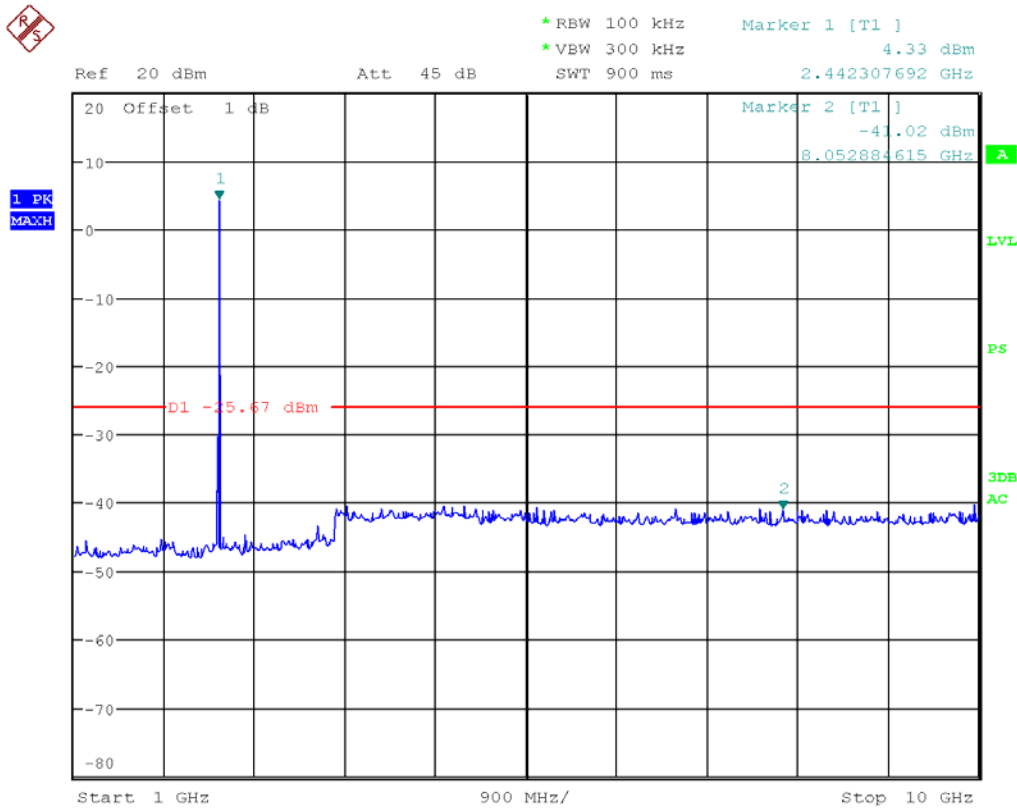

10G to 25GHz

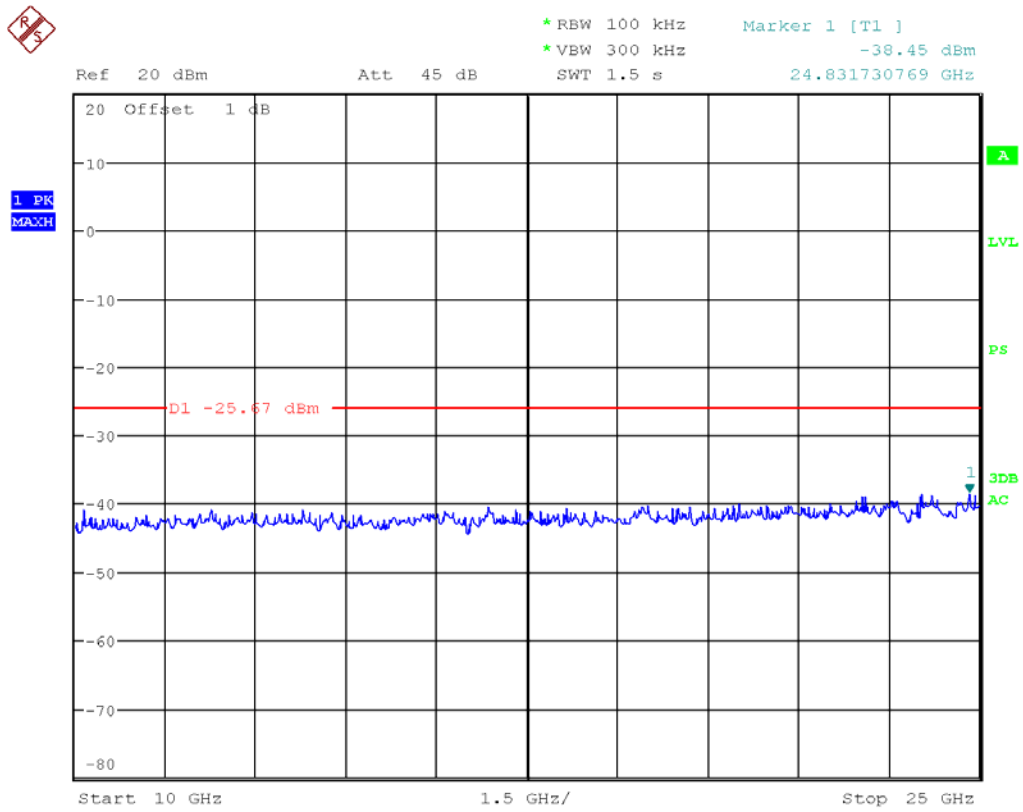

Highest Channel

30M to 1GHz

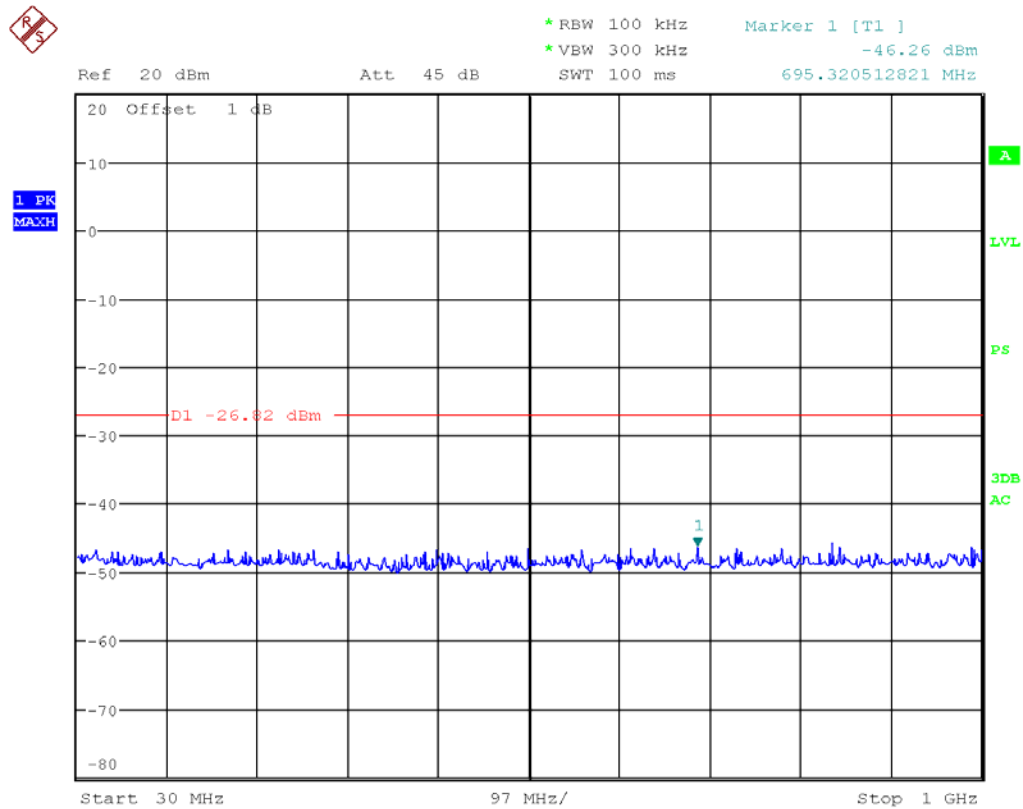

1G to 10GHz

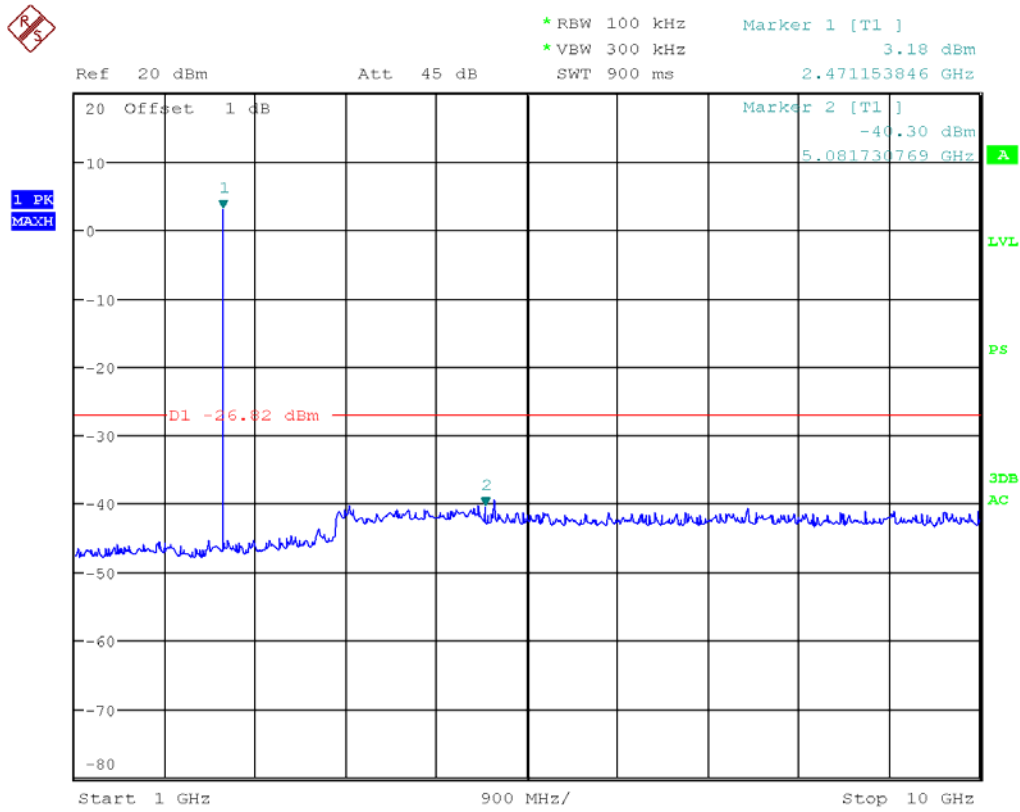

10G to 25GHz

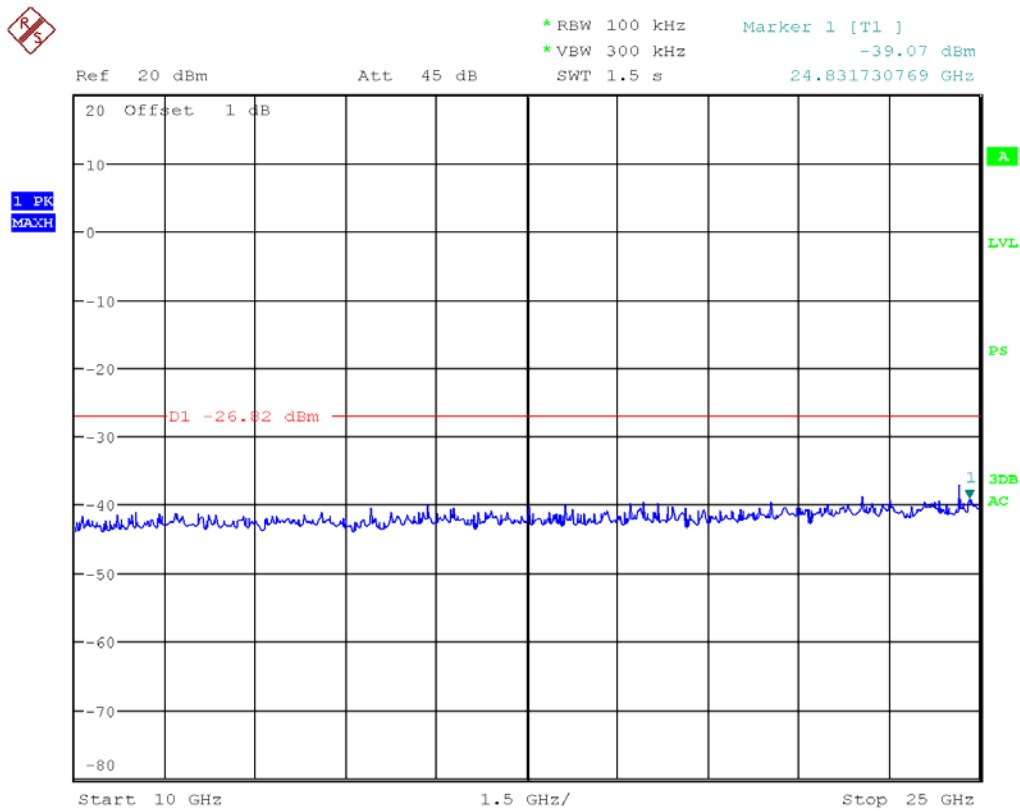

4.10 RADIATED SPURIOUS EMISSIONS

4.10.1 LIMITS

| Frequency (MHz) | Quasi-peak(dBμV/m) |
|-----------------|--------------------|
| 30 ~ 88 | 40 |
| 88~216 | 43.5 |
| 216 ~ 960 | 46 |
| Above 960 | 54 |

NOTE: (1) The lower limit shall apply at the transition frequencies.

| Frequency (GHz) | Quasi-peak(dBμV/m) |
|-----------------|--------------------|
| 1 ~ 26.5 | 74 |
| 1~ 26.5 | 54 |

4.10.2 TEST PROCEDURES

Procedure of Preliminary Test

According to ANSI C63.10:2009, a calibrated, linearly polarized antenna shall be positioned at the specified distance from the periphery of the EUT. The specified distance is the distance between the horizontal projection onto the ground plane of the closest periphery of the EUT and the projection onto the ground plane of the center of the axis of the elements of the receiving antenna.

Measurements shall be made with the antenna positioned in both the horizontal and vertical planes of polarization. The measurement antenna shall be varied in height above the reference ground plane to obtain the maximum signal strength. Unless otherwise specified, the measurement distance shall be 3 m. At any measurement distance, the antenna height shall be varied from 1 m to 4 m. These height scans apply for both horizontal and vertical polarizations, except that for vertical polarization, the minimum height of the center of the antenna shall be increased so that the lowest point of the bottom of the lowest antenna element clears the site reference ground plane by at least 25 cm. For a tuned dipole, the minimum heights as measured from the center of the antenna are those specified in the NSA measurement requirements.

For tabletop systems, cables or wires should be manipulated within the range of likely arrangements. For floor-standing equipment, the cables or wires should be located in the same manner as the user would install them and no further manipulation is made. For combination EUTs, the tabletop and floor-standing portions of the EUT shall follow the procedures for their respective setups and cable manipulation.

Table-top equipment is placed on a non-conductive set-up table with height $0,8\text{ m} \pm 0,01\text{ m}$, ANSI C63.10:2009 specifies the method to determine the impact of the non-conductive set-up table on test results. If the manner of cable installation is not known, or if it changes with each installation, cables or wires for floor-standing equipment shall be manipulated to the extent possible to produce the maximum level of emissions. For each mode of operation required to be tested, the frequency spectrum shall be monitored. Variations in antenna height between 1 m and 4 m, antenna polarization, EUT azimuth, and cable or wire placement shall be explored to produce the emission that has the highest amplitude relative to the limit.

Procedure of Final Test

EUT and support equipment were set up on the turntable as per the configuration with highest emission level in the preliminary test. The Analyzer / Receiver scanned from 30MHz to 1000MHz. Emissions were scanned and measured rotating the EUT to 360 degrees, varying cable placement

and positioning the antenna 1 to 4 meters above the ground plane, in both the vertical and the horizontal polarization, to maximize the emission reading level. Record at least six highest emissions. Emission frequency, amplitude, antenna position, polarization and turntable position were recorded into a computer in which correction factors were used to calculate the emission level and compare reading to the applicable limit and only QP reading is presented. The test data of the worst-case condition(s) was recorded.

Procedure of Final Test

EUT and support equipment were set up on the test bench as per the configuration with highest emission level in the preliminary test. A scan was taken on both power lines, recording at least the six highest emissions. Emission frequency and amplitude were recorded into a computer in which correction factors were used to calculate the emission level and compare reading to the applicable limit. The test data of the worst-case condition(s) was recorded.

Below 1GHz Set the spectrum analyzer: RBW =100KHz VBW \geq RBW , Span = enough to catch the trace. Sweep = auto; Detector Function = Peak. Trace = Max,hold.

Above 1GHz Set the spectrum analyzer: RBW =1MHz VBW \geq RBW , Span = enough to catch the trace. Sweep = auto; Detector Function = Peak. Trace = Max,hold.

Pre-test for normal mode and EDR mode, to find the EDR is the worst case.

The worst case emissions were reported.

4.10.3 TEST SETUP

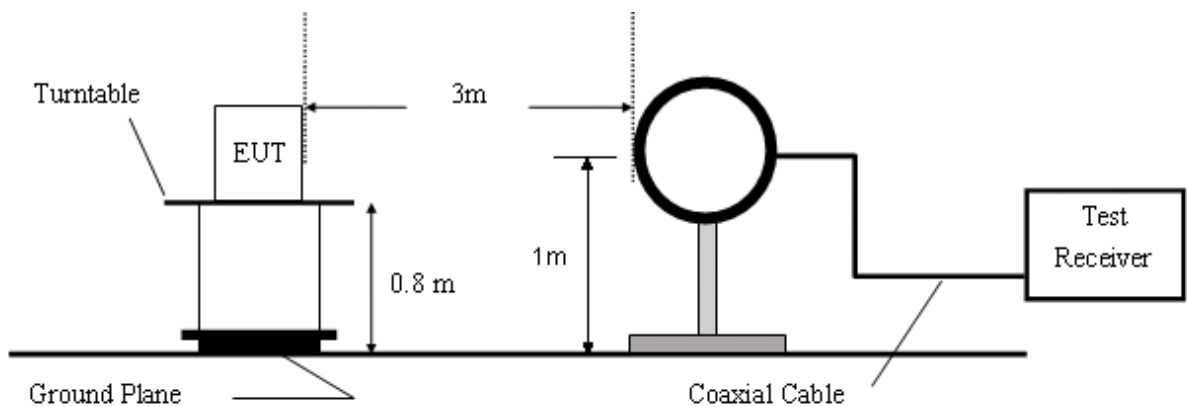

Figure 1. 9KHz to 30MHz radiated emissions test configuration

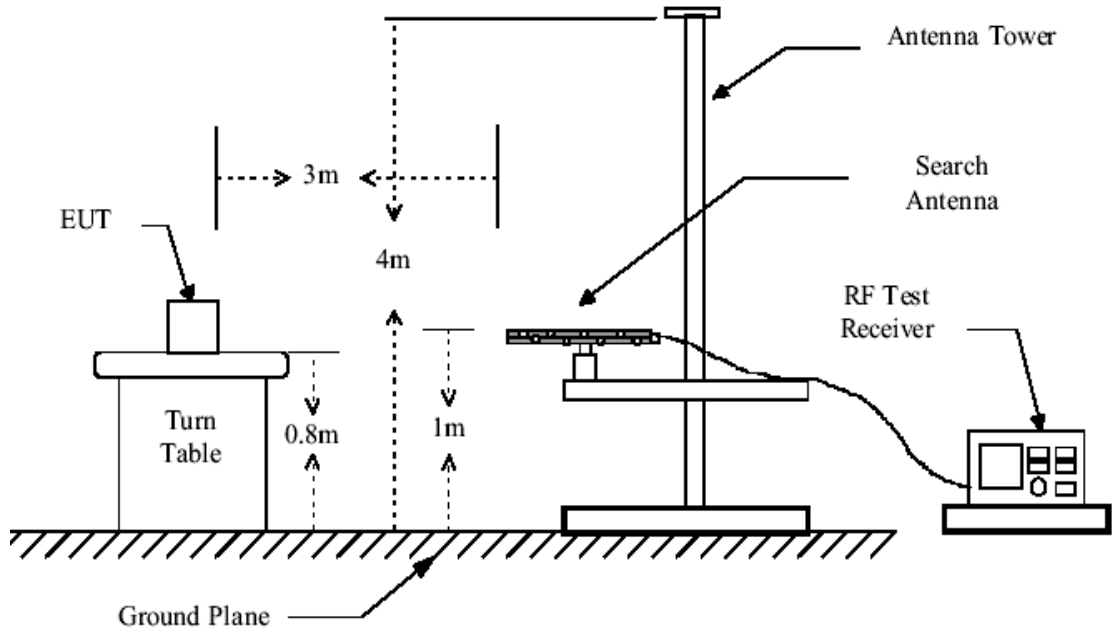

Figure 2. 30MHz to 1GHz radiated emissions test configuration

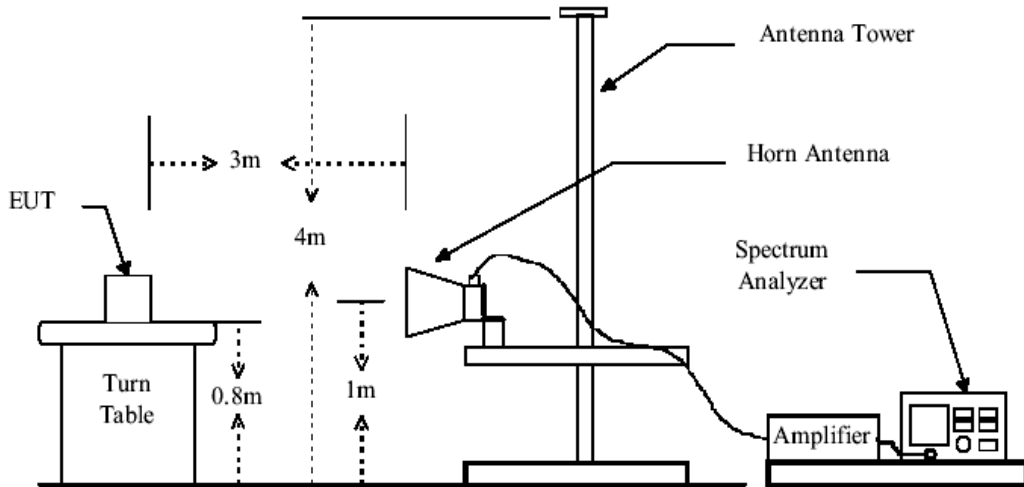

Figure 3. Above 1GHz radiated emissions test configuration

4.10.4 TEST RESULTS

1. Low Frequency 2402MHz

30MHz~1GHz Spurious Emissions .Quasi-Peak Measurement

| No. | Frequency (MHz) | Reading (dBuV/m) | Correct Factor(dB/m) | Result (dBuV/m) | Limit (dBuV/m) | Over Limit (dB) | Antenna polarization |
|-----|-----------------|------------------|----------------------|-----------------|----------------|-----------------|----------------------|
| 1 | 35.9102 | 17.39 | 15.81 | 33.20 | 40.00 | -6.80 | Vertical |
| 2 | 40.8648 | 17.48 | 13.02 | 30.50 | 40.00 | -9.50 | Vertical |
| 3 | 59.2137 | 18.55 | 8.15 | 26.70 | 40.00 | -13.30 | Vertical |
| 4 | 156.5422 | 19.60 | 10.50 | 30.10 | 43.50 | -13.40 | Vertical |
| 5 | 623.7305 | 10.60 | 22.80 | 33.40 | 46.00 | -12.60 | Vertical |
| 6 | 780.9397 | 15.08 | 24.72 | 39.80 | 46.00 | -6.20 | Vertical |
| 7 | 33.3803 | 4.43 | 17.37 | 21.80 | 40.00 | -18.20 | Horizontal |
| 8 | 295.3990 | 11.59 | 14.91 | 26.50 | 46.00 | -19.50 | Horizontal |
| 9 | 384.6920 | 11.92 | 17.88 | 29.80 | 46.00 | -16.20 | Horizontal |
| 10 | 465.6832 | 12.78 | 19.62 | 32.40 | 46.00 | -13.60 | Horizontal |
| 11 | 623.7305 | 9.30 | 22.80 | 32.10 | 46.00 | -13.90 | Horizontal |
| 12 | 780.9397 | 17.98 | 24.72 | 42.70 | 46.00 | -3.30 | Horizontal |

1~25 GHz Harmonics & Spurious Emissions. Peak & Average Measurement

Peak Measurement:

| No. | Frequency (MHz) | Reading (dBuV/m) | Correct Factor(dB/m) | Result (dBuV/m) | Limit (dBuV/m) | Over Limit (dB) | Antenna polarization |
|-----|-----------------|------------------|----------------------|-----------------|----------------|-----------------|----------------------|
| 1 | 15235.368 | 30.26 | 31.52 | 61.78 | 74.00 | -12.22 | Vertical |
| 2 | 16869.777 | 30.43 | 35.22 | 65.65 | 74.00 | -8.35 | Vertical |
| 3 | 13695.720 | 28.22 | 29.38 | 57.60 | 74.00 | -16.40 | Horizontal |
| 4 | 15737.456 | 28.19 | 32.52 | 60.71 | 74.00 | -13.29 | Horizontal |
| 5 | 16869.777 | 29.77 | 35.22 | 64.99 | 74.00 | -9.01 | Horizontal |

AV Measurement:

| No. | Frequency (MHz) | Reading (dBuV/m) | Correct Factor(dB/m) | Result (dBuV/m) | Limit (dBuV/m) | Over Limit (dB) | Antenna polarization |
|-----|-----------------|------------------|----------------------|-----------------|----------------|-----------------|----------------------|
| 1 | 8756.039 | 14.56 | 24.22 | 46.08 | 54.00 | -7.92 | Vertical |
| 2 | 9357.371 | 15.27 | 24.67 | 50.49 | 54.00 | -3.51 | Vertical |
| 3 | 22514.450 | 15.81 | 25.67 | 45.19 | 54.00 | -8.81 | Vertical |
| 4 | 9254.355 | 15.36 | 24.54 | 47.88 | 54.00 | -6.12 | Horizontal |
| 5 | 9853.482 | 15.69 | 25.45 | 50.91 | 54.00 | -3.09 | Horizontal |

The field strength is calculated by adding the Antenna Factor. Correct Factor.

The basic equation with a sample calculation is as follows:

Final Test Level =Receiver Reading + Correct Factor

2. Middle Frequency 2441MHz

30MHz~1GHz Spurious Emissions .Quasi-Peak Measurement

| No. | Frequency (MHz) | Reading (dBuV/m) | Correct Factor(dB/m) | Result (dBuV/m) | Limit (dBuV/m) | Over Limit (dB) | Antenna polarization |
|-----|-----------------|------------------|----------------------|-----------------|----------------|-----------------|----------------------|
| 1 | 33.3803 | 16.03 | 17.37 | 33.40 | 40.00 | -6.60 | Vertical |
| 2 | 40.8648 | 17.08 | 13.02 | 30.10 | 40.00 | -9.90 | Vertical |
| 3 | 59.8830 | 16.96 | 8.04 | 25.00 | 40.00 | -15.00 | Vertical |
| 4 | 164.6630 | 20.19 | 10.61 | 30.80 | 43.50 | -12.70 | Vertical |
| 5 | 623.7305 | 10.30 | 22.80 | 33.10 | 46.00 | -12.90 | Vertical |
| 6 | 780.9397 | 12.78 | 24.72 | 37.50 | 46.00 | -8.50 | Vertical |
| 7 | 33.9478 | 6.18 | 17.02 | 23.20 | 40.00 | -16.80 | Horizontal |
| 8 | 295.3990 | 12.29 | 14.91 | 27.20 | 46.00 | -18.80 | Horizontal |
| 9 | 384.6920 | 12.22 | 17.88 | 30.10 | 46.00 | -15.90 | Horizontal |
| 10 | 468.3073 | 11.95 | 19.75 | 31.70 | 46.00 | -14.30 | Horizontal |
| 11 | 623.7305 | 7.60 | 22.80 | 30.40 | 46.00 | -15.60 | Horizontal |
| 12 | 776.5635 | 17.46 | 24.64 | 42.10 | 46.00 | -3.90 | Horizontal |

1~25 GHz Harmonics & Spurious Emissions. Peak & Average Measurement

Peak Measurement:

| No. | Frequency (MHz) | Reading (dBuV/m) | Correct Factor(dB/m) | Result (dBuV/m) | Limit (dBuV/m) | Over Limit (dB) | Antenna polarization |
|-----|-----------------|------------------|----------------------|-----------------|----------------|-----------------|----------------------|
| 1 | 15306.102 | 29.26 | 31.60 | 60.86 | 74.00 | -13.14 | Vertical |
| 2 | 17185.254 | 29.95 | 35.66 | 65.61 | 74.00 | -8.39 | Vertical |
| 3 | 17834.018 | 29.85 | 35.94 | 65.79 | 74.00 | -8.21 | Vertical |
| 4 | 15883.925 | 26.17 | 32.96 | 59.13 | 74.00 | -14.87 | Horizontal |
| 5 | 16869.777 | 30.02 | 35.22 | 65.24 | 74.00 | -8.76 | Horizontal |

AV Measurement:

| No. | Frequency (MHz) | Reading (dBuV/m) | Correct Factor(dB/m) | Result (dBuV/m) | Limit (dBuV/m) | Over Limit (dB) | Antenna polarization |
|-----|-----------------|------------------|----------------------|-----------------|----------------|-----------------|----------------------|
| 1 | 15306.102 | 14.51 | 31.60 | 46.11 | 54.00 | -7.89 | Vertical |
| 2 | 17185.254 | 14.97 | 35.66 | 50.63 | 54.00 | -3.37 | Vertical |
| 3 | 17834.018 | 15.01 | 35.94 | 50.95 | 54.00 | -3.05 | Vertical |
| 4 | 15883.925 | 14.72 | 32.96 | 47.68 | 54.00 | -6.32 | Horizontal |
| 5 | 16869.777 | 15.41 | 35.22 | 50.63 | 54.00 | -3.37 | Horizontal |

The field strength is calculated by adding the Antenna Factor. Correct Factor.

The basic equation with a sample calculation is as follows:

Final Test Level =Receiver Reading + Correct Factor

3. High Frequency 2480MHz

30MHz~1GHz Spurious Emissions .Quasi-Peak Measurement

| No. | Frequency (MHz) | Reading (dBuV/m) | Correct Factor(dB/m) | Result (dBuV/m) | Limit (dBuV/m) | Over Limit (dB) | Antenna polarization |
|-----|-----------------|------------------|----------------------|-----------------|----------------|-----------------|----------------------|
| 1 | 35.1120 | 15.48 | 16.32 | 31.80 | 40.00 | -8.20 | Vertical |
| 2 | 59.8830 | 17.76 | 8.04 | 25.80 | 40.00 | -14.20 | Vertical |
| 3 | 96.0079 | 17.64 | 9.86 | 27.50 | 43.50 | -16.00 | Vertical |
| 4 | 162.8227 | 20.05 | 10.65 | 30.70 | 43.50 | -12.80 | Vertical |
| 5 | 620.2354 | 8.69 | 22.71 | 31.40 | 46.00 | -14.60 | Vertical |
| 6 | 776.5636 | 12.16 | 24.64 | 36.80 | 46.00 | -9.20 | Vertical |
| 7 | 35.7089 | 6.46 | 15.94 | 22.40 | 40.00 | -17.60 | Horizontal |
| 8 | 288.8331 | 12.69 | 14.71 | 27.40 | 46.00 | -18.60 | Horizontal |
| 9 | 363.6705 | 11.30 | 17.50 | 28.80 | 46.00 | -17.20 | Horizontal |
| 10 | 465.6832 | 12.18 | 19.62 | 31.80 | 46.00 | -14.20 | Horizontal |
| 11 | 776.5636 | 17.86 | 24.64 | 42.50 | 46.00 | -3.50 | Horizontal |
| 12 | 934.7895 | 9.55 | 26.15 | 35.70 | 46.00 | -10.30 | Horizontal |

1~25 GHz Harmonics & Spurious Emissions. Peak & Average Measurement

Peak Measurement:

| No. | Frequency (MHz) | Reading (dBuV/m) | Correct Factor(dB/m) | Result (dBuV/m) | Limit (dBuV/m) | Over Limit (dB) | Antenna polarization |
|-----|-----------------|------------------|----------------------|-----------------|----------------|-----------------|----------------------|
| 1 | 16948.099 | 30.09 | 35.54 | 65.63 | 74.00 | -8.37 | Vertical |
| 2 | 17669.566 | 30.07 | 35.73 | 65.80 | 74.00 | -8.20 | Vertical |
| 3 | 2596.575 | 50.89 | 6.56 | 57.45 | 74.00 | -16.55 | Horizontal |
| 4 | 16106.189 | 27.49 | 33.39 | 60.88 | 74.00 | -13.12 | Horizontal |
| 5 | 16869.777 | 30.26 | 35.22 | 65.48 | 74.00 | -8.52 | Horizontal |

AV Measurement:

| No. | Frequency (MHz) | Reading (dBuV/m) | Correct Factor(dB/m) | Result (dBuV/m) | Limit (dBuV/m) | Over Limit (dB) | Antenna polarization |
|-----|-----------------|------------------|----------------------|-----------------|----------------|-----------------|----------------------|
| 1 | 16948.099 | 15.01 | 35.54 | 50.55 | 54.00 | -3.45 | Vertical |
| 2 | 17669.566 | 14.67 | 35.73 | 50.4 | 54.00 | -3.60 | Vertical |
| 3 | 2596.575 | 38.99 | 6.56 | 45.55 | 54.00 | -8.45 | Horizontal |
| 4 | 16106.189 | 15.62 | 33.39 | 49.01 | 54.00 | -4.99 | Horizontal |
| 5 | 16869.777 | 15.31 | 35.22 | 50.53 | 54.00 | -3.47 | Horizontal |

Remark:

- 1). No any other emissions level which are attenuated less than 20dB below the limit.
According to 15.31(o), The amplitude of spurious emissions from intentional radiators and emissions from unintentional radiators which are attenuated more than 20 dB below the permissible value need not be reported unless specifically required elsewhere in this Part.
Hence there no other emissions have been reported.
- 2). As shown in Section, for frequencies above 1000 MHz. the above field strength limits are based on average limits. However, the peak field strength of any emission shall not exceed the maximum permitted average limits specified above by more than 20 dB under any condition of modulation.
- 3). The test only perform the EUT in transmitting status since the test frequencies were over 1GHz only required transmitting status.

Test result: The unit does meet the requirements.

4.11 BAND EDGES REQUIREMENT

4.11.1 LIMITS

Section 15.247 (d) In any 100 kHz bandwidth outside the frequency band in which the spread spectrum or digitally modulated intentional radiator is operating, the radio frequency power that is produced by the intentional radiator shall be at least 20 dB below that in the 100 kHz bandwidth within the band that contains the highest level of the desired power, based on either an RF conducted or a radiated measurement, provided the transmitter demonstrates compliance with the peak conducted power limits. If the transmitter complies with the conducted power limits based on the use of RMS averaging over a time interval, as permitted under paragraph (b)(3) of this section, the attenuation required under this paragraph shall be 30 dB instead of 20 dB. Attenuation below the general limits specified in Section 15.209(a) is not required.

4.11.2 TEST PROCEDURES

1. Check the calibration of the measuring instrument using either an internal calibrator or a known signal from an external generator.
2. Position the EUT without connection to measurement instrument. Turn on the EUT and connect its antenna terminal to measurement instrument via a low loss cable. Then set it to any one measured frequency within its operating range, and make sure the instrument is operated in its linear range.
3. Set RBW to 100 kHz and VBW of spectrum analyzer to 300 kHz with a convenient frequency span including 100 kHz bandwidth from band edge.
Note: For Restricted Band
RBW=100 kHz
VBW=300 kHz
4. Measure the highest amplitude appearing on spectral display and set it as a reference level. Plot the graph with marking the highest point and edge frequency.

Repeat above procedures until all measured frequencies were complete.

4.11.3 TEST SETUP

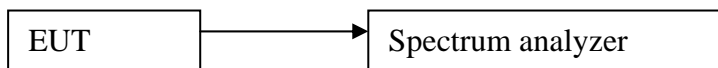

4.11.4 TEST RESULTS

The unit does meet the FCC requirements.

Test result plot as follows:

For GFSK

Lowest Channel

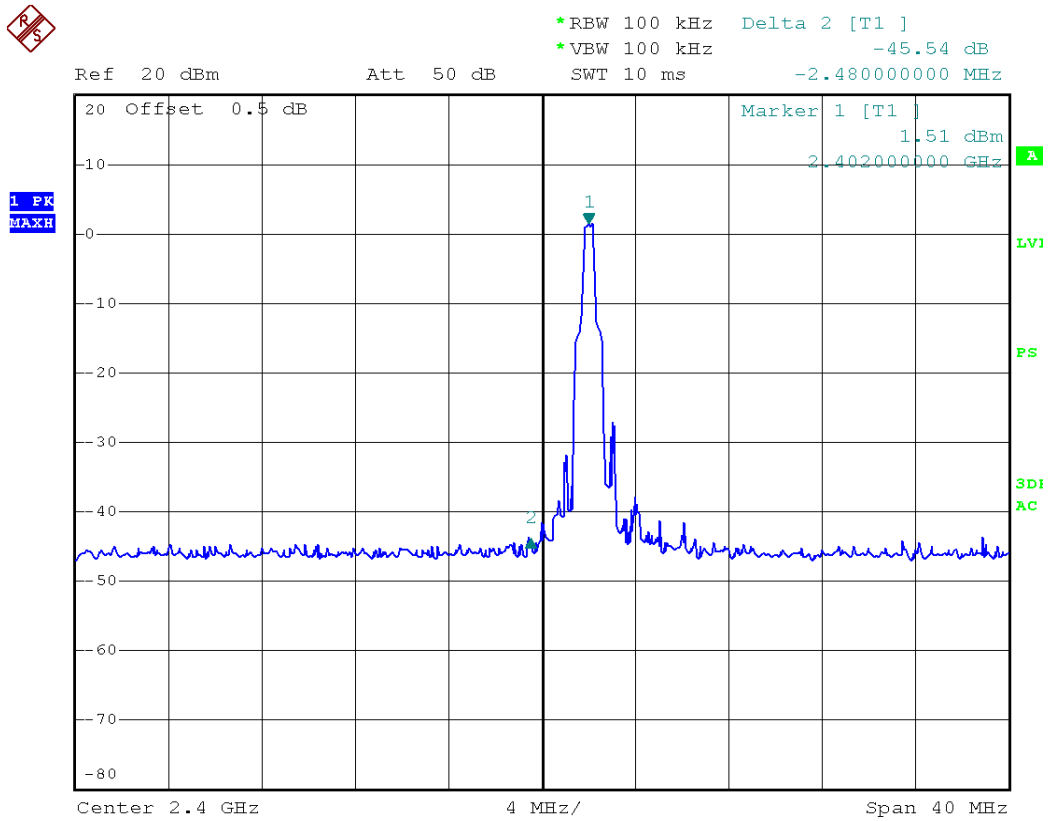

Highest Channel

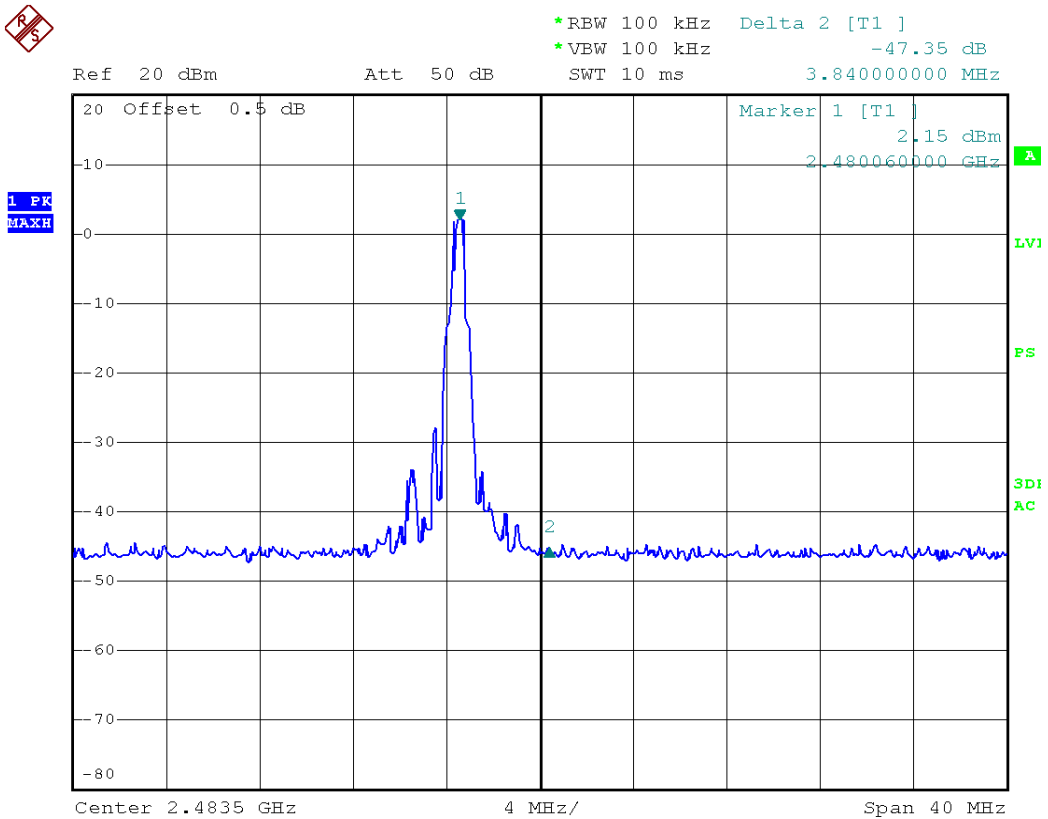

For 8DPSK

Lowest Channel

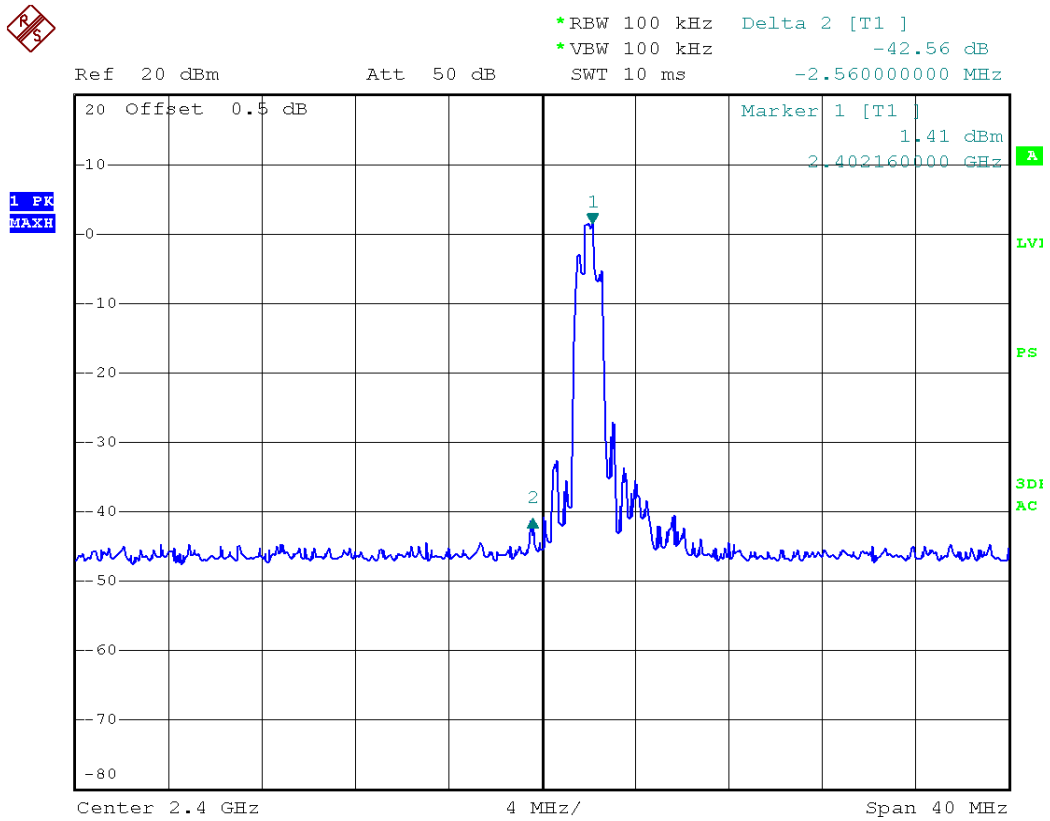

Highest Channel

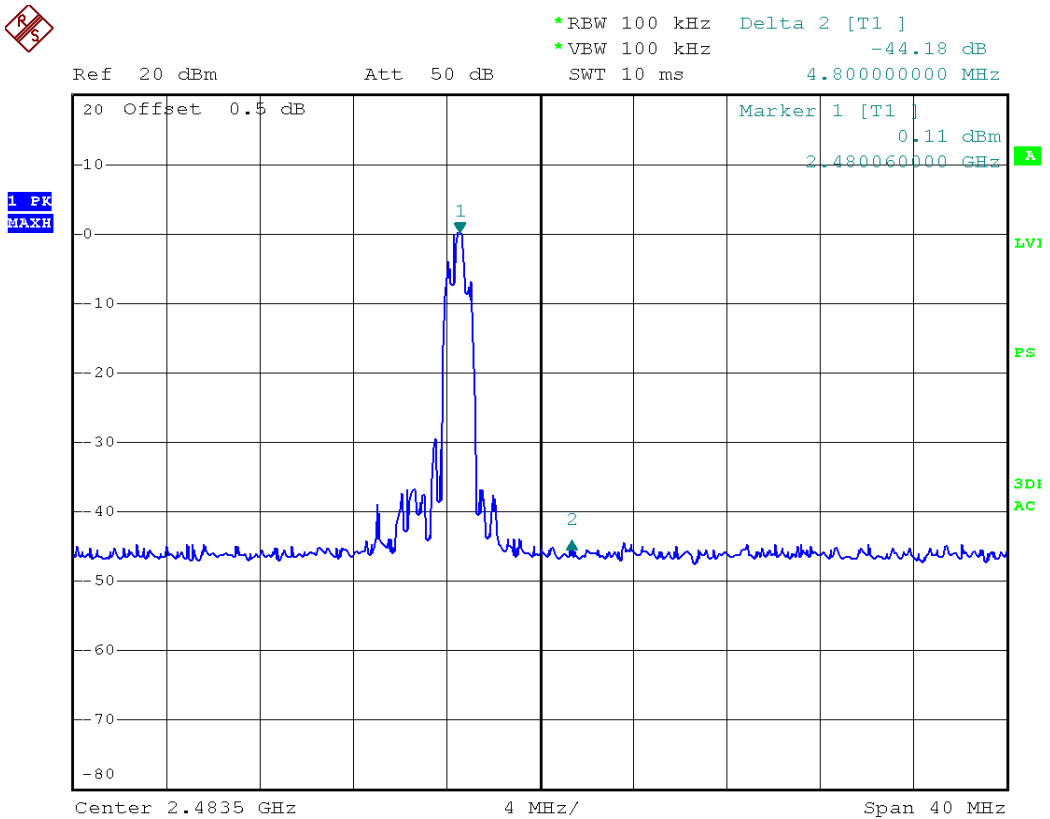

4.11.5 Radiated Emissions which fall in the restricted bands

Section 15.247(d) In addition, radiated emissions which fall in the restricted bands. as defined in Section 15.205(a), must also comply with the radiated emission limits specified in Section 15.209(a) (see Section 15.205(c)).

Section 15.205 Restricted bands of operation.

(a) Except as shown in paragraph (d) of this section. Only spurious emissions are permitted in any of the frequency bands listed below:

| MHz | MHz | MHz | GHz |
|-------------------|-------------------|-----------------|---------------|
| 0.090 - 0.110 | 16.42 - 16.423 | 399.9 - 410 | 4.5 - 5.15 |
| 0.495 - 0.505 | 16.69475 - | 608 - 614 | 5.35 - 5.46 |
| 2.1735 - 2.1905 | 16.69525 | 960 - 1240 | 7.25 - 7.75 |
| 4.125 - 4.128 | 16.80425 - | 1300 - 1427 | 8.025 - 8.5 |
| 4.17725 - 4.17775 | 16.80475 | 1435 - 1626.5 | 9.0 - 9.2 |
| 4.20725 - 4.20775 | 25.5 - 25.67 | 1645.5 - 1646.5 | 9.3 - 9.5 |
| 6.215 - 6.218 | 37.5 - 38.25 | 1660 - 1710 | 10.6 - 12.7 |
| 6.26775 - 6.26825 | 73 - 74.6 | 1718.8 - 1722.2 | 13.25 - 13.4 |
| 6.31175 - 6.31225 | 74.8 - 75.2 | 2200 - 2300 | 14.47 - 14.5 |
| 8.291 - 8.294 | 108 - 121.94 | 2310 - 2390 | 15.35 - 16.2 |
| 8.362 - 8.366 | 123 - 138 | 2483.5 - 2500 | 17.7 - 21.4 |
| 8.37625 - 8.38675 | 149.9 - 150.05 | 2655 - 2900 | 22.01 - 23.12 |
| 8.41425 - 8.41475 | 156.52475 - | 3260 - 3267 | 23.6 - 24.0 |
| 12.29 - 12.293 | 156.52525 | 3332 - 3339 | 31.2 - 31.8 |
| 12.51975 - | 156.7 - 156.9 | 3345.8 - 3358 | 36.43 - 36.5 |
| 12.52025 | 162.0125 - 167.17 | 3600 - 4400 | |
| 12.57675 - | 167.72 - 173.2 | | |
| 12.57725 | 240 - 285 | | |
| 13.36 - 13.41 | 322 - 335.4 | | |

Pretest the Bluetooth normal mode and EDR mode , record EDR mode date

The field strength was measured with an EMI measuring receiver and 1 MHz RBW / VBW for peak and with 1MHz RBW / 10Hz VBW for average at a distance of 3m.

Test Result:

Channel Low

| No. | Freq MHz | Reading dBuV | Factor dB | Level dBuV/m | Limit dBuV/m | Over Limit dB | Remark | Pol V/H |
|-----|-------------|-----------------|--------------|-----------------|-----------------|---------------------|--------|------------|
| 1 | 2390.000 | 28.29 | 16.32 | 44.61 | 74.00 | -29.39 | peak | VERTICAL |
| 2 | 2400.000 | 43.75 | 16.38 | 60.13 | 74.00 | -13.87 | peak | VERTICAL |
| 3 | 2390.000 | 15.74 | 16.32 | 32.06 | 54.00 | -21.94 | AVG | VERTICAL |
| 4 | 2400.000 | 25.67 | 16.38 | 42.05 | 54.00 | -11.95 | AVG | VERTICAL |
| | | | | | | | | |
| 1 | 2390.000 | 29.35 | 16.32 | 45.67 | 74.00 | -28.33 | peak | HORIZONTAL |
| 2 | 2400.000 | 50.07 | 16.38 | 66.45 | 74.00 | -7.55 | peak | HORIZONTAL |
| 3 | 2390.000 | 15.78 | 16.32 | 32.10 | 54.00 | -21.90 | AVG | HORIZONTAL |
| 4 | 2400.000 | 30.50 | 16.38 | 46.88 | 54.00 | -7.12 | AVG | HORIZONTAL |

Channel High

| No. | Freq MHz | Reading dBuV | Factor dB | Level dBuV/m | Limit dBuV/m | Over Limit dB | Remark | Pol V/H |
|-----|-------------|-----------------|--------------|-----------------|-----------------|---------------------|--------|------------|
| 1 | 2483.500 | 29.84 | 16.87 | 46.71 | 74.00 | -27.29 | peak | VERTICAL |
| 2 | 2500.000 | 29.20 | 16.97 | 46.17 | 74.00 | -27.83 | peak | VERTICAL |
| 3 | 2483.500 | 23.27 | 16.87 | 40.14 | 54.00 | -13.86 | AVG | VERTICAL |
| 4 | 2500.000 | 16.92 | 16.97 | 33.89 | 54.00 | -20.11 | AVG | VERTICAL |
| | | | | | | | | |
| 1 | 2483.500 | 32.03 | 16.87 | 48.90 | 74.00 | -25.10 | peak | HORIZONTAL |
| 2 | 2500.000 | 27.49 | 16.97 | 44.46 | 74.00 | -29.54 | peak | HORIZONTAL |
| 3 | 2483.500 | 26.93 | 16.87 | 43.80 | 54.00 | -10.20 | AVG | HORIZONTAL |
| 4 | 2500.000 | 16.85 | 16.97 | 33.82 | 54.00 | -20.18 | AVG | HORIZONTAL |

Remark: Max field strength in 3m distance. No any other emission which falls in restricted bands can be detected and be reported.

-----**This is the last page of the report.**-----