



Test Report No.: RF2212WDG0234-1



TEST REPORT



| | |
|-----------|---|
| Applicant | Sony Group Corporation |
| Address | 1-7-1 Konan Minato-ku Tokyo 108-0075 JP |

| | |
|-------------------------------------|---|
| Manufacturer or Supplier | Sony Interactive Entertainment Inc. |
| Address | 1-7-1 Konan Minato-ku Tokyo 108-0075 JP |
| Product | Computer Entertainment System |
| Brand Name | SONY |
| Model | CFI-Y1001 |
| Additional Model & Model Difference | N/A |
| Date of tests | Mar. 02, 2023 ~ May 17, 2023 |

The tests have been carried out according to the requirements of the following standard:

FCC Part 15, Subpart C, Section 15.247

CONCLUSION: The submitted sample was found to COMPLY with the test requirement

| | |
|---|---|
| Tested by Lucas Chen Project Engineer / EMC Department | Approved by Glyn He Assistant Manager / EMC Department |
|  |  Date: Jun. 12, 2023 |

This report is governed by, and incorporates by reference, the Conditions of Testing as posted at the date of issuance of this report at <http://www.bureauveritas.com/home/about-us/our-business/cps/about-us/terms-conditions/> and is intended for your exclusive use. Any copying or replication of this report to or for any other person or entity, or use of our name or trademark, is permitted only with our prior written permission. This report sets forth our findings solely with respect to the test samples identified herein. The results set forth in this report are not indicative or representative of the quality or characteristics of the lot from which a test sample was taken or any similar or identical product unless specifically and expressly noted. Our report includes all of the tests requested by you and the results thereof based upon the information that you provided to us. Measurement uncertainty is only provided upon request for accredited tests. Statements of conformity are based on simple acceptance criteria without taking measurement uncertainty into account, unless otherwise requested in writing. You have 60 days from date of issuance of this report to notify us of any material error or omission caused by our negligence or if you require measurement uncertainty; provided, however, that such notice shall be in writing and shall specifically address the issue you wish to raise. A failure to raise such issue within the prescribed time shall constitute your unqualified acceptance of the completeness of this report, the tests conducted and the correctness of the report contents.

TABLE OF CONTENTS

| | |
|--|-----------|
| RELEASE CONTROL RECORD | 4 |
| 1 SUMMARY OF TEST RESULTS..... | 5 |
| 2 MEASUREMENT UNCERTAINTY | 5 |
| 3 GENERAL INFORMATION | 6 |
| 3.1 GENERAL DESCRIPTION OF EUT | 6 |
| 3.2 DESCRIPTION OF TEST MODES | 8 |
| 3.2.1 CONFIGURATION OF SYSTEM UNDER TEST | 8 |
| 3.2.2 TEST MODE APPLICABILITY AND TESTED CHANNEL DETAIL..... | 8 |
| 3.3 GENERAL DESCRIPTION OF APPLIED STANDARDS | 11 |
| 3.4 DESCRIPTION OF SUPPORT UNITS | 11 |
| 3.5 CONFIGURATION OF SYSTEM UNDER TEST | 12 |
| 3.6 DUTY CYCLE OF TEST SIGNAL..... | 13 |
| 4 TEST TYPES AND RESULTS..... | 14 |
| 4.1 CONDUCTED EMISSION MEASUREMENT | 14 |
| 4.1.1 LIMITS OF CONDUCTED EMISSION MEASUREMENT | 14 |
| 4.1.2 TEST INSTRUMENTS..... | 14 |
| 4.1.3 TEST PROCEDURES | 15 |
| 4.1.4 DEVIATION FROM TEST STANDARD | 15 |
| 4.1.5 TEST SETUP | 16 |
| 4.1.6 EUT OPERATING CONDITIONS | 16 |
| 4.1.7 TEST RESULTS | 17 |
| 4.2 RADIATED EMISSION MEASUREMENT | 19 |
| 4.2.1 LIMITS OF RADIATED EMISSION MEASUREMENT | 19 |
| 4.2.2 TEST INSTRUMENTS..... | 20 |
| 4.2.3 TEST PROCEDURES | 21 |
| 4.2.4 DEVIATION FROM TEST STANDARD | 22 |
| 4.2.5 TEST SETUP | 22 |
| 4.2.6 EUT OPERATING CONDITIONS | 23 |
| 4.2.7 TEST RESULTS | 24 |
| 4.3 6DB BANDWIDTH MEASUREMENT | 32 |
| 4.3.1 LIMITS OF 6DB BANDWIDTH MEASUREMENT | 32 |
| 4.3.2 TEST INSTRUMENTS..... | 32 |
| 4.3.3 TEST PROCEDURE..... | 33 |



| | | |
|----------|---|-----------|
| 4.3.4 | DEVIATION FROM TEST STANDARD | 33 |
| 4.3.5 | TEST SETUP | 34 |
| 4.3.6 | EUT OPERATING CONDITIONS | 34 |
| 4.3.7 | TEST RESULTS | 35 |
| 4.4 | CONDUCTED OUTPUT POWER..... | 39 |
| 4.4.1 | LIMITS OF CONDUCTED OUTPUT POWER MEASUREMENT | 39 |
| 4.4.2 | TEST SETUP | 39 |
| 4.4.3 | TEST INSTRUMENTS..... | 39 |
| 4.4.4 | TEST PROCEDURES | 39 |
| 4.4.5 | DEVIATION FROM TEST STANDARD | 39 |
| 4.4.6 | EUT OPERATING CONDITIONS | 39 |
| 4.4.7 | TEST RESULTS | 40 |
| 4.5 | POWER SPECTRAL DENSITY MEASUREMENT | 42 |
| 4.5.1 | LIMITS OF POWER SPECTRAL DENSITY MEASUREMENT | 42 |
| 4.5.2 | TEST SETUP | 42 |
| 4.5.3 | TEST INSTRUMENTS..... | 42 |
| 4.5.4 | TEST PROCEDURE..... | 42 |
| 4.5.5 | DEVIATION FROM TEST STANDARD | 42 |
| 4.5.6 | EUT OPERATING CONDITION | 42 |
| 4.5.7 | TEST RESULTS | 43 |
| 4.6 | OUT OF BAND EMISSION MEASUREMENT | 47 |
| 4.6.1 | LIMITS OF OUT OF BAND EMISSION MEASUREMENT | 47 |
| 4.6.2 | TEST SETUP | 47 |
| 4.6.3 | TEST INSTRUMENTS..... | 47 |
| 4.6.4 | TEST PROCEDURE..... | 47 |
| 4.6.5 | DEVIATION FROM TEST STANDARD | 48 |
| 4.6.6 | EUT OPERATING CONDITION | 48 |
| 4.6.7 | TEST RESULTS | 49 |
| 5 | PHOTOGRAPHS OF THE TEST CONFIGURATION | 52 |
| 6 | APPENDIX A - MODIFICATIONS RECORDERS FOR ENGINEERING CHANGES TO THE EUT BY THE LAB | 53 |



**BUREAU
VERITAS**

Test Report No.: RF2212WDG0234-1

RELEASE CONTROL RECORD

| ISSUE NO. | REASON FOR CHANGE | DATE ISSUED |
|-----------------|-------------------|---------------|
| RF2212WDG0234-1 | Original release | Jun. 12, 2023 |



1 SUMMARY OF TEST RESULTS

The EUT has been tested according to the following specifications:

| APPLIED STANDARD: FCC PART 15, SUBPART C (SECTION 15.247) | | | |
|---|----------------------------------|--------|--------------------------------|
| STANDARD SECTION | TEST TYPE AND LIMIT | RESULT | REMARK |
| 15.207 | AC Power Conducted Emission | PASS | Meet the requirement of limit. |
| 15.205 15.209 | Radiated Emission | PASS | Meet the requirement of limit. |
| 15.247(d) | Out of band Emission Measurement | PASS | Meet the requirement of limit. |
| 15.247(a)(2) | 6dB bandwidth | PASS | Meet the requirement of limit. |
| 15.247(b) | Conducted Output power | PASS | Meet the requirement of limit. |
| 15.247(e) | Power Spectral Density | PASS | Meet the requirement of limit. |
| 15.203 | Antenna Requirement | PASS | Meet the requirement of limit. |

2 MEASUREMENT UNCERTAINTY

Where relevant, the following measurement uncertainty levels have been estimated for tests performed on the EUT as specified in CISPR 16-4-2:

| MEASUREMENT | FREQUENCY | UNCERTAINTY |
|---------------------|-----------------|-------------|
| Conducted emissions | 0.15MHz ~ 30MHz | 2.68dB |
| Radiated emissions | 9KHz ~ 30MHz | 2.80dB |
| | 30MHz ~ 1GMHz | 4.24dB |
| | 1GHz ~ 18GHz | 4.76dB |
| | 18GHz ~ 40GHz | 4.50dB |

This uncertainty represents an expanded uncertainty expressed at approximately the 95% confidence level using a coverage factor of k = 2.



3 GENERAL INFORMATION

3.1 GENERAL DESCRIPTION OF EUT

| | |
|------------------------------------|---|
| PRODUCT | Computer Entertainment System |
| MODEL NO. | CFI-Y1001 |
| ADDITIONAL MODEL | N/A |
| FCC ID | AK8CFIY1001 |
| NOMINAL VOLTAGE | Powered by Type-C Host Unit or DC 3.87V from Li-ion Battery |
| MODULATION TECHNOLOGY | DTS |
| MODULATION TYPE | $\pi/4$ DQPSK |
| OPERATING FREQUENCY | 2404.39578-2476.39578MHz |
| PEAK OUTPUT POWER | 4.046mW (Max. Measured) |
| ANTENNA TYPE | Chain 0: FPCB Antenna, with 1.26dBi gain Chain 1: FPCB Antenna, with -0.85dBi gain |
| I/O PORTS | Refer to user's manual |
| CABLE SUPPLIED | Type-C Cable: Shielded, Detachable, 1.5m |
| RF POWER SETTING IN TEST SW | See notes 5 |

NOTES:

1. For a more detailed features description, please refer to the manufacturer's specifications or the user's manual.
2. For the test results, the EUT had been tested with all conditions. But only the worst case was shown in test report.
3. Please refer to the EUT photo document (Reference No.: 2212WDG0234-3) for detailed product photo.
4. The working status of the two antennas is as follows.

| MODULATION MODE | TX FUNCTION |
|------------------------|--------------------|
| $\pi/4$ DQPSK | 2 Chains (SISO) |



5. By means of test software provided by manufacturer, the power levels during the tests were set according to the following codes:

Chain 0

| $\pi/4$ DQPSK | |
|---------------|---------------|
| CHANNEL | POWER SETTING |
| 1 | 0x11 |
| 19 | 0x11 |
| 37 | 0x11 |

Chain 1

| $\pi/4$ DQPSK | |
|---------------|---------------|
| CHANNEL | POWER SETTING |
| 1 | 0x11 |
| 19 | 0x11 |
| 37 | 0x11 |



3.2 DESCRIPTION OF TEST MODES

37 channels are provided for π/4 DQPSK:

| CHANNEL | FREQ. (MHZ) | CHANNEL | FREQ. (MHZ) | CHANNEL | FREQ. (MHZ) | CHANNEL | FREQ. (MHZ) |
|---------|-------------|---------|-------------|---------|-------------|---------|-------------|
| 1 | 2404.39578 | 11 | 2424.39578 | 21 | 2444.39578 | 31 | 2464.39578 |
| 2 | 2406.39578 | 12 | 2426.39578 | 22 | 2446.39578 | 32 | 2466.39578 |
| 3 | 2408.39578 | 13 | 2428.39578 | 23 | 2448.39578 | 33 | 2468.39578 |
| 4 | 2410.39578 | 14 | 2430.39578 | 24 | 2450.39578 | 34 | 2470.39578 |
| 5 | 2412.39578 | 15 | 2432.39578 | 25 | 2452.39578 | 35 | 2472.39578 |
| 6 | 2414.39578 | 16 | 2434.39578 | 26 | 2454.39578 | 36 | 2474.39578 |
| 7 | 2416.39578 | 17 | 2436.39578 | 27 | 2456.39578 | 37 | 2476.39578 |
| 8 | 2418.39578 | 18 | 2438.39578 | 28 | 2458.39578 | | |
| 9 | 2420.39578 | 19 | 2440.39578 | 29 | 2460.39578 | | |
| 10 | 2422.39578 | 20 | 2442.39578 | 30 | 2462.39578 | | |

3.2.1 CONFIGURATION OF SYSTEM UNDER TEST

Please see section 5 photographs of the test configuration for reference.

3.2.2 TEST MODE APPLICABILITY AND TESTED CHANNEL DETAIL

Pre-Scan has been conducted to determine the worst-case mode from all possible combinations between available modulations, data rates, XYZ axis, power supply voltage range and antenna ports. The worst case was found when positioned on X axis for radiated emission. Following test modes were selected for the final test, and the final worst case is marked in boldface and recorded in the report:

| EUT CONFIGURE MODE | APPLICABLE TO | | | | DESCRIPTION |
|--------------------|---------------|-------|-----|------|---|
| | RE<1G | RE≥1G | PLC | APCM | |
| A | √ | √ | √ | - | Powered by Adaptor |
| B | - | - | - | √ | Powered by DC 3.87V from Li-ion Battery |

Where **RE<1G**: Radiated Emission below 1GHz **RE≥1G**: Radiated Emission above 1GHz
PLC: Power Line Conducted Emission **APCM**: Antenna Port Conducted Measurement



POWER LINE CONDUCTED EMISSION TEST:

- Pre-Scan has been conducted to determine the worst-case mode from all possible combinations between available modulations, antenna ports (if EUT with antenna diversity architecture), and packet types.
- Following channels were selected for the final test as listed below.

| EUT CONFIGURE MODE | AVAILABLE CHANNEL | TESTED CHANNEL | MODULATION TECHNOLOGY | MODULATION TYPE |
|--------------------|-------------------|----------------|-----------------------|-----------------|
| A | 1 to 37 | 2.4G Link | DTS | $\pi/4$ DQPSK |

For the test results, only the worst case was shown in test report.

RADIATED EMISSION TEST (BELOW 1GHz):

- Pre-Scan has been conducted to determine the worst-case mode from all possible combinations between available modulations, data rates, XYZ axis and antenna ports (if EUT with antenna diversity architecture).
- Following channels were selected for the final test as listed below.

| EUT CONFIGURE MODE | AVAILABLE CHANNEL | TESTED CHANNEL | MODULATION TECHNOLOGY | MODULATION TYPE |
|--------------------|-------------------|----------------|-----------------------|-----------------|
| A | 1 to 37 | 37 | DTS | $\pi/4$ DQPSK |

For the test results, only the worst case was shown in test report.

RADIATED EMISSION TEST (ABOVE 1GHz):

Pre-Scan has been conducted to determine the worst-case mode from all possible combinations between available modulations, data rates, XYZ axis and antenna ports (if EUT with antenna diversity architecture).

- Following channels were selected for the final test as listed below.

| EUT CONFIGURE MODE | AVAILABLE CHANNEL | TESTED CHANNEL | MODULATION TECHNOLOGY | MODULATION TYPE |
|--------------------|-------------------|----------------|-----------------------|-----------------|
| A | 1 to 37 | 1,19, 37 | DTS | $\pi/4$ DQPSK |



ANTENNA PORT CONDUCTED MEASUREMENT:

- This item includes all test value of each mode, but only includes spectrum plot of worst value of each mode.
- Pre-Scan has been conducted to determine the worst-case mode from all possible combinations between available modulations, data rates and antenna ports (if EUT with antenna diversity architecture).
- Following channels were selected for the final test as listed below.

| EUT CONFIGURE MODE | AVAILABLE CHANNEL | TESTED CHANNEL | MODULATION TECHNOLOGY | MODULATION TYPE |
|--------------------|-------------------|----------------|-----------------------|-----------------|
| B | 1 to 37 | 1, 19, 37 | DTS | π/4 DQPSK |

TEST CONDITION:

| APPLICABLE TO | ENVIRONMENTAL CONDITIONS | TEST VOLTAGE | TESTED BY |
|---------------|--------------------------|-----------------------------|-----------|
| RE<1G | 25deg. C, 55%RH | Powered by adaptor | Stalker |
| RE≥1G | 25deg. C, 52%RH | Powered by adaptor | Stalker |
| PLC | 25deg. C, 56%RH | Powered by adaptor | Ming Bai |
| APCM | 25deg. C, 58%RH | DC 3.87V from fully battery | Vincent |



3.3 GENERAL DESCRIPTION OF APPLIED STANDARDS

The EUT is a RF Product. According to the specifications of the manufacturer, it must comply with the requirements of the following standards:

FCC Part 15, Subpart C, Section 15.247

558074 D01 15.247 Meas Guidance v05r02

ANSI C63.10-2013

Note: All test items have been performed and recorded as per the above standards.

3.4 DESCRIPTION OF SUPPORT UNITS

The EUT has been tested as an independent unit together with other necessary accessories or support units. The following support units or accessories were used to form a representative test configuration during the tests.

| NO. | PRODUCT | BRAND | MODEL NO. | SERIAL NO. | FCC ID |
|-----|---|-------|------------------|------------|--------|
| 1 | Adaptor | N/A | A829-120167C-US1 | N/A | N/A |
| 2 | SPECIAL 2.4GHZ WIRELESS Debugging board | N/A | N/A | N/A | N/A |

| NO. | SIGNAL CABLE DESCRIPTION OF THE ABOVE SUPPORT UNITS |
|-----|---|
| 1 | N/A |
| 2 | Type-C Cable: Shielded, Detachable, 1.5m |

3.5 CONFIGURATION OF SYSTEM UNDER TEST

For Conducted Emission Test

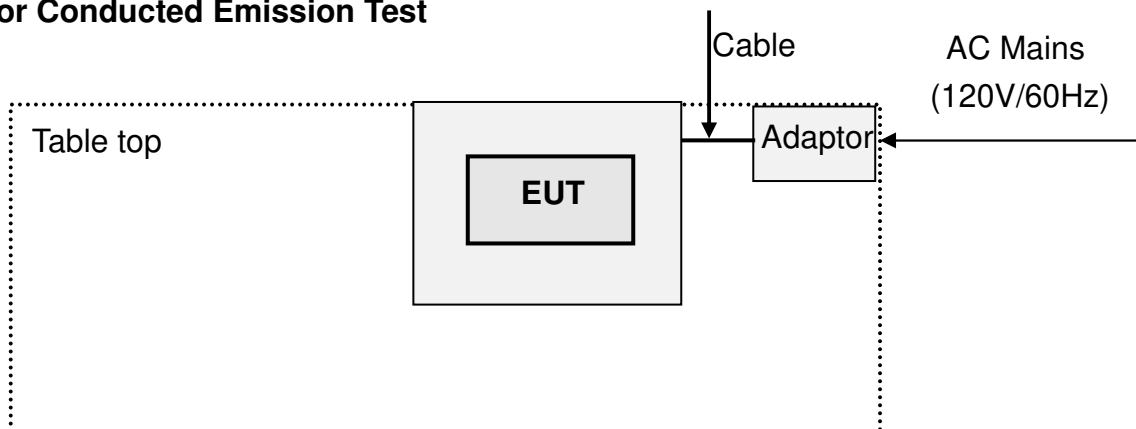

Note: For the actual test configuration, please refer to the attached file (Test Setup Photo).

For Radiated Emission Test

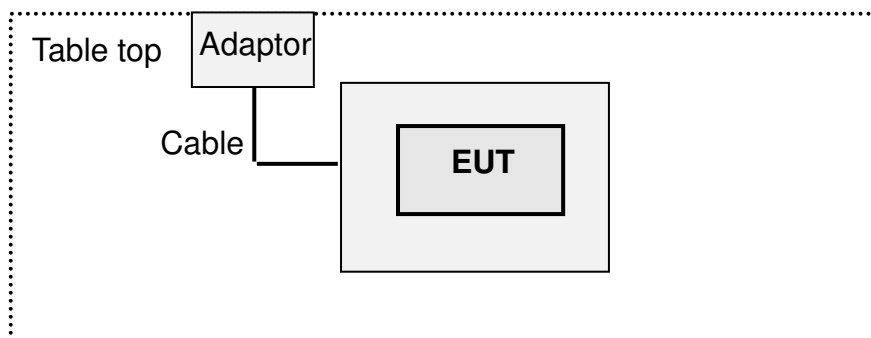

Note: For the actual test configuration, please refer to the attached file (Test Setup Photo).



BUREAU VERITAS

Test Report No.: RF2212WDG0234-1

3.6 DUTY CYCLE OF TESET SIGNAL

| Test Mode | On Time (ms) | Period (ms) | Duty Cycle (%) | VBW Setting |
|---------------|--------------|-------------|----------------|-------------|
| $\pi/4$ DQPSK | 1 | 1 | 100 | 10Hz |

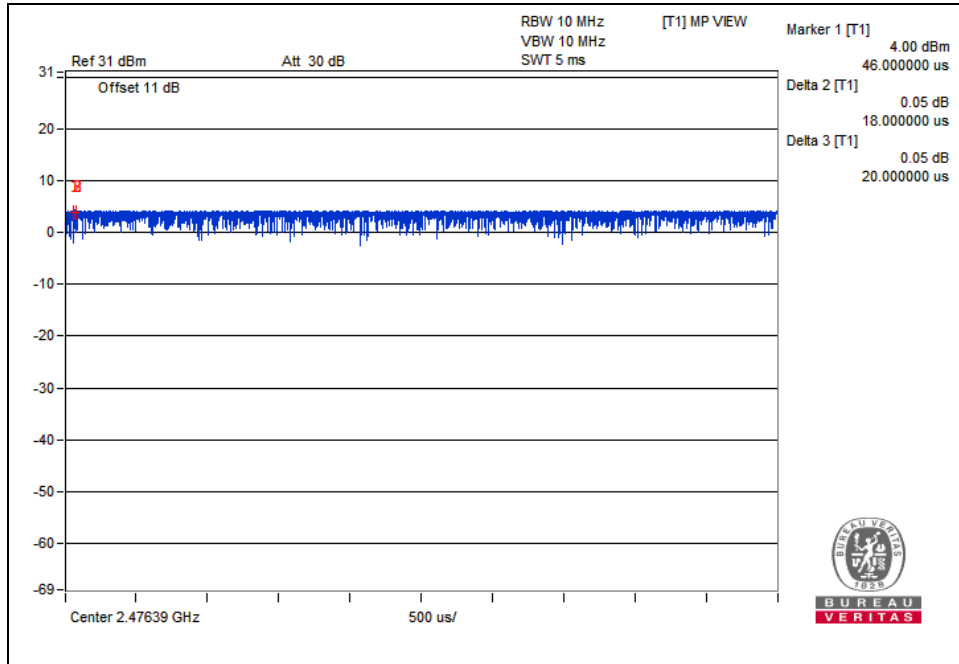



4 TEST TYPES AND RESULTS

4.1 CONDUCTED EMISSION MEASUREMENT

4.1.1 LIMITS OF CONDUCTED EMISSION MEASUREMENT

| FREQUENCY OF EMISSION (MHz) | CONDUCTED LIMIT (dBµV) | |
|-----------------------------|------------------------|----------|
| | Quasi-peak | Average |
| 0.15 ~ 0.5 | 66 to 56 | 56 to 46 |
| 0.5 ~ 5 | 56 | 46 |
| 5 ~ 30 | 60 | 50 |

- NOTES:**
1. The lower limit shall apply at the transition frequencies.
 2. The limit decreases in line with the logarithm of the frequency in the range of 0.15 to 0.50MHz.
 3. All emanations from a class A/B digital device or system, including any network of conductors and apparatus connected thereto, shall not exceed the level of field strengths specified above.

4.1.2 TEST INSTRUMENTS

| Equipment | Manufacturer | Model No. | Serial No. | Next Cal. |
|--------------------------|---------------|-----------------|----------------|-------------|
| EMI Test Receiver | Rohde&Schwarz | ESR7 | 101494 | Jan. 10,24 |
| Artificial Mains Network | Rohde&Schwarz | ENV216 | 101173 | Jan. 11,24 |
| Artificial Mains Network | Rohde&Schwarz | ESH3-Z5 | 100317 | Jan. 10,24 |
| V-LISN (CISPR 25) | SCHWARZBECK | NNBM 8124-200 | 8124-200 05857 | Jun. 14, 23 |
| V-LISN (CISPR 25) | SCHWARZBECK | NNBM 8124-200 | 8124-200 05858 | Jun. 14, 23 |
| Voltage probe | SCHWARZBECK | TK 9421 | TK 9421-176 | Jul. 27, 23 |
| Coaxial RF Cable | SUHNER | RG 223/U-CE | G2310066DG | Jul. 24, 23 |
| Test software | ADT | ADT_Cond_V7.3.7 | N/A | N/A |

- NOTES:**
1. The test was performed in shielded room 553.
 2. The calibration interval of the above test instruments is 12 months. And the calibrations are traceable to CEPREI/CHINA, GRGT/CHINA and NIM/CHINA.



**BUREAU
VERITAS**

Test Report No.: RF2212WDG0234-1

4.1.3 TEST PROCEDURES

- a. The EUT was placed 0.4 meters from the conducting wall of the shielded room with EUT being connected to the power mains through a line impedance stabilization network (LISN). Other support units were connected to the power mains through another LISN. The two LISNs provide 50 ohm/ 50uH of coupling impedance for the measuring instrument.
- b. Both lines of the power mains connected to the EUT were checked for maximum conducted interference.
- c. The frequency range from 150kHz to 30MHz was searched. Emission levels under (Limit - 20dB) was not recorded.

NOTE: All modes of operation were investigated and the worst-case emissions are reported.

4.1.4 DEVIATION FROM TEST STANDARD

No deviation.

4.1.5 TEST SETUP

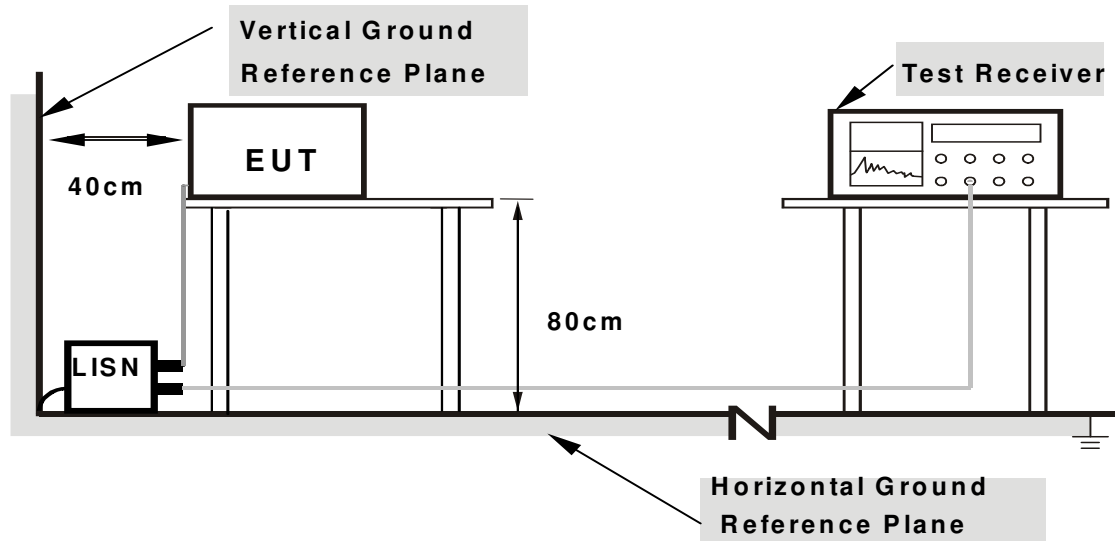

Note: 1.Support units were connected to second LISN.

**2.Both of LISNs (AMN) are 80 cm from EUT and at least 80
from other units and other metal planes**

For the actual test configuration, please refer to the attached file (Test Setup Photo).

4.1.6 EUT OPERATING CONDITIONS

- a. Turned on the power and connected of all equipment.
- b. EUT was operated according to the type used was description in manufacturer's specifications or the User's Manual.



**BUREAU
VERITAS**

Test Report No.: RF2212WDG0234-1

4.1.7 TEST RESULTS

CONDUCTED DATA: 2.4G Wireless Link

| | | | |
|--------------|------|----------------------|------|
| PHASE | Line | 6dB BANDWIDTH | 9kHz |
|--------------|------|----------------------|------|

| No. | Freq. [MHz] | Corr. Factor (dB) | Reading Value | | Emission Level | | Limit | | Margin | |
|-----|----------------|-------------------------|---------------|-------|----------------|-------|-----------|-------|--------|--------|
| | | | [dB (uV)] | | [dB (uV)] | | [dB (uV)] | | (dB) | |
| | | | Q.P. | AV. | Q.P. | AV. | Q.P. | AV. | Q.P. | AV. |
| 1 | 0.15225 | 10.05 | 27.47 | 10.54 | 37.52 | 20.59 | 65.88 | 55.88 | -28.40 | -35.28 |
| 2 | 0.20627 | 10.11 | 27.00 | 11.06 | 37.11 | 21.17 | 63.40 | 53.40 | -26.25 | -32.19 |
| 3 | 0.34975 | 10.19 | 27.04 | 9.47 | 37.23 | 19.66 | 58.97 | 48.97 | -21.74 | -29.31 |
| 4 | 0.75812 | 10.24 | 26.28 | 10.38 | 36.52 | 20.62 | 56.00 | 46.00 | -19.48 | -25.38 |
| 5 | 5.00000 | 10.41 | 32.43 | 22.03 | 42.84 | 32.44 | 56.00 | 46.00 | -13.16 | -13.56 |
| 6 | 8.44350 | 10.64 | 34.91 | 25.06 | 45.55 | 35.70 | 60.00 | 50.00 | -14.45 | -14.30 |

REMARKS: The emission levels of other frequencies were very low against the limit.

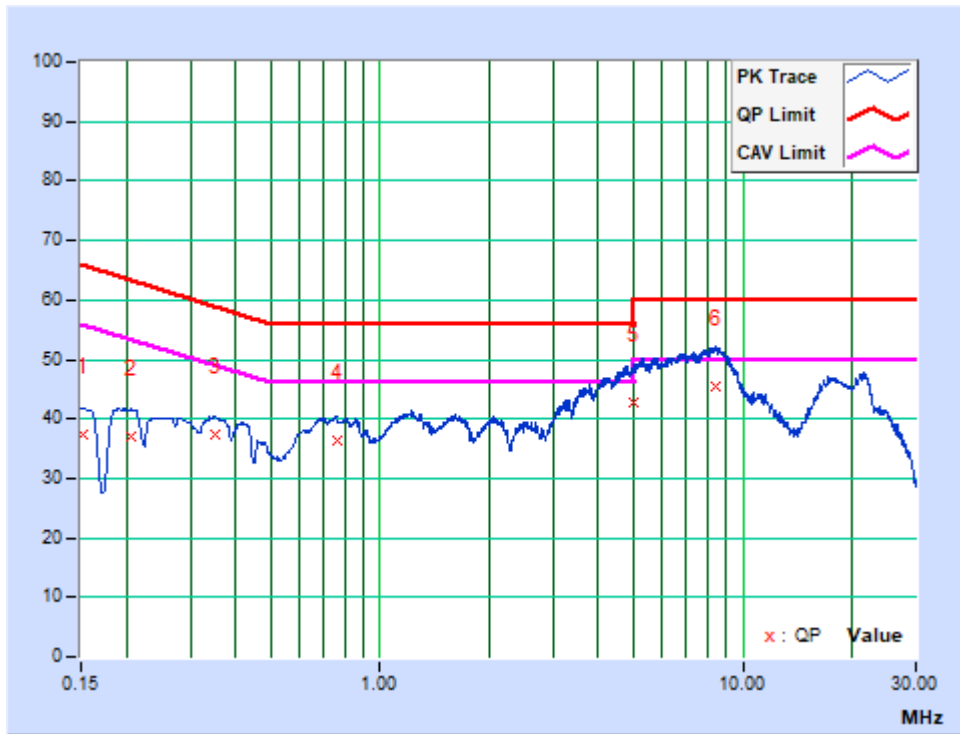



**BUREAU
VERITAS**

Test Report No.: RF2212WDG0234-1

| | | | |
|--------------|---------|----------------------|------|
| PHASE | Neutral | 6dB BANDWIDTH | 9kHz |
|--------------|---------|----------------------|------|

| No. | Freq. [MHz] | Corr. Factor (dB) | Reading Value | | Emission Level | | Limit | | Margin | |
|-----|----------------|-------------------------|---------------|-------|----------------|-------|-----------|-------|--------|--------|
| | | | [dB (uV)] | | [dB (uV)] | | [dB (uV)] | | (dB) | |
| | | | Q.P. | AV. | Q.P. | AV. | Q.P. | AV. | Q.P. | AV. |
| 1 | 0.21067 | 10.11 | 27.30 | 8.87 | 37.41 | 18.98 | 63.18 | 53.18 | -25.77 | -34.20 |
| 2 | 0.69900 | 10.24 | 26.26 | 9.67 | 36.50 | 19.91 | 56.00 | 46.00 | -19.50 | -26.09 |
| 3 | 1.12653 | 10.24 | 25.98 | 10.99 | 36.22 | 21.23 | 56.00 | 46.00 | -19.78 | -24.77 |
| 4 | 2.08725 | 10.26 | 23.03 | 10.90 | 33.29 | 21.16 | 56.00 | 46.00 | -22.71 | -24.84 |
| 5 | 5.00000 | 10.41 | 30.68 | 18.18 | 41.09 | 28.59 | 56.00 | 46.00 | -14.91 | -17.41 |
| 6 | 8.26575 | 10.63 | 32.02 | 20.86 | 42.65 | 31.49 | 60.00 | 50.00 | -17.40 | -18.51 |

REMARKS: The emission levels of other frequencies were very low against the limit.

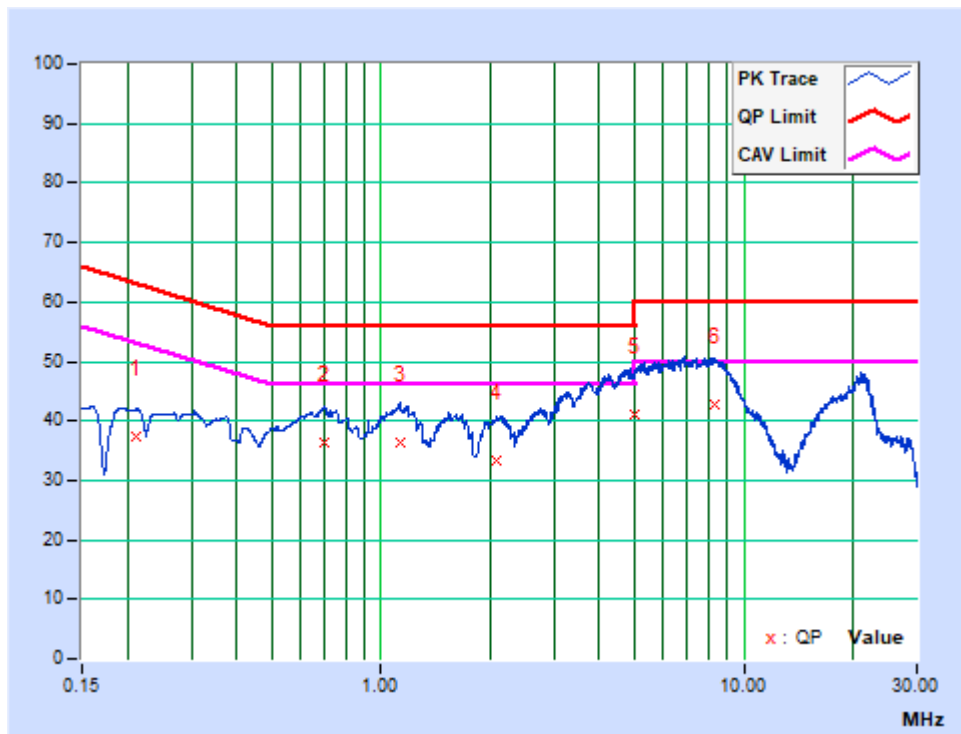

**Bureau Veritas Shenzhen Co., Ltd.
Dongguan Branch**

No. 96, Guantai Road (Houjie Section), Houjie
Town, Dongguan City, Guangdong Province.
523942. People's Republic of China.

Tel: +86 769 8998 2098
Fax: +86 769 8593 1080
Email: customerservice.dg@bureauveritas.com



4.2 RADIATED EMISSION MEASUREMENT

4.2.1 LIMITS OF RADIATED EMISSION MEASUREMENT

Radiated emissions which fall in the restricted bands, as defined in Section 15.205(a), must also comply with the radiated emission limits specified in Section 15.209(a).

| FREQUENCIES (MHz) | FIELD STRENGTH (microvolts/meter) | MEASUREMENT DISTANCE (meters) |
|-------------------|-----------------------------------|-------------------------------|
| 0.009 ~ 0.490 | 2400/F(kHz) | 300 |
| 0.490 ~ 1.705 | 24000/F(kHz) | 30 |
| 1.705 ~ 30.0 | 30 | 30 |
| 30 ~ 88 | 100 | 3 |
| 88 ~ 216 | 150 | 3 |
| 216 ~ 960 | 200 | 3 |
| Above 960 | 500 | 3 |

NOTES:

1. The lower limit shall apply at the transition frequencies.
2. Emission level (dBuV/m) = 20 log Emission level (uV/m).
3. As shown in 15.35(b), for frequencies above 1000MHz, the field strength limits are based on average detector, however, the peak field strength of any emission shall not exceed the maximum permitted average limits, specified above by more than 20dB under any condition of modulation.



4.2.2 TEST INSTRUMENTS

| Equipment | Manufacturer | Model No. | Serial No. | Next Cal. |
|-------------------------------------|---------------|--------------------------|-------------|-------------|
| EMI Test Receiver | Rohde&Schwarz | ESU40 | 100449 | Jan. 10, 24 |
| Signal and Spectrum Analyzer | Rohde&Schwarz | FSV7 | 102331 | Apr. 05, 24 |
| Active Loop Antenna (9KHz -30MHz) | SCHWARZBECK | FMZB 1519B | 1519B-045 | Apr. 20, 24 |
| Amplifier (9KHz -1GHz) | Burgeon | BPA-530 | 100210 | Mar. 06, 24 |
| Trilog-Broadband Antenna | SCHWARZBECK | VULB 9168 | 9168-554 | Jan. 08, 24 |
| Horn Antenna (1GHz -18GHz) | ETS -Lindgren | 3117 | 00062558 | Apr. 01, 24 |
| Horn Antenna (18GHz -40GHz) | SCHWARZBECK | BBHA 9170 | BBHA9170147 | Apr. 01, 24 |
| 3m Semi-anechoic Chamber | ETS-LINDGREN | 9m*6m*6m | NSEMC003 | May 22, 23 |
| Test Software | ADT | ADT_Radiated_V7.6.15.9.2 | N/A | N/A |
| Broadband Preamplifier (1GHz~18GHz) | SCHWARZBECK | BBV9718 | 305 | Apr. 24, 24 |
| Pre-Amplifier (18GHz-40GHz) | EMCI | EMC 184045 | 980102 | Jan. 16, 24 |
| BLUETOOTH TESTER | Rohde&Schwarz | CBT32 | 100811 | N/A |

NOTES:

1. The test was performed in 966 Chamber.
2. The calibration interval of the above test instruments is 12 months and the calibrations are traceable to CEPREI/CHINA, GRGT/CHINA and NIM/CHINA.
3. The horn antenna is used only for the measurement of emission frequency above 1GHz if tested.
4. The FCC Site Registration No. is 749762.



4.2.3 TEST PROCEDURES

- a. The EUT was placed on the top of a rotating table 1.5 meters (above 1GHz) and 0.8 meters (below 1GHz) above the ground at a 3 meters semi-anechoic chamber. The table was rotated 360 degrees to determine the position of the highest radiation.
- b. The EUT was set 3 meters away from the interference-receiving antenna, which was mounted on the top of a variable-height antenna tower.
- c. The antenna is a broadband antenna, and its height is varied from one meter to four meters above the ground to determine the maximum value of the field strength. Both horizontal and vertical polarizations of the antenna are set to make the measurement.
- d. For each suspected emission, the EUT was arranged to its worst case and then the antenna was tuned to heights from 1 meter to 4 meters and the rotatable table was turned from 0 degrees to 360 degrees to find the maximum reading.
- e. The test-receiver system was set to Peak Detect Function and Specified Bandwidth with Maximum Hold Mode.
- f. For below 30MHz, a loop antenna with its vertical plane is place 3m from the EUT and rotated about its vertical axis for maximum response at each azimuth about the EUT. And the centre of the loop shall be 1.3m above the ground.
- g. During the test, each emission was maximized by: having the EUT continuously working, investigated all operating modes, rotated about all 3 axis (X, Y & Z) and considered typical configuration to obtain worst position, manipulating interconnecting cables, For battery operated equipment, the equipment tests shall be perform using fresh batteries. The turntable was rotated to maximize the emission level.

NOTES:

1. The resolution bandwidth and video bandwidth of test receiver/spectrum analyzer is 120kHz for Quasi-peak detection at frequency below 1GHz.
2. The resolution bandwidth of test receiver/spectrum analyzer is 1 MHz and video bandwidth is 3MHz for Peak detection at frequency above 1GHz.
3. The resolution bandwidth of test receiver/spectrum analyzer is 1MHz and the video bandwidth is 10Hz(Duty cycle > 98%) for Average detection (AV) at frequency above 1GHz.
4. All modes of operation were investigated and the worst-case emissions are reported.
5. The testing of the EUT was performed on all 3 orthogonal axes; the worst-case test configuration was reported on the file test setup photo.



4.2.4 DEVIATION FROM TEST STANDARD

No deviation.

4.2.5 TEST SETUP

Below 30MHz test setup

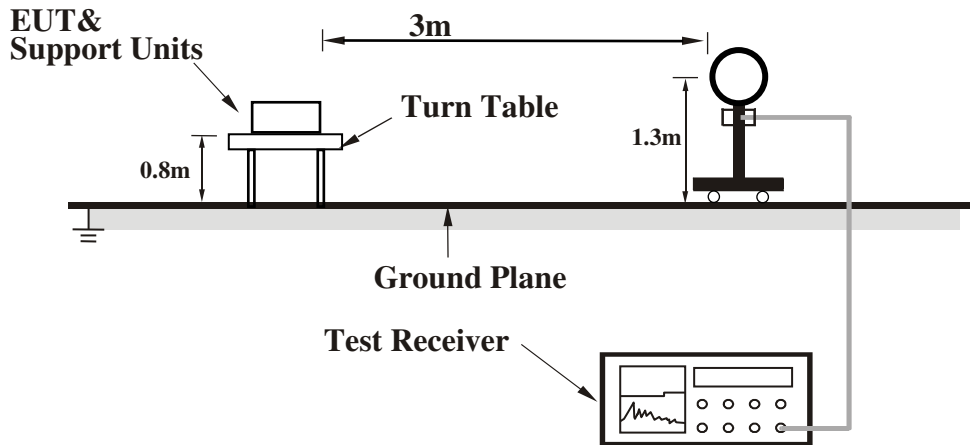

Below 1GHz test setup

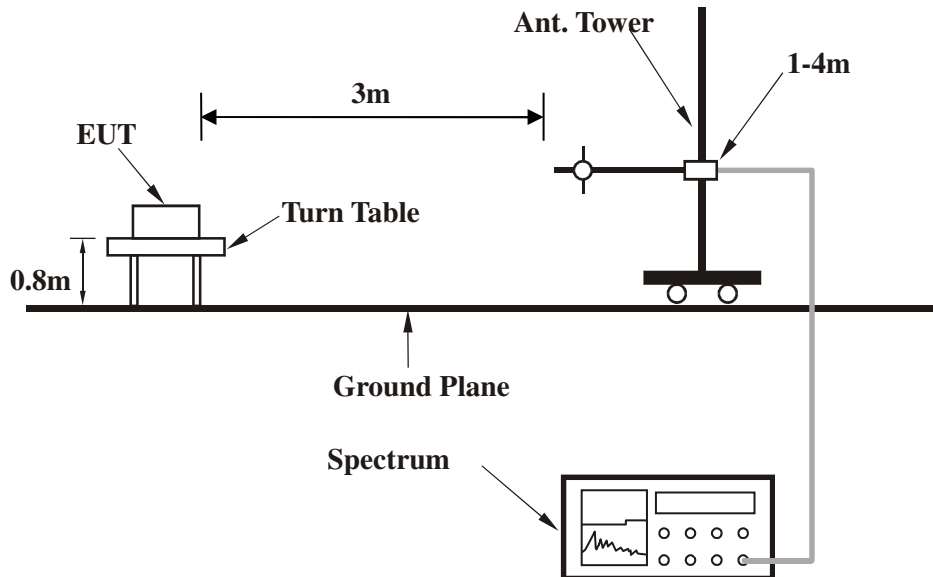

Note: For the actual test configuration, please refer to the attached file (Test Setup Photo).

Above 1GHz test setup

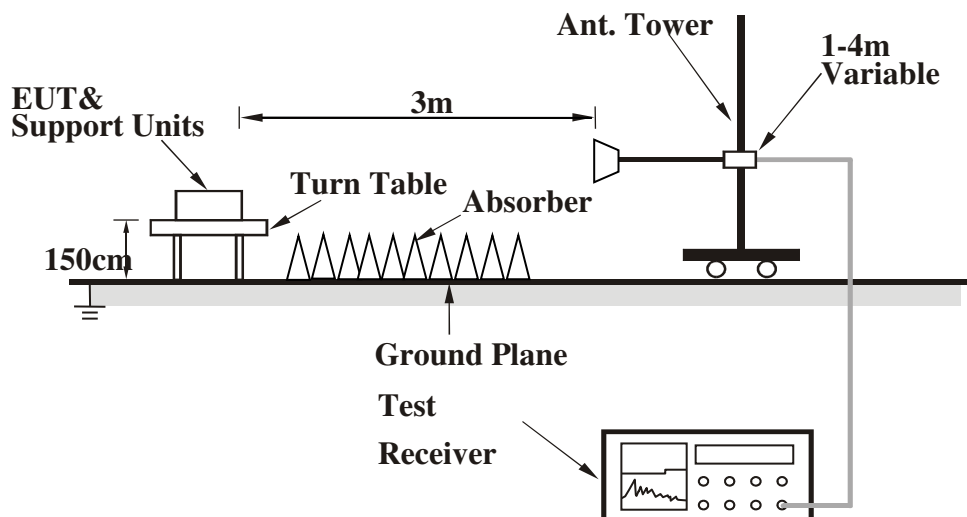

Note: For the actual test configuration, please refer to the attached file (Test Setup Photo).

4.2.6 EUT OPERATING CONDITIONS

- a. Set the EUT under full load condition and placed them on a testing table.
- b. Set the transmitter part of EUT under transmission condition continuously at specific channel frequency.
- c. The necessary accessories enable the EUT in full functions.



4.2.7 TEST RESULTS

BELOW 1GHz WORST-CASE DATA:

II/4 DQPSK (Worst-case chain 1)

| | | | |
|------------------------|---------------|------------------------------|-----------------|
| CHANNEL | TX Channel 37 | DETECTOR FUNCTION | Quasi-Peak (QP) |
| FREQUENCY RANGE | 9KHz ~ 1GHz | | |

| ANTENNA POLARITY & TEST DISTANCE: HORIZONTAL AT 3 M | | | | | | | | |
|---|----------------|-------------------------------|-------------------|----------------|--------------------------|----------------------------|------------------------|--------------------------------|
| NO. | FREQ. (MHz) | EMISSION LEVEL (dBuV/m) | LIMIT (dBuV/m) | MARGIN (dB) | ANTENNA HEIGHT (m) | TABLE ANGLE (Degree) | RAW VALUE (dBuV) | CORRECTION FACTOR (dB/m) |
| 1 | 30.00 | 25.2 QP | 40.0 | -14.8 | 2.00 H | 55 | 43.2 | -18.0 |
| 2 | 54.87 | 23.1 QP | 40.0 | -16.9 | 2.00 H | 42 | 39.7 | -16.6 |
| 3 | 103.06 | 26.5 QP | 43.5 | -17.0 | 2.00 H | 68 | 47.1 | -20.6 |
| 4 | 121.71 | 25.5 QP | 43.5 | -18.0 | 2.00 H | 12 | 44.0 | -18.6 |
| 5 | 297.37 | 17.1 QP | 46.0 | -28.9 | 2.00 H | 120 | 31.8 | -14.8 |
| 6 | 417.07 | 21.7 QP | 46.0 | -24.3 | 2.00 H | 155 | 33.4 | -11.7 |

REMARKS:

1. Emission level (dBuV/m) = Raw Value (dBuV) + Correction Factor (dB/m).
2. Correction Factor (dB/m) = Antenna Factor (dB/m) + Cable Factor (dB).
3. The emission levels of other frequencies were greater than 20dB margin.
4. 9KHz~30MHz have been test and test data more than 20dB margin.
5. Margin value = Emission level – Limit value

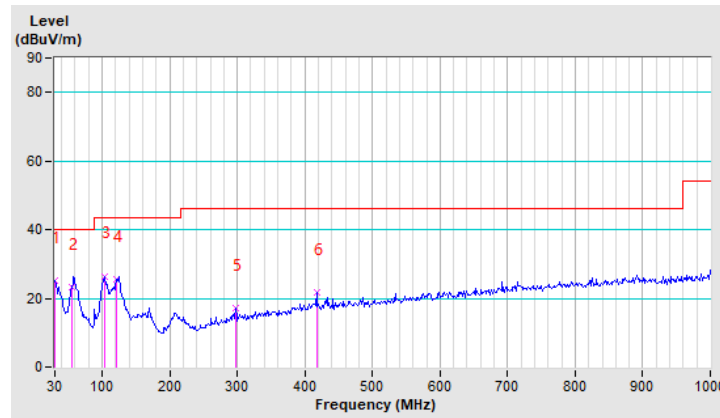



**BUREAU
VERITAS**

Test Report No.: RF2212WDG0234-1

| | | | |
|------------------------|---------------|------------------------------|-----------------|
| CHANNEL | TX Channel 37 | DETECTOR FUNCTION | Quasi-Peak (QP) |
| FREQUENCY RANGE | 9KHz ~ 1GHz | | |

| ANTENNA POLARITY & TEST DISTANCE: VERTICAL AT 3 M | | | | | | | | |
|---|----------------|-------------------------------|-------------------|----------------|--------------------------|----------------------------|------------------------|--------------------------------|
| NO. | FREQ. (MHz) | EMISSION LEVEL (dBuV/m) | LIMIT (dBuV/m) | MARGIN (dB) | ANTENNA HEIGHT (m) | TABLE ANGLE (Degree) | RAW VALUE (dBuV) | CORRECTION FACTOR (dB/m) |
| 1 | 30.00 | 27.0 QP | 40.0 | -13.1 | 2.00 V | 110 | 45.0 | -18.0 |
| 2 | 54.92 | 30.4 QP | 40.0 | -9.6 | 1.00 V | 211 | 47.0 | -16.6 |
| 3 | 106.17 | 26.9 QP | 43.5 | -16.6 | 1.90 V | 166 | 47.0 | -20.1 |
| 4 | 123.27 | 24.0 QP | 43.5 | -19.5 | 1.99 V | 150 | 42.3 | -18.3 |
| 5 | 297.37 | 20.0 QP | 46.0 | -26.0 | 2.00 V | 136 | 34.8 | -14.8 |
| 6 | 403.08 | 19.7 QP | 46.0 | -26.3 | 2.00 V | 84 | 31.9 | -12.2 |

REMARKS:

1. Emission level (dBuV/m) = Raw Value (dBuV) + Correction Factor (dB/m).
2. Correction Factor (dB/m) = Antenna Factor (dB/m) + Cable Factor (dB).
3. The emission levels of other frequencies were greater than 20dB margin.
4. 9KHz~30MHz have been test and test data more than 20dB margin.
5. Margin value = Emission level – Limit value

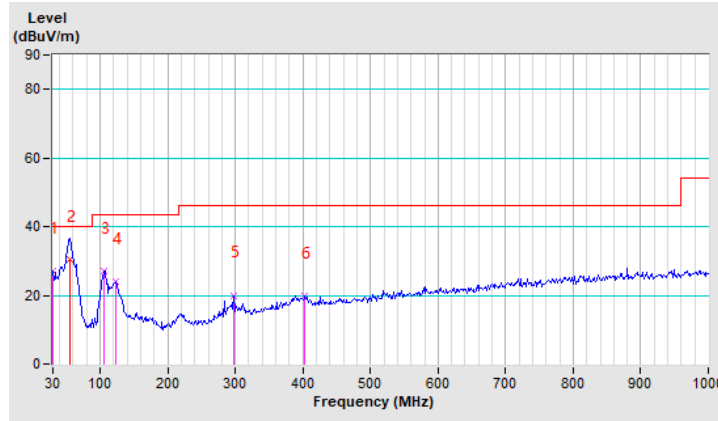

**Bureau Veritas Shenzhen Co., Ltd.
Dongguan Branch**

No. 96, Guantai Road (Houjie Section), Houjie
Town, Dongguan City, Guangdong Province.
523942. People's Republic of China.

Tel: +86 769 8998 2098
Fax: +86 769 8593 1080
Email: customerservice.dg@bureauveritas.com



ABOVE 1GHz TEST DATA:

π/4 DQPSK

Chain 0

| | | | |
|-----------------|--------------|-------------------|--------------|
| CHANNEL | TX Channel 1 | DETECTOR FUNCTION | Peak (PK) |
| FREQUENCY RANGE | 1GHz ~ 25GHz | | Average (AV) |

ANTENNA POLARITY & TEST DISTANCE : HORIZONTAL AT 3 M

| NO. | FREQ. (MHz) | EMISSION LEVEL (dBuV/m) | LIMIT (dBuV/m) | MARGIN (dB) | ANTENNA HEIGHT (m) | TABLE ANGLE (Degree) | RAW VALUE (dBuV) | CORRECTION FACTOR (dB/m) |
|-----|-------------|-------------------------|----------------|-------------|--------------------|----------------------|------------------|--------------------------|
| 1 | 2390.00 | 46.9 PK | 74.0 | -27.1 | 1.73 H | 104 | 44.2 | 2.7 |
| 2 | 2390.00 | 35.9 AV | 54.0 | -18.1 | 1.73 H | 104 | 33.2 | 2.7 |
| 3 | *2404.39 | 95.0 PK | | | 1.73 H | 104 | 92.3 | 2.7 |
| 4 | *2404.39 | 92.4 AV | | | 1.73 H | 104 | 89.7 | 2.7 |
| 5 | 4808.70 | 50.6 PK | 74.0 | -23.5 | 2.06 H | 55 | 42.3 | 8.2 |
| 6 | 4808.70 | 40.3 AV | 54.0 | -13.7 | 2.06 H | 55 | 32.0 | 8.2 |
| 7 | #7213.05 | 51.3 PK | 74.0 | -22.7 | 1.00 H | 92 | 41.8 | 9.5 |
| 8 | #7213.05 | 40.2 AV | 54.0 | -13.8 | 1.00 H | 92 | 30.7 | 9.5 |

ANTENNA POLARITY & TEST DISTANCE : VERTICAL AT 3 M

| NO. | FREQ. (MHz) | EMISSION LEVEL (dBuV/m) | LIMIT (dBuV/m) | MARGIN (dB) | ANTENNA HEIGHT (m) | TABLE ANGLE (Degree) | RAW VALUE (dBuV) | CORRECTION FACTOR (dB/m) |
|-----|-------------|-------------------------|----------------|-------------|--------------------|----------------------|------------------|--------------------------|
| 1 | 2390.00 | 47.2 PK | 74.0 | -26.8 | 1.00 V | 82 | 44.5 | 2.7 |
| 2 | 2390.00 | 38.4 AV | 54.0 | -15.6 | 1.00 V | 82 | 35.8 | 2.7 |
| 3 | *2404.39 | 84.8 PK | | | 1.05 V | 82 | 82.1 | 2.7 |
| 4 | *2404.39 | 80.6 AV | | | 1.05 V | 82 | 77.8 | 2.7 |
| 5 | 4808.70 | 51.3 PK | 74.0 | -22.7 | 1.80 V | 96 | 43.1 | 8.2 |
| 6 | 4808.70 | 40.3 AV | 54.0 | -13.7 | 1.80 V | 96 | 32.1 | 8.2 |
| 7 | #7213.05 | 51.3 PK | 74.0 | -22.7 | 2.41 V | 92 | 41.8 | 9.5 |
| 8 | #7213.05 | 39.3 AV | 54.0 | -14.7 | 2.41 V | 92 | 29.8 | 9.5 |

REMARKS:

1. Emission level (dBuV/m) = Raw Value (dBuV) + Correction Factor (dB/m).
2. Correction Factor (dB/m) = Antenna Factor (dB/m) + Cable Factor (dB).
3. The emission levels of other frequencies were greater than 20dB margin.
4. Margin value = Emission level – Limit value.
5. " * ": Fundamental frequency.
6. " # ": The radiated frequency is out of the restricted band.



| | | | |
|------------------------|---------------|--------------------------|--------------|
| CHANNEL | TX Channel 19 | DETECTOR FUNCTION | Peak (PK) |
| FREQUENCY RANGE | 1GHz ~ 25GHz | | Average (AV) |

| ANTENNA POLARITY & TEST DISTANCE : HORIZONTAL AT 3 M | | | | | | | | |
|--|-------------|-------------------------|----------------|-------------|--------------------|----------------------|------------------|--------------------------|
| NO. | FREQ. (MHz) | EMISSION LEVEL (dBuV/m) | LIMIT (dBuV/m) | MARGIN (dB) | ANTENNA HEIGHT (m) | TABLE ANGLE (Degree) | RAW VALUE (dBuV) | CORRECTION FACTOR (dB/m) |
| 1 | *2440.39 | 95.8 PK | | | 1.66 H | 80 | 92.9 | 2.9 |
| 2 | *2440.39 | 92.5 AV | | | 1.66 H | 80 | 89.6 | 2.9 |
| 3 | 4880.70 | 51.4 PK | 74.0 | -22.6 | 1.80 H | 92 | 42.6 | 8.8 |
| 4 | 4880.70 | 39.5 AV | 54.0 | -14.5 | 1.80 H | 92 | 30.8 | 8.8 |
| 5 | 7321.05 | 52.4 PK | 74.0 | -21.6 | 1.06 H | 75 | 42.8 | 9.6 |
| 6 | 7321.05 | 40.3 AV | 54.0 | -13.7 | 1.06 H | 75 | 30.7 | 9.6 |
| ANTENNA POLARITY & TEST DISTANCE : VERTICAL AT 3 M | | | | | | | | |
| NO. | FREQ. (MHz) | EMISSION LEVEL (dBuV/m) | LIMIT (dBuV/m) | MARGIN (dB) | ANTENNA HEIGHT (m) | TABLE ANGLE (Degree) | RAW VALUE (dBuV) | CORRECTION FACTOR (dB/m) |
| 1 | *2440.39 | 85.6 PK | | | 1.00 V | 155 | 82.8 | 2.9 |
| 2 | *2440.39 | 81.7 AV | | | 1.00 V | 155 | 78.9 | 2.9 |
| 3 | 4880.70 | 48.9 PK | 74.0 | -25.1 | 1.00 V | 95 | 40.2 | 8.8 |
| 4 | 4880.70 | 38.6 AV | 54.0 | -15.4 | 1.00 V | 95 | 29.9 | 8.8 |
| 5 | 7321.05 | 49.4 PK | 74.0 | -24.6 | 1.00 V | 108 | 39.8 | 9.6 |
| 6 | 7321.05 | 37.6 AV | 54.0 | -16.4 | 1.00 V | 108 | 28.0 | 9.6 |

REMARKS:

1. Emission level (dBuV/m) = Raw Value (dBuV) + Correction Factor (dB/m).
2. Correction Factor (dB/m) = Antenna Factor (dB/m) + Cable Factor (dB).
3. The emission levels of other frequencies were greater than 20dB margin.
4. Margin value = Emission level – Limit value.
5. " * ": Fundamental frequency.



| | | | |
|------------------------|---------------|--------------------------|--------------|
| CHANNEL | TX Channel 37 | DETECTOR FUNCTION | Peak (PK) |
| FREQUENCY RANGE | 1GHz ~ 25GHz | | Average (AV) |

| ANTENNA POLARITY & TEST DISTANCE : HORIZONTAL AT 3 M | | | | | | | | |
|--|-------------|-------------------------|----------------|-------------|--------------------|----------------------|------------------|--------------------------|
| NO. | FREQ. (MHz) | EMISSION LEVEL (dBuV/m) | LIMIT (dBuV/m) | MARGIN (dB) | ANTENNA HEIGHT (m) | TABLE ANGLE (Degree) | RAW VALUE (dBuV) | CORRECTION FACTOR (dB/m) |
| 1 | *2476.39 | 93.3 PK | | | 1.30 H | 88 | 90.3 | 3.0 |
| 2 | *2476.39 | 90.2 AV | | | 1.30 H | 88 | 87.2 | 3.0 |
| 3 | 2483.50 | 55.0 PK | 74.0 | -19.0 | 1.30 H | 88 | 52.0 | 3.0 |
| 4 | 2483.50 | 42.8 AV | 54.0 | -11.2 | 1.30 H | 88 | 39.8 | 3.0 |
| 5 | 4952.70 | 48.4 PK | 74.0 | -25.6 | 1.80 H | 85 | 39.1 | 9.3 |
| 6 | 4952.70 | 38.7 AV | 54.0 | -15.3 | 1.80 H | 85 | 29.4 | 9.3 |
| 7 | 7429.05 | 50.8 PK | 74.0 | -23.2 | 1.49 H | 88 | 41.2 | 9.7 |
| 8 | 7429.05 | 39.9 AV | 54.0 | -14.1 | 1.49 H | 88 | 30.2 | 9.7 |
| ANTENNA POLARITY & TEST DISTANCE : VERTICAL AT 3 M | | | | | | | | |
| NO. | FREQ. (MHz) | EMISSION LEVEL (dBuV/m) | LIMIT (dBuV/m) | MARGIN (dB) | ANTENNA HEIGHT (m) | TABLE ANGLE (Degree) | RAW VALUE (dBuV) | CORRECTION FACTOR (dB/m) |
| 1 | *2476.39 | 84.3 PK | | | 1.34 V | 224 | 81.3 | 3.0 |
| 2 | *2476.39 | 80.8 AV | | | 1.34 V | 224 | 77.9 | 3.0 |
| 3 | 2483.50 | 46.5 PK | 74.0 | -27.5 | 1.33 V | 223 | 43.6 | 3.0 |
| 4 | 2483.50 | 35.4 AV | 54.0 | -18.6 | 1.33 V | 223 | 32.4 | 3.0 |
| 5 | 4952.70 | 49.1 PK | 74.0 | -24.9 | 1.48 V | 34 | 39.9 | 9.3 |
| 6 | 4952.70 | 37.9 AV | 54.0 | -16.1 | 1.48 V | 34 | 28.6 | 9.3 |
| 7 | 7429.05 | 49.1 PK | 74.0 | -24.9 | 1.32 V | 48 | 39.4 | 9.7 |
| 8 | 7429.05 | 38.5 AV | 54.0 | -15.5 | 1.32 V | 48 | 28.8 | 9.7 |

REMARKS:

1. Emission level (dBuV/m) = Raw Value (dBuV) + Correction Factor (dB/m).
2. Correction Factor (dB/m) = Antenna Factor (dB/m) + Cable Factor (dB).
3. The emission levels of other frequencies were greater than 20dB margin.
4. Margin value = Emission level – Limit value.
5. " * " : Fundamental frequency.



π/4 DQPSK

Chain 1

| | | | |
|------------------------|--------------|--------------------------|--------------|
| CHANNEL | TX Channel 1 | DETECTOR FUNCTION | Peak (PK) |
| FREQUENCY RANGE | 1GHz ~ 25GHz | | Average (AV) |

| ANTENNA POLARITY & TEST DISTANCE : HORIZONTAL AT 3 M | | | | | | | | |
|--|-------------|-------------------------|----------------|-------------|--------------------|----------------------|------------------|--------------------------|
| NO. | FREQ. (MHz) | EMISSION LEVEL (dBuV/m) | LIMIT (dBuV/m) | MARGIN (dB) | ANTENNA HEIGHT (m) | TABLE ANGLE (Degree) | RAW VALUE (dBuV) | CORRECTION FACTOR (dB/m) |
| 1 | 2390.00 | 46.9 PK | 74.0 | -27.1 | 1.70 H | 130 | 44.2 | 2.7 |
| 2 | 2390.00 | 34.7 AV | 54.0 | -19.3 | 1.70 H | 130 | 32.0 | 2.7 |
| 3 | *2404.39 | 94.7 PK | | | 1.70 H | 130 | 91.9 | 2.7 |
| 4 | *2404.39 | 91.4 AV | | | 1.70 H | 130 | 88.6 | 2.7 |
| 5 | 4808.70 | 51.1 PK | 74.0 | -22.9 | 1.00 H | 90 | 42.8 | 8.2 |
| 6 | 4808.70 | 41.3 AV | 54.0 | -12.7 | 1.00 H | 90 | 33.1 | 8.2 |
| 7 | #7213.05 | 49.1 PK | 74.0 | -24.9 | 2.00 H | 51 | 39.6 | 9.5 |
| 8 | #7213.05 | 38.8 AV | 54.0 | -15.2 | 2.00 H | 51 | 29.3 | 9.5 |
| ANTENNA POLARITY & TEST DISTANCE : VERTICAL AT 3 M | | | | | | | | |
| NO. | FREQ. (MHz) | EMISSION LEVEL (dBuV/m) | LIMIT (dBuV/m) | MARGIN (dB) | ANTENNA HEIGHT (m) | TABLE ANGLE (Degree) | RAW VALUE (dBuV) | CORRECTION FACTOR (dB/m) |
| 1 | 2390.00 | 46.6 PK | 74.0 | -27.4 | 1.10 V | 70 | 43.9 | 2.7 |
| 2 | 2390.00 | 36.7 AV | 54.0 | -17.3 | 1.10 V | 70 | 34.0 | 2.7 |
| 3 | *2404.39 | 92.4 PK | | | 1.10 V | 70 | 89.6 | 2.7 |
| 4 | *2404.39 | 86.7 AV | | | 1.10 V | 70 | 84.0 | 2.7 |
| 5 | 4808.70 | 51.0 PK | 74.0 | -23.0 | 1.00 V | 85 | 42.8 | 8.2 |
| 6 | 4808.70 | 41.0 AV | 54.0 | -13.0 | 1.00 V | 85 | 32.8 | 8.2 |
| 7 | #7213.05 | 50.1 PK | 74.0 | -23.9 | 1.60 V | 52 | 40.6 | 9.5 |
| 8 | #7213.05 | 38.7 AV | 54.0 | -15.3 | 1.60 V | 52 | 29.2 | 9.5 |

REMARKS:

1. Emission level (dBuV/m) = Raw Value (dBuV) + Correction Factor (dB/m).
2. Correction Factor (dB/m) = Antenna Factor (dB/m) + Cable Factor (dB).
3. The emission levels of other frequencies were greater than 20dB margin.
4. Margin value = Emission level – Limit value.
5. " * ": Fundamental frequency.
6. " # ": The radiated frequency is out of the restricted band.



**BUREAU
VERITAS**

Test Report No.: RF2212WDG0234-1

| | | | |
|------------------------|---------------|------------------------------|--------------|
| CHANNEL | TX Channel 19 | DETECTOR FUNCTION | Peak (PK) |
| FREQUENCY RANGE | 1GHz ~ 25GHz | | Average (AV) |

| ANTENNA POLARITY & TEST DISTANCE : HORIZONTAL AT 3 M | | | | | | | | |
|--|----------------|-------------------------------|-------------------|----------------|--------------------------|----------------------------|------------------------|--------------------------------|
| NO. | FREQ. (MHz) | EMISSION LEVEL (dBuV/m) | LIMIT (dBuV/m) | MARGIN (dB) | ANTENNA HEIGHT (m) | TABLE ANGLE (Degree) | RAW VALUE (dBuV) | CORRECTION FACTOR (dB/m) |
| 1 | *2440.39 | 96.3 PK | | | 1.70 H | 96 | 93.4 | 2.9 |
| 2 | *2440.39 | 92.4 AV | | | 1.70 H | 96 | 89.5 | 2.9 |
| 3 | 4880.70 | 48.1 PK | 74.0 | -25.9 | 1.40 H | 280 | 39.3 | 8.8 |
| 4 | 4880.70 | 37.8 AV | 54.0 | -16.2 | 1.40 H | 280 | 29.1 | 8.8 |
| 5 | 7321.05 | 48.6 PK | 74.0 | -25.4 | 1.75 H | 352 | 39.1 | 9.6 |
| 6 | 7321.05 | 37.3 AV | 54.0 | -16.7 | 1.75 H | 352 | 27.7 | 9.6 |
| ANTENNA POLARITY & TEST DISTANCE : VERTICAL AT 3 M | | | | | | | | |
| NO. | FREQ. (MHz) | EMISSION LEVEL (dBuV/m) | LIMIT (dBuV/m) | MARGIN (dB) | ANTENNA HEIGHT (m) | TABLE ANGLE (Degree) | RAW VALUE (dBuV) | CORRECTION FACTOR (dB/m) |
| 1 | *2440.39 | 93.5 PK | | | 1.00 V | 85 | 90.6 | 2.9 |
| 2 | *2440.39 | 87.5 AV | | | 1.00 V | 85 | 84.6 | 2.9 |
| 3 | 4880.70 | 48.7 PK | 74.0 | -25.3 | 1.00 V | 19 | 40.0 | 8.8 |
| 4 | 4880.70 | 38.2 AV | 54.0 | -15.8 | 1.00 V | 19 | 29.5 | 8.8 |
| 5 | 7321.05 | 50.0 PK | 74.0 | -24.0 | 1.00 V | 202 | 40.4 | 9.6 |
| 6 | 7321.05 | 38.2 AV | 54.0 | -15.8 | 1.00 V | 202 | 28.6 | 9.6 |

REMARKS:

1. Emission level (dBuV/m) = Raw Value (dBuV) + Correction Factor (dB/m).
2. Correction Factor (dB/m) = Antenna Factor (dB/m) + Cable Factor (dB).
3. The emission levels of other frequencies were greater than 20dB margin.
4. Margin value = Emission level – Limit value.
5. " * ": Fundamental frequency.

Bureau Veritas Shenzhen Co., Ltd.
Dongguan Branch

No. 96, Guantai Road (Houjie Section), Houjie
Town, Dongguan City, Guangdong Province.
523942. People's Republic of China.

Tel: +86 769 8998 2098
Fax: +86 769 8593 1080
Email: customerservice.dg@bureauveritas.com



| | | | |
|------------------------|---------------|------------------------------|--------------|
| CHANNEL | TX Channel 37 | DETECTOR FUNCTION | Peak (PK) |
| FREQUENCY RANGE | 1GHz ~ 25GHz | | Average (AV) |

| ANTENNA POLARITY & TEST DISTANCE : HORIZONTAL AT 3 M | | | | | | | | |
|--|----------------|-------------------------------|-------------------|----------------|--------------------------|----------------------------|------------------------|--------------------------------|
| NO. | FREQ. (MHz) | EMISSION LEVEL (dBuV/m) | LIMIT (dBuV/m) | MARGIN (dB) | ANTENNA HEIGHT (m) | TABLE ANGLE (Degree) | RAW VALUE (dBuV) | CORRECTION FACTOR (dB/m) |
| 1 | *2476.39 | 94.8 PK | | | 2.44 H | 273 | 91.8 | 3.0 |
| 2 | *2476.39 | 91.3 AV | | | 2.44 H | 273 | 88.4 | 3.0 |
| 3 | 2483.50 | 59.9 PK | 74.0 | -14.1 | 2.44 H | 273 | 57.0 | 3.0 |
| 4 | 2483.50 | 44.5 AV | 54.0 | -9.5 | 2.44 H | 273 | 41.5 | 3.0 |
| 5 | 4952.70 | 50.1 PK | 74.0 | -23.9 | 2.40 H | 252 | 40.8 | 9.3 |
| 6 | 4952.70 | 38.2 AV | 54.0 | -15.8 | 2.40 H | 252 | 28.9 | 9.3 |
| 7 | 7429.05 | 51.3 PK | 74.0 | -22.7 | 2.08 H | 70 | 41.6 | 9.7 |
| 8 | 7429.05 | 40.4 AV | 54.0 | -13.6 | 2.08 H | 70 | 30.7 | 9.7 |
| ANTENNA POLARITY & TEST DISTANCE : VERTICAL AT 3 M | | | | | | | | |
| NO. | FREQ. (MHz) | EMISSION LEVEL (dBuV/m) | LIMIT (dBuV/m) | MARGIN (dB) | ANTENNA HEIGHT (m) | TABLE ANGLE (Degree) | RAW VALUE (dBuV) | CORRECTION FACTOR (dB/m) |
| 1 | *2476.39 | 90.8 PK | | | 1.23 V | 65 | 87.9 | 3.0 |
| 2 | *2476.39 | 87.3 AV | | | 1.23 V | 65 | 84.3 | 3.0 |
| 3 | 2483.50 | 55.9 PK | 74.0 | -18.1 | 1.23 V | 65 | 52.9 | 3.0 |
| 4 | 2483.50 | 45.6 AV | 54.0 | -8.4 | 1.23 V | 65 | 42.6 | 3.0 |
| 5 | 4952.70 | 47.1 PK | 74.0 | -26.9 | 1.80 V | 40 | 37.8 | 9.3 |
| 6 | 4952.70 | 37.3 AV | 54.0 | -16.7 | 1.80 V | 40 | 28.1 | 9.3 |
| 7 | 7429.05 | 49.6 PK | 74.0 | -24.4 | 1.00 V | 220 | 40.0 | 9.7 |
| 8 | 7429.05 | 39.3 AV | 54.0 | -14.7 | 1.00 V | 220 | 29.6 | 9.7 |

REMARKS:

1. Emission level (dBuV/m) = Raw Value (dBuV) + Correction Factor (dB/m).
2. Correction Factor (dB/m) = Antenna Factor (dB/m) + Cable Factor (dB).
3. The emission levels of other frequencies were greater than 20dB margin.
4. Margin value = Emission level – Limit value.
5. " * " : Fundamental frequency.



4.3 6dB BANDWIDTH MEASUREMENT

4.3.1 LIMITS OF 6dB BANDWIDTH MEASUREMENT

The minimum of 6dB Bandwidth Measurement is 0.5 MHz.

4.3.2 TEST INSTRUMENTS

| Equipment | Manufacturer | Model No. | Serial No. | Next Cal. |
|----------------------------------|---------------|-------------------------------|-------------|-------------|
| Power Sensor | Keysight | U2021XA | MY57320002 | Jan. 11, 24 |
| Power Meter | Anritsu | ML2495A | 1139001 | Aug. 22, 23 |
| Power Sensor | Anritsu | MA2411B | 1531155 | Aug. 22, 23 |
| Digital Multimeter | FLUKE | 15B | A1220010DG | N/A |
| Humid & Temp Programmable Tester | Haida | HD-225T | 110807201 | Nov. 02, 23 |
| Oscilloscope | Agilent | DSO9254A | MY51260160 | Jul. 27, 23 |
| Signal and Spectrum Analyzer | Rohde&Schwarz | FSV40 | 101094 | Jan. 11, 24 |
| Signal Generator | Agilent | N5183A | MY50140980 | Jul. 20, 23 |
| MXG-B RF Vector Signal Generator | Keysight | N5182B | MY56200288 | Jul. 20, 23 |
| BLUETOOTH TESTER | Rohde&Schwarz | CBT32 | 100811 | N/A |
| Attenuator | MINI | BW-S10W2+ | S130129FGE2 | N/A |
| DC Source | Keysight | E3642A | MY56146098 | N/A |
| Test software | ADT | ADT_RF Test Software V6.6.5.3 | N/A | N/A |

NOTES:

1. The test was performed in RF Oven room.
2. The calibration interval of the above test instruments is 12 months and the calibrations are traceable to CEPREI/CHINA, GRGT/CHINA and NIM/CHINA.



**BUREAU
VERITAS**

Test Report No.: RF2212WDG0234-1

4.3.3 TEST PROCEDURE

1. Set RBW = 100 kHz.
2. Set the video bandwidth (VBW) ≥ 3 RBW.
3. Detector = Peak.
4. Trace mode = max hold.
5. Sweep = auto couple.
6. Allow the trace to stabilize.
7. Measure the maximum width of the emission that is constrained by the frequencies associated with the two outermost amplitude points (upper and lower frequencies) that are attenuated by 6 dB relative to the maximum level measured in the fundamental emission.

4.3.4 DEVIATION FROM TEST STANDARD

No deviation.



4.3.5 TEST SETUP

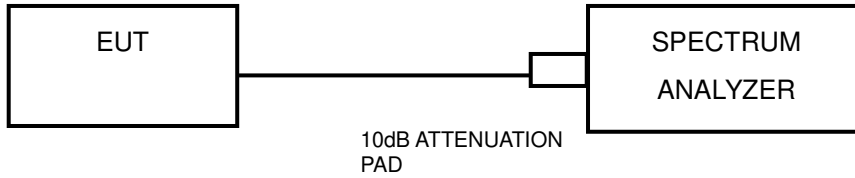

4.3.6 EUT OPERATING CONDITIONS

The software provided by client to enable the EUT under transmission condition continuously at lowest, middle and highest channel frequencies individually.



BUREAU VERITAS

Test Report No.: RF2212WDG0234-1

4.3.7 TEST RESULTS

II/4 DQPSK

Chain 0

| CHANNEL | CHANNEL FREQUENCY (MHz) | 6dB BANDWIDTH (MHz) | MINIMUM LIMIT (MHz) | PASS / FAIL |
|---------|-------------------------|---------------------|---------------------|-------------|
| 1 | 2404.39578 | 3.56 | 0.5 | PASS |
| 19 | 2440.39578 | 3.62 | 0.5 | PASS |
| 37 | 2476.39578 | 3.58 | 0.5 | PASS |

CH1

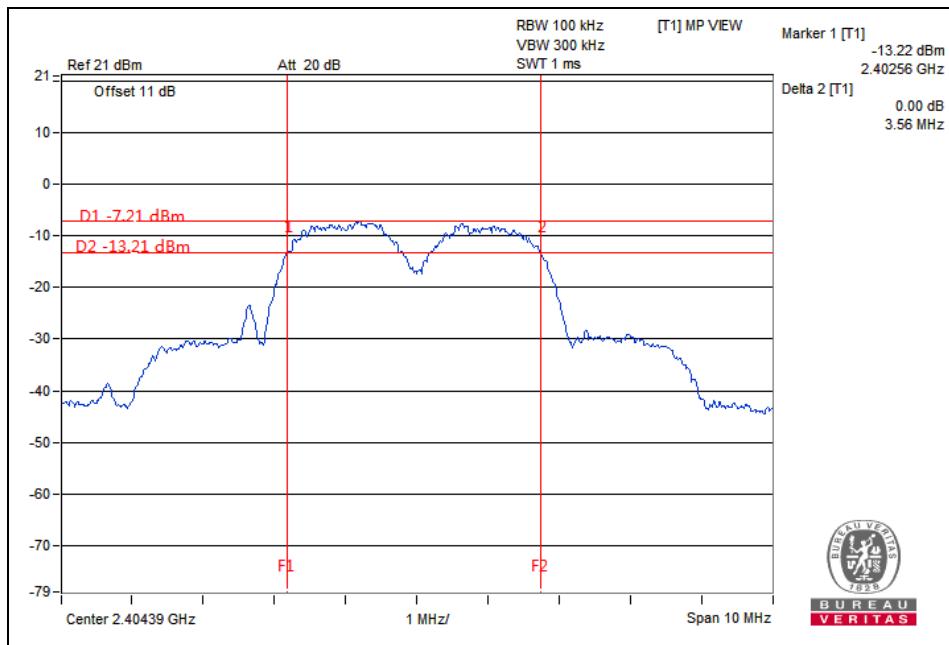



BUREAU VERITAS

Test Report No.: RF2212WDG0234-1

CH19

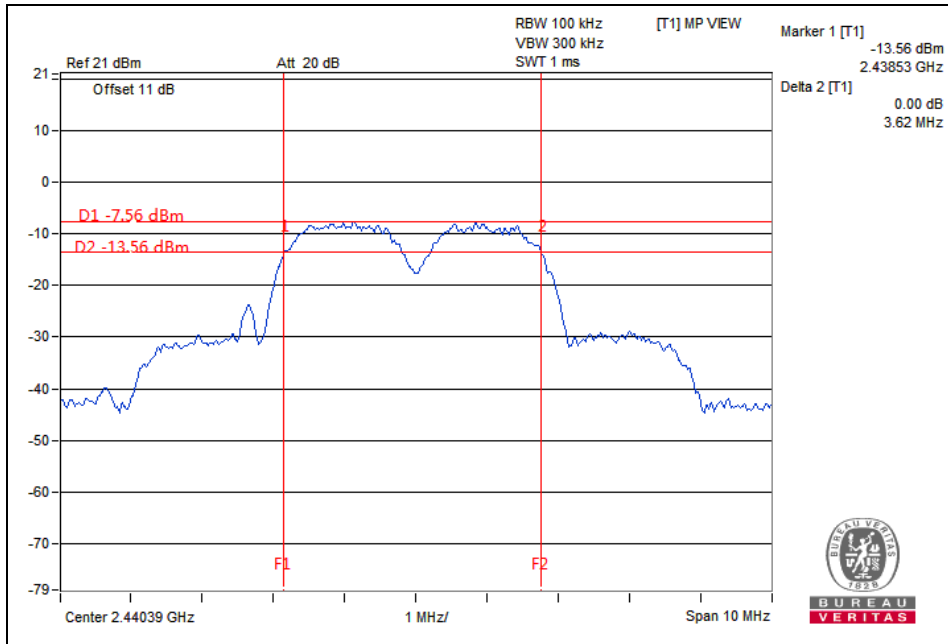

CH37

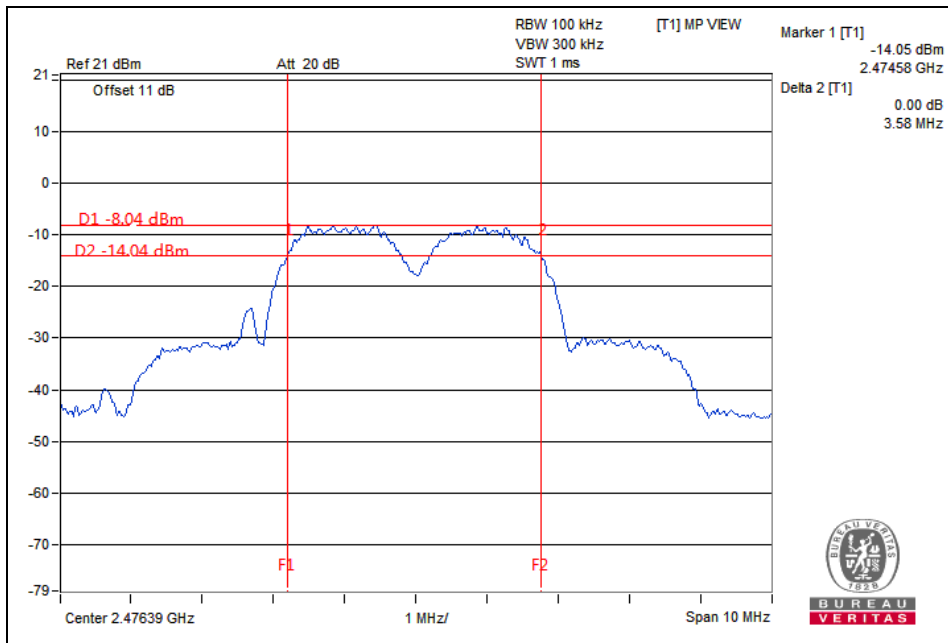



BUREAU VERITAS

Test Report No.: RF2212WDG0234-1

Chain 1

| CHANNEL | CHANNEL FREQUENCY (MHz) | 6dB BANDWIDTH (MHz) | MINIMUM LIMIT (MHz) | PASS / FAIL |
|---------|-------------------------|---------------------|---------------------|-------------|
| 1 | 2404.39578 | 3.54 | 0.5 | PASS |
| 19 | 2440.39578 | 3.58 | 0.5 | PASS |
| 37 | 2476.39578 | 3.50 | 0.5 | PASS |

CH1

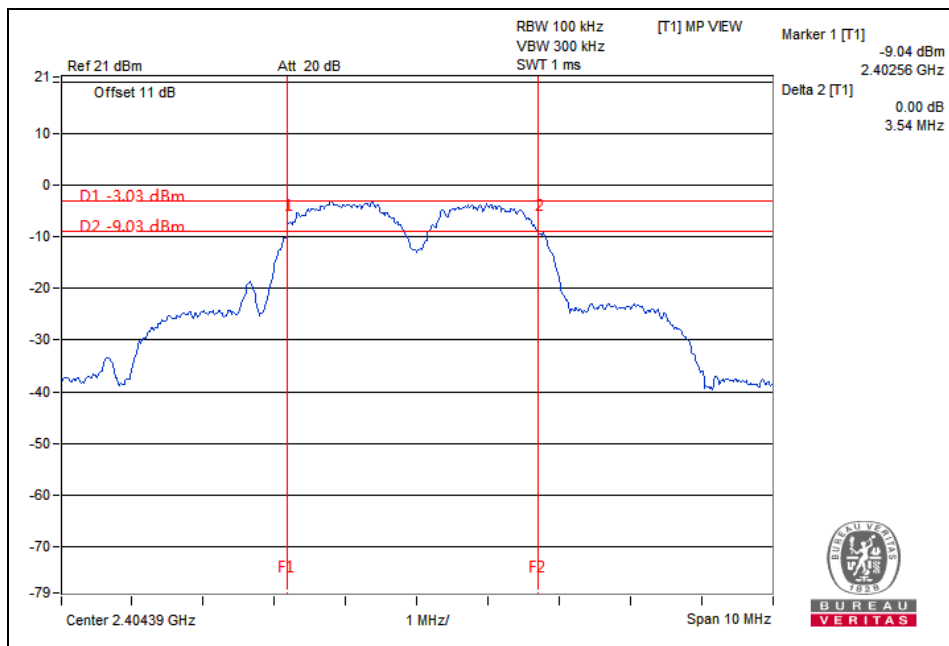



BUREAU VERITAS

Test Report No.: RF2212WDG0234-1

CH19

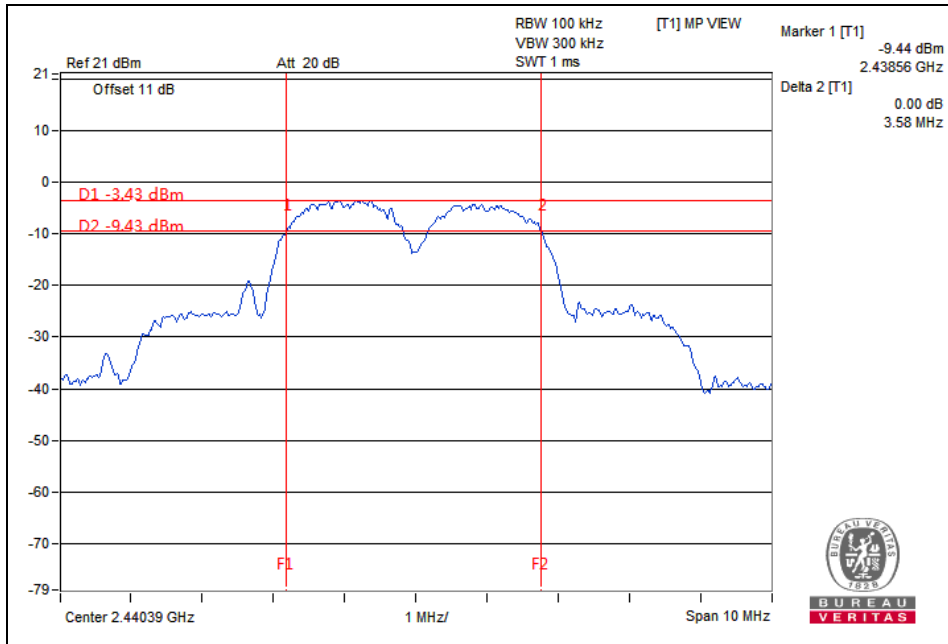

CH37

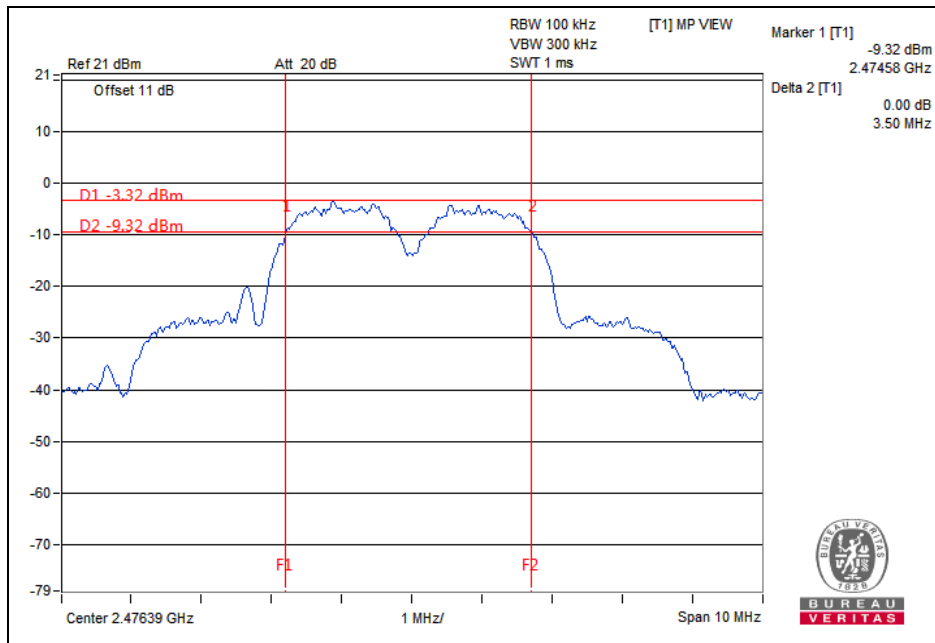

Bureau Veritas Shenzhen Co., Ltd.
Dongguan Branch

No. 96, Guantai Road (Houjie Section), Houjie
Town, Dongguan City, Guangdong Province.
523942, People's Republic of China.

Tel: +86 769 8998 2098
Fax: +86 769 8593 1080
Email: customerservice.dg@bureauveritas.com



4.4 CONDUCTED OUTPUT POWER

4.4.1 LIMITS OF CONDUCTED OUTPUT POWER MEASUREMENT

For systems using digital modulation in the 2400–2483.5 MHz band: 1 Watt (30dBm)

4.4.2 TEST SETUP

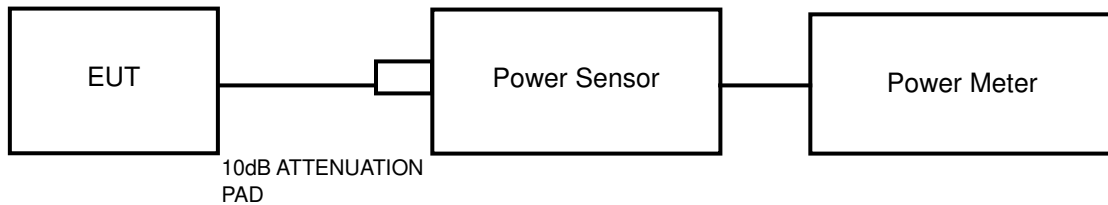

4.4.3 TEST INSTRUMENTS

Refer to section 4.3.2 to get information of above instrument.

4.4.4 TEST PROCEDURES

A peak power sensor was used on the output port of the EUT. A power meter was used to read the response of the peak power sensor and set the detector to PEAK. Record the power level.

An average power sensor was used on the output port of the EUT. A power meter was used to read the response of the average power sensor and set the detector to AVERAGE. Record the power level.

4.4.5 DEVIATION FROM TEST STANDARD

No deviation.

4.4.6 EUT OPERATING CONDITIONS

The software provided by client to enable the EUT under transmission condition continuously at lowest, middle and highest channel frequencies individually.



4.4.7 TEST RESULTS

MAXIMUM PEAK OUTPUT POWER

II/4 DQPSK

Chain 0

| CHANNEL | CHANNEL FREQUENCY (MHz) | PEAK POWER (dBm) | PEAK POWER (mW) | PEAK POWER LIMIT (W) | PASS/FAIL |
|---------|-------------------------|------------------|-----------------|----------------------|-----------|
| 1 | 2404.39578 | 1.49 | 1.409 | 1 | PASS |
| 19 | 2440.39578 | 1.41 | 1.384 | 1 | PASS |
| 37 | 2476.39578 | 0.96 | 1.247 | 1 | PASS |

Chain 1

| CHANNEL | CHANNEL FREQUENCY (MHz) | PEAK POWER (dBm) | PEAK POWER (mW) | PEAK POWER LIMIT (W) | PASS/FAIL |
|---------|-------------------------|------------------|-----------------|----------------------|-----------|
| 1 | 2404.39578 | 6.07 | 4.046 | 1 | PASS |
| 19 | 2440.39578 | 5.63 | 3.656 | 1 | PASS |
| 37 | 2476.39578 | 5.06 | 3.206 | 1 | PASS |

AVERAGE OUTPUT POWER (FOR REFERENCE)

The average power sensor was used on the output port of the EUT. A power meter was used to read the response of the power sensor. Record the power level.

II/4 DQPSK

Chain 0

| CHANNEL | CHANNEL FREQUENCY (MHz) | AVERAGE POWER (dBm) |
|---------|-------------------------|---------------------|
| 1 | 2404.39578 | -2.04 |
| 19 | 2440.39578 | -2.05 |
| 37 | 2476.39578 | -2.46 |

Chain 1

| CHANNEL | CHANNEL FREQUENCY (MHz) | AVERAGE POWER (dBm) |
|---------|-------------------------|---------------------|
| 1 | 2404.39578 | 2.49 |
| 19 | 2440.39578 | 2.14 |
| 37 | 2476.39578 | 1.62 |



4.5 POWER SPECTRAL DENSITY MEASUREMENT

4.5.1 LIMITS OF POWER SPECTRAL DENSITY MEASUREMENT

The Maximum of Power Spectral Density Measurement is 8dBm/3KHz.

4.5.2 TEST SETUP

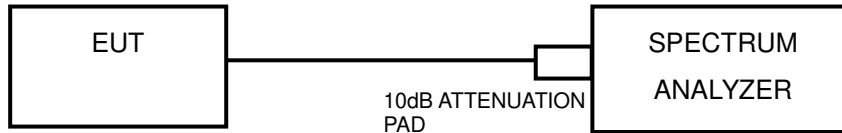

4.5.3 TEST INSTRUMENTS

Refer to section 4.3.2 to get information of above instrument.

4.5.4 TEST PROCEDURE

1. Set the span to 1.5 times the DTS bandwidth
2. Set the RBW = 3 kHz, VBW $\geq 3 \times$ RBW, Detector = peak.
3. Sweep time = auto couple, Trace mode = max hold, allow trace to fully stabilize.
4. Use the peak marker function to determine the maximum amplitude level.

4.5.5 DEVIATION FROM TEST STANDARD

No deviation.

4.5.6 EUT OPERATING CONDITION

The software provided by client to enable the EUT under transmission condition continuously at lowest, middle and highest channel frequencies individually.



BUREAU VERITAS

Test Report No.: RF2212WDG0234-1

4.5.7 TEST RESULTS

II/4 DQPSK

Chain 0

| Channel | FREQ. (MHz) | PSD (dBm/3kHz) | Limit (dBm/3kHz) | PASS /FAIL |
|---------|-------------|----------------|------------------|------------|
| 1 | 2404.39578 | -22.05 | 8 | PASS |
| 19 | 2440.39578 | -21.57 | 8 | PASS |
| 37 | 2476.39578 | -21.32 | 8 | PASS |

CH1

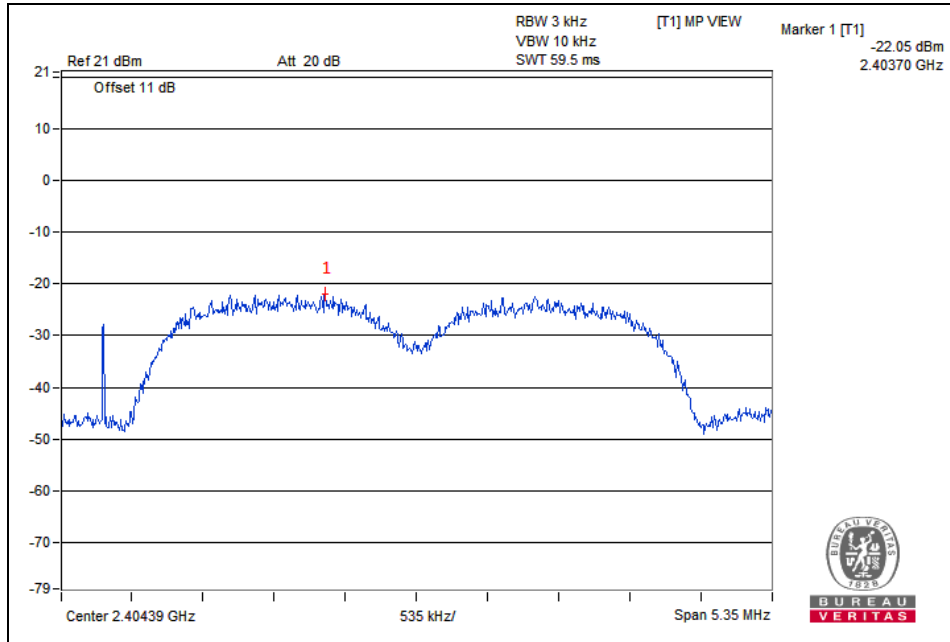



BUREAU VERITAS

Test Report No.: RF2212WDG0234-1

CH19

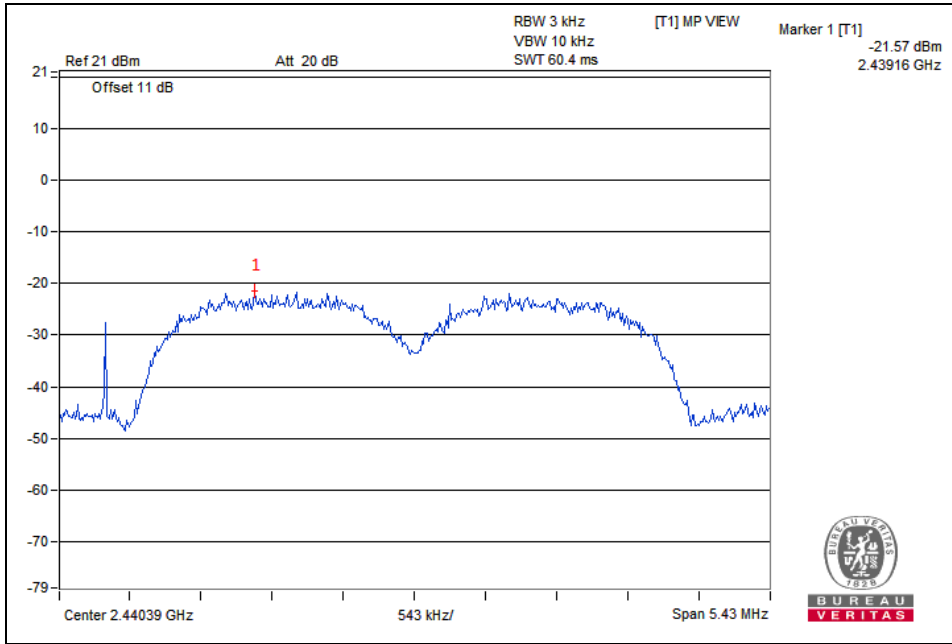

CH37

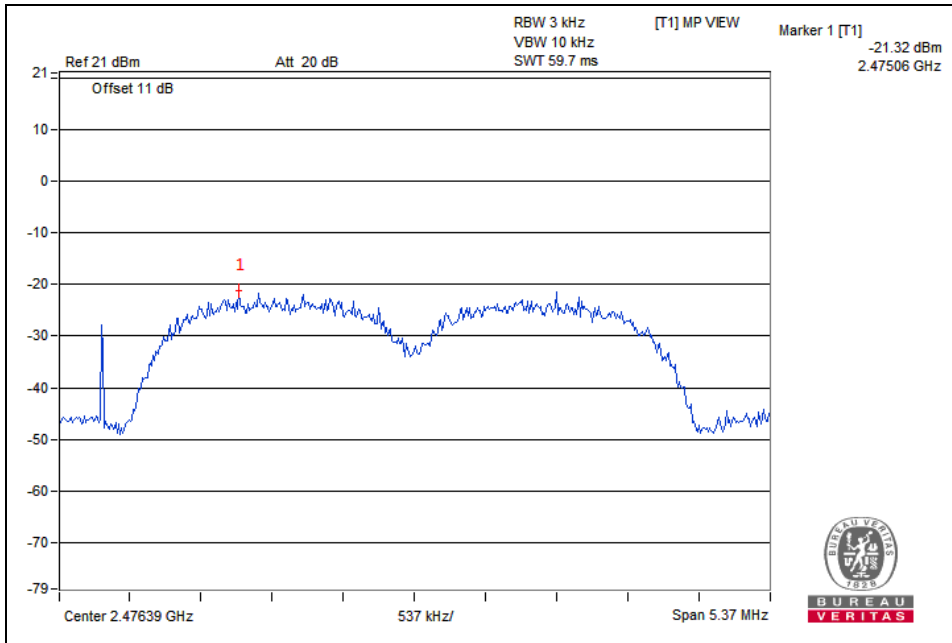

Bureau Veritas Shenzhen Co., Ltd.
Dongguan Branch

No. 96, Guantai Road (Houjie Section), Houjie
Town, Dongguan City, Guangdong Province.
523942. People's Republic of China.

Tel: +86 769 8998 2098
Fax: +86 769 8593 1080
Email: customerservice.dg@bureauveritas.com



BUREAU VERITAS

Test Report No.: RF2212WDG0234-1

Chain 1

| Channel | FREQ. (MHz) | PSD (dBm/3kHz) | Limit (dBm/3kHz) | PASS /FAIL |
|---------|-------------|----------------|------------------|------------|
| 1 | 2404.39578 | -16.53 | 8 | PASS |
| 19 | 2440.39578 | -16.68 | 8 | PASS |
| 37 | 2476.39578 | -17.75 | 8 | PASS |

CH1

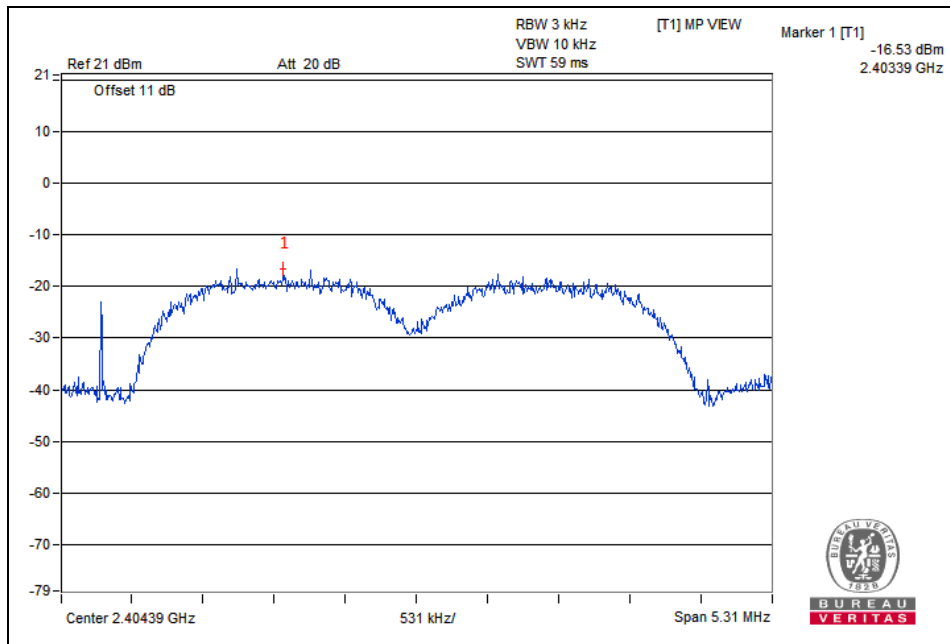



Test Report No.: RF2212WDG0234-1

CH19

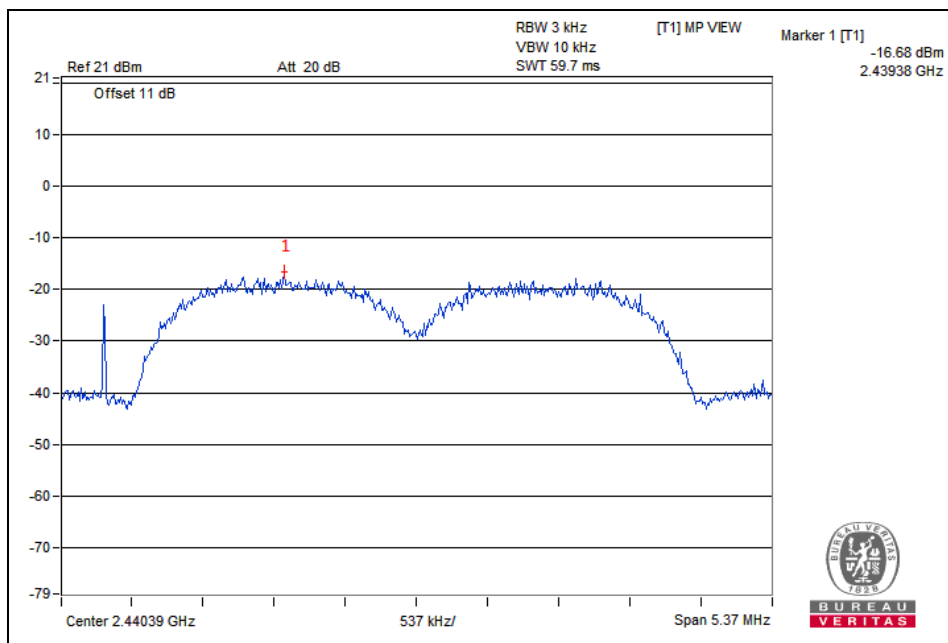

CH37

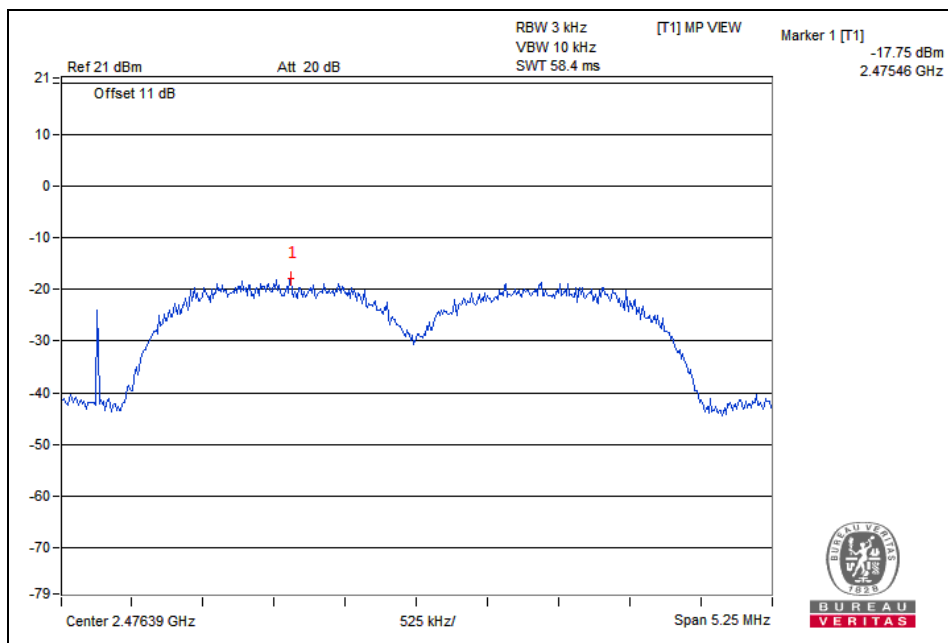

Bureau Veritas Shenzhen Co., Ltd.
Dongguan Branch

No. 96, Guantai Road (Houjie Section), Houjie
Town, Dongguan City, Guangdong Province.
523942. People's Republic of China.

Tel: +86 769 8998 2098
Fax: +86 769 8593 1080
Email: customerservice.dg@bureauveritas.com



4.6 OUT OF BAND EMISSION MEASUREMENT

4.6.1 LIMITS OF OUT OF BAND EMISSION MEASUREMENT

Below -20dB of the highest emission level of operating band (in 100kHz Resolution Bandwidth).

4.6.2 TEST SETUP

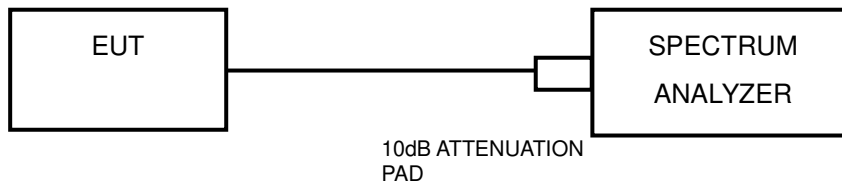

4.6.3 TEST INSTRUMENTS

Refer to section 4.3.2 to get information of above instrument.

4.6.4 TEST PROCEDURE

MEASUREMENT PROCEDURE REF

1. Set the RBW = 100 kHz.
2. Set the VBW \geq 300 kHz.
3. Detector = peak.
4. Sweep time = auto couple.
5. Trace mode = max hold.
6. Allow trace to fully stabilize.
7. Use the peak marker function to determine the maximum power level in any 100 kHz band segment within the fundamental EBW.



**BUREAU
VERITAS**

Test Report No.: RF2212WDG0234-1

MEASUREMENT PROCEDURE OOB

1. Set RBW = 100 kHz.
2. Set VBW \geq 300 kHz.
3. Set span to encompass the spectrum to be examined
4. Detector = peak.
5. Trace Mode = max hold.
6. Sweep = auto couple.

4.6.5 DEVIATION FROM TEST STANDARD

No deviation.

4.6.6 EUT OPERATING CONDITION

The software provided by client to enable the EUT under transmission condition continuously at lowest, middle and highest channel frequencies individually.



BUREAU VERITAS

Test Report No.: RF2212WDG0234-1

4.6.7 TEST RESULTS

Π/4 DQPSK

Chain 0

CH 1

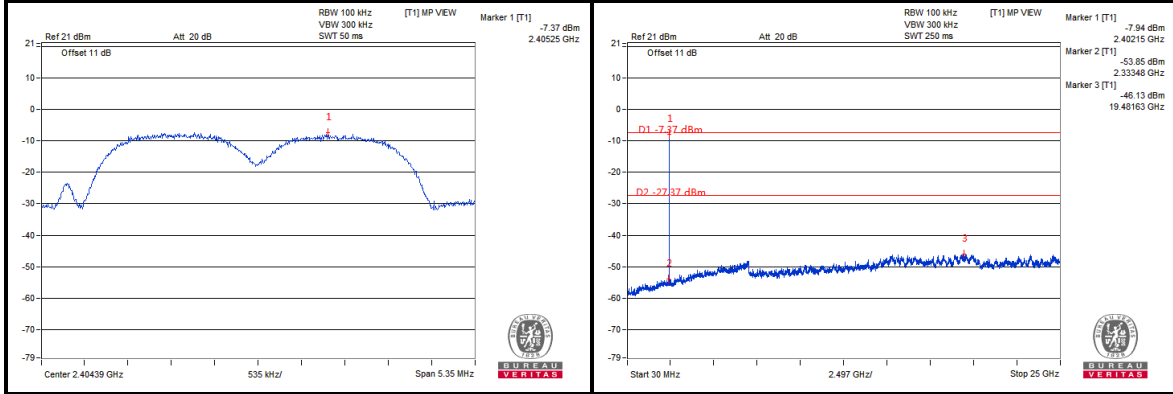

CH 19

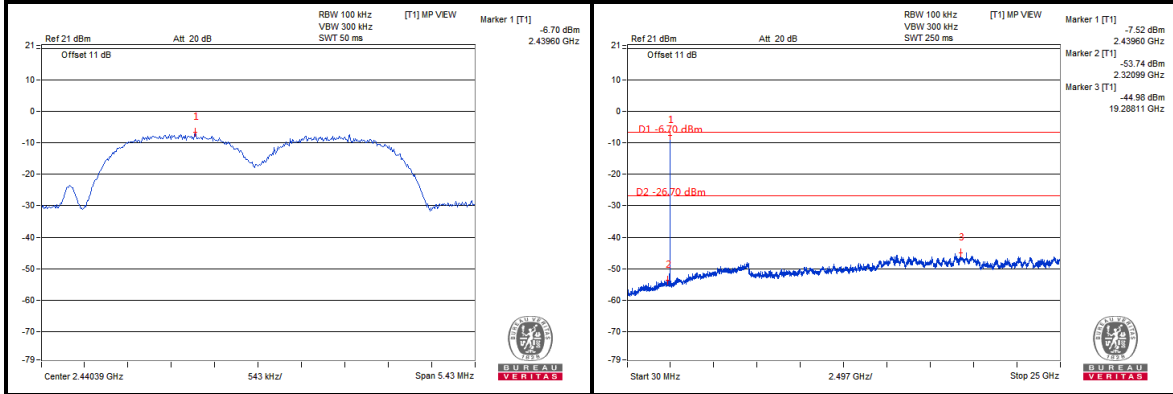

CH 37

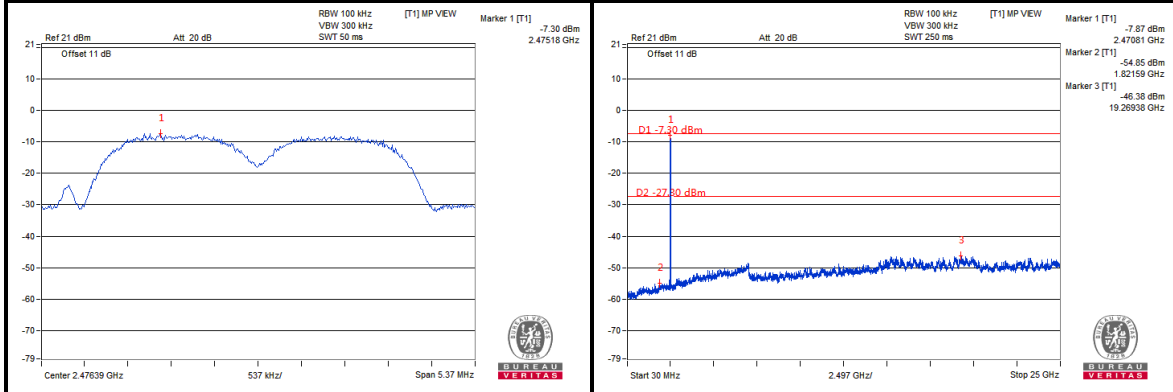

Bureau Veritas Shenzhen Co., Ltd.
Dongguan Branch

No. 96, Guantai Road (Houjie Section), Houjie
Town, Dongguan City, Guangdong Province.
523942, People's Republic of China.

Tel: +86 769 8998 2098
Fax: +86 769 8593 1080
Email: customerservice.dg@bureauveritas.com



BUREAU VERITAS

Test Report No.: RF2212WDG0234-1

Chain 1

CH 1

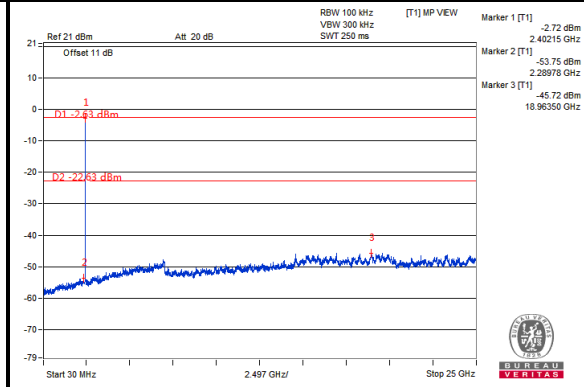
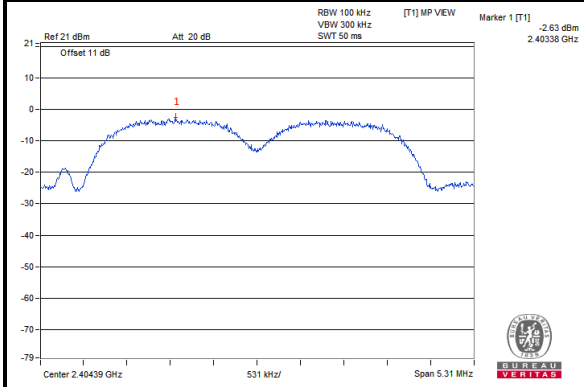

CH 19

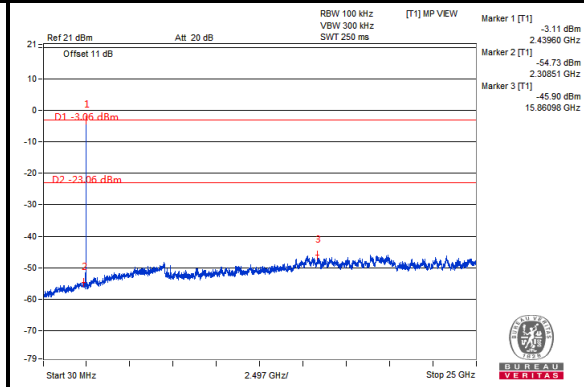
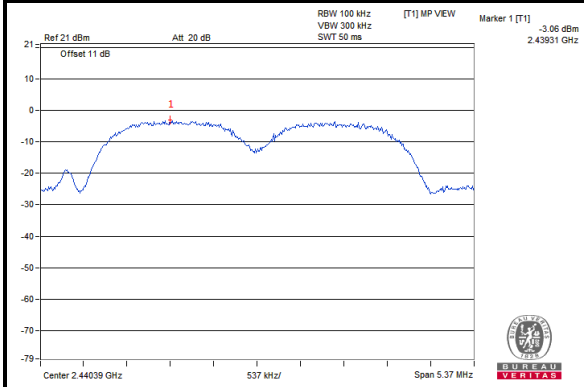

CH 37

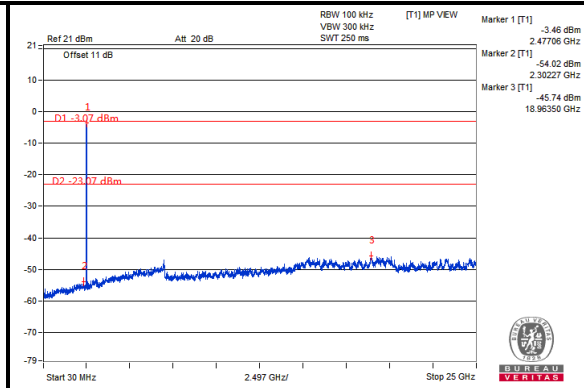
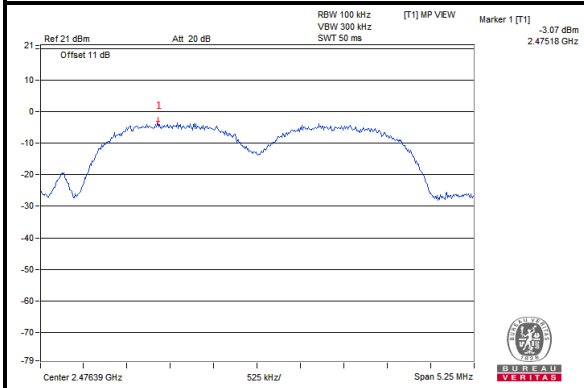

Bureau Veritas Shenzhen Co., Ltd. Dongguan Branch

No. 96, Guantai Road (Houjie Section), Houjie Town, Dongguan City, Guangdong Province. 523942. People's Republic of China.

Tel: +86 769 8998 2098 Fax: +86 769 8593 1080 Email: customerservice.dg@bureauveritas.com



BUREAU VERITAS

Test Report No.: RF2212WDG0234-1

II/4 DQPSK

Chain 0

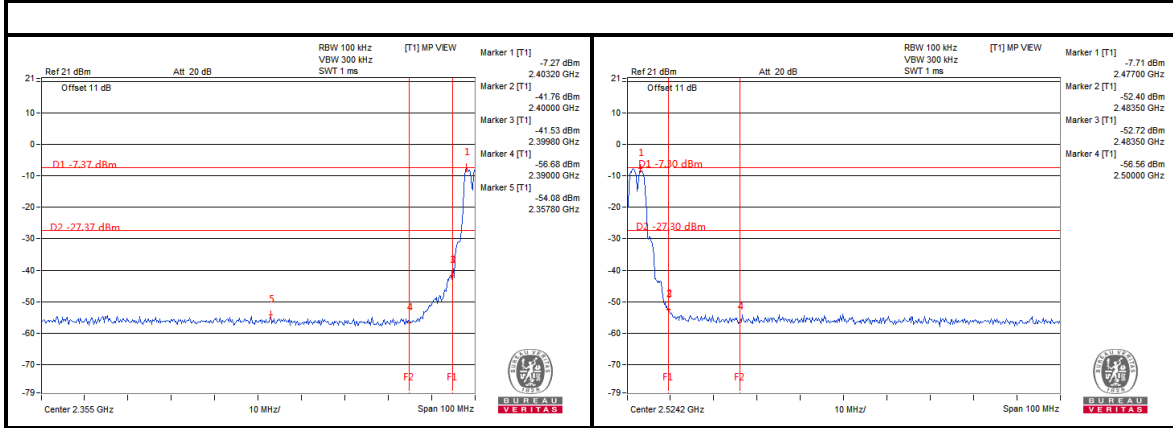

Chain 1

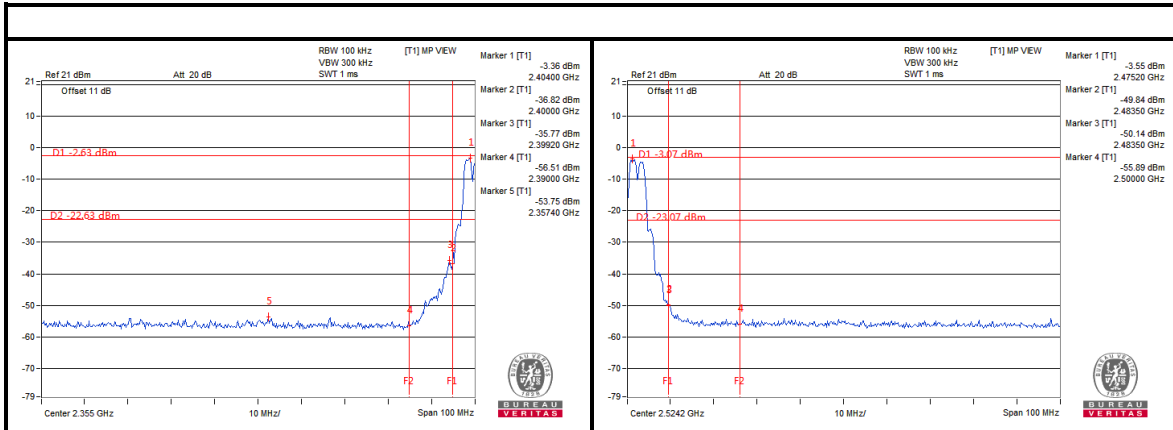

Bureau Veritas Shenzhen Co., Ltd.
Dongguan Branch

No. 96, Guantai Road (Houjie Section), Houjie
Town, Dongguan City, Guangdong Province.
523942, People's Republic of China.

Tel: +86 769 8998 2098
Fax: +86 769 8593 1080
Email: customerservice.dg@bureauveritas.com



**BUREAU
VERITAS**

Test Report No.: RF2212WDG0234-1

5 PHOTOGRAPHS OF THE TEST CONFIGURATION

Please refer to the attached file (Test Setup Photo).



**BUREAU
VERITAS**

Test Report No.: RF2212WDG0234-1

6 APPENDIX A - MODIFICATIONS RECORDERS FOR ENGINEERING CHANGES TO THE EUT BY THE LAB

No any modifications are made to the EUT by the lab during the test.

---END---