



## SAR EVALUATION REPORT

**Applicant Name:**  
 Samsung Electronics, Co. Ltd.  
 416 Maetan 3-Dong, Yeongtong-gu  
 Suwon-si, Gyeonggi-do  
 443-742, Republic of Korea

**Date of Testing:**  
 04/01/13 - 04/03/13  
**Test Site/Location:**  
 PCTEST Lab, Columbia, MD, USA  
**Document Serial No.:**  
 0Y1303280555-R1.A3L

**FCC ID:** A3LSMT310

**APPLICANT:** SAMSUNG ELECTRONICS, CO. LTD.

**DUT Type:** Portable Tablet Computer  
**Application Type:** Certification  
**FCC Rule Part(s):** CFR §2.1093  
**Model(s):** SM-T310  
**Test Device Serial No.:** Pre-Production [S/N: 4300a40b66a7218d]

Equipment Class	Band & Mode	Tx Frequency	Measured Conducted Power [dBm]	SAR
				1 gm Body (W/kg)
DTS	2.4 GHz WLAN	2412 - 2462 MHz	15.84	0.71
DTS	5.8 GHz WLAN	5745 - 5825 MHz	11.08	0.51
DTS	Bluetooth LE	2402 - 2480 MHz	7.49	N/A
NII	5.2 GHz WLAN	5180 - 5240 MHz	10.70	0.62
NII	5.3 GHz WLAN	5260 - 5320 MHz	10.40	0.66
NII	5.5 GHz WLAN	5500 - 5700 MHz	11.20	0.83
DSS	Bluetooth	2402 - 2480 MHz	11.72	<0.1

Note: Powers in the above table represent output powers for the SAR test configurations and may not represent the highest output powers for all configurations for each mode.



Note: The revised test report (S/N: 0Y1303280555-R1.A3L) supersedes and replaces the previously issued test report on the same subject DUT for the same type of testing indicated. Please discard or destroy the previously issued test report(s) and dispose of accordingly.

This wireless portable device has been shown to be capable of compliance for localized specific absorption rate (SAR) for uncontrolled environment/general population exposure limits specified in ANSI/IEEE C95.1-1992 and has been tested in accordance with the measurement procedures specified in Section 1.8 of this report; for North American frequency bands only.

I attest to the accuracy of data. All measurements reported herein were performed by me or were made under my supervision and are correct to the best of my knowledge and belief. I assume full responsibility for the completeness of these measurements and vouch for the qualifications of all persons taking them. Test results reported herein relate only to the item(s) tested.



  
 Randy Ortanez  
 President



<b>FCC ID:</b> A3LSMT310		<b>SAR EVALUATION REPORT</b>		<b>Reviewed by:</b> Quality Manager
<b>Document S/N:</b> 0Y1303280555-R1.A3L	<b>Test Dates:</b> 04/01/13 - 04/03/13	<b>DUT Type:</b> Portable Tablet Computer	Page 1 of 24	

# T A B L E O F C O N T E N T S

1	DEVICE UNDER TEST .....	3
2	INTRODUCTION .....	6
3	DOSIMETRIC ASSESSMENT .....	7
4	RF EXPOSURE LIMITS .....	8
5	FCC MEASUREMENT PROCEDURES.....	9
6	RF CONDUCTED POWERS.....	10
7	SYSTEM VERIFICATION.....	14
8	SAR DATA SUMMARY .....	16
9	SAR MEASUREMENT VARIABILITY .....	18
10	EQUIPMENT LIST.....	19
11	MEASUREMENT UNCERTAINTIES .....	20
12	CONCLUSION.....	22
13	REFERENCES .....	23
APPENDIX A:	SAR TEST PLOTS	
APPENDIX B:	SAR DIPOLE VERIFICATION PLOTS	
APPENDIX C:	PROBE AND DIPOLE CALIBRATION CERTIFICATES	
APPENDIX D:	SAR TISSUE SPECIFICATIONS	
APPENDIX E:	SAR SYSTEM VALIDATION	
APPENDIX F:	SAR TEST SETUP PHOTOGRAPHS	

<b>FCC ID:</b> A3LSMT310		<b>SAR EVALUATION REPORT</b>		<b>Reviewed by:</b> Quality Manager
<b>Document S/N:</b> 0Y1303280555-R1.A3L	<b>Test Dates:</b> 04/01/13 - 04/03/13	<b>DUT Type:</b> Portable Tablet Computer		Page 2 of 24

# 1 DEVICE UNDER TEST



## 1.1 Device Overview

Band & Mode	Operating Modes	Tx Frequency
2.4 GHz WLAN	Data	2412 - 2462 MHz
5.8 GHz WLAN	Data	5745 - 5825 MHz
Bluetooth LE	Data	2402 - 2480 MHz
5.2 GHz WLAN	Data	5180 - 5240 MHz
5.3 GHz WLAN	Data	5260 - 5320 MHz
5.5 GHz WLAN	Data	5500 - 5700 MHz
Bluetooth	Data	2402 - 2480 MHz

## 1.2 Nominal and Maximum Output Power Specifications

This device operates using the following maximum and nominal output power specifications. SAR values were scaled to the maximum allowed power to determine compliance per KDB Publication 447498 D01v05.

Mode / Band		Modulated Average (dBm)
IEEE 802.11b (2.4 GHz)	Maximum	<b>16.0</b>
	Nominal	<b>15.5</b>
IEEE 802.11g (2.4 GHz)	Maximum	<b>13.5</b>
	Nominal	<b>13.0</b>
IEEE 802.11n (2.4 GHz)	Maximum	<b>12.5</b>
	Nominal	<b>12.0</b>
IEEE 802.11a (5 GHz)	Maximum	<b>11.5</b>
	Nominal	<b>11.0</b>
IEEE 802.11n (5 GHz)	Maximum	<b>11.5</b>
	Nominal	<b>11.0</b>
Bluetooth	Maximum	<b>12.0</b>
	Nominal	<b>11.5</b>
Bluetooth LE	Maximum	<b>7.5</b>
	Nominal	<b>7.0</b>

FCC ID: A3LSMT310	 <b>PCTEST</b> ENGINEERING LABORATORY, INC.	<b>SAR EVALUATION REPORT</b>		Reviewed by: Quality Manager
Document S/N: 0Y1303280555-R1.A3L	Test Dates: 04/01/13 - 04/03/13	DUT Type: Portable Tablet Computer		Page 3 of 24

### 1.3 DUT Antenna Locations

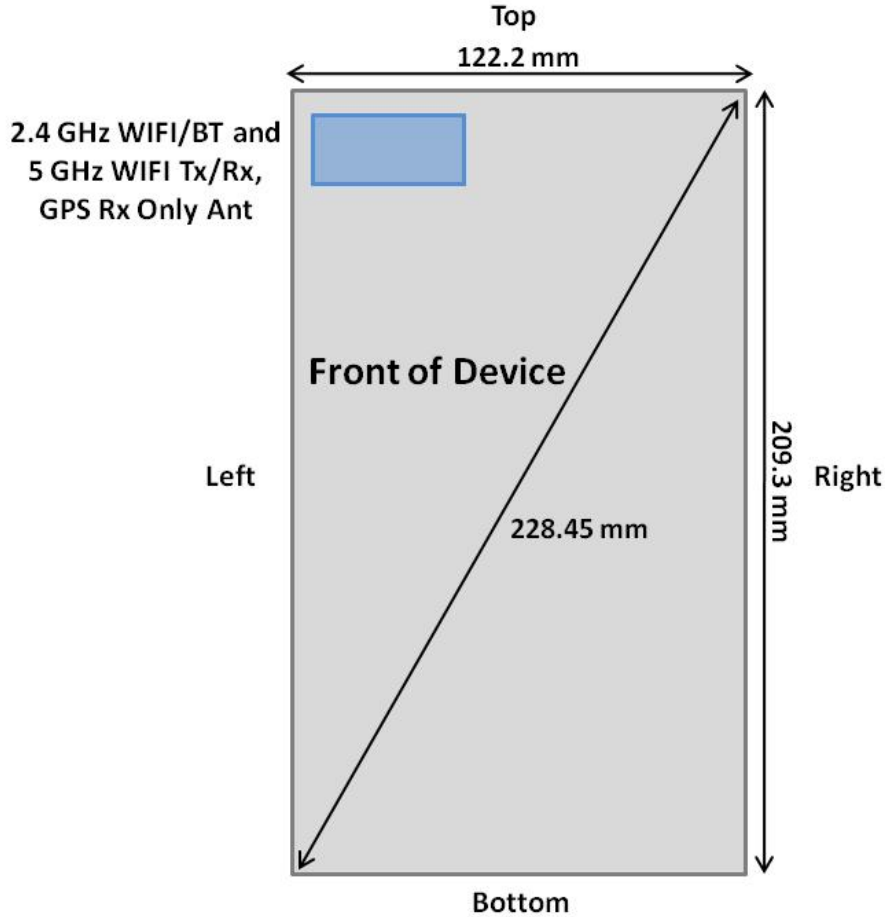

Note: Exact antenna dimensions and separation distances are shown in the Technical Descriptions in the FCC Filing.

**Figure 1-1**  
**DUT Antenna Locations**



**Table 1-1**  
**Sides for Body SAR Testing**

Sides for Body SAR Testing					
Back	Front	Top	Bottom	Right	Left
Yes	No	Yes	No	No	Yes

Note: Particular DUT edges were not required to be evaluated for SAR based on the SAR exclusion threshold in KDB 447498 D01v05. The antenna document shows the distances between the transmit antenna and the edges of the device.

### 1.4 Simultaneous Transmission Capabilities

There are no simultaneous transmission capabilities on this device; therefore no simultaneous transmission was required to be evaluated.

FCC ID: A3LSMT310		SAR EVALUATION REPORT		Reviewed by: Quality Manager
Document S/N: 0Y1303280555-R1.A3L	Test Dates: 04/01/13 - 04/03/13	DUT Type: Portable Tablet Computer	Page 4 of 24	

## 1.5 Power Reduction for SAR

There is no power reduction used for any band/mode implemented in this device for SAR purposes.

## 1.6 SAR Test Exclusions Applied

### (A) WIFI/BT

2.4 GHz WLAN and 5 GHz WLAN and Bluetooth share the same antenna path and cannot transmit simultaneously.

Per FCC KDB 447498 D01 v05, the SAR exclusion threshold for distances <50mm is defined by the following equation:



$$\frac{\text{Max Power of Channel (mW)}}{\text{Test Separation Dist (mm)}} * \sqrt{\text{Frequency(GHz)}} \leq 3.0$$

Based on the maximum conducted power of Bluetooth LE (rounded to the nearest mW) and the antenna to user separation distance, Bluetooth LE SAR was not required;  $[(6/5) * \sqrt{2.441}] = 1.9 < 3.0$ .

This device supports 20 MHz and 40 MHz Bandwidths for IEEE 802.11n for 5 GHz WIFI only. IEEE 802.11n was not evaluated for SAR since the average output power of 20 MHz and 40 MHz bandwidths was not more than 0.25 dB higher than the average output power of IEEE 802.11a.

## 1.7 Guidance Applied

- FCC KDB Publication 616217 D04v01 (Tablet SAR Considerations)
- FCC KDB Publication 248227 D01v01r02 (SAR Considerations for 802.11 Devices)
- FCC KDB Publication 447498 D01v05 (General SAR Guidance)
- FCC KDB Publication 865664 D01-D02 (SAR Measurements up to 6 GHz)

FCC ID: A3LSMT310		SAR EVALUATION REPORT		Reviewed by: Quality Manager
Document S/N: 0Y1303280555-R1.A3L	Test Dates: 04/01/13 - 04/03/13	DUT Type: Portable Tablet Computer	Page 5 of 24	

## 2 INTRODUCTION

The FCC and Industry Canada have adopted the guidelines for evaluating the environmental effects of radio frequency (RF) radiation in ET Docket 93-62 on Aug. 6, 1996 and Health Canada Safety Code 6 to protect the public and workers from the potential hazards of RF emissions due to FCC-regulated portable devices. [1]

The safety limits used for the environmental evaluation measurements are based on the criteria published by the American National Standards Institute (ANSI) for localized specific absorption rate (SAR) in IEEE/ANSI C95.1-1992 Standard for Safety Levels with Respect to Human Exposure to Radio Frequency Electromagnetic Fields, 3 kHz to 300 GHz [3] and Health Canada RF Exposure Guidelines Safety Code 6 [24]. The measurement procedure described in IEEE/ANSI C95.3-2002 Recommended Practice for the Measurement of Potentially Hazardous Electromagnetic Fields - RF and Microwave [4] is used for guidance in measuring the Specific Absorption Rate (SAR) due to the RF radiation exposure from the Equipment Under Test (EUT). These criteria for SAR evaluation are similar to those recommended by the International Committee for Non-Ionizing Radiation Protection (ICNIRP) in "Biological Effects and Exposure Criteria for Radiofrequency Electromagnetic Fields," Report No. Vol 74. SAR is a measure of the rate of energy absorption due to exposure to an RF transmitting source. SAR values have been related to threshold levels for potential biological hazards.

### 2.1 SAR Definition

Specific Absorption Rate is defined as the time derivative (rate) of the incremental energy (dU) absorbed by (dissipated in) an incremental mass (dm) contained in a volume element (dV) of a given density ( $\rho$ ). It is also defined as the rate of RF energy absorption per unit mass at a point in an absorbing body (see Equation 2-1).

**Equation 2-1**  
**SAR Mathematical Equation**

$$SAR = \frac{d}{dt} \left( \frac{dU}{dm} \right) = \frac{d}{dt} \left( \frac{dU}{\rho dv} \right)$$



**SAR is expressed in units of Watts per Kilogram (W/kg).**

$$SAR = \frac{\sigma \cdot E^2}{\rho}$$

where:

- $\sigma$  = conductivity of the tissue-simulating material (S/m)
- $\rho$  = mass density of the tissue-simulating material (kg/m<sup>3</sup>)
- E = Total RMS electric field strength (V/m)

NOTE: The primary factors that control rate of energy absorption were found to be the wavelength of the incident field in relation to the dimensions and geometry of the irradiated organism, the orientation of the organism in relation to the polarity of field vectors, the presence of reflecting surfaces, and whether conductive contact is made by the organism with a ground plane.[6]

FCC ID: A3LSMT310	 PCTEST ENGINEERING LABORATORY, INC.	SAR EVALUATION REPORT		Reviewed by: Quality Manager
Document S/N: 0Y1303280555-R1.A3L	Test Dates: 04/01/13 - 04/03/13	DUT Type: Portable Tablet Computer		Page 6 of 24

### 3 DOSIMETRIC ASSESSMENT

#### 3.1 Measurement Procedure

The evaluation was performed using the following procedure:

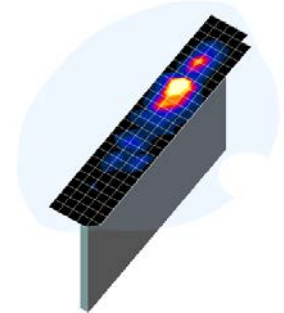

1. The SAR distribution at the exposed side of the head or body was measured at a distance no greater than 5.0 mm from the inner surface of the shell. The area covered the entire dimension of the device-head and body interface and the horizontal grid resolution was determined per FCC KDB Publication 865664 D01v01 (See Table 3-1).
2. The point SAR measurement was taken at the maximum SAR region determined from Step 1 to enable the monitoring of SAR fluctuations/drifts during the 1g/10g cube evaluation. SAR at this fixed point was measured and used as a reference value.
3. Based on the area scan data, the peak of the region with maximum SAR was determined by spline interpolation. Around this point, a volume was assessed according to the measurement resolution and volume size requirements of FCC KDB Publication 865664 D01v01 (See Table 3-1). On the basis of this data set, the spatial peak SAR value was evaluated with the following procedure (see references or the DASYS manual online for more details):
  - a. The data was extrapolated to the surface of the outer-shell of the phantom. The combined distance extrapolated was the combined distance from the center of the dipoles 2.7mm away from the tip of the probe housing plus the 1.2 mm distance between the surface and the lowest measuring point. The extrapolation was based on a least-squares algorithm. A polynomial of the fourth order was calculated through the points in the z-axis (normal to the phantom shell).
  - b. After the maximum interpolated values were calculated between the points in the cube, the SAR was averaged over the spatial volume (1g or 10g) using a 3D-Spline interpolation algorithm. The 3D-spline is composed of three one-dimensional splines with the “Not a knot” condition (in x, y, and z directions). The volume was then integrated with the trapezoidal algorithm. One thousand points (10 x 10 x 10) were obtained through interpolation, in order to calculate the averaged SAR.
  - c. All neighboring volumes were evaluated until no neighboring volume with a higher average value was found.
4. The SAR reference value, at the same location as step 2, was re-measured after the zoom scan was complete to calculate the SAR drift. If the drift deviated by more than 5%, the SAR test and drift measurements were repeated.



**Figure 3-1**  
**Sample SAR Area Scan**

**Table 3-1**  
**Area and Zoom Scan Resolutions per FCC KDB Publication 865664 D01v01**

Frequency	Maximum Area Scan Resolution (mm) ( $\Delta x_{\text{area}}, \Delta y_{\text{area}}$ )	Maximum Zoom Scan Resolution (mm) ( $\Delta x_{\text{zoom}}, \Delta y_{\text{zoom}}$ )	Maximum Zoom Scan Spatial Resolution (mm)			Minimum Zoom Scan Volume (mm) (x, y, z)
			Uniform Grid	Graded Grid		
			$\Delta z_{\text{zoom}}(n)$	$\Delta z_{\text{zoom}}(1)^*$	$\Delta z_{\text{zoom}}(n>1)^*$	
≤ 2 GHz	≤ 15	≤ 8	≤ 5	≤ 4	$\leq 1.5 * \Delta z_{\text{zoom}}(n-1)$	≥ 30
2-3 GHz	≤ 12	≤ 5	≤ 5	≤ 4	$\leq 1.5 * \Delta z_{\text{zoom}}(n-1)$	≥ 30
3-4 GHz	≤ 12	≤ 5	≤ 4	≤ 3	$\leq 1.5 * \Delta z_{\text{zoom}}(n-1)$	≥ 28
4-5 GHz	≤ 10	≤ 4	≤ 3	≤ 2.5	$\leq 1.5 * \Delta z_{\text{zoom}}(n-1)$	≥ 25
5-6 GHz	≤ 10	≤ 4	≤ 2	≤ 2	$\leq 1.5 * \Delta z_{\text{zoom}}(n-1)$	≥ 22

FCC ID: A3LSMT310		<b>SAR EVALUATION REPORT</b>		<b>Reviewed by:</b> Quality Manager
<b>Document S/N:</b> OY1303280555-R1.A3L	<b>Test Dates:</b> 04/01/13 - 04/03/13	<b>DUT Type:</b> Portable Tablet Computer	Page 7 of 24	

## 4 RF EXPOSURE LIMITS

### 4.1 Uncontrolled Environment

UNCONTROLLED ENVIRONMENTS are defined as locations where there is the exposure of individuals who have no knowledge or control of their exposure. The general population/uncontrolled exposure limits are applicable to situations in which the general public may be exposed or in which persons who are exposed as a consequence of their employment may not be made fully aware of the potential for exposure or cannot exercise control over their exposure. Members of the general public would come under this category when exposure is not employment-related; for example, in the case of a wireless transmitter that exposes persons in its vicinity.



### 4.2 Controlled Environment

CONTROLLED ENVIRONMENTS are defined as locations where there is exposure that may be incurred by persons who are aware of the potential for exposure, (i.e. as a result of employment or occupation). In general, occupational/controlled exposure limits are applicable to situations in which persons are exposed as a consequence of their employment, who have been made fully aware of the potential for exposure and can exercise control over their exposure. This exposure category is also applicable when the exposure is of a transient nature due to incidental passage through a location where the exposure levels may be higher than the general population/uncontrolled limits, but the exposed person is fully aware of the potential for exposure and can exercise control over his or her exposure by leaving the area or by some other appropriate means.

**Table 4-1**  
**SAR Human Exposure Specified in ANSI/IEEE C95.1-1992 and Health Canada Safety Code 6**

HUMAN EXPOSURE LIMITS		
	UNCONTROLLED ENVIRONMENT <i>General Population</i> (W/kg) or (mW/g)	CONTROLLED ENVIRONMENT <i>Occupational</i> (W/kg) or (mW/g)
<b>Peak Spatial Average SAR</b> Head	1.6	8.0
<b>Whole Body SAR</b>	0.08	0.4
<b>Peak Spatial Average SAR</b> Hands, Feet, Ankle, Wrists, etc.	4.0	20

1. The Spatial Peak value of the SAR averaged over any 1 gram of tissue (defined as a tissue volume in the shape of a cube) and over the appropriate averaging time.
2. The Spatial Average value of the SAR averaged over the whole body.
3. The Spatial Peak value of the SAR averaged over any 10 grams of tissue (defined as a tissue volume in the shape of a cube) and over the appropriate averaging time.

FCC ID: A3LSMT310	 PCTEST ENGINEERING LABORATORY, INC.	SAR EVALUATION REPORT	 SAMSUNG	Reviewed by: Quality Manager
Document S/N: 0Y1303280555-R1.A3L	Test Dates: 04/01/13 - 04/03/13	DUT Type: Portable Tablet Computer	Page 8 of 24	

## 5 FCC MEASUREMENT PROCEDURES

### 5.1 Measured and Reported SAR

Per FCC KDB Publication 447498 D01v05, When SAR is not measured at the maximum power level allowed for production units, the results must be scaled to the maximum tune-up tolerance limit according to the power applied to the individual channels tested to determine compliance. For simultaneous transmission, the measured aggregate SAR must be scaled according to the sum of the differences between the maximum tune-up tolerance and actual power used to test each transmitter. When SAR is measured at or scaled to the maximum tune-up tolerance limit, the results are referred to as *reported* SAR. The highest *reported* SAR results are identified on the grant of equipment authorization according to procedures in KDB 690783 D01v01r02.

### 5.2 SAR Testing with 802.11 Transmitters

Normal network operating configurations are not suitable for measuring the SAR of 802.11 a/b/g/n transmitters. Unpredictable fluctuations in network traffic and antenna diversity conditions can introduce undesirable variations in SAR results. The SAR for these devices should be measured using chipset based test mode software to ensure the results are consistent and reliable. See KDB Publication 248227 D01v01r02 for more details.

#### 5.2.1 General Device Setup

Chipset based test mode software is hardware dependent and generally varies among manufacturers. The device operating parameters established in test mode for SAR measurements must be identical to those programmed in production units, including output power levels, amplifier gain settings and other RF performance tuning parameters. The test frequencies should correspond to actual channel frequencies defined for domestic use. SAR for devices with switched diversity should be measured with only one antenna transmitting at a time during each SAR measurement, according to a fixed modulation and data rate. The same data pattern should be used for all measurements.

#### 5.2.2 Frequency Channel Configurations [27]



For 2.4 GHz, the highest average RF output power channel between the low, mid and high channel at the lowest data rate was selected for SAR evaluation in 802.11b mode. 802.11g/n modes and higher data rates for 802.11b were additionally evaluated for SAR if the output power of the respective mode was 0.25 dB or higher than the powers of the SAR configurations tested in the 802.11b mode.

For 5 GHz, the highest average RF output power channel across the default test channels at the lowest data rate was selected for SAR evaluation in 802.11a. When the adjacent channels are higher in power than the default channels, these "required channels" were considered instead of the default channels for SAR testing. 802.11n modes and higher data rates for 802.11a/n were evaluated only if the respective mode was 0.25 dB or higher than the 802.11a mode.

If the maximum extrapolated peak SAR of the zoom scan for the highest output channel was less than 1.6 W/kg or if the 1g averaged SAR was less than 0.8 W/kg, SAR testing was not required for the other test channels in the band.

### 5.3 SAR Testing for Tablet per KDB Publication 616217 D04v01

Per FCC KDB 616217, the back surface and edges of the tablet should be tested for SAR compliance with the tablet touching the phantom. The SAR Exclusion Threshold in KDB 447498 D01v05 can be applied to determine SAR test exclusion for adjacent edge configurations. The closest distance from the antenna to an adjacent tablet edge is used to determine if SAR testing is required for the adjacent edges, with the adjacent edge positioned against the phantom and the edge containing the antenna positioned perpendicular to the phantom.

FCC ID: A3LSMT310	 PCTEST ENGINEERING LABORATORY, INC.	SAR EVALUATION REPORT		Reviewed by: Quality Manager
Document S/N: 0Y1303280555-R1.A3L	Test Dates: 04/01/13 - 04/03/13	DUT Type: Portable Tablet Computer		Page 9 of 24

## 6 RF CONDUCTED POWERS

### 6.1 WLAN and Bluetooth Conducted Powers

**Table 7-1**  
**IEEE 802.11b Average RF Power**



Mode	Freq [MHz]	Channel	802.11b (2.4 GHz) Conducted Power [dBm]			
			Data Rate [Mbps]			
			1	2	5.5	11
802.11b	2412	1	15.83	15.90	15.90	15.90
802.11b	2437	6	15.84	15.81	15.88	15.90
802.11b	2462	11	15.75	15.85	15.86	15.85

**Table 7-2**  
**IEEE 802.11g Average RF Power**

Mode	Freq [MHz]	Channel	802.11g (2.4 GHz) Conducted Power [dBm]							
			Data Rate [Mbps]							
			6	9	12	18	24	36	48	54
802.11g	2412	1	13.02	13.20	13.15	13.10	13.15	13.12	13.12	13.10
802.11g	2437	6	13.00	13.07	13.02	13.00	13.11	13.00	13.11	13.05
802.11g	2462	11	13.05	13.02	13.20	13.10	13.00	13.05	13.00	12.98

**Table 7-3**  
**IEEE 802.11n Average RF Power**

Mode	Freq [MHz]	Channel	802.11n (2.4 GHz) Conducted Power [dBm]							
			Data Rate [Mbps]							
			6.5	13	20	26	39	52	58	65
802.11n	2412	1	11.90	11.98	12.00	12.05	11.95	12.00	12.10	11.93
802.11n	2437	6	11.85	11.85	11.96	11.91	11.92	11.85	11.86	11.96
802.11n	2462	11	11.93	11.92	11.91	11.88	11.92	11.80	11.95	11.75



FCC ID: A3LSMT310	 PCTEST ENGINEERING LABORATORY, INC.	SAR EVALUATION REPORT	 SAMSUNG	Reviewed by: Quality Manager
Document S/N: 0Y1303280555-R1.A3L	Test Dates: 04/01/13 - 04/03/13	DUT Type: Portable Tablet Computer		Page 10 of 24

**Table 7-4  
IEEE 802.11a Average RF Power**

Mode	Freq	Channel	802.11a (5GHz) Conducted Power [dBm]							
			Data Rate [Mbps]							
	[MHz]		6	9	12	18	24	36	48	54
802.11a	5180	36*	10.60	10.71	10.70	10.65	10.71	10.65	10.70	10.67
802.11a	5200	40	<b>10.70</b>	10.70	10.65	10.80	10.70	10.68	10.70	10.70
802.11a	5220	44	<b>10.58</b>	<b>10.57</b>	<b>10.55</b>	<b>10.64</b>	<b>10.55</b>	<b>10.60</b>	<b>10.60</b>	<b>10.48</b>
802.11a	5240	48*	<b>10.61</b>	10.55	10.50	10.50	10.45	10.54	10.60	10.55
802.11a	5260	52*	<b>10.40</b>	<b>10.35</b>	<b>10.38</b>	<b>10.60</b>	<b>10.58</b>	<b>10.50</b>	<b>10.45</b>	<b>10.46</b>
802.11a	5280	56	10.36	10.44	10.45	10.48	10.51	10.55	10.56	10.52
802.11a	5300	60	<b>10.38</b>	10.38	10.39	10.50	10.38	10.32	10.30	10.33
802.11a	5320	64*	<b>10.23</b>	<b>10.20</b>	<b>10.20</b>	<b>10.21</b>	<b>10.28</b>	<b>10.27</b>	<b>10.28</b>	<b>10.45</b>
802.11a	5500	100	11.17	11.24	11.20	11.21	11.22	11.28	11.30	11.20
802.11a	5520	104*	<b>11.20</b>	11.18	11.20	11.22	11.20	11.22	11.29	11.18
802.11a	5540	108	11.20	11.22	11.19	11.12	11.21	11.28	11.25	11.19
802.11a	5560	112	<b>11.11</b>	11.15	11.06	11.06	11.05	11.04	11.20	11.20
802.11a	5580	116*	11.10	11.00	11.11	11.07	11.00	11.07	11.10	10.99
802.11a	5600	120	N/A	N/A	N/A	N/A	N/A	N/A	N/A	N/A
802.11a	5620	124*	N/A	N/A	N/A	N/A	N/A	N/A	N/A	N/A
802.11a	5640	128	N/A	N/A	N/A	N/A	N/A	N/A	N/A	N/A
802.11a	5660	132	<b>10.82</b>	10.84	10.80	10.83	10.85	10.80	10.80	10.85
802.11a	5680	136*	10.76	10.80	10.80	10.88	10.70	10.75	10.76	10.72
802.11a	5700	140	10.71	10.75	10.75	10.76	10.75	10.71	10.75	10.78
802.11a	5745	149*	<b>11.08</b>	11.02	11.03	11.10	11.06	11.06	11.10	11.22
802.11a	5765	153	<b>11.02</b>	11.02	11.02	11.12	11.00	10.97	11.05	11.05
802.11a	5785	157*	<b>10.95</b>	11.00	11.00	10.95	11.05	11.05	11.00	11.00
802.11a	5805	161*	<b>11.05</b>	11.00	11.11	11.06	11.00	11.00	11.00	11.12
802.11a	5825	165	10.90	10.94	10.86	11.02	10.86	10.92	11.00	10.90

Per FCC KDB Publication 443999 and RSS-210 A9.2(3), transmission on channels which overlap the 5600-5650 MHz is prohibited as a client. This device does not transmit any beacons or initiate any transmissions in 5.3 and 5.5 GHz Band.

(\*) – indicates default channels per KDB Publication 248227 D01v01r02. When the adjacent channels are higher in power then the default channels, these “required channels” are considered for SAR testing instead of the default channels.

FCC ID: A3LSMT310	 <b>PCTEST</b> ENGINEERING LABORATORY, INC.	<b>SAR EVALUATION REPORT</b>		Reviewed by: Quality Manager
Document S/N: 0Y1303280555-R1.A3L	Test Dates: 04/01/13 - 04/03/13	DUT Type: Portable Tablet Computer	Page 11 of 24	

**Table 7-5**  
**IEEE 802.11n Average RF Power – 20 MHz Bandwidth**

Mode	Freq	Channel	20MHz BW 802.11n (5GHz) Conducted Power [dBm]							
			Data Rate [Mbps]							
	[MHz]		6.5	13	20	26	39	52	58	65
802.11n	5180	36	10.58	10.62	10.60	10.59	10.56	10.61	10.66	10.62
802.11n	5200	40	10.55	10.60	10.51	10.56	10.50	10.55	10.55	10.58
802.11n	5220	44	10.44	10.44	10.40	10.45	10.40	10.46	10.50	10.45
802.11n	5240	48	10.42	10.40	10.41	10.47	10.42	10.45	10.42	10.46
802.11n	5260	52	10.35	10.37	10.45	10.48	10.40	10.40	10.50	10.44
802.11n	5280	56	10.31	10.30	10.31	10.32	10.26	10.35	10.35	10.36
802.11n	5300	60	10.26	10.30	10.25	10.25	10.30	10.25	10.30	10.31
802.11n	5320	64	10.25	10.21	10.22	10.20	10.20	10.20	10.21	10.20
802.11n	5500	100	10.50	10.60	10.55	10.55	10.61	10.60	10.50	10.51
802.11n	5520	104	10.60	10.50	10.50	10.53	10.45	10.52	10.51	10.48
802.11n	5540	108	10.40	10.40	10.45	10.45	10.40	10.41	10.45	10.41
802.11n	5560	112	10.33	10.41	10.40	10.45	10.35	10.28	10.30	10.39
802.11n	5580	116	10.25	10.31	10.32	10.30	10.35	10.21	10.21	10.30
802.11n	5600	120	N/A	N/A	N/A	N/A	N/A	N/A	N/A	N/A
802.11n	5620	124	N/A	N/A	N/A	N/A	N/A	N/A	N/A	N/A
802.11n	5640	128	N/A	N/A	N/A	N/A	N/A	N/A	N/A	N/A
802.11n	5660	132	10.10	10.10	10.12	10.10	10.10	9.99	10.10	10.15
802.11n	5680	136	10.10	10.01	9.99	10.01	10.01	10.01	9.90	10.12
802.11n	5700	140	9.95	9.99	9.99	9.91	9.95	9.90	9.95	9.98
802.11n	5745	149	11.32	11.28	11.32	11.28	11.32	11.28	11.25	11.15
802.11n	5765	153	11.30	11.22	11.15	11.31	11.30	11.25	11.30	11.30
802.11n	5785	157	11.12	11.10	11.22	11.00	11.11	11.15	11.11	11.11
802.11n	5805	161	11.10	11.12	11.15	11.05	11.00	11.00	11.10	11.06
802.11n	5825	165	11.05	11.01	11.12	11.00	11.00	11.10	11.00	11.15



Per FCC KDB Publication 443999 and RSS-210 A9.2(3), transmission on channels which overlap the 5600-5650 MHz is prohibited as a client. This device does not transmit any beacons or initiate any transmissions in 5.3 and 5.5 GHz Band.

**Table 7-6**  
**IEEE 802.11n Average RF Power – 40 MHz Bandwidth**

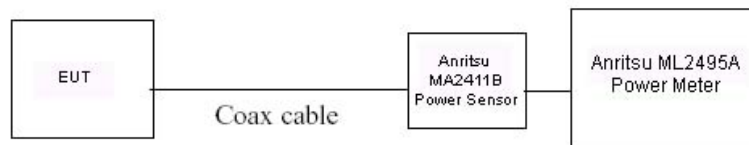
Mode	Freq	Channel	40MHz BW 802.11n (5GHz) Conducted Power [dBm]							
			Data Rate [Mbps]							
	[MHz]		13.5/15	27/30	40.5/45	54/60	81/90	108/120	121.5/135	135/150
802.11n	5190	38	10.10	10.00	10.05	10.10	10.10	10.00	10.00	9.96
802.11n	5230	46	10.00	9.90	9.98	9.98	9.90	9.95	9.83	9.95
802.11n	5270	54	9.85	9.85	9.88	9.88	9.81	9.85	9.95	9.75
802.11n	5310	62	9.71	9.75	9.70	9.62	9.60	9.72	9.77	9.70
802.11n	5510	102	10.04	9.90	9.95	10.00	10.00	10.00	9.95	9.95
802.11n	5550	110	9.80	9.85	9.83	9.97	9.90	9.90	9.75	9.75
802.11n	5590	118	N/A	N/A	N/A	N/A	N/A	N/A	N/A	N/A
802.11n	5630	126	N/A	N/A	N/A	N/A	N/A	N/A	N/A	N/A
802.11n	5670	134	9.40	9.46	9.44	9.40	9.42	9.40	9.22	9.35
802.11n	5755	151	9.70	9.70	9.62	9.59	9.70	9.75	9.60	9.50
802.11n	5795	159	9.50	9.50	9.50	9.40	9.50	9.55	9.50	9.50

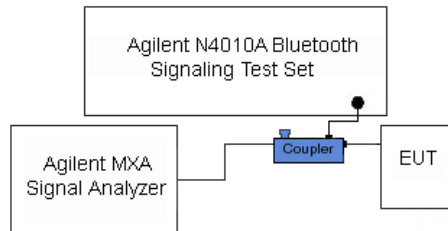

**Figure 7-1**  
**Power Measurement Setup**

FCC ID: A3LSMT310		SAR EVALUATION REPORT		Reviewed by: Quality Manager
Document S/N: OY1303280555-R1.A3L	Test Dates: 04/01/13 - 04/03/13	DUT Type: Portable Tablet Computer		Page 12 of 24

**Table 7-7  
Bluetooth RF Conducted Powers**



Frequency [MHz]	Data Rate [Mbps]	Channel No.	Peak Conducted Power		Avg Conducted Power	
			[dBm]	[mW]	[dBm]	[mW]
2402	1.0	0	12.457	17.608	<b>11.720</b>	<b>14.858</b>
2441	1.0	39	12.381	17.302	11.692	14.762
2480	1.0	78	11.815	15.188	11.081	12.826
2402	2.0	0	11.566	14.342	8.902	7.767
2441	2.0	39	11.918	15.552	9.455	8.820
2480	2.0	78	11.527	14.213	8.887	7.739
2402	3.0	0	11.848	15.304	8.975	7.897
2441	3.0	39	12.137	16.357	9.501	8.915
2480	3.0	78	11.783	15.076	8.881	7.728



**Figure 7-2  
Power Measurement Setup**

Justification for reduced test configurations for WIFI channels per KDB Publication 248227 D01v01r02 and October 2012 FCC/TCB Meeting Notes:

- For 2.4 GHz, highest average RF output power channel for the lowest data rate for IEEE 802.11b were selected for SAR evaluation. Other IEEE 802.11 modes (including 802.11g/n) were not investigated since the average output powers over all channels and data rates were not more than 0.25 dB higher than the tested channel in the lowest data rate of IEEE 802.11b mode.
- For 5 GHz, highest average RF output power channel for the lowest data rate for IEEE 802.11a were selected for SAR evaluation. Other IEEE 802.11 modes (including 802.11n 20 MHz and 40 MHz) were not investigated since the average output powers over all channels and data rates were not more than 0.25 dB higher than the tested channel in the lowest data rate of IEEE 802.11a mode.
- When the maximum extrapolated peak SAR of the zoom scan for the maximum output channel is <1.6 W/kg and the reported 1g averaged SAR is <0.8 W/kg, SAR testing on other channels is not required. Otherwise, the other default (or corresponding required) test channels were additionally tested using the lowest data rate.
- The bolded data rate and channel above were tested for SAR.

FCC ID: A3LSMT310		SAR EVALUATION REPORT		Reviewed by: Quality Manager
Document S/N: 0Y1303280555-R1.A3L	Test Dates: 04/01/13 - 04/03/13	DUT Type: Portable Tablet Computer	Page 13 of 24	



# 7 SYSTEM VERIFICATION

## 7.1 Tissue Verification

**Table 8-1  
Measured Tissue Properties**

Calibrated for Tests Performed on:	Tissue Type	Tissue Temp During Calibration (C°)	Measured Frequency (MHz)	Measured Conductivity, $\sigma$ (S/m)	Measured Dielectric Constant, $\epsilon$	TARGET Conductivity, $\sigma$ (S/m)	TARGET Dielectric Constant, $\epsilon$	% dev $\sigma$	% dev $\epsilon$
04/01/2013	2450B	24.1	2401	1.948	51.420	1.903	52.765	2.36%	-2.55%
			2450	2.011	51.233	1.950	52.700	3.13%	-2.78%
			2499	2.077	51.020	2.019	52.638	2.87%	-3.07%
04/03/2013	2450B	23.6	2401	1.881	52.794	1.903	52.765	-1.16%	0.05%
			2450	1.947	52.639	1.950	52.700	-0.15%	-0.12%
			2499	2.013	52.433	2.019	52.638	-0.30%	-0.39%
04/01/2013	5200B-5800B	24.1	5200	5.252	48.233	5.299	49.014	-0.89%	-1.59%
			5240	5.285	48.190	5.346	48.933	-1.14%	-1.52%
			5260	5.330	48.088	5.369	48.906	-0.73%	-1.67%
			5300	5.380	48.024	5.416	48.851	-0.66%	-1.69%
			5500	5.669	47.593	5.650	48.580	0.34%	-2.03%
			5520	5.705	47.538	5.673	48.553	0.56%	-2.09%
			5560	5.761	47.422	5.720	48.499	0.72%	-2.22%
			5600	5.817	47.365	5.766	48.444	0.88%	-2.23%
			5660	5.907	47.227	5.837	48.363	1.20%	-2.35%
			5745	6.047	47.018	5.936	48.248	1.87%	-2.55%
			5765	6.080	47.016	5.959	48.220	2.03%	-2.50%
			5800	6.124	46.860	6.000	48.200	2.07%	-2.78%
5805	6.140	46.866	6.005	48.166	2.25%	-2.70%			

The above measured tissue parameters were used in the DASY software. The DASY software was used to perform interpolation to determine the dielectric parameters at the SAR test device frequencies (per IEEE 1528 6.6.1.2). The tissue parameters listed in the SAR test plots may slightly differ from the table above due to significant digit rounding in the software.

FCC ID: A3LSMT310		SAR EVALUATION REPORT			Reviewed by: Quality Manager
Document S/N: 0Y1303280555-R1.A3L	Test Dates: 04/01/13 - 04/03/13	DUT Type: Portable Tablet Computer		Page 14 of 24	

## 7.2 Test System Verification

Prior to SAR assessment, the system is verified to  $\pm 10\%$  of the SAR measurement on the reference dipole at the time of calibration by the calibration facility. Full system validation status and result summary can be found in Appendix E.

**Table 8-2**  
**System Verification Results**

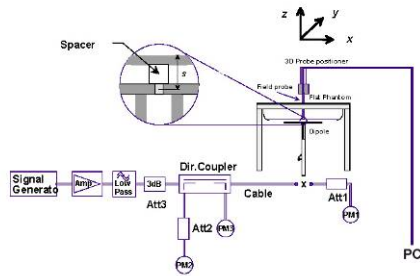

System Verification TARGET & MEASURED											
Tissue Frequency (MHz)	Tissue Type	Date:	Amb. Temp (°C)	Liquid Temp (°C)	Input Power (W)	Dipole SN	Probe SN	Measured SAR <sub>1g</sub> (W/kg)	1 W Target SAR <sub>1g</sub> (W/kg)	1 W Normalized SAR <sub>1g</sub>	Deviation (%)
2450	BODY	04/01/2013	24.3	24.0	0.100	719	3022	5.440	51.600	54.400	5.43%
2450	BODY	04/03/2013	24.1	23.3	0.100	719	3287	4.990	51.600	49.900	-3.29%
5200	BODY	04/01/2013	24.3	23.2	0.100	1057	3589	7.410	75.500	74.100	-1.85%
5300	BODY	04/01/2013	24.3	23.2	0.100	1057	3589	7.220	75.300	72.200	-4.12%
5500	BODY	04/01/2013	24.3	23.2	0.100	1057	3589	8.070	80.800	80.700	-0.12%
5600	BODY	04/01/2013	24.4	23.3	0.100	1057	3589	8.020	80.300	80.200	-0.12%
5800	BODY	04/01/2013	24.4	23.3	0.100	1057	3589	7.490	75.100	74.900	-0.27%



**Figure 8-1**  
**System Verification Setup Diagram**



**Figure 8-2**  
**System Verification Setup Photo**

FCC ID: A3LSMT310	 PCTEST ENGINEERING LABORATORY, INC.	SAR EVALUATION REPORT	 SAMSUNG	Reviewed by: Quality Manager
Document S/N: 0Y1303280555-R1.A3L	Test Dates: 04/01/13 - 04/03/13	DUT Type: Portable Tablet Computer	Page 15 of 24	

# 8 SAR DATA SUMMARY



## 8.1 Standalone Body SAR Data

**Table 9-1  
DTS Body SAR**

MEASUREMENT RESULTS															
FREQUENCY		Mode	Service	Maximum Allowed Power [dBm]	Conducted Power [dBm]	Power Drift [dB]	Spacing	Device Serial Number	Data Rate (Mbps)	Side	Duty Cycle	SAR (1g)	Scaling Factor	Scaled SAR (1g)	Plot #
MHz	Ch.											(W/kg)		(W/kg)	
2412	1	IEEE 802.11b	DSSS	16.0	15.83	0.06	0 mm	4300a40b66a7218d	1	back	1:1	0.611	1.040	0.635	
2437	6	IEEE 802.11b	DSSS	16.0	15.84	-0.17	0 mm	4300a40b66a7218d	1	back	1:1	0.680	1.038	0.706	A2
2462	11	IEEE 802.11b	DSSS	16.0	15.75	0.02	0 mm	4300a40b66a7218d	1	back	1:1	0.600	1.059	0.635	
2437	6	IEEE 802.11b	DSSS	16.0	15.84	0.02	0 mm	4300a40b66a7218d	1	top	1:1	0.450	1.038	0.467	
2437	6	IEEE 802.11b	DSSS	16.0	15.84	0.00	0 mm	4300a40b66a7218d	1	left	1:1	0.160	1.038	0.166	
5745	149	IEEE 802.11a	OFDM	11.5	11.08	-0.07	0 mm	4300a40b66a7218d	6	back	1:1	0.459	1.102	0.506	A4
5765	153	IEEE 802.11a	OFDM	11.5	11.02	0.15	0 mm	4300a40b66a7218d	6	back	1:1	0.438	1.117	0.489	
5805	161	IEEE 802.11a	OFDM	11.5	11.05	-0.12	0 mm	4300a40b66a7218d	6	back	1:1	0.381	1.109	0.423	
5745	149	IEEE 802.11a	OFDM	11.5	11.08	0.02	0 mm	4300a40b66a7218d	6	top	1:1	0.409	1.102	0.451	
5765	153	IEEE 802.11a	OFDM	11.5	11.02	0.08	0 mm	4300a40b66a7218d	6	top	1:1	0.376	1.117	0.420	
5805	161	IEEE 802.11a	OFDM	11.5	11.05	0.12	0 mm	4300a40b66a7218d	6	top	1:1	0.323	1.109	0.358	
5745	149	IEEE 802.11a	OFDM	11.5	11.08	0.14	0 mm	4300a40b66a7218d	6	left	1:1	0.051	1.102	0.056	
ANSI / IEEE C95.1 1992 - SAFETY LIMIT Spatial Peak Uncontrolled Exposure/General Population							Body 1.6 W/kg (mW/g) averaged over 1 gram								

**Table 9-2  
NII Body SAR**

MEASUREMENT RESULTS															
FREQUENCY		Mode	Service	Maximum Allowed Power [dBm]	Conducted Power [dBm]	Power Drift [dB]	Spacing	Device Serial Number	Data Rate (Mbps)	Side	Duty Cycle	SAR (1g)	Scaling Factor	Scaled SAR (1g)	Plot #
MHz	Ch.											(W/kg)		(W/kg)	
5200	40	IEEE 802.11a	OFDM	11.5	10.70	-0.05	0 mm	4300a40b66a7218d	6	back	1:1	0.495	1.202	0.595	
5240	48	IEEE 802.11a	OFDM	11.5	10.61	0.10	0 mm	4300a40b66a7218d	6	back	1:1	0.502	1.227	0.616	
5200	40	IEEE 802.11a	OFDM	11.5	10.70	0.06	0 mm	4300a40b66a7218d	6	top	1:1	0.448	1.202	0.538	
5240	48	IEEE 802.11a	OFDM	11.5	10.61	-0.01	0 mm	4300a40b66a7218d	6	top	1:1	0.446	1.227	0.547	
5200	40	IEEE 802.11a	OFDM	11.5	10.70	0.12	0 mm	4300a40b66a7218d	6	left	1:1	0.261	1.202	0.314	
5260	52	IEEE 802.11a	OFDM	11.5	10.40	-0.14	0 mm	4300a40b66a7218d	6	back	1:1	0.515	1.288	0.663	
5300	60	IEEE 802.11a	OFDM	11.5	10.38	-0.10	0 mm	4300a40b66a7218d	6	back	1:1	0.504	1.294	0.652	
5260	52	IEEE 802.11a	OFDM	11.5	10.40	0.16	0 mm	4300a40b66a7218d	6	top	1:1	0.471	1.288	0.607	
5300	60	IEEE 802.11a	OFDM	11.5	10.38	0.03	0 mm	4300a40b66a7218d	6	top	1:1	0.473	1.294	0.612	
5260	52	IEEE 802.11a	OFDM	11.5	10.40	0.12	0 mm	4300a40b66a7218d	6	left	1:1	0.304	1.288	0.392	
5300	60	IEEE 802.11a	OFDM	11.5	10.38	0.13	0 mm	4300a40b66a7218d	6	left	1:1	0.306	1.294	0.396	
5520	104	IEEE 802.11a	OFDM	11.5	11.20	0.03	0 mm	4300a40b66a7218d	6	back	1:1	0.761	1.072	0.816	A3
5560	112	IEEE 802.11a	OFDM	11.5	11.11	-0.14	0 mm	4300a40b66a7218d	6	back	1:1	0.754	1.094	0.825	
5660	132	IEEE 802.11a	OFDM	11.5	10.82	-0.07	0 mm	4300a40b66a7218d	6	back	1:1	0.602	1.169	0.704	
5520	104	IEEE 802.11a	OFDM	11.5	11.20	0.11	0 mm	4300a40b66a7218d	6	top	1:1	0.720	1.072	0.772	
5560	112	IEEE 802.11a	OFDM	11.5	11.11	0.08	0 mm	4300a40b66a7218d	6	top	1:1	0.717	1.094	0.784	
5660	132	IEEE 802.11a	OFDM	11.5	10.82	0.17	0 mm	4300a40b66a7218d	6	top	1:1	0.551	1.169	0.644	
5520	104	IEEE 802.11a	OFDM	11.5	11.20	0.19	0 mm	4300a40b66a7218d	6	left	1:1	0.214	1.072	0.229	
ANSI / IEEE C95.1 1992 - SAFETY LIMIT Spatial Peak Uncontrolled Exposure/General Population							Body 1.6 W/kg (mW/g) averaged over 1 gram								

FCC ID: A3LSMT310		SAR EVALUATION REPORT		Reviewed by: Quality Manager
Document S/N: OY1303280555-R1.A3L	Test Dates: 04/01/13 - 04/03/13	DUT Type: Portable Tablet Computer		Page 16 of 24

**Table 9-3  
DSS Body SAR**

MEASUREMENT RESULTS															
FREQUENCY		Mode	Service	Maximum Allowed Power [dBm]	Conducted Power [dBm]	Power Drift [dB]	Spacing	Device Serial Number	Data Rate (Mbps)	Side	Duty Cycle	SAR (1g)	Scaling Factor	Scaled SAR (1g)	Plot #
MHz	Ch.											(W/kg)		(W/kg)	
2402	0	2.4 GHz Bluetooth	FHSS	12.0	11.72	-0.19	0 mm	4300a40b66a7218d	1	back	1:1	0.080	1.067	0.085	A1
2402	0	2.4 GHz Bluetooth	FHSS	12.0	11.72	-0.13	0 mm	4300a40b66a7218d	1	top	1:1	0.034	1.067	0.036	
2402	0	2.4 GHz Bluetooth	FHSS	12.0	11.72	0.13	0 mm	4300a40b66a7218d	1	left	1:1	0.011	1.067	0.012	
ANSI / IEEE C95.1 1992 - SAFETY LIMIT Spatial Peak Uncontrolled Exposure/General Population							Body 1.6 W/kg (mW/g) averaged over 1 gram								



## 8.2 SAR Test Notes

### General Notes:

1. The test data reported are the worst-case SAR values according to test procedures specified in FCC KDB Publication 616217 D04.
2. Batteries are fully charged at the beginning of the SAR measurements. A standard battery was used for all SAR measurements.
3. Liquid tissue depth was at least 15.0 cm for all frequencies.
4. The manufacturer has confirmed that the device(s) tested have the same physical, mechanical and thermal characteristics and are within operational tolerances expected for production units.
5. SAR results were scaled to the maximum allowed power to demonstrate compliance per FCC KDB Publication 447498 D01v05.
6. Per FCC KDB 865664 D01 v01, since the measured SAR results for a frequency band were less than 0.8 W/kg, variability SAR tests were not performed. Please see Section 10 for variability analysis.

### BT/WLAN Notes:

1. Justification for reduced test configurations for WIFI channels per KDB Publication 248227 D01v01r02 and October 2012 FCC/TCB Meeting Notes for 2.4 GHz WIFI: Highest average RF output power channel for the lowest data rate was selected for SAR evaluation in 802.11b. Other IEEE 802.11 modes (including 802.11g/n) were not investigated since the average output powers over all channels and data rates were not more than 0.25 dB higher than the tested channel in the lowest data rate of IEEE 802.11b mode.
2. Justification for reduced test configurations for WIFI channels per KDB Publication 248227 D01v01r02 and October 2012 FCC/TCB Meeting Notes for 5 GHz WIFI: Highest average RF output power channel for the lowest data rate was selected for SAR evaluation in 802.11a. Other IEEE 802.11 modes (including 802.11n 20 MHz and 40 MHz bandwidths) were not investigated since the average output powers over all channels and data rates were not more than 0.25 dB higher than the tested channel in the lowest data rate of IEEE 802.11a mode.
3. WIFI transmission was verified using an uncalibrated spectrum analyzer.
4. Even though the reported 1g averaged SAR is <0.8 W/kg, SAR testing on other default channels for IEEE 802.11b mode was required when the maximum extrapolated peak SAR of the zoom scan for the maximum output channel is >1.6 W/kg.

FCC ID: A3LSMT310		<b>SAR EVALUATION REPORT</b>		Reviewed by: Quality Manager
Document S/N: 0Y1303280555-R1.A3L	Test Dates: 04/01/13 - 04/03/13	DUT Type: Portable Tablet Computer	Page 17 of 24	

# 9

# SAR MEASUREMENT VARIABILITY

## 9.1 Measurement Variability

Per FCC KDB Publication 865664 D01v01, SAR measurement variability was assessed for each frequency band, which was determined by the SAR probe calibration point and tissue-equivalent medium used for the device measurements. When both head and body tissue-equivalent media were required for SAR measurements in a frequency band, the variability measurement procedures were applied to the tissue medium with the highest measured SAR, using the highest measured SAR configuration for that tissue-equivalent medium. These additional measurements were repeated after the completion of all measurements requiring the same head or body tissue-equivalent medium in a frequency band. The test device was returned to ambient conditions (normal room temperature) with the battery fully charged before it was re-mounted on the device holder for the repeated measurement(s) to minimize any unexpected variations in the repeated results.



SAR Measurement Variability was assessed using the following procedures for each frequency band:

- 1) When the original highest measured SAR is  $\geq 0.80$  W/kg, the measurement was repeated once.
- 2) A second repeated measurement was performed only if the ratio of largest to smallest SAR for the original and first repeated measurements was  $> 1.20$  or when the original or repeated measurement was  $\geq 1.45$  W/kg (~ 10% from the 1-g SAR limit).
- 3) A third repeated measurement was performed only if the original, first or second repeated measurement was  $\geq 1.5$  W/kg and the ratio of largest to smallest SAR for the original, first and second repeated measurements is  $> 1.20$ .
- 4) Repeated measurements are not required when the original highest measured SAR is  $< 0.80$  W/kg

**Note:** All measured SAR values were  $< 0.8$  W/kg. Therefore, no SAR measurement variability analysis was required.

## 9.2 Measurement Uncertainty



The measured SAR was  $< 1.5$  W/kg for all frequency bands. Therefore, per KDB Publication 865664 D01v01, the extended measurement uncertainty analysis per IEEE 1528-2003 was not required.

FCC ID: A3LSMT310	 PCTEST ENGINEERING LABORATORY, INC.	SAR EVALUATION REPORT		Reviewed by: Quality Manager
Document S/N: 0Y1303280555-R1.A3L	Test Dates: 04/01/13 - 04/03/13	DUT Type: Portable Tablet Computer	Page 18 of 24	

# 10 EQUIPMENT LIST

Manufacturer	Model	Description	Cal Date	Cal Interval	Cal Due	Serial Number
Agilent	85047A	S-Parameter Test Set	N/A	N/A	N/A	2904A00579
Agilent	85070E	Dielectric Probe Kit	2/14/2013	Annual	2/14/2014	MY44300633
Agilent	8594A	(9kHz-2.9GHz) Spectrum Analyzer	N/A	N/A	N/A	3051A00187
Agilent	8648D	(9kHz-4GHz) Signal Generator	10/10/2012	Annual	10/10/2013	3613A00315
Agilent	8753E	(30kHz-6GHz) Network Analyzer	4/4/2012	Annual	4/4/2013	JP38020182
Agilent	E8257D	(250kHz-20GHz) Signal Generator	4/5/2012	Annual	4/5/2013	MY45470194
Agilent	N9020A	MXA Signal Analyzer	10/9/2012	Annual	10/9/2013	US46470561
Agilent	N4010A	Wireless Connectivity Test Set	N/A	N/A	N/A	GB44450273
Agilent	MA24106A	USB Power Sensor	12/7/2012	Annual	12/7/2013	1244512
Agilent	MA24106A	USB Power Sensor	12/6/2012	Annual	12/6/2013	1248508
Amplifier Research	5S1G4	5W, 800MHz-4.2GHz	CBT	N/A	CBT	21910
Anritsu	MA24106A	USB Power Sensor	8/22/2012	Annual	8/22/2013	1231538
Anritsu	MA24106A	USB Power Sensor	8/22/2012	Annual	8/22/2013	1231535
Anritsu	MA2411B	Pulse Sensor	9/19/2012	Annual	9/19/2013	1027293
Anritsu	MA2411B	Pulse Power Sensor	12/4/2012	Annual	12/4/2013	1207364
Anritsu	MA2411B	Pulse Power Sensor	12/5/2012	Annual	12/5/2013	1126066
Anritsu	MA2481A	Power Sensor	4/5/2012	Annual	4/5/2013	5605
Anritsu	MA2481A	Power Sensor	2/14/2013	Annual	2/14/2014	2400
Anritsu	MA2481D	Universal Sensor	12/17/2012	Annual	12/17/2013	1204419
Anritsu	MA2481D	Universal Sensor	12/17/2012	Annual	12/17/2013	1204343
Anritsu	ML2495A	Power Meter	10/11/2012	Annual	10/11/2013	1039008
Anritsu	ML2496A	Power Meter	11/28/2012	Annual	11/28/2013	1138001
COMTECH	AR85729-5	Solid State Amplifier	CBT	N/A	CBT	M155A00-009
COMTECH	AR85729-5/5759B	Solid State Amplifier	CBT	N/A	CBT	M3W1A00-1002
Control Company	36934-158	Wall-Mounted Thermometer	1/4/2012	Biennial	1/4/2014	122014497
Control Company	36934-158	Wall-Mounted Thermometer	1/4/2012	Biennial	1/4/2014	122014488
Gigatronics	80701A	(0.05-18GHz) Power Sensor	10/10/2012	Annual	10/10/2013	1833460
Gigatronics	8651A	Universal Power Meter	10/10/2012	Annual	10/10/2013	8650319
Intelligent Weighing	PD-3000	Electronic Balance	6/29/2012	Annual	6/29/2013	120405017
MCL	BW-N6W5+	6dB Attenuator	CBT	N/A	CBT	1139
MiniCircuits	VLF-6000+	Low Pass Filter	CBT	N/A	CBT	N/A
Mini-Circuits	BW-N20W5	Power Attenuator	CBT	N/A	CBT	1226
Mini-Circuits	BW-N20W5+	DC to 18 GHz Precision Fixed 20 dB Attenuator	CBT	N/A	CBT	N/A
Mini-Circuits	NLP-2950+	Low Pass Filter DC to 2700 MHz	CBT	N/A	CBT	N/A
Narda	4014C-6	4 - 8 GHz SMA 6 dB Directional Coupler	CBT	N/A	CBT	N/A
Narda	4772-3	Attenuator (3dB)	CBT	N/A	CBT	9406
Narda	BW-S3W2	Attenuator (3dB)	CBT	N/A	CBT	120
Pasternack	PE2208-6	Bidirectional Coupler	CBT	N/A	CBT	N/A
Pasternack	PE2209-10	Bidirectional Coupler	CBT	N/A	CBT	N/A
Rohde & Schwarz	CMU200	Base Station Simulator	5/22/2012	Annual	5/22/2013	109892
Rohde & Schwarz	NRVD	Dual Channel Power Meter	10/12/2012	Biennial	10/12/2014	101695
Rohde & Schwarz	NRV-232	Peak Power Sensor	10/12/2012	Biennial	10/12/2014	836019/013
Rohde & Schwarz	SME06	Signal Generator	10/11/2012	Annual	10/11/2013	832026
Seekonk	NC-100	Torque Wrench (8" lb)	11/29/2011	Triennial	11/29/2014	21053
SPEAG	D2450V2	2450 MHz SAR Dipole	8/23/2012	Annual	8/23/2013	719
SPEAG	D5GHzV2	5 GHz SAR Dipole	1/11/2013	Annual	1/11/2014	1057
SPEAG	DAE4	Dasy Data Acquisition Electronics	1/17/2013	Annual	1/17/2014	1272
SPEAG	DAE4	Dasy Data Acquisition Electronics	11/13/2012	Annual	11/13/2013	1333
SPEAG	DAE4	Dasy Data Acquisition Electronics	8/24/2012	Annual	8/24/2013	1322
SPEAG	DAK-3.5	Dielectric Assessment Kit	6/19/2012	Annual	6/19/2013	1070
SPEAG	DAK-3.5	Dielectric Assessment Kit	12/11/2012	Annual	12/11/2013	1091
SPEAG	ES3DV2	SAR Probe	8/28/2012	Annual	8/28/2013	3022
SPEAG	ES3DV3	SAR Probe	11/15/2012	Annual	11/15/2013	3287
SPEAG	EX3DV4	SAR Probe	1/17/2013	Annual	1/17/2014	3589
Tektronix	RSA-6114A	Real Time Spectrum Analyzer	4/5/2012	Annual	4/5/2013	B010177
VWR	23226-658	Long Stem Thermometer	3/30/2012	Biennial	3/30/2014	122179874
VWR	23226-658	Long Stem Thermometer	7/11/2012	Biennial	7/11/2014	122389334
VWR	62344-925	Mini-Thermometer	10/24/2011	Biennial	10/24/2013	111886441

Note: CBT (Calibrated Before Testing). Prior to testing, the measurement paths containing a cable, amplifier, attenuator, coupler or filter were connected to a calibrated source (i.e. a signal generator) to determine the losses of the measurement path. The power meter offset was then adjusted to compensate for the measurement system losses. This level offset is stored within the power meter before measurements are made. This calibration verification procedure applies to the system verification and output power measurements. The calibrated reading is then taken directly from the power meter after compensation of the losses for all final power measurements.



FCC ID: A3LSMT310		<b>SAR EVALUATION REPORT</b>		Reviewed by: Quality Manager
Document S/N: OY1303280555-R1.A3L	Test Dates: 04/01/13 - 04/03/13	DUT Type: Portable Tablet Computer		Page 19 of 24

# 11 MEASUREMENT UNCERTAINTIES

Applicable for frequencies less than 3000 MHz.

a	b	c	d	e= f(d,k)	f	g	h = c x f/e	i = c x g/e	k
Uncertainty Component	IEEE 1528 Sec.	Tol. (± %)	Prob. Dist.	Div.	c <sub>i</sub> 1gm	c <sub>i</sub> 10 gms	1gm u <sub>i</sub> (± %)	10gms u <sub>i</sub> (± %)	v <sub>i</sub>
<b>Measurement System</b>									
Probe Calibration	E.2.1	6.0	N	1	1.0	1.0	6.0	6.0	∞
Axial Isotropy	E.2.2	0.25	N	1	0.7	0.7	0.2	0.2	∞
Hemishperical Isotropy	E.2.2	1.3	N	1	1.0	1.0	1.3	1.3	∞
Boundary Effect	E.2.3	0.4	N	1	1.0	1.0	0.4	0.4	∞
Linearity	E.2.4	0.3	N	1	1.0	1.0	0.3	0.3	∞
System Detection Limits	E.2.5	5.1	N	1	1.0	1.0	5.1	5.1	∞
Readout Electronics	E.2.6	1.0	N	1	1.0	1.0	1.0	1.0	∞
Response Time	E.2.7	0.8	R	1.73	1.0	1.0	0.5	0.5	∞
Integration Time	E.2.8	2.6	R	1.73	1.0	1.0	1.5	1.5	∞
RF Ambient Conditions	E.6.1	3.0	R	1.73	1.0	1.0	1.7	1.7	∞
Probe Positioner Mechanical Tolerance	E.6.2	0.4	R	1.73	1.0	1.0	0.2	0.2	∞
Probe Positioning w/ respect to Phantom	E.6.3	2.9	R	1.73	1.0	1.0	1.7	1.7	∞
Extrapolation, Interpolation & Integration algorithms for Max. SAR Evaluation	E.5	1.0	R	1.73	1.0	1.0	0.6	0.6	∞
<b>Test Sample Related</b>									
Test Sample Positioning	E.4.2	6.0	N	1	1.0	1.0	6.0	6.0	287
Device Holder Uncertainty	E.4.1	3.32	R	1.73	1.0	1.0	1.9	1.9	∞
Output Power Variation - SAR drift measurement	6.6.2	5.0	R	1.73	1.0	1.0	2.9	2.9	∞
<b>Phantom &amp; Tissue Parameters</b>									
Phantom Uncertainty (Shape & Thickness tolerances)	E.3.1	4.0	R	1.73	1.0	1.0	2.3	2.3	∞
Liquid Conductivity - deviation from target values	E.3.2	5.0	R	1.73	0.64	0.43	1.8	1.2	∞
Liquid Conductivity - measurement uncertainty	E.3.3	3.8	N	1	0.64	0.43	2.4	1.6	6
Liquid Permittivity - deviation from target values	E.3.2	5.0	R	1.73	0.60	0.49	1.7	1.4	∞
Liquid Permittivity - measurement uncertainty	E.3.3	4.5	N	1	0.60	0.49	2.7	2.2	6
<b>Combined Standard Uncertainty (k=1)</b>				RSS			12.1	11.7	299
<b>Expanded Uncertainty (95% CONFIDENCE LEVEL)</b>				k=2			24.2	23.5	



The above measurement uncertainties are according to IEEE Std. 1528-2003

FCC ID: A3LSMT310	 PCTEST ENGINEERING LABORATORY, INC.	SAR EVALUATION REPORT		Reviewed by: Quality Manager
Document S/N: OY1303280555-R1.A3L	Test Dates: 04/01/13 - 04/03/13	DUT Type: Portable Tablet Computer		Page 20 of 24

Applicable for frequencies up to 6 GHz.

a	b	c	d	e= f(d,k)	f	g	h = c x f/e	i = c x g/e	k
Uncertainty Component	IEEE 1528 Sec.	Tol. (± %)	Prob. Dist.	Div.	c <sub>i</sub> 1gm	c <sub>i</sub> 10 gms	1gm u <sub>i</sub> (± %)	10gms u <sub>i</sub> (± %)	v <sub>i</sub>
<b>Measurement System</b>									
Probe Calibration	E.2.1	6.55	N	1	1.0	1.0	6.6	6.6	∞
Axial Isotropy	E.2.2	0.25	N	1	0.7	0.7	0.2	0.2	∞
Hemishperical Isotropy	E.2.2	1.3	N	1	1.0	1.0	1.3	1.3	∞
Boundary Effect	E.2.3	0.4	N	1	1.0	1.0	0.4	0.4	∞
Linearity	E.2.4	0.3	N	1	1.0	1.0	0.3	0.3	∞
System Detection Limits	E.2.5	5.1	N	1	1.0	1.0	5.1	5.1	∞
Readout Electronics	E.2.6	1.0	N	1	1.0	1.0	1.0	1.0	∞
Response Time	E.2.7	0.8	R	1.73	1.0	1.0	0.5	0.5	∞
Integration Time	E.2.8	2.6	R	1.73	1.0	1.0	1.5	1.5	∞
RF Ambient Conditions	E.6.1	3.0	R	1.73	1.0	1.0	1.7	1.7	∞
Probe Positioner Mechanical Tolerance	E.6.2	0.4	R	1.73	1.0	1.0	0.2	0.2	∞
Probe Positioning w/ respect to Phantom	E.6.3	2.9	R	1.73	1.0	1.0	1.7	1.7	∞
Extrapolation, Interpolation & Integration algorithms for Max. SAR Evaluation	E.5	1.0	R	1.73	1.0	1.0	0.6	0.6	∞
<b>Test Sample Related</b>									
Test Sample Positioning	E.4.2	6.0	N	1	1.0	1.0	6.0	6.0	287
Device Holder Uncertainty	E.4.1	3.32	R	1.73	1.0	1.0	1.9	1.9	∞
Output Power Variation - SAR drift measurement	6.6.2	5.0	R	1.73	1.0	1.0	2.9	2.9	∞
<b>Phantom &amp; Tissue Parameters</b>									
Phantom Uncertainty (Shape & Thickness tolerances)	E.3.1	4.0	R	1.73	1.0	1.0	2.3	2.3	∞
Liquid Conductivity - deviation from target values	E.3.2	5.0	R	1.73	0.64	0.43	1.8	1.2	∞
Liquid Conductivity - measurement uncertainty	E.3.3	3.8	N	1	0.64	0.43	2.4	1.6	6
Liquid Permittivity - deviation from target values	E.3.2	5.0	R	1.73	0.60	0.49	1.7	1.4	∞
Liquid Permittivity - measurement uncertainty	E.3.3	4.5	N	1	0.60	0.49	2.7	2.2	6
<b>Combined Standard Uncertainty (k=1)</b>	RSS						12.4	12.0	299
<b>Expanded Uncertainty</b> (95% CONFIDENCE LEVEL)	k=2						24.7	24.0	

The above measurement uncertainties are according to IEEE Std. 1528-2003



FCC ID: A3LSMT310		<b>SAR EVALUATION REPORT</b>		Reviewed by: Quality Manager
Document S/N: 0Y1303280555-R1.A3L	Test Dates: 04/01/13 - 04/03/13	DUT Type: Portable Tablet Computer	Page 21 of 24	

## 12 CONCLUSION

### 12.1 Measurement Conclusion



The SAR evaluation indicates that the EUT complies with the RF radiation exposure limits of the FCC and Industry Canada, with respect to all parameters subject to this test. These measurements were taken to simulate the RF effects of RF exposure under worst-case conditions. Precise laboratory measures were taken to assure repeatability of the tests. The results and statements relate only to the item(s) tested.

Please note that the absorption and distribution of electromagnetic energy in the body are very complex phenomena that depend on the mass, shape, and size of the body, the orientation of the body with respect to the field vectors, and the electrical properties of both the body and the environment. Other variables that may play a substantial role in possible biological effects are those that characterize the environment (e.g. ambient temperature, air velocity, relative humidity, and body insulation) and those that characterize the individual (e.g. age, gender, activity level, debilitation, or disease). Because various factors may interact with one another to vary the specific biological outcome of an exposure to electromagnetic fields, any protection guide should consider maximal amplification of biological effects as a result of field-body interactions, environmental conditions, and physiological variables. [3]



<b>FCC ID:</b> A3LSMT310		<b>SAR EVALUATION REPORT</b>		<b>Reviewed by:</b> Quality Manager
<b>Document S/N:</b> 0Y1303280555-R1.A3L	<b>Test Dates:</b> 04/01/13 - 04/03/13	<b>DUT Type:</b> Portable Tablet Computer	Page 22 of 24	

## 13 REFERENCES

- [1] Federal Communications Commission, ET Docket 93-62, Guidelines for Evaluating the Environmental Effects of Radiofrequency Radiation, Aug. 1996.
- [2] ANSI/IEEE C95.1-2005, American National Standard safety levels with respect to human exposure to radio frequency electromagnetic fields, 3kHz to 300GHz, New York: IEEE, 2006.
- [3] ANSI/IEEE C95.1-1992, American National Standard safety levels with respect to human exposure to radio frequency electromagnetic fields, 3kHz to 300GHz, New York: IEEE, Sept. 1992.
- [4] ANSI/IEEE C95.3-2002, IEEE Recommended Practice for the Measurement of Potentially Hazardous Electromagnetic Fields - RF and Microwave, New York: IEEE, December 2002.
- [5] Federal Communications Commission, OET Bulletin 65 (Edition 97-01), Supplement C (Edition 01-01), Evaluating Compliance with FCC Guidelines for Human Exposure to Radiofrequency Electromagnetic Fields, June 2001.
- [6] IEEE Standards Coordinating Committee 34 – IEEE Std. 1528-2003, Recommended Practice for Determining the Peak Spatial-Average Specific Absorption Rate (SAR) in the Human Body Due to Wireless Communications Devices.
- [7] NCRP, National Council on Radiation Protection and Measurements, Biological Effects and Exposure Criteria for RadioFrequency Electromagnetic Fields, NCRP Report No. 86, 1986. Reprinted Feb. 1995.
- [8] T. Schmid, O. Egger, N. Kuster, Automated E-field scanning system for dosimetric assessments, IEEE Transaction on Microwave Theory and Techniques, vol. 44, Jan. 1996, pp. 105-113.
- [9] K. Pokovic, T. Schmid, N. Kuster, Robust setup for precise calibration of E-field probes in tissue simulating liquids at mobile communications frequencies, ICECOM97, Oct. 1997, pp. -124.
- [10] K. Pokovic, T. Schmid, and N. Kuster, E-field Probe with improved isotropy in brain simulating liquids, Proceedings of the ELMAR, Zadar, Croatia, June 23-25, 1996, pp. 172-175.
- [11] Schmid & Partner Engineering AG, Application Note: Data Storage and Evaluation, June 1998, p2.
- [12] V. Hombach, K. Meier, M. Burkhardt, E. Kuhn, N. Kuster, The Dependence of EM Energy Absorption upon Human Modeling at 900 MHz, IEEE Transaction on Microwave Theory and Techniques, vol. 44 no. 10, Oct. 1996, pp. 1865-1873.
- [13] N. Kuster and Q. Balzano, Energy absorption mechanism by biological bodies in the near field of dipole antennas above 300MHz, IEEE Transaction on Vehicular Technology, vol. 41, no. 1, Feb. 1992, pp. 17-23.
- [14] G. Hartsgrrove, A. Kraszewski, A. Surowiec, Simulated Biological Materials for Electromagnetic Radiation Absorption Studies, University of Ottawa, Bioelectromagnetics, Canada: 1987, pp. 29-36.
- [15] Q. Balzano, O. Garay, T. Manning Jr., Electromagnetic Energy Exposure of Simulated Users of Portable Cellular Telephones, IEEE Transactions on Vehicular Technology, vol. 44, no.3, Aug. 1995.
- [16] W. Gander, Computermathematik, Birkhaeuser, Basel, 1992.
- [17] W.H. Press, S.A. Teukolsky, W.T. Vetterling, and B.P. Flannery, Numerical Recipes in C, The Art of Scientific Computing, Second edition, Cambridge University Press, 1992.

FCC ID: A3LSMT310	 PCTEST ENGINEERING LABORATORY, INC.	SAR EVALUATION REPORT		Reviewed by: Quality Manager
Document S/N: 0Y1303280555-R1.A3L	Test Dates: 04/01/13 - 04/03/13	DUT Type: Portable Tablet Computer		Page 23 of 24

- [18] Federal Communications Commission, OET Bulletin 65, Evaluating Compliance with FCC Guidelines for Human Exposure to Radiofrequency Electromagnetic Fields. Supplement C, Dec. 1997.
- [19] N. Kuster, R. Kastle, T. Schmid, Dosimetric evaluation of mobile communications equipment with known precision, IEEE Transaction on Communications, vol. E80-B, no. 5, May 1997, pp. 645-652.
- [20] CENELEC CLC/SC111B, European Prestandard (prENV 50166-2), Human Exposure to Electromagnetic Fields High-frequency: 10kHz-300GHz, Jan. 1995.
- [21] Prof. Dr. Niels Kuster, ETH, Eidgenössische Technische Hochschule Zürich, Dosimetric Evaluation of the Cellular Phone.
- [22] IEC 62209-1, Human exposure to radio frequency fields from hand-held and body-mounted wireless communication devices - Human models, instrumentation, and procedures - Part 1: Procedure to determine the specific absorption rate (SAR) for hand-held devices used in close proximity to the ear (frequency range of 300 MHz to 3 GHz), Feb. 2005.
- [23] Industry Canada RSS-102 Radio Frequency Exposure Compliance of Radiocommunication Apparatus (All Frequency Bands) Issue 4, March 2010.
- [24] Health Canada Safety Code 6 Limits of Human Exposure to Radio Frequency Electromagnetic Fields in the Frequency Range from 3 kHz – 300 GHz, 2009
- [25] FCC Public Notice DA-02-1438. Office of Engineering and Technology Announces a Transition Period for the Phantom Requirements of Supplement C to OET Bulletin 65, June 19, 2002
- [26] FCC SAR Test Procedures for 2G-3G Devices, Mobile Hotspot and UMPC Devices KDB Publications 941225, D01-D07
- [27] SAR Measurement procedures for IEEE 802.11a/b/g KDB Publication 248227 D01v01r02
- [28] FCC SAR Considerations for Handsets with Multiple Transmitters and Antennas, KDB Publications 648474 D02-D04
- [29] FCC SAR Evaluation Considerations for Laptop, Notebook, Netbook and Tablet Computers, FCC KDB Publication 616217 D04
- [30] FCC SAR Measurement and Reporting Requirements for 100MHz – 6 GHz, KDB Publications 865664 D01-D02
- [31] FCC General RF Exposure Guidance and SAR Procedures for Dongles, KDB Publication 447498, D01-D02
- [32] Anexo à Resolução No. 533, de 10 de Setembro de 2009.
- [33] IEC 62209-2, Human exposure to radio frequency fields from hand-held and body-mounted wireless communication devices - Human models, instrumentation, and procedures - Part 2: Procedure to determine the specific absorption rate (SAR) for wireless communication devices used in close proximity to the human body (frequency range of 30 MHz to 6 GHz), Mar. 2010.

<b>FCC ID:</b> A3LSMT310	 <b>PCTEST</b> ENGINEERING LABORATORY, INC.	<b>SAR EVALUATION REPORT</b>		<b>Reviewed by:</b> Quality Manager
<b>Document S/N:</b> 0Y1303280555-R1.A3L	<b>Test Dates:</b> 04/01/13 - 04/03/13	<b>DUT Type:</b> Portable Tablet Computer	Page 24 of 24	

## APPENDIX A: SAR TEST DATA

# PCTEST ENGINEERING LABORATORY, INC.

**DUT: A3LSMT310; Type: Portable Tablet Computer; Serial: 4300a40b66a7218d**

Communication System: Bluetooth; Frequency: 2402 MHz; Duty Cycle: 1:1

Medium: 2450 Body Medium parameters used (interpolated):

$f = 2402 \text{ MHz}$ ;  $\sigma = 1.882 \text{ mho/m}$ ;  $\epsilon_r = 52.791$ ;  $\rho = 1000 \text{ kg/m}^3$

Phantom section: Flat Section; Space: 0.0 cm

Test Date: 04-03-2013; Ambient Temp: 24.1°C; Tissue Temp: 23.3°C

Probe: ES3DV3 - SN3287; ConvF(4.29, 4.29, 4.29); Calibrated: 11/15/2012;

Sensor-Surface: 3mm (Mechanical Surface Detection)

Electronics: DAE4 Sn1333; Calibrated: 11/13/2012

Phantom: SAM Sub Dasy B; Type: SAM 5.0; Serial: TP-1626

Measurement SW: DASY4, Version 4.7 (80); SEMCAD X Version 14.6.7 (6848)

**Mode: 2.4 GHz Bluetooth, Body SAR, Ch 0, 1 Mbps, Back Side**

**Area Scan (12x19x1):** Measurement grid: dx=12mm, dy=12mm

**Zoom Scan (7x7x7)/Cube 0:** Measurement grid: dx=5mm, dy=5mm, dz=5mm

Reference Value = 6.102 V/m; Power Drift = -0.19 dB

Peak SAR (extrapolated) = 0.220 W/kg

**SAR(1 g) = 0.080 W/kg; SAR(10 g) = 0.032 W/kg**

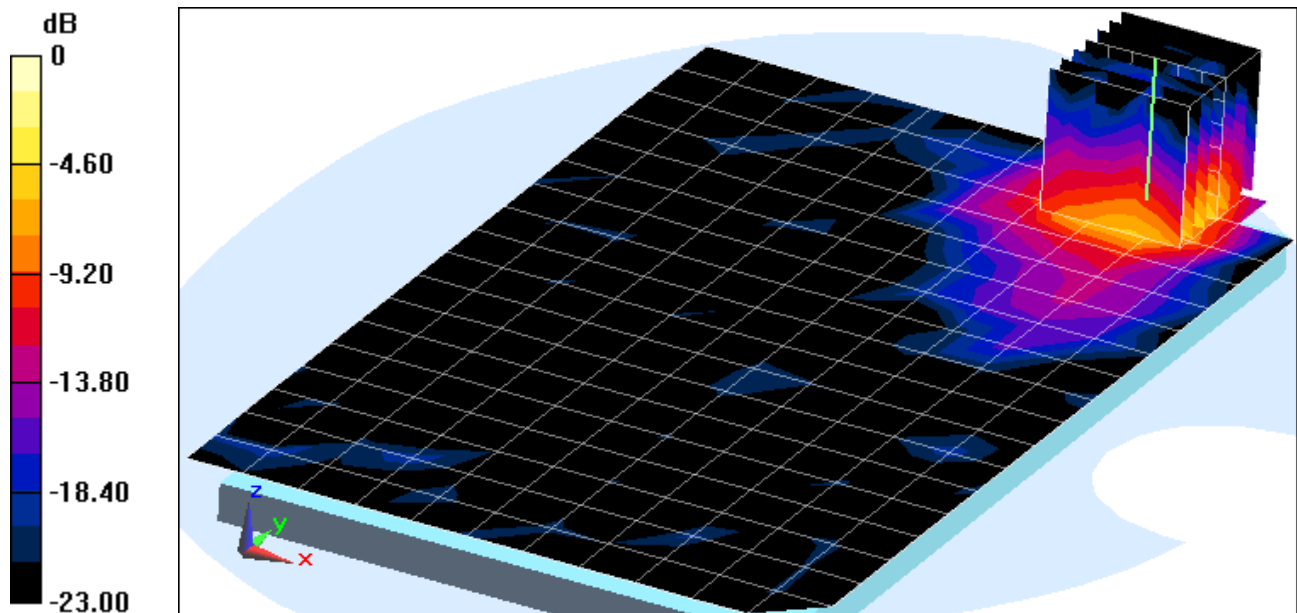

0 dB = 0.113 W/kg = -9.47 dBW/kg

# PCTEST ENGINEERING LABORATORY, INC.

**DUT: A3LSMT310; Type: Portable Tablet Computer; Serial: Sample 4300a40b66a7218d**

Communication System: IEEE 802.11b; Frequency: 2437 MHz; Duty Cycle: 1:1

Medium: 2450 Body Medium parameters used (interpolated):

$f = 2437 \text{ MHz}$ ;  $\sigma = 1.994 \text{ mho/m}$ ;  $\epsilon_r = 51.283$ ;  $\rho = 1000 \text{ kg/m}^3$

Phantom section: Flat Section; Space: 0.0 cm

Test Date: 04-01-2013; Ambient Temp: 24.3°C; Tissue Temp: 24.0°C

Probe: ES3DV2 - SN3022; ConvF(3.97, 3.97, 3.97); Calibrated: 8/28/2012;

Sensor-Surface: 3mm (Mechanical Surface Detection)

Electronics: DAE4 Sn1322; Calibrated: 8/24/2012

Phantom: SAM Sub; Type: SAM 4.0; Serial: TP-1357

Measurement SW: DASY4, Version 4.7 (80); SEMCAD X Version 14.6.7 (6848)

**Mode: IEEE 802.11b, Body SAR, Ch 06, 1 Mbps, Back Side**

**Area Scan (16x20x1):** Measurement grid: dx=12mm, dy=12mm

**Zoom Scan (7x7x7)/Cube 0:** Measurement grid: dx=5mm, dy=5mm, dz=5mm

Reference Value = 19.329 V/m; Power Drift = -0.17 dB

Peak SAR (extrapolated) = 1.78 W/kg

**SAR(1 g) = 0.680 W/kg; SAR(10 g) = 0.281 W/kg**

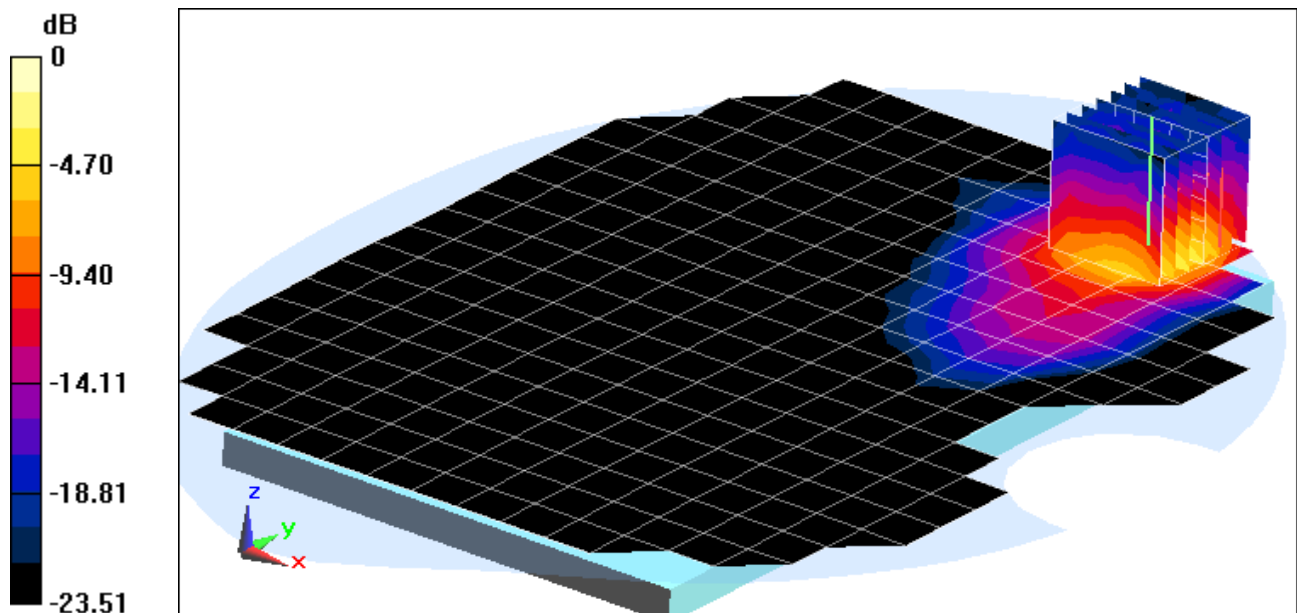

0 dB = 0.957 W/kg = -0.19 dBW/kg

# PCTEST ENGINEERING LABORATORY, INC.

**DUT: A3LSMT310; Type: Portable Tablet; Serial: 4300a40b66a7218d**

Communication System: IEEE 802.11a 5.2-5.8 GHz Band; Frequency: 5520 MHz; Duty Cycle: 1:1

Medium: 5 GHz Body Medium parameters used:

$f = 5520 \text{ MHz}$ ;  $\sigma = 5.705 \text{ mho/m}$ ;  $\epsilon_r = 47.538$ ;  $\rho = 1000 \text{ kg/m}^3$

Phantom section: Flat Section; Space: 0.0 cm

Test Date: 04-01-2013; Ambient Temp: 24.3°C; Tissue Temp: 23.2°C

Probe: EX3DV4 - SN3589; ConvF(3.52, 3.52, 3.52); Calibrated: 1/17/2013;

Sensor-Surface: 1.4mm (Mechanical Surface Detection)

Electronics: DAE4 Sn1272; Calibrated: 1/17/2013

Phantom: SAM Sub; Type: SAM 4.0; Serial: TP-1357

Measurement SW: DASY4, Version 4.7 (80); SEMCAD X Version 14.6.7 (6848)

**Mode: IEEE 802.11a, 5.5 GHz, Body SAR, Ch 104, 6 Mbps, Back Side**

**Area Scan (17x26x1):** Measurement grid: dx=10mm, dy=10mm

**Zoom Scan (7x7x7)/Cube 0:** Measurement grid: dx=4mm, dy=4mm, dz=1.4mm; Graded Ratio: 1.4

Reference Value = 13.348 V/m; Power Drift = 0.03 dB

Peak SAR (extrapolated) = 3.72 W/kg

**SAR(1 g) = 0.761 W/kg; SAR(10 g) = 0.165 W/kg**

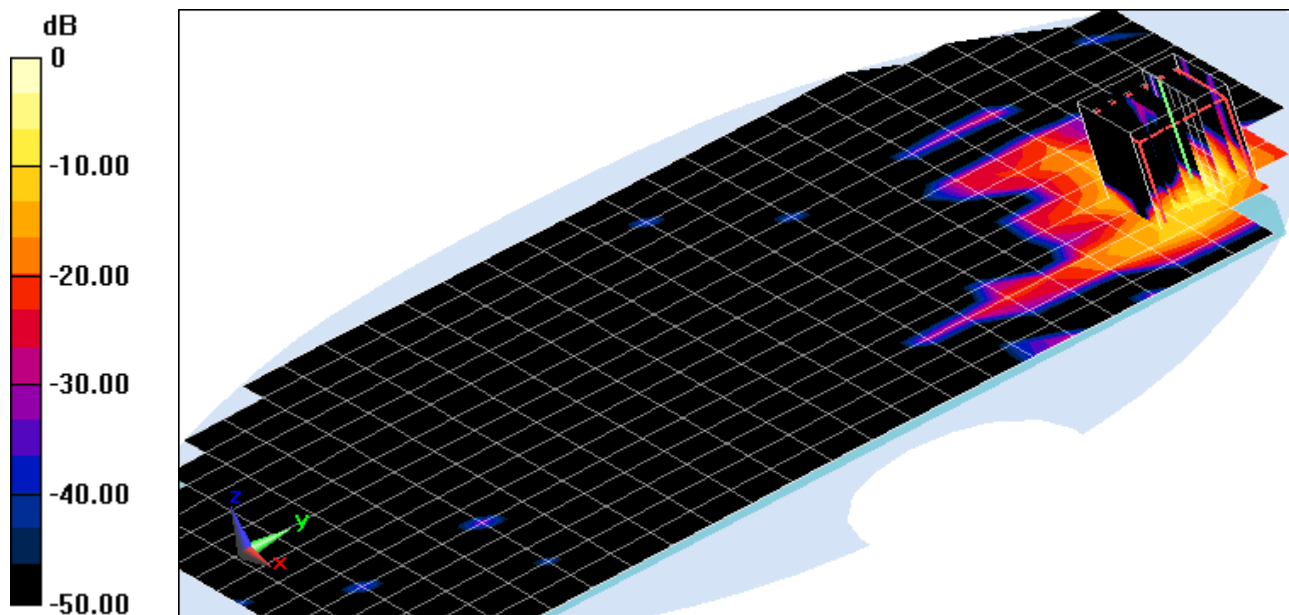

0 dB = 2.02 W/kg = 3.05 dBW/kg

# PCTEST ENGINEERING LABORATORY, INC.

**DUT: A3LSMT310; Type: Portable Tablet Computer; Serial: 4300a40b66a7218d**

Communication System: IEEE 802.11a 5.2-5.8 GHz Band; Frequency: 5745 MHz; Duty Cycle: 1:1  
Medium: 5 GHz Body Medium parameters used:

$f = 5745 \text{ MHz}$ ;  $\sigma = 6.047 \text{ mho/m}$ ;  $\epsilon_r = 47.018$ ;  $\rho = 1000 \text{ kg/m}^3$

Phantom section: Flat Section; Space: 0.0 cm

Test Date: 04-01-2013; Ambient Temp: 24.4°C; Tissue Temp: 23.3°C

Probe: EX3DV4 - SN3589; ConvF(3.66, 3.66, 3.66); Calibrated: 1/17/2013;

Sensor-Surface: 1.4mm (Mechanical Surface Detection)

Electronics: DAE4 Sn1272; Calibrated: 1/17/2013

Phantom: SAM Sub; Type: SAM 4.0; Serial: TP-1357

Measurement SW: DASY4, Version 4.7 (80); SEMCAD X Version 14.6.7 (6848)

**Mode: IEEE 802.11a, 5.8 GHz, Body SAR, Ch 149, 6 Mbps, Back Side**

**Area Scan (17x26x1):** Measurement grid: dx=10mm, dy=10mm

**Zoom Scan (7x7x7)/Cube 0:** Measurement grid: dx=4mm, dy=4mm, dz=1.4mm; Graded Ratio: 1.4

Reference Value = 10.667 V/m; Power Drift = -0.07 dB

Peak SAR (extrapolated) = 1.91 W/kg

**SAR(1 g) = 0.459 W/kg; SAR(10 g) = 0.099 W/kg**

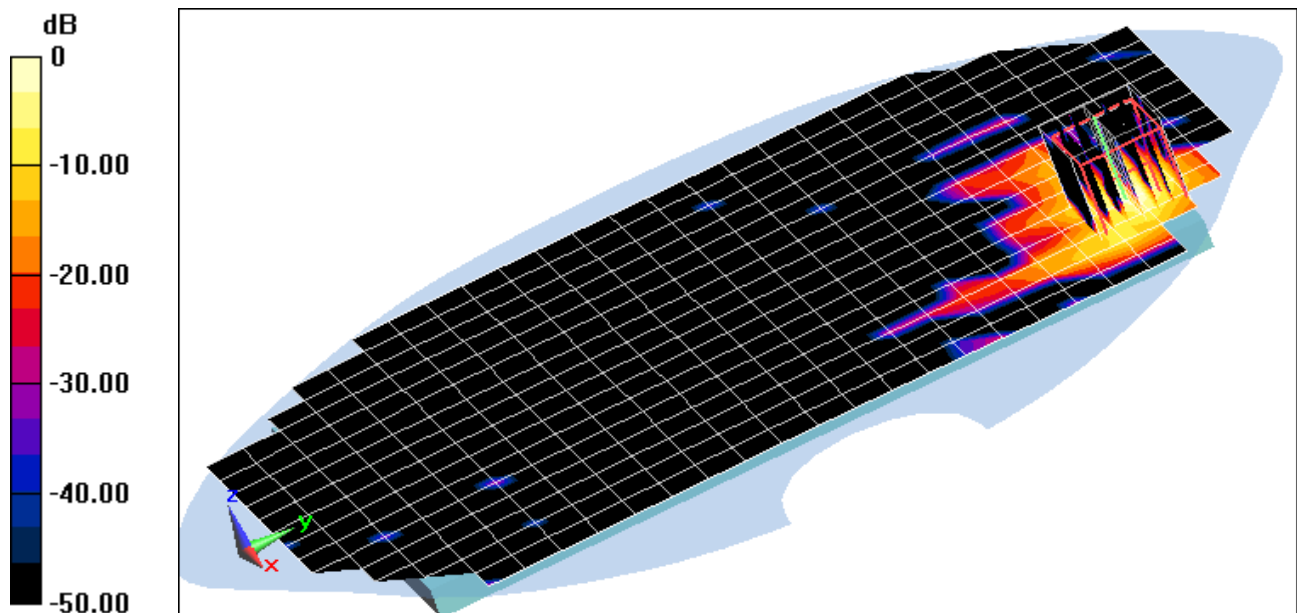

0 dB = 1.26 W/kg = 1.00 dBW/kg

## APPENDIX B: SYSTEM VERIFICATION

# PCTEST ENGINEERING LABORATORY, INC.

**DUT: SAR Dipole 2450 MHz; Type: D2450V2; Serial: 719**

Communication System: CW; Frequency: 2450 MHz; Duty Cycle: 1:1

Medium: 2450 Body Medium parameters used:

$f = 2450 \text{ MHz}$ ;  $\sigma = 2.011 \text{ mho/m}$ ;  $\epsilon_r = 51.233$ ;  $\rho = 1000 \text{ kg/m}^3$

Phantom section: Flat Section; Space: 1.0 cm

Test Date: 04-01-2013; Ambient Temp: 24.3°C; Tissue Temp: 24.0°C

Probe: ES3DV2 - SN3022; ConvF(3.97, 3.97, 3.97); Calibrated: 8/28/2012;

Sensor-Surface: 3mm (Mechanical Surface Detection)

Electronics: DAE4 Sn1322; Calibrated: 8/24/2012

Phantom: SAM Sub; Type: SAM 4.0; Serial: TP-1357

Measurement SW: DASY4, Version 4.7 (80); SEMCAD X Version 14.6.7 (6848)

## 2450MHz System Verification

**Area Scan (6x8x1):** Measurement grid: dx=12mm, dy=12mm

**Zoom Scan (7x7x7)/Cube 0:** Measurement grid: dx=5mm, dy=5mm, dz=5mm

Input Power: 20 dBm (100 mW)

Peak SAR (extrapolated) = 11.6 W/kg

**SAR(1 g) = 5.44 W/kg; SAR(10 g) = 2.54 W/kg**

Deviation: 5.43%

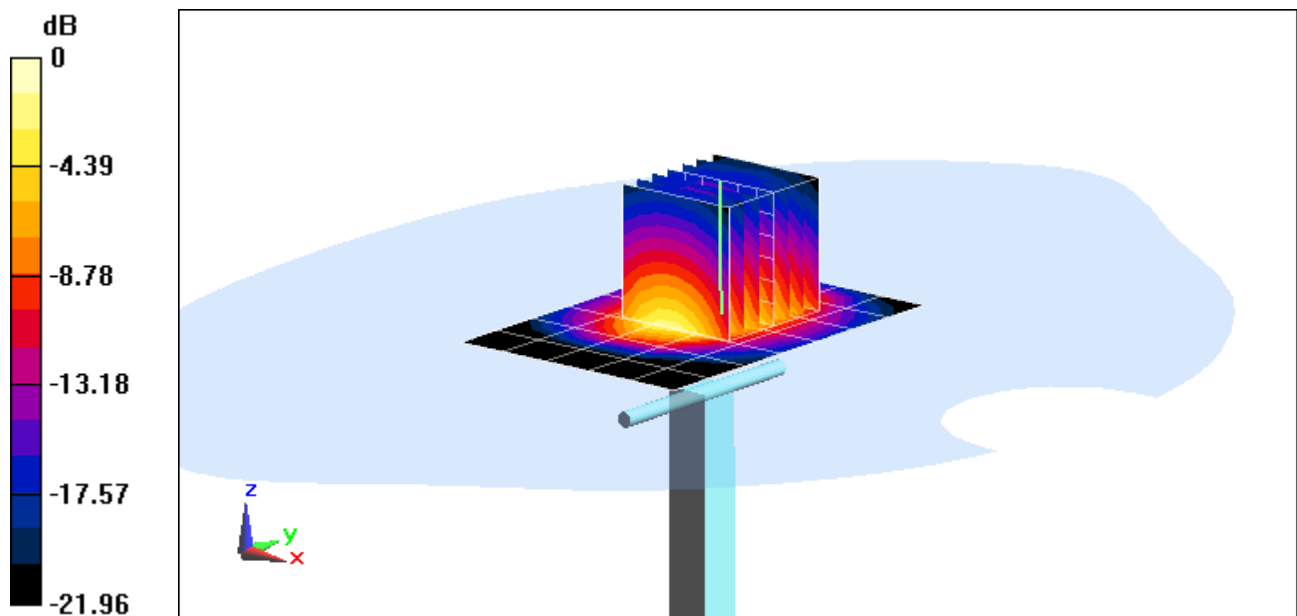

0 dB = 7.06 W/kg = 8.49 dBW/kg

# PCTEST ENGINEERING LABORATORY, INC.

**DUT: Dipole 2450 MHz; Type: D2450V2; Serial: 719**

Communication System: CW; Frequency: 2450 MHz; Duty Cycle: 1:1

Medium: 2450 Body Medium parameters used:

$f = 2450 \text{ MHz}$ ;  $\sigma = 1.947 \text{ mho/m}$ ;  $\epsilon_r = 52.639$ ;  $\rho = 1000 \text{ kg/m}^3$

Phantom section: Flat Section; Space: 1.0 cm

Test Date: 04-03-2013; Ambient Temp: 24.1°C; Tissue Temp: 23.3°C

Probe: ES3DV3 - SN3287; ConvF(4.29, 4.29, 4.29); Calibrated: 11/15/2012;

Sensor-Surface: 3mm (Mechanical Surface Detection)

Electronics: DAE4 Sn1333; Calibrated: 11/13/2012

Phantom: SAM Sub Dasy B; Type: SAM 5.0; Serial: TP-1626

Measurement SW: DASY4, Version 4.7 (80); SEMCAD X Version 14.6.7 (6848)

## 2450MHz System Verification

**Area Scan (6x9x1):** Measurement grid: dx=12mm, dy=12mm

**Zoom Scan (7x7x7)/Cube 0:** Measurement grid: dx=5mm, dy=5mm, dz=5mm

Input Power: 20 dBm (100 mW)

Peak SAR (extrapolated) = 10.7 W/kg

**SAR(1 g) = 4.99 W/kg; SAR(10 g) = 2.31 W/kg**

Deviation: -3.29%

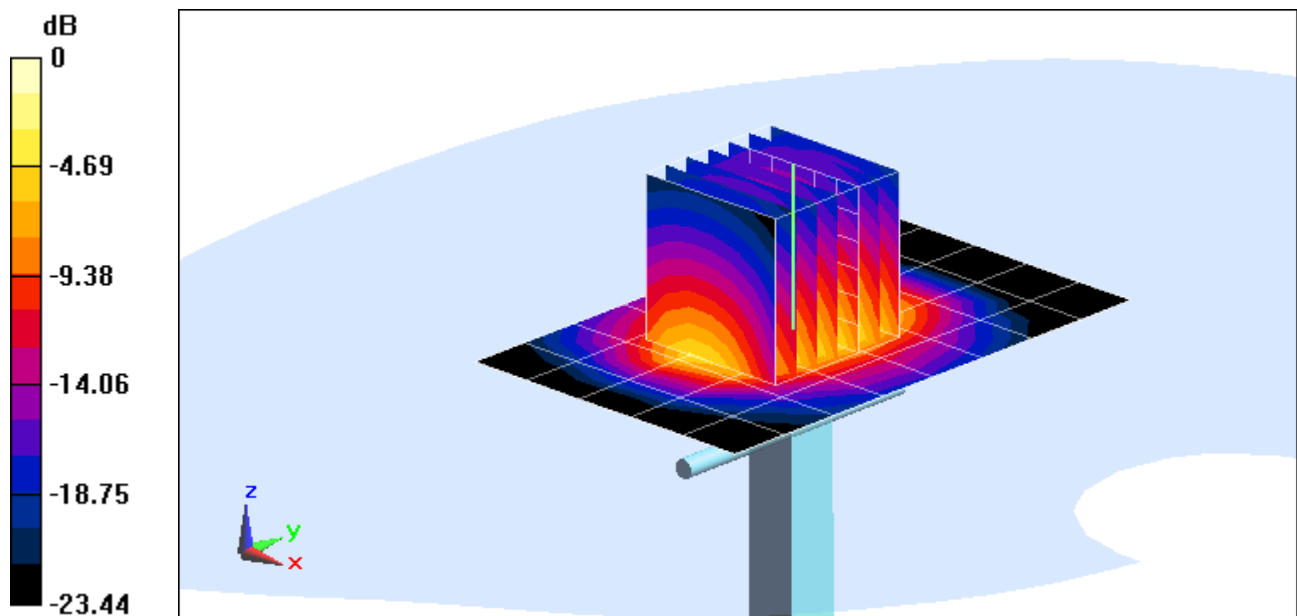

0 dB = 6.54 W/kg = 8.16 dBW/kg

# PCTEST ENGINEERING LABORATORY, INC.

**DUT: Dipole 5200 MHz; Type: D5GHzV2; Serial: 1057**

Communication System: CW; Frequency: 5200 MHz; Duty Cycle: 1:1

Medium: 5 GHz Body Medium parameters used:

$f = 5200 \text{ MHz}$ ;  $\sigma = 5.252 \text{ mho/m}$ ;  $\epsilon_r = 48.233$ ;  $\rho = 1000 \text{ kg/m}^3$

Phantom section: Flat Section; Space: 1.0 cm

Test Date: 04-01-2013; Ambient Temp: 24.3°C; Tissue Temp: 23.2°C

Probe: EX3DV4 - SN3589; ConvF(3.99, 3.99, 3.99); Calibrated: 1/17/2013;

Sensor-Surface: 1.4mm (Mechanical Surface Detection)

Electronics: DAE4 Sn1272; Calibrated: 1/17/2013

Phantom: SAM Sub; Type: SAM 4.0; Serial: TP-1357

Measurement SW: DASY4, Version 4.7 (80); SEMCAD X Version 14.6.7 (6848)

## 5200MHz System Verification

**Area Scan (7x9x1):** Measurement grid: dx=10mm, dy=10mm

**Zoom Scan (7x7x7)/Cube 0:** Measurement grid: dx=4mm, dy=4mm, dz=1.4mm; Graded Ratio: 1.4

Input Power: 20 dBm (100 mW)

Peak SAR (extrapolated) = 34.8 W/kg

**SAR(1 g) = 7.41 W/kg; SAR(10 g) = 2.05 W/kg**

Deviation: -1.85%

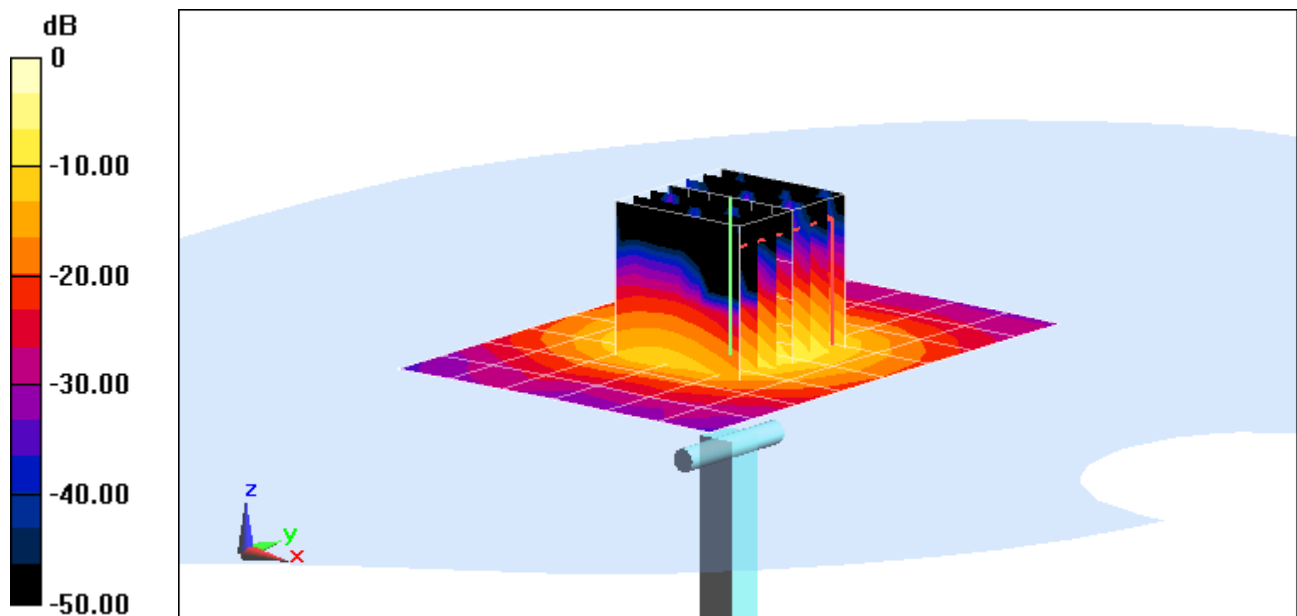

0 dB = 17.1 W/kg = 12.33 dBW/kg

# PCTEST ENGINEERING LABORATORY, INC.

**DUT: Dipole 5300 MHz; Type: D5GHzV2; Serial: 1057**

Communication System: CW; Frequency: 5300 MHz; Duty Cycle: 1:1

Medium: 5 GHz Body Medium parameters used:

$f = 5300 \text{ MHz}$ ;  $\sigma = 5.38 \text{ mho/m}$ ;  $\epsilon_r = 48.024$ ;  $\rho = 1000 \text{ kg/m}^3$

Phantom section: Flat Section; Space: 1.0 cm

Test Date: 04-01-2013; Ambient Temp: 24.3°C; Tissue Temp: 23.2°C

Probe: EX3DV4 - SN3589; ConvF(3.81, 3.81, 3.81); Calibrated: 1/17/2013;

Sensor-Surface: 1.4mm (Mechanical Surface Detection)

Electronics: DAE4 Sn1272; Calibrated: 1/17/2013

Phantom: SAM Sub; Type: SAM 4.0; Serial: TP-1357

Measurement SW: DASY4, Version 4.7 (80); SEMCAD X Version 14.6.7 (6848)

## 5300MHz System Verification

**Area Scan (7x9x1):** Measurement grid: dx=10mm, dy=10mm

**Zoom Scan (7x7x7)/Cube 0:** Measurement grid: dx=4mm, dy=4mm, dz=1.4mm; Graded Ratio: 1.4

Input Power: 20 dBm (100 mW)

Peak SAR (extrapolated) = 35.1 W/kg

**SAR(1 g) = 7.22 W/kg; SAR(10 g) = 1.95 W/kg**

Deviation: -4.12%

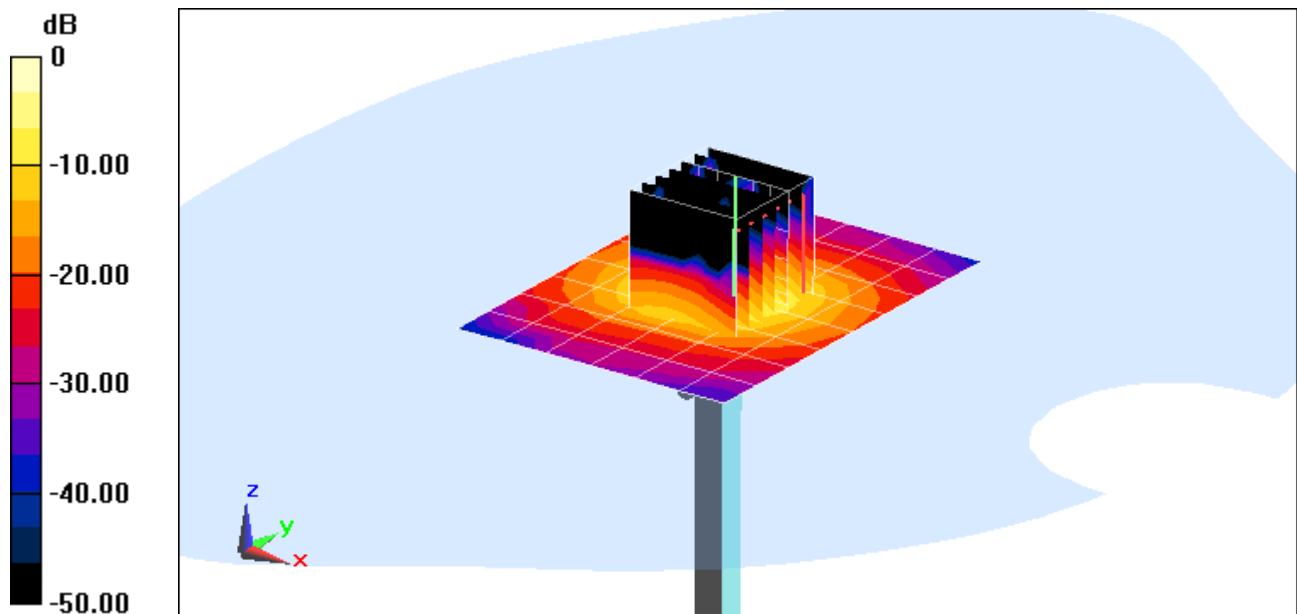

0 dB = 16.7 W/kg = 12.23 dBW/kg

# PCTEST ENGINEERING LABORATORY, INC.

**DUT: Dipole 5500 MHz; Type: D5GHzV2; Serial: 1057**

Communication System: CW; Frequency: 5500 MHz; Duty Cycle: 1:1

Medium: 5 GHz Body Medium parameters used:

$f = 5500 \text{ MHz}$ ;  $\sigma = 5.669 \text{ mho/m}$ ;  $\epsilon_r = 47.593$ ;  $\rho = 1000 \text{ kg/m}^3$

Phantom section: Flat Section; Space: 1.0 cm

Test Date: 04-01-2013; Ambient Temp: 24.3°C; Tissue Temp: 23.2°C

Probe: EX3DV4 - SN3589; ConvF(3.52, 3.52, 3.52); Calibrated: 1/17/2013;

Sensor-Surface: 1.4mm (Mechanical Surface Detection)

Electronics: DAE4 Sn1272; Calibrated: 1/17/2013

Phantom: SAM Sub; Type: SAM 4.0; Serial: TP-1357

Measurement SW: DASY4, Version 4.7 (80); SEMCAD X Version 14.6.7 (6848)

## 5500MHz System Verification

**Area Scan (7x9x1):** Measurement grid: dx=10mm, dy=10mm

**Zoom Scan (7x7x7)/Cube 0:** Measurement grid: dx=4mm, dy=4mm, dz=1.4mm; Graded Ratio: 1.4

Input Power: 20 dBm (100 mW)

Peak SAR (extrapolated) = 40.1 W/kg

**SAR(1 g) = 8.07 W/kg; SAR(10 g) = 2.19 W/kg**

Deviation: -0.12%

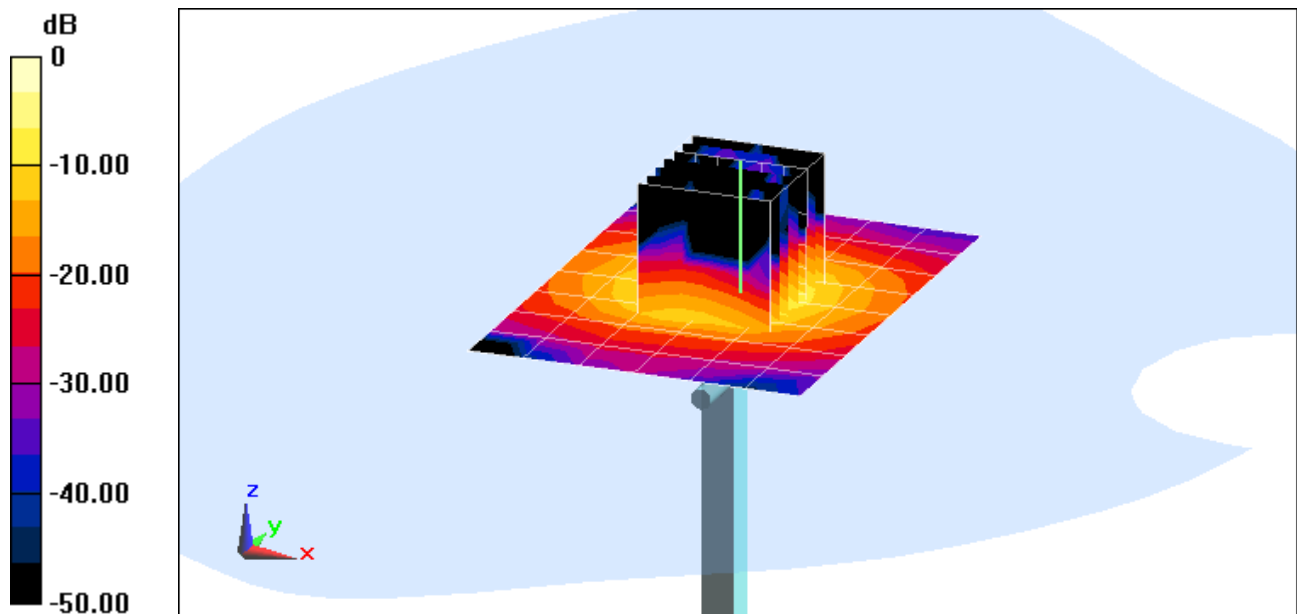

0 dB = 19.3 W/kg = 12.86 dBW/kg

# PCTEST ENGINEERING LABORATORY, INC.

**DUT: Dipole 5600 MHz; Type: D5GHzV2; Serial: 1057**

Communication System: CW; Frequency: 5600 MHz; Duty Cycle: 1:1

Medium: 5 GHz Body Medium parameters used:

$f = 5600 \text{ MHz}$ ;  $\sigma = 5.817 \text{ mho/m}$ ;  $\epsilon_r = 47.365$ ;  $\rho = 1000 \text{ kg/m}^3$

Phantom section: Flat Section; Space: 1.0 cm

Test Date: 04-01-2013; Ambient Temp: 24.4°C; Tissue Temp: 23.3°C

Probe: EX3DV4 - SN3589; ConvF(3.32, 3.32, 3.32); Calibrated: 1/17/2013;

Sensor-Surface: 1.4mm (Mechanical Surface Detection)

Electronics: DAE4 Sn1272; Calibrated: 1/17/2013

Phantom: SAM Sub; Type: SAM 4.0; Serial: TP-1357

Measurement SW: DASY4, Version 4.7 (80); SEMCAD X Version 14.6.7 (6848)

## 5600MHz System Verification

**Area Scan (7x9x1):** Measurement grid: dx=10mm, dy=10mm

**Zoom Scan (7x7x7)/Cube 0:** Measurement grid: dx=4mm, dy=4mm, dz=1.4mm; Graded Ratio: 1.4

Input Power: 20 dBm (100 mW)

Peak SAR (extrapolated) = 38.6 W/kg

**SAR(1 g) = 8.02 W/kg; SAR(10 g) = 2.18 W/kg**

Deviation: -0.12%

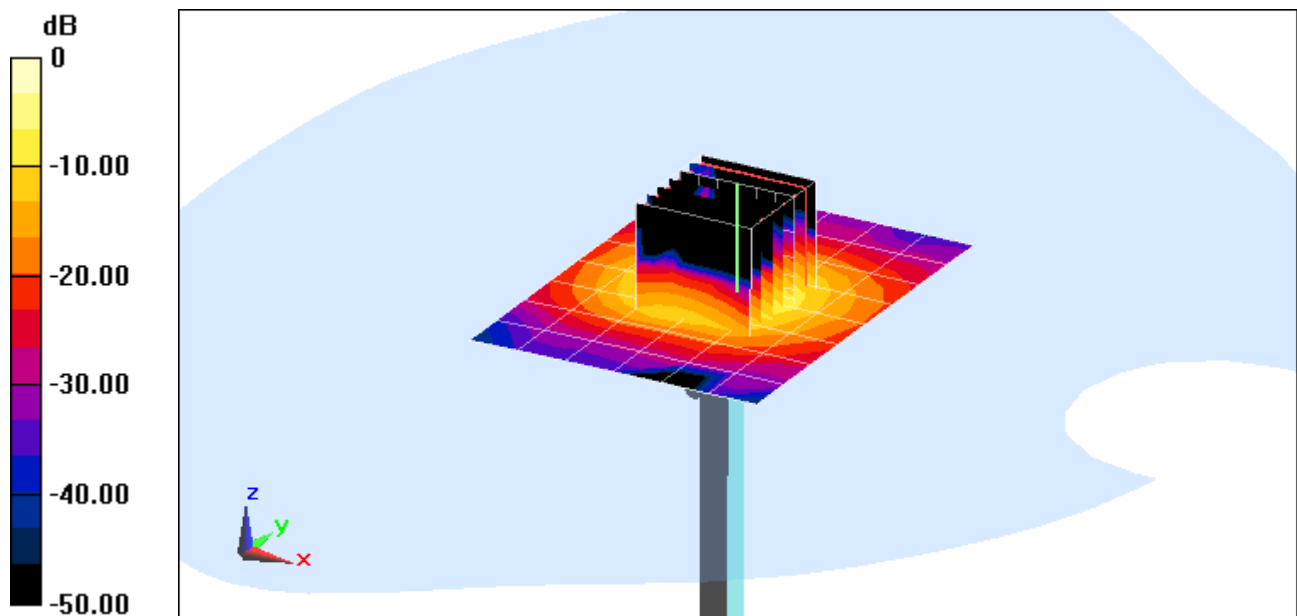

# PCTEST ENGINEERING LABORATORY, INC.

**DUT: Dipole 5800 MHz; Type: D5GHzV2; Serial: 1057**

Communication System: CW; Frequency: 5800 MHz; Duty Cycle: 1:1

Medium: 5 GHz Body Medium parameters used:

$f = 5800 \text{ MHz}$ ;  $\sigma = 6.124 \text{ mho/m}$ ;  $\epsilon_r = 46.86$ ;  $\rho = 1000 \text{ kg/m}^3$

Phantom section: Flat Section; Space: 1.0 cm

Test Date: 04-01-2013; Ambient Temp: 24.4°C; Tissue Temp: 23.3°C

Probe: EX3DV4 - SN3589; ConvF(3.66, 3.66, 3.66); Calibrated: 1/17/2013;

Sensor-Surface: 1.4mm (Mechanical Surface Detection)

Electronics: DAE4 Sn1272; Calibrated: 1/17/2013

Phantom: SAM Sub; Type: SAM 4.0; Serial: TP-1357

Measurement SW: DASY4, Version 4.7 (80); SEMCAD X Version 14.6.7 (6848)

## 5800MHz System Verification

**Area Scan (7x9x1):** Measurement grid: dx=10mm, dy=10mm

**Zoom Scan (7x7x7)/Cube 0:** Measurement grid: dx=4mm, dy=4mm, dz=1.4mm; Graded Ratio: 1.4

Input Power: 20 dBm (100 mW)

Peak SAR (extrapolated) = 39.2 W/kg

**SAR(1 g) = 7.49 W/kg; SAR(10 g) = 2.02 W/kg**

Deviation: -0.27%

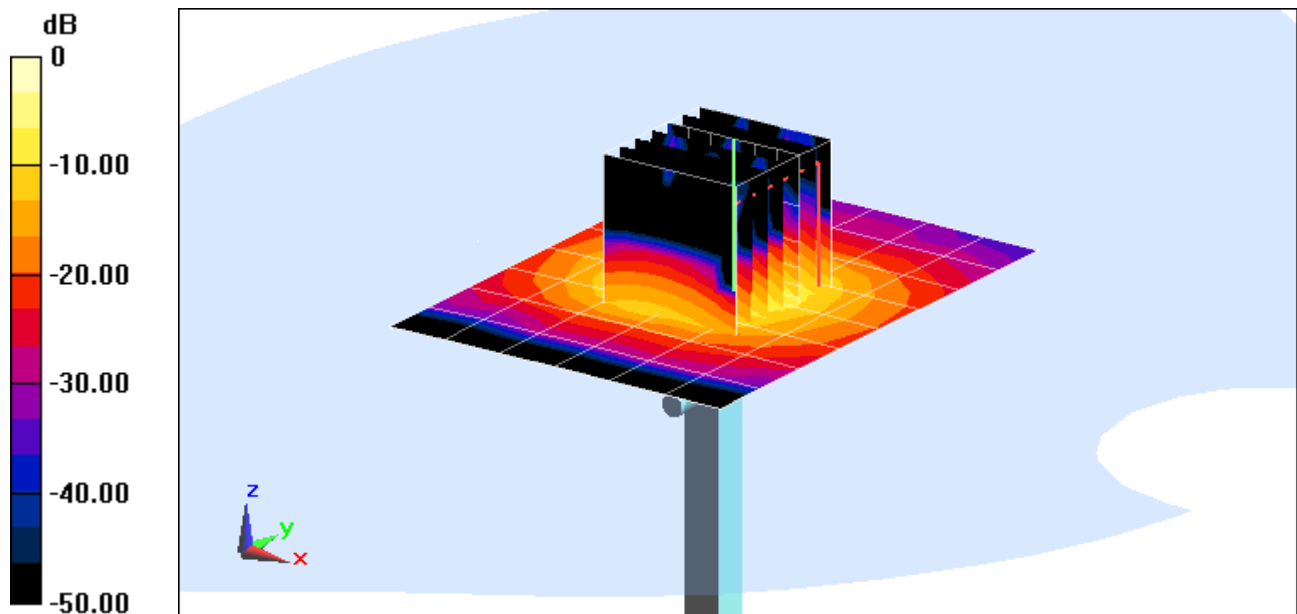

0 dB = 18.7 W/kg = 12.72 dBW/kg

## APPENDIX C: PROBE CALIBRATION

**Calibration Laboratory of  
Schmid & Partner  
Engineering AG**  
Zeughausstrasse 43, 8004 Zurich, Switzerland



**S** Schweizerischer Kalibrierdienst  
**C** Service suisse d'étalonnage  
**S** Servizio svizzero di taratura  
**S** Swiss Calibration Service

Accredited by the Swiss Accreditation Service (SAS)  
The Swiss Accreditation Service is one of the signatories to the EA  
Multilateral Agreement for the recognition of calibration certificates

Accreditation No.: **SCS 108**

Client **PC Test**

Certificate No: **D2450V2-719\_Aug12**

## CALIBRATION CERTIFICATE

Object **D2450V2 - SN: 719**

Calibration procedure(s) **QA CAL-05.v8  
Calibration procedure for dipole validation kits above 700 MHz**

Calibration date: **August 23, 2012**

*✓ KOK  
9/17/12*

This calibration certificate documents the traceability to national standards, which realize the physical units of measurements (SI).  
The measurements and the uncertainties with confidence probability are given on the following pages and are part of the certificate.

All calibrations have been conducted in the closed laboratory facility: environment temperature (22 ± 3)°C and humidity < 70%.

Calibration Equipment used (M&TE critical for calibration)

Primary Standards	ID #	Cal Date (Certificate No.)	Scheduled Calibration
Power meter EPM-442A	GB37480704	05-Oct-11 (No. 217-01451)	Oct-12
Power sensor HP 8481A	US37292783	05-Oct-11 (No. 217-01451)	Oct-12
Reference 20 dB Attenuator	SN: 5058 (20k)	27-Mar-12 (No. 217-01530)	Apr-13
Type-N mismatch combination	SN: 5047.2 / 06327	27-Mar-12 (No. 217-01533)	Apr-13
Reference Probe ES3DV3	SN: 3205	30-Dec-11 (No. ES3-3205_Dec11)	Dec-12
DAE4	SN: 601	27-Jun-12 (No. DAE4-601_Jun12)	Jun-13
Secondary Standards	ID #	Check Date (in house)	Scheduled Check
Power sensor HP 8481A	MY41092317	18-Oct-02 (in house check Oct-11)	In house check: Oct-13
RF generator R&S SMT-06	100005	04-Aug-99 (in house check Oct-11)	In house check: Oct-13
Network Analyzer HP 8753E	US37390585 S4206	18-Oct-01 (in house check Oct-11)	In house check: Oct-12

Calibrated by: **Israe El-Naouq**      Name: **Israe El-Naouq**      Function: **Laboratory Technician**

Approved by: **Katja Pokovic**      Name: **Katja Pokovic**      Function: **Technical Manager**

Signature  
*Israe El-Naouq*  
*Katja Pokovic*

Issued: August 23, 2012

This calibration certificate shall not be reproduced except in full without written approval of the laboratory.



Accredited by the Swiss Accreditation Service (SAS)  
The Swiss Accreditation Service is one of the signatories to the EA  
Multilateral Agreement for the recognition of calibration certificates

Accreditation No.: **SCS 108**

**Glossary:**

TSL	tissue simulating liquid
ConvF	sensitivity in TSL / NORM x,y,z
N/A	not applicable or not measured

**Calibration is Performed According to the Following Standards:**

- IEEE Std 1528-2003, "IEEE Recommended Practice for Determining the Peak Spatial-Averaged Specific Absorption Rate (SAR) in the Human Head from Wireless Communications Devices: Measurement Techniques", December 2003
- IEC 62209-1, "Procedure to measure the Specific Absorption Rate (SAR) for hand-held devices used in close proximity to the ear (frequency range of 300 MHz to 3 GHz)", February 2005
- Federal Communications Commission Office of Engineering & Technology (FCC OET), "Evaluating Compliance with FCC Guidelines for Human Exposure to Radiofrequency Electromagnetic Fields; Additional Information for Evaluating Compliance of Mobile and Portable Devices with FCC Limits for Human Exposure to Radiofrequency Emissions", Supplement C (Edition 01-01) to Bulletin 65

**Additional Documentation:**

- DASY4/5 System Handbook

**Methods Applied and Interpretation of Parameters:**

- Measurement Conditions:* Further details are available from the Validation Report at the end of the certificate. All figures stated in the certificate are valid at the frequency indicated.
- Antenna Parameters with TSL:* The dipole is mounted with the spacer to position its feed point exactly below the center marking of the flat phantom section, with the arms oriented parallel to the body axis.
- Feed Point Impedance and Return Loss:* These parameters are measured with the dipole positioned under the liquid filled phantom. The impedance stated is transformed from the measurement at the SMA connector to the feed point. The Return Loss ensures low reflected power. No uncertainty required.
- Electrical Delay:* One-way delay between the SMA connector and the antenna feed point. No uncertainty required.
- SAR measured:* SAR measured at the stated antenna input power.
- SAR normalized:* SAR as measured, normalized to an input power of 1 W at the antenna connector.
- SAR for nominal TSL parameters:* The measured TSL parameters are used to calculate the nominal SAR result.

The reported uncertainty of measurement is stated as the standard uncertainty of measurement multiplied by the coverage factor  $k=2$ , which for a normal distribution corresponds to a coverage probability of approximately 95%.

## Measurement Conditions

DASY system configuration, as far as not given on page 1.

DASY Version	DASY5	V52.8.2
Extrapolation	Advanced Extrapolation	
Phantom	Modular Flat Phantom	
Distance Dipole Center - TSL	10 mm	with Spacer
Zoom Scan Resolution	dx, dy, dz = 5 mm	
Frequency	2450 MHz $\pm$ 1 MHz	

## Head TSL parameters

The following parameters and calculations were applied.

	Temperature	Permittivity	Conductivity
Nominal Head TSL parameters	22.0 °C	39.2	1.80 mho/m
Measured Head TSL parameters	(22.0 $\pm$ 0.2) °C	39.2 $\pm$ 6 %	1.81 mho/m $\pm$ 6 %
Head TSL temperature change during test	< 0.5 °C	----	----

## SAR result with Head TSL

SAR averaged over 1 cm <sup>3</sup> (1 g) of Head TSL	Condition	
SAR measured	250 mW input power	13.2 mW / g
SAR for nominal Head TSL parameters	normalized to 1W	<b>52.7 mW / g <math>\pm</math> 17.0 % (k=2)</b>

SAR averaged over 10 cm <sup>3</sup> (10 g) of Head TSL	condition	
SAR measured	250 mW input power	6.19 mW / g
SAR for nominal Head TSL parameters	normalized to 1W	<b>24.7 mW / g <math>\pm</math> 16.5 % (k=2)</b>

## Body TSL parameters

The following parameters and calculations were applied.

	Temperature	Permittivity	Conductivity
Nominal Body TSL parameters	22.0 °C	52.7	1.95 mho/m
Measured Body TSL parameters	(22.0 $\pm$ 0.2) °C	51.3 $\pm$ 6 %	1.99 mho/m $\pm$ 6 %
Body TSL temperature change during test	< 0.5 °C	----	----

## SAR result with Body TSL

SAR averaged over 1 cm <sup>3</sup> (1 g) of Body TSL	Condition	
SAR measured	250 mW input power	13.1 mW / g
SAR for nominal Body TSL parameters	normalized to 1W	<b>51.6 mW / g <math>\pm</math> 17.0 % (k=2)</b>

SAR averaged over 10 cm <sup>3</sup> (10 g) of Body TSL	condition	
SAR measured	250 mW input power	6.16 mW / g
SAR for nominal Body TSL parameters	normalized to 1W	<b>24.4 mW / g <math>\pm</math> 16.5 % (k=2)</b>

## Appendix

### Antenna Parameters with Head TSL

Impedance, transformed to feed point	54.4 $\Omega$ + 3.8 j $\Omega$
Return Loss	- 25.1 dB

### Antenna Parameters with Body TSL

Impedance, transformed to feed point	50.7 $\Omega$ + 5.9 j $\Omega$
Return Loss	- 24.6 dB

### General Antenna Parameters and Design

Electrical Delay (one direction)	1.150 ns
----------------------------------	----------

After long term use with 100W radiated power, only a slight warming of the dipole near the feedpoint can be measured.

The dipole is made of standard semirigid coaxial cable. The center conductor of the feeding line is directly connected to the second arm of the dipole. The antenna is therefore short-circuited for DC-signals. On some of the dipoles, small end caps are added to the dipole arms in order to improve matching when loaded according to the position as explained in the "Measurement Conditions" paragraph. The SAR data are not affected by this change. The overall dipole length is still according to the Standard.

No excessive force must be applied to the dipole arms, because they might bend or the soldered connections near the feedpoint may be damaged.

### Additional EUT Data

Manufactured by	SPEAG
Manufactured on	September 10, 2002

## DASY5 Validation Report for Head TSL

Date: 23.08.2012

Test Laboratory: SPEAG, Zurich, Switzerland

**DUT: Dipole 2450 MHz; Type: D2450V2; Serial: D2450V2 - SN: 719**

Communication System: CW; Frequency: 2450 MHz

Medium parameters used:  $f = 2450$  MHz;  $\sigma = 1.81$  mho/m;  $\epsilon_r = 39.2$ ;  $\rho = 1000$  kg/m<sup>3</sup>

Phantom section: Flat Section

Measurement Standard: DASY5 (IEEE/IEC/ANSI C63.19-2007)

DASY52 Configuration:

- Probe: ES3DV3 - SN3205; ConvF(4.45, 4.45, 4.45); Calibrated: 30.12.2011;
- Sensor-Surface: 3mm (Mechanical Surface Detection)
- Electronics: DAE4 Sn601; Calibrated: 27.06.2012
- Phantom: Flat Phantom 5.0 (front); Type: QD000P50AA; Serial: 1001
- DASY52 52.8.2(969); SEMCAD X 14.6.6(6824)

**Dipole Calibration for Head Tissue/Pin=250 mW, d=10mm/Zoom Scan (7x7x7)/Cube 0:**

Measurement grid: dx=5mm, dy=5mm, dz=5mm

Reference Value = 99.219 V/m; Power Drift = 0.03 dB

Peak SAR (extrapolated) = 26.633 mW/g

**SAR(1 g) = 13.2 mW/g; SAR(10 g) = 6.19 mW/g**

Maximum value of SAR (measured) = 16.5 W/kg

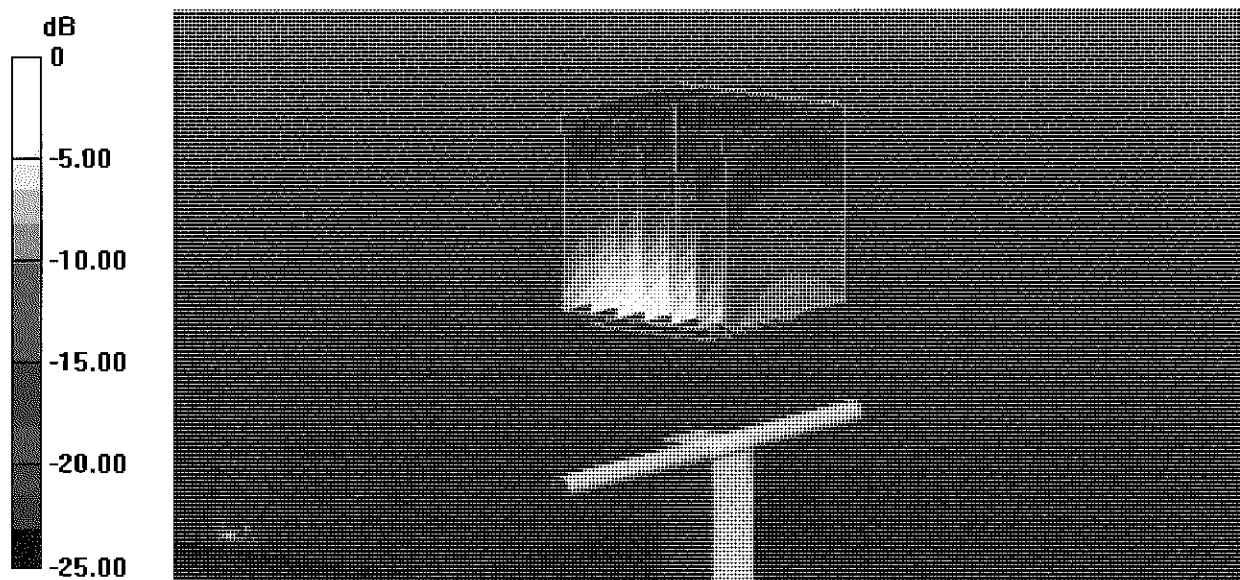

0 dB = 16.5 W/kg = 24.35 dB W/kg

# Impedance Measurement Plot for Head TSL

22 Aug 2012 15:39:08

CH1 S11 1 U FS

3: 54.416  $\Omega$  3.7656  $\Omega$  244.62 pF

2 450.000 000 MHz

\*  
Del

CΔ

Avg  
16

H1 d

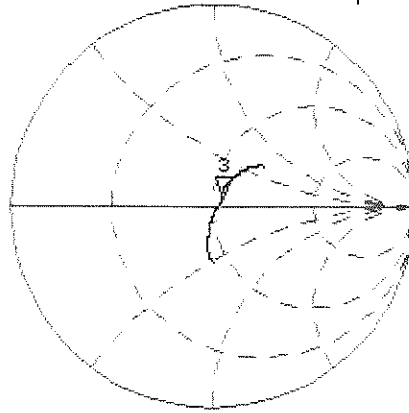

CH2 S11

L06

5 dB/REF -20 dB

3: -25.109 dB

2 450.000 000 MHz

CΔ

Avg  
16

H1 d

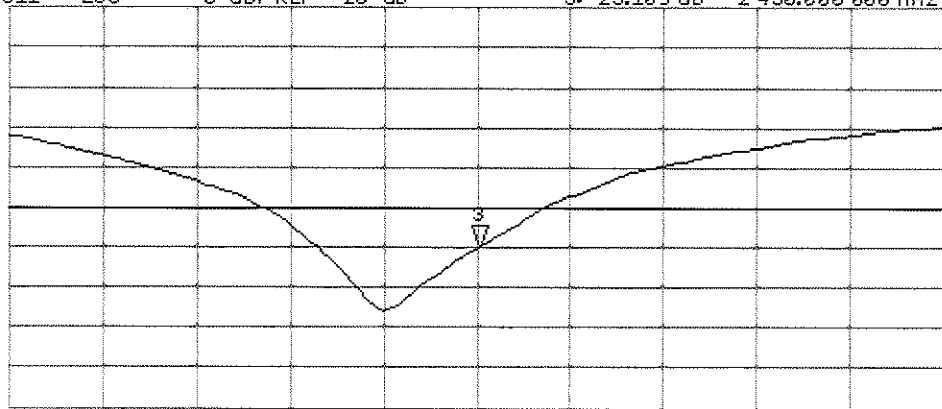

START 2 250.000 000 MHz

STOP 2 650.000 000 MHz

## DASY5 Validation Report for Body TSL

Date: 22.08.2012

Test Laboratory: SPEAG, Zurich, Switzerland

**DUT: Dipole 2450 MHz; Type: D2450V2; Serial: D2450V2 - SN: 719**

Communication System: CW; Frequency: 2450 MHz

Medium parameters used:  $f = 2450$  MHz;  $\sigma = 1.99$  mho/m;  $\epsilon_r = 51.3$ ;  $\rho = 1000$  kg/m<sup>3</sup>

Phantom section: Flat Section

Measurement Standard: DASY5 (IEEE/IEC/ANSI C63.19-2007)

DASY52 Configuration:

- Probe: ES3DV3 - SN3205; ConvF(4.26, 4.26, 4.26); Calibrated: 30.12.2011;
- Sensor-Surface: 3mm (Mechanical Surface Detection)
- Electronics: DAE4 Sn601; Calibrated: 27.06.2012
- Phantom: Flat Phantom 5.0 (back); Type: QD000P50AA; Serial: 1002
- DASY52 52.8.2(969); SEMCAD X 14.6.6(6824)

### Dipole Calibration for Body Tissue/Pin=250 mW, d=10mm/Zoom Scan (7x7x7)/Cube 0:

Measurement grid: dx=5mm, dy=5mm, dz=5mm

Reference Value = 95.970 V/m; Power Drift = 0.03 dB

Peak SAR (extrapolated) = 26.692 mW/g

**SAR(1 g) = 13.1 mW/g; SAR(10 g) = 6.16 mW/g**

Maximum value of SAR (measured) = 17.1 W/kg

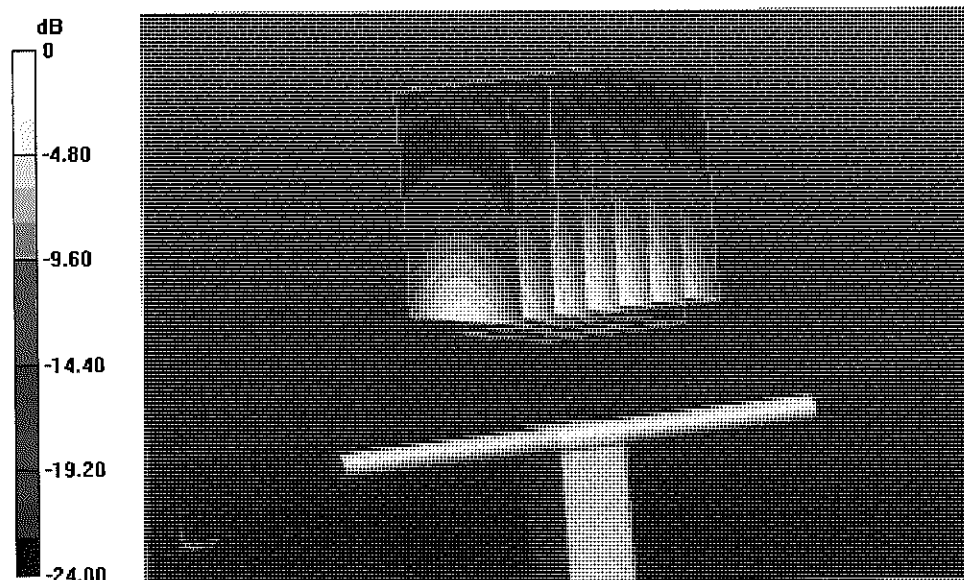

0 dB = 17.1 W/kg = 24.66 dB W/kg

# Impedance Measurement Plot for Body TSL

22 Aug 2012 15:38:22

[CH1] S11 1 U FS

3: 50.709  $\Omega$  5.8906  $\Omega$  382.66 pF

2 450.000 000 MHz

\*  
Del  
CA  
Avg  
16  
H1d

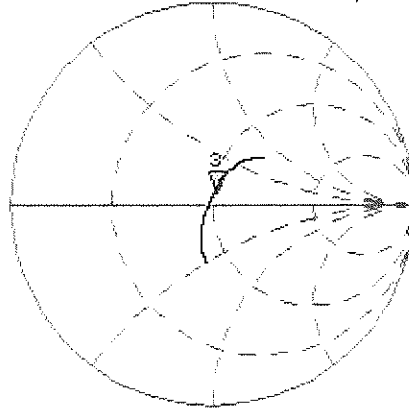

CH2 S11 LOG 5 dB/REF -20 dB 3: -24.605 dB 2 450.000 000 MHz

CA  
Avg  
16  
H1d

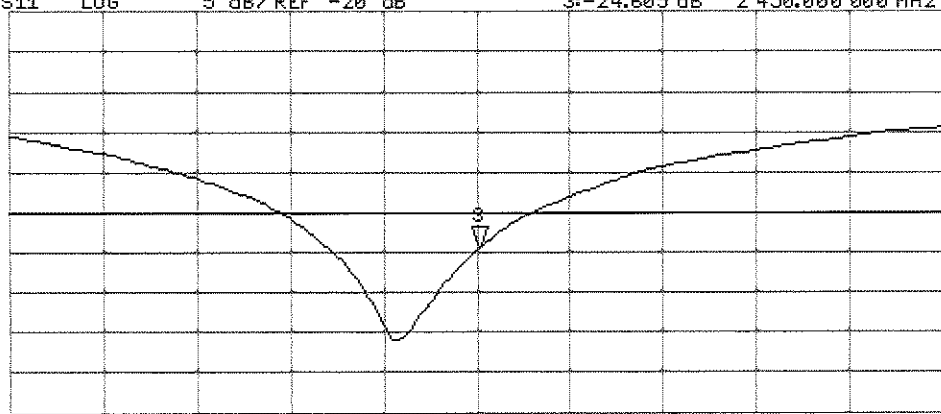

START 2 250.000 000 MHz

STOP 2 650.000 000 MHz



Accredited by the Swiss Accreditation Service (SAS)  
The Swiss Accreditation Service is one of the signatories to the EA  
Multilateral Agreement for the recognition of calibration certificates

Accreditation No.: **SCS 108**

Client **PC Test**

Certificate No: **D5GHzV2-1057\_Jan13**

## CALIBRATION CERTIFICATE

Object **D5GHzV2 - SN: 1057**

Calibration procedure(s) **QA CAL-22.v2  
Calibration procedure for dipole validation kits between 3-6 GHz**

Calibration date: **January 11, 2013**

✓  
KOK  
1/29/13

This calibration certificate documents the traceability to national standards, which realize the physical units of measurements (SI).  
The measurements and the uncertainties with confidence probability are given on the following pages and are part of the certificate.

All calibrations have been conducted in the closed laboratory facility: environment temperature ( $22 \pm 3$ )°C and humidity < 70%.

Calibration Equipment used (M&TE critical for calibration)

Primary Standards	ID #	Cal Date (Certificate No.)	Scheduled Calibration
Power meter EPM-442A	GB37480704	01-Nov-12 (No. 217-01640)	Oct-13
Power sensor HP 8481A	US37292783	01-Nov-12 (No. 217-01640)	Oct-13
Reference 20 dB Attenuator	SN: 5058 (20k)	27-Mar-12 (No. 217-01530)	Apr-13
Type-N mismatch combination	SN: 5047.3 / 06327	27-Mar-12 (No. 217-01533)	Apr-13
Reference Probe EX3DV4	SN: 3503	28-Dec-12 (No. EX3-3503_Dec12)	Dec-13
DAE4	SN: 601	27-Jun-12 (No. DAE4-601_Jun12)	Jun-13
Secondary Standards	ID #	Check Date (in house)	Scheduled Check
Power sensor HP 8481A	MY41092317	18-Oct-02 (in house check Oct-11)	In house check: Oct-13
RF generator R&S SMT-06	100005	04-Aug-99 (in house check Oct-11)	In house check: Oct-13
Network Analyzer HP 8753E	US37390585 S4206	18-Oct-01 (in house check Oct-12)	In house check: Oct-13

Calibrated by: **Israe El-Naouq**      Name: **Israe El-Naouq**      Function: **Laboratory Technician**      Signature: *Israe El-Naouq*

Approved by: **Katja Pokovic**      Name: **Katja Pokovic**      Function: **Technical Manager**      Signature: *Katja Pokovic*

Issued: January 11, 2013

This calibration certificate shall not be reproduced except in full without written approval of the laboratory.



Accredited by the Swiss Accreditation Service (SAS)

The Swiss Accreditation Service is one of the signatories to the EA  
Multilateral Agreement for the recognition of calibration certificates

Accreditation No.: **SCS 108**

### Glossary:

TSL	tissue simulating liquid
ConvF	sensitivity in TSL / NORM x,y,z
N/A	not applicable or not measured

### Calibration is Performed According to the Following Standards:

- IEC 62209-2, "Evaluation of Human Exposure to Radio Frequency Fields from Handheld and Body-Mounted Wireless Communication Devices in the Frequency Range of 30 MHz to 6 GHz: Human models, Instrumentation, and Procedures"; Part 2: "Procedure to determine the Specific Absorption Rate (SAR) for including accessories and multiple transmitters", March 2010
- Federal Communications Commission Office of Engineering & Technology (FCC OET), "Evaluating Compliance with FCC Guidelines for Human Exposure to Radiofrequency Electromagnetic Fields; Additional Information for Evaluating Compliance of Mobile and Portable Devices with FCC Limits for Human Exposure to Radiofrequency Emissions", Supplement C (Edition 01-01) to Bulletin 65

### Additional Documentation:

- DASY4/5 System Handbook

### Methods Applied and Interpretation of Parameters:

- Measurement Conditions:* Further details are available from the Validation Report at the end of the certificate. All figures stated in the certificate are valid at the frequency indicated.
- Antenna Parameters with TSL:* The dipole is mounted with the spacer to position its feed point exactly below the center marking of the flat phantom section, with the arms oriented parallel to the body axis.
- Feed Point Impedance and Return Loss:* These parameters are measured with the dipole positioned under the liquid filled phantom. The impedance stated is transformed from the measurement at the SMA connector to the feed point. The Return Loss ensures low reflected power. No uncertainty required.
- Electrical Delay:* One-way delay between the SMA connector and the antenna feed point. No uncertainty required.
- SAR measured:* SAR measured at the stated antenna input power.
- SAR normalized:* SAR as measured, normalized to an input power of 1 W at the antenna connector.
- SAR for nominal TSL parameters:* The measured TSL parameters are used to calculate the nominal SAR result.

The reported uncertainty of measurement is stated as the standard uncertainty of measurement multiplied by the coverage factor  $k=2$ , which for a normal distribution corresponds to a coverage probability of approximately 95%.

## Measurement Conditions

DASY system configuration, as far as not given on page 1.

<b>DASY Version</b>	DASY5	V52.8.5
<b>Extrapolation</b>	Advanced Extrapolation	
<b>Phantom</b>	Modular Flat Phantom V5.0	
<b>Distance Dipole Center - TSL</b>	10 mm	with Spacer
<b>Zoom Scan Resolution</b>	dx, dy = 4.0 mm, dz = 1.4 mm	Graded Ratio = 1.4 (Z direction)
<b>Frequency</b>	5200 MHz ± 1 MHz 5300 MHz ± 1 MHz 5500 MHz ± 1 MHz 5600 MHz ± 1 MHz 5800 MHz ± 1 MHz	

## Head TSL parameters at 5200 MHz

The following parameters and calculations were applied.

	Temperature	Permittivity	Conductivity
<b>Nominal Head TSL parameters</b>	22.0 °C	36.0	4.66 mho/m
<b>Measured Head TSL parameters</b>	(22.0 ± 0.2) °C	34.6 ± 6 %	4.50 mho/m ± 6 %
<b>Head TSL temperature change during test</b>	< 0.5 °C	----	----

## SAR result with Head TSL at 5200 MHz

<b>SAR averaged over 1 cm<sup>3</sup> (1 g) of Head TSL</b>	Condition	
SAR measured	100 mW input power	7.66 W/kg
SAR for nominal Head TSL parameters	normalized to 1W	<b>75.9 W/kg ± 19.9 % (k=2)</b>

<b>SAR averaged over 10 cm<sup>3</sup> (10 g) of Head TSL</b>	condition	
SAR measured	100 mW input power	2.17 W/kg
SAR for nominal Head TSL parameters	normalized to 1W	<b>21.4 W/kg ± 19.5 % (k=2)</b>

### Head TSL parameters at 5300 MHz

The following parameters and calculations were applied.

	Temperature	Permittivity	Conductivity
Nominal Head TSL parameters	22.0 °C	35.9	4.76 mho/m
Measured Head TSL parameters	(22.0 ± 0.2) °C	34.5 ± 6 %	4.60 mho/m ± 6 %
Head TSL temperature change during test	< 0.5 °C	----	----

### SAR result with Head TSL at 5300 MHz

SAR averaged over 1 cm <sup>3</sup> (1 g) of Head TSL	Condition	
SAR measured	100 mW input power	7.76 W/kg
SAR for nominal Head TSL parameters	normalized to 1W	<b>76.9 W / kg ± 19.9 % (k=2)</b>

SAR averaged over 10 cm <sup>3</sup> (10 g) of Head TSL	condition	
SAR measured	100 mW input power	2.22 W/kg
SAR for nominal Head TSL parameters	normalized to 1W	<b>21.9 W/kg ± 19.5 % (k=2)</b>

### Head TSL parameters at 5500 MHz

The following parameters and calculations were applied.

	Temperature	Permittivity	Conductivity
Nominal Head TSL parameters	22.0 °C	35.6	4.96 mho/m
Measured Head TSL parameters	(22.0 ± 0.2) °C	34.2 ± 6 %	4.79 mho/m ± 6 %
Head TSL temperature change during test	< 0.5 °C	----	----

### SAR result with Head TSL at 5500 MHz

SAR averaged over 1 cm <sup>3</sup> (1 g) of Head TSL	Condition	
SAR measured	100 mW input power	8.09 W/kg
SAR for nominal Head TSL parameters	normalized to 1W	<b>80.1 W/kg ± 19.9 % (k=2)</b>

SAR averaged over 10 cm <sup>3</sup> (10 g) of Head TSL	condition	
SAR measured	100 mW input power	2.28 W/kg
SAR for nominal Head TSL parameters	normalized to 1W	<b>22.5 W/kg ± 19.5 % (k=2)</b>

### Head TSL parameters at 5600 MHz

The following parameters and calculations were applied.

	Temperature	Permittivity	Conductivity
Nominal Head TSL parameters	22.0 °C	35.5	5.07 mho/m
Measured Head TSL parameters	(22.0 ± 0.2) °C	34.1 ± 6 %	4.88 mho/m ± 6 %
Head TSL temperature change during test	< 0.5 °C	----	----

### SAR result with Head TSL at 5600 MHz

SAR averaged over 1 cm <sup>3</sup> (1 g) of Head TSL	Condition	
SAR measured	100 mW input power	8.12 W/kg
SAR for nominal Head TSL parameters	normalized to 1W	<b>80.4 W/kg ± 19.9 % (k=2)</b>

SAR averaged over 10 cm <sup>3</sup> (10 g) of Head TSL	condition	
SAR measured	100 mW input power	2.30 W/kg
SAR for nominal Head TSL parameters	normalized to 1W	<b>22.7 W/kg ± 19.5 % (k=2)</b>

### Head TSL parameters at 5800 MHz

The following parameters and calculations were applied.

	Temperature	Permittivity	Conductivity
Nominal Head TSL parameters	22.0 °C	35.3	5.27 mho/m
Measured Head TSL parameters	(22.0 ± 0.2) °C	33.8 ± 6 %	5.09 mho/m ± 6 %
Head TSL temperature change during test	< 0.5 °C	----	----

### SAR result with Head TSL at 5800 MHz

SAR averaged over 1 cm <sup>3</sup> (1 g) of Head TSL	Condition	
SAR measured	100 mW input power	7.69 W/kg
SAR for nominal Head TSL parameters	normalized to 1W	<b>76.1 W/kg ± 19.9 % (k=2)</b>

SAR averaged over 10 cm <sup>3</sup> (10 g) of Head TSL	condition	
SAR measured	100 mW input power	2.17 W/kg
SAR for nominal Head TSL parameters	normalized to 1W	<b>21.4 W/kg ± 19.5 % (k=2)</b>

### Body TSL parameters at 5200 MHz

The following parameters and calculations were applied.

	Temperature	Permittivity	Conductivity
Nominal Body TSL parameters	22.0 °C	49.0	5.30 mho/m
Measured Body TSL parameters	(22.0 ± 0.2) °C	47.0 ± 6 %	5.42 mho/m ± 6 %
Body TSL temperature change during test	< 0.5 °C	----	----

### SAR result with Body TSL at 5200 MHz

SAR averaged over 1 cm <sup>3</sup> (1 g) of Body TSL	Condition	
SAR measured	100 mW input power	7.61 W/kg
SAR for nominal Body TSL parameters	normalized to 1W	<b>75.5 W/kg ± 19.9 % (k=2)</b>

SAR averaged over 10 cm <sup>3</sup> (10 g) of Body TSL	condition	
SAR measured	100 mW input power	2.13 W/kg
SAR for nominal Body TSL parameters	normalized to 1W	<b>21.1 W/kg ± 19.5 % (k=2)</b>

### Body TSL parameters at 5300 MHz

The following parameters and calculations were applied.

	Temperature	Permittivity	Conductivity
Nominal Body TSL parameters	22.0 °C	48.9	5.42 mho/m
Measured Body TSL parameters	(22.0 ± 0.2) °C	46.8 ± 6 %	5.55 mho/m ± 6 %
Body TSL temperature change during test	< 0.5 °C	----	----

### SAR result with Body TSL at 5300 MHz

SAR averaged over 1 cm <sup>3</sup> (1 g) of Body TSL	Condition	
SAR measured	100 mW input power	7.59 W/kg
SAR for nominal Body TSL parameters	normalized to 1W	<b>75.3 W/kg ± 19.9 % (k=2)</b>

SAR averaged over 10 cm <sup>3</sup> (10 g) of Body TSL	condition	
SAR measured	100 mW input power	2.13 W/kg
SAR for nominal Body TSL parameters	normalized to 1W	<b>21.1 W/kg ± 19.5 % (k=2)</b>

### Body TSL parameters at 5500 MHz

The following parameters and calculations were applied.

	Temperature	Permittivity	Conductivity
Nominal Body TSL parameters	22.0 °C	48.6	5.65 mho/m
Measured Body TSL parameters	(22.0 ± 0.2) °C	46.5 ± 6 %	5.81 mho/m ± 6 %
Body TSL temperature change during test	< 0.5 °C	----	----

### SAR result with Body TSL at 5500 MHz

SAR averaged over 1 cm <sup>3</sup> (1 g) of Body TSL	Condition	
SAR measured	100 mW input power	8.14 W/kg
SAR for nominal Body TSL parameters	normalized to 1W	<b>80.8 W/kg ± 19.9 % (k=2)</b>

SAR averaged over 10 cm <sup>3</sup> (10 g) of Body TSL	condition	
SAR measured	100 mW input power	2.26 W/kg
SAR for nominal Body TSL parameters	normalized to 1W	<b>22.4 W/kg ± 19.5 % (k=2)</b>

### Body TSL parameters at 5600 MHz

The following parameters and calculations were applied.

	Temperature	Permittivity	Conductivity
Nominal Body TSL parameters	22.0 °C	48.5	5.77 mho/m
Measured Body TSL parameters	(22.0 ± 0.2) °C	46.3 ± 6 %	5.94 mho/m ± 6 %
Body TSL temperature change during test	< 0.5 °C	----	----

### SAR result with Body TSL at 5600 MHz

SAR averaged over 1 cm <sup>3</sup> (1 g) of Body TSL	Condition	
SAR measured	100 mW input power	8.10 W/kg
SAR for nominal Body TSL parameters	normalized to 1W	<b>80.3 W/kg ± 19.9 % (k=2)</b>

SAR averaged over 10 cm <sup>3</sup> (10 g) of Body TSL	condition	
SAR measured	100 mW input power	2.25 W/kg
SAR for nominal Body TSL parameters	normalized to 1W	<b>22.3 W/kg ± 19.5 % (k=2)</b>

### Body TSL parameters at 5800 MHz

The following parameters and calculations were applied.

	Temperature	Permittivity	Conductivity
Nominal Body TSL parameters	22.0 °C	48.2	6.00 mho/m
Measured Body TSL parameters	(22.0 ± 0.2) °C	46.0 ± 6 %	6.21 mho/m ± 6 %
Body TSL temperature change during test	< 0.5 °C	----	----

### SAR result with Body TSL at 5800 MHz

SAR averaged over 1 cm <sup>3</sup> (1 g) of Body TSL	Condition	
SAR measured	100 mW input power	7.57 W/kg
SAR for nominal Body TSL parameters	normalized to 1W	<b>75.1 W/kg ± 19.9 % (k=2)</b>

SAR averaged over 10 cm <sup>3</sup> (10 g) of Body TSL	condition	
SAR measured	100 mW input power	2.09 W/kg
SAR for nominal Body TSL parameters	normalized to 1W	<b>20.7 W/kg ± 19.5 % (k=2)</b>

## Appendix

### Antenna Parameters with Head TSL at 5200 MHz

Impedance, transformed to feed point	50.5 $\Omega$ - 9.8 j $\Omega$
Return Loss	- 20.3 dB

### Antenna Parameters with Head TSL at 5300 MHz

Impedance, transformed to feed point	48.5 $\Omega$ - 4.5 j $\Omega$
Return Loss	- 26.4 dB

### Antenna Parameters with Head TSL at 5500 MHz

Impedance, transformed to feed point	50.6 $\Omega$ - 5.8 j $\Omega$
Return Loss	- 24.8 dB

### Antenna Parameters with Head TSL at 5600 MHz

Impedance, transformed to feed point	53.9 $\Omega$ - 3.8 j $\Omega$
Return Loss	- 25.6 dB

### Antenna Parameters with Head TSL at 5800 MHz

Impedance, transformed to feed point	52.5 $\Omega$ - 4.4 j $\Omega$
Return Loss	- 26.1 dB

### Antenna Parameters with Body TSL at 5200 MHz

Impedance, transformed to feed point	49.3 $\Omega$ - 7.9 j $\Omega$
Return Loss	- 22.0 dB

### Antenna Parameters with Body TSL at 5300 MHz

Impedance, transformed to feed point	48.7 $\Omega$ - 3.2 j $\Omega$
Return Loss	- 29.2 dB

### Antenna Parameters with Body TSL at 5500 MHz

Impedance, transformed to feed point	51.2 $\Omega$ - 4.8 j $\Omega$
Return Loss	- 26.2 dB

### Antenna Parameters with Body TSL at 5600 MHz

Impedance, transformed to feed point	53.6 $\Omega$ - 2.1 j $\Omega$
Return Loss	- 27.9 dB

## Antenna Parameters with Body TSL at 5800 MHz

Impedance, transformed to feed point	53.3 $\Omega$ - 2.9 j $\Omega$
Return Loss	- 27.4 dB

## General Antenna Parameters and Design

Electrical Delay (one direction)	1.202 ns
----------------------------------	----------

After long term use with 100W radiated power, only a slight warming of the dipole near the feedpoint can be measured.

The dipole is made of standard semirigid coaxial cable. The center conductor of the feeding line is directly connected to the second arm of the dipole. The antenna is therefore short-circuited for DC-signals. On some of the dipoles, small end caps are added to the dipole arms in order to improve matching when loaded according to the position as explained in the "Measurement Conditions" paragraph. The SAR data are not affected by this change. The overall dipole length is still according to the Standard.

No excessive force must be applied to the dipole arms, because they might bend or the soldered connections near the feedpoint may be damaged.

## Additional EUT Data

Manufactured by	SPEAG
Manufactured on	November 27, 2006

## DASY5 Validation Report for Head TSL

Date: 11.01.2013

Test Laboratory: SPEAG, Zurich, Switzerland

**DUT: Dipole 5GHz; Type: D5GHzV2; Serial: D5GHzV2 - SN: 1057**

Communication System: CW; Frequency: 5200 MHz, Frequency: 5300 MHz, Frequency: 5500 MHz, Frequency: 5600 MHz, Frequency: 5800 MHz

Medium parameters used:  $f = 5200$  MHz;  $\sigma = 4.5$  S/m;  $\epsilon_r = 34.6$ ;  $\rho = 1000$  kg/m<sup>3</sup>, Medium parameters used:  $f = 5300$  MHz;  $\sigma = 4.6$  S/m;  $\epsilon_r = 34.5$ ;  $\rho = 1000$  kg/m<sup>3</sup>, Medium parameters used:  $f = 5500$  MHz;  $\sigma = 4.79$  S/m;  $\epsilon_r = 34.2$ ;  $\rho = 1000$  kg/m<sup>3</sup>, Medium parameters used:  $f = 5600$  MHz;  $\sigma = 4.88$  S/m;  $\epsilon_r = 34.1$ ;  $\rho = 1000$  kg/m<sup>3</sup>, Medium parameters used:  $f = 5800$  MHz;  $\sigma = 5.09$  S/m;  $\epsilon_r = 33.8$ ;  $\rho = 1000$  kg/m<sup>3</sup>

Phantom section: Flat Section

Measurement Standard: DASY5 (IEEE/IEC/ANSI C63.19-2007)

DASY52 Configuration:

- Probe: EX3DV4 - SN3503; ConvF(5.41, 5.41, 5.41); Calibrated: 28.12.2012, ConvF(5.1, 5.1, 5.1); Calibrated: 28.12.2012, ConvF(4.91, 4.91, 4.91); Calibrated: 28.12.2012, ConvF(4.76, 4.76, 4.76); Calibrated: 28.12.2012, ConvF(4.81, 4.81, 4.81); Calibrated: 28.12.2012;
- Sensor-Surface: 1.4mm (Mechanical Surface Detection)
- Electronics: DAE4 Sn601; Calibrated: 27.06.2012
- Phantom: Flat Phantom 5.0 (front); Type: QD000P50AA; Serial: 1001
- DASY52 52.8.5(1059); SEMCAD X 14.6.8(7028)

**Dipole Calibration for Head Tissue/Pin=100mW, dist=10mm, f=5200 MHz/Zoom Scan,**

**dist=1.4mm (8x8x7)/Cube 0:** Measurement grid: dx=4mm, dy=4mm, dz=1.4mm

Reference Value = 63.671 V/m; Power Drift = 0.09 dB

Peak SAR (extrapolated) = 29.4 W/kg

**SAR(1 g) = 7.66 W/kg; SAR(10 g) = 2.17 W/kg**

Maximum value of SAR (measured) = 18.5 W/kg

**Dipole Calibration for Head Tissue/Pin=100mW, dist=10mm, f=5300 MHz/Zoom Scan,**

**dist=1.4mm (8x8x7)/Cube 0:** Measurement grid: dx=4mm, dy=4mm, dz=1.4mm

Reference Value = 63.473 V/m; Power Drift = 0.09 dB

Peak SAR (extrapolated) = 30.3 W/kg

**SAR(1 g) = 7.76 W/kg; SAR(10 g) = 2.22 W/kg**

Maximum value of SAR (measured) = 18.8 W/kg

**Dipole Calibration for Head Tissue/Pin=100mW, dist=10mm, f=5500 MHz/Zoom Scan,**

**dist=1.4mm (8x8x7)/Cube 0:** Measurement grid: dx=4mm, dy=4mm, dz=1.4mm

Reference Value = 63.735 V/m; Power Drift = 0.08 dB

Peak SAR (extrapolated) = 33.2 W/kg

**SAR(1 g) = 8.09 W/kg; SAR(10 g) = 2.28 W/kg**

Maximum value of SAR (measured) = 20.1 W/kg

**Dipole Calibration for Head Tissue/Pin=100mW, dist=10mm, f=5600 MHz/Zoom Scan, dist=1.4mm (8x8x7)/Cube 0:** Measurement grid: dx=4mm, dy=4mm, dz=1.4mm  
Reference Value = 63.848 V/m; Power Drift = 0.09 dB  
Peak SAR (extrapolated) = 33.5 W/kg  
**SAR(1 g) = 8.12 W/kg; SAR(10 g) = 2.3 W/kg**  
Maximum value of SAR (measured) = 20.2 W/kg

**Dipole Calibration for Head Tissue/Pin=100mW, dist=10mm, f=5800 MHz/Zoom Scan, dist=1.4mm (8x8x7)/Cube 0:** Measurement grid: dx=4mm, dy=4mm, dz=1.4mm  
Reference Value = 60.467 V/m; Power Drift = 0.08 dB  
Peak SAR (extrapolated) = 33.3 W/kg  
**SAR(1 g) = 7.69 W/kg; SAR(10 g) = 2.17 W/kg**  
Maximum value of SAR (measured) = 19.4 W/kg

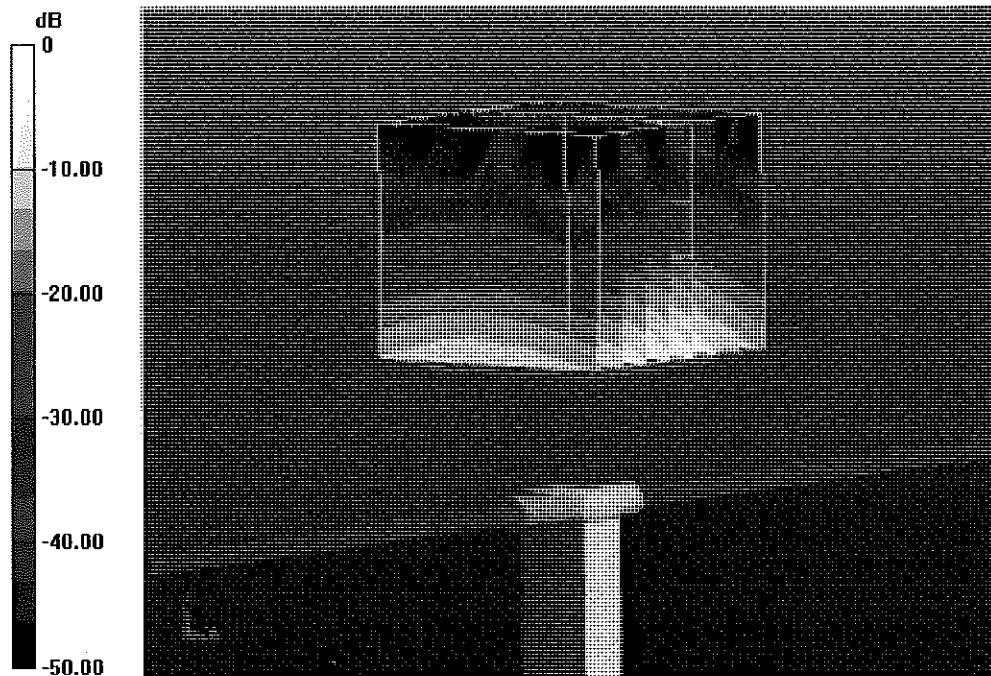

0 dB = 19.4 W/kg = 12.88 dBW/kg

# Impedance Measurement Plot for Head TSL

11 Jan 2013 09:26:56

CH1 S11 1 U FS 1: 50.543  $\Omega$  -9.7754  $\Omega$  3.1310 pF 5 200.000 000 MHz

\*  
De1  
CA  
Avg  
16  
H1d

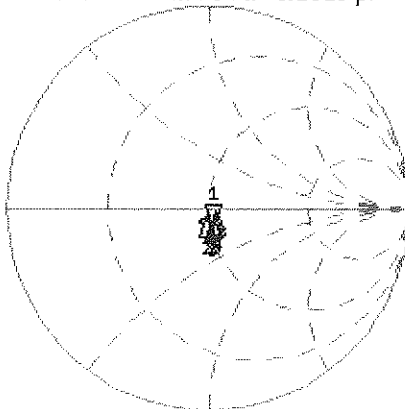

CH1 Markers

- 2: 48.508  $\Omega$   
-4.4805  $\Omega$   
5.30000 GHz
- 3: 50.617  $\Omega$   
-5.7559  $\Omega$   
5.50000 GHz
- 4: 53.891  $\Omega$   
-3.8418  $\Omega$   
5.60000 GHz
- 5: 52.500  $\Omega$   
-4.4160  $\Omega$   
5.80000 GHz

CH2 S11 LOG 5 dB/REF -20 dB 1: -20.273 dB 5 200.000 000 MHz

CA  
Avg  
16  
H1d

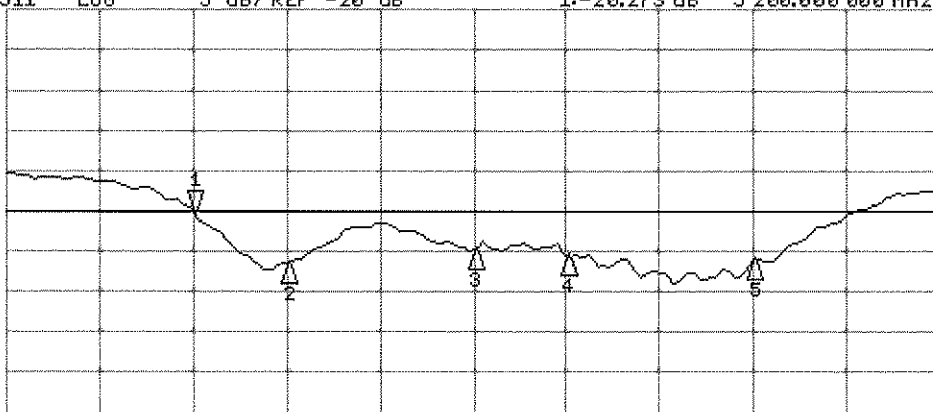

CH2 Markers

- 2: -25.396 dB  
5.30000 GHz
- 3: -24.818 dB  
5.50000 GHz
- 4: -25.573 dB  
5.60000 GHz
- 5: -26.115 dB  
5.80000 GHz

START 5 000.000 000 MHz

STOP 6 000.000 000 MHz

## DASY5 Validation Report for Body TSL

Date: 10.01.2013

Test Laboratory: SPEAG, Zurich, Switzerland

**DUT: Dipole 5GHz; Type: D5GHzV2; Serial: D5GHzV2 - SN: 1057**

Communication System: CW; Frequency: 5200 MHz, Frequency: 5300 MHz, Frequency: 5500 MHz, Frequency: 5600 MHz, Frequency: 5800 MHz

Medium parameters used:  $f = 5200$  MHz;  $\sigma = 5.42$  S/m;  $\epsilon_r = 47$ ;  $\rho = 1000$  kg/m<sup>3</sup>, Medium parameters used:  $f = 5300$  MHz;  $\sigma = 5.55$  S/m;  $\epsilon_r = 46.8$ ;  $\rho = 1000$  kg/m<sup>3</sup>, Medium parameters used:  $f = 5500$  MHz;  $\sigma = 5.81$  S/m;  $\epsilon_r = 46.5$ ;  $\rho = 1000$  kg/m<sup>3</sup>, Medium parameters used:  $f = 5600$  MHz;  $\sigma = 5.94$  S/m;  $\epsilon_r = 46.3$ ;  $\rho = 1000$  kg/m<sup>3</sup>, Medium parameters used:  $f = 5800$  MHz;  $\sigma = 6.21$  S/m;  $\epsilon_r = 46$ ;  $\rho = 1000$  kg/m<sup>3</sup>

Phantom section: Flat Section

Measurement Standard: DASY5 (IEEE/IEC/ANSI C63.19-2007)

DASY52 Configuration:

- Probe: EX3DV4 - SN3503; ConvF(4.91, 4.91, 4.91); Calibrated: 28.12.2012, ConvF(4.67, 4.67, 4.67); Calibrated: 28.12.2012, ConvF(4.43, 4.43, 4.43); Calibrated: 28.12.2012, ConvF(4.22, 4.22, 4.22); Calibrated: 28.12.2012, ConvF(4.38, 4.38, 4.38); Calibrated: 28.12.2012;
- Sensor-Surface: 1.4mm (Mechanical Surface Detection)
- Electronics: DAE4 Sn601; Calibrated: 27.06.2012
- Phantom: Flat Phantom 5.0 (back); Type: QD000P50AA; Serial: 1002
- DASY52 52.8.5(1059); SEMCAD X 14.6.8(7028)

**Dipole Calibration for Body Tissue/Pin=100mW, dist=10mm, f=5200 MHz/Zoom Scan, dist=1.4mm (8x8x7)/Cube 0:** Measurement grid: dx=4mm, dy=4mm, dz=1.4mm

Reference Value = 59.074 V/m; Power Drift = -0.01 dB

Peak SAR (extrapolated) = 30.4 W/kg

**SAR(1 g) = 7.61 W/kg; SAR(10 g) = 2.13 W/kg**

Maximum value of SAR (measured) = 18.0 W/kg

**Dipole Calibration for Body Tissue/Pin=100mW, dist=10mm, f=5300 MHz/Zoom Scan, dist=1.4mm (8x8x7)/Cube 0:** Measurement grid: dx=4mm, dy=4mm, dz=1.4mm

Reference Value = 58.924 V/m; Power Drift = -0.00 dB

Peak SAR (extrapolated) = 30.9 W/kg

**SAR(1 g) = 7.59 W/kg; SAR(10 g) = 2.13 W/kg**

Maximum value of SAR (measured) = 17.9 W/kg

**Dipole Calibration for Body Tissue/Pin=100mW, dist=10mm, f=5500 MHz/Zoom Scan, dist=1.4mm (8x8x7)/Cube 0:** Measurement grid: dx=4mm, dy=4mm, dz=1.4mm

Reference Value = 59.561 V/m; Power Drift = -0.01 dB

Peak SAR (extrapolated) = 35.3 W/kg

**SAR(1 g) = 8.14 W/kg; SAR(10 g) = 2.26 W/kg**

Maximum value of SAR (measured) = 19.7 W/kg

**Dipole Calibration for Body Tissue/Pin=100mW, dist=10mm, f=5600 MHz/Zoom Scan,**

**dist=1.4mm (8x8x7)/Cube 0:** Measurement grid: dx=4mm, dy=4mm, dz=1.4mm

Reference Value = 58.884 V/m; Power Drift = -0.02 dB

Peak SAR (extrapolated) = 36.3 W/kg

**SAR(1 g) = 8.1 W/kg; SAR(10 g) = 2.25 W/kg**

Maximum value of SAR (measured) = 20.0 W/kg

**Dipole Calibration for Body Tissue/Pin=100mW, dist=10mm, f=5800 MHz/Zoom Scan,**

**dist=1.4mm (8x8x7)/Cube 0:** Measurement grid: dx=4mm, dy=4mm, dz=1.4mm

Reference Value = 55.753 V/m; Power Drift = -0.00 dB

Peak SAR (extrapolated) = 35.6 W/kg

**SAR(1 g) = 7.57 W/kg; SAR(10 g) = 2.09 W/kg**

Maximum value of SAR (measured) = 18.9 W/kg

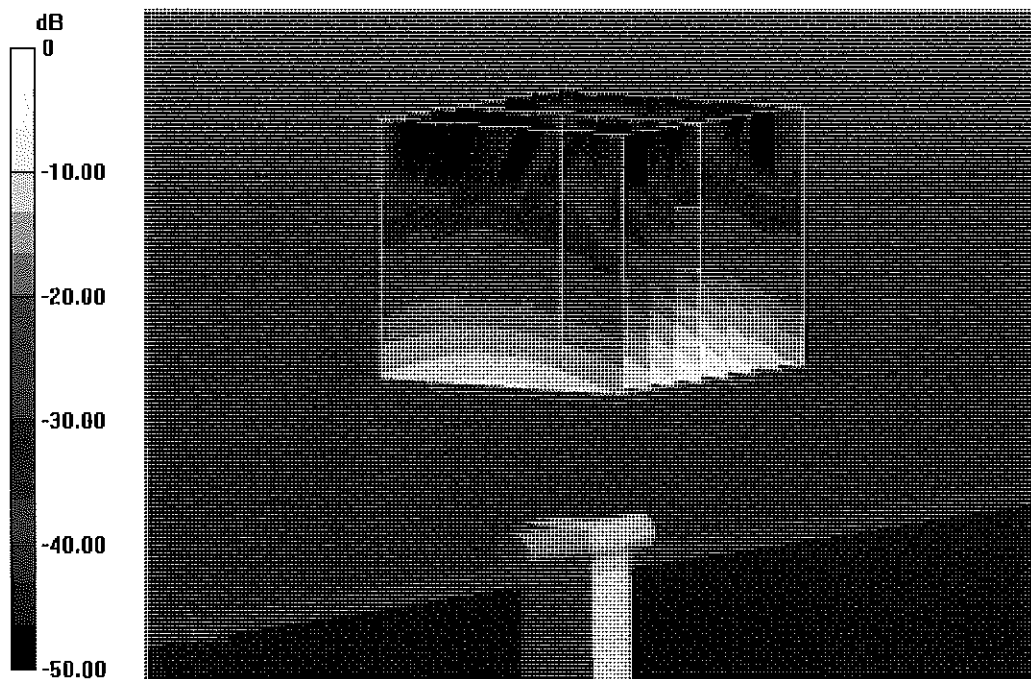

0 dB = 18.9 W/kg = 12.76 dBW/kg

# Impedance Measurement Plot for Body TSL

10 Jan 2013 13:20:10

CH1 S11 1 U FS 1: 49.311  $\Omega$  -7.8789  $\Omega$  3.8846 pF 5 200.000 000 MHz

\*  
Del  
CA  
Avg  
16  
H1d

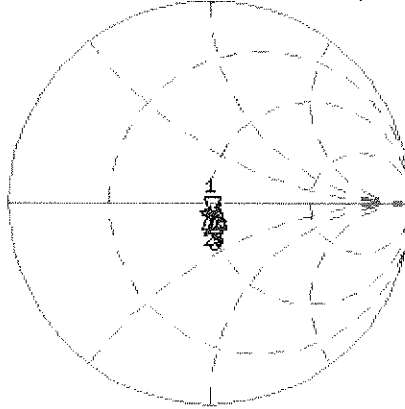

CH1 Markers  
2: 48.729  $\Omega$   
-3.1895  $\Omega$   
5.30000 GHz  
3: 51.209  $\Omega$   
-4.8184  $\Omega$   
5.50000 GHz  
4: 53.596  $\Omega$   
-2.1113  $\Omega$   
5.60000 GHz  
5: 53.314  $\Omega$   
-2.9355  $\Omega$   
5.90000 GHz

CH2 S11 LOG 5 dB/REF -20 dB 1: -22.005 dB 5 200.000 000 MHz

CA  
Avg  
16  
H1d

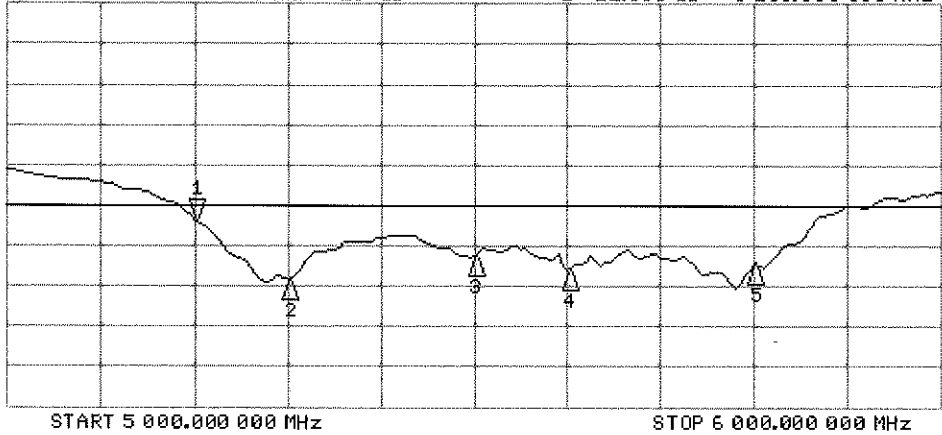

CH2 Markers  
2: -29.181 dB  
5.30000 GHz  
3: -26.190 dB  
5.50000 GHz  
4: -27.903 dB  
5.60000 GHz  
5: -27.367 dB  
5.80000 GHz



Accredited by the Swiss Accreditation Service (SAS)  
The Swiss Accreditation Service is one of the signatories to the EA  
Multilateral Agreement for the recognition of calibration certificates

Accreditation No.: **SCS 108**

Client **PC Test**

Certificate No: **ES3-3022\_Aug12**

**CALIBRATION CERTIFICATE**

Object **ES3DV2 - SN:3022**

Calibration procedure(s) **QA CAL-01.v8, QA CAL-23.v4, QA CAL-25.v4  
Calibration procedure for dosimetric E-field probes**

Calibration date: **August 28, 2012**

This calibration certificate documents the traceability to national standards, which realize the physical units of measurements (SI).  
The measurements and the uncertainties with confidence probability are given on the following pages and are part of the certificate.

All calibrations have been conducted in the closed laboratory facility: environment temperature (22 ± 3)°C and humidity < 70%.

Calibration Equipment used (M&TE critical for calibration)

*Handwritten signature: KOK 9/10*

Primary Standards	ID	Cal Date (Certificate No.)	Scheduled Calibration
Power meter E4419B	GB41293874	29-Mar-12 (No. 217-01508)	Apr-13
Power sensor E4412A	MY41498087	29-Mar-12 (No. 217-01508)	Apr-13
Reference 3 dB Attenuator	SN: S5054 (3c)	27-Mar-12 (No. 217-01531)	Apr-13
Reference 20 dB Attenuator	SN: S5086 (20b)	27-Mar-12 (No. 217-01529)	Apr-13
Reference 30 dB Attenuator	SN: S5129 (30b)	27-Mar-12 (No. 217-01532)	Apr-13
Reference Probe ES3DV2	SN: 3013	29-Dec-11 (No. ES3-3013_Dec11)	Dec-12
DAE4	SN: 660	20-Jun-12 (No. DAE4-660_Jun12)	Jun-13
Secondary Standards	ID	Check Date (in house)	Scheduled Check
RF generator HP 8648C	US3642U01700	4-Aug-99 (in house check Apr-11)	In house check: Apr-13
Network Analyzer HP 8753E	US37390585	18-Oct-01 (in house check Oct-11)	In house check: Oct-12

Calibrated by:	Name <b>Jeton Kastrati</b>	Function <b>Laboratory Technician</b>	Signature 
Approved by:	Name <b>Katja Pokovic</b>	Function <b>Technical Manager</b>	Signature 

Issued: August 28, 2012

This calibration certificate shall not be reproduced except in full without written approval of the laboratory.



Accredited by the Swiss Accreditation Service (SAS)

Accreditation No.: **SCS 108**

The Swiss Accreditation Service is one of the signatories to the EA  
Multilateral Agreement for the recognition of calibration certificates

### Glossary:

TSL	tissue simulating liquid
NORM <sub>x,y,z</sub>	sensitivity in free space
ConvF	sensitivity in TSL / NORM <sub>x,y,z</sub>
DCP	diode compression point
CF	crest factor (1/duty_cycle) of the RF signal
A, B, C	modulation dependent linearization parameters
Polarization $\phi$	$\phi$ rotation around probe axis
Polarization $\vartheta$	$\vartheta$ rotation around an axis that is in the plane normal to probe axis (at measurement center), i.e., $\vartheta = 0$ is normal to probe axis

### Calibration is Performed According to the Following Standards:

- IEEE Std 1528-2003, "IEEE Recommended Practice for Determining the Peak Spatial-Averaged Specific Absorption Rate (SAR) in the Human Head from Wireless Communications Devices: Measurement Techniques", December 2003
- IEC 62209-1, "Procedure to measure the Specific Absorption Rate (SAR) for hand-held devices used in close proximity to the ear (frequency range of 300 MHz to 3 GHz)", February 2005

### Methods Applied and Interpretation of Parameters:

- NORM<sub>x,y,z</sub>**: Assessed for E-field polarization  $\vartheta = 0$  ( $f \leq 900$  MHz in TEM-cell;  $f > 1800$  MHz: R22 waveguide). NORM<sub>x,y,z</sub> are only intermediate values, i.e., the uncertainties of NORM<sub>x,y,z</sub> does not affect the E<sup>2</sup>-field uncertainty inside TSL (see below ConvF).
- NORM(f)<sub>x,y,z</sub> = NORM<sub>x,y,z</sub> \* frequency\_response** (see Frequency Response Chart). This linearization is implemented in DASY4 software versions later than 4.2. The uncertainty of the frequency response is included in the stated uncertainty of ConvF.
- DCP<sub>x,y,z</sub>**: DCP are numerical linearization parameters assessed based on the data of power sweep with CW signal (no uncertainty required). DCP does not depend on frequency nor media.
- PAR**: PAR is the Peak to Average Ratio that is not calibrated but determined based on the signal characteristics
- A<sub>x,y,z</sub>; B<sub>x,y,z</sub>; C<sub>x,y,z</sub>; VR<sub>x,y,z</sub>**: A, B, C are numerical linearization parameters assessed based on the data of power sweep for specific modulation signal. The parameters do not depend on frequency nor media. VR is the maximum calibration range expressed in RMS voltage across the diode.
- ConvF and Boundary Effect Parameters**: Assessed in flat phantom using E-field (or Temperature Transfer Standard for  $f \leq 800$  MHz) and inside waveguide using analytical field distributions based on power measurements for  $f > 800$  MHz. The same setups are used for assessment of the parameters applied for boundary compensation (alpha, depth) of which typical uncertainty values are given. These parameters are used in DASY4 software to improve probe accuracy close to the boundary. The sensitivity in TSL corresponds to NORM<sub>x,y,z</sub> \* ConvF whereby the uncertainty corresponds to that given for ConvF. A frequency dependent ConvF is used in DASY version 4.4 and higher which allows extending the validity from  $\pm 50$  MHz to  $\pm 100$  MHz.
- Spherical isotropy (3D deviation from isotropy)**: in a field of low gradients realized using a flat phantom exposed by a patch antenna.
- Sensor Offset**: The sensor offset corresponds to the offset of virtual measurement center from the probe tip (on probe axis). No tolerance required.

# Probe ES3DV2

## SN:3022

Manufactured: April 15, 2003  
Calibrated: August 28, 2012

Calibrated for DASY/EASY Systems  
(Note: non-compatible with DASY2 system!)

## DASY/EASY - Parameters of Probe: ES3DV2 - SN:3022

### Basic Calibration Parameters

	Sensor X	Sensor Y	Sensor Z	Unc (k=2)
Norm ( $\mu\text{V}/(\text{V}/\text{m})^2$ ) <sup>A</sup>	1.00	1.04	0.99	$\pm 10.1 \%$
DCP (mV) <sup>B</sup>	98.3	99.5	101.3	

### Modulation Calibration Parameters

UID	Communication System Name	PAR		A dB	B dB	C dB	VR mV	Unc <sup>E</sup> (k=2)
0	CW	0.00	X	0.00	0.00	1.00	133.3	$\pm 2.7 \%$
			Y	0.00	0.00	1.00	140.3	
			Z	0.00	0.00	1.00	178.9	

The reported uncertainty of measurement is stated as the standard uncertainty of measurement multiplied by the coverage factor k=2, which for a normal distribution corresponds to a coverage probability of approximately 95%.

<sup>A</sup> The uncertainties of NormX,Y,Z do not affect the E<sup>2</sup>-field uncertainty inside TSL (see Pages 5 and 6).

<sup>B</sup> Numerical linearization parameter: uncertainty not required.

<sup>E</sup> Uncertainty is determined using the max. deviation from linear response applying rectangular distribution and is expressed for the square of the field value.

## DASY/EASY - Parameters of Probe: ES3DV2 - SN:3022

### Calibration Parameter Determined in Head Tissue Simulating Media

f (MHz) <sup>C</sup>	Relative Permittivity <sup>F</sup>	Conductivity (S/m) <sup>F</sup>	ConvF X	ConvF Y	ConvF Z	Alpha	Depth (mm)	Unct. (k=2)
750	41.9	0.89	6.30	6.30	6.30	0.30	1.72	± 12.0 %
835	41.5	0.90	6.03	6.03	6.03	0.35	1.63	± 12.0 %
1750	40.1	1.37	5.07	5.07	5.07	0.32	1.89	± 12.0 %
1900	40.0	1.40	4.86	4.86	4.86	0.40	1.57	± 12.0 %
2450	39.2	1.80	4.23	4.23	4.23	0.59	1.44	± 12.0 %
2600	39.0	1.96	4.10	4.10	4.10	0.67	1.37	± 12.0 %

<sup>C</sup> Frequency validity of ± 100 MHz only applies for DASY v4.4 and higher (see Page 2), else it is restricted to ± 50 MHz. The uncertainty is the RSS of the ConvF uncertainty at calibration frequency and the uncertainty for the indicated frequency band.

<sup>F</sup> At frequencies below 3 GHz, the validity of tissue parameters ( $\epsilon$  and  $\sigma$ ) can be relaxed to ± 10% if liquid compensation formula is applied to measured SAR values. At frequencies above 3 GHz, the validity of tissue parameters ( $\epsilon$  and  $\sigma$ ) is restricted to ± 5%. The uncertainty is the RSS of the ConvF uncertainty for indicated target tissue parameters.

## DASY/EASY - Parameters of Probe: ES3DV2 - SN:3022

### Calibration Parameter Determined in Body Tissue Simulating Media

f (MHz) <sup>C</sup>	Relative Permittivity <sup>F</sup>	Conductivity (S/m) <sup>F</sup>	ConvF X	ConvF Y	ConvF Z	Alpha	Depth (mm)	Unct. (k=2)
750	55.5	0.96	6.07	6.07	6.07	0.23	2.09	± 12.0 %
835	55.2	0.97	6.02	6.02	6.02	0.47	1.44	± 12.0 %
1750	53.4	1.49	4.70	4.70	4.70	0.46	1.55	± 12.0 %
1900	53.3	1.52	4.43	4.43	4.43	0.36	1.87	± 12.0 %
2450	52.7	1.95	3.97	3.97	3.97	0.65	1.06	± 12.0 %
2600	52.5	2.16	3.80	3.80	3.80	0.54	0.75	± 12.0 %

<sup>C</sup> Frequency validity of ± 100 MHz only applies for DASY v4.4 and higher (see Page 2), else it is restricted to ± 50 MHz. The uncertainty is the RSS of the ConvF uncertainty at calibration frequency and the uncertainty for the indicated frequency band.

<sup>F</sup> At frequencies below 3 GHz, the validity of tissue parameters ( $\epsilon$  and  $\sigma$ ) can be relaxed to ± 10% if liquid compensation formula is applied to measured SAR values. At frequencies above 3 GHz, the validity of tissue parameters ( $\epsilon$  and  $\sigma$ ) is restricted to ± 5%. The uncertainty is the RSS of the ConvF uncertainty for indicated target tissue parameters.

### Frequency Response of E-Field (TEM-Cell:ifi110 EXX, Waveguide: R22)

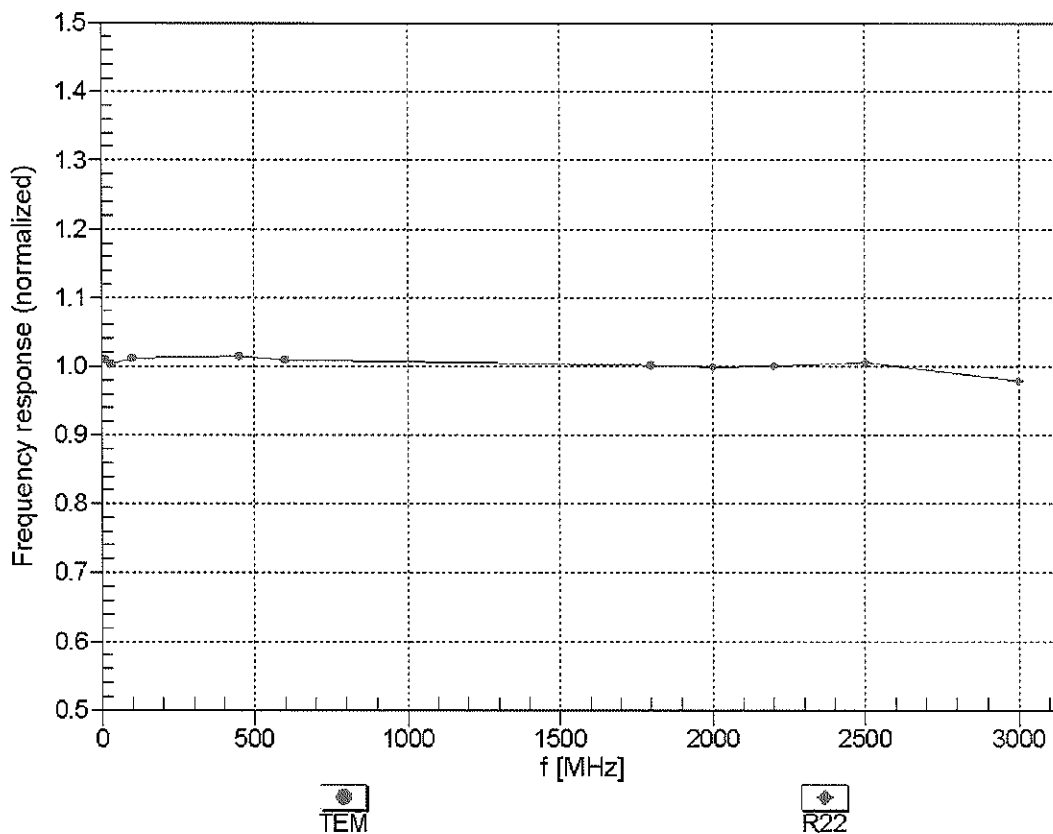

Uncertainty of Frequency Response of E-field:  $\pm 6.3\%$  (k=2)

### Receiving Pattern ( $\phi$ ), $\theta = 0^\circ$

f=600 MHz, TEM

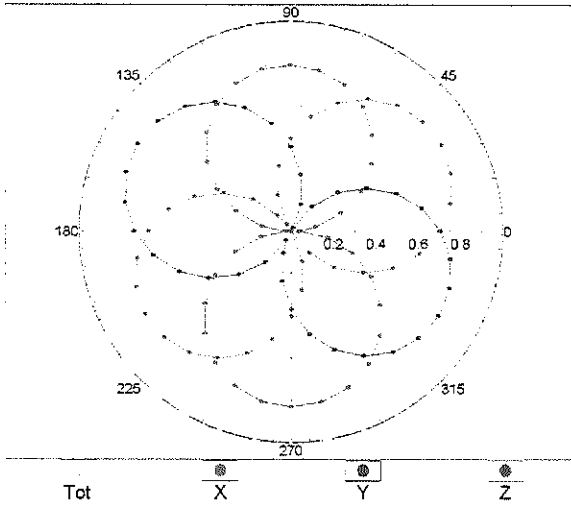

f=1800 MHz, R22

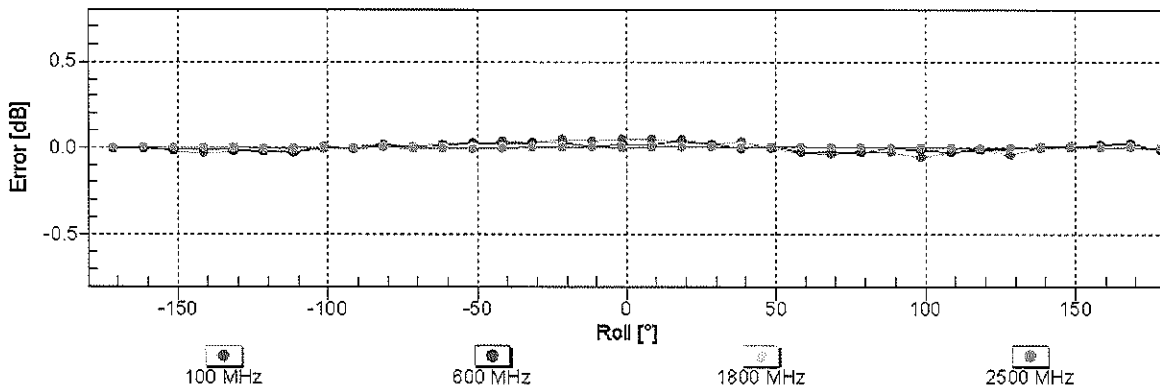
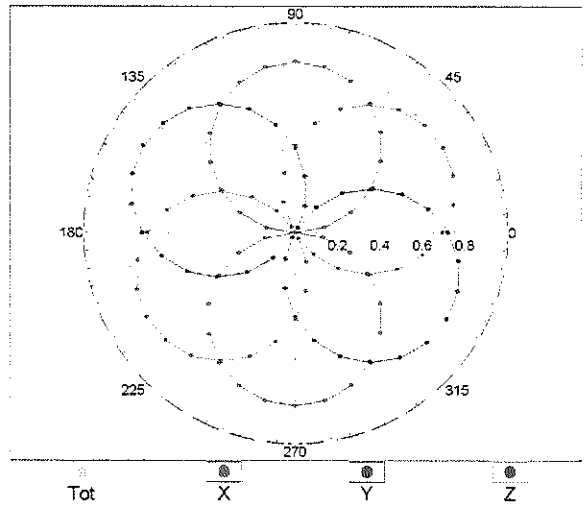

Uncertainty of Axial Isotropy Assessment:  $\pm 0.5\%$  (k=2)

### Dynamic Range $f(\text{SAR}_{\text{head}})$ (TEM cell , $f = 900 \text{ MHz}$ )

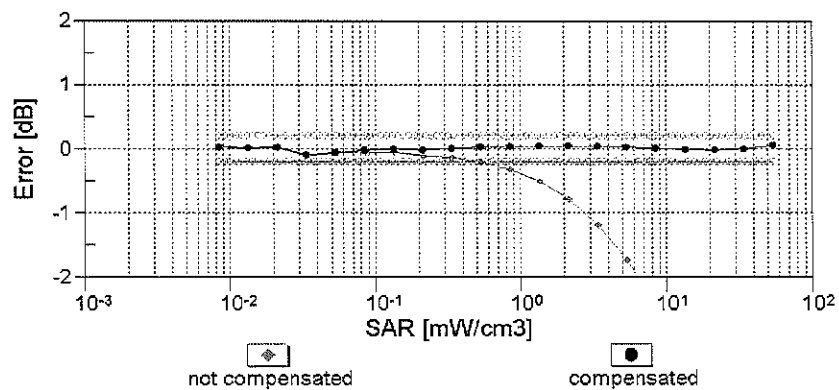
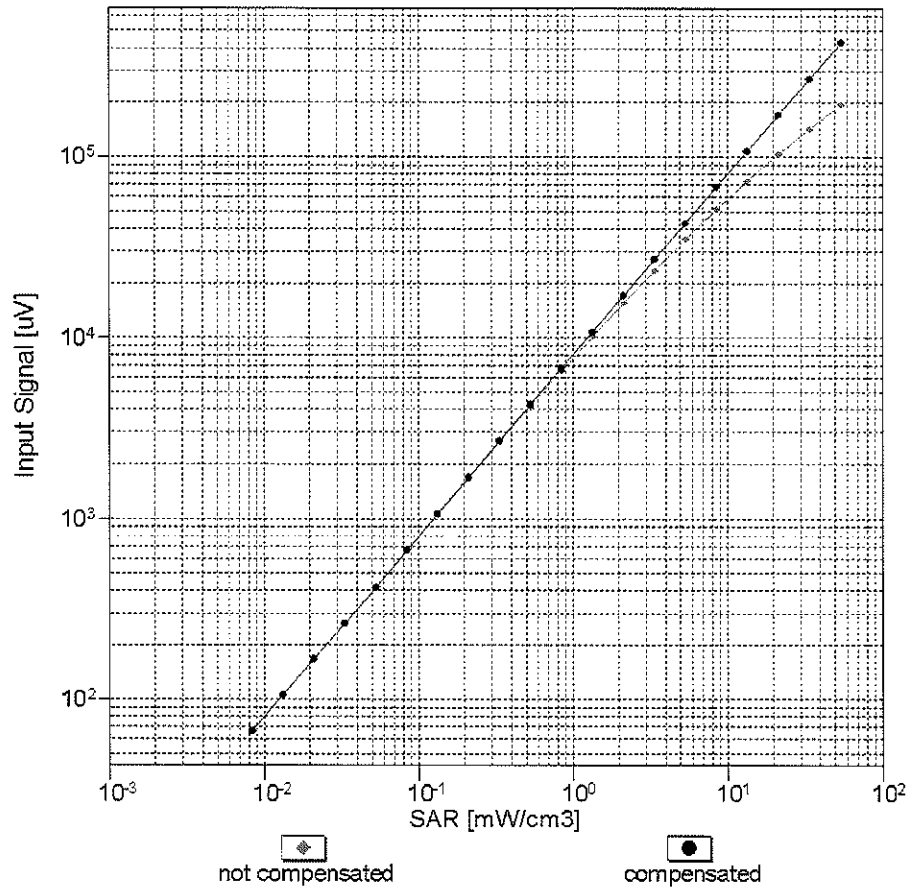

Uncertainty of Linearity Assessment:  $\pm 0.6\%$  ( $k=2$ )

# Conversion Factor Assessment

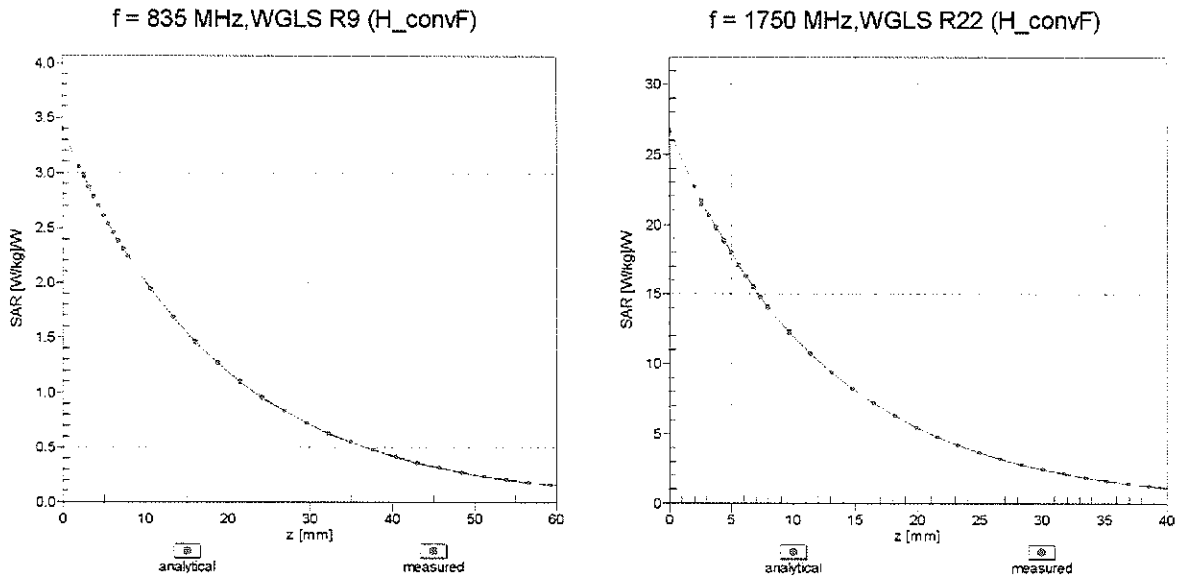

## Deviation from Isotropy in Liquid Error ( $\phi, \theta$ ), f = 900 MHz

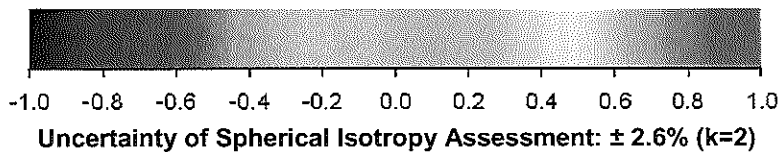
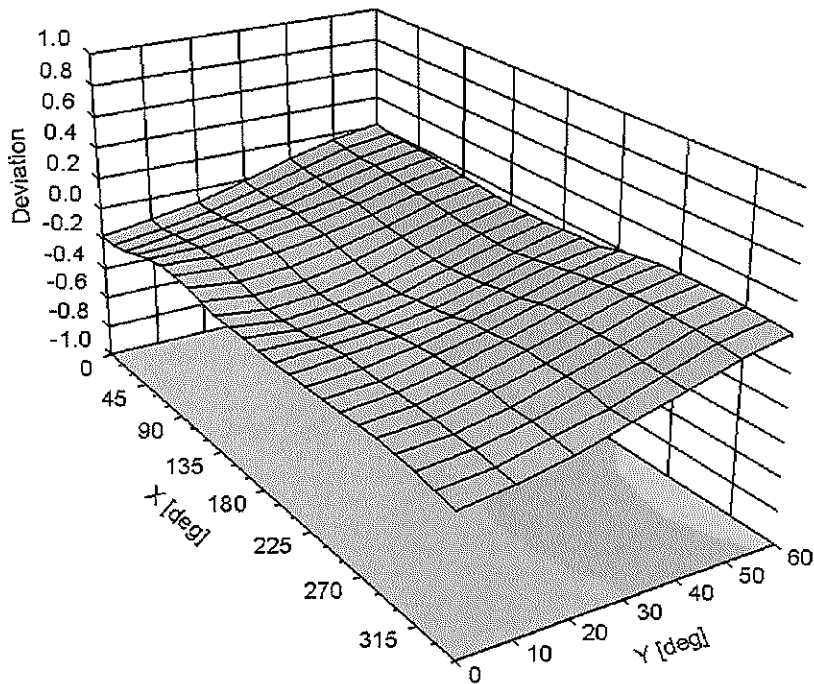

## DASY/EASY - Parameters of Probe: ES3DV2 - SN:3022

### Other Probe Parameters

Sensor Arrangement	Triangular
Connector Angle (°)	98.5
Mechanical Surface Detection Mode	enabled
Optical Surface Detection Mode	disabled
Probe Overall Length	337 mm
Probe Body Diameter	10 mm
Tip Length	10 mm
Tip Diameter	4 mm
Probe Tip to Sensor X Calibration Point	2 mm
Probe Tip to Sensor Y Calibration Point	2 mm
Probe Tip to Sensor Z Calibration Point	2 mm
Recommended Measurement Distance from Surface	3 mm

**Calibration Laboratory of  
Schmid & Partner  
Engineering AG**  
Zeughausstrasse 43, 8004 Zurich, Switzerland



**S** Schweizerischer Kalibrierdienst  
**C** Service suisse d'étalonnage  
**S** Servizio svizzero di taratura  
Swiss Calibration Service

Accredited by the Swiss Accreditation Service (SAS)  
The Swiss Accreditation Service is one of the signatories to the EA  
Multilateral Agreement for the recognition of calibration certificates

Accreditation No.: **SCS 108**

Client **PC Test**

Certificate No: **ES3-3287\_Nov12**

## CALIBRATION CERTIFICATE

Object **ES3DV3 - SN:3287**

Calibration procedure(s) **QA CAL-01.v8, QA CAL-23.v4, QA CAL-25.v4  
Calibration procedure for dosimetric E-field probes**

Calibration date: **November 15, 2012**

*✓ KOK  
11/2012*

This calibration certificate documents the traceability to national standards, which realize the physical units of measurements (SI).  
The measurements and the uncertainties with confidence probability are given on the following pages and are part of the certificate.

All calibrations have been conducted in the closed laboratory facility: environment temperature (22 ± 3)°C and humidity < 70%.

Calibration Equipment used (M&TE critical for calibration)

Primary Standards	ID	Cal Date (Certificate No.)	Scheduled Calibration
Power meter E4419B	GB41293874	29-Mar-12 (No. 217-01508)	Apr-13
Power sensor E4412A	MY41498087	29-Mar-12 (No. 217-01508)	Apr-13
Reference 3 dB Attenuator	SN: S5054 (3c)	27-Mar-12 (No. 217-01531)	Apr-13
Reference 20 dB Attenuator	SN: S5086 (20b)	27-Mar-12 (No. 217-01529)	Apr-13
Reference 30 dB Attenuator	SN: S5129 (30b)	27-Mar-12 (No. 217-01532)	Apr-13
Reference Probe ES3DV2	SN: 3013	29-Dec-11 (No. ES3-3013_Dec11)	Dec-12
DAE4	SN: 660	20-Jun-12 (No. DAE4-660_Jun12)	Jun-13
Secondary Standards	ID	Check Date (in house)	Scheduled Check
RF generator HP 8648C	US3642U01700	4-Aug-99 (in house check Apr-11)	In house check: Apr-13
Network Analyzer HP 8753E	US37390585	18-Oct-01 (in house check Oct-12)	In house check: Oct-13

Calibrated by:	Name <b>Claudio Leubler</b>	Function <b>Laboratory Technician</b>	Signature 
Approved by:	Name <b>Katja Pokovic</b>	Function <b>Technical Manager</b>	Signature 

Issued: November 16, 2012

This calibration certificate shall not be reproduced except in full without written approval of the laboratory.



Accredited by the Swiss Accreditation Service (SAS)

Accreditation No.: **SCS 108**

The Swiss Accreditation Service is one of the signatories to the EA  
Multilateral Agreement for the recognition of calibration certificates

### Glossary:

TSL	tissue simulating liquid
NORM <sub>x,y,z</sub>	sensitivity in free space
ConvF	sensitivity in TSL / NORM <sub>x,y,z</sub>
DCP	diode compression point
CF	crest factor (1/duty_cycle) of the RF signal
A, B, C	modulation dependent linearization parameters
Polarization $\varphi$	$\varphi$ rotation around probe axis
Polarization $\vartheta$	$\vartheta$ rotation around an axis that is in the plane normal to probe axis (at measurement center), i.e., $\vartheta = 0$ is normal to probe axis

### Calibration is Performed According to the Following Standards:

- IEEE Std 1528-2003, "IEEE Recommended Practice for Determining the Peak Spatial-Averaged Specific Absorption Rate (SAR) in the Human Head from Wireless Communications Devices: Measurement Techniques", December 2003
- IEC 62209-1, "Procedure to measure the Specific Absorption Rate (SAR) for hand-held devices used in close proximity to the ear (frequency range of 300 MHz to 3 GHz)", February 2005

### Methods Applied and Interpretation of Parameters:

- NORM<sub>x,y,z</sub>**: Assessed for E-field polarization  $\vartheta = 0$  ( $f \leq 900$  MHz in TEM-cell;  $f > 1800$  MHz: R22 waveguide). NORM<sub>x,y,z</sub> are only intermediate values, i.e., the uncertainties of NORM<sub>x,y,z</sub> does not affect the E<sup>2</sup>-field uncertainty inside TSL (see below ConvF).
- NORM(f)<sub>x,y,z</sub>** = NORM<sub>x,y,z</sub> \* frequency\_response (see Frequency Response Chart). This linearization is implemented in DASY4 software versions later than 4.2. The uncertainty of the frequency response is included in the stated uncertainty of ConvF.
- DCP<sub>x,y,z</sub>**: DCP are numerical linearization parameters assessed based on the data of power sweep with CW signal (no uncertainty required). DCP does not depend on frequency nor media.
- PAR**: PAR is the Peak to Average Ratio that is not calibrated but determined based on the signal characteristics
- A<sub>x,y,z</sub>; B<sub>x,y,z</sub>; C<sub>x,y,z</sub>; VR<sub>x,y,z</sub>**: A, B, C are numerical linearization parameters assessed based on the data of power sweep for specific modulation signal. The parameters do not depend on frequency nor media. VR is the maximum calibration range expressed in RMS voltage across the diode.
- ConvF and Boundary Effect Parameters**: Assessed in flat phantom using E-field (or Temperature Transfer Standard for  $f \leq 800$  MHz) and inside waveguide using analytical field distributions based on power measurements for  $f > 800$  MHz. The same setups are used for assessment of the parameters applied for boundary compensation (alpha, depth) of which typical uncertainty values are given. These parameters are used in DASY4 software to improve probe accuracy close to the boundary. The sensitivity in TSL corresponds to NORM<sub>x,y,z</sub> \* ConvF whereby the uncertainty corresponds to that given for ConvF. A frequency dependent ConvF is used in DASY version 4.4 and higher which allows extending the validity from  $\pm 50$  MHz to  $\pm 100$  MHz.
- Spherical isotropy (3D deviation from isotropy)**: in a field of low gradients realized using a flat phantom exposed by a patch antenna.
- Sensor Offset**: The sensor offset corresponds to the offset of virtual measurement center from the probe tip (on probe axis). No tolerance required.

# Probe ES3DV3

## SN:3287

Manufactured: June 7, 2010  
Calibrated: November 15, 2012

Calibrated for DASY/EASY Systems  
(Note: non-compatible with DASY2 system!)

## DASY/EASY - Parameters of Probe: ES3DV3 - SN:3287

### Basic Calibration Parameters

	Sensor X	Sensor Y	Sensor Z	Unc (k=2)
Norm ( $\mu\text{V}/(\text{V}/\text{m})^2$ ) <sup>A</sup>	1.31	1.25	1.25	± 10.1 %
DCP (mV) <sup>B</sup>	102.9	103.6	101.6	

### Modulation Calibration Parameters

UID	Communication System Name	PAR		A dB	B dB	C dB	VR mV	Unc <sup>E</sup> (k=2)
0	CW	0.00	X	0.0	0.0	1.0	116.8	±3.5 %
			Y	0.0	0.0	1.0	118.5	
			Z	0.0	0.0	1.0	154.1	

The reported uncertainty of measurement is stated as the standard uncertainty of measurement multiplied by the coverage factor  $k=2$ , which for a normal distribution corresponds to a coverage probability of approximately 95%.

<sup>A</sup> The uncertainties of NormX,Y,Z do not affect the  $E^2$ -field uncertainty inside TSL (see Pages 5 and 6).

<sup>B</sup> Numerical linearization parameter: uncertainty not required.

<sup>E</sup> Uncertainty is determined using the max. deviation from linear response applying rectangular distribution and is expressed for the square of the field value.

## DASY/EASY - Parameters of Probe: ES3DV3 - SN:3287

### Calibration Parameter Determined in Head Tissue Simulating Media

f (MHz) <sup>C</sup>	Relative Permittivity <sup>F</sup>	Conductivity (S/m) <sup>F</sup>	ConvF X	ConvF Y	ConvF Z	Alpha	Depth (mm)	Unct. (k=2)
750	41.9	0.89	6.40	6.40	6.40	0.20	2.54	± 12.0 %
835	41.5	0.90	6.17	6.17	6.17	0.34	1.68	± 12.0 %
1750	40.1	1.37	5.16	5.16	5.16	0.63	1.30	± 12.0 %
1900	40.0	1.40	4.96	4.96	4.96	0.48	1.55	± 12.0 %
2450	39.2	1.80	4.30	4.30	4.30	0.79	1.31	± 12.0 %
2600	39.0	1.96	4.19	4.19	4.19	0.80	1.31	± 12.0 %

<sup>C</sup> Frequency validity of ± 100 MHz only applies for DASY v4.4 and higher (see Page 2), else it is restricted to ± 50 MHz. The uncertainty is the RSS of the ConvF uncertainty at calibration frequency and the uncertainty for the indicated frequency band.

<sup>F</sup> At frequencies below 3 GHz, the validity of tissue parameters ( $\epsilon$  and  $\sigma$ ) can be relaxed to ± 10% if liquid compensation formula is applied to measured SAR values. At frequencies above 3 GHz, the validity of tissue parameters ( $\epsilon$  and  $\sigma$ ) is restricted to ± 5%. The uncertainty is the RSS of the ConvF uncertainty for indicated target tissue parameters.

## DASY/EASY - Parameters of Probe: ES3DV3 - SN:3287

### Calibration Parameter Determined in Body Tissue Simulating Media

f (MHz) <sup>C</sup>	Relative Permittivity <sup>F</sup>	Conductivity (S/m) <sup>F</sup>	ConvF X	ConvF Y	ConvF Z	Alpha	Depth (mm)	Unct. (k=2)
750	55.5	0.96	6.14	6.14	6.14	0.28	2.06	± 12.0 %
835	55.2	0.97	6.06	6.06	6.06	0.42	1.63	± 12.0 %
1750	53.4	1.49	4.86	4.86	4.86	0.43	1.64	± 12.0 %
1900	53.3	1.52	4.69	4.69	4.69	0.56	1.54	± 12.0 %
2450	52.7	1.95	4.29	4.29	4.29	0.80	1.02	± 12.0 %
2600	52.5	2.16	4.12	4.12	4.12	0.64	0.92	± 12.0 %

<sup>C</sup> Frequency validity of ± 100 MHz only applies for DASY v4.4 and higher (see Page 2), else it is restricted to ± 50 MHz. The uncertainty is the RSS of the ConvF uncertainty at calibration frequency and the uncertainty for the indicated frequency band.

<sup>F</sup> At frequencies below 3 GHz, the validity of tissue parameters ( $\epsilon$  and  $\sigma$ ) can be relaxed to ± 10% if liquid compensation formula is applied to measured SAR values. At frequencies above 3 GHz, the validity of tissue parameters ( $\epsilon$  and  $\sigma$ ) is restricted to ± 5%. The uncertainty is the RSS of the ConvF uncertainty for indicated target tissue parameters.

### Frequency Response of E-Field (TEM-Cell:ifi110 EXX, Waveguide: R22)

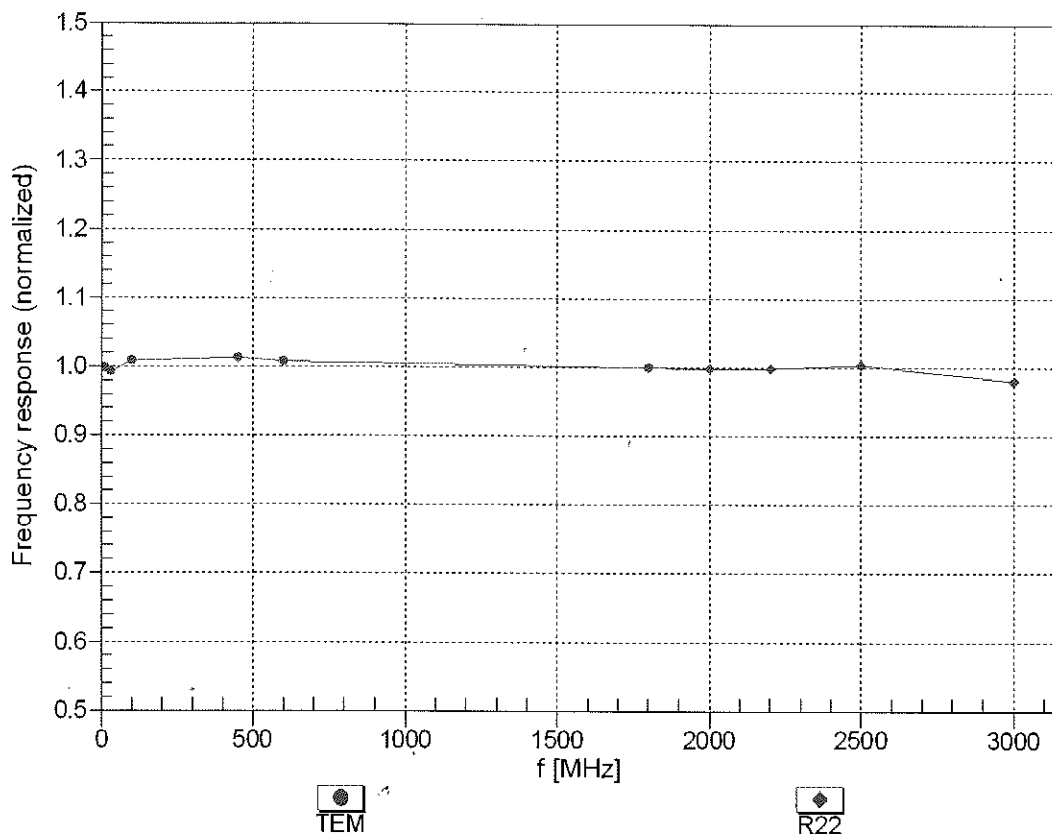

Uncertainty of Frequency Response of E-field:  $\pm 6.3\%$  (k=2)

### Receiving Pattern ( $\phi$ ), $\theta = 0^\circ$

f=600 MHz,TEM

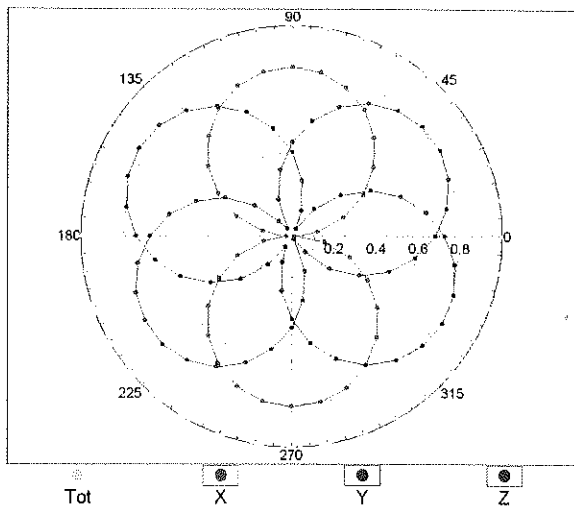

f=1800 MHz,R22

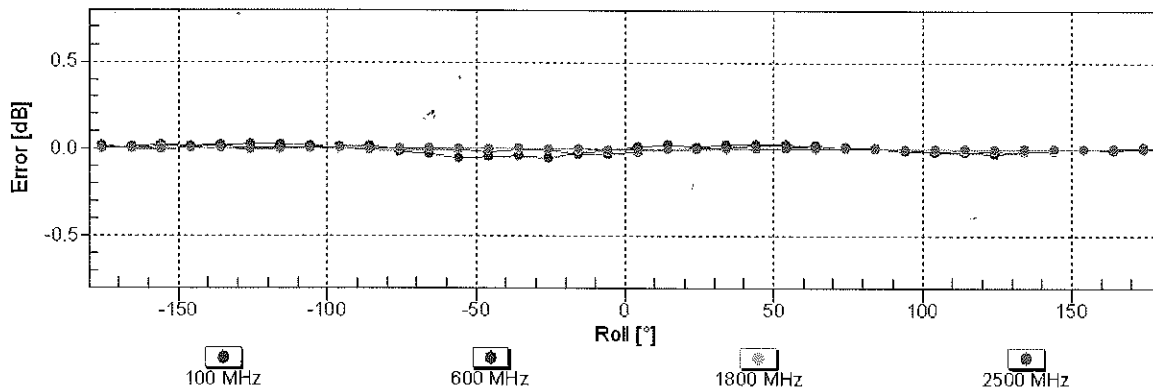
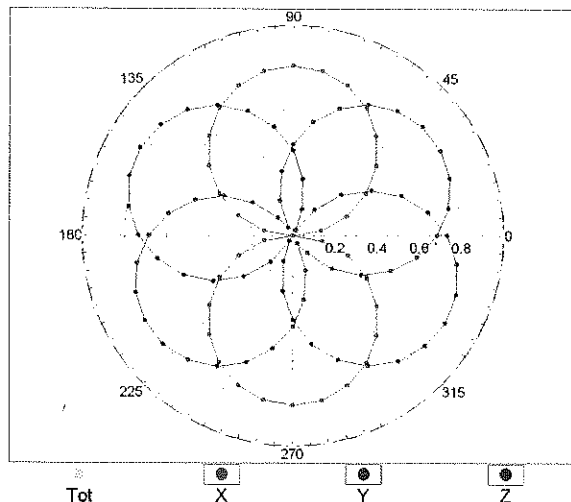

Uncertainty of Axial Isotropy Assessment:  $\pm 0.5\%$  (k=2)

## Dynamic Range f(SAR<sub>head</sub>) (TEM cell , f = 900 MHz)

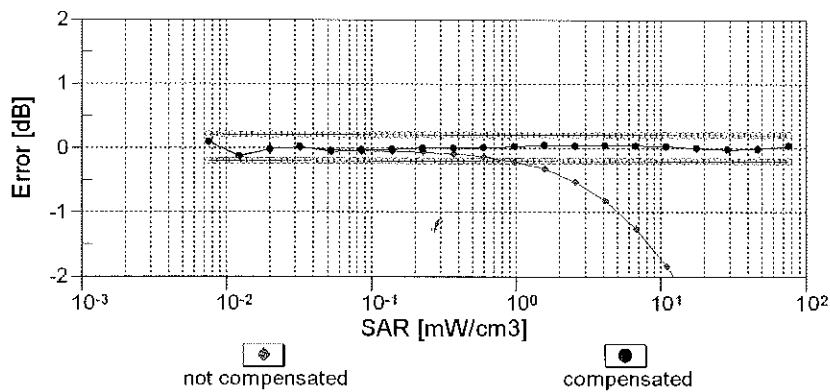
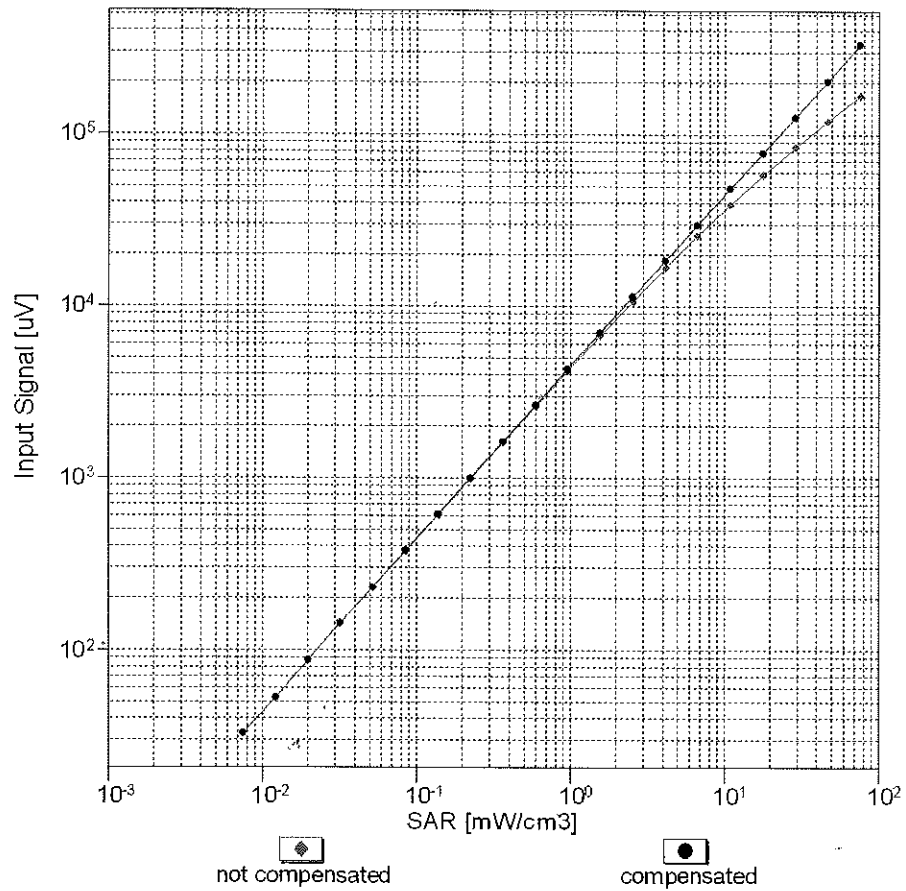

**Uncertainty of Linearity Assessment: ± 0.6% (k=2)**

# Conversion Factor Assessment

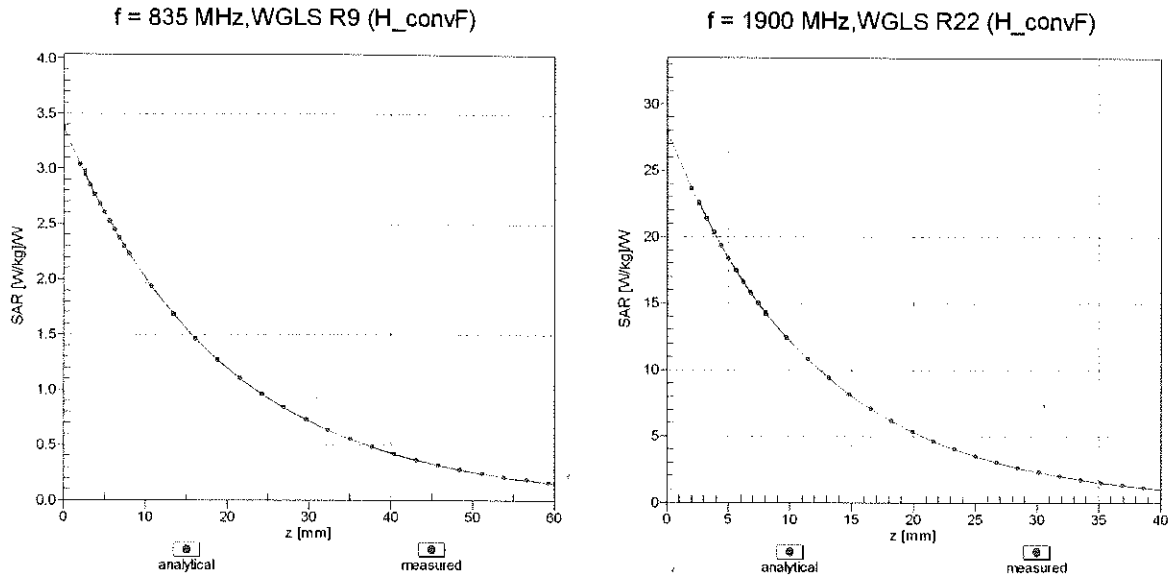

## Deviation from Isotropy in Liquid Error ( $\phi, \theta$ ), f = 900 MHz

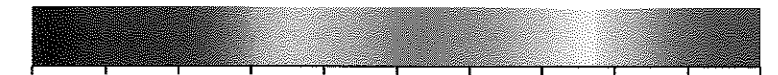
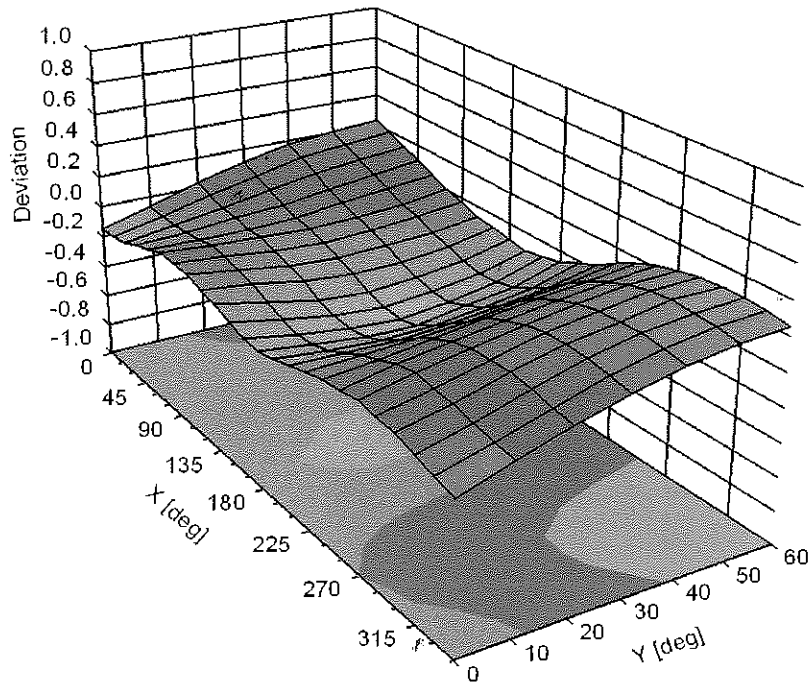

Uncertainty of Spherical Isotropy Assessment:  $\pm 2.6\%$  (k=2)

## DASY/EASY - Parameters of Probe: ES3DV3 - SN:3287

### Other Probe Parameters

Sensor Arrangement	Triangular
Connector Angle (°)	-15.9
Mechanical Surface Detection Mode	enabled
Optical Surface Detection Mode	disabled
Probe Overall Length	337 mm
Probe Body Diameter	10 mm
Tip Length	10 mm
Tip Diameter	4 mm
Probe Tip to Sensor X Calibration Point	2 mm
Probe Tip to Sensor Y Calibration Point	2 mm
Probe Tip to Sensor Z Calibration Point	2 mm
Recommended Measurement Distance from Surface	3 mm



Accredited by the Swiss Accreditation Service (SAS)  
The Swiss Accreditation Service is one of the signatories to the EA  
Multilateral Agreement for the recognition of calibration certificates

Accreditation No.: **SCS 108**

Client **PC Test**

Certificate No: **EX3-3589\_Jan13**

## CALIBRATION CERTIFICATE

Object **EX3DV4 - SN:3589**

Calibration procedure(s) **QA CAL-01 v3, QA CAL-14 v3, QA CAL-23 v4, QA CAL-25 v4  
Calibration procedure for dosimetric E-field probes**

Calibration date: **January 17, 2013**

✓  
Kok  
1/28/13

This calibration certificate documents the traceability to national standards, which realize the physical units of measurements (SI).  
The measurements and the uncertainties with confidence probability are given on the following pages and are part of the certificate.

All calibrations have been conducted in the closed laboratory facility: environment temperature (22 ± 3)°C and humidity < 70%.

Calibration Equipment used (M&TE critical for calibration)

Primary Standards	ID	Cal Date (Certificate No.)	Scheduled Calibration
Power meter E4419B	GB41293874	29-Mar-12 (No. 217-01508)	Apr-13
Power sensor E4412A	MY41498087	29-Mar-12 (No. 217-01508)	Apr-13
Reference 3 dB Attenuator	SN: S5054 (3c)	27-Mar-12 (No. 217-01531)	Apr-13
Reference 20 dB Attenuator	SN: S5086 (20b)	27-Mar-12 (No. 217-01529)	Apr-13
Reference 30 dB Attenuator	SN: S5129 (30b)	27-Mar-12 (No. 217-01532)	Apr-13
Reference Probe ES3DV2	SN: 3013	28-Dec-12 (No. ES3-3013_Dec12)	Dec-13
DAE4	SN: 660	20-Jun-12 (No. DAE4-660_Jun12)	Jun-13
Secondary Standards	ID	Check Date (in house)	Scheduled Check
RF generator HP 8648C	US3642U01700	4-Aug-99 (in house check Apr-11)	In house check: Apr-13
Network Analyzer HP 8753E	US37390585	18-Oct-01 (in house check Oct-12)	In house check: Oct-13

	Name	Function	Signature
Calibrated by:	Jeton Kastrati	Laboratory Technician	
Approved by:	Katja Pokovic	Technical Manager	

Issued: January 17, 2013

This calibration certificate shall not be reproduced except in full without written approval of the laboratory.



Accredited by the Swiss Accreditation Service (SAS)

Accreditation No.: **SCS 108**

The Swiss Accreditation Service is one of the signatories to the EA  
Multilateral Agreement for the recognition of calibration certificates

### Glossary:

TSL	tissue simulating liquid
NORM <sub>x,y,z</sub>	sensitivity in free space
ConvF	sensitivity in TSL / NORM <sub>x,y,z</sub>
DCP	diode compression point
CF	crest factor (1/duty_cycle) of the RF signal
A, B, C, D	modulation dependent linearization parameters
Polarization $\varphi$	$\varphi$ rotation around probe axis
Polarization $\vartheta$	$\vartheta$ rotation around an axis that is in the plane normal to probe axis (at measurement center), i.e., $\vartheta = 0$ is normal to probe axis

### Calibration is Performed According to the Following Standards:

- IEEE Std 1528-2003, "IEEE Recommended Practice for Determining the Peak Spatial-Averaged Specific Absorption Rate (SAR) in the Human Head from Wireless Communications Devices: Measurement Techniques", December 2003
- IEC 62209-1, "Procedure to measure the Specific Absorption Rate (SAR) for hand-held devices used in close proximity to the ear (frequency range of 300 MHz to 3 GHz)", February 2005

### Methods Applied and Interpretation of Parameters:

- NORM<sub>x,y,z</sub>**: Assessed for E-field polarization  $\vartheta = 0$  ( $f \leq 900$  MHz in TEM-cell;  $f > 1800$  MHz: R22 waveguide). NORM<sub>x,y,z</sub> are only intermediate values, i.e., the uncertainties of NORM<sub>x,y,z</sub> does not affect the E<sup>2</sup>-field uncertainty inside TSL (see below ConvF).
- NORM(f)<sub>x,y,z</sub>** = NORM<sub>x,y,z</sub> \* frequency\_response (see Frequency Response Chart). This linearization is implemented in DASY4 software versions later than 4.2. The uncertainty of the frequency response is included in the stated uncertainty of ConvF.
- DCP<sub>x,y,z</sub>**: DCP are numerical linearization parameters assessed based on the data of power sweep with CW signal (no uncertainty required). DCP does not depend on frequency nor media.
- PAR**: PAR is the Peak to Average Ratio that is not calibrated but determined based on the signal characteristics
- A<sub>x,y,z</sub>; B<sub>x,y,z</sub>; C<sub>x,y,z</sub>; D<sub>x,y,z</sub>; VR<sub>x,y,z</sub>; A, B, C, D** are numerical linearization parameters assessed based on the data of power sweep for specific modulation signal. The parameters do not depend on frequency nor media. VR is the maximum calibration range expressed in RMS voltage across the diode.
- ConvF and Boundary Effect Parameters**: Assessed in flat phantom using E-field (or Temperature Transfer Standard for  $f \leq 800$  MHz) and inside waveguide using analytical field distributions based on power measurements for  $f > 800$  MHz. The same setups are used for assessment of the parameters applied for boundary compensation (alpha, depth) of which typical uncertainty values are given. These parameters are used in DASY4 software to improve probe accuracy close to the boundary. The sensitivity in TSL corresponds to NORM<sub>x,y,z</sub> \* ConvF whereby the uncertainty corresponds to that given for ConvF. A frequency dependent ConvF is used in DASY version 4.4 and higher which allows extending the validity from  $\pm 50$  MHz to  $\pm 100$  MHz.
- Spherical isotropy (3D deviation from isotropy)**: in a field of low gradients realized using a flat phantom exposed by a patch antenna.
- Sensor Offset**: The sensor offset corresponds to the offset of virtual measurement center from the probe tip (on probe axis). No tolerance required.

# Probe EX3DV4

## SN:3589

Manufactured: March 30, 2006  
Calibrated: January 17, 2013

Calibrated for DASY/EASY Systems  
(Note: non-compatible with DASY2 system!)

## DASY/EASY - Parameters of Probe: EX3DV4 - SN:3589

### Basic Calibration Parameters

	Sensor X	Sensor Y	Sensor Z	Unc (k=2)
Norm ( $\mu\text{V}/(\text{V}/\text{m})^2$ ) <sup>A</sup>	0.46	0.40	0.40	$\pm 10.1 \%$
DCP (mV) <sup>B</sup>	100.5	103.8	99.6	

### Modulation Calibration Parameters

UID	Communication System Name		A dB	B dB $\sqrt{\mu\text{V}}$	C	D dB	VR mV	Unc <sup>E</sup> (k=2)
0	CW	X	0.0	0.0	1.0	0.00	165.8	$\pm 3.3 \%$
		Y	0.0	0.0	1.0		134.3	
		Z	0.0	0.0	1.0		140.5	

The reported uncertainty of measurement is stated as the standard uncertainty of measurement multiplied by the coverage factor k=2, which for a normal distribution corresponds to a coverage probability of approximately 95%.

<sup>A</sup> The uncertainties of NormX,Y,Z do not affect the E<sup>2</sup>-field uncertainty inside TSL (see Pages 5 and 6).

<sup>B</sup> Numerical linearization parameter: uncertainty not required.

<sup>E</sup> Uncertainty is determined using the max. deviation from linear response applying rectangular distribution and is expressed for the square of the field value.

## DASY/EASY - Parameters of Probe: EX3DV4 - SN:3589

### Calibration Parameter Determined in Head Tissue Simulating Media

f (MHz) <sup>C</sup>	Relative Permittivity <sup>F</sup>	Conductivity (S/m) <sup>F</sup>	ConvF X	ConvF Y	ConvF Z	Alpha	Depth (mm)	Unct. (k=2)
750	41.9	0.89	8.70	8.70	8.70	0.39	0.96	± 12.0 %
835	41.5	0.90	8.40	8.40	8.40	0.52	0.74	± 12.0 %
1750	40.1	1.37	7.34	7.34	7.34	0.45	0.93	± 12.0 %
1900	40.0	1.40	7.09	7.09	7.09	0.80	0.65	± 12.0 %
2450	39.2	1.80	6.37	6.37	6.37	0.39	0.97	± 12.0 %
2600	39.0	1.96	6.19	6.19	6.19	0.30	1.12	± 12.0 %
5200	36.0	4.66	4.48	4.48	4.48	0.45	1.80	± 13.1 %
5300	35.9	4.76	4.27	4.27	4.27	0.45	1.80	± 13.1 %
5500	35.6	4.96	4.14	4.14	4.14	0.50	1.80	± 13.1 %
5600	35.5	5.07	3.81	3.81	3.81	0.55	1.80	± 13.1 %
5800	35.3	5.27	3.85	3.85	3.85	0.55	1.80	± 13.1 %

<sup>C</sup> Frequency validity of ± 100 MHz only applies for DASY v4.4 and higher (see Page 2), else it is restricted to ± 50 MHz. The uncertainty is the RSS of the ConvF uncertainty at calibration frequency and the uncertainty for the indicated frequency band.

<sup>F</sup> At frequencies below 3 GHz, the validity of tissue parameters ( $\epsilon$  and  $\sigma$ ) can be relaxed to ± 10% if liquid compensation formula is applied to measured SAR values. At frequencies above 3 GHz, the validity of tissue parameters ( $\epsilon$  and  $\sigma$ ) is restricted to ± 5%. The uncertainty is the RSS of the ConvF uncertainty for indicated target tissue parameters.

## DASY/EASY - Parameters of Probe: EX3DV4 - SN:3589

### Calibration Parameter Determined in Body Tissue Simulating Media

f (MHz) <sup>C</sup>	Relative Permittivity <sup>F</sup>	Conductivity (S/m) <sup>F</sup>	ConvF X	ConvF Y	ConvF Z	Alpha	Depth (mm)	Unct. (k=2)
750	55.5	0.96	8.59	8.59	8.59	0.49	0.86	± 12.0 %
835	55.2	0.97	8.43	8.43	8.43	0.38	1.05	± 12.0 %
1750	53.4	1.49	7.87	7.87	7.87	0.44	0.89	± 12.0 %
1900	53.3	1.52	7.46	7.46	7.46	0.58	0.75	± 12.0 %
2450	52.7	1.95	7.07	7.07	7.07	0.80	0.50	± 12.0 %
2600	52.5	2.16	6.68	6.68	6.68	0.80	0.50	± 12.0 %
5200	49.0	5.30	3.99	3.99	3.99	0.50	1.90	± 13.1 %
5300	48.9	5.42	3.81	3.81	3.81	0.50	1.90	± 13.1 %
5500	48.6	5.65	3.52	3.52	3.52	0.55	1.90	± 13.1 %
5600	48.5	5.77	3.32	3.32	3.32	0.60	1.90	± 13.1 %
5800	48.2	6.00	3.66	3.66	3.66	0.60	1.90	± 13.1 %

<sup>C</sup> Frequency validity of ± 100 MHz only applies for DASY v4.4 and higher (see Page 2), else it is restricted to ± 50 MHz. The uncertainty is the RSS of the ConvF uncertainty at calibration frequency and the uncertainty for the indicated frequency band.

<sup>F</sup> At frequencies below 3 GHz, the validity of tissue parameters ( $\epsilon$  and  $\sigma$ ) can be relaxed to ± 10% if liquid compensation formula is applied to measured SAR values. At frequencies above 3 GHz, the validity of tissue parameters ( $\epsilon$  and  $\sigma$ ) is restricted to ± 5%. The uncertainty is the RSS of the ConvF uncertainty for indicated target tissue parameters.

### Frequency Response of E-Field (TEM-Cell:ifi110 EXX, Waveguide: R22)

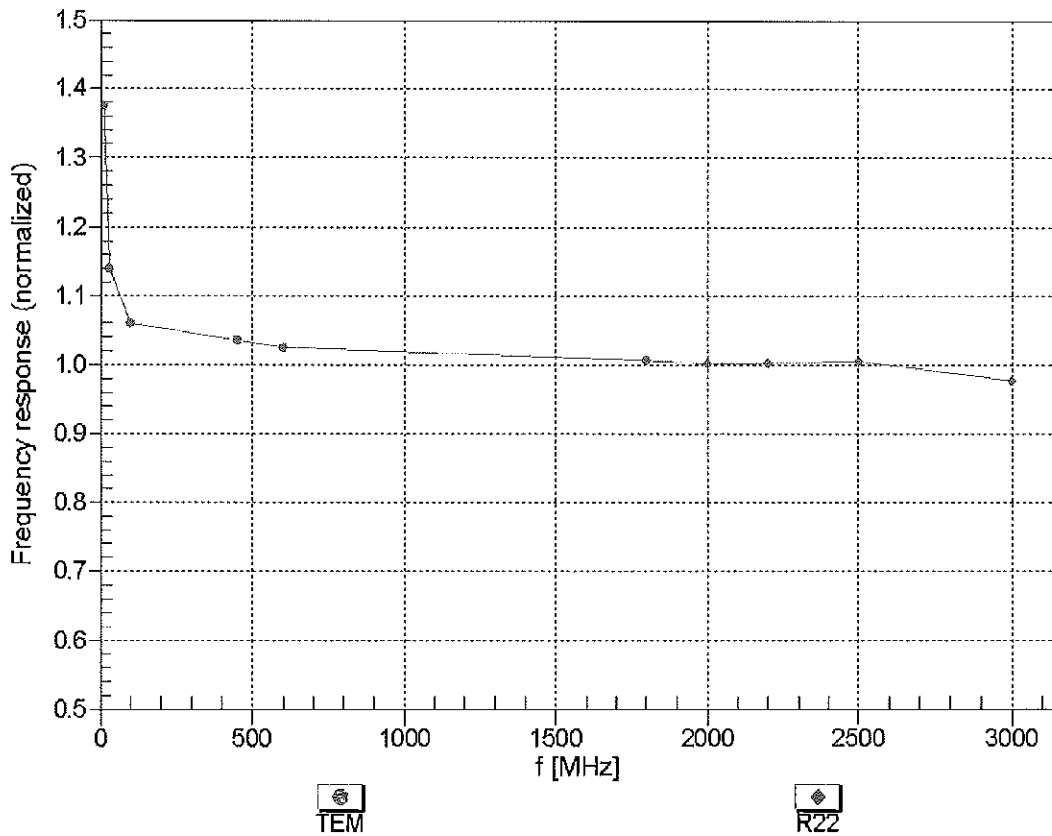

Uncertainty of Frequency Response of E-field:  $\pm 6.3\%$  (k=2)

### Receiving Pattern ( $\phi$ ), $\vartheta = 0^\circ$

f=600 MHz, TEM

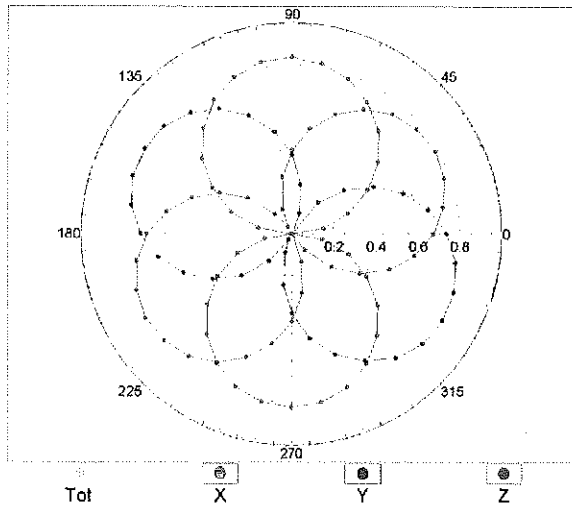

f=1800 MHz, R22

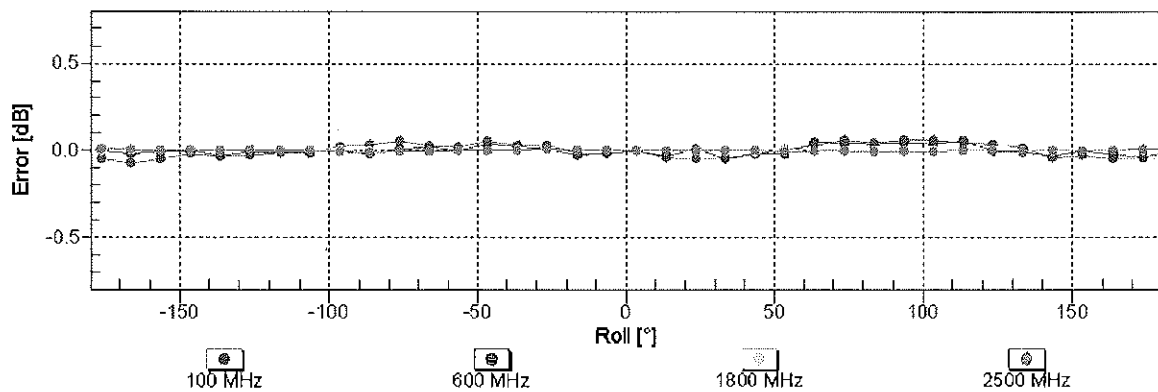
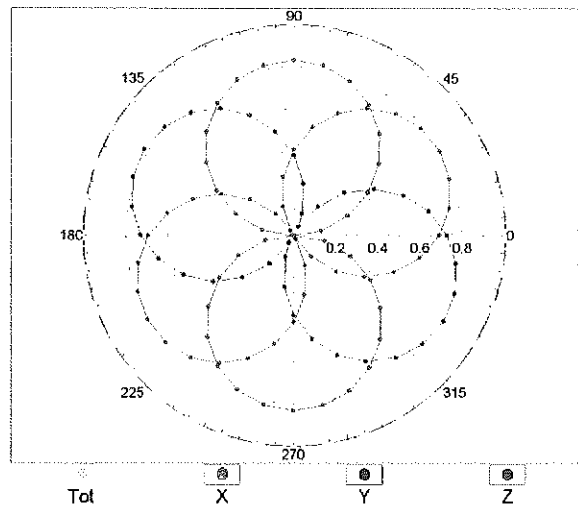

Uncertainty of Axial Isotropy Assessment:  $\pm 0.5\%$  (k=2)

### Dynamic Range $f(\text{SAR}_{\text{head}})$ (TEM cell , $f = 900 \text{ MHz}$ )

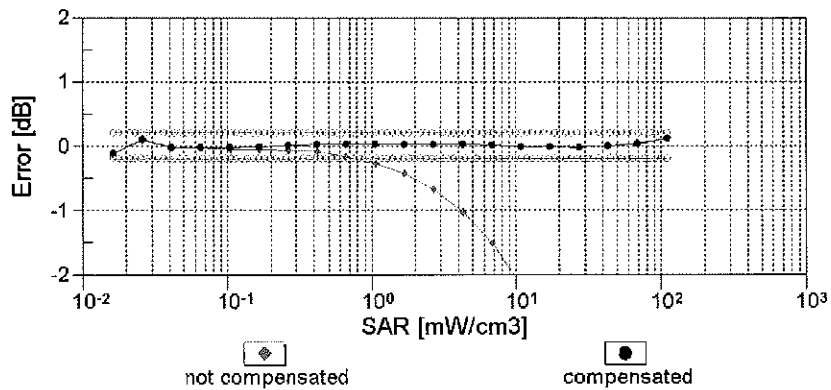
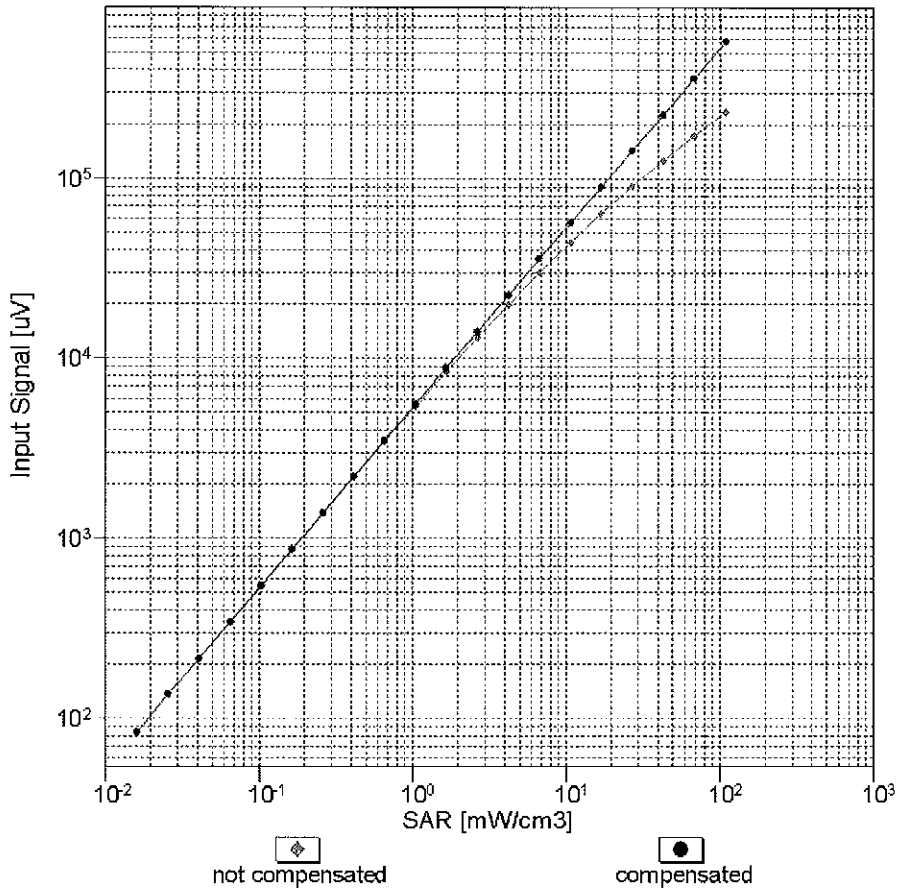

**Uncertainty of Linearity Assessment:  $\pm 0.6\%$  ( $k=2$ )**

# Conversion Factor Assessment

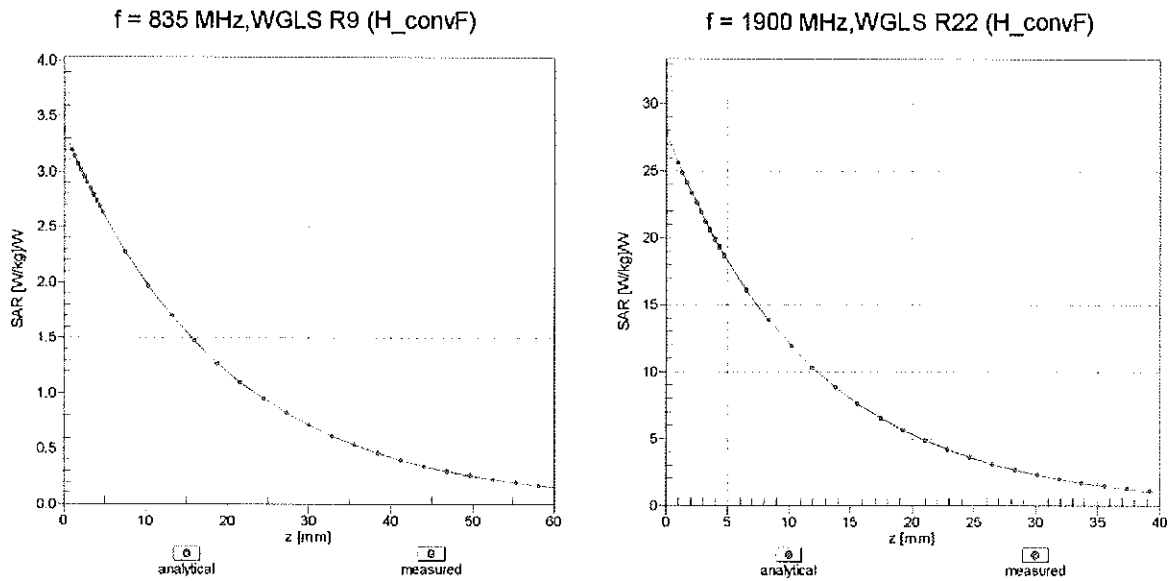

## Deviation from Isotropy in Liquid Error ( $\phi, \vartheta$ ), $f = 900$ MHz

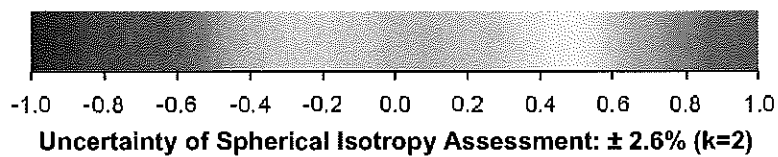
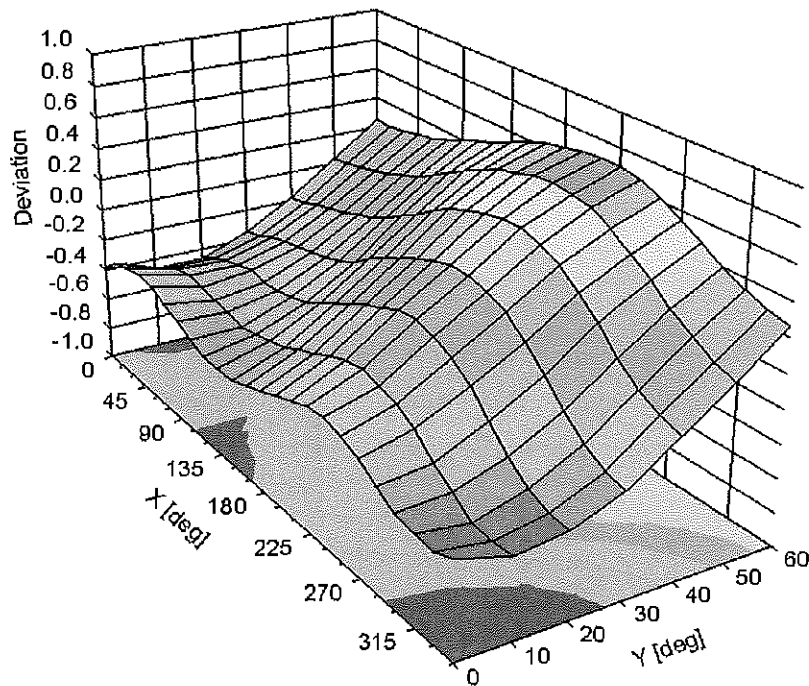

**DASY/EASY - Parameters of Probe: EX3DV4 - SN:3589****Other Probe Parameters**

Sensor Arrangement	Triangular
Connector Angle (°)	-26.4
Mechanical Surface Detection Mode	enabled
Optical Surface Detection Mode	disabled
Probe Overall Length	337 mm
Probe Body Diameter	10 mm
Tip Length	9 mm
Tip Diameter	2.5 mm
Probe Tip to Sensor X Calibration Point	1 mm
Probe Tip to Sensor Y Calibration Point	1 mm
Probe Tip to Sensor Z Calibration Point	1 mm
Recommended Measurement Distance from Surface	2 mm

## APPENDIX D: SAR TISSUE SPECIFICATIONS

Measurement Procedure for Tissue verification:



- 1) The network analyzer and probe system was configured and calibrated.
- 2) The probe was immersed in the tissue. The tissue was placed in a nonmetallic container. Trapped air bubbles beneath the flange were minimized by placing the probe at a slight angle.
- 3) The complex admittance with respect to the probe aperture was measured
- 4) The complex relative permittivity  $\epsilon$  can be calculated from the below equation (Pournaropoulos and Misra):

$$Y = \frac{j2\omega\epsilon_r\epsilon_0}{[\ln(b/a)]^2} \int_a^b \int_a^b \int_0^\pi \cos\phi' \frac{\exp[-j\omega r(\mu_0\epsilon_r'\epsilon_0)^{1/2}]}{r} d\phi' d\rho' d\rho$$

where  $Y$  is the admittance of the probe in contact with the sample, the primed and unprimed coordinates refer to source and observation points, respectively,  $r^2 = \rho^2 + \rho'^2 - 2\rho\rho' \cos\phi'$ ,  $\omega$  is the angular frequency, and  $j = \sqrt{-1}$ .

**Table D-I  
Composition of the Tissue Equivalent Matter**

Frequency (MHz)	2450	5200-5800
Tissue	Body	Body
Ingredients (% by weight)		
DGBE	26.7	
NaCl	0.1	
Polysorbate (Tween) 80		20
Water	73.2	80

<b>FCC ID:</b> A3LSMT310	 <b>PCTEST</b> <small>ENGINEERING LABORATORY, INC.</small>	<b>SAR EVALUATION REPORT</b>		<b>Reviewed by:</b> Quality Manager
<b>Test Dates:</b> 04/01/13 - 04/03/13	<b>DUT Type:</b> Portable Tablet Computer			APPENDIX D: Page 1 of 1

## APPENDIX E: SAR SYSTEM VALIDATION



Per FCC KDB 865664 D02v01, SAR system validation status should be documented to confirm measurement accuracy. The SAR systems (including SAR probes, system components and software versions) used for this device were validated against its performance specifications prior to the SAR measurements. Reference dipoles were used with the required tissue- equivalent media for system validation, according to the procedures outlined in IEEE 1528-2003 and FCC KDB 865664 D01 v01. Since SAR probe calibrations are frequency dependent, each probe calibration point was validated at a frequency within the valid frequency range of the probe calibration point, using the system that normally operates with the probe for routine SAR measurements and according to the required tissue-equivalent media.

A tabulated summary of the system validation status including the validation date(s), measurement frequencies, SAR probes and tissue dielectric parameters has been included.

**Table E-I**  
**SAR System Validation Summary**

SAR SYSTEM #	FREQ. [MHz]	DATE	PROBE SN	PROBE TYPE	PROBE CAL. POINT		COND.	PERM.	CW VALIDATION			MOD. VALIDATION		
							( $\sigma$ )	( $\epsilon$ )	SENSI-TIVITY	PROBE LINEARITY	PROBE ISOTROPY	MOD. TYPE	DUTY FACTOR	PAR
B	2450	1/30/2013	3287	ES3DV3	2450	Body	1.985	51.49	PASS	PASS	PASS	OFDM	N/A	PASS
C	2450	11/8/2012	3022	ES3DV2	2450	Body	2.038	51.10	PASS	PASS	PASS	OFDM	N/A	PASS
A	5200	1/23/2013	3589	EX3DV4	5200	Body	5.292	47.85	PASS	PASS	PASS	OFDM	N/A	PASS
A	5300	1/23/2013	3589	EX3DV4	5300	Body	5.477	47.47	PASS	PASS	PASS	OFDM	N/A	PASS
A	5500	1/23/2013	3589	EX3DV4	5500	Body	5.729	47.03	PASS	PASS	PASS	OFDM	N/A	PASS
A	5600	1/23/2013	3589	EX3DV4	5600	Body	6.233	46.20	PASS	PASS	PASS	OFDM	N/A	PASS
A	5800	1/23/2013	3589	EX3DV4	5800	Body	6.233	46.20	PASS	PASS	PASS	OFDM	N/A	PASS

NOTE: All measurements were performed using probes calibrated for CW signals only. Modulations in the table above represent test configurations for which the measurement system has been validated per FCC KDB Publication 865664 D01v01.

FCC ID: A3LSMT310		<b>SAR EVALUATION REPORT</b>		Reviewed by: Quality Manager
Test Dates: 04/01/13 - 04/03/13	DUT Type: Portable Tablet Computer			APPENDIX E: Page 1 of 1