



**FCC CFR47 PART 22 SUBPART H  
FCC CFR47 PART 24 SUBPART E  
FCC CFR47 PART 27 SUBPART H  
FCC CFR47 PART 27 SUBPART L**

**WWAN**

**CERTIFICATION TEST REPORT**

**FOR**

**GSM/WCDMA/LTE Phone + BT/BLE, DTS b/g/n and ANT+**

**MODEL NUMBER : SM-G611MT/DS**

**FCC ID: A3LSMG611MT**

**REPORT NUMBER: 4788312331-E5V3**

**ISSUE DATE: FEB 20, 2018**

*Prepared for*

**SAMSUNG ELECTRONICS CO., LTD.  
129 SAMSUNG-RO, YEONGTONG-GU, SUWON-SI,  
GYEONGGI-DO, 16677, KOREA**

*Prepared by*

**UL Korea, Ltd.**

**26th floor, 152, Teheran-ro, Gangnam-gu Seoul, 06236, Korea**

**Suwon Test Site: UL Korea, Ltd. Suwon Laboratory**

**218 Maeyeong-ro, Yeongtong-gu,  
Suwon-si, Gyeonggi-do, 16675, Korea**

**TEL: (031) 337-9902**

**FAX: (031) 213-5433**



**ACCREDITED\***

Testing  
Laboratory

**TL-637**

Revision History

<u>Rev.</u>	<u>Issue Date</u>	<u>Revisions</u>	<u>Revised By</u>
V1	02/09/18	Initial issue	Junwhan Lee
V2	02/19/18	Updated to address TCB's question	Junwhan Lee
V3	02/20/18	Updated to address TCB's question	Junwhan Lee

## TABLE OF CONTENTS

<b>1. ATTESTATION OF TEST RESULTS</b>	<b>5</b>
<b>2. TEST METHODOLOGY</b>	<b>6</b>
<b>3. FACILITIES AND ACCREDITATION</b>	<b>6</b>
<b>4. CALIBRATION AND UNCERTAINTY</b>	<b>6</b>
4.1. MEASURING INSTRUMENT CALIBRATION	6
4.2. SAMPLE CALCULATION	6
4.3. MEASUREMENT UNCERTAINTY	7
<b>5. EQUIPMENT UNDER TEST</b>	<b>8</b>
5.1. DESCRIPTION OF EUT	8
5.2. MAXIMUM OUTPUT POWER	8
5.3. DESCRIPTION OF AVAILABLE ANTENNAS	11
5.4. WORST-CASE ORIENTATION	11
5.5. DESCRIPTION OF TEST SETUP	12
<b>6. TEST AND MEASUREMENT EQUIPMENT</b>	<b>14</b>
<b>7. Summary Table</b>	<b>15</b>
<b>8. PEAK TO AVERAGE RATIO</b>	<b>17</b>
8.1. CONDUCTED PEAK TO AVERAGE RESULT	17
8.2. CONDUCTED PEAK TO AVERAGE PLOTS	19
<b>9. LIMITS AND CONDUCTED RESULTS</b>	<b>27</b>
9.1. OCCUPIED BANDWIDTH	27
9.1.1. OCCUPIED BANDWIDTH RESULTS	27
9.1.2. OCCUPIED BANDWIDTH PLOTS	32
9.2. BAND EDGE EMISSIONS	55
9.2.1. BAND EDGE PLOTS	62
9.3. OUT OF BAND EMISSIONS	83
9.3.1. OUT OF BAND EMISSIONS PLOTS	88
9.4. FREQUENCY STABILITY	111
9.4.1. FREQUENCY STABILITY RESULTS	112
<b>10. RADIATED TEST RESULTS</b>	<b>121</b>
10.1. RADIATED POWER (ERP & EIRP)	121
10.1.1. ERP/EIRP Results	122
10.1.2. ERP/EIRP DATA	128
10.2. FIELD STRENGTH OF SPURIOUS RADIATION	151

---

10.2.1.	SPURIOUS RADIATION PLOTS.....	152
<b>11.</b>	<b>SETUP PHOTOS.....</b>	<b>175</b>

# 1. ATTESTATION OF TEST RESULTS

**COMPANY NAME:** SAMSUNG ELECTRONICS CO., LTD.  
**EUT DESCRIPTION:** GSM/WCDMA/LTE Phone + BT/BLE, DTS b/g/n and ANT+  
**MODEL NUMBER:** SM-G611MT/DS  
**SERIAL NUMBER:** R38K102WFSP, R38K102W6YX (RADIATED);  
R38K102W7AW (CONDUCTED)  
**DATE TESTED:** JAN 22, 2018 - FEB 05, 2018

APPLICABLE STANDARDS	
STANDARD	TEST RESULTS
FCC PART 22H, 24E, 27H and 27L	Pass

UL Korea, Ltd. tested the above equipment in accordance with the requirements set forth in the above standards. All indications of Pass/Fail in this report are opinions expressed by UL Korea, Ltd. based on interpretations and/or observations of test results. Measurement Uncertainties were not taken into account and are published for informational purposes only. The test results show that the equipment tested is capable of demonstrating compliance with the requirements as documented in this report.

**Note:** The results documented in this report apply only to the tested sample, under the conditions and modes of operation as described herein. This document may not be altered or revised in any way unless done so by UL Korea, Ltd. and all revisions are duly noted in the revisions section. Any alteration of this document not carried out by UL Korea, Ltd. will constitute fraud and shall nullify the document. This report must not be used by the client to claim product certification, approval, or endorsement by IAS, any agency of the Federal Government, or any agency of any government.

Approved & Released For  
UL Korea, Ltd. By:



SungGil Park  
Suwon Lab Engineer  
UL Korea, Ltd.

Tested By:



Junwhan Lee  
Suwon Lab Engineer  
UL Korea, Ltd.

## 2. TEST METHODOLOGY

The tests documented in this report were performed in accordance with following methods.

1. FCC CFR 47 Part 2.
2. FCC CFR 47 Part 22.
3. FCC CFR 47 Part 24.
4. FCC CFR 47 Part 27
5. ANSI TIA-603-E
6. KDB 971168 D01 Power Meas License Digital Systems v03

## 3. FACILITIES AND ACCREDITATION

The test sites and measurement facilities used to collect data are located at 218 Maeyeong-ro, Yeongtong-gu, Suwon-si, Gyeonggi-do, 16675, Korea. Line conducted emissions are measured only at the 218 address. The following table identifies which facilities were utilized for radiated emission measurements documented in this report. Specific facilities are also identified in the test results sections.

218 Maeyeong-ro
<input checked="" type="checkbox"/> Chamber 1
<input checked="" type="checkbox"/> Chamber 2

UL Korea, Ltd. is accredited by IAS, Laboratory Code TL-637. The full scope of accreditation can be viewed at <http://www.iasonline.org/PDF/TL/TL-637.pdf>.

## 4. CALIBRATION AND UNCERTAINTY

### 4.1. MEASURING INSTRUMENT CALIBRATION

The measuring equipment utilized to perform the tests documented in this report has been calibrated in accordance with the manufacturer's recommendations, and is traceable to recognized national standards.

### 4.2. SAMPLE CALCULATION

Where relevant, the following sample calculation is provided:

$EIRP = PSA \text{ reading with EUT worst orientation (dBm)} + \text{Path loss (dB)} - \text{cable loss (between the SG and substitution antenna)} + \text{Substitution Antenna Factor (dBi)}$

$ERP = PSA \text{ reading with EUT worst orientation (dBm)} + \text{Path loss (dB)} - \text{cable loss (between the SG and substitution antenna)}$

(Path loss = Signal generator output – PSA reading with substitution antenna)

### 4.3. MEASUREMENT UNCERTAINTY

Where relevant, the following measurement uncertainty levels have been estimated for tests performed on the apparatus:

PARAMETER	UNCERTAINTY
Conducted Disturbance, 0.15 to 30 MHz	2.32 dB
Radiated Disturbance, Below 1GHz	3.86 dB
Radiated Disturbance, Above 1 GHz	5.97 dB

Uncertainty figures are valid to a confidence level of 95%.

## 5. EQUIPMENT UNDER TEST

### 5.1. DESCRIPTION OF EUT

The EUT is a GSM/WCDMA/LTE Phone + BT/BLE, DTS b/g/n and ANT+.

### 5.2. MAXIMUM OUTPUT POWER

The transmitter has a maximum average conducted and radiated ERP / EIRP output powers as follows:

Note : Conducted output power results were excerpted from RF exposure test report.(4788312331-S1V1 FCC Report SAR)

#### GSM

FCC Part 22/24						
Band	Frequency Range	Modulation	Conducted		Radiated	
	[MHz]		Peak	Avg [dBm]	Avg [mW]	Avg [dBm]
GSM850	824~849	GMSK	32.2	1659.59		
		GPRS	32.2	1659.59	29.65	922.57
		EGPRS	26.8	478.63	26.35	431.52
GSM1900	1850~1910	GMSK	29.8	954.99		
		GPRS	29.8	954.99	28.72	744.73
		EGPRS	26.0	398.11	25.95	393.55

**WCDMA**

FCC Part 22/24						
Band	Frequency Range	Modulation	Conducted		Radiated	
	[MHz]		Peak	Avg [dBm]	Avg [mW]	Avg [dBm]
Band 5	824~849	REL99	24.00	251.19	20.76	119.12
		HSDPA	24.00	251.19	20.94	124.17
		HSUPA	24.00	251.19		
		DC-HSDPA	23.90	245.47		
Band 4	1710~1755	REL99	22.30	169.82	22.25	167.88
		HSDPA	22.30	169.82	22.76	188.80
		HSUPA	22.30	169.82		
		DC-HSDPA	22.40	173.78		
Band 2	1850~1910	REL99	22.20	165.96	22.05	160.32
		HSDPA	21.80	151.36	22.04	159.96
		HSUPA	22.20	165.96		
		DC-HSDPA	21.80	151.36		

**LTE Band 17**

FCC Part 27							
Band	Frequency Range [MHz]	BandWidth [MHz]	Modulation	Conducted		Radiated	
				Peak	Avg [dBm]	Avg [mW]	Avg [dBm]
Band 17	704 ~ 716	10	QPSK	23.9	245.47	15.44	34.99
			16QAM	22.6	181.97	15.29	33.81
		5	QPSK	23.9	245.47	15.43	34.91
			16QAM	22.9	194.98	14.21	26.36

**LTE Band 5**

FCC Part 22							
Band	Frequency Range [MHz]	BandWidth [MHz]	Modulation Peak	Conducted		Radiated	
				Avg [dBm]	Avg [mW]	Avg [dBm]	Avg [mW]
Band 5	824 ~ 849	10	QPSK	24.3	269.77	20.06	101.39
			16QAM	23.2	208.45	18.43	69.66
		5	QPSK	24.2	263.03	19.68	92.90
			16QAM	23.2	208.93	18.71	74.30
		3	QPSK	24.3	269.15	19.77	94.84
			16QAM	23.5	223.87	18.82	76.21
		1.4	QPSK	24.3	268.53	17.63	57.94
			16QAM	23.4	218.78	16.69	46.67

**LTE Band 4**

FCC Part 27							
Band	Frequency Range [MHz]	BandWidth [MHz]	Modulation Peak	Conducted		Radiated	
				Avg [dBm]	Avg [mW]	Avg [dBm]	Avg [mW]
Band 4	1710 ~ 1755	20	QPSK	22.2	165.96	20.41	109.90
			16QAM	21.1	128.82	19.45	88.10
		15	QPSK	22.3	169.82	20.41	109.90
			16QAM	21.1	128.82	20.48	111.69
		10	QPSK	22.3	169.82	20.53	112.98
			16QAM	21.3	134.90	19.52	89.54
		5	QPSK	22.3	169.82	20.29	106.91
			16QAM	21.2	131.83	19.27	84.53
		3	QPSK	22.4	173.78	20.43	110.41
			16QAM	21.5	141.25	19.34	85.90
		1.4	QPSK	22.4	173.78	18.31	67.76
			16QAM	21.4	138.04	17.34	54.20

**LTE Band 2**

FCC Part 24							
Band	Frequency Range [MHz]	BandWidth [MHz]	Modulation Peak	Conducted		Radiated	
				Avg [dBm]	Avg [mW]	Avg [dBm]	Avg [mW]
Band 2	1850 ~ 1910	20	QPSK	22.9	194.98	19.91	97.95
			16QAM	21.8	151.36	18.98	79.07
		15	QPSK	22.9	194.98	20.30	107.15
			16QAM	21.8	151.36	19.31	85.31
		10	QPSK	22.9	194.98	20.50	112.20
			16QAM	21.8	151.36	19.48	88.72
		5	QPSK	22.8	190.55	20.54	113.24
			16QAM	21.7	147.91	19.56	90.36
		3	QPSK	22.9	194.98	18.70	74.13
			16QAM	21.6	144.54	17.71	59.02
		1.4	QPSK	22.8	190.55	16.50	44.67
			16QAM	21.9	154.88	15.60	36.31

**5.3. DESCRIPTION OF AVAILABLE ANTENNAS**

The radio utilizes a internal antenna for the [List the bands supported] with a maximum peak gain as follow:

Frequency (MHz)	Peak Gain (dBi)
GSM850/WCDMA Band 5 / LTE Band 5 824 ~ 849 MHz	-5.9
GSM1900/WCDMA Band 2 /LTE Band 2 1850 ~ 1910 MHz	-4.3
WCDMA Band 4 /LTE Band 5 1710 ~ 1755 MHz	-5.1
LTE Band 17 704 ~ 716 MHz	-7.4

**5.4. WORST-CASE ORIENTATION**

For GSM1900/WCDMA Band 2 /LTE Band 2/ WCDMA Band 4 /LTE Band 5, the fundamental of the EUT was investigated in three orthogonal orientations X, Y and Z it was determined that X orientation was worst-case orientation; therefore, all final radiated testing was performed with the EUT in X orientation.

For GSM850/WCDMA Band 5 / LTE Band 5 /LTE Band 17, the fundamental of the EUT was investigated in three orthogonal orientations X, Y and Z it was determined that Z orientation was worst-case orientation; therefore, all final radiated testing was performed with the EUT in Z orientation.

## 5.5. DESCRIPTION OF TEST SETUP

### SUPPORT EQUIPMENT

Support Equipment List				
Description	Manufacturer	Model	Serial Number	FCC ID
Charger	SAMSUNG	EP-TA50BWB	DK1J511VS/A- E	N/A
Data Cable	SAMSUNG	ECB-DU68WE	N/A	N/A
Earphone	SAMSUNG	EHS61ASFWE	N/A	N/A

### I/O CABLES

I/O Cable List						
Cable No	Port	# of identical ports	Connector Type	Cable Type	Cable Length (m)	Remarks
1	DC Power	1	Mini-USB	Shielded	1.2m	N/A
2	Audio	2	Mini-Jack	Unshielded	1.2m	N/A

### TEST SETUP

The EUT is continuously communicated to the call box during the tests.

**SETUP DIAGRAM FOR TESTS (CONDUCTED TEST SETUP)**

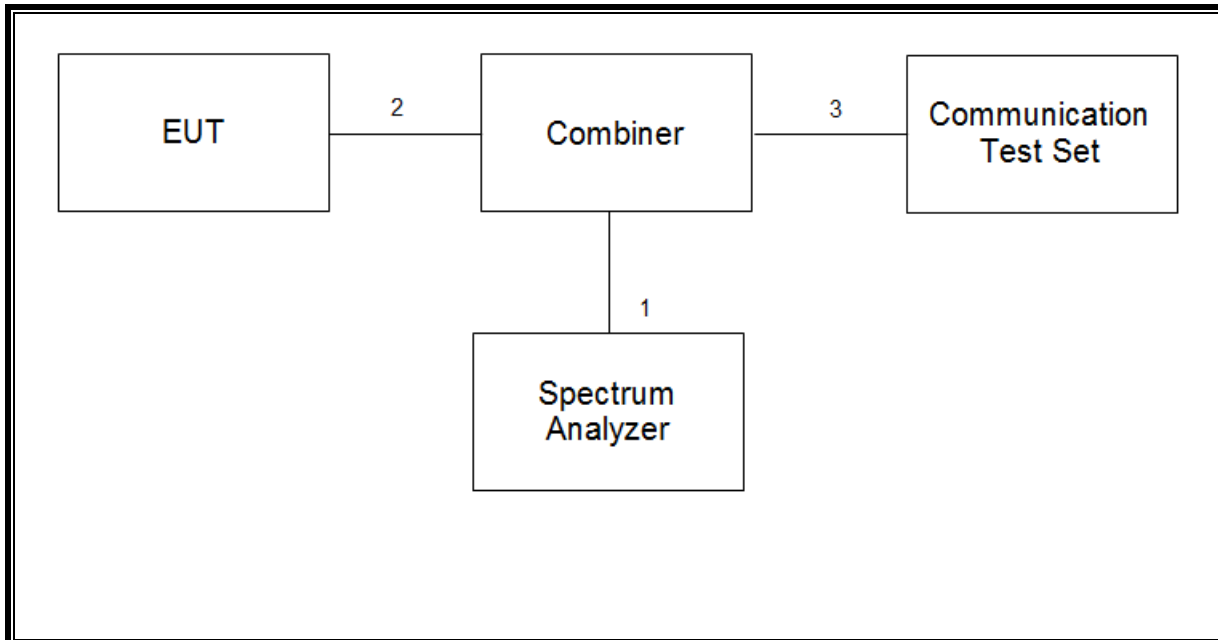

**SETUP DIAGRAM FOR TESTS (RADIATED TEST SETUP)**

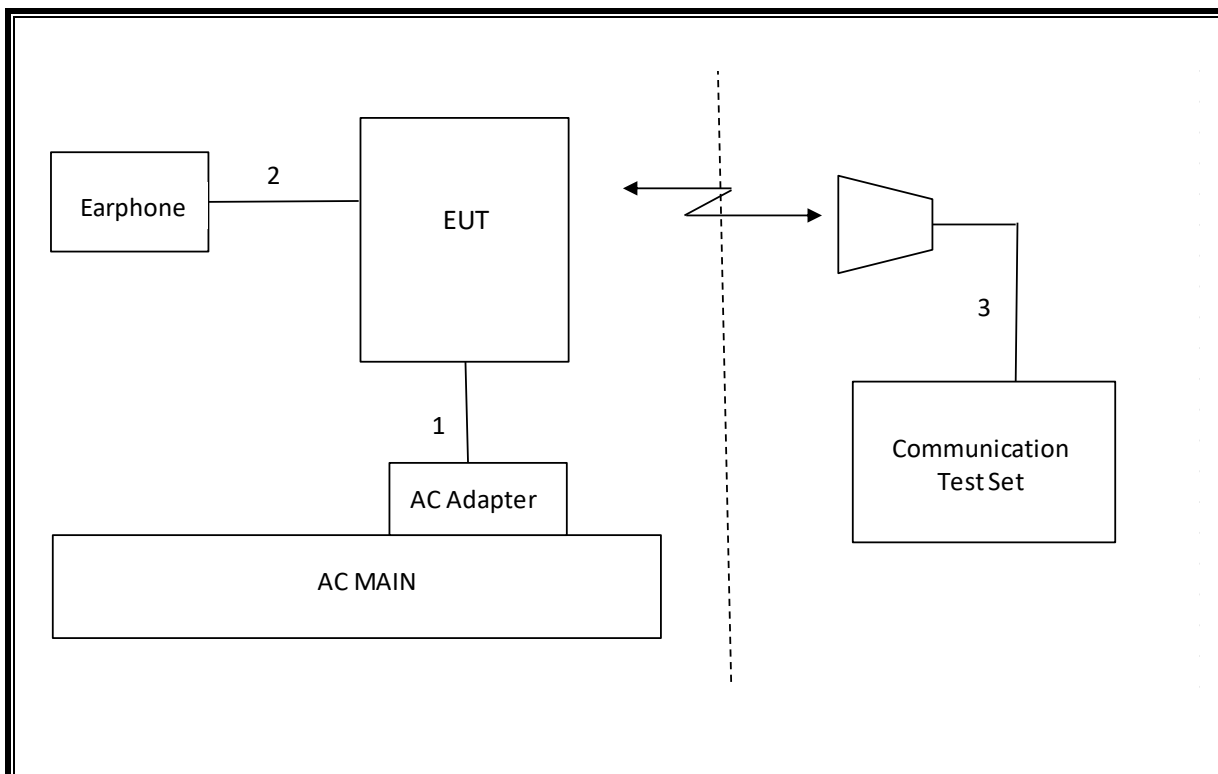

## 6. TEST AND MEASUREMENT EQUIPMENT

The following test and measurement equipment was utilized for the tests documented in this report:

Description	Manufacturer	Model	S/N	Cal Due
Antenna, Tuned Dipole 400~1000 MHz	ETS	3121D DB4	00164753	06-30-19
Antenna, Horn, 40 GHz	ETS	3116C	00166155	12-04-19
Preamplifier	ETS	3116C-PA	00168841	11-13-19
Antenna, Horn, 40 GHz	ETS	3116C	00168645	12-04-19
Antenna, Bilog, 30MHz-1GHz	SCHWARZBECK	VULB9163	750	10-14-18
Antenna, Bilog, 30MHz-1GHz	SCHWARZBECK	VULB9163	749	04-14-19
Antenna, Horn, 18 GHz	ETS	3115	00167211	10-14-18
Antenna, Horn, 18 GHz	ETS	3115	00161451	03-10-19
Antenna, Horn, 18 GHz	ETS	3117	00168724	05-31-19
Antenna, Horn, 18 GHz	ETS	3117	00168717	05-31-19
Combiner	WEINSCHTEL	1575	2152	08-08-18
Communications Test Set	R&S	CMW500	150312	08-07-18
Communications Test Set	R&S	CMW500	115331	08-07-18
DC Power Supply	Agilent / HP	E3640A	MY54226395	08-07-18
Preamplifier, 1000 MHz	Sonoma	310N	341282	08-09-18
Preamplifier, 1000 MHz	Sonoma	310N	351741	08-07-18
Preamplifier, 18 GHz	Miteq	AFS42-00101800-25-S-42	1876511	08-08-18
Preamplifier, 18 GHz	Miteq	AFS42-00101800-25-S-42	1896138	08-08-18
Spectrum Analyzer, 44 GHz	Agilent / HP	N9030A	MY54490312	08-08-18
EMI Test Receive, 40 GHz	R&S	ESU40	100439	08-08-18
EMI Test Receive, 40 GHz	R&S	ESU40	100457	08-08-18
High Pass Filter 1.2GHz	Micro-Tronics	HPM50108-02	G005	08-09-18
High Pass Filter 1.2GHz	Micro-Tronics	HPM50108-02	G006	08-08-18
High Pass Filter 2.8GHz	Micro-Tronics	HPM50111-02	010	08-09-18
High Pass Filter 2.8GHz	Micro-Tronics	HPM50111-02	011	08-08-18
High Pass Filter 4GHz	Micro-Tronics	HPM50118-02	G001	08-09-18
High Pass Filter 4GHz	Micro-Tronics	HPM50118-02	G002	08-08-18
Attenuator	PASTERNAK	PE7087-10	A009	08-08-18
Antenna, Loop, 9kHz-30MHz	R&S	HFH2-Z2	100418	10-26-19
Temperature Chamber	ESPEC	SH-642	93001109	08-08-18
UL Software				
Description	Manufacturer	Model	Version	
Antenna port test software	UL	CLT	Ver 2.2	

## 7. Summary Table

FCC Part Section	Test Description	Test Limit	Test Condition	Test Result	Note
2.1049	Occupied Band width (99%)	N/A	Conducted	Pass	17.93 MHz
22.917(a) 24.238(a) 27.53(g),(h)	Band Edge / Conducted Spurious Emission	-13dBm		Pass	-15.8dBm
2.1046	Conducted output power	N/A		Pass	32.2 dBm
22.355 24.235 27.54	Frequency Stability	2.5PPM		Pass	-0.009PPM
22.913(a)(2)	Effective Radiated Power	38.45 dBm	Radiated	Pass	29.65 dBm
27.50(c)(10)		34.77dBm		Pass	15.44 dBm
27.50(d)(4)	Equivalent Isotropic Radiated Power	30dBm		Pass	22.76 dBm
24.232(c)		33dBm		Pass	28.72 dBm
22.917(a) 24.238(a) 27.53(g),(h)	Radiated Spurious Emission	-13dBm		Pass	-32.7 dBm

FCC Rule Part	Frequency Range [MHz]	Output Power [W]	Frequency Tolerance	Emission Designator	Emission Bandwidth [MHz]	Communication Type
GSM						
22H	824.2 - 848.8	0.923	2.5 ppm	236KGXW		GSM850
22H	824.2 - 848.8	0.432	2.5 ppm	237KG7W		EDGE850
24E	1850.2 - 1909.8	0.745	2.5 ppm	240KGXW		GSM1900
24E	1850.2 - 1909.8	0.394	2.5 ppm	243KG7W		EDGE1900
WCDMA						
22H	826.4 - 846.6	0.124	2.5 ppm	4M14F9W		WCDMA B5
27L	1712.4 - 1752.6	0.189	2.5 ppm	4M15F9W		WCDMA B4
24E	1852.4 - 1907.6	0.160	2.5 ppm	4M14F9W		WCDMA B2
LTE Band 2						
24E	1860.0 - 1900.0	0.098	2.5 ppm	17M9G7W	20	QPSK
24E	1860.0 - 1900.0	0.079	2.5 ppm	17M9D7W	20	16QAM
24E	1852.5 - 1907.5	0.113	2.5 ppm	4M51G7W	5	QPSK
24E	1852.5 - 1907.5	0.090	2.5 ppm	4M51D7W	5	16QAM
LTE Band 4						
27L	1720.0 - 1745.0	0.110	2.5 ppm	17M9G7W	20	QPSK
27L	1720.0 - 1745.0	0.088	2.5 ppm	17M9D7W	20	16QAM
27L	1717.5 - 1747.5	0.112	2.5 ppm	13M5D7W	15	16QAM
27L	1715.0 - 1750.0	0.113	2.5 ppm	8M99G7W	10	QPSK
LTE Band 5						
22H	829.0 - 844.0	0.101	2.5 ppm	8M96G7W	10	QPSK
22H	829.0 - 844.0	0.070	2.5 ppm	8M98D7W	10	16QAM
22H	825.5 - 847.5	0.076	2.5 ppm	2M70D7W	3	16QAM
LTE Band 17						
27H	709.0 - 711.0	0.035	2.5 ppm	8M96G7W	10	QPSK
27H	709.0 - 711.0	0.034	2.5 ppm	8M96D7W	10	16QAM

## 8. PEAK TO AVERAGE RATIO

### Test Procedure

Per KDB 971168 D01 Power Meas License Digital Systems v03;

The transmitter output was connected to a CMW500 Test Set and configured to operate at maximum power. The PAR were measured on the Spectrum Analyzer.

### Test Spec

In addition, when the transmitter power is measured in terms of average value, the peak-to-average ratio of the power shall not exceed 13 dB.

### 8.1. CONDUCTED PEAK TO AVERAGE RESULT

#### GSM

Band	Channel	f [MHz]	Mode	Ratio [dB]	Limit [dB]
GSM850	190	836.6	GPRS	0.40	13.00
			EGPRS	3.46	
GSM1900	661	1880.0	GPRS	0.35	
			EGPRS	3.10	

#### WCDMA

Band	Channel	f [MHz]	Mode	Ratio [dB]	Limit [dB]
Band 5	4183	836.6	REL99	3.13	13.00
			HSDPA	3.22	
Band 4	1413	1732.6	REL99	3.24	
			HSDPA	3.32	
Band 2	9400	1880.0	REL99	3.13	
			HSDPA	3.26	

**LTE**

Band	BW [MHz]	Channel	f [MHz]	Mode	Ratio [dB]	Limit [dB]
Band 17	10	23790	710	QPSK	4.73	13.00
				16QAM	6.03	
	5			QPSK	4.66	
				16QAM	5.91	
Band 5	10	20525	836.5	QPSK	5.19	13.00
				16QAM	6.56	
	5			QPSK	5.18	
				16QAM	6.43	
	3			QPSK	5.06	
				16QAM	6.12	
	1.4			QPSK	5.17	
				16QAM	6.18	
Band 4	20	20174	1732.5	QPSK	5.79	13.00
				16QAM	6.81	
	15			QPSK	5.74	
				16QAM	6.98	
	10			QPSK	5.65	
				16QAM	6.96	
	5			QPSK	5.71	
				16QAM	7.06	
	3			QPSK	5.70	
				16QAM	6.77	
1.4	QPSK	5.81				
	16QAM	6.90				
Band 2	20	18900	1880.0	QPSK	5.27	13.00
				16QAM	6.45	
	15			QPSK	5.16	
				16QAM	6.65	
	10			QPSK	5.37	
				16QAM	6.61	
	5			QPSK	5.43	
				16QAM	6.43	
	3			QPSK	5.28	
				16QAM	6.55	
1.4	QPSK	5.27				
	16QAM	6.53				

## 8.2. CONDUCTED PEAK TO AVERAGE PLOTS

### GSM

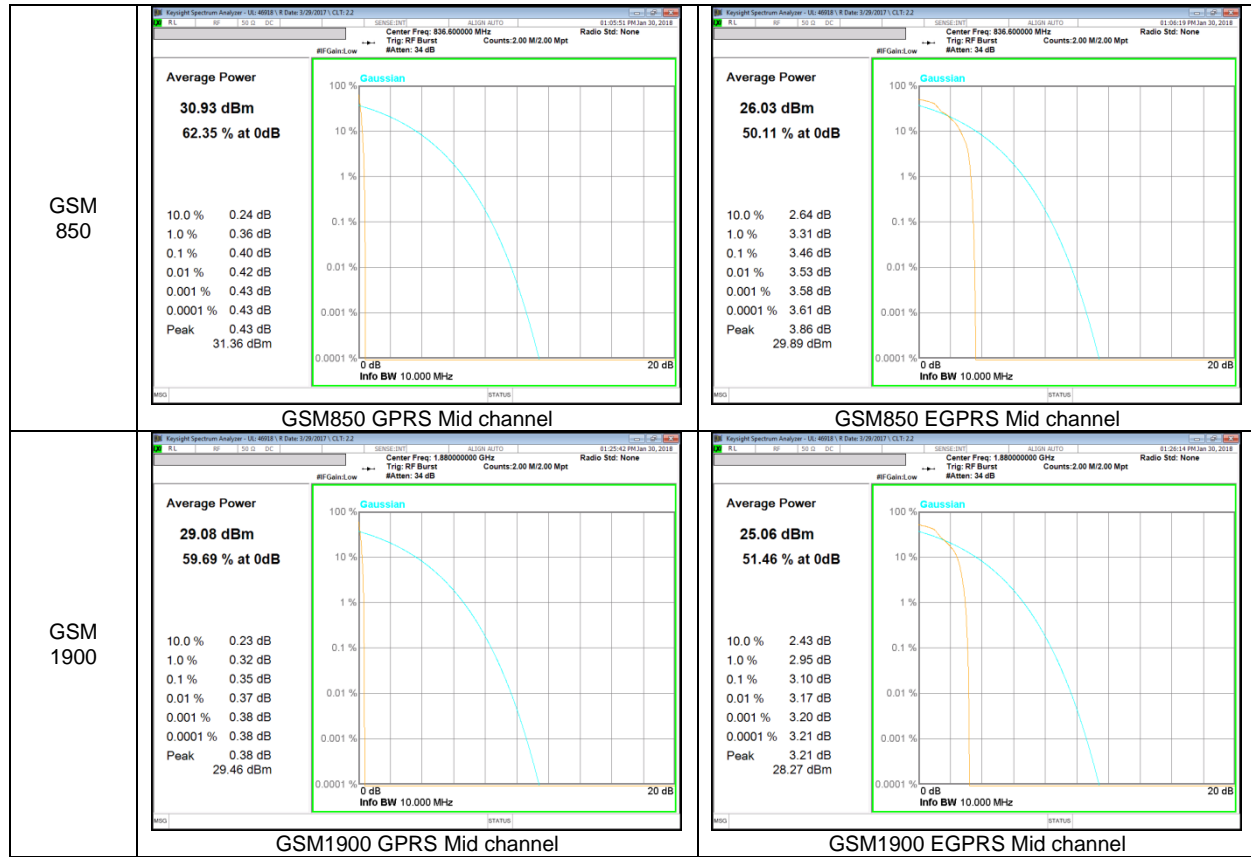

**WCDMA**

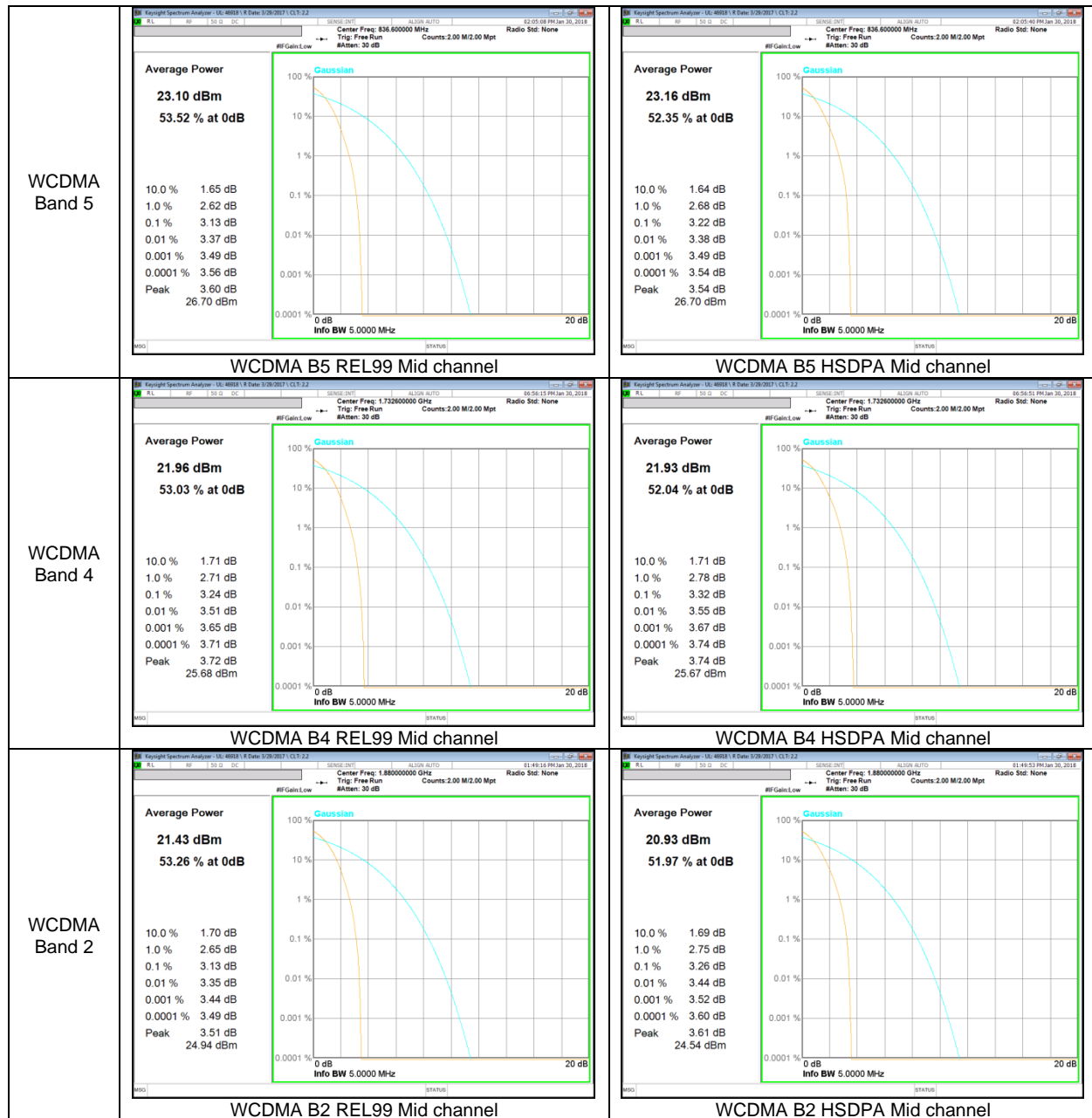

**LTE Band 17**

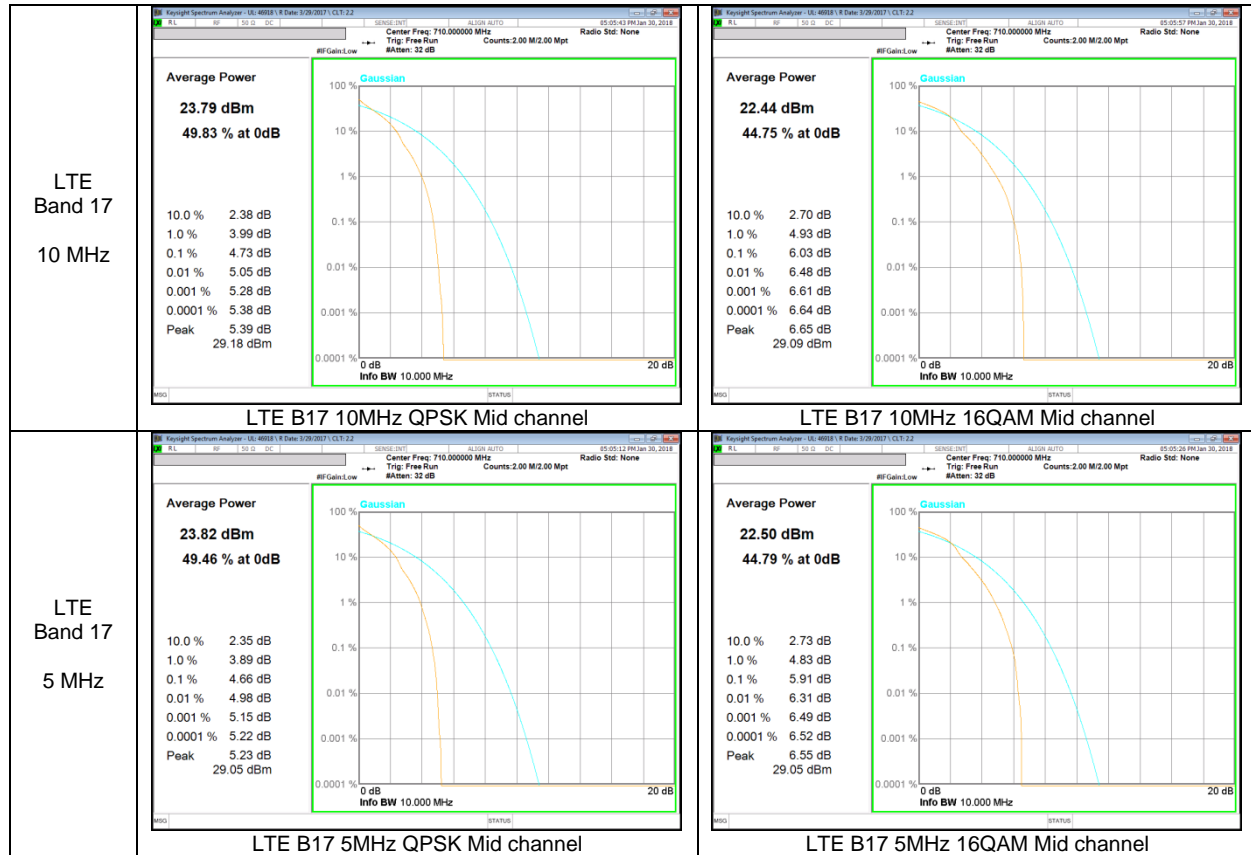

**LTE Band 5**

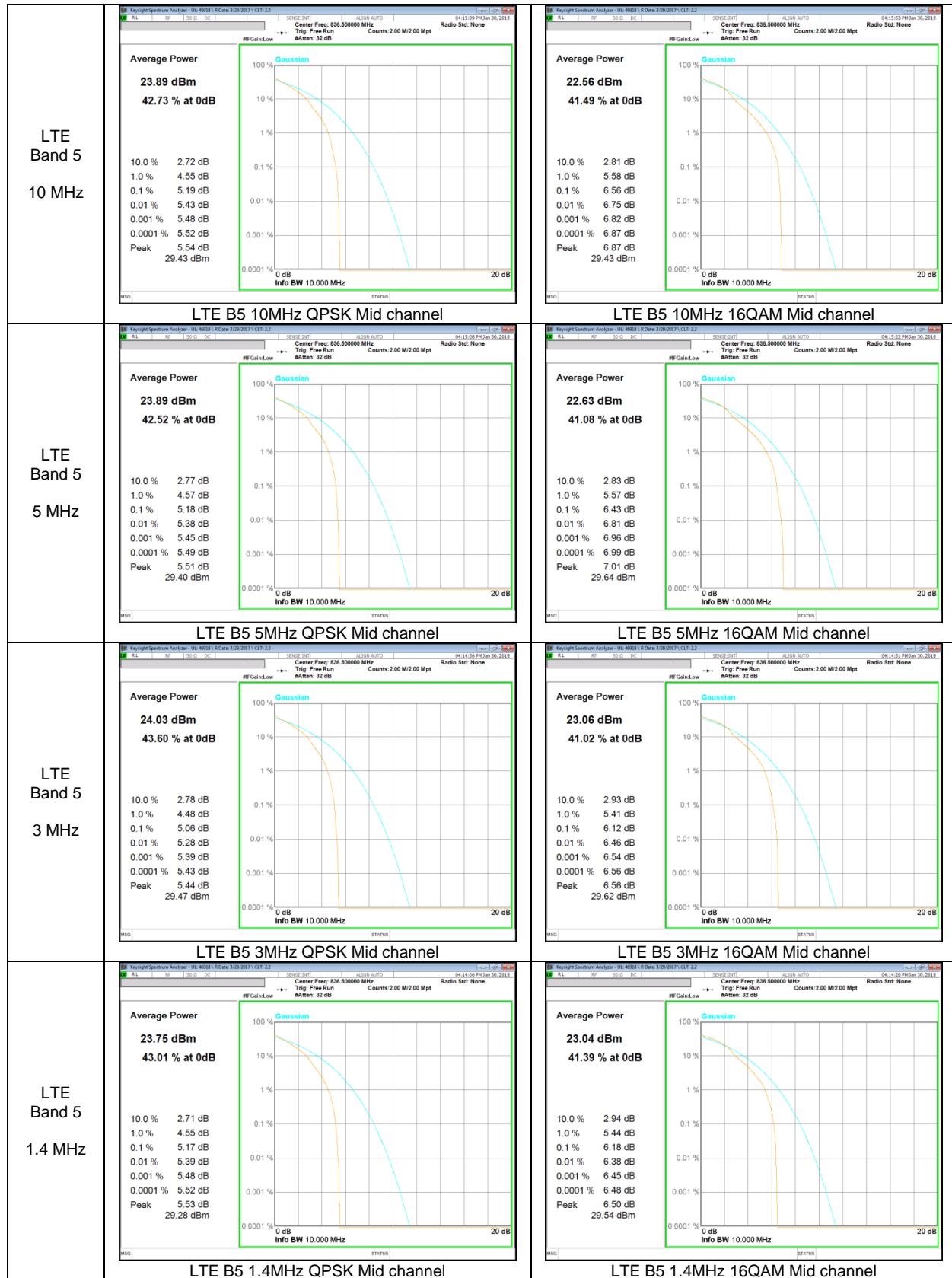

**LTE Band 4**

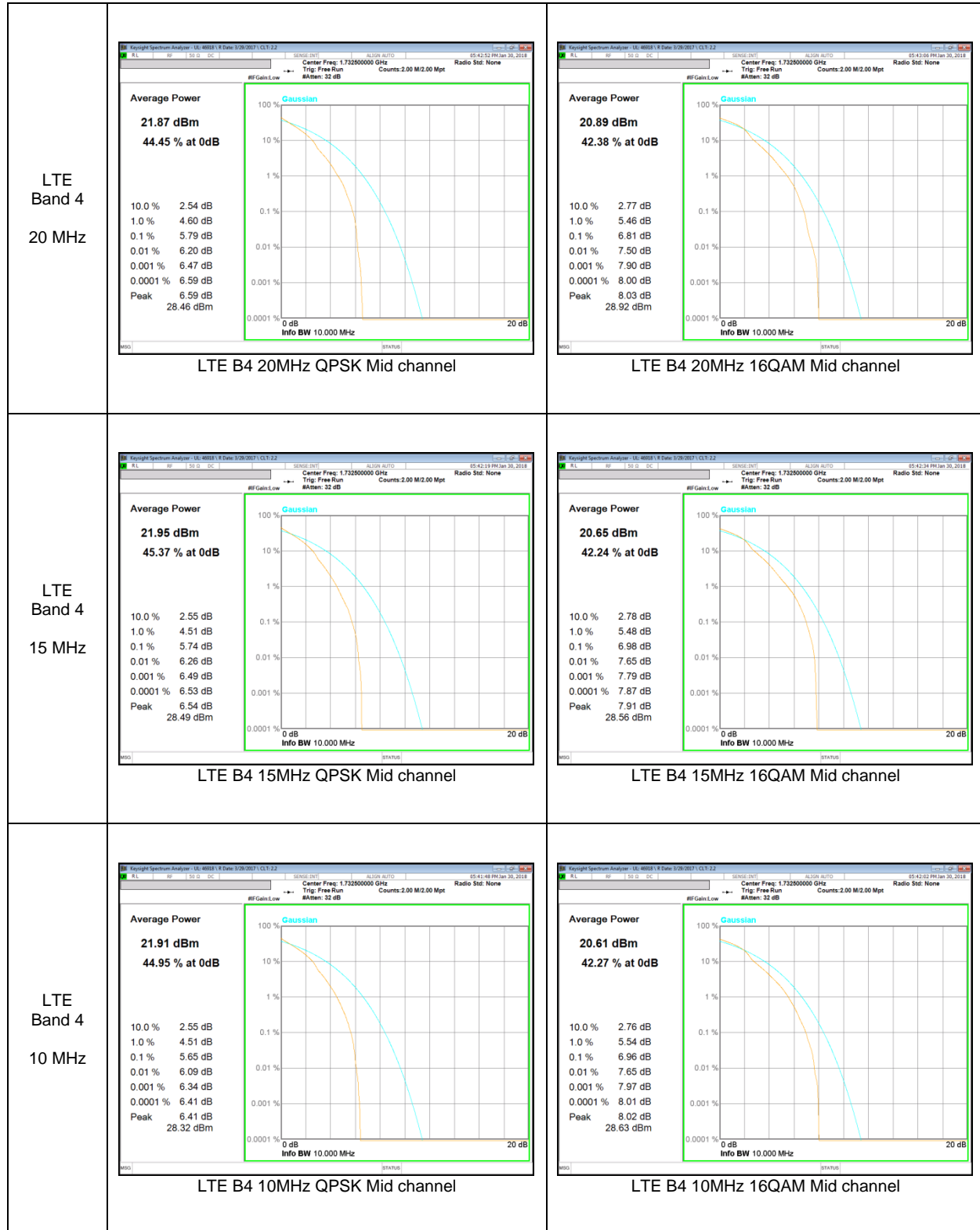

<p>LTE Band 4 5 MHz</p>	<p>Average Power 22.00 dBm 44.56 % at 0dB</p> <p>10.0 % 2.59 dB 1.0 % 4.63 dB 0.1 % 5.71 dB 0.01 % 6.38 dB 0.001 % 6.72 dB 0.0001 % 6.75 dB Peak 28.75 dBm</p> <p>LTE B4 5MHz QPSK Mid channel</p>	<p>Average Power 20.71 dBm 42.35 % at 0dB</p> <p>10.0 % 2.80 dB 1.0 % 5.51 dB 0.1 % 7.06 dB 0.01 % 7.99 dB 0.001 % 8.33 dB 0.0001 % 8.40 dB Peak 29.21 dBm</p> <p>LTE B4 5MHz 16QAM Mid channel</p>
<p>LTE Band 4 3 MHz</p>	<p>Average Power 22.07 dBm 45.00 % at 0dB</p> <p>10.0 % 2.60 dB 1.0 % 4.59 dB 0.1 % 5.70 dB 0.01 % 6.13 dB 0.001 % 6.51 dB 0.0001 % 6.63 dB Peak 28.73 dBm</p> <p>LTE B4 3MHz QPSK Mid channel</p>	<p>Average Power 20.81 dBm 42.22 % at 0dB</p> <p>10.0 % 2.77 dB 1.0 % 5.51 dB 0.1 % 6.77 dB 0.01 % 7.39 dB 0.001 % 7.77 dB 0.0001 % 7.82 dB Peak 28.65 dBm</p> <p>LTE B4 3MHz 16QAM Mid channel</p>
<p>LTE Band 4 1.4 MHz</p>	<p>Average Power 21.88 dBm 45.40 % at 0dB</p> <p>10.0 % 2.58 dB 1.0 % 4.64 dB 0.1 % 5.81 dB 0.01 % 6.28 dB 0.001 % 6.37 dB 0.0001 % 6.44 dB Peak 28.32 dBm</p> <p>LTE B4 1.4MHz QPSK Mid channel</p>	<p>Average Power 21.09 dBm 42.50 % at 0dB</p> <p>10.0 % 2.81 dB 1.0 % 5.43 dB 0.1 % 6.90 dB 0.01 % 7.54 dB 0.001 % 7.96 dB 0.0001 % 8.03 dB Peak 29.13 dBm</p> <p>LTE B4 1.4MHz 16QAM Mid channel</p>

**LTE Band 2**

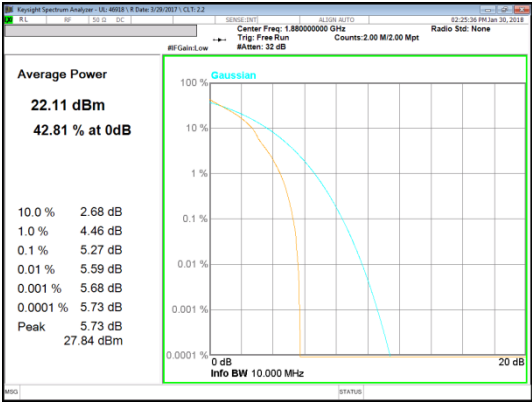
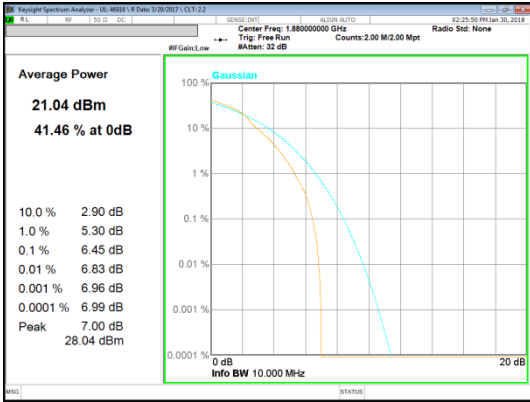
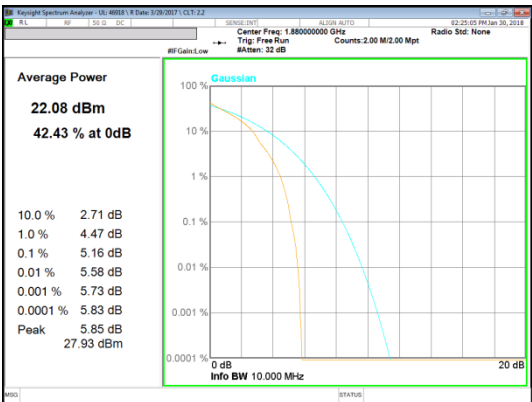
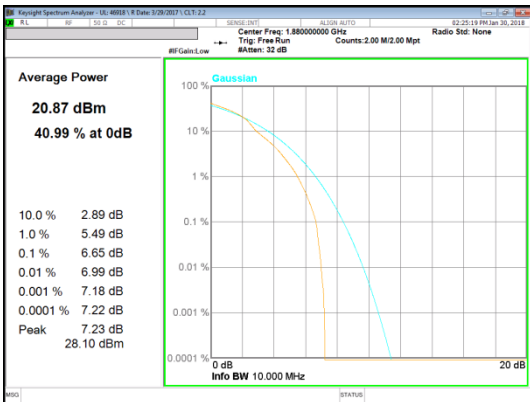
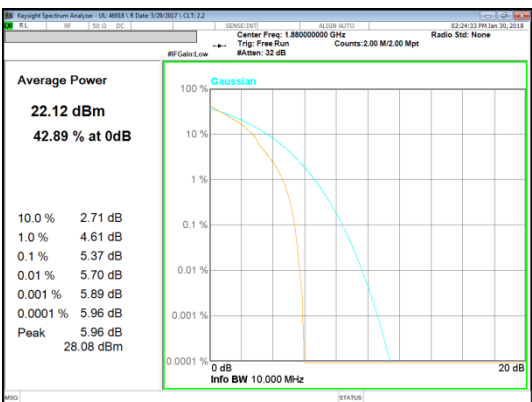
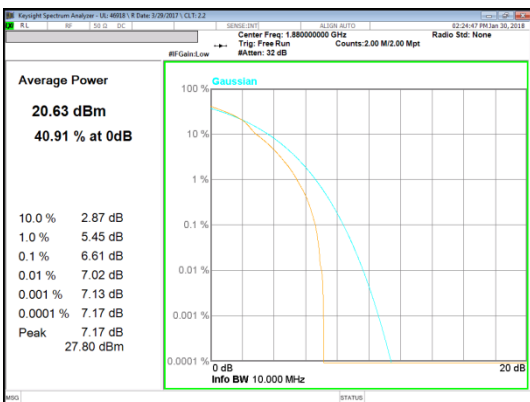
<p>LTE Band 2 20 MHz</p>	 <p>Average Power 22.11 dBm 42.81 % at 0dB</p> <p>10.0 % 2.68 dB 1.0 % 4.46 dB 0.1 % 5.27 dB 0.01 % 5.59 dB 0.001 % 5.68 dB 0.0001 % 5.73 dB Peak 27.84 dBm</p> <p>LTE B2 20MHz QPSK Mid channel</p>	 <p>Average Power 21.04 dBm 41.46 % at 0dB</p> <p>10.0 % 2.90 dB 1.0 % 5.30 dB 0.1 % 6.45 dB 0.01 % 6.83 dB 0.001 % 6.96 dB 0.0001 % 6.99 dB Peak 7.00 dB 28.04 dBm</p> <p>LTE B2 20MHz 16QAM Mid channel</p>
<p>LTE Band 2 15 MHz</p>	 <p>Average Power 22.08 dBm 42.43 % at 0dB</p> <p>10.0 % 2.71 dB 1.0 % 4.47 dB 0.1 % 5.16 dB 0.01 % 5.58 dB 0.001 % 5.73 dB 0.0001 % 5.83 dB Peak 27.93 dBm</p> <p>LTE B2 15MHz QPSK Mid channel</p>	 <p>Average Power 20.87 dBm 40.99 % at 0dB</p> <p>10.0 % 2.89 dB 1.0 % 5.49 dB 0.1 % 6.65 dB 0.01 % 6.99 dB 0.001 % 7.18 dB 0.0001 % 7.22 dB Peak 7.23 dB 28.10 dBm</p> <p>LTE B2 15MHz 16QAM Mid channel</p>
<p>LTE Band 2 10 MHz</p>	 <p>Average Power 22.12 dBm 42.89 % at 0dB</p> <p>10.0 % 2.71 dB 1.0 % 4.61 dB 0.1 % 5.37 dB 0.01 % 5.70 dB 0.001 % 5.89 dB 0.0001 % 5.96 dB Peak 5.96 dB 28.08 dBm</p> <p>LTE B2 10MHz QPSK Mid channel</p>	 <p>Average Power 20.63 dBm 40.91 % at 0dB</p> <p>10.0 % 2.87 dB 1.0 % 5.45 dB 0.1 % 6.61 dB 0.01 % 7.02 dB 0.001 % 7.13 dB 0.0001 % 7.17 dB Peak 7.17 dB 27.80 dBm</p> <p>LTE B2 10MHz 16QAM Mid channel</p>

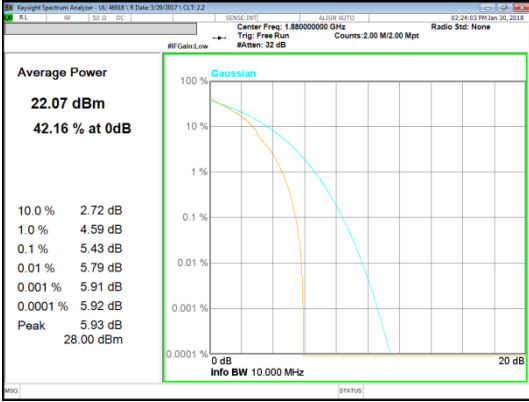
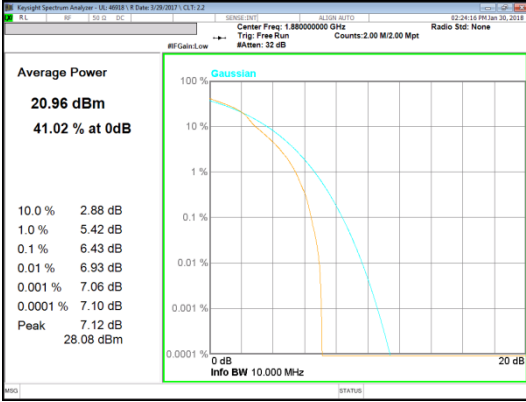
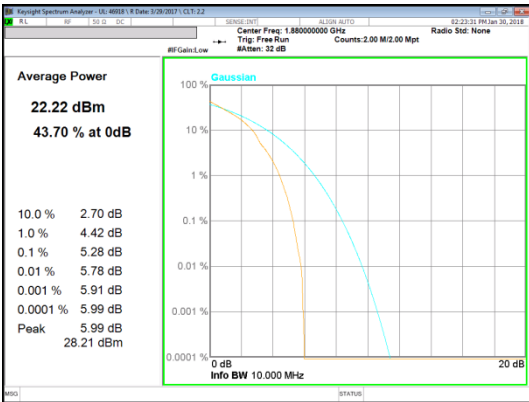
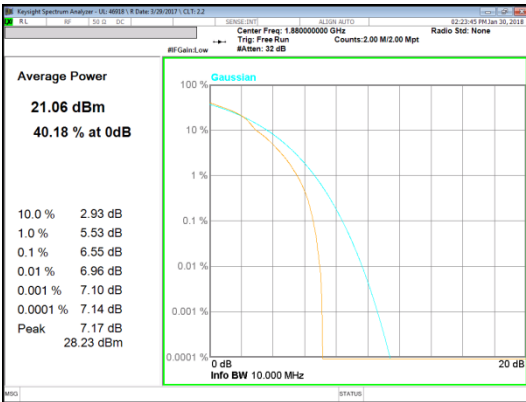
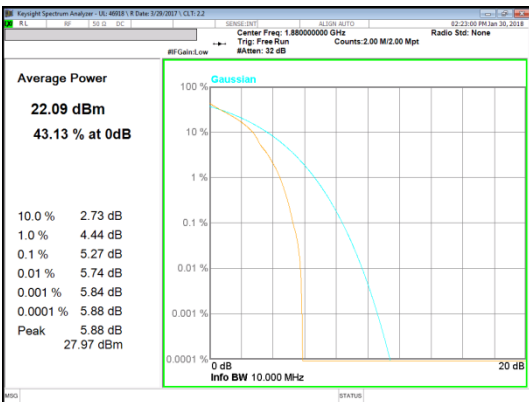
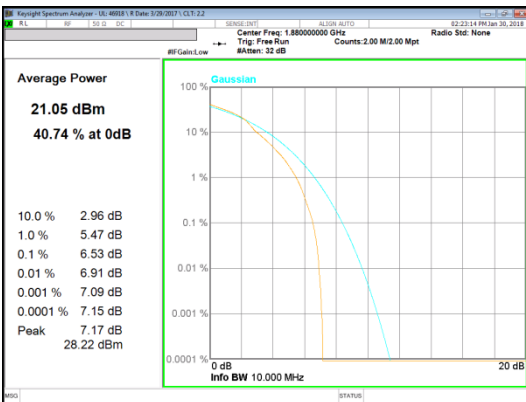
<p>LTE Band 2 5 MHz</p>	 <p>LTE B2 5MHz QPSK Mid channel</p>	 <p>LTE B2 5MHz 16QAM Mid channel</p>
<p>LTE Band 2 3 MHz</p>	 <p>LTE B2 3MHz QPSK Mid channel</p>	 <p>LTE B2 3MHz 16QAM Mid channel</p>
<p>LTE Band 2 1.4 MHz</p>	 <p>LTE B2 1.4MHz QPSK Mid channel</p>	 <p>LTE B2 1.4MHz 16QAM Mid channel</p>

## 9. LIMITS AND CONDUCTED RESULTS

### 9.1. OCCUPIED BANDWIDTH

#### RULE PART(S)

FCC: §2.1049

#### LIMITS

For reporting purposes only

#### TEST PROCEDURE

The transmitter output was connected to a calibrated coaxial cable and coupler, the other end of which was connected to a spectrum analyzer. The occupied bandwidth was measured with the spectrum analyzer at the low, middle and high channel in each band. The -26dB bandwidth was also measured and recorded. (KDB 971168 D01 Power Meas License Digital Systems v03)

#### 9.1.1. OCCUPIED BANDWIDTH RESULTS

#### GSM

Band	Mode	Channel	f [MHz]	99% BW [KHz]	26dB BW [KHz]
GSM850	GPRS	128	824.2	236.07	302.9
		190	836.6	233.53	294.8
		251	848.8	234.51	297.4
	EGPRS	128	824.2	236.08	296.8
		190	836.6	236.15	295.3
		251	848.8	237.14	298.8
GSM1900	GPRS	512	1850.2	239.32	300.4
		661	1880.0	239.95	311.5
		810	1909.8	239.00	309.2
	EGPRS	512	1850.2	237.78	309.2
		661	1880.0	236.38	308.4
		810	1909.8	242.75	303.7

**WCDMA**

Band	Mode	Channel	f [MHz]	99% BW [MHz]	26dB BW [MHz]
Band 5	REL99	4132	826.4	4.1185	4.683
		4183	836.6	4.1226	4.700
		4233	846.6	4.1279	4.672
	HSDPA	4132	826.4	4.1353	4.705
		4183	836.6	4.1234	4.716
		4233	846.6	4.1370	4.657
Band 4	REL99	1312	1712.4	4.1356	4.670
		1413	1732.6	4.1277	4.685
		1513	1752.6	4.1344	4.684
	HSDPA	1312	1712.4	4.1315	4.661
		1413	1732.6	4.1468	4.646
		1513	1752.6	4.1454	4.670
Band 2	REL99	9262	1852.4	4.1274	4.682
		9400	1880.0	4.1334	4.687
		9538	1907.6	4.1268	4.676
	HSDPA	9262	1852.4	4.1387	4.673
		9400	1880.0	4.1447	4.678
		9538	1907.6	4.1375	4.673

**LTE Band 17**

Band	BW [MHz]	Channel	f [MHz]	Mode	99% BW [MHz]	26dB BW [MHz]
Band 17	10	23780	709.0	QPSK	8.9514	10.20
				16QAM	8.9563	10.14
		23790	710.0	QPSK	8.9557	10.06
				16QAM	8.9348	10.15
		23799	711.0	QPSK	8.9261	10.20
				16QAM	8.9616	10.07
	5	23755	706.5	QPSK	4.4962	5.200
				16QAM	4.4916	5.247
		23790	710.0	QPSK	4.4902	5.269
				16QAM	4.4942	5.221
		23824	713.5	QPSK	4.4950	5.312
				16QAM	4.4936	5.320

**LTE Band 5**

Band	BW [MHz]	Channel	f [MHz]	Mode	99% BW [MHz]	26dB BW [MHz]
Band 5	10	20450	829.0	QPSK	8.9567	10.04
				16QAM	8.9662	10.17
		20524	836.5	QPSK	8.9562	10.11
				16QAM	8.9457	10.14
		20599	844.0	QPSK	8.9553	10.27
				16QAM	8.9797	10.26
	5	20425	826.5	QPSK	4.4941	5.293
				16QAM	4.4975	5.160
		20524	836.5	QPSK	4.4933	5.235
				16QAM	4.4929	5.190
		20624	846.5	QPSK	4.5022	5.242
				16QAM	4.5022	5.272
	3	20415	825.5	QPSK	2.6952	3.049
				16QAM	2.6956	3.055
		20524	836.5	QPSK	2.7023	3.052
				16QAM	2.6947	3.076
		20634	847.5	QPSK	2.7016	3.089
				16QAM	2.7022	3.090
	1.4	20407	824.7	QPSK	1.0908	1.352
				16QAM	1.0892	1.412
		20524	836.5	QPSK	1.0889	1.370
				16QAM	1.0925	1.360
		20624	848.3	QPSK	1.0888	1.379
				16QAM	1.0920	1.332

**LTE Band 4**

Band	BW [MHz]	Channel	f [MHz]	Mode	99% BW [MHz]	26dB BW [MHz]
Band 4	20	20050	1720.0	QPSK	17.864	19.57
				16QAM	17.874	19.68
		20174	1732.5	QPSK	17.893	19.72
				16QAM	17.847	19.81
		20299	1745.0	QPSK	17.889	19.72
				16QAM	17.914	19.57
	15	20025	1717.5	QPSK	13.466	15.09
				16QAM	13.416	15.04
		20174	1732.5	QPSK	13.444	15.05
				16QAM	13.448	15.21
		20324	1747.5	QPSK	13.456	15.07
				16QAM	13.462	14.94
	10	20000	1715.0	QPSK	8.9902	10.29
				16QAM	8.9746	10.20
		20174	1732.5	QPSK	8.9600	10.16
				16QAM	8.9651	10.08
		20349	1750.0	QPSK	8.9510	10.12
				16QAM	8.9711	10.25
	5	19975	1712.5	QPSK	4.5026	5.257
				16QAM	4.5016	5.189
		20174	1732.5	QPSK	4.5010	5.270
				16QAM	4.4993	5.122
		20374	1752.5	QPSK	4.5055	5.253
				16QAM	4.5048	5.348
	3	19965	1711.5	QPSK	2.7004	3.072
				16QAM	2.6968	3.064
		20174	1732.5	QPSK	2.7047	3.085
				16QAM	2.6968	3.067
		20384	1753.5	QPSK	2.7011	3.071
				16QAM	2.7051	3.062
1.4	19957	1710.7	QPSK	1.0945	1.361	
			16QAM	1.0950	1.377	
	20174	1732.5	QPSK	1.0929	1.362	
			16QAM	1.0919	1.380	
	20392	1754.3	QPSK	1.0876	1.351	
			16QAM	1.0930	1.391	

**LTE Band 2**

Band	BW [MHz]	Channel	f [MHz]	Mode	99% BW [MHz]	26dB BW [MHz]
Band 2	20	18700	1860.0	QPSK	17.883	19.76
				16QAM	17.894	19.66
		18900	1880.0	QPSK	17.849	19.62
				16QAM	17.871	19.67
		19099	1900.0	QPSK	17.930	19.53
				16QAM	17.878	19.49
	15	18675	1857.5	QPSK	13.457	15.01
				16QAM	13.449	15.16
		18900	1880.0	QPSK	13.453	15.17
				16QAM	13.452	14.83
		19124	1902.5	QPSK	13.431	15.08
				16QAM	13.415	14.99
	10	18650	1955.0	QPSK	8.9681	10.19
				16QAM	8.9640	10.24
		18900	1880.0	QPSK	8.9656	10.12
				16QAM	8.9712	10.15
		19149	1905.0	QPSK	8.9447	10.06
				16QAM	8.9587	10.20
	5	18625	1852.5	QPSK	4.5056	5.182
				16QAM	4.5089	5.215
		18900	1880.0	QPSK	4.5032	5.300
				16QAM	4.5065	5.259
		18175	1907.5	QPSK	4.5053	5.217
				16QAM	4.5070	5.265
	3	18615	1815.5	QPSK	2.6969	3.081
				16QAM	2.6977	3.071
		18900	1880.0	QPSK	2.6984	3.111
				16QAM	2.7014	3.088
		19184	1908.5	QPSK	2.7002	3.067
				16QAM	2.7052	3.117
1.4	18607	1850.7	QPSK	1.0915	1.373	
			16QAM	1.0913	1.397	
	18900	1880.0	QPSK	1.0932	1.398	
			16QAM	1.0874	1.349	
	19192	1909.3	QPSK	1.0911	1.365	
			16QAM	1.0921	1.373	

### 9.1.2. OCCUPIED BANDWIDTH PLOTS

#### GSM 850



**GSM 1900**



**WCDMA Band 5**

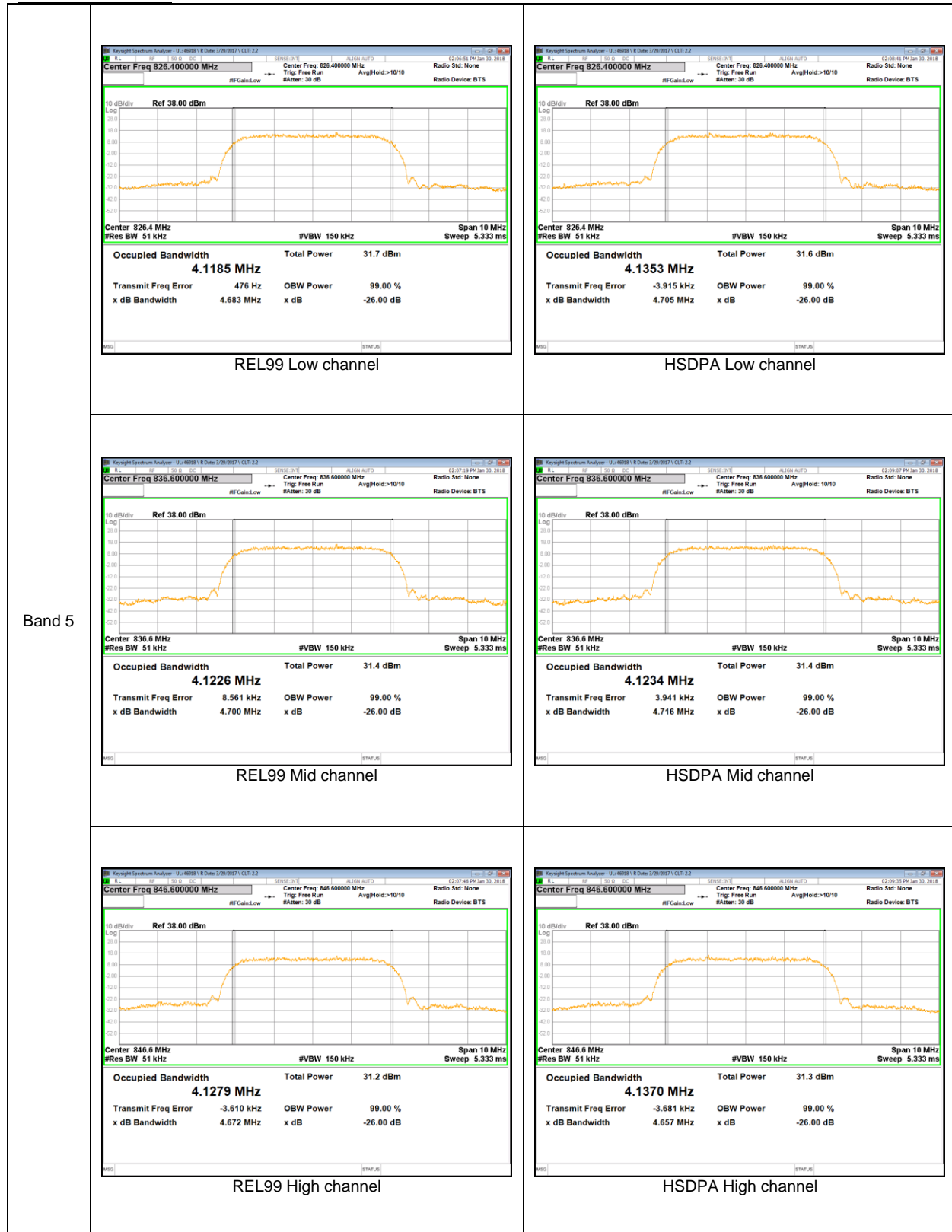

**WCDMA Band 4**

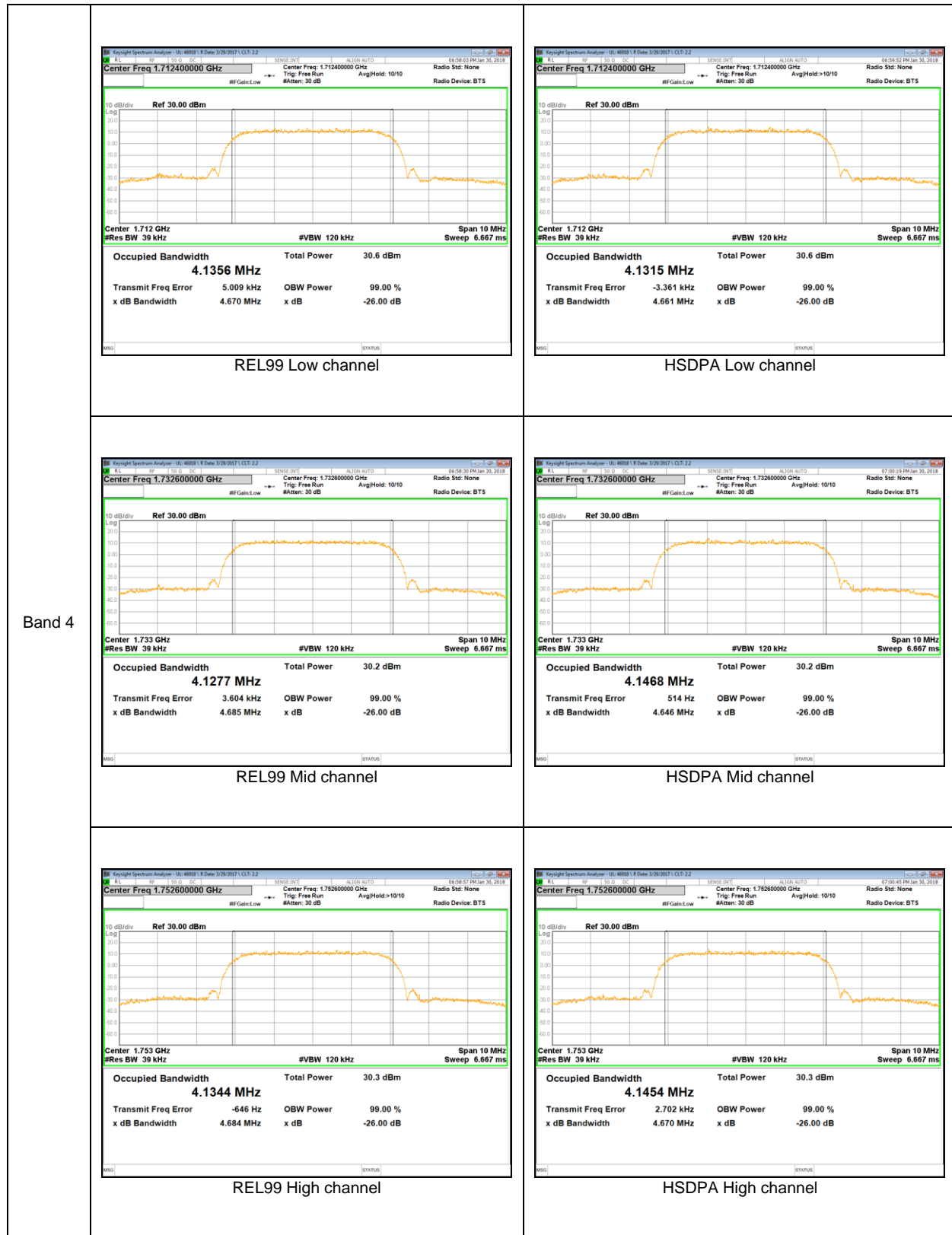

**WCDMA Band 2**

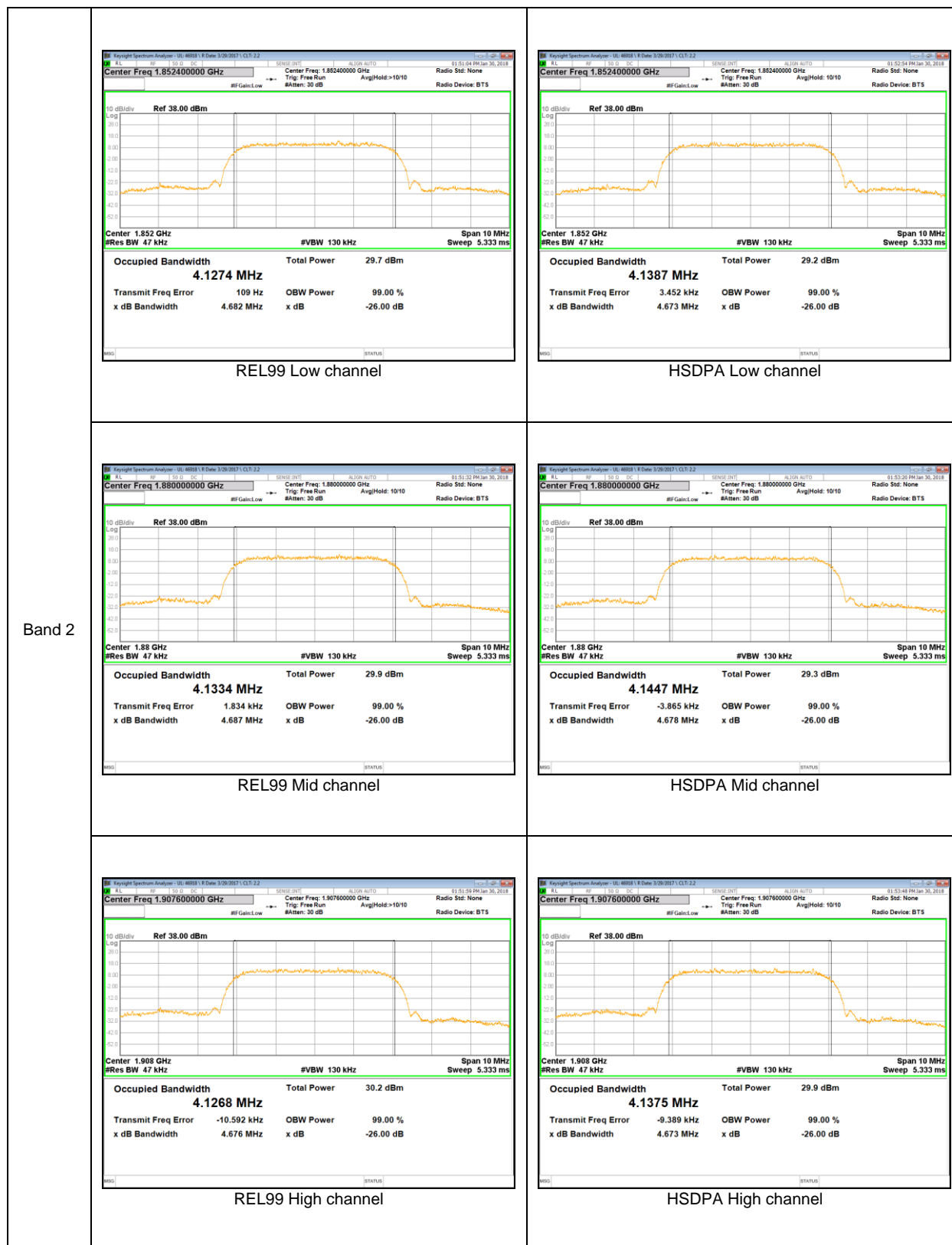

**LTE Band 17**

