



FCC CFR47 PART 15 SUBPART C

Bluetooth Low Energy

CERTIFICATION TEST REPORT

FOR

GSM/WCDMA/LTE Phone + BT/BLE, DTS/UNII a/b/g/n/ac, ANT+ and NFC

MODEL NUMBER : SM-A505GN/DS, SM-A505GN

FCC ID: A3LSMA505GN

REPORT NUMBER: 4788805413-E3V2

ISSUE DATE: FEB 11, 2019

Prepared for
SAMSUNG ELECTRONICS CO., LTD.
129 SAMSUNG-RO, YEONGTONG-GU, SUWON-SI,
GYEONGGI-DO, 16677, KOREA

Prepared by
UL Korea, Ltd.
26th floor, 152, Teheran-ro, Gangnam-gu Seoul, 06236, Korea

Suwon Test Site: UL Korea, Ltd. Suwon Laboratory
218 Maeyeong-ro, Yeongtong-gu,
Suwon-si, Gyeonggi-do, 16675, Korea
TEL: (031) 337-9902
FAX: (031) 213-5433



Testing
Laboratory

TL-637

Revision History

<u>Rev.</u>	<u>Issue Date</u>	<u>Revisions</u>	<u>Revised By</u>
V1	02/08/19	Initial issue	Hoonpyo Lee
V2	02/11/19	Updated to address TCB's question	Hoonpyo Lee

TABLE OF CONTENTS

1. ATTESTATION OF TEST RESULTS	5
1.1. INTRODUCTION OF TEST DATA REUSE	6
1.2. DIFFERENCE	6
1.3. SPOT CHECK VERIFICATION DATA.....	6
1.4. REFERENCE DETAIL.....	7
2. TEST METHODOLOGY	8
3. FACILITIES AND ACCREDITATION	8
4. CALIBRATION AND UNCERTAINTY	8
4.1. MEASURING INSTRUMENT CALIBRATION.....	8
4.2. SAMPLE CALCULATION.....	8
4.3. MEASUREMENT UNCERTAINTY	9
5. EQUIPMENT UNDER TEST	10
5.1. DESCRIPTION OF EUT.....	10
5.2. MAXIMUM OUTPUT POWER.....	10
5.3. DESCRIPTION OF AVAILABLE ANTENNAS	10
5.4. WORST-CASE CONFIGURATION AND MODE	11
5.5. DESCRIPTION OF TEST SETUP.....	12
6. TEST AND MEASUREMENT EQUIPMENT	14
7. REFERENCE MEASUREMENT RESULTS.....	15
7.1. ON TIME AND DUTY CYCLE RESULTS.....	15
7.2. 99% BANDWIDTH	16
8. MEASUREMENT METHODS	19
9. SUMMARY TABLE	20
10. ANTENNA PORT TEST RESULTS	21
10.1. 6 dB BANDWIDTH.....	21
10.2. OUTPUT POWER.....	24
10.3. AVERAGE POWER.....	27
10.4. PSD.....	28
10.5. OUT-OF-BAND EMISSIONS	31
11. RADIATED TEST RESULTS.....	38

11.1. LIMITS AND PROCEDURE	38
11.2. TRANSMITTER ABOVE 1 GHz	40
11.2.1. 1Mbps MODE	40
11.2.2. 2Mbps MODE	50
11.3. WORST-CASE BELOW 1 GHz.....	60
12. AC POWER LINE CONDUCTED EMISSIONS	64
13. SETUP PHOTOS.....	69

1. ATTESTATION OF TEST RESULTS

COMPANY NAME: SAMSUNG ELECTRONICS CO., LTD.

EUT DESCRIPTION: GSM/WCDMA/LTE Phone + BT/BLE, DTS/UNII a/b/g/n/ac, ANT+ and NFC

MODEL NUMBER: SM-A505GN/DS, SM-A505GN

SERIAL NUMBER: R38KB0HB4SW (RADIATED, Original);
R38KB0HB5BP (CONDUCTED, Original)
R38M102D04M (RADIATED, Spot check)

DATE TESTED: JAN 09, 2019 - JAN 28, 2019 (Original)
JAN 22, 2019 – JAN 31, 2019 (Spot check)

APPLICABLE STANDARDS	
STANDARD	TEST RESULTS
CFR 47 Part 15 Subpart C	Pass

UL Korea, Ltd. tested the above equipment in accordance with the requirements set forth in the above standards. All indications of Pass/Fail in this report are opinions expressed by UL Korea, Ltd. based on interpretations and/or observations of test results. Measurement Uncertainties were not taken into account and are published for informational purposes only. The test results show that the equipment tested is capable of demonstrating compliance with the requirements as documented in this report.

Note: The results documented in this report apply only to the tested sample, under the conditions and modes of operation as described herein. This document JUN not be altered or revised in any way unless done so by UL Korea, Ltd. and all revisions are duly noted in the revisions section. Any alteration of this document not carried out by UL Korea, Ltd. will constitute fraud and shall nullify the document. This report must not be used by the client to claim product certification, approval, or endorsement by IAS, any agency of the Federal Government, or any agency of any government.

Approved & Released For
UL Korea, Ltd. By:

Tested By:



SungGil Park
Suwon Lab Engineer
UL Korea, Ltd.

Hoonpyo Lee
Suwon Lab Engineer
UL Korea, Ltd.

1.1. INTRODUCTION OF TEST DATA REUSE

This report referenced from the FCC ID: A3LSMA505F DTS BLE(FCC CFR 47 Part 15). And the applicant takes full responsibility that the test data as referenced in this report represent compliance for this FCC ID.

1.2. DIFFERENCE

The FCC ID: A3LSMA505GN shares the same enclosure and circuit board as FCC ID: A3LSMA505F. The BLE antennas and surrounding circuitry and layout are identical between these two units for re-used bands.

After confirming through preliminary radiated emissions that the performance of the FCC ID: A3LSMA505F remains representative of FCC ID: A3LSMA505GN. The test data of FCC ID: A3LSMA505F being submitted for this application to cover BLE features.

1.3. SPOT CHECK VERIFICATION DATA

Band	Test Item	Mode	Frequency	Test Limit	Original model	Spot check model	Deviation	Remark
					SM-A505F/DS	SM-A505GN/DS		
					FCC ID : A3LSMA505F	FCC ID : A3LSMA505GN		
DTS BLE (2.4GHz)	Band Edge	2Mbps	2480 MHz	54 dBuV/m	45.47 dBuV/m	46.26 dBuV/m	0.79 dB	
	RSE	2Mbps	2440 MHz	74 dBuV/m	40.57 dBuV/m	40.05 dBuV/m	-0.52 dB	Noise Floor

Comparison of two models, upper deviation is within 3dB range and all test results are under FCC Technical Limits. Output power verification was performed for the spot check model, all conducted power test results were in the tune up tolerance range. Also deviation for maximum output power result is within upper 0.5dB range.

1.4. REFERENCE DETAIL

Reference application that contains the reused reference data.

Equipment Class	Reference FCC ID	Type Grant/Permissive Change	Reference Application	Folder Test/RF Exposure	Report Title / Section
PCE	A3LSMA505F	Grant	4788805451-E1	Test	FCC Report WWAN / All sections
DTS	A3LSMA505F	Grant	4788805451-E2	Test	FCC Report DTS WLAN / All sections
			4788805451-E3	Test	FCC Report BLE All sections
DSS	A3LSMA505F	Grant	4788805451-E4	Test	FCC Report BT / All sections
NII	A3LSMA505F	Grant	4788805451-E5	Test	FCC Report UNII WLAN / All sections
DXX	A3LSMA505F	Grant	4788805451-E6	Test	FCC Report ANT+ / All sections

2. TEST METHODOLOGY

The tests documented in this report were performed in accordance with following methods.

1. FCC CFR 47 Part 2.
2. FCC CFR 47 Part 15.
3. KDB 558074 D01 15.247 Meas Guidance v05.
4. KDB 484596 D01 v01
5. ANSI C63.10-2013.

3. FACILITIES AND ACCREDITATION

The test sites and measurement facilities used to collect data are located at 218 Maeyeong-ro, Yeongtong-gu, Suwon-si, Gyeonggi-do, 16675, Korea. Line conducted emissions are measured only at the 218 address. The following table identifies which facilities were utilized for radiated emission measurements documented in this report. Specific facilities are also identified in the test results sections.

218 Maeyeong-ro	
<input checked="" type="checkbox"/>	Chamber 1
<input checked="" type="checkbox"/>	Chamber 2
<input type="checkbox"/>	Chamber 3

UL Korea, Ltd. is accredited by IAS, Laboratory Code TL-637. The full scope of accreditation can be viewed at <http://www.iasonline.org/PDF/TL/TL-637.pdf>.

4. CALIBRATION AND UNCERTAINTY

4.1. MEASURING INSTRUMENT CALIBRATION

The measuring equipment utilized to perform the tests documented in this report has been calibrated in accordance with the manufacturer's recommendations, and is traceable to recognized national standards.

4.2. SAMPLE CALCULATION

Where relevant, the following sample calculation is provided:

$$\begin{aligned} \text{Field Strength (dBuV/m)} &= \text{Measured Voltage (dBuV)} + \text{Antenna Factor (dB/m)} + \\ &\text{Cable Loss (dB)} - \text{Preamp Gain (dB)} \\ 36.5 \text{ dBuV} + 18.7 \text{ dB/m} + 0.6 \text{ dB} - 26.9 \text{ dB} &= 28.9 \text{ dBuV/m} \end{aligned}$$

4.3. MEASUREMENT UNCERTAINTY

Where relevant, the following measurement uncertainty levels have been estimated for tests performed on the apparatus:

PARAMETER	UNCERTAINTY
Conducted Disturbance, 0.15 to 30 MHz	2.32 dB
Radiated Disturbance, Below 1GHz	3.86 dB
Radiated Disturbance, Above 1 GHz	5.97 dB

Uncertainty figures are valid to a confidence level of 95%.

5. EQUIPMENT UNDER TEST

5.1. DESCRIPTION OF EUT

The EUT is a GSM/WCDMA/LTE Phone + BT/BLE, DTS/UNII a/b/g/n/ac, ANT+ and NFC. This test report addresses the DTS (BLE) operational mode.

5.2. MAXIMUM OUTPUT POWER

The transmitter has a maximum total conducted output power as follows:

Frequency Range [MHz]	Mode	Power Mode	Output Power [dBm]	Output Power [mW]
2402 - 2480	1Mbps	Peak	6.721	4.70
		Average	6.475	4.44
	2Mbps	Peak	6.739	4.72
		Average	6.327	4.29

5.3. DESCRIPTION OF AVAILABLE ANTENNAS

The radio utilizes an internal antenna, with a maximum gain of -2.11 dBi.

5.4. WORST-CASE CONFIGURATION AND MODE

Radiated emission below 1GHz and power line conducted emission were performed with the EUT set to transmit at the channel with highest output power as worst-case scenario.

Radiated emission above 1GHz was performed with the EUT set to transmit low/mid/high channels.

The fundamental of the EUT was investigated in three orthogonal orientations X, Y and Z it was determined that Y orientation was worst-case orientation; therefore, all final radiated testing was performed with the EUT in Y orientation.

Note : All radiated and power line conducted tests were performed connected with earphone and charger for evaluation of worst case mode.

Power verification

The Output Power of all data rate are all investigated, the 1Mbps(255 pkt) and 2Mbps(255 pkt) power is the worst case for symbol rate. All tests were performed in these two modes.

Symbol Rate [Ms/s]	Mode	Frequency [MHz]	Conducted Burst Avg (dBm)	Symbol Rate [Ms/s]	Mode	Frequency [MHz]	Conducted Burst Avg (dBm)
1	1Mbps (37 pkt)	2402	6.229	2	2Mbps (37 pkt)	2402	6.065
		2440	6.438			2440	6.273
		2480	5.588			2480	5.417
	1Mbps (255 pkt)	2402	6.296		2Mbps (255 pkt)	2402	6.148
		2440	6.475			2440	6.327
		2480	5.616			2480	5.463

5.5. DESCRIPTION OF TEST SETUP

SUPPORT EQUIPMENT

Support Equipment List				
Description	Manufacturer	Model	Serial Number	FCC ID
Charger	SAMSUNG	EP-TA200	R37KC3B01G0RC3	N/A
Data Cable	SAMSUNG	EP-D140AWE	N/A	N/A
Earphone	SAMSUNG	EHS61ASFWE	N/A	N/A

I/O CABLES

I/O Cable List						
Cable No	Port	# of identical ports	Connector Type	Cable Type	Cable Length (m)	Remarks
1	DC Power	1	Mini-USB	Shielded	1.2m	N/A
2	Audio	2	Mini-Jack	Unshielded	1.2m	N/A

TEST SETUP

The EUT is a stand-alone unit during the tests.
 Test software in hidden menu exercised the EUT to enable BLE mode.

SETUP DIAGRAM FOR TESTS (CONDUCTED TEST SETUP)

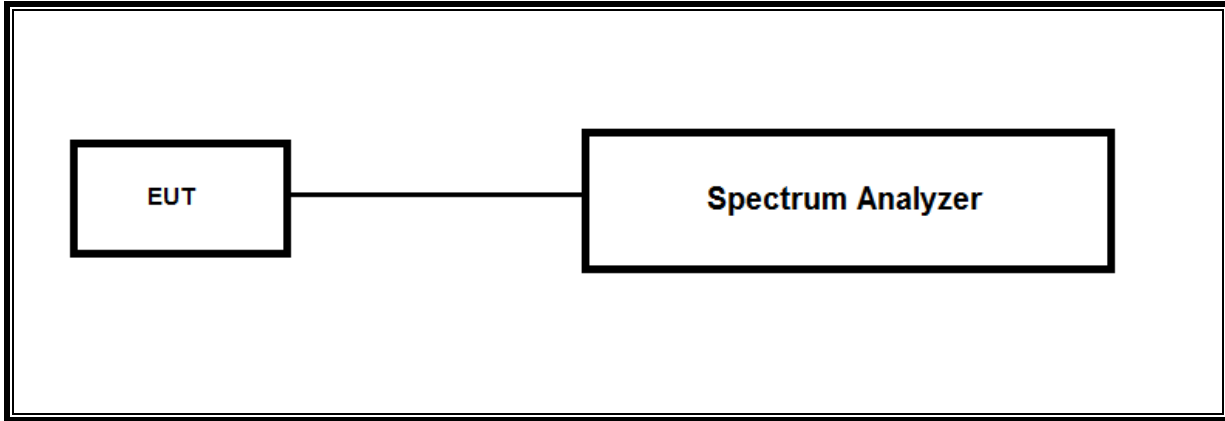

SETUP DIAGRAM FOR TESTS (RADIATED TEST SETUP)

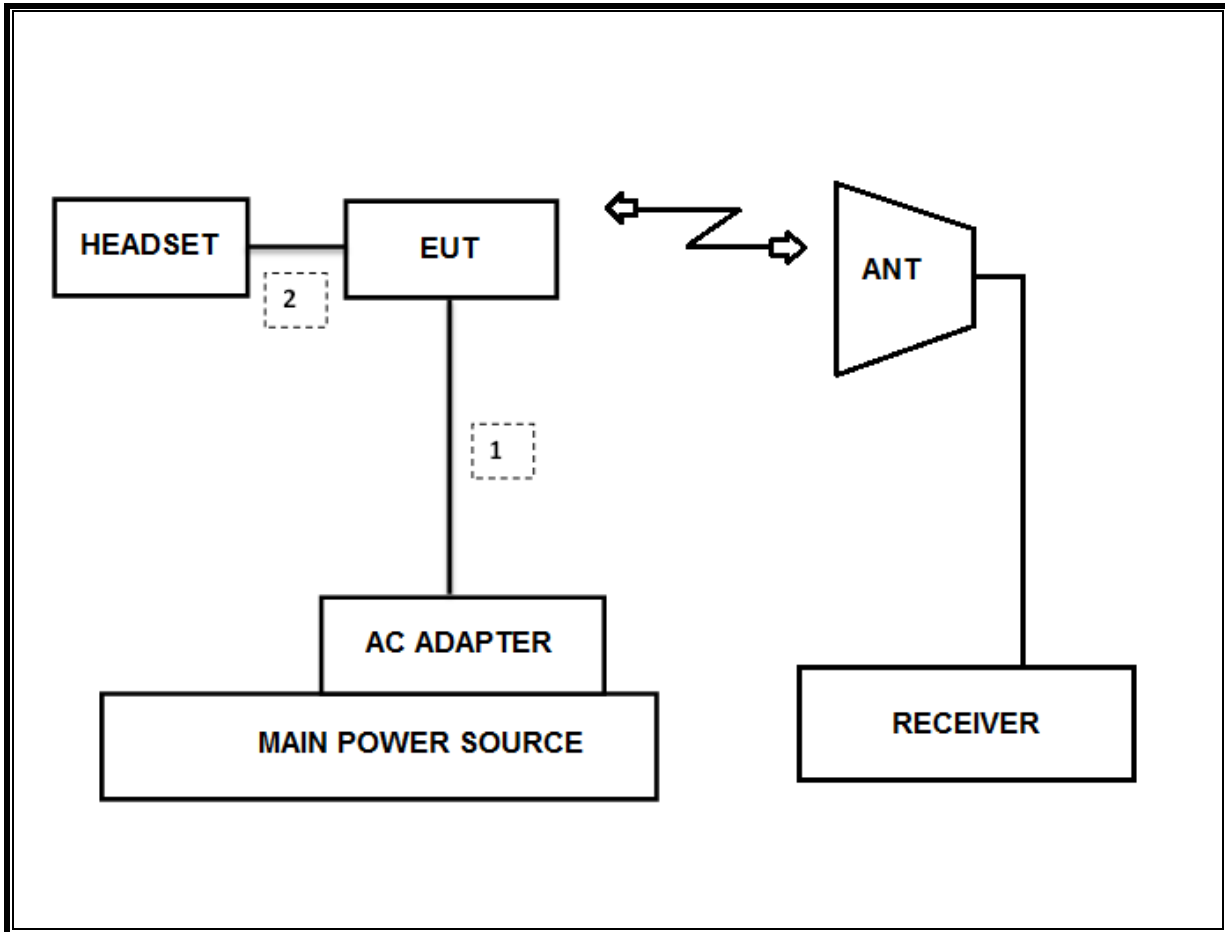

6. TEST AND MEASUREMENT EQUIPMENT

The following test and measurement equipment was utilized for the tests documented in this report:

Test Equipment List				
Description	Manufacturer	Model	S/N	Cal Due
Antenna, Bilog, 30MHz-1GHz	SCHWARZBECK	VULB9163	750	08-04-20
Antenna, Bilog, 30MHz-1GHz	SCHWARZBECK	VULB9163	749	08-04-20
Antenna, Bilog, 30MHz-1GHz	SCHWARZBECK	VULB9163	845	08-04-20
Antenna, Horn, 18 GHz	ETS	3115	00167211	08-04-20
Antenna, Horn, 18 GHz	ETS	3115	00161451	08-04-20
Antenna, Horn, 18 GHz	ETS	3117	00168724	08-04-20
Antenna, Horn, 18 GHz	ETS	3117	00168717	08-04-20
Antenna, Horn, 18 GHz	ETS	3117	00205959	08-04-20
Antenna, Horn, 40 GHz	ETS	3116C	00166155	12-04-19
Antenna, Horn, 40 GHz	ETS	3116C	00168645	08-09-19
Antenna, Horn, 40 GHz	ETS	3116C-PA	00168841	08-07-19
Preamplifier, 1000 MHz	Sonoma	310N	341282	08-07-19
Preamplifier, 1000 MHz	Sonoma	310N	351741	08-06-19
Preamplifier, 1000 MHz	Sonoma	310N	370599	08-07-19
Preamplifier, 18 GHz	Miteq	AFS42-00101800-25-S-42	1876511	08-07-19
Preamplifier, 18 GHz	Miteq	AFS42-00101800-25-S-42	1896138	08-07-19
Preamplifier, 18 GHz	Miteq	AFS42-00101800-25-S-42	2029169	08-07-19
Spectrum Analyzer, 44 GHz	Agilent / HP	N9030A	MY54170614	08-06-19
Spectrum Analyzer, 44 GHz	Agilent / HP	N9030A	MY54490312	08-06-19
Average Power Sensor	Agilent / HP	U2000	MY54270007	08-07-19
Attenuator	PASTERNAK	PE7087-10	A001	08-08-19
Attenuator	PASTERNAK	PE7087-10	A008	08-08-19
Attenuator	PASTERNAK	PE7087-10	2	08-07-19
EMI Test Receive, 40 GHz	R&S	ESU40	100439	08-06-19
EMI Test Receive, 40 GHz	R&S	ESU40	100457	08-06-19
EMI Test Receive, 44 GHz	R&S	ESW44	101590	08-06-19
EMI Test Receive, 3 GHz	R&S	ESR3	101832	08-06-19
Low Pass Filter 5GHz	Micro-Tronics	LPS17541	009	08-07-19
Low Pass Filter 5GHz	Micro-Tronics	LPS17541	015	08-07-19
Low Pass Filter 5GHz	Micro-Tronics	LPS17541	020	08-06-19
High Pass Filter 3GHz	Micro-Tronics	HPM17543	010	08-07-19
High Pass Filter 3GHz	Micro-Tronics	HPM17543	015	08-07-19
High Pass Filter 3GHz	Micro-Tronics	HPM17543	020	08-06-19
High Pass Filter 6GHz	Micro-Tronics	HPS17542	009	08-07-19
High Pass Filter 6GHz	Micro-Tronics	HPS17542	016	08-07-19
High Pass Filter 6GHz	Micro-Tronics	HPS17542	021	08-06-19
Antenna, Loop, 9kHz-30MHz	R&S	HFH2-Z2	100418	10-26-19
LISN	R&S	ENV-216	101837	08-09-19
UL Software				
Description	Manufacturer	Model	Version	
Radiated software	UL	UL EMC	Ver 9.5	
AC Line Conducted software	UL	UL EMC	Ver 9.5	

7. REFERENCE MEASUREMENT RESULTS

7.1. ON TIME AND DUTY CYCLE RESULTS

LIMITS

None: for reporting purposes only.

Mode	ON Time B [msec]	Period [msec]	Duty Cycle x [linear]	Duty Cycle [%]	Duty Cycle Correction Factor [dB]	1/T Minimum VBW [kHz]
2400MHz Bands						
BLE 1M	2.127	2.500	0.851	85.1%	0.70	0.470
BLE 2M	1.070	1.875	0.571	57.1%	2.44	0.935



7.2. 99% BANDWIDTH

LIMITS

None; for reporting purposes only.

TEST PROCEDURE

The transmitter output is connected to the spectrum analyzer. The RBW is set to 1% to 3% of the 99 % bandwidth and to 1% of the span. The VBW is set to ≥ 3 times the RBW. The spectrum analyzer internal 99% bandwidth function is utilized.

RESULTS

- 1Mbps

Channel	Frequency [MHz]	99% Bandwidth [MHz]
Low	2402	1.040
Mid	2440	1.042
High	2480	1.046
Worst		1.046

- 2Mbps

Channel	Frequency [MHz]	99% Bandwidth [MHz]
Low	2402	2.054
Mid	2440	2.063
High	2480	2.060
Worst		2.063

99% BANDWIDTH PLOTS

- 1Mbps

<p>Low CH</p>	<p>KeySight Spectrum Analyzer - Occupied BW Center Freq: 2.402000000 GHz Trig: Free Run #Atten: 30 dB Radio Std: None Radio Device: BTS</p> <p>10 dB/div Ref 20.00 dBm</p> <p>Center 2.402 GHz #Res BW 30 kHz VBW 300 kHz Span 3 MHz #Sweep 100 ms</p> <table border="1"> <tr> <td>Occupied Bandwidth</td> <td>Total Power</td> <td>5.51 dBm</td> </tr> <tr> <td>1.0395 MHz</td> <td></td> <td></td> </tr> <tr> <td>Transmit Freq Error</td> <td>2.962 kHz</td> <td>OBW Power</td> </tr> <tr> <td>x dB Bandwidth</td> <td>642.9 kHz</td> <td>x dB</td> </tr> <tr> <td></td> <td></td> <td>99.00 %</td> </tr> <tr> <td></td> <td></td> <td>-6.00 dB</td> </tr> </table>	Occupied Bandwidth	Total Power	5.51 dBm	1.0395 MHz			Transmit Freq Error	2.962 kHz	OBW Power	x dB Bandwidth	642.9 kHz	x dB			99.00 %			-6.00 dB
Occupied Bandwidth	Total Power	5.51 dBm																	
1.0395 MHz																			
Transmit Freq Error	2.962 kHz	OBW Power																	
x dB Bandwidth	642.9 kHz	x dB																	
		99.00 %																	
		-6.00 dB																	
<p>Middle CH</p>	<p>KeySight Spectrum Analyzer - Occupied BW Center Freq: 2.440000000 GHz Trig: Free Run #Atten: 30 dB Radio Std: None Radio Device: BTS</p> <p>10 dB/div Ref 20.00 dBm</p> <p>Center 2.44 GHz #Res BW 30 kHz VBW 300 kHz Span 3 MHz #Sweep 100 ms</p> <table border="1"> <tr> <td>Occupied Bandwidth</td> <td>Total Power</td> <td>5.75 dBm</td> </tr> <tr> <td>1.0417 MHz</td> <td></td> <td></td> </tr> <tr> <td>Transmit Freq Error</td> <td>4.806 kHz</td> <td>OBW Power</td> </tr> <tr> <td>x dB Bandwidth</td> <td>611.8 kHz</td> <td>x dB</td> </tr> <tr> <td></td> <td></td> <td>99.00 %</td> </tr> <tr> <td></td> <td></td> <td>-6.00 dB</td> </tr> </table>	Occupied Bandwidth	Total Power	5.75 dBm	1.0417 MHz			Transmit Freq Error	4.806 kHz	OBW Power	x dB Bandwidth	611.8 kHz	x dB			99.00 %			-6.00 dB
Occupied Bandwidth	Total Power	5.75 dBm																	
1.0417 MHz																			
Transmit Freq Error	4.806 kHz	OBW Power																	
x dB Bandwidth	611.8 kHz	x dB																	
		99.00 %																	
		-6.00 dB																	
<p>High CH</p>	<p>KeySight Spectrum Analyzer - Occupied BW Center Freq: 2.480000000 GHz Trig: Free Run #Atten: 30 dB Radio Std: None Radio Device: BTS</p> <p>10 dB/div Ref 20.00 dBm</p> <p>Center 2.48 GHz #Res BW 30 kHz VBW 300 kHz Span 3 MHz #Sweep 100 ms</p> <table border="1"> <tr> <td>Occupied Bandwidth</td> <td>Total Power</td> <td>4.75 dBm</td> </tr> <tr> <td>1.0464 MHz</td> <td></td> <td></td> </tr> <tr> <td>Transmit Freq Error</td> <td>-1.658 kHz</td> <td>OBW Power</td> </tr> <tr> <td>x dB Bandwidth</td> <td>627.0 kHz</td> <td>x dB</td> </tr> <tr> <td></td> <td></td> <td>99.00 %</td> </tr> <tr> <td></td> <td></td> <td>-6.00 dB</td> </tr> </table>	Occupied Bandwidth	Total Power	4.75 dBm	1.0464 MHz			Transmit Freq Error	-1.658 kHz	OBW Power	x dB Bandwidth	627.0 kHz	x dB			99.00 %			-6.00 dB
Occupied Bandwidth	Total Power	4.75 dBm																	
1.0464 MHz																			
Transmit Freq Error	-1.658 kHz	OBW Power																	
x dB Bandwidth	627.0 kHz	x dB																	
		99.00 %																	
		-6.00 dB																	

- 2Mbps

<p>Low CH</p>	<p>KeySight Spectrum Analyzer - Occupied BW Center Freq: 2.40200000 GHz Trig: Free Run #Attenu: 30 dB Radio Std: None Radio Device: BTS</p> <p>10 dB/div Ref 20.00 dBm Log</p> <p>Center 2.402 GHz Span 5 MHz #Res BW 30 kHz VBW 300 kHz #Sweep 100 ms</p> <table border="1"> <tr> <td>Occupied Bandwidth</td> <td>Total Power</td> <td>3.90 dBm</td> </tr> <tr> <td>2.0540 MHz</td> <td></td> <td></td> </tr> <tr> <td>Transmit Freq Error</td> <td>OBW Power</td> <td>99.00 %</td> </tr> <tr> <td>15.024 kHz</td> <td></td> <td></td> </tr> <tr> <td>x dB Bandwidth</td> <td>x dB</td> <td>-6.00 dB</td> </tr> <tr> <td>1.109 MHz</td> <td></td> <td></td> </tr> </table>	Occupied Bandwidth	Total Power	3.90 dBm	2.0540 MHz			Transmit Freq Error	OBW Power	99.00 %	15.024 kHz			x dB Bandwidth	x dB	-6.00 dB	1.109 MHz		
Occupied Bandwidth	Total Power	3.90 dBm																	
2.0540 MHz																			
Transmit Freq Error	OBW Power	99.00 %																	
15.024 kHz																			
x dB Bandwidth	x dB	-6.00 dB																	
1.109 MHz																			
<p>Middle CH</p>	<p>KeySight Spectrum Analyzer - Occupied BW Center Freq: 2.44000000 GHz Trig: Free Run #Attenu: 30 dB Radio Std: None Radio Device: BTS</p> <p>10 dB/div Ref 20.00 dBm Log</p> <p>Center 2.44 GHz Span 5 MHz #Res BW 30 kHz VBW 300 kHz #Sweep 100 ms</p> <table border="1"> <tr> <td>Occupied Bandwidth</td> <td>Total Power</td> <td>4.14 dBm</td> </tr> <tr> <td>2.0630 MHz</td> <td></td> <td></td> </tr> <tr> <td>Transmit Freq Error</td> <td>OBW Power</td> <td>99.00 %</td> </tr> <tr> <td>13.894 kHz</td> <td></td> <td></td> </tr> <tr> <td>x dB Bandwidth</td> <td>x dB</td> <td>-6.00 dB</td> </tr> <tr> <td>1.216 MHz</td> <td></td> <td></td> </tr> </table>	Occupied Bandwidth	Total Power	4.14 dBm	2.0630 MHz			Transmit Freq Error	OBW Power	99.00 %	13.894 kHz			x dB Bandwidth	x dB	-6.00 dB	1.216 MHz		
Occupied Bandwidth	Total Power	4.14 dBm																	
2.0630 MHz																			
Transmit Freq Error	OBW Power	99.00 %																	
13.894 kHz																			
x dB Bandwidth	x dB	-6.00 dB																	
1.216 MHz																			
<p>High CH</p>	<p>KeySight Spectrum Analyzer - Occupied BW Center Freq: 2.48000000 GHz Trig: Free Run #Attenu: 30 dB Radio Std: None Radio Device: BTS</p> <p>10 dB/div Ref 20.00 dBm Log</p> <p>Center 2.48 GHz Span 5 MHz #Res BW 30 kHz VBW 300 kHz #Sweep 100 ms</p> <table border="1"> <tr> <td>Occupied Bandwidth</td> <td>Total Power</td> <td>3.19 dBm</td> </tr> <tr> <td>2.0599 MHz</td> <td></td> <td></td> </tr> <tr> <td>Transmit Freq Error</td> <td>OBW Power</td> <td>99.00 %</td> </tr> <tr> <td>8.512 kHz</td> <td></td> <td></td> </tr> <tr> <td>x dB Bandwidth</td> <td>x dB</td> <td>-6.00 dB</td> </tr> <tr> <td>1.203 MHz</td> <td></td> <td></td> </tr> </table>	Occupied Bandwidth	Total Power	3.19 dBm	2.0599 MHz			Transmit Freq Error	OBW Power	99.00 %	8.512 kHz			x dB Bandwidth	x dB	-6.00 dB	1.203 MHz		
Occupied Bandwidth	Total Power	3.19 dBm																	
2.0599 MHz																			
Transmit Freq Error	OBW Power	99.00 %																	
8.512 kHz																			
x dB Bandwidth	x dB	-6.00 dB																	
1.203 MHz																			

8. MEASUREMENT METHODS

6 dB BW : KDB 558074 D01 v05, Section 8.2.

OUTPUT POWER : KDB 558074 D01 v05, Section 8.3.2.3

POWER SPECTRAL DENSITY : KDB 558074 D01 v05, Section 8.4.

Out-of-band EMISSIONS (Conducted) : KDB 558074 D01 v05, Section 8.5.

Out-of-band EMISSIONS IN NON-RESTRICTED BANDS: KDB 558074 D01 v05, Section 8.5.

Out-of-band EMISSIONS IN RESTRICTED BANDS : KDB 558074 D01 v05, Section 8.6.

AC Power Line Conducted Emission : ANSI C63.10-2013, Section 6.2.

9. SUMMARY TABLE

FCC Part Section	Test Description	Test Limit	Test Condition	Test Result
15.247 (a)(2)	Occupied Band width (6dB)	>500KHz	Conducted	Pass
2.1051, 15.247 (d)	Band Edge / Conducted Spurious Emission	-20dBc		Pass
15.247 (b)(3)	TX conducted output power	<30dBm		Pass
15.247 (e)	PSD	<8dBm		Pass
15.207 (a)	AC Power Line conducted emissions	Section 10	Power Line conducted	Pass
15.205, 15.209	Radiated Spurious Emission	< 54dBuV/m(Av)	Radiated	Pass

10. ANTENNA PORT TEST RESULTS

10.1. 6 dB BANDWIDTH

LIMITS

FCC §15.247 (a) (2)

The minimum 6 dB bandwidth shall be at least 500 kHz.

TEST PROCEDURE

Reference to section 11.8 in ANSI C63.10(2013): The transmitter output is connected to a spectrum analyzer with the RBW set to 100kHz, the VBW $\geq 3 \times$ RBW, peak detector and max hold.

RESULTS

- 1Mbps

Channel	Frequency [MHz]	6 dB Bandwidth [kHz]	Minimum Limit [kHz]
Low	2402	668.63	500.0
Mid	2440	670.46	500.0
High	2480	672.90	500.0
Worst		668.63	500.0

- 2Mbps

Channel	Frequency [MHz]	6 dB Bandwidth [MHz]	Minimum Limit [kHz]
Low	2402	1.136	500.0
Mid	2440	1.160	500.0
High	2480	1.257	500.0
Worst		1.136	500.0

6 dB BANDWIDTH PLOTS

- 1Mbps

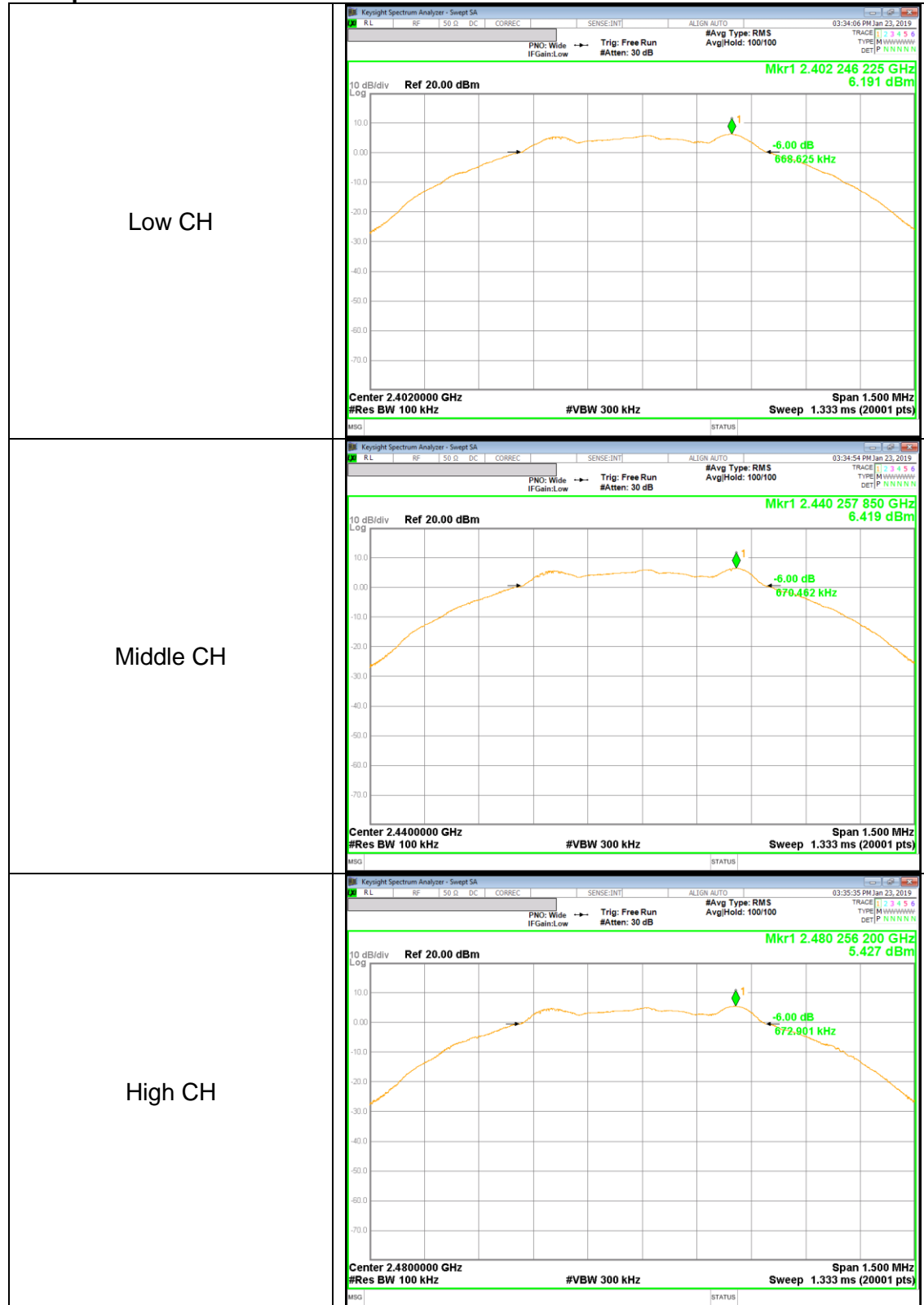

- 2Mbps



10.2. OUTPUT POWER

LIMITS

FCC §15.247 (b)

The maximum antenna gain is less than or equal to 6 dBi, therefore the limit is 30 dBm.

TEST PROCEDURE

Peak power is measured using ANSI C63.10(2013) under section 11.9.1.1 utilizing spectrum analyzer.

RESULTS

- 1Mbps

Channel	Frequency [MHz]	Peak Power Reading [dBm]	Limit [dBm]	Margin [dB]
Low	2402	6.536	30.000	-23.464
Mid	2440	6.721	30.000	-23.279
High	2480	5.933	30.000	-24.067
Worst		6.721	30.000	-23.279

- 2Mbps

Channel	Frequency [MHz]	Peak Power Reading [dBm]	Limit [dBm]	Margin [dB]
Low	2402	6.575	30.000	-23.425
Mid	2440	6.739	30.000	-23.261
High	2480	5.919	30.000	-24.081
Worst		6.739	30.000	-23.261

OUTPUT POWER PLOTS

- 1Mbps

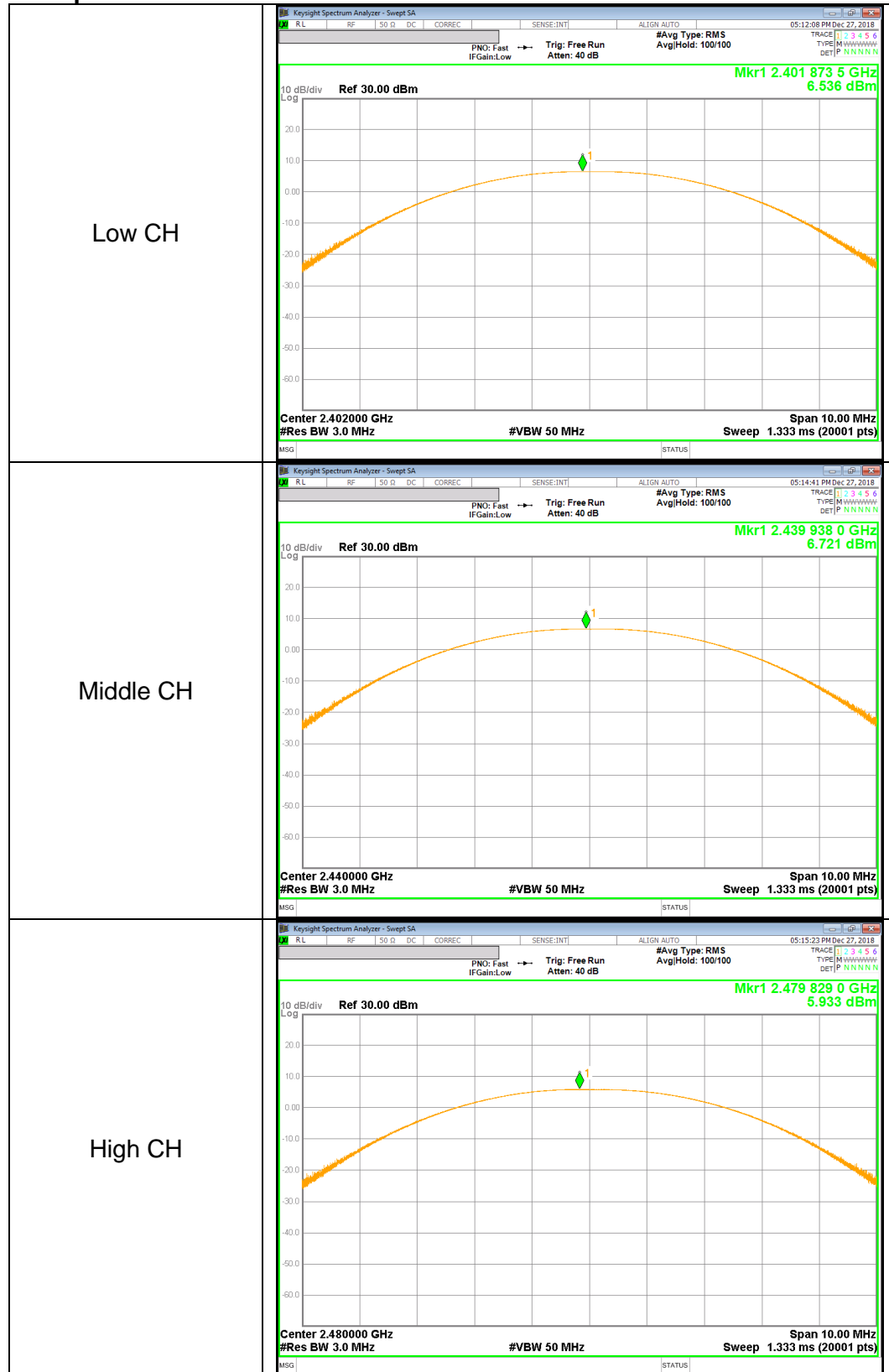

- 2Mbps

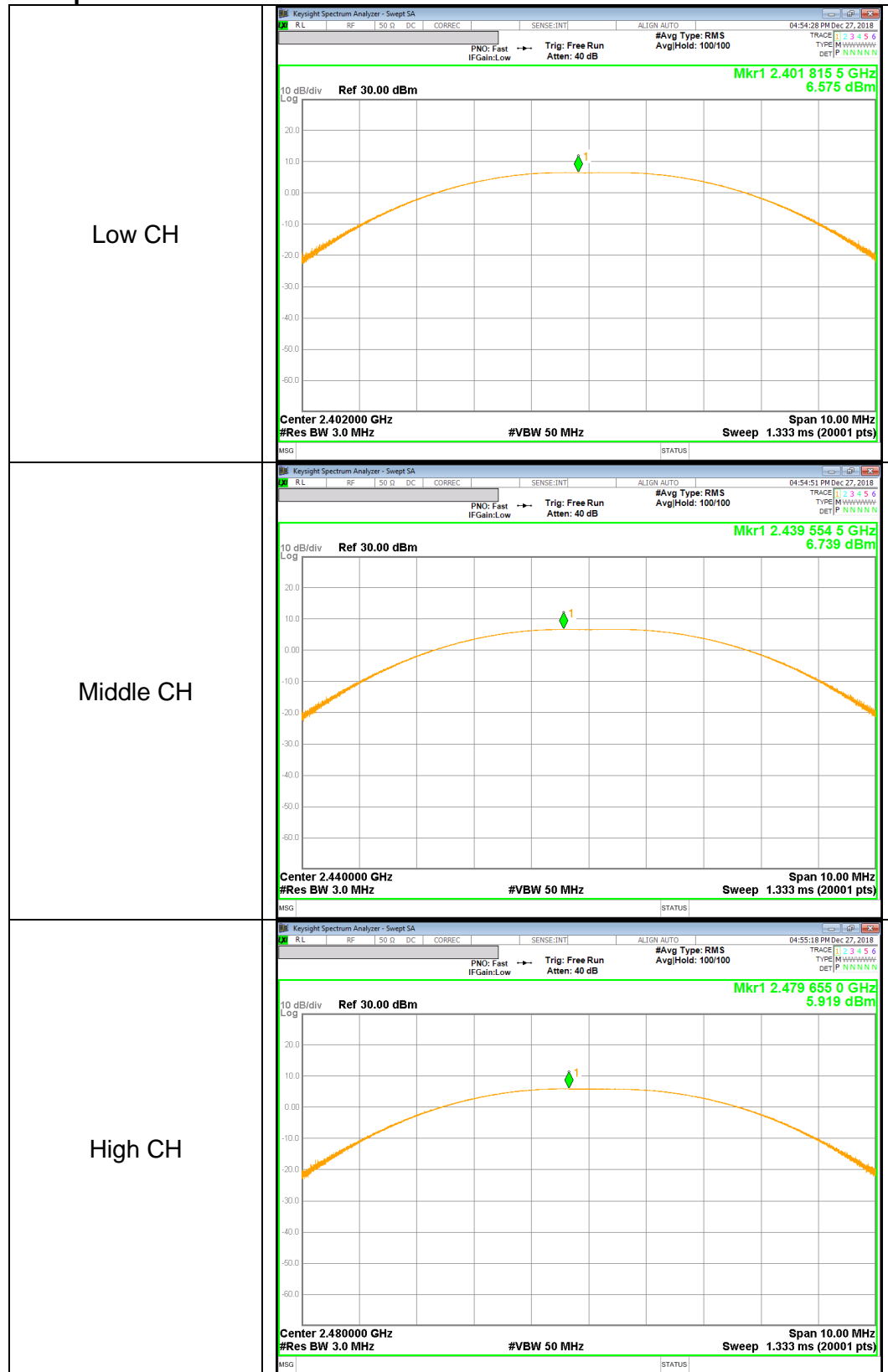

10.3. AVERAGE POWER

LIMITS

None; for reporting purposes only.

TEST PROCEDURE

The transmitter output is connected to a power meter.

RESULTS

The cable assembly insertion loss was entered as an offset in the power meter to allow for direct reading of power. The duty factor already has been added.

- 1Mbps

Channel	Frequency [MHz]	AV power [dBm]	AV power [mW]
Low	2402	6.296	4.261
Middle	2440	6.475	4.441
High	2480	5.616	3.644

- 2Mbps

Channel	Frequency [MHz]	AV power [dBm]	AV power [mW]
Low	2402	6.148	4.119
Middle	2440	6.327	4.292
High	2480	5.463	3.518

10.4. PSD

LIMITS

FCC §15.247

The power spectral density conducted from the transmitter to the antenna shall not be greater than 8 dBm in any 3 kHz band during any time interval of continuous transmission.

TEST PROCEDURE

Power Spectral Density was performed utilizing the ANSI C63.10 section 11.10.2 (Method PKPSD).

RESULTS

- 1Mbps

Channel	Frequency [MHz]	PSD [dBm/3kHz]	Limit [dBm/3kHz]	Margin [dB]
Low	2402	-9.78	8.00	-17.78
Mid	2440	-9.49	8.00	-17.49
High	2480	-10.61	8.00	-18.61

- 2Mbps

Channel	Frequency [MHz]	PSD [dBm/3kHz]	Limit [dBm/3kHz]	Margin [dB]
Low	2402	-12.45	8.00	-20.45
Mid	2440	-13.03	8.00	-21.03
High	2480	-13.59	8.00	-21.59

POWER SPECTRAL DENSITY PLOTS

- 1Mbps

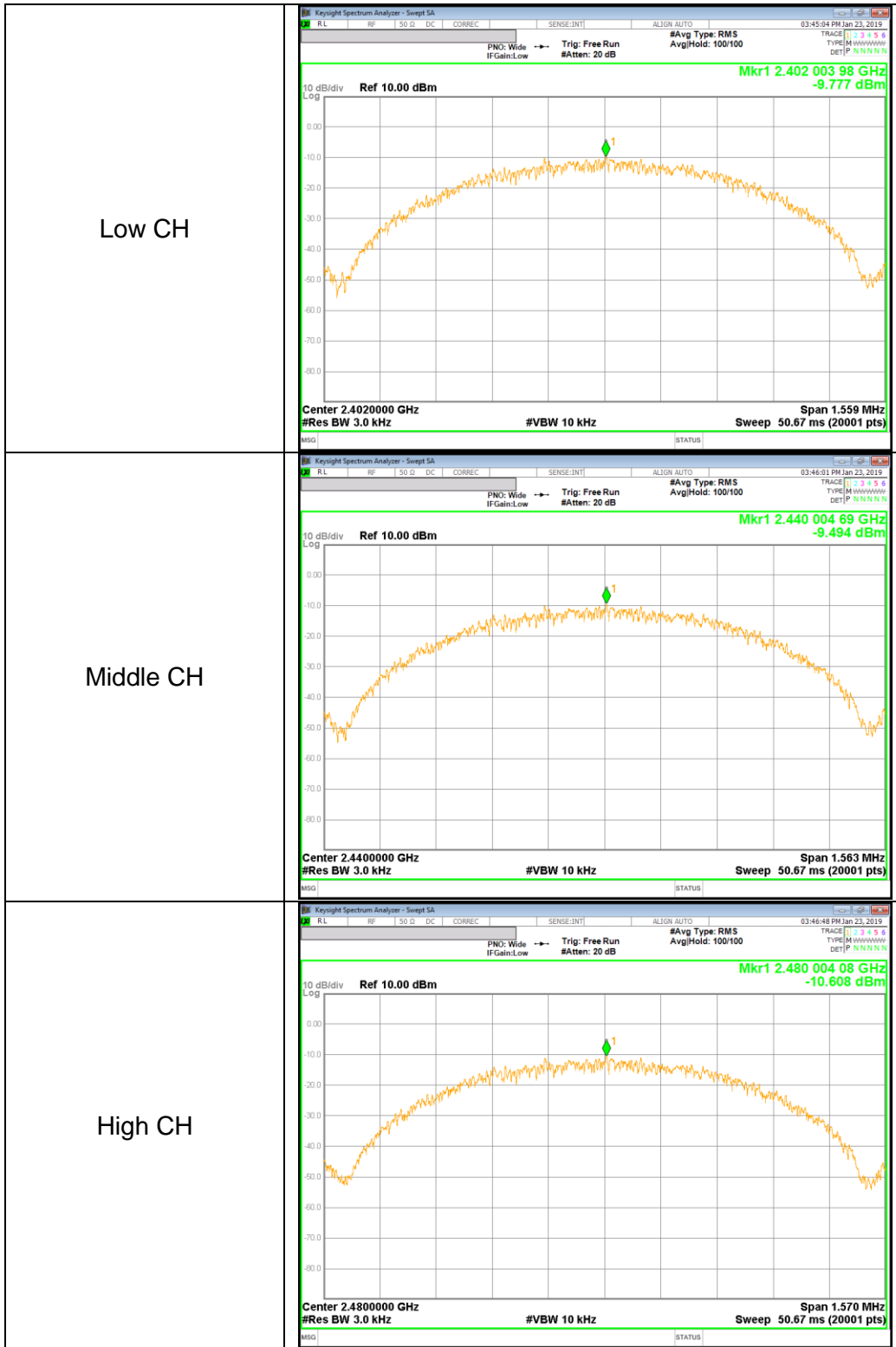

- 2Mbps

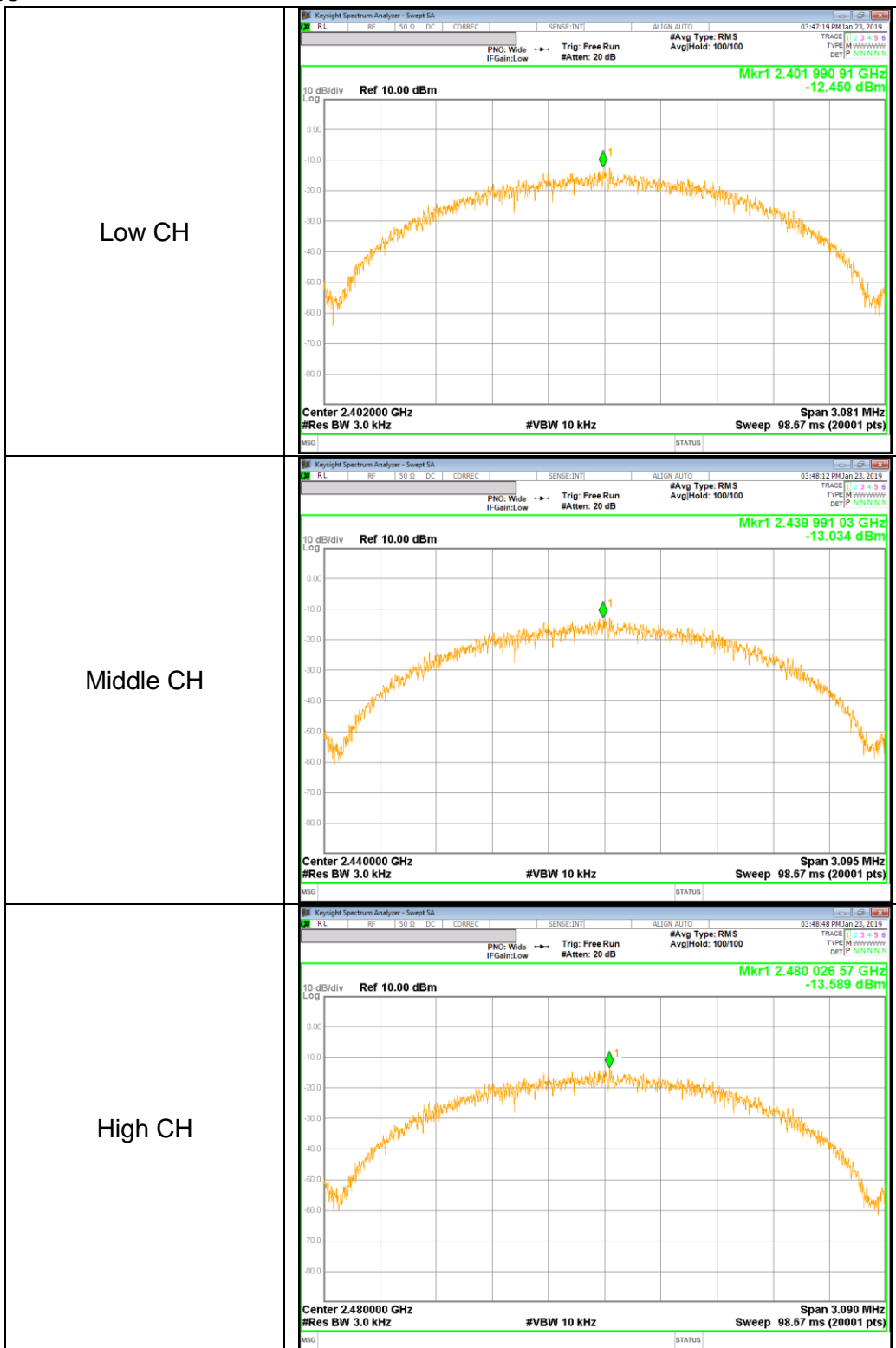

10.5. OUT-OF-BAND EMISSIONS

LIMITS

FCC §15.247 (d)

In any 100 kHz bandwidth outside the frequency band in which the spread spectrum or digitally modulated intentional radiator is operating, the radio frequency power that is produced by the intentional radiator shall be at least 20 dB below that in the 100 kHz bandwidth within the band that contains the highest level of the desired power, based on either an RF conducted or a radiated measurement, provided the transmitter demonstrates compliance with the peak conducted power limits. If the transmitter complies with the conducted power limits based on the use of RMS averaging over a time interval, as permitted under paragraph (b)(3) of this section, the attenuation required under this paragraph shall be 30 dB instead of 20 dB. Attenuation below the general limits specified in §15.209(a) is not required.

TEST PROCEDURE

The transmitter output is connected to a spectrum analyzer with RBW = 100 kHz, VBW = 300 kHz, peak detector, and max hold. Measurements utilizing these settings are made of the in-band reference level, bandedge (where measurements to the general radiated limits will not be made) and out-of-band emissions.

RESULTS

BANDEDGE & SPURIOUS EMISSIONS, LOW CHANNEL (1Mbps)

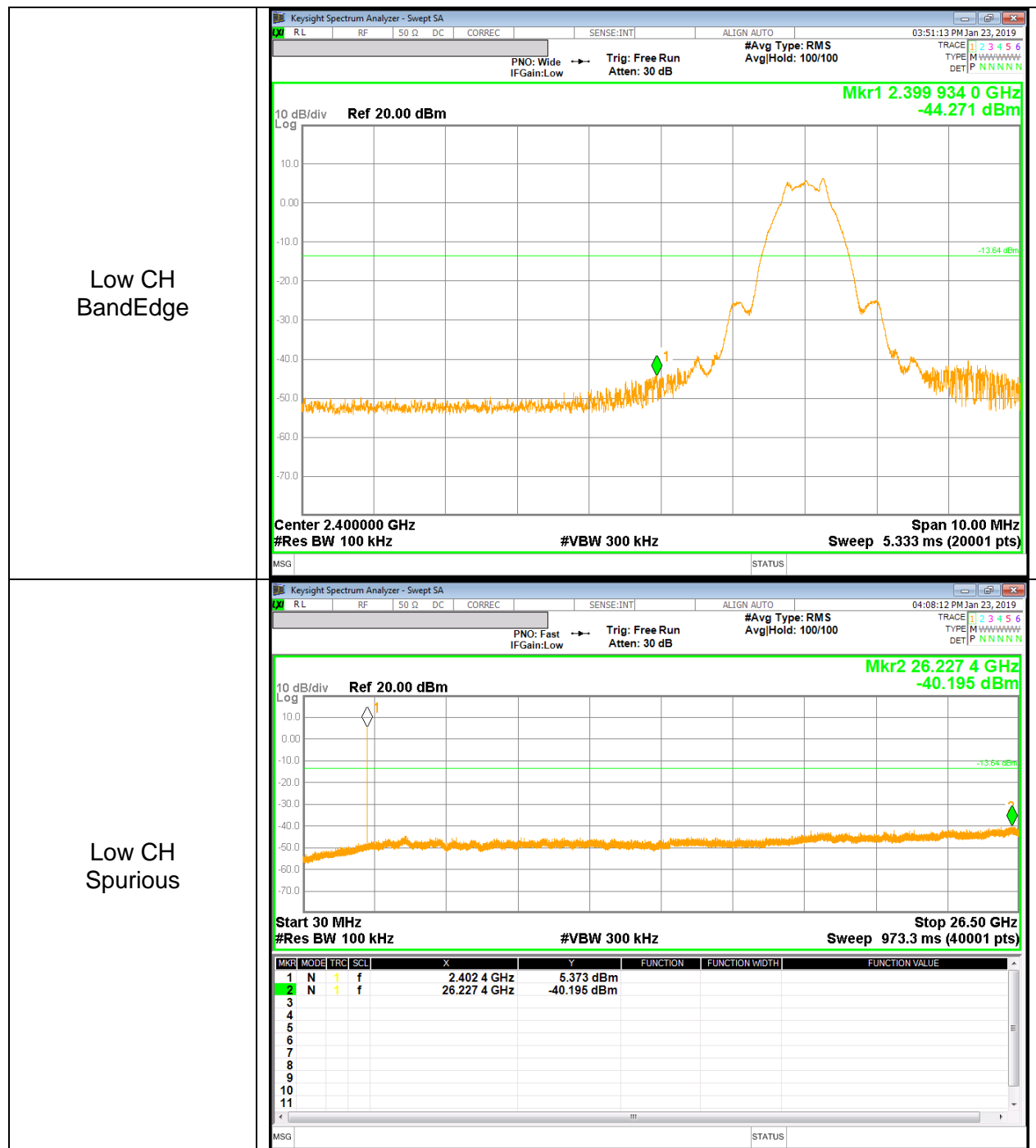

SPURIOUS EMISSIONS, MID CHANNEL (1Mbps)

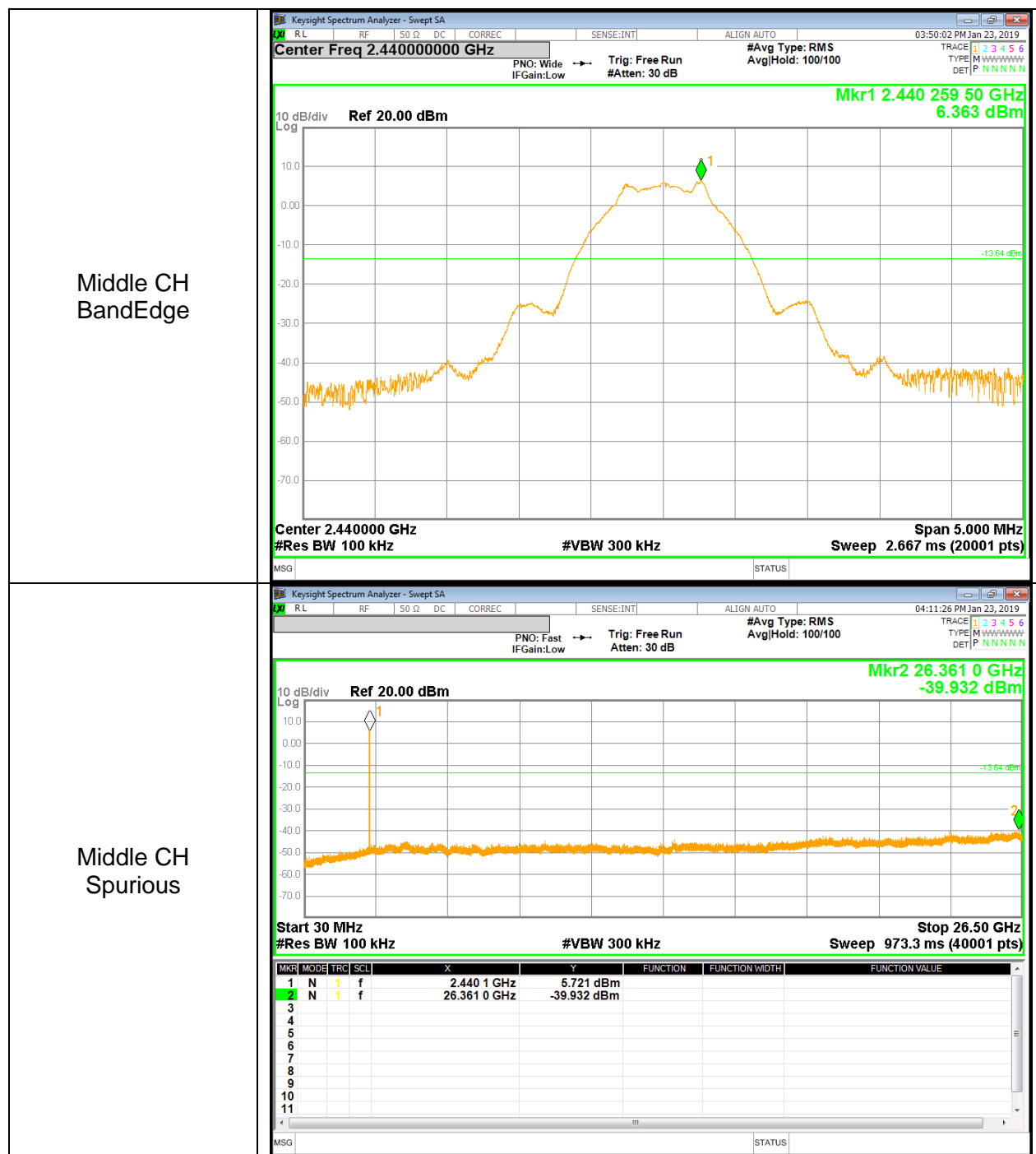

SPURIOUS EMISSIONS, HIGH CHANNEL (1Mbps)

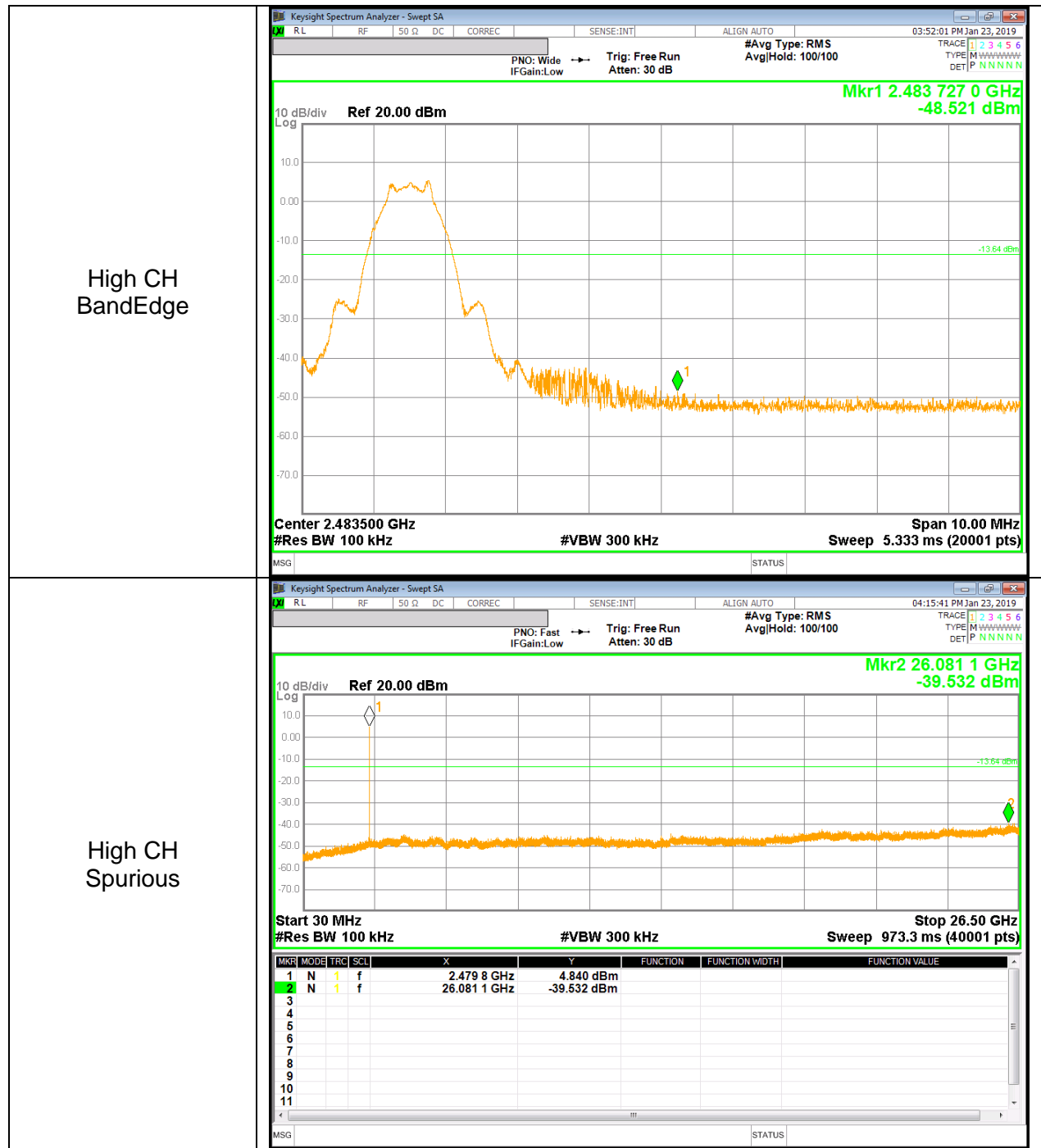

BANDEDGE & SPURIOUS EMISSIONS, LOW CHANNEL (2Mbps)

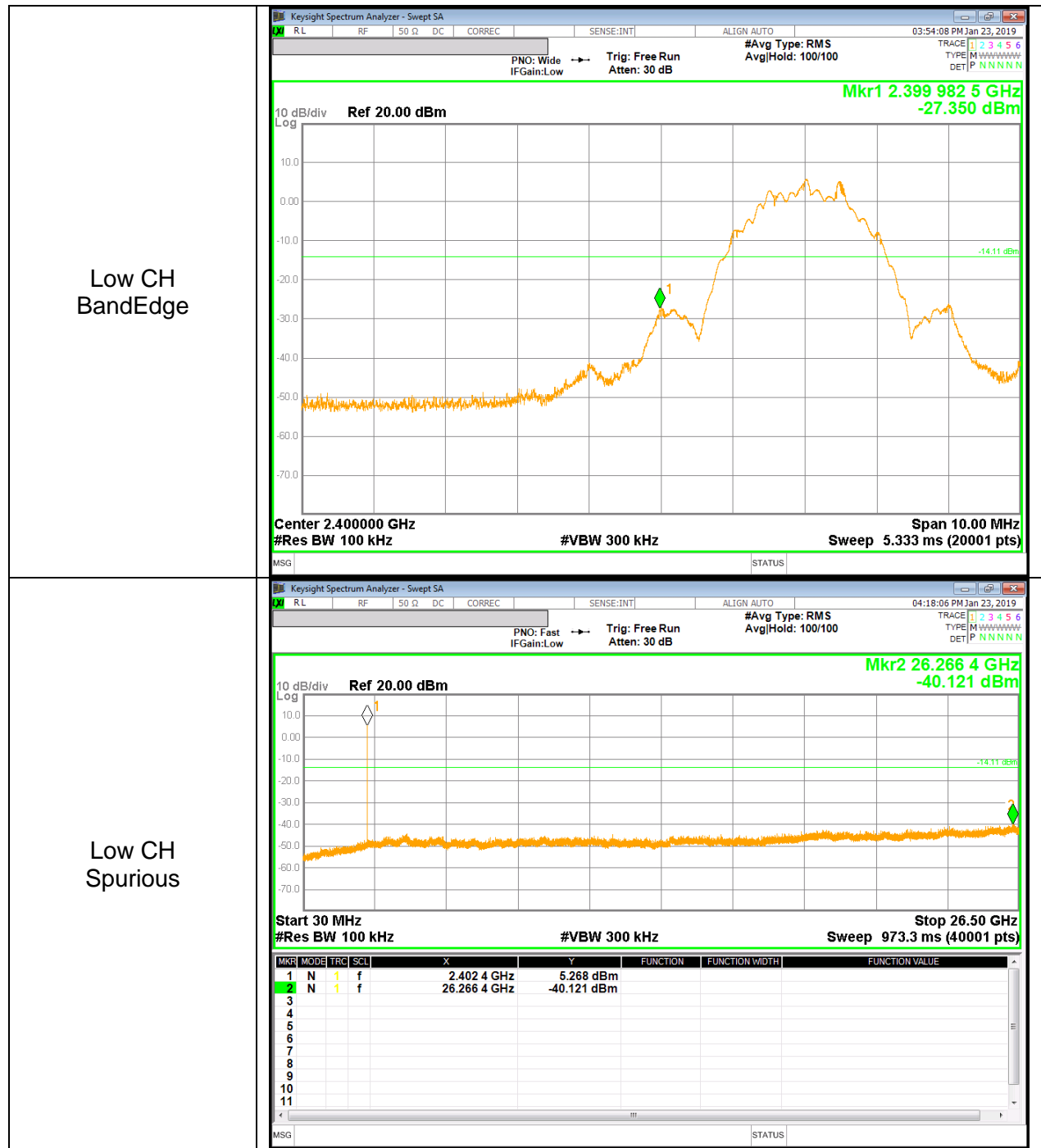

SPURIOUS EMISSIONS, MID CHANNEL (2Mbps)

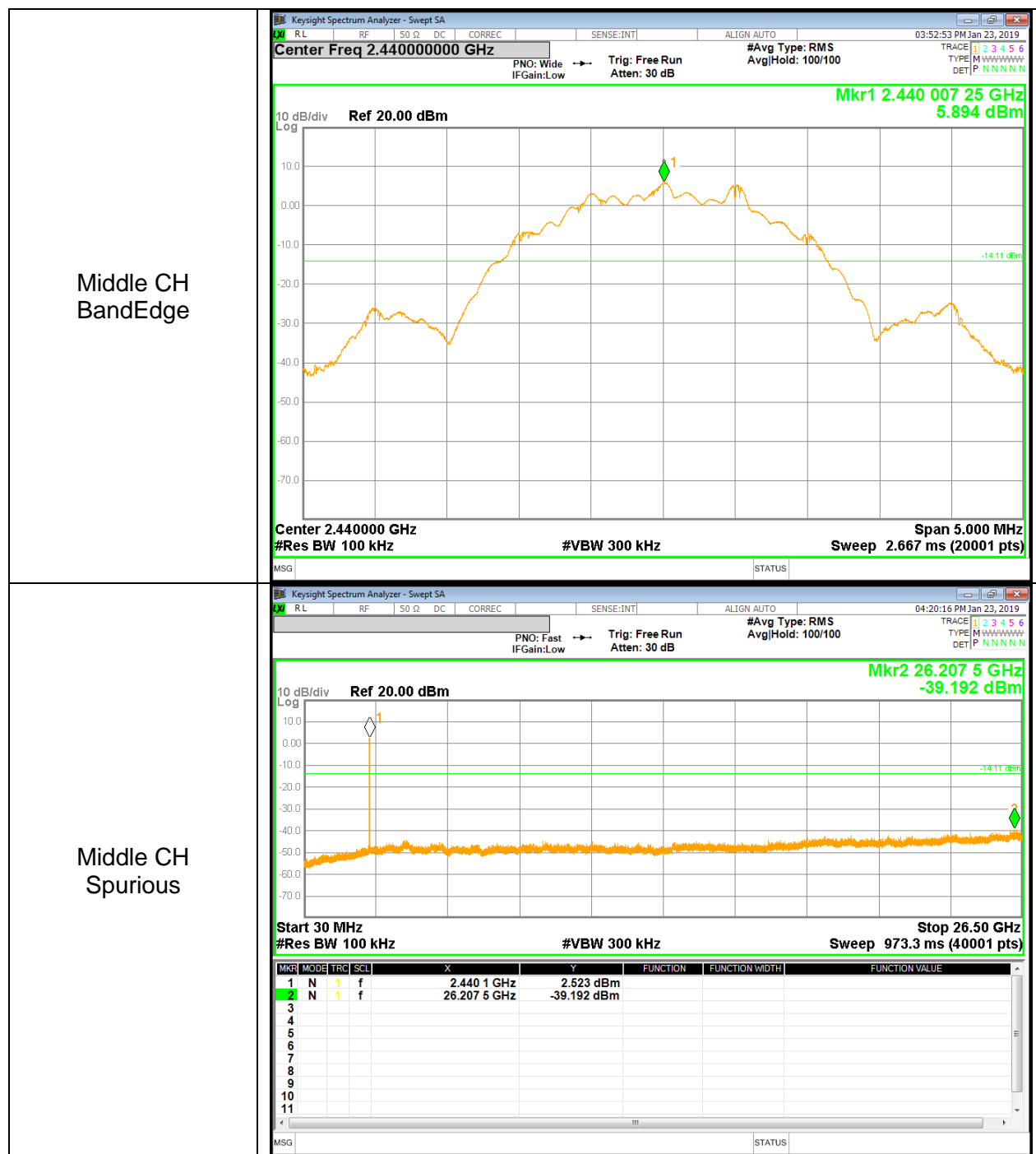

SPURIOUS EMISSIONS, HIGH CHANNEL (2Mbps)

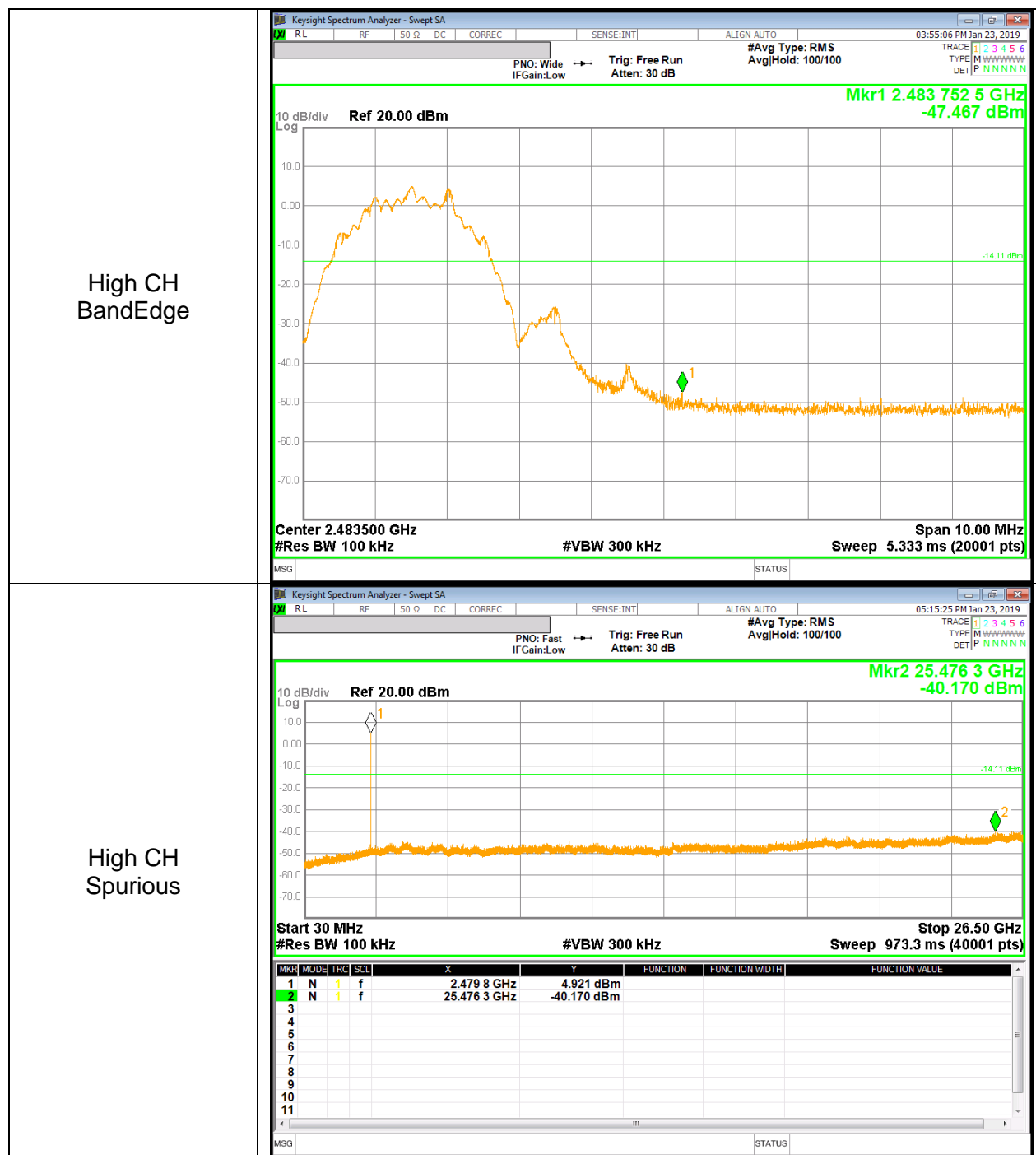

11. RADIATED TEST RESULTS

11.1. LIMITS AND PROCEDURE

LIMITS

FCC §15.205 and §15.209

Limits for radiated disturbance of an intentional radiator		
Frequency range (MHz)	Limits (µV/m)	Measurement Distance (m)
0.009 – 0.490	2400 / F (kHz)	300
0.490 – 1.705	24000 / F (kHz)	30
1.705 – 30.0	30	30
30 – 88	100**	3
88 - 216	150**	3
216 – 960	200**	3
Above 960	500	3

** Except as provided in paragraph (g), fundamental emissions from intentional radiators operating under this section shall not be located in the frequency bands 54-72 MHz, 76-88 MHz, 174-216 MHz or 470-806 MHz. However, operation within these frequency bands is permitted under other sections of this part, e.g. §§ 15.231 and 15.241.

TEST PROCEDURE

The EUT is placed on a non-conducting table 80 cm above the ground plane for below 1GHz and 150 cm for above 1GHz. The antenna to EUT distance is 3 meters. The EUT is configured in accordance with ANSI C63.10. The EUT is set to transmit in a continuous mode.

For measurements below 1 GHz the resolution bandwidth is set to 100 kHz for peak detection measurements or 120 kHz for quasi-peak detection measurements. Peak detection is used unless otherwise noted as quasi-peak.

For measurements above 1 GHz the resolution bandwidth is set to 1 MHz, then the video bandwidth is set to 3 MHz for peak measurements and add duty cycle factor for average measurements. (Restricted bandedge, Final detection of spurious harmonic emissions) Duty cycle factor = $10 \log(1/x)$. For this sample: For 1Mbps, DCF = $10 \log(1/0.851) = 0.70$ dB (Spectrum Analyzer round it up to 0.7dB) and for 2Mbps, DCF = $10 \log(1/0.571) = 2.44$ dB (Spectrum Analyzer round it up to 2.4dB)

Pre-scans to detect harmonic and spurious emissions, the resolution bandwidth is set to 1 MHz; the video bandwidth is set to 30 KHz for peak measurements.

The spectrum from 1 GHz to 26 GHz is investigated with the transmitter set to the lowest, middle, and highest channels in the 2.4 GHz band.
(From 30MHz to 1GHz, test was performed with the EUT set to transmit at the channel with highest output power)

The frequency range of interest is monitored at a fixed antenna height and EUT azimuth. The EUT is rotated through 360 degrees to maximize emissions received. The antenna is scanned from 1 to 4 meters above the ground plane to further maximize the emission. Measurements are made with the antenna polarized in both the vertical and the horizontal positions.

Note : Emission was pre-scanned from 9KHz to 30MHz; No emissions were detected which was at least 20dB below the specification limit (consider distance correction factor).
Per FCC part 15.31(o), test results were not reported.

Although these tests were performed other than open area test site, adequate comparison measurements were confirmed against 30 m open are test site.
Therefore sufficient tests were made to demonstrate that the alternative site produces results that correlate with the one of tests made in an open field based on KDB 414788.

11.2. TRANSMITTER ABOVE 1 GHz

11.2.1. 1Mbps MODE

RESTRICTED BANDEDGE (LOW CHANNEL)

HORIZONTAL PEAK AND AVERAGE PLOT

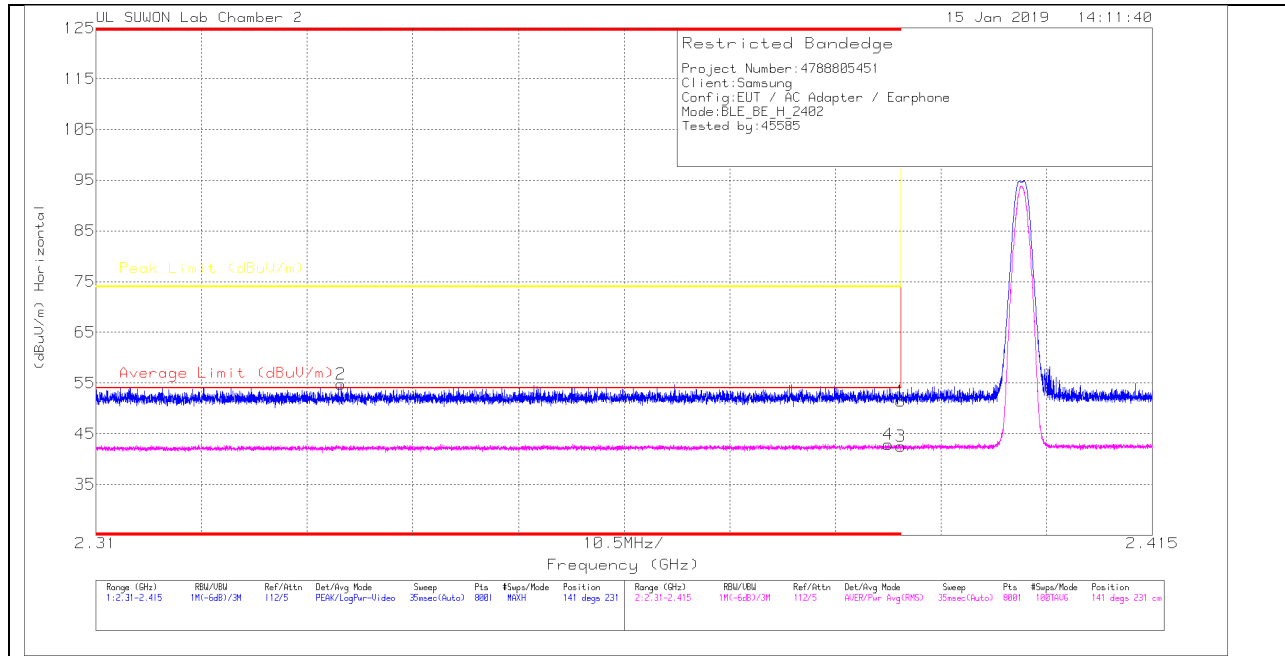

HORIZONTAL DATA

Trace Markers

Marker	Frequency (GHz)	Meter Reading (dBuV)	Det	3117_00168724	10dB(dB)	DC Corr (dB)	Corrected Reading (dBuV/m)	Average Limit (dBuV/m)	Margin (dB)	Peak Limit (dBuV/m)	PK Margin (dB)	Azimuth (Degs)	Height (cm)	Polarity
1	* 2.39	40.64	Pk	31.6	-20.8	0	51.44	-	-	74	-22.56	141	231	H
2	* 2.334	44.03	Pk	31.5	-20.8	0	54.73	-	-	74	-19.27	141	231	H
3	* 2.39	30.99	RMS	31.6	-20.8	.7	42.49	54	-11.51	-	-	141	231	H
4	* 2.389	31.44	RMS	31.6	-20.8	.7	42.94	54	-11.06	-	-	141	231	H

* - indicates frequency in CFR47 Pt 15 / IC RSS-Restricted Band

Pk - Peak detector

RMS - RMS detection

VERTICAL PEAK AND AVERAGE PLOT



VERTICAL DATA

Trace Markers

Marker	Frequency (GHz)	Meter Reading (dBuV)	Det	3117_00168724	10dB(dB)	DC Corr (dB)	Corrected Reading (dBuV/m)	Average Limit (dBuV/m)	Margin (dB)	Peak Limit (dBuV/m)	PK Margin (dB)	Azimuth (Degs)	Height (cm)	Polarity
1	* 2.39	41.36	Pk	31.6	-20.8	0	52.16	-	-	74	-21.84	319	144	V
2	* 2.36	44.88	Pk	31.6	-20.8	0	55.68	-	-	74	-18.32	319	144	V
3	* 2.39	30.7	RMS	31.6	-20.8	.7	42.2	54	-11.8	-	-	319	144	V
4	* 2.389	31.51	RMS	31.6	-20.8	.7	43.01	54	-10.99	-	-	319	144	V

* - indicates frequency in CFR47 Pt 15 / IC RSS-Restricted Band

Pk - Peak detector

RMS - RMS detection

AUTHORIZED BANDEDGE (HIGH CHANNEL)

HORIZONTAL PEAK AND AVERAGE PLOT

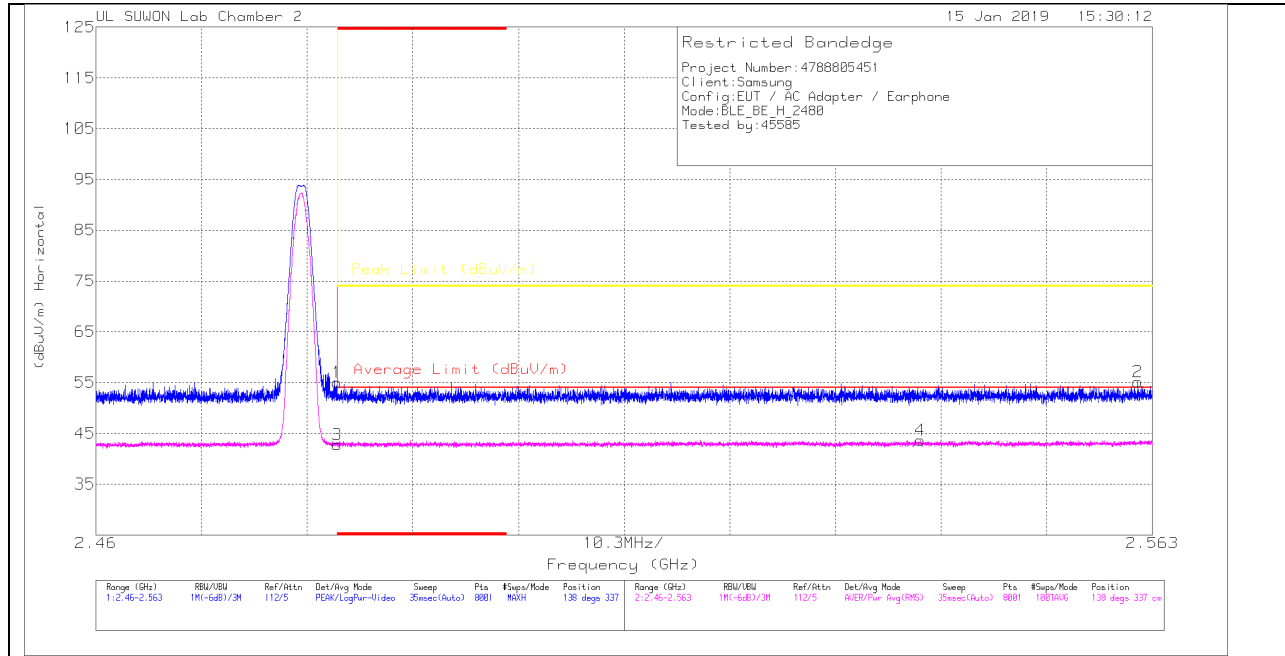

HORIZONTAL DATA

Trace Markers

Marker	Frequency (GHz)	Meter Reading (dBuV)	Det	3117_00168724	10dB(dB)	DC Corr (dB)	Corrected Reading (dBuV/m)	Average Limit (dBuV/m)	Margin (dB)	Peak Limit (dBuV/m)	PK Margin (dB)	Asimuth (Degs)	Height (cm)	Polarity
1	* 2.484	43.72	Pk	31.9	-20.6	0	55.02	-	-	74	-18.98	138	337	H
2	2.562	43.52	Pk	32	-20.4	0	55.12	-	-	74	-18.88	138	337	H
3	* 2.484	30.74	RMS	31.9	-20.6	.7	42.74	54	-11.26	-	-	138	337	H
4	2.54	31.5	RMS	32	-20.5	.7	43.7	54	-10.3	-	-	138	337	H

* - indicates frequency in CFR47 Pt 15 / IC RSS-Restricted Band

Pk - Peak detector

RMS - RMS detection

VERTICAL PEAK AND AVERAGE PLOT

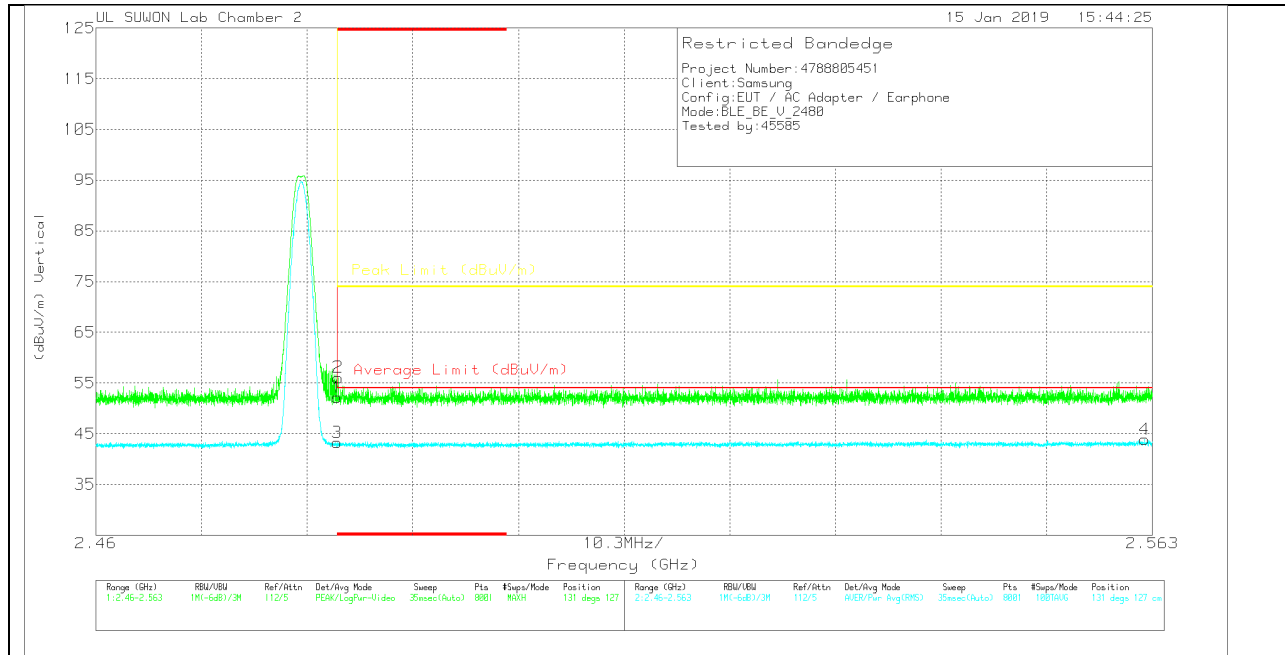

VERTICAL DATA

Trace Markers

Marker	Frequency (GHz)	Meter Reading (dBuV)	Det	3117_00168724	10dB(dB)	DC Corr (dB)	Corrected Reading (dBuV/m)	Average Limit (dBuV/m)	Margin (dB)	Peak Limit (dBuV/m)	PK Margin (dB)	Azimuth (Degs)	Height (cm)	Polarity
1	* 2.484	40.89	Pk	31.9	-20.6	0	52.19	-	-	74	-21.81	131	127	V
2	* 2.484	44.78	Pk	31.9	-20.6	0	56.08	-	-	74	-17.92	131	127	V
3	* 2.484	31.23	RMS	31.9	-20.6	.7	43.23	54	-10.77	-	-	131	127	V
4	2.562	31.47	RMS	32	-20.3	.7	43.87	54	-10.13	-	-	131	127	V

* - indicates frequency in CFR47 Pt 15 / IC RSS-Restricted Band

Pk - Peak detector

RMS - RMS detection

HARMONICS AND SPURIOUS EMISSIONS

LOW CHANNEL HORIZONTAL

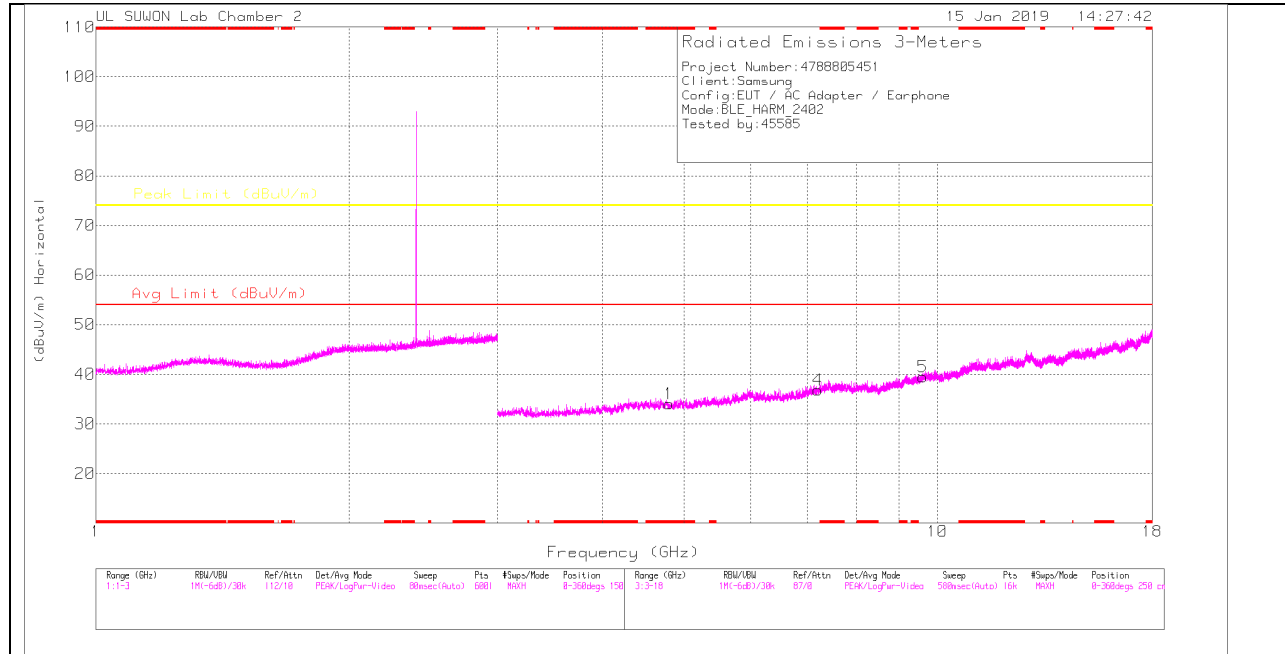

LOW CHANNEL VERTICAL

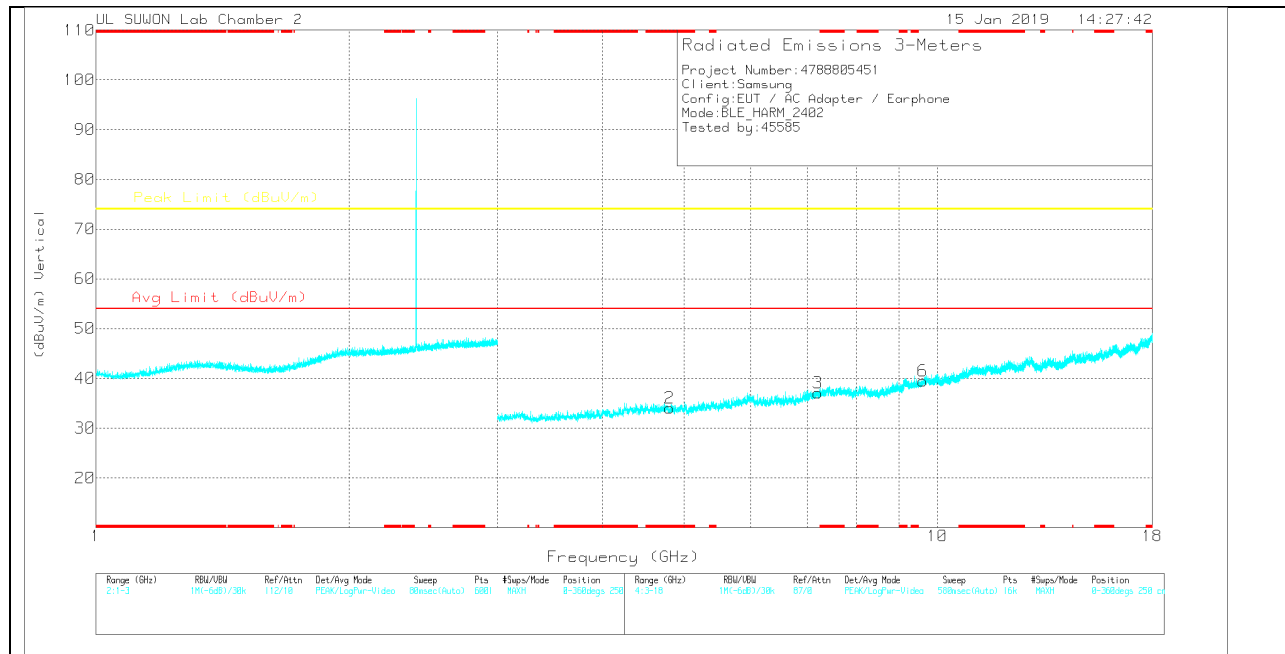

Note: Emission was scanned up to 26GHz; No emissions were detected above the noise floor which was at least 20dB below the specification limit.

LOW CHANNEL DATA

Trace Markers

Marker	Frequency (GHz)	Meter Reading (dBuV)	Det	3117_00168724	3GHz_HP(dB)	DC Corr (dB)	Corrected Reading (dBuV/m)	Avg Limit (dBuV/m)	Margin (dB)	Peak Limit (dBuV/m)	Margin (dB)	Azimuth (Degs)	Height (cm)	Polarity
1	* 4.797	27.98	PK	34	-27.9	0	34.08	-	-	74	-39.92	0-360	150	H
4	7.207	26.07	PK	36.1	-25.4	0	36.77	-	-	74	-37.23	0-360	150	H
5	9.608	24.42	PK	37	-21.9	0	39.52	-	-	74	-34.48	0-360	150	H
2	* 4.804	28.13	PK	34	-28.1	0	34.03	-	-	74	-39.97	0-360	250	V
3	7.206	26.31	PK	36.1	-25.3	0	37.11	-	-	74	-36.89	0-360	150	V
6	9.608	24.38	PK	37	-21.9	0	39.48	-	-	74	-34.52	0-360	150	V

* - indicates frequency in CFR47 Pt 15 / IC RSS-Restricted Band
 PK – Peak Detector

Note: Only peak measurement was performed. Because peak measurement result of unwanted emission is less than average limit (54dBuV/m).

MID CHANNEL HORIZONTAL

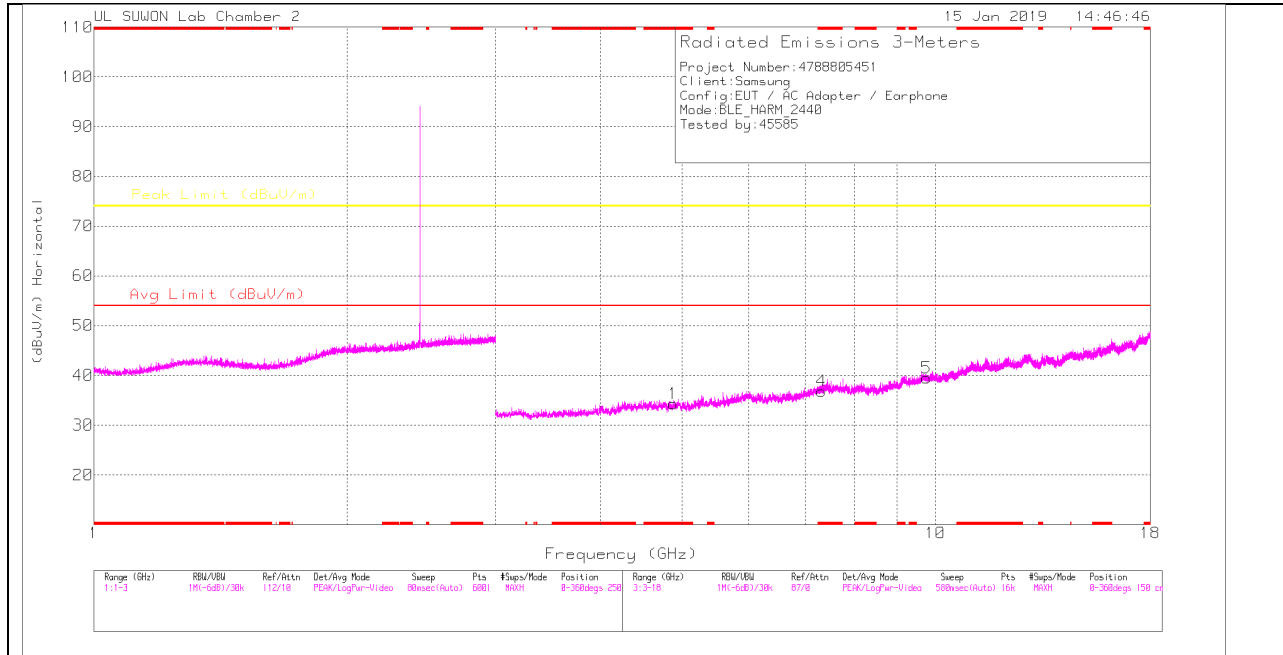

MID CHANNEL VERTICAL

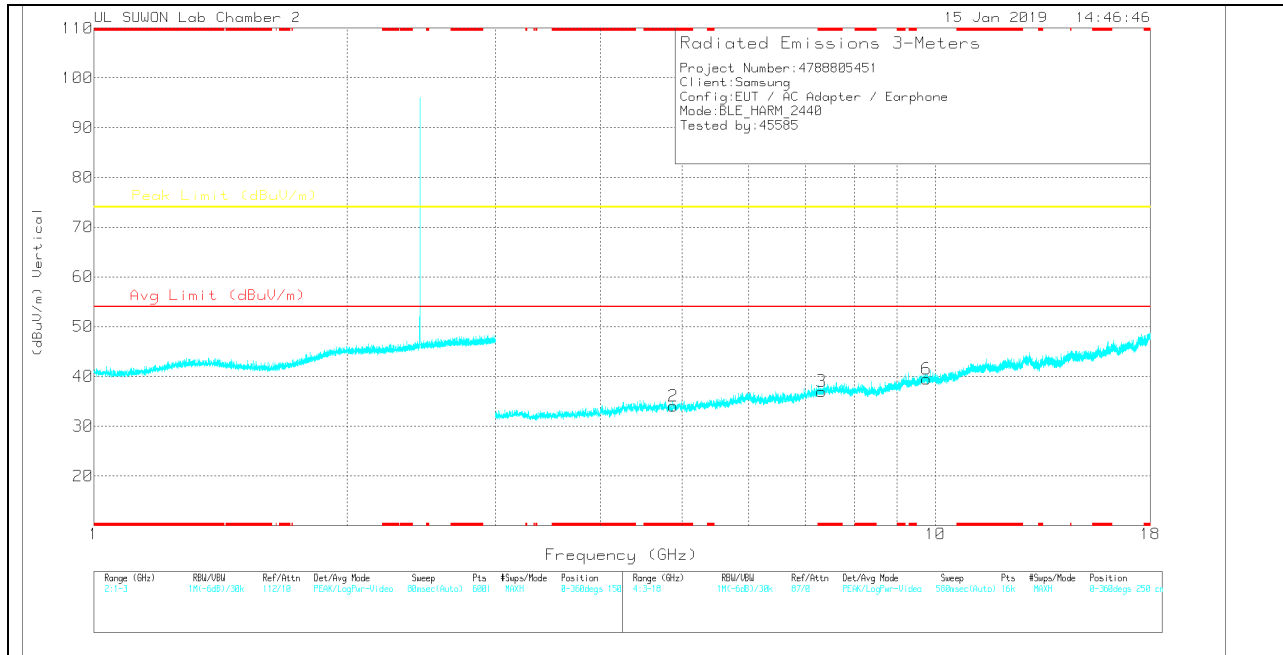

Note: Emission was scanned up to 26GHz; No emissions were detected above the noise floor which was at least 20dB below the specification limit.

MID CHANNEL DATA

Trace Markers

Marker	Frequency (GHz)	Meter Reading (dBuV)	Det	3117_00168724	3GHz_HP[dB]	DC Corr (dB)	Corrected Reading (dBuV/m)	Avg Limit (dBuV/m)	Margin (dB)	Peak Limit (dBuV/m)	Margin (dB)	Azimuth (Degs)	Height (cm)	Polarity
1	* 4.879	28.22	PK	34	-27.9	0	34.32	-	-	74	-39.68	0-360	250	H
4	* 7.321	25.52	PK	36.2	-24.9	0	36.82	-	-	74	-37.18	0-360	150	H
5	9.76	23.75	PK	37.2	-21.5	0	39.45	-	-	74	-34.55	0-360	250	H
2	* 4.88	27.94	PK	34	-27.9	0	34.04	-	-	74	-39.96	0-360	250	V
3	* 7.321	25.71	PK	36.2	-24.9	0	37.01	-	-	74	-36.99	0-360	150	V
6	9.76	23.83	PK	37.2	-21.5	0	39.53	-	-	74	-34.47	0-360	150	V

* - indicates frequency in CFR47 Pt 15 / IC RSS-Restricted Band
 PK – Peak Detector

Note: Only peak measurement was performed. Because peak measurement result of unwanted emission is less than average limit (54dBuV/m).

HIGH CHANNEL HORIZONTAL

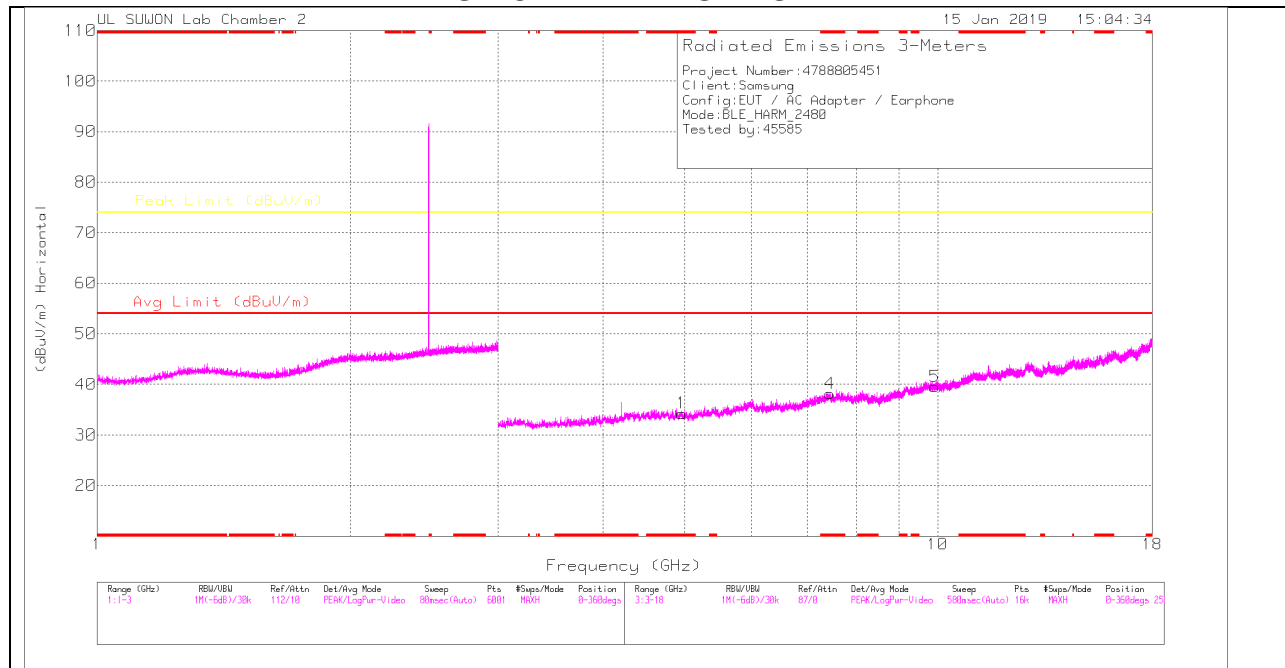

HIGH CHANNEL VERTICAL

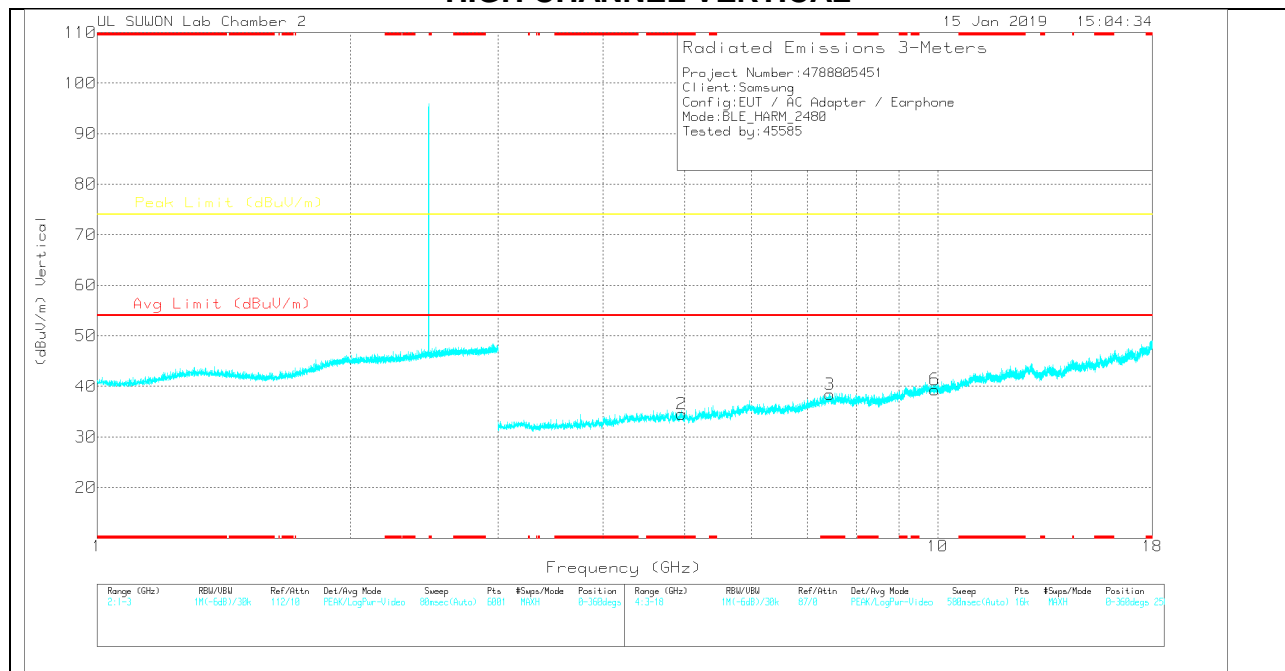

Note: Emission was scanned up to 26GHz; No emissions were detected above the noise floor which was at least 20dB below the specification limit.

HIGH CHANNEL DATA

Trace Markers

Marker	Frequency (GHz)	Meter Reading (dBuV)	Det	3117_00158724	3GHz_HP[dB]	DC Corr (dB)	Corrected Reading (dBuV/m)	Avg Limit (dBuV/m)	Margin (dB)	Peak Limit (dBuV/m)	Margin (dB)	Azimuth (Degs)	Height (cm)	Polarity
1	* 4.962	27.16	PK	34.1	-27	0	34.26	-	-	74	-39.74	0-360	150	H
4	* 7.441	26.08	PK	36.2	-24.1	0	38.18	-	-	74	-35.82	0-360	150	H
5	9.92	23.14	PK	37.4	-21	0	39.54	-	-	74	-34.46	0-360	250	H
2	* 4.959	27.53	PK	34.1	-27.1	0	34.53	-	-	74	-39.47	0-360	150	V
3	* 7.441	26.3	PK	36.2	-24.1	0	38.4	-	-	74	-35.6	0-360	250	V
6	9.921	22.94	PK	37.4	-21	0	39.34	-	-	74	-34.66	0-360	150	V

* - indicates frequency in CFR47 Pt 15 / IC RSS-Restricted Band
 PK – Peak Detector

Note: Only peak measurement was performed. Because peak measurement result of unwanted emission is less than average limit (54dBuV/m).

11.2.2. 2Mbps MODE

RESTRICTED BANDEDGE (LOW CHANNEL)

HORIZONTAL PEAK AND AVERAGE PLOT

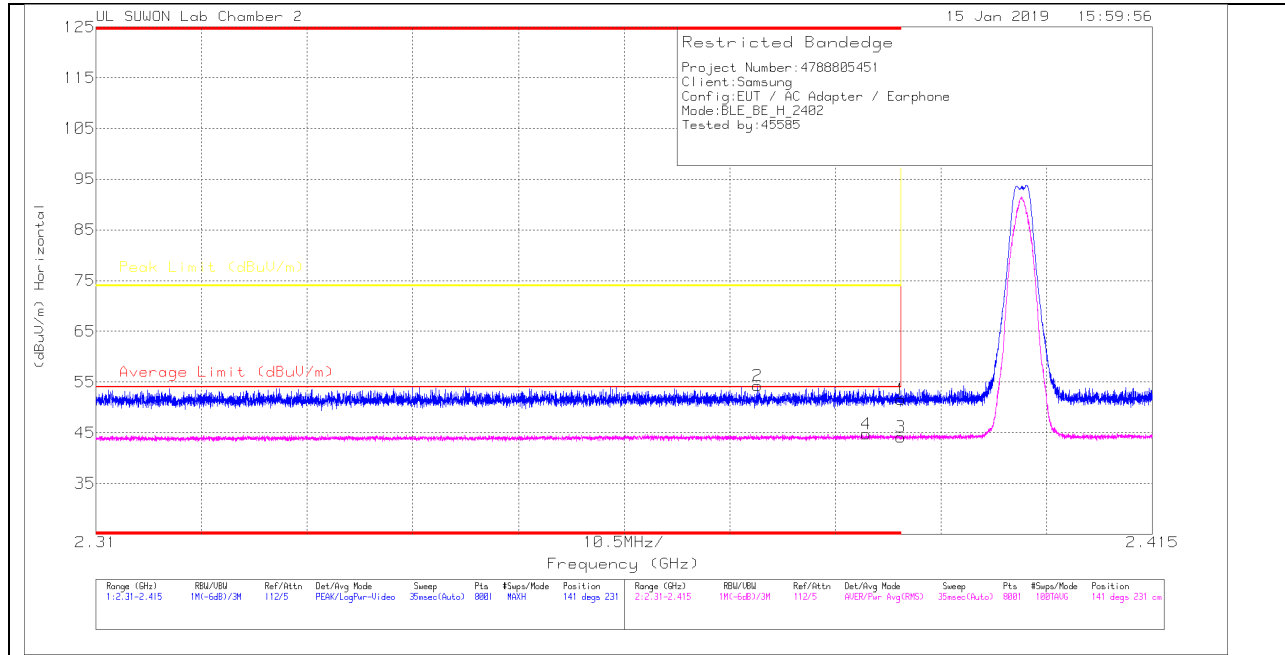

HORIZONTAL DATA

Trace Markers

Marker	Frequency (GHz)	Meter Reading (dBuV)	Det	3117_00168724	10dB(dB)	DC Corr (dB)	Corrected Reading (dBuV/m)	Average Limit (dBuV/m)	Margin (dB)	Peak Limit (dBuV/m)	PK Margin (dB)	Azimuth (Degs)	Height (cm)	Polarity	
1	* 2.39	40.72	Pk		31.6	-20.8	0	51.52	-	-	74	-22.48	141	231	H
2	* 2.376	43.44	Pk		31.6	-20.8	0	54.24	-	-	74	-19.76	141	231	H
3	* 2.39	30.87	RMS		31.6	-20.8	2.44	44.11	54	-9.89	-	-	141	231	H
4	* 2.387	31.51	RMS		31.6	-20.8	2.44	44.75	54	-9.25	-	-	141	231	H

* - indicates frequency in CFR47 Pt 15 / IC RSS-Restricted Band

Pk - Peak detector

RMS - RMS detection

VERTICAL PEAK AND AVERAGE PLOT



VERTICAL DATA

Trace Markers

Marker	Frequency (GHz)	Meter Reading (dBuV)	Det	3117_00168724	10dB(dB)	DC Corr (dB)	Corrected Reading (dBuV/m)	Average Limit (dBuV/m)	Margin (dB)	Peak Limit (dBuV/m)	PK Margin (dB)	Azimuth (Degs)	Height (cm)	Polarity
1	* 2.39	40.16	Pk	31.6	-20.8	0	50.96	-	-	74	-23.04	315	145	V
2	* 2.363	44	Pk	31.6	-20.8	0	54.8	-	-	74	-19.2	315	145	V
3	* 2.39	30.74	RMS	31.6	-20.8	2.44	43.98	54	-10.02	-	-	315	145	V
4	* 2.383	31.69	RMS	31.6	-20.8	2.44	44.93	54	-9.07	-	-	315	145	V

* - indicates frequency in CFR47 Pt 15 / IC RSS-Restricted Band

Pk - Peak detector

RMS - RMS detection

AUTHORIZED BANDEDGE (HIGH CHANNEL)

HORIZONTAL PEAK AND AVERAGE PLOT

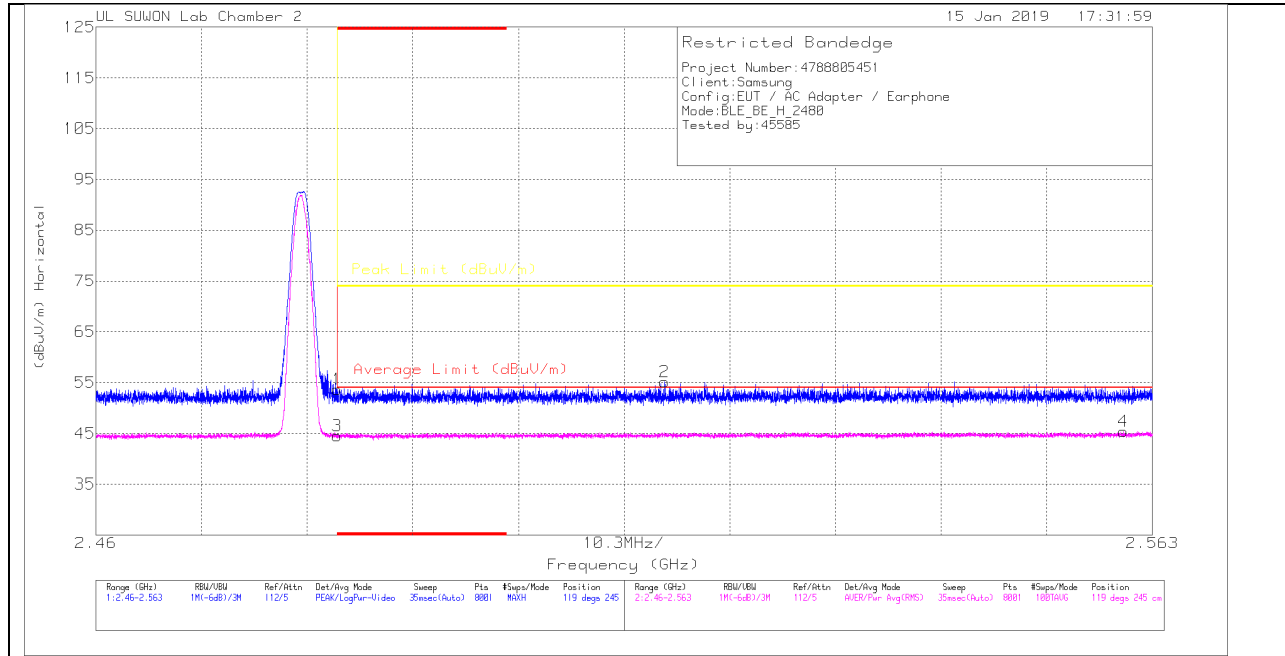

HORIZONTAL DATA

Trace Markers

Marker	Frequency (GHz)	Meter Reading (dBuV)	Det	3117_00168724	10dB(dB)	DC Corr (dB)	Corrected Reading (dBuV/m)	Average Limit (dBuV/m)	Margin (dB)	Peak Limit (dBuV/m)	PK Margin (dB)	Azimuth (Degs)	Height (cm)	Polarity
1	* 2.484	42.32	Pk	31.9	-20.6	0	53.62	-	-	74	-20.38	119	245	H
2	2.515	43.79	Pk	31.9	-20.5	0	55.19	-	-	74	-18.81	119	245	H
3	* 2.484	30.78	RMS	31.9	-20.6	2.44	44.52	54	-9.48	-	-	119	245	H
4	2.56	31.45	RMS	32	-20.5	2.44	45.39	54	-8.61	-	-	119	245	H

* - indicates frequency in CFR47 Pt 15 / IC RSS-Restricted Band

Pk - Peak detector

RMS - RMS detection

VERTICAL PEAK AND AVERAGE PLOT

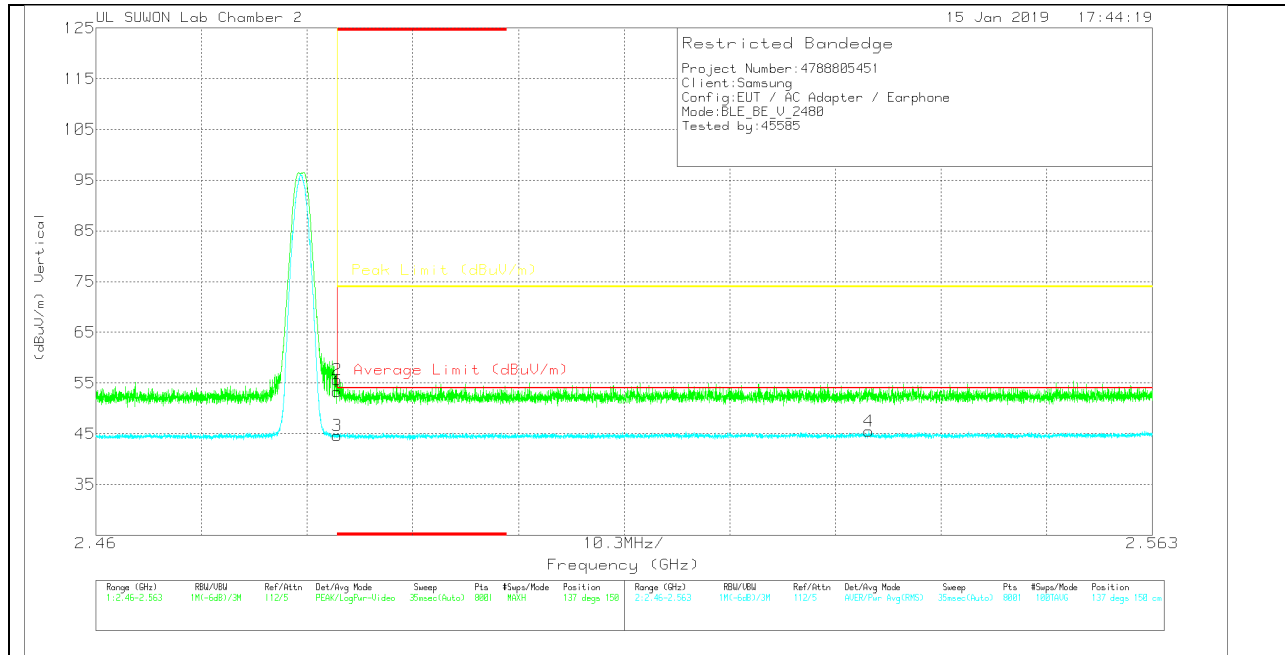

VERTICAL DATA

Trace Markers

Marker	Frequency (GHz)	Meter Reading (dBuV)	Det	3117_00168724	10dB[dB]	DC Corr (dB)	Corrected Reading (dBuV/m)	Average Limit (dBuV/m)	Margin (dB)	Peak Limit (dBuV/m)	PK Margin (dB)	Azimuth (Degs)	Height (cm)	Polarity
1	* 2.484	42.04	Pk	31.9	-20.6	0	53.34	-	-	74	-20.66	137	150	V
2	* 2.484	44.36	Pk	31.9	-20.6	0	55.66	-	-	74	-18.34	137	150	V
3	* 2.484	30.85	RMS	31.9	-20.6	2.44	44.59	54	-9.41	-	-	137	150	V
4	2.535	31.53	RMS	32	-20.5	2.44	45.47	54	-8.53	-	-	137	150	V

* - indicates frequency in CFR47 Pt 15 / IC RSS-Restricted Band

Pk - Peak detector

RMS - RMS detection

HARMONICS AND SPURIOUS EMISSIONS

LOW CHANNEL HORIZONTAL

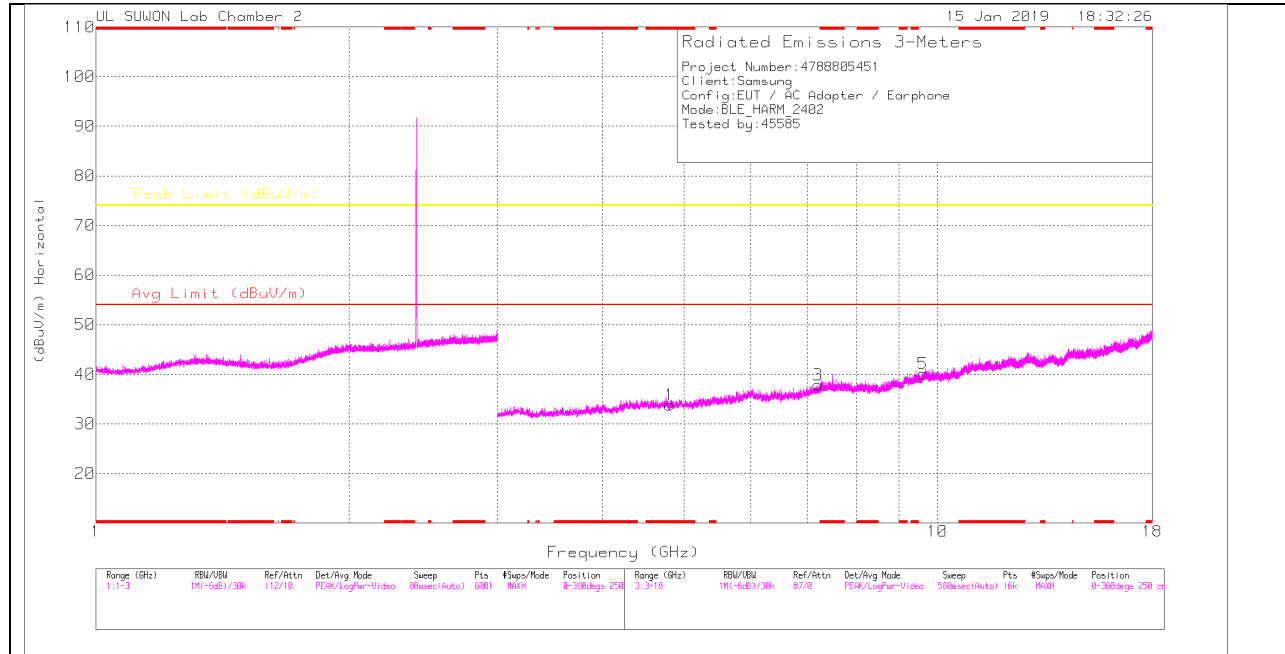

LOW CHANNEL VERTICAL

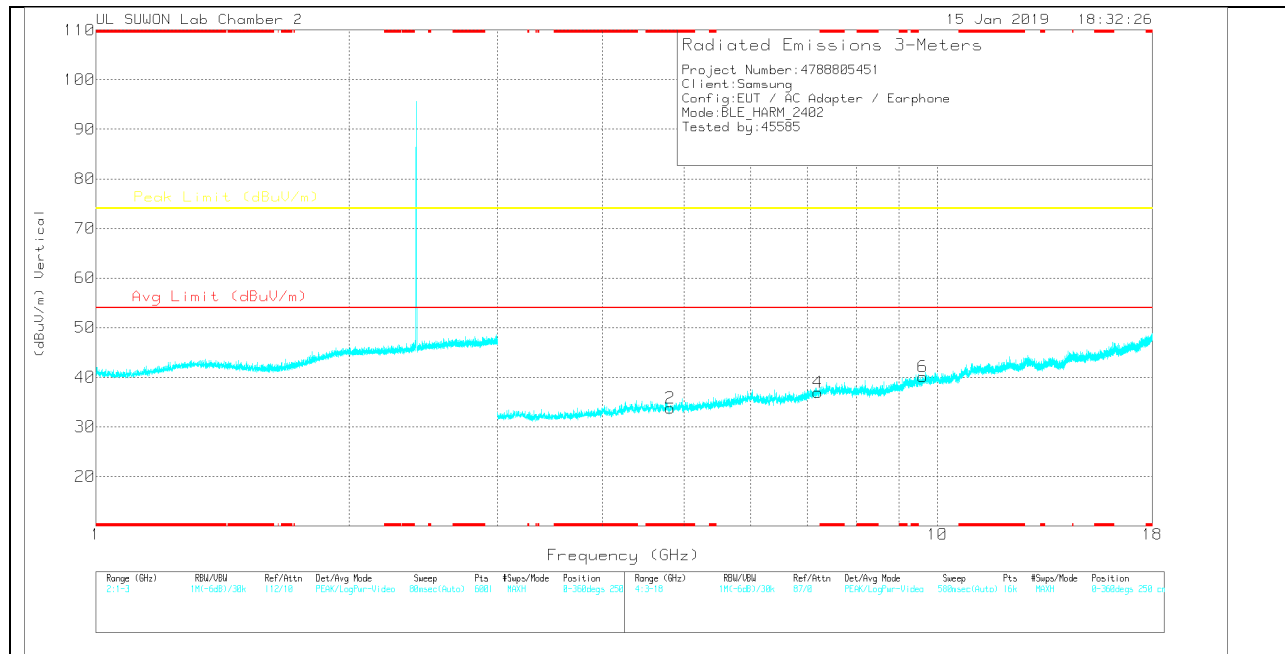

Note: Emission was scanned up to 26GHz; No emissions were detected above the noise floor which was at least 20dB below the specification limit.

LOW CHANNEL DATA

Trace Markers

Marker	Frequency (GHz)	Meter Reading (dBuV)	Det	3117_00168724	3GHz_HP(dB)	DC Corr (dB)	Corrected Reading (dBuV/m)	Avg Limit (dBuV/m)	Margin (dB)	Peak Limit (dBuV/m)	Margin (dB)	Azimuth (Degs)	Height (cm)	Polarity
1	* 4.807	27.82	PK	34	-28	0	33.82	-	-	74	-40.18	0-360	250	H
3	7.207	27.16	PK	36.1	-25.4	0	37.86	-	-	74	-36.14	0-360	150	H
5	9.612	24.85	PK	37	-21.8	0	40.05	-	-	74	-33.95	0-360	250	H
2	* 4.809	27.91	PK	34	-28.1	0	33.81	-	-	74	-40.19	0-360	150	V
4	7.206	26.14	PK	36.1	-25.3	0	36.94	-	-	74	-37.06	0-360	250	V
6	9.611	24.91	PK	37	-21.8	0	40.11	-	-	74	-33.89	0-360	150	V

* - indicates frequency in CFR47 Pt 15 / IC RSS-Restricted Band
 PK – Peak Detector

Note: Only peak measurement was performed. Because peak measurement result of unwanted emission is less than average limit (54dBuV/m).

MID CHANNEL HORIZONTAL

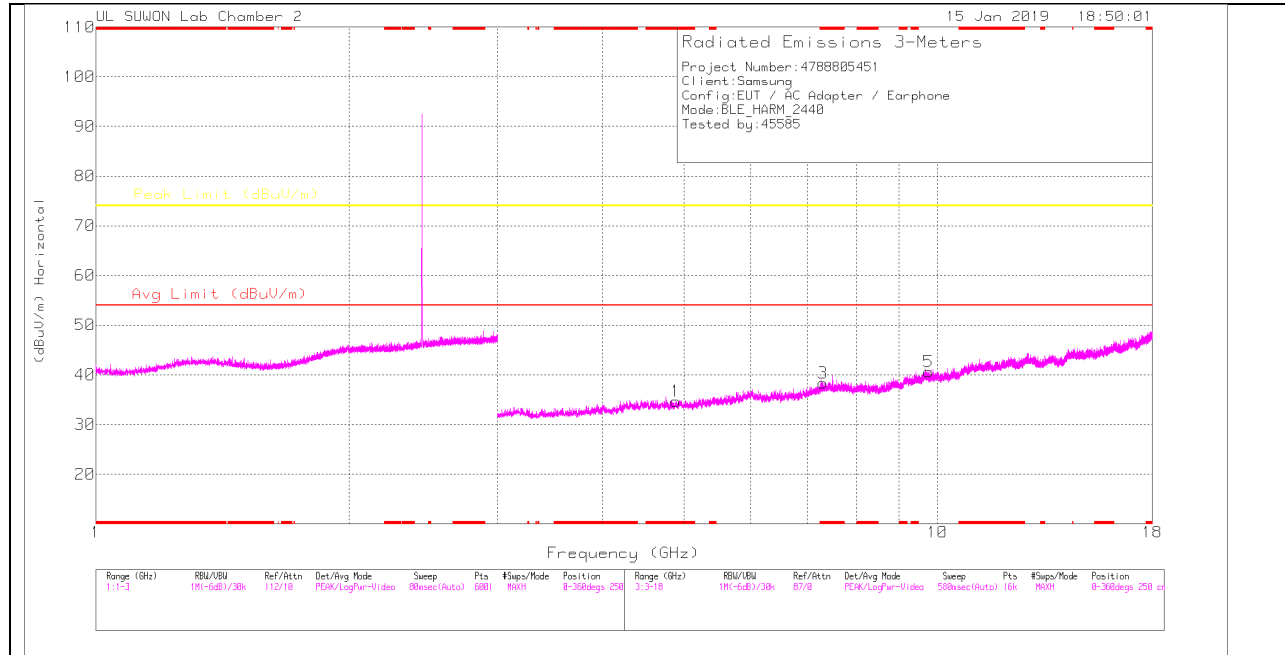

MID CHANNEL VERTICAL

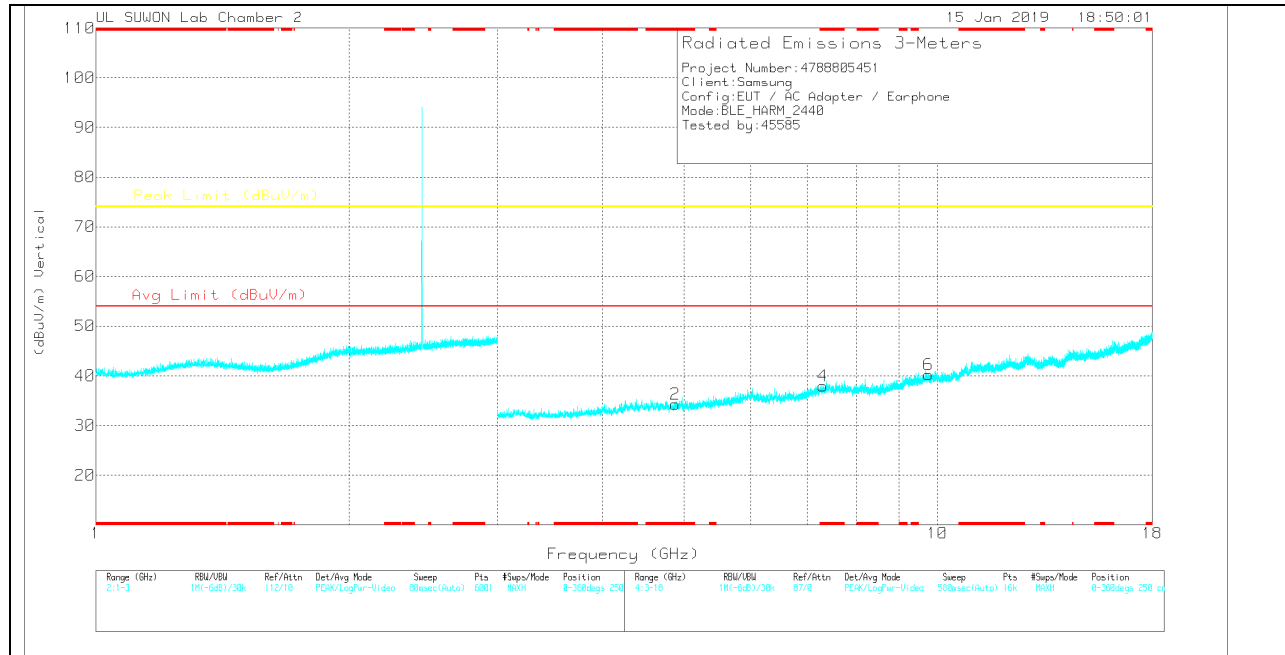

Note: Emission was scanned up to 26GHz; No emissions were detected above the noise floor which was at least 20dB below the specification limit.

MID CHANNEL DATA

Trace Markers

Marker	Frequency (GHz)	Meter Reading (dBuV)	Det	3117_00168724	3GHz_HP[dB]	DC Corr (dB)	Corrected Reading (dBuV/m)	Avg Limit (dBuV/m)	Margin (dB)	Peak Limit (dBuV/m)	Margin (dB)	Azimuth (Degs)	Height (cm)	Polarity
1	* 4.884	28.53	PK	34	-27.8	0	34.73	-	-	74	-39.27	0-360	150	H
3	* 7.314	27.18	PK	36.2	-25	0	38.38	-	-	74	-35.62	0-360	150	H
5	9.758	24.87	PK	37.2	-21.5	0	40.57	-	-	74	-33.43	0-360	250	H
2	* 4.877	28.19	PK	34	-27.9	0	34.29	-	-	74	-39.71	0-360	250	V
4	* 7.312	26.71	PK	36.2	-25	0	37.91	-	-	74	-36.09	0-360	250	V
6	9.754	24.39	PK	37.2	-21.4	0	40.19	-	-	74	-33.81	0-360	250	V

* - indicates frequency in CFR47 Pt 15 / IC RSS-Restricted Band

PK – Peak Detector

Note: Only peak measurement was performed. Because peak measurement result of unwanted emission is less than average limit (54dBuV/m).

HIGH CHANNEL HORIZONTAL

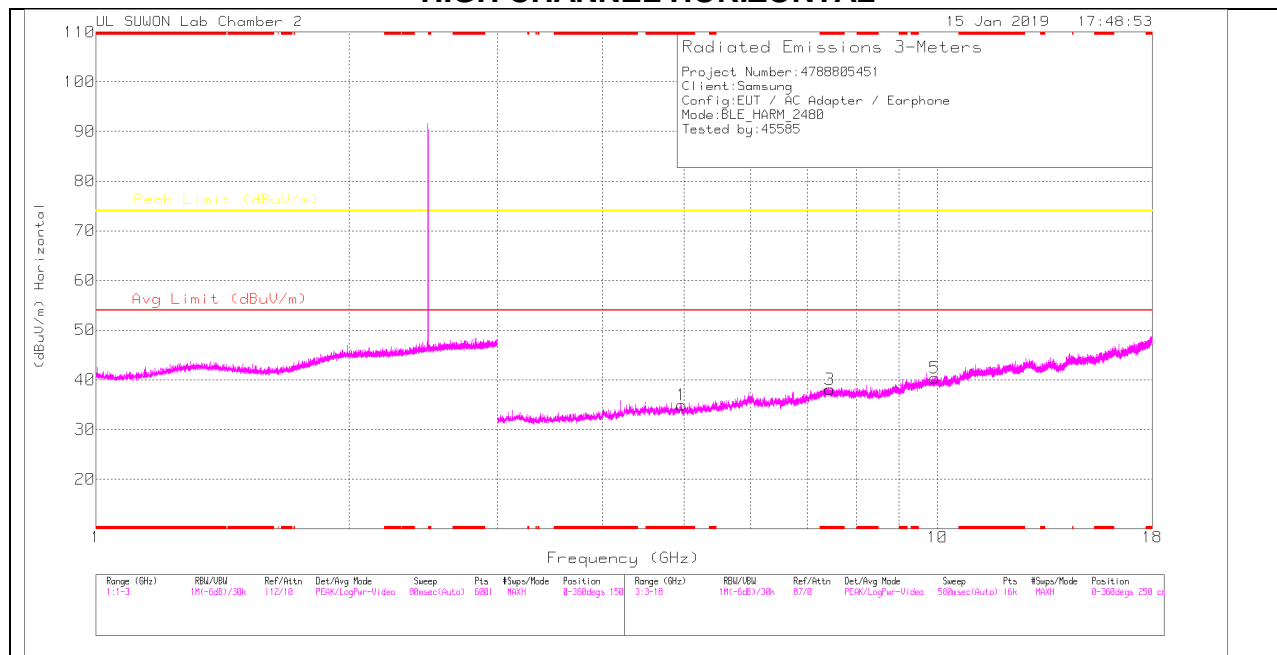

HIGH CHANNEL VERTICAL

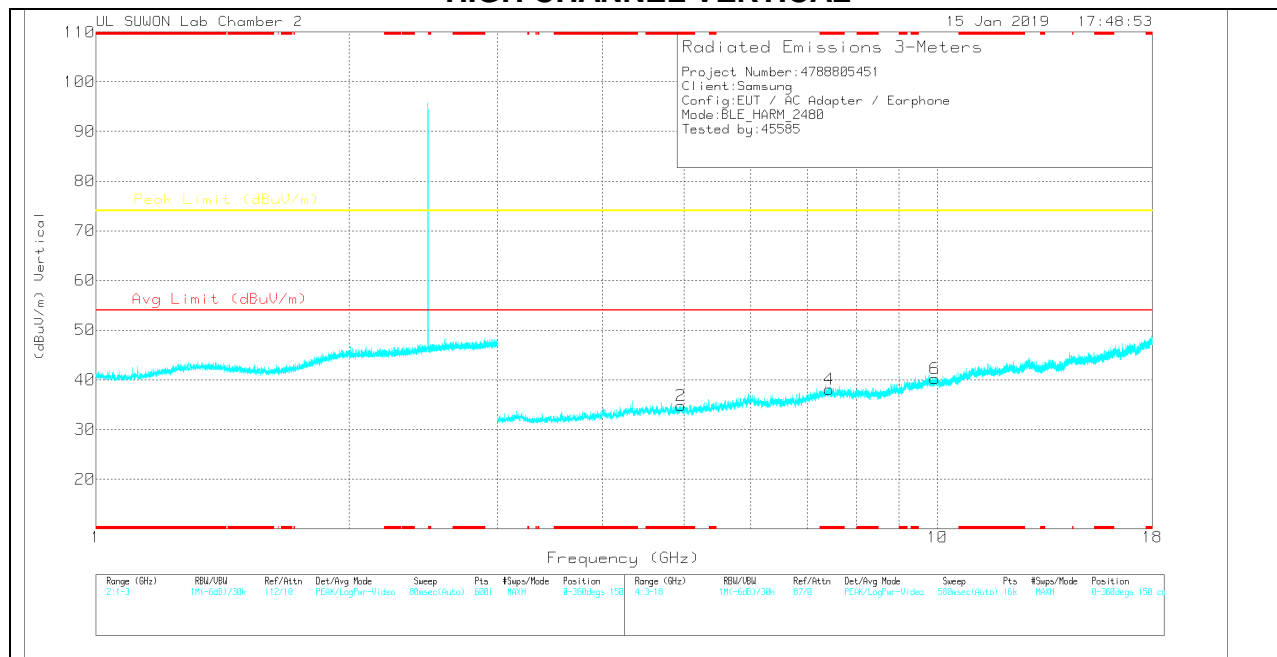

Note: Emission was scanned up to 26GHz; No emissions were detected above the noise floor which was at least 20dB below the specification limit.

HIGH CHANNEL DATA

Trace Markers

Marker	Frequency (GHz)	Meter Reading (dBuV)	Det	3117_00158724	3GHz_HP[dB]	DC Corr (dB)	Corrected Reading (dBuV/m)	Avg Limit (dBuV/m)	Margin (dB)	Peak Limit (dBuV/m)	Margin (dB)	Azimuth (Degs)	Height (cm)	Polarity
1	* 4.968	27.83	PK	34.1	-27	0	34.93	-	-	74	-39.07	0-360	150	H
3	* 7.443	26.04	PK	36.2	-24.1	0	38.14	-	-	74	-35.86	0-360	150	H
5	9.923	23.86	PK	37.4	-20.9	0	40.36	-	-	74	-33.64	0-360	250	H
2	* 4.958	27.74	PK	34.1	-27	0	34.84	-	-	74	-39.16	0-360	150	V
4	* 7.442	25.99	PK	36.2	-24.1	0	38.09	-	-	74	-35.91	0-360	250	V
6	9.926	23.79	PK	37.4	-21	0	40.19	-	-	74	-33.81	0-360	250	V

* - indicates frequency in CFR47 Pt 15 / IC RSS-Restricted Band
 PK – Peak Detector

Note: Only peak measurement was performed. Because peak measurement result of unwanted emission is less than average limit (54dBuV/m).

11.3. WORST-CASE BELOW 1 GHz

SPURIOUS EMISSIONS 30 TO 1000 MHz (1Mbps)

HORIZONTAL PLOT

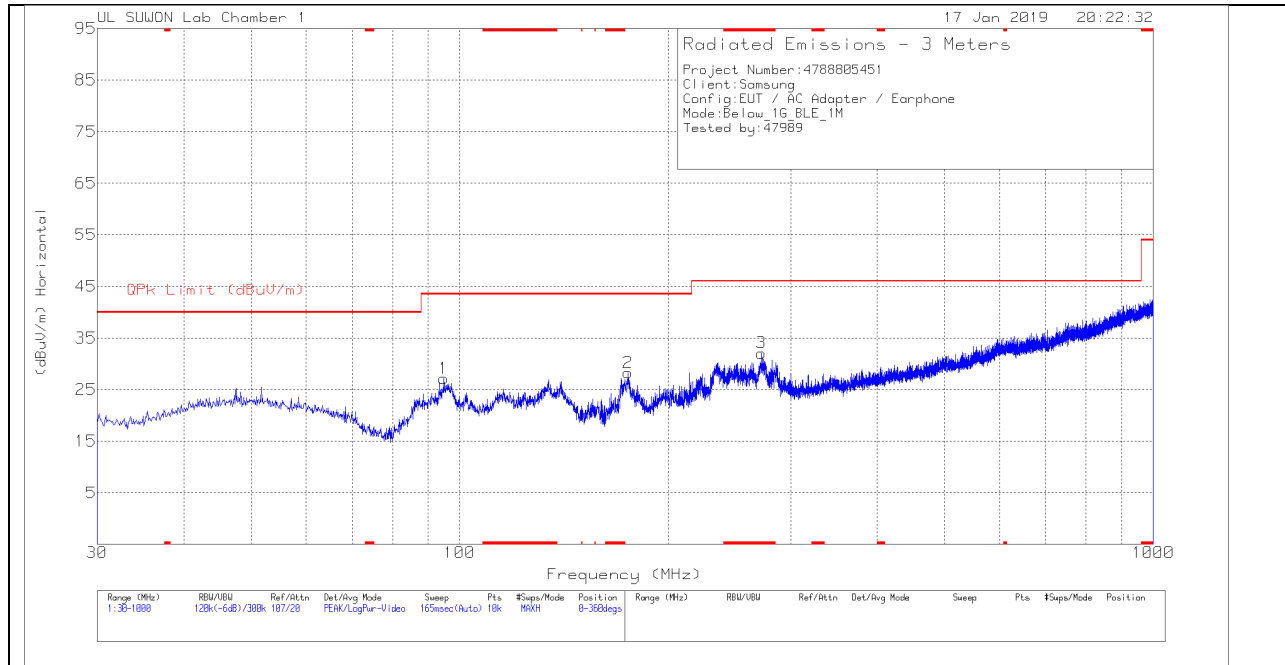

VERTICAL PLOT

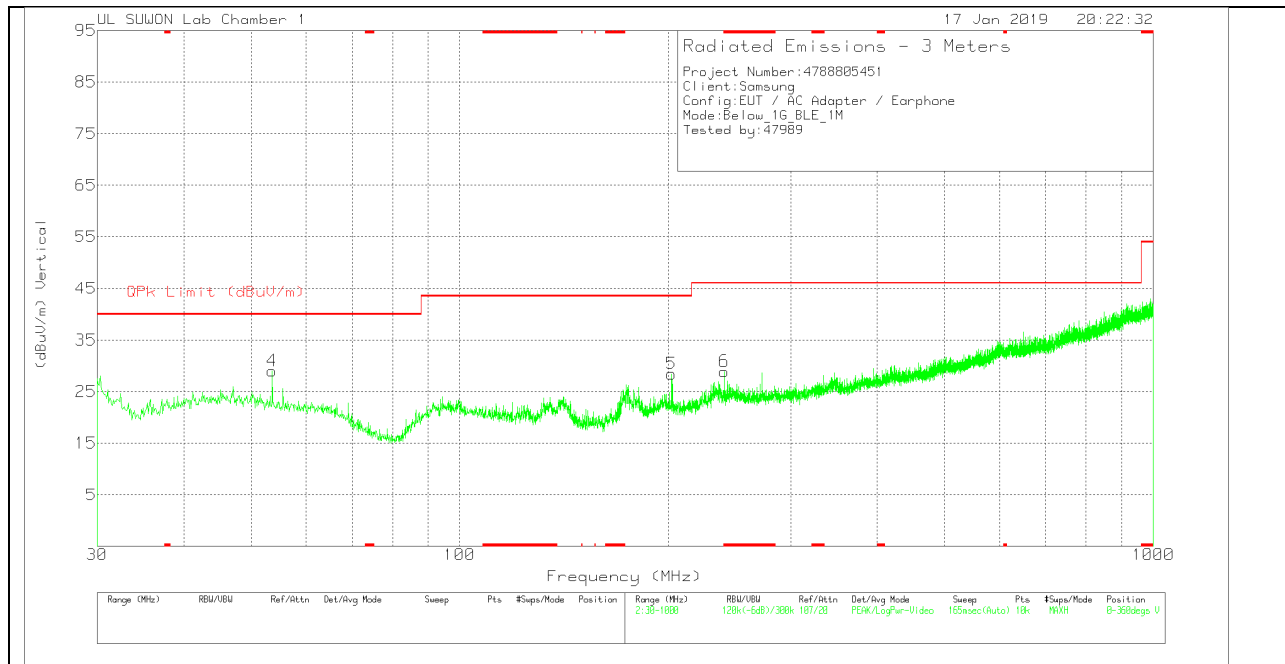

BELOW 1 GHz TABLE

Trace Markers

Marker	Frequency (MHz)	Meter Reading (dBuV)	Det	VULB9163_750	Below_1G[dB]	Corrected Reading (dBuV/m)	QPk Limit (dBuV/m)	Margin (dB)	Azimuth (Degs)	Height (cm)	Polarity
1	94.893	39.65	Pk	17.3	-29.8	27.15	43.52	-16.37	0-360	300	H
2	174.821	42.06	Pk	15	-28.8	28.26	43.52	-15.26	0-360	200	H
3	* 272.209	41.21	Pk	18.7	-27.8	32.11	46.02	-13.91	0-360	100	H
4	53.668	40.02	Pk	19.5	-30.5	29.02	40	-10.98	0-360	100	V
5	202.078	39.56	Pk	17.4	-28.5	28.46	43.52	-15.06	0-360	100	V
6	* 240.684	38.52	Pk	18.6	-28.2	28.92	46.02	-17.1	0-360	100	V

* - indicates frequency in CFR47 Pt 15 / IC RSS-Restricted Band
 Pk - Peak detector

SPURIOUS EMISSIONS 30 TO 1000 MHz (2Mbps)

HORIZONTAL PLOT

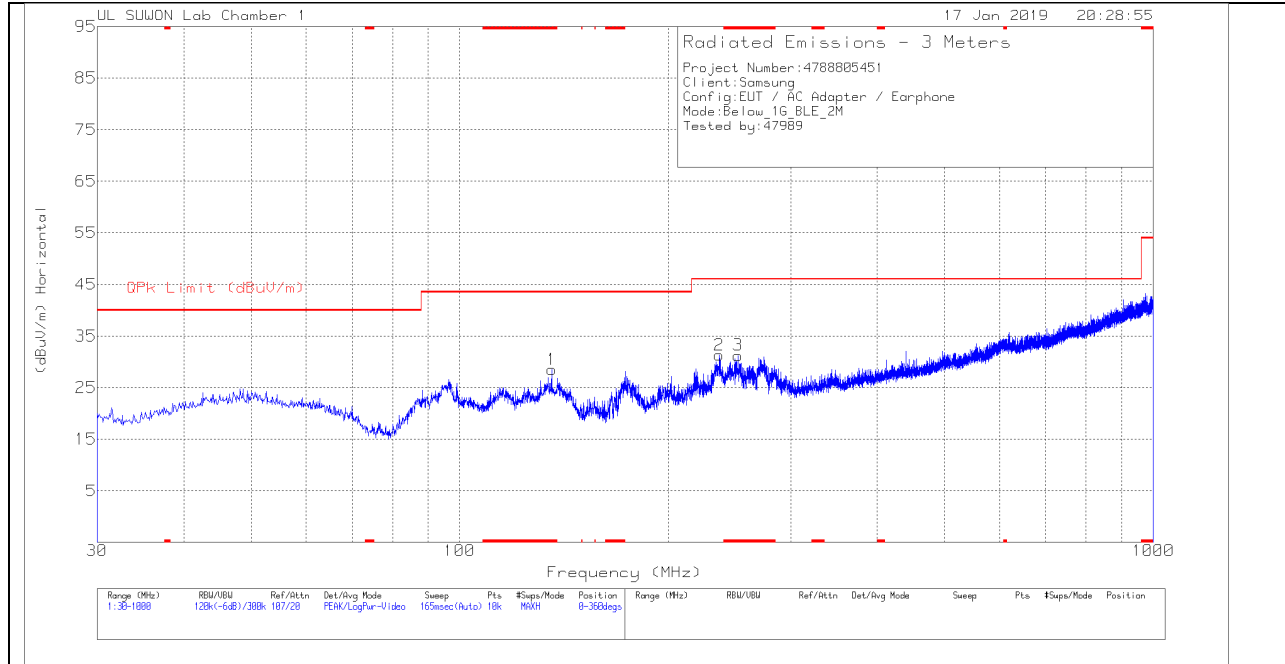

VERTICAL PLOT

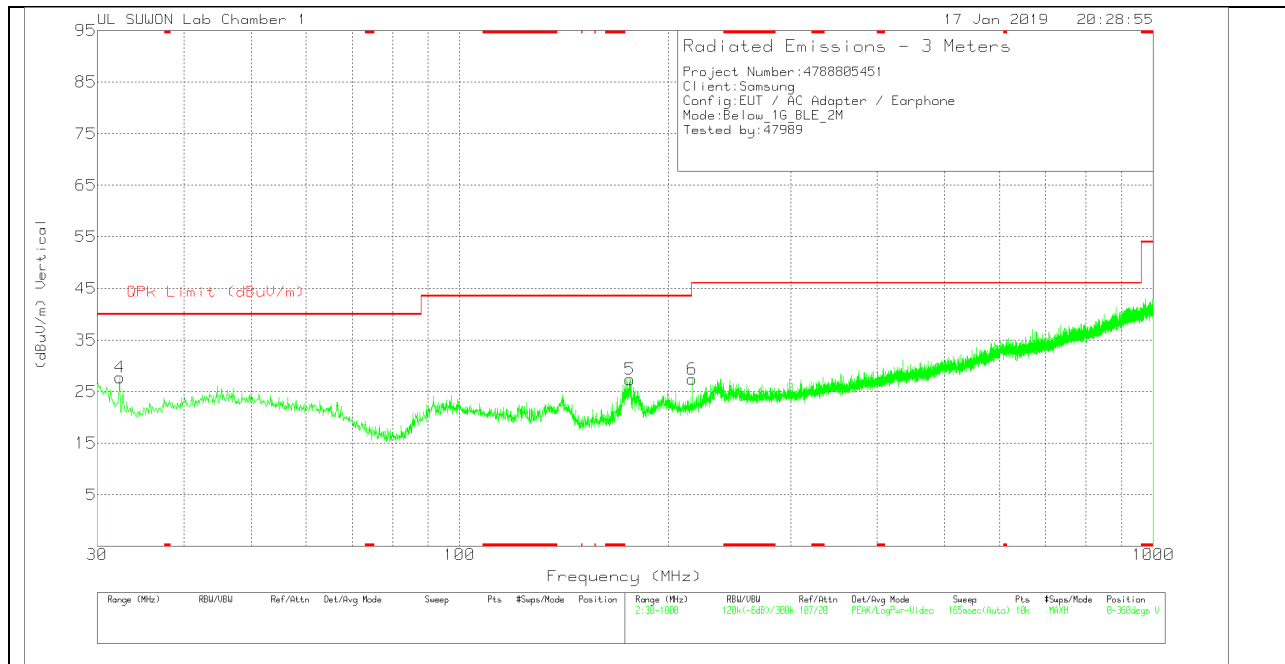

BELOW 1 GHz TABLE

Trace Markers

Marker	Frequency (MHz)	Meter Reading (dBuV)	Det	VULB9163_750	Below_1G[dB]	Corrected Reading (dBuV/m)	QPk Limit (dBuV/m)	Margin (dB)	Azimuth (Degs)	Height (cm)	Polarity
1	* 135.73	43.59	Pk	14.1	-29.2	28.49	43.52	-15.03	0-360	300	H
2	236.707	41.19	Pk	18.3	-28.2	31.29	46.02	-14.73	0-360	100	H
3	* 252.13	40.05	Pk	19.2	-28	31.25	46.02	-14.77	0-360	100	H
4	32.328	42.95	Pk	15.7	-30.9	27.75	40	-12.25	0-360	100	V
5	175.985	41.07	Pk	15.1	-28.8	27.37	43.52	-16.15	0-360	100	V
6	216.337	38.73	Pk	17.1	-28.4	27.43	46.02	-18.59	0-360	200	V

* - indicates frequency in CFR47 Pt 15 / IC RSS-Restricted Band

Pk - Peak detector

12. AC POWER LINE CONDUCTED EMISSIONS

LIMITS

FCC §15.207 (a)

Frequency of Emission (MHz)	Conducted Limit (dBuV)	
	Quasi-peak	Average
0.15-0.5	66 to 56	56 to 46
0.5-5	56	46
5-30	60	50

*Decreases with the logarithm of the frequency.

TEST PROCEDURE

The EUT is placed on a non-conducting table 40 cm from the vertical ground plane and 80 cm above the horizontal ground plane. The EUT is configured in accordance with ANSI C63.10.

The receiver is set to a resolution bandwidth of 9 kHz. Peak detection is used unless otherwise noted as quasi-peak or average.

Line conducted data is recorded for both NEUTRAL and HOT lines.

RESULTS

WORST EMISSIONS (1Mbps)

LINE 1 PLOT

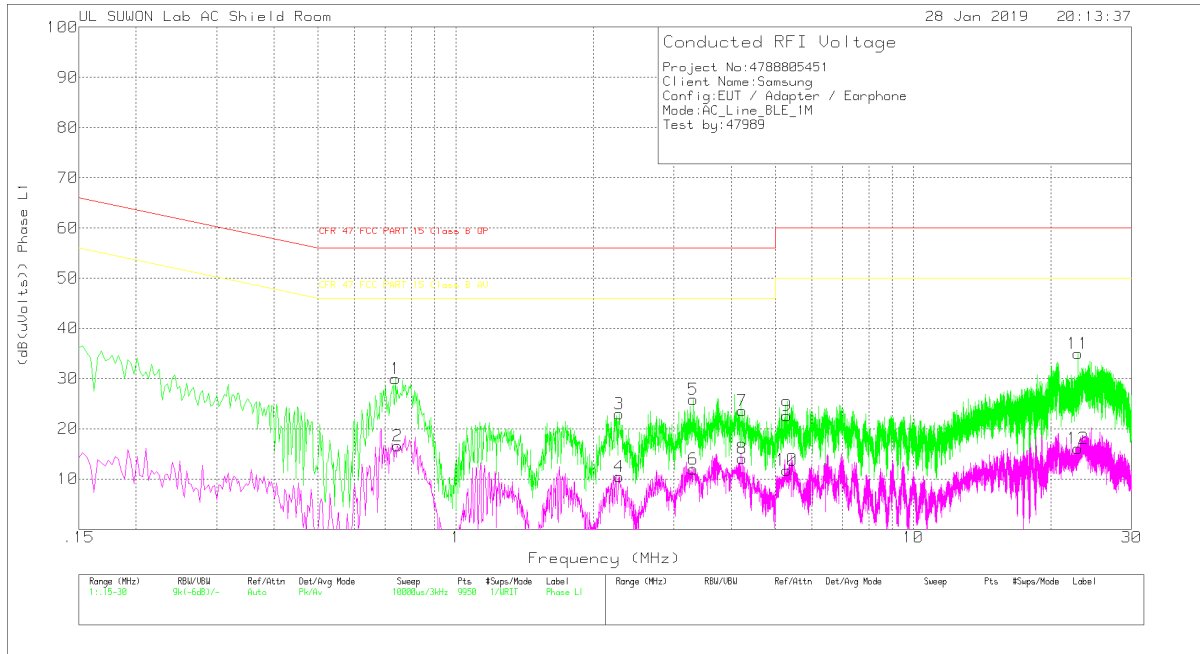

LINE 1 RESULTS

Trace Markers

Range 1: Phase L1 .15 - 30MHz

Marker	Frequency (MHz)	Meter Reading (dBuV)	Det	ENV216_10183 6_With ex-cord_L1	CABLELOSS(dB)	Corrected Reading (dB(uVolts))	CFR 47 FCC PART 15 Class B QP	Margin (dB)	CFR 47 FCC PART 15 Class B AV	Margin (dB)
1	.738	19.91	Pk	9.9	.2	30.01	56	-25.99	-	-
2	.747	6.49	Av	9.9	.2	16.59	-	-	46	-29.41
3	2.274	12.81	Pk	9.9	.3	23.01	56	-32.99	-	-
4	2.274	.22	Av	9.9	.3	10.42	-	-	46	-35.58
5	3.3	15.59	Pk	9.9	.3	25.79	56	-30.21	-	-
6	3.306	1.75	Av	9.9	.3	11.95	-	-	46	-34.05
7	4.227	13.54	Pk	9.8	.3	23.64	56	-32.36	-	-
8	4.23	3.97	Av	9.8	.3	14.07	-	-	46	-31.93
9	5.289	12.5	Pk	9.8	.3	22.6	60	-37.4	-	-
10	5.283	1.67	Av	9.8	.3	11.77	-	-	50	-38.23
11	22.902	24.02	Pk	10.6	.4	35.02	60	-24.98	-	-
12	22.896	5.09	Av	10.6	.4	16.09	-	-	50	-33.91

Pk - Peak detector

Av - Average detection

LINE 2 PLOT

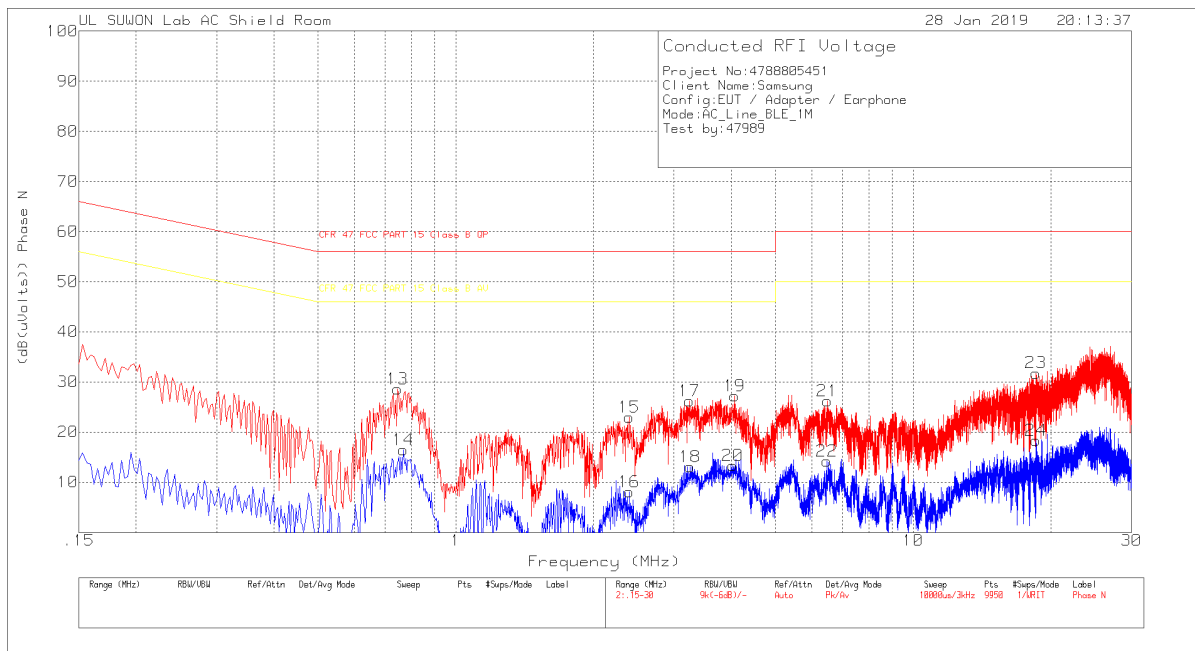

LINE 2 RESULTS

Trace Markers

Range 2: Phase N .15 - 30MHz

Marker	Frequency (MHz)	Meter Reading (dBuV)	Det	ENV216_10183 6_With ex-cord_N	CABLELOSS(dB)	Corrected Reading (dB(uVolts))	CFR 47 FCC PART 15 Class B QP	Margin (dB)	CFR 47 FCC PART 15 Class B AV	Margin (dB)
13	.747	18.48	Pk	9.9	.2	28.58	56	-27.42	-	-
14	.768	6.42	Av	9.8	.2	16.42	-	-	46	-29.58
15	2.394	12.95	Pk	9.7	.3	22.95	56	-33.05	-	-
16	2.394	-1.93	Av	9.7	.3	8.07	-	-	46	-37.93
17	3.24	16.18	Pk	9.7	.3	26.18	56	-29.82	-	-
18	3.249	3.14	Av	9.7	.3	13.14	-	-	46	-32.86
19	4.065	17.12	Pk	9.8	.3	27.22	56	-28.78	-	-
20	4.026	3.23	Av	9.8	.3	13.33	-	-	46	-32.67
21	6.501	15.98	Pk	9.9	.3	26.18	60	-33.82	-	-
22	6.477	3.97	Av	9.9	.3	14.17	-	-	50	-35.83
23	18.543	20.99	Pk	10.4	.4	31.79	60	-28.21	-	-
24	18.564	7.53	Av	10.4	.4	18.33	-	-	50	-31.67

Pk - Peak detector

Av - Average detection

WORST EMISSIONS (2Mbps)

LINE 1 PLOT

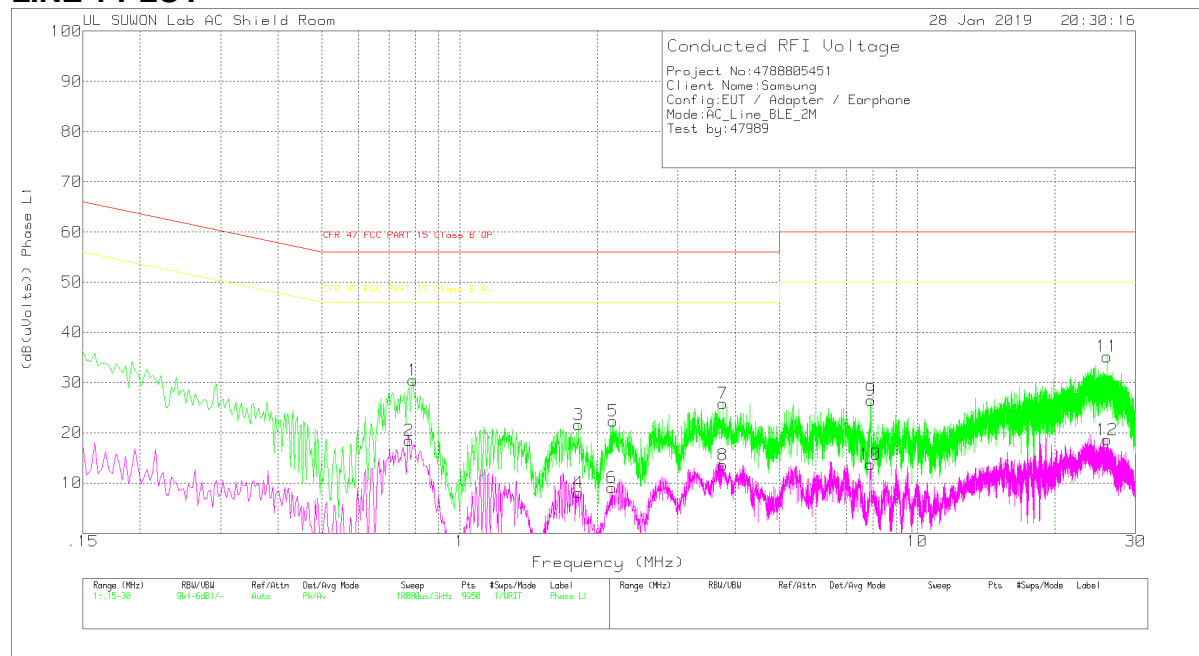

LINE 1 RESULTS

Trace Markers

Range 1: Phase L1 .15 - 30MHz

Marker	Frequency (MHz)	Meter Reading (dBuV)	Det	ENV216_10183 6_With ex-cord_L1	CABLELOSS(dB)	Corrected Reading (dB(uVolts))	CFR 47 FCC PART 15 Class B QP	Margin (dB)	CFR 47 FCC PART 15 Class B AV	Margin (dB)
1	.789	20.32	Pk	9.9	.2	30.42	56	-25.58	-	-
2	.774	8.33	Av	9.9	.2	18.43	-	-	46	-27.57
3	1.821	11.49	Pk	9.8	.3	21.59	56	-34.41	-	-
4	1.818	-1.99	Av	9.8	.3	8.11	-	-	46	-37.89
5	2.166	12.21	Pk	9.8	.3	22.31	56	-33.69	-	-
6	2.148	-1.05	Av	9.8	.3	9.05	-	-	46	-36.95
7	3.756	15.76	Pk	9.8	.3	25.86	56	-30.14	-	-
8	3.756	3.54	Av	9.8	.3	13.64	-	-	46	-32.36
9	7.914	16.33	Pk	9.9	.3	26.53	60	-33.47	-	-
10	7.902	3.51	Av	9.9	.3	13.71	-	-	50	-36.29
11	25.977	24.17	Pk	10.7	.3	35.17	60	-24.83	-	-
12	25.977	7.64	Av	10.7	.3	18.64	-	-	50	-31.36

Pk - Peak detector

Av - Average detection

LINE 2 PLOT

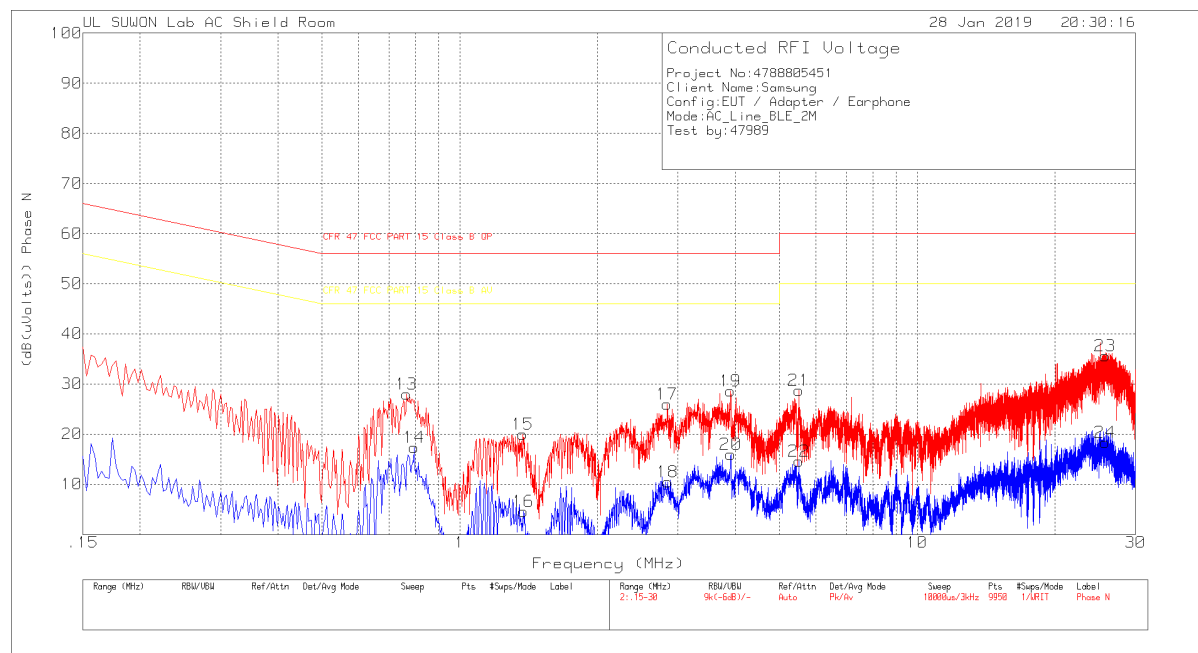

LINE 2 RESULTS

Trace Markers

Range 2: Phase N .15 - 30MHz

Marker	Frequency (MHz)	Meter Reading (dBuV)	Det	ENV216_10183 6_With ex-cord_N	CABLELOSS(dB)	Corrected Reading (dB(uVolts))	CFR 47 FCC PART 15 Class B QP	Margin (dB)	CFR 47 FCC PART 15 Class B AV	Margin (dB)
13	.765	17.97	Pk	9.8	.2	27.97	56	-28.03	-	-
14	.795	7.31	Av	9.8	.2	17.31	-	-	46	-28.69
15	1.374	9.91	Pk	9.7	.3	19.91	56	-36.09	-	-
16	1.377	-5.4	Av	9.7	.3	4.6	-	-	46	-41.4
17	2.841	15.92	Pk	9.7	.3	25.92	56	-30.08	-	-
18	2.844	.47	Av	9.7	.3	10.47	-	-	46	-35.53
19	3.909	18.48	Pk	9.8	.3	28.58	56	-27.42	-	-
20	3.912	5.84	Av	9.8	.3	15.94	-	-	46	-30.06
21	5.508	18.68	Pk	9.8	.3	28.78	60	-31.22	-	-
22	5.508	4.44	Av	9.8	.3	14.54	-	-	50	-35.46
23	25.761	24.49	Pk	10.8	.3	35.59	60	-24.41	-	-
24	25.752	7.27	Av	10.8	.3	18.37	-	-	50	-31.63

Pk - Peak detector

Av - Average detection