



16. SETUP PHOTOGRAPHS

See following Attached Pages for setup photographs.

PCTEST™ HAC REPORT		C63.19-2006 v3.12 TEST REPORT		Reviewed by: Quality Manager
HAC Filename: 0606070471	Test Dates: June 19 - 20, 2006	EUT Type: Dual-Band GSM/PCS GPRS/EDGE Phone with Bluetooth	FCC ID: A3LSGHD407T	Page 68 of 70

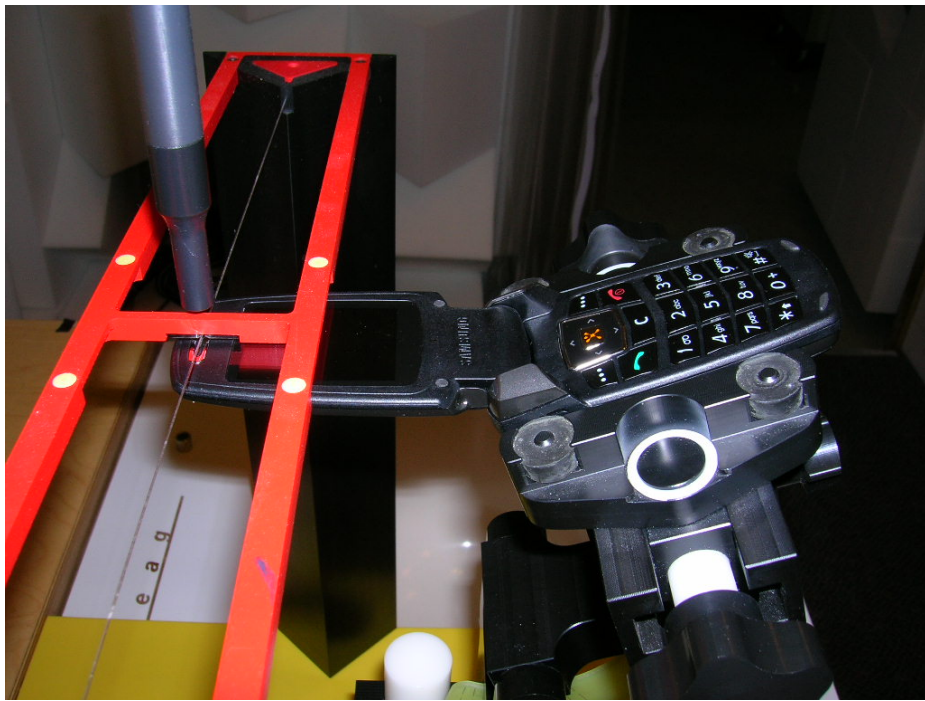

Figure 16-1

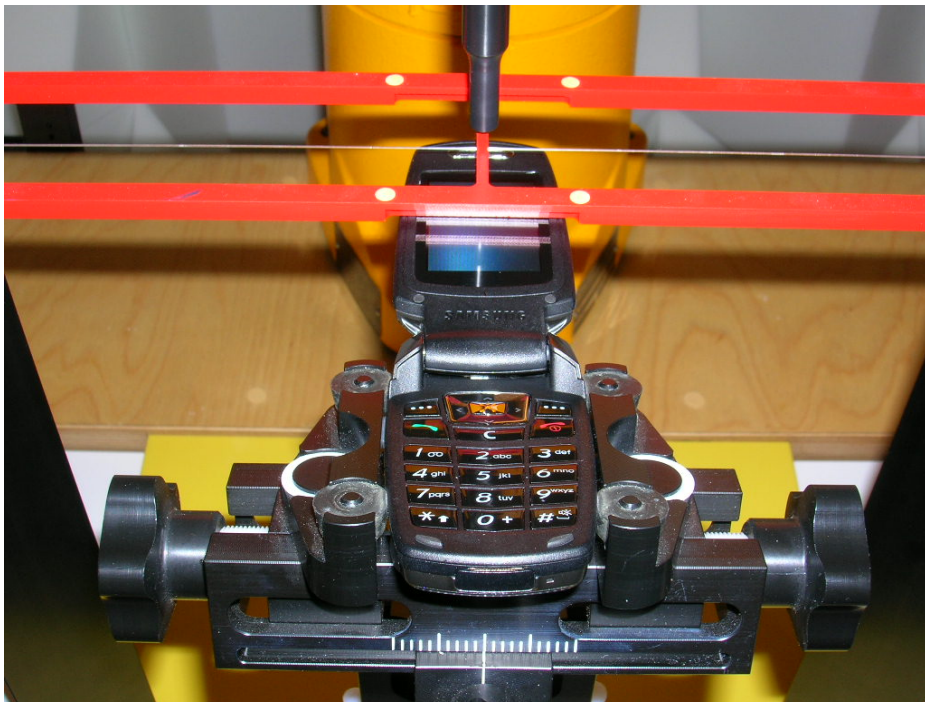



Figure 16-2

PCTEST™ HAC REPORT		C63.19-2006 v3.12 TEST REPORT		Reviewed by: Quality Manager
HAC Filename: 0606070471	Test Dates: June 19 - 20, 2006	EUT Type: Dual-Band GSM/PCS GPRS/EDGE Phone with Bluetooth	FCC ID: A3LSGHD407T	Page 69 of 70

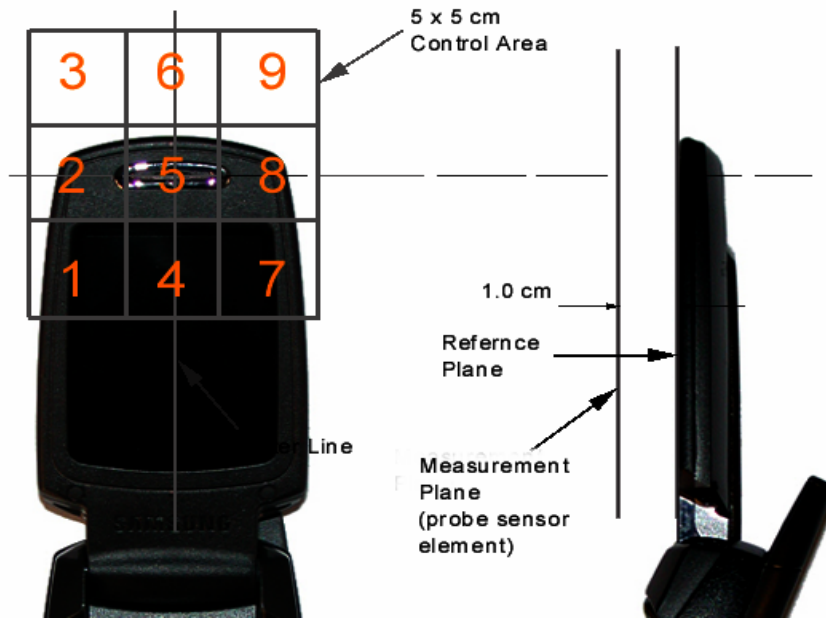

Figure 16-3 5x5 Scan grid above WD



Figure 16-4
E-Field WD Scan overlay



Figure 16-5
H-Field WD Scan overlay

PCTEST™ HAC REPORT	PCTEST	C63.19-2006 v3.12 TEST REPORT	SAMSUNG	Reviewed by: Quality Manager
HAC Filename: 0606070471	Test Dates: June 19 - 20, 2006	EUT Type: Dual-Band GSM/PCS GPRS/EDGE Phone with Bluetooth	FCC ID: A3LSGHD407T	Page 70 of 70