

SAR TEST REPORT

Equipment Under Test	:	Digital Camera
Model No.	:	NX1000
Applicant	:	Samsung Electronics Co., Ltd.
Address of Applicant	:	416, Maetan-dong, Yeongtong-gu, Suwon-city, Gyeonggi-do, Korea
FCC ID	:	A3LNX1000
IC ID	:	649E-NX1000
Device Category	:	Portable Device
Exposure Category	:	General Population /Uncontrolled Exposure
Date of Receipt	:	2012-04-06
Date of Test(s)	:	2012-04-16
Date of Issue	:	2012-04-17
Max. SAR	:	0.532 W/kg (11b)

Standards: **FCC OET Bulletin 65 supplement C**
 RSS-102 (Issue 4)
 IEEE 1528, 2003
 ANSI/IEEE C95.1, C95.3

In the configuration tested, the EUT complied with the standards specified above.

Remarks:

This report details the results of the testing carried out on one sample, the results contained in this test report do not relate to other samples of the same product. The manufacturer should ensure that all products in series production are in conformity with the product sample detailed in this report.

This report may only be reproduced and distributed in full. If the product in this report is used in any configuration other than that detailed in the report, the manufacturer must ensure the new system complies with all relevant standards. Any mention of SGS Testing Korea Co., Ltd. or testing done by SGS Testing Korea Co., Ltd. in connection with distribution or use of the product described in this report must be approved by SGS Testing Korea Co., Ltd. in writing.

Tested by	:	Fred Jeong 	2012-04-17
Approved by	:	Charles Kim 	2012-04-17

Contents

1. General Information

1.1	Testing Laboratory.....	3
1.2	Details of Applicant.....	3
1.3	Version of Report.....	3
1.4	Description of EUT(s).....	3
1.5	Test Environment.....	3
1.6	Operation description.....	4
1.7	Evaluation procedures.....	4
1.8	The SAR Measurement System.....	5
1.9	System Components.....	7
1.10	SAR System Verification.....	8
1.11	Tissue Simulant Fluid for the Frequency Band.....	10
1.12	Test Standards and Limits.....	11
1.13	Justification for Extended SAR Dipole Calibrations.....	12

2 Instruments List..... 13

3 Summary of Results 14

3.1	FCC Power Measurement Procedures.....	14
3.2	RF Conducted Power.....	14
3.3	SAR Test Configuration	16
3.4	Still cameras and video cameras Test position	17

APPENDIX

A. DASY4 SAR Report

B. Uncertainty Analysis

C. Calibration certificate

1. General Information

1.1 Testing Laboratory

SGS Korea Co., Ltd.
 Wireless Div. 2FL, 18-34, Sanbon-dong, Gunpo-si, Gyeonggi-do, Korea 435-040
 Telephone : +82 +31 428 5700
 FAX : +82 +31 427 2371
 Homepage : www.ee.sgs.com/Korea

1.2 Details of Applicant

Manufacturer : Samsung Electronics Co., Ltd.
 Address : 416, Maetan-dong, Yeongtong-gu, Suwon-city, Gyeonggi-do, Korea
 Contact Person : sungjo- Hwang
 Phone No. : +82 +31 277 8583
 E-mail : sj112.hwang@samsung.com

1.3 Version of Report

Version Number	Date	Revision
00	2012-04-17	Initial issue

1.4 Description of EUT(s)

EUT Type	: Digital Camera
Model	: NX1000
Serial Number	: 0067940
Mode of Operation	: WLAN
Body worn Accessory	: None
Tx Frequency Range	: 2412 MHz ~ 2462 MHz (WLAN)
Max. Conducted RF Power	: 16.13 dB m (WLAN)
Battery Type	: DC 7.4 V (Li-ion Battery)

1.5 Test Environment

Ambient temperature	: (22 ± 2) ° C
Tissue Simulating Liquid	: (22 ± 2) ° C
Relative Humidity	: (55 ± 5) % R.H.

1.6 Operation Configuration

The client provided a special driver and test program which can control the frequency and power of the WLAN module. Measurements were performed at the lowest, middle and highest channels of the operating band. The EUT was set to maximum power level during all tests and at the beginning of each test the battery was fully charged.

The DASY4 system measures power drift during SAR testing by comparing e-field in the same location at the beginning and at the end of measurement.

1.7 EVALUATION PROCEDURES

- Power Reference Measurement Procedures

The Power Reference Measurement and Power Drift Measurements are for monitoring the power drift of the device under test in the batch process. The Minimum distance of probe sensors to surface determines the closest measurement point to phantom surface. The minimum distance of probe sensors to surface is 4 mm. This distance cannot be smaller than the Distance of sensor calibration points to probe tip as defined in the probe properties (for example, 2.7 mm for an ET3DV6 probe type).

- The entire evaluation of the spatial peak values is performed within the Post-processing engine (SEMCAD). The system always gives the maximum values for the 1g and 10g cubes. The algorithm to find the cube with highest averaged SAR is divided into the following stages:

1. The extraction of the measured data (grid and values) from the Zoom Scan.
2. The calculation of the SAR value at every measurement point based on all stored data (A/D values and measurement parameters)
3. The generation of a high-resolution mesh within the measured volume
4. The interpolation of all measured values from the measurement grid to the high-resolution grid
5. The extrapolation of the entire 3-D field distribution to the phantom surface over the distance from sensor to surface
6. The calculation of the averaged SAR within masses of 1g and 10g.

The probe is calibrated at the center of the dipole sensors that is located 1 to 2.7 mm away from the probe tip. During measurements, the probe stops shortly above the phantom surface, depending on the probe and the surface detecting system. Both distances are included as parameters in the probe configuration file. The software always knows exactly how far away the measured point is from the surface. As the probe cannot directly measure at the surface, the values between the deepest measured point and the surface must be extrapolated. The angle between the probe axis and the surface normal line is less than 30 degree.

In the Area Scan, the gradient of the interpolation function is evaluated to find all the extreme of the SAR distribution. The uncertainty on the locations of the extreme is less than 1/20 of the grid size. Only local maximum within -2 dB of the global maximum are searched and passed for the Cube Scan measurement. In the Cube Scan, the interpolation function is used to extrapolate the Peak SAR from the lowest

measurement points to the inner phantom surface (the extrapolation distance). The uncertainty increases with the extrapolation distance. To keep the uncertainty within 1% for the 1g and 10g cubes, the extrapolation distance should not be larger than 5 mm.

The maximum search is automatically performed after each area scan measurement. It is based on splines in two or three dimensions. The procedure can find the maximum for most SAR distributions even with relatively large grid spacing. After the area scanning measurement, the probe is automatically moved to a position at the interpolated maximum. The following scan can directly use this position for reference, e.g., for a finer resolution grid or the cube evaluations. The 1g and 10g peak evaluations are only available for the predefined cube 7x7x7 scans. The routines are verified and optimized for the grid dimensions used in these cube measurements. The measured volume of 30x30x30 mm contains about 30g of tissue. The first procedure is an extrapolation (incl. Boundary correction) to get the points between the lowest measured plane and the surface. The next step uses 3D interpolation to get all points within the measured volume. In the last step, a 1g cube is placed numerically into the volume and its averaged SAR is calculated. This cube is moved around until the highest averaged SAR is found. If the highest SAR is found at the edge of the measured volume, the system will issue a warning: higher SAR values might be found outside of the measured volume. In that case the cube measurement can be repeated, using the new interpolated maximum as the center.

1.8 The SAR Measurement System

A photograph of the SAR measurement System is given in Fig. a. This SAR Measurement System uses a Computer-controlled 3-D stepper motor system (Speag Dasy 4 professional system). A Model ET3DV6 1782 E-field probe is used to determine the internal electric fields. The SAR can be obtained from the equation $SAR = \sigma (|E_i|^2) / \rho$ where σ and ρ are the conductivity and mass density of the tissue-simulant. The DASY4 system for performing compliance tests consists of the following items:

- A standard high precision 6-axis robot (Staubli RX family) with controller, teach pendant and software. An arm extension for accommodating the data acquisition electronics (DAE).
- A dosimeter probe, i.e., an isotropic E-field probe optimized and calibrated for usage in tissue simulating liquid. The probe is equipped with an optical surface detector system.
- A data acquisition electronics (DAE) which performs the signal amplification, signal multiplexing, AD-conversion, offset measurements, mechanical surface detection, collision detection, etc. The unit is battery powered with standard or rechargeable batteries. The signal is optically transmitted to the EOC.

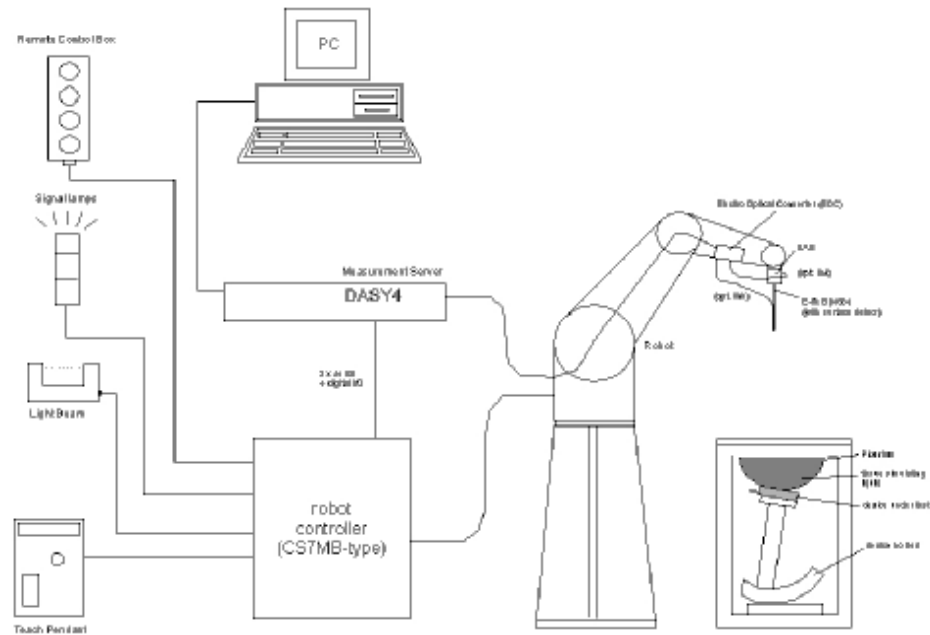

Fig a. The microwave circuit arrangement used for SAR system verification

- The Electro-optical converter (EOC) performs the conversion between optical and electrical of the signals for the digital communication to the DAE and for the analog signal from the optical surface detection. The EOC is connected to the measurement server.
- The function of the measurement server is to perform the time critical tasks such as signal filtering, control of the robot operation and fast movement interrupts.
- A probe alignment unit which improves the (absolute) accuracy of the probe positioning.
- A computer operating Windows 2000 or Windows XP.
- DASY4 software.
- Remote control with teach pendant and additional circuitry for robot safety such as warning lamps, etc.
- The SAM twin phantom enabling testing left-hand and right-hand usage.
- The device holder for handheld mobile phones.
- Tissue simulating liquid mixed according to the given recipes.
- Validation dipole kits allowing to validate the proper functioning of the system.

1.9 System Components

ES3DV3 E-Field Probe

- Construction** : Symmetrical design with triangular core Built-in shielding against static charges PEEK enclosure material (resistant to organic solvents, e.g. glycol).
- Calibration** : In air from 10 MHz to 4 GHz In brain simulating tissue (accuracy $\pm 8\%$)
- Frequency** : 10 MHz to >4 GHz; Linearity: ± 0.2 dB (30 MHz to 4 GHz)
- Directivity** : ± 0.2 dB in brain tissue (rotation around probe axis)
 ± 0.3 dB in brain tissue (rotation normal to probe axis)
- Dynamic Range** : $5 \mu\text{W/g}$ to >100 mW/g; Linearity: ± 0.2 dB
- Srfce. Detect** : ± 0.2 mm repeatability in air and clear liquids over diffuse reflecting surfaces
- Dimensions** : Overall length: 337 mm
 Tip length: 3.9 mm
 Body diameter: 12 mm
 Tip diameter: 6.8 mm
 Distance from probe tip to dipole centers: 2.0 mm
- Application** : General dosimetry up to 4 GHz Compliance tests of mobile phone



ES3DV3 E-Field Probe

NOTE:

1. The Probe parameters have been calibrated by the SPEAG. Please reference "APPENDIX C" for the Calibration Certification Report.

SAM Phantom

Construction: The SAM Phantom is constructed of a fiberglass shell integrated in a wooden table. The shape of the shell is based on data from an anatomical study designed to determine the maximum exposure in at least 90% of all users. It enables the dosimetric evaluation of left and right hand phone usage as well as body mounted usage at the flat phantom region. A cover prevents the evaporation of the liquid. Reference markings on the Phantom allow the complete setup of all predefined phantom positions and measurement grids by manually teaching three points in the robot

Shell Thickness: 2.0 ± 0.1 mm
Filling Volume: Approx. 25 liters



SAM Phantom

DEVICE HOLDER

Construction In combination with the Twin SAM Phantom V4.0/V4.0C or Twin SAM, the Mounting Device (made from POM) enables the rotation of the mounted transmitter in spherical coordinates, whereby the rotation point is the ear opening. The devices can be easily and accurately positioned according to IEC, IEEE, CENELEC, FCC or other specifications. The device holder can be locked at different phantom locations (left head, right head, flat phantom).



Device Holder

1.10 SAR System Verification

The microwave circuit arrangement for system verification is sketched in Fig. b. The daily system accuracy verification occurs within the flat section of the SAM phantom. A SAR measurement was performed to see if the measured SAR was within +/- 10% from the target SAR values. This test was done at 2450 MHz. The test for EUT was conducted within 24 hours after each validation. The obtained result from the system accuracy verification is displayed in the table 1 (SAR values are normalized to 1W forward power delivered to the dipole). During the test, the ambient temperature of the laboratory was in the range $(22 \pm 2)^\circ\text{C}$, the relative humidity was in the range $(55 \pm 5)\%$ R.H. and the liquid depth above the ear reference points was above 15 cm in all the cases. It is seen that the system is operating within its specification, as the result is within acceptable tolerance of the reference value.

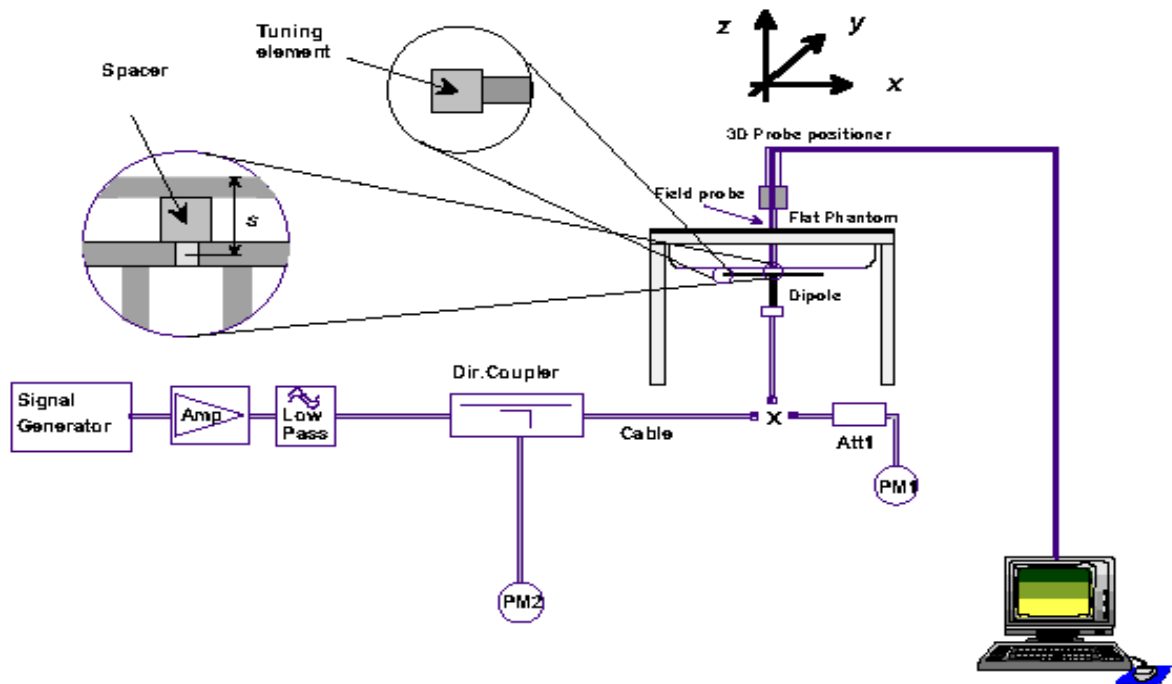

Fig b. The microwave circuit arrangement used for SAR system verification

- A. Agilent Model E4421B Signal Generator
- B. EMPOWER Model 2001-BBS3Q7ECK Amplifier
- C. Agilent Model E4419B Power Meter
- D. Agilent Model 9300H Power Sensor
- E. Agilent Model 777D/778D Dual directional coupling
- F. Reference dipole Antenna

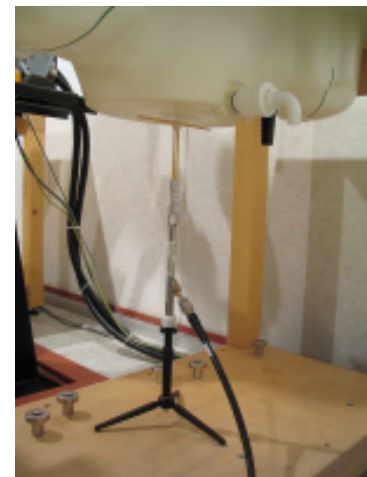

Fig c. Photo of the dipole Antenna

System Validation Results

Validation Kit	Tissue	Input Power (W)	Measured SAR 1g	Target SAR 1 g (Normalized to 1 W)	Measured SAR 1 g (Normalized to 1 W)	Deviation (%)	Date	Liquid Temp. (°C)
D2450V2 S/N: 734	2450 MHz Body	0.1	5.23	53.50 W/kg	52.30 W/kg	-2.24	2012-04-16	22.1

Table 1. Results system validation

1.11 Tissue Simulant Fluid for the Frequency Band

The dielectric properties for this simulant fluid were measured by using the Agilent Model 85070D Dielectric Probe (rates frequency band 200 MHz to 20 GHz) in conjunction with Agilent E5070B Network Analyzer(300 kHz-3000 MHz) by using a procedure detailed in Section V.

f (MHz)	Tissue type	Limits / Measured	Dielectric Parameters		
			Permittivity	Conductivity	Simulated Tissue Temp(°C)
2450	Body	Measured, 2012-04-16	51.7	1.98	22.1
		Recommended Limits	52.7	1.95	21.0 ~ 23.0
		Deviation(%)	<u>-1.90</u>	<u>1.54</u>	<u>22.1</u>
2412		Measured, 2012-04-16	51.7	1.93	21.0 ~ 23.0
		Deviation(%)	<u>-1.71</u>	<u>-1.03</u>	<u>22.1</u>
2437		Measured, 2012-04-16	51.7	1.96	21.0 ~ 23.0
		Deviation(%)	<u>-1.90</u>	<u>0.51</u>	<u>22.1</u>
2462		Measured, 2012-04-16	51.6	2.00	21.0 ~ 23.0
		Deviation(%)	<u>-2.09</u>	<u>2.56</u>	<u>22.1</u>

Typical composition of ingredients for liquid liquid tissue phantoms

The following tissue formulations are provided for reference only as some of the parameters have not been thoroughly verified. The composition of ingredients may be modified accordingly to achieve the desired target tissue parameters required for routine SAR evaluation.

Ingredients (% by weight)	Frequency (MHz)									
	450		835		915		1900		2450	
Tissue Type	Head	Body	Head	Body	Head	Body	Head	Body	Head	Body
Water	38.56	51.16	41.45	52.4	41.05	56.0	54.9	40.4	62.7	73.2
Salt (NaCl)	3.95	1.49	1.45	1.4	1.35	0.76	0.18	0.5	0.5	0.04
Sugar	56.32	46.78	56.0	45.0	56.5	41.76	0.0	58.0	0.0	0.0
HEC	0.98	0.52	1.0	1.0	1.0	1.21	0.0	1.0	0.0	0.0
Bactericide	0.19	0.05	0.1	0.1	0.1	0.27	0.0	0.1	0.0	0.0
Triton X-100	0.0	0.0	0.0	0.0	0.0	0.0	0.0	0.0	36.8	0.0
DGBE	0.0	0.0	0.0	0.0	0.0	0.0	44.92	0.0	0.0	26.7
Dielectric Constant	43.5	56.7	41.5	55.2	42.0	56.8	40.0	53.3	39.2	52.7
Conductivity (S/m)	0.87	0.94	0.90	0.97	1.0	1.07	1.40	1.52	1.80	1.95

Salt: 99⁺% Pure Sodium Chloride

Sugar: 98⁺% Pure Sucrose

Water: De-ionized, 16 MΩ⁺ resistivity

HEC: Hydroxyethyl Cellulose

DGBE: 99⁺% Di(ethylene glycol) butyl ether, [2-(2-butoxyethoxy)ethanol]

Triton X-100 (ultra pure): Polyethylene glycol mono [4-(1,1, 3, 3-tetramethylbutyl)phenyl]ether

1.12 Test Standards and Limits

According to FCC 47CFR §2.1093(d) The limits to be used for evaluation are based generally on criteria published by the American National Standards Institute (ANSI) for localized specific absorption rate (“SAR”) in Section 4.2 of “IEEE Standard for Safety Levels with Respect to Human Exposure to Radio Frequency Electromagnetic Fields, 3 kHz to 300 GHz,” ANSI/IEEE C95.3–2003, Copyright 2003 by the Institute of Electrical and Electronics Engineers, Inc., New York, New York 10017. These criteria for SAR evaluation are similar to those recommended by the National Council on Radiation Protection and Measurements (NCRP) in “Biological Effects and Exposure Criteria for Radio frequency Electromagnetic Fields,” NCRP Report No. 86, Section 17.4.5. Copyright NCRP, 1986, Bethesda, Maryland 20814. SAR is a measure of the rate of energy absorption due to exposure to an RF transmitting source. SAR values have been related to threshold levels for potential biological hazards. The criteria to be used are specified in paragraphs (d)(1) and (d)(2) of this section and shall apply for portable devices transmitting in the frequency range from 100 kHz to 6 GHz. Portable devices that transmit at frequencies above 6 GHz are to be evaluated in terms of the MPE limits specified in § 1.1310 of this chapter. Measurements and calculations to demonstrate compliance with MPE field strength or power density limits for devices operating above 6 GHz should be made at a minimum distance of 5 cm from the radiating source.

(1) Limits for Occupational/Controlled exposure: 0.4 W/kg as averaged over the whole-body and spatial peak SAR not exceeding 8 W/kg as averaged over any 1 gram of tissue (defined as a tissue volume in the shape of a cube). Exceptions are the hands, wrists, feet and ankles where the spatial peak SAR shall not exceed 20 W/kg, as averaged over an 10 grams of tissue (defined as a tissue volume in the shape of a cube). Occupational/Controlled limits apply when persons are exposed as a consequence of their employment provided these persons are fully aware of and exercise control over their exposure. Awareness of exposure can be accomplished by use of warning labels or by specific training or education through appropriate means, such as an RF safety program in a work environment.

(2) Limits for General Population/Uncontrolled exposure: 0.08 W/kg as averaged over the whole-body and spatial peak SAR not exceeding 1.6 W/kg as averaged over any 1 gram of tissue (defined as a tissue volume in the shape of a cube). Exceptions are the hands, wrists, feet and ankles where the spatial peak SAR shall not exceed 4 W/kg, as averaged over any 10 grams of tissue (defined as a tissue volume in the shape of a cube). General Population/Uncontrolled limits apply when the general public may be exposed, or when persons that are exposed as a consequence of their employment may not be fully aware of the potential for exposure or do not exercise control over their exposure. Warning labels placed on consumer devices such as cellular telephones will not be sufficient reason to allow these devices to be evaluated subject to limits for occupational/controlled exposure in paragraph (d)(1) of this section.(Table .4)

Human Exposure	Uncontrolled Environment General Population	Controlled Environment Occupational
Partial Peak SAR (Partial)	1.60 mW/g	8.00 mW/g
Partial Average SAR (Whole Body)	0.08 mW/g	0.40 mW/g
Partial Peak SAR (Hands/Feet/Ankle/Wrist)	4.00 mW/g	20.00 mW/g

Table .4 RF exposure limits

1.13 Justification for Extended SAR Dipole Calibrations

Usage of SAR dipoles calibrated less than 2 years ago but more than 1 year ago were confirmed in maintaining return loss (< -20 dB, within 20 % of prior calibration) and impedance (within 5 ohm from prior calibration) requirements per extended calibrations in KDB publication 450824:

D2450V2_Body (SN : 734)				
Measurement Date	Return Loss (dB)	$\Delta\%$	Impedance (Ω)	$\Delta\Omega$
2010-05-27	-27.1	-	49.8	-
2011-06-07	-26.2	-3.32	48.3	-3.01

2. Instruments List

Maunfacturer	Device	Type	Serial Number	Due date of Calibration
Stäubli	Robot	RX90BL	F03/5W05A1/A/01	N/A
Schmid& Partner Engineering AG	Dosimetric E-Field Probe	ES3DV3	3068	May 20, 2012
Schmid& Partner Engineering AG	2450 Mhz System Validation Dipole	D2450V2	734	May 27, 2012
Schmid& Partner Engineering AG	Data acquisition Electronics	DAE3	567	January 20, 2013
Schmid& Partner Engineering AG	Software	DASY 4 V4.7	-	N/A
Schmid& Partner Engineering AG	Phantom	SAM Phantom V4.0	TP-1300	N/A
Agilent	Network Analyzer	E5070B	MY42100282	January 03, 2013
Agilent	Dielectric Probe Kit	85070D	2184	N/A
Agilent	Power Meter	E4419B	GB43311125	July 03, 2012
Agilent	Power Sensor	E9300H	MY41495307	September 29, 2012
			MY41495314	September 29, 2012
Agilent	Signal Generator	E4421B	MY43350132	July 05, 2012
Empower RF Systems	Power Amplifier	2001-BBS3Q7ECK	1032 D/C 0336	March 31, 2013
Agilent	Dual Directional Coupler	777D	50128	July 11, 2012
Agilent	Attenuator	8491B	50566	September 29, 2012
R & S	Spectrum Analyzer	FSV30	100768	March 29, 2013
Microlab	LP Filter	LA-30N	N/A	September 29, 2012

3.Summary of Results

3.1 FCC Power Measurement Procedures

Power measurements were performed using a base station simulator under digital average power.

The handset was placed into a simulated call using a base station simulator in shielded chamber. SAR measurements were taken with a fully charged battery. In order to verify that the device was tested and maintained at full power, this was configured with the base station simulator. The SAR measurement Software calculates a reference point at the start and end of the test to check for power drifts. If conducted power deviations of more than 5 % occurred, the tests were repeated.

3.2 WLAN RF Conducted Average Power

802.11b Mode		Rated (Mbps)	Measured Average Power (dB m)
Frequency (MHz)	Channel No.		
2412	1	1	<u>15.82</u>
		2	15.80
		5.5	15.73
		11	15.68
2437	6	1	<u>16.01</u>
		2	15.96
		5.5	15.88
		11	15.73
2462	11	1	<u>16.13</u>
		2	16.07
		5.5	15.96
		11	15.77

802.11g Mode		Rated (Mbps)	Measured Average Power (dB m)
Frequency (MHz)	Channel No.		
2412	1	6	12.97
		9	12.84
		12	12.76
		18	12.67
		24	12.45
		36	12.34
		48	12.12
		54	11.80
2437	6	6	13.17
		9	13.06
		12	12.98
		18	12.73
		24	12.67
		36	12.57
		48	12.38
		54	11.98
2462	11	6	13.35
		9	13.22
		12	13.13
		18	13.01
		24	12.88
		36	12.78
		48	12.67
		54	12.34
802.11n_HT20 Mode		Rated (Mbps)	Measured Average Power (dB m)
Frequency (MHz)	Channel No.		
2412	1	MCS0	11.94
		MCS1	11.56
		MCS2	11.31
		MCS3	11.09
		MCS4	10.72
		MCS5	10.59
		MCS6	10.49
		MCS7	10.11
2437	6	MCS0	12.00
		MCS1	11.73
		MCS2	11.47
		MCS3	11.26
		MCS4	10.98
		MCS5	10.76
		MCS6	10.55
		MCS7	10.34
2462	11	MCS0	12.12
		MCS1	11.98
		MCS2	11.76
		MCS3	11.54
		MCS4	11.38
		MCS5	11.23
		MCS6	11.12
		MCS7	10.89

3.3 SAR Test Configuration

IEEE 802.11 Transmitters

802.11 a/b/g and 4.9 GHz operating modes are tested independently according to the service requirements in each frequency band. 802.11 b/g modes are tested on channel 1, 6, and 11. 802.11a is tested for UNII operations on channels 36 and 48 in the 5.15 ~ 5.25 GHz band, channels 52 and 64 in the 5.25 ~ 5.35 GHz band, channels 104, 116, 124 and 136 in the 5.470 ~ 5.725 GHz band, and channels 149 and 161 in the 5.8 GHz band. When 5.8 GHz §15.247 is also available, channels 149, 157 and 165 should be tested instead of the UNII channels. 802.11g mode was evaluated only if the output power was 0.25 dB higher than the 802.11b mode.

Mode	GHz	Channel	Turbo Channel	"Default Test Channels"			
				§15.247		UNII	
				802.11b	802.11g		
802.11 b/g	2.412	1 [#]		√	▽		
	2.437	6	6	√	▽		
	2.462	11 [#]		√	▽		
802.11a	5.18	36	42 (5.21 GHz)			√	
	5.20	40					*
	5.22	44					*
	5.24	48	50 (5.25 GHz)			√	
	5.26	52	58 (5.29 GHz)			√	
	5.28	56					*
	5.30	60					*
	5.32	64				√	
	5.500	100	Unknown				*
	5.520	104				√	*
	5.540	108					*
	5.560	112					*
	5.580	116				√	*
	5.600	120					*
	5.620	124				√	*
	5.640	128					*
	5.660	132					*
	5.680	136				√	*
	5.700	140				*	
	UNII	5.745	149		√		√
or	5.765	153	152 (5.76 GHz)		*		*
§15.247	5.785	157		√			*
	5.805	161	160 (5.80 GHz)		*	√	*
§15.247	5.825	165		√			

- √ = "default test channels"
- * = possible 802.11 a channels with maximum average output > the "default test channels"
- ▽ = possible 802.11 g channels with maximum average output ¼ dB ≥ the "default test channels"
- # = when output power is reduced for channel 1 and/or 11 to meet restricted band requirements the highest output channels closest to each of these channels should be tested

3.4 Still cameras and video cameras Test position

FCC OET Bulletin 65 supplement C

For purpose of determining test requirements, accessories may be divided into two categories:

Those that do not contain metallic components and those that do. For multiple accessories that do not contain metallic components, the device may be tested only with that accessory which provides the closest spacing to the body.

For multiple accessories that contain metallic components, the device must be tested with each accessory that contains a unique metallic component. If multiple accessories share an identical metallic component, only the accessory that provides the closest spacing to the body must be tested.

If the manufacturer provides none body accessories, a separation distance of 0 cm between the back of the device and the flat phantom is recommended to cover the worst-case usage scenarios. Other separation distances may be used, but they shall not exceed 2.5 cm. In these cases, the device may use body-worn accessories that provide a separation distance greater than that tested for the device provided however that the accessory contains no metallic components.

<The Distance information of Antenna to Edges of EUT>

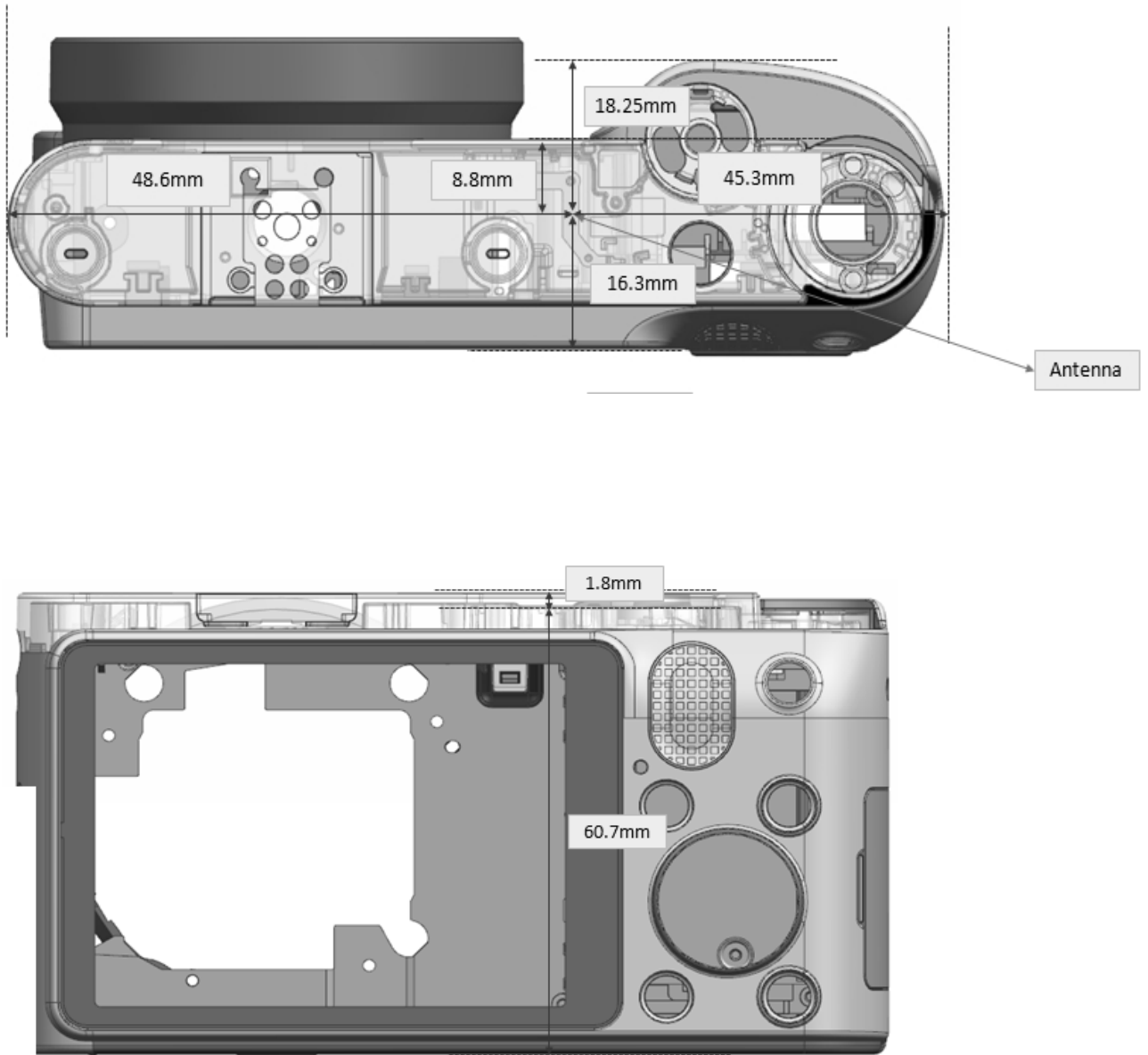

WLAN Body SAR

Ambient Temperature (°C)	22.5
Liquid Temperature (°C)	22.1
Date	2012-04-16

	Test Mode	EUT Position	Distance from Phantom (mm)	Traffic Channel		Power Drift (dB)	1 g SAR (W/kg)	1 g SAR Limits (W/kg)
				Frequency (Mhz)	Channel			
Body	11b	Front	0	2462	11	0.146	0.074	1.6
		Back	0	2462	11	-0.015	0.063	
		Right Edge	0	2462	11	0.057	0.027	
		Left Edge	0	2462	11	-0.07	0.005	
		Bottom	0	2462	11	-0.148	0.023	
		Top	0	2462	11	0.070	0.376	
		Top	0	2412	1	0.118	0.532	
		Top	0	2437	6	0.051	0.447	
		Accessory (Aperture)						
		Front	0	2462	11	-0.018	0.005	

<Note>

- The test data reported are the worst-case SAR value with the position set in a typical configuration.
- All modes of operation were investigated, and worst-case results are reported.
- Battery is fully charged for all readings and the standard batteries are the only options.
- Liquid tissue depth was at least 15 cm.
- Test procedures used were according to FCC OET Bulletin 65 supplement C
- RSS102 < Exemption from Routine Evaluation Limits – SAR Evaluation >
 - above 2.2 GHz and up to 3 GHz inclusively, and with output power (i.e. the higher of the conducted or radiated (e.i.r.p.) source-based, time-averaged output power) that is less than or equal to 20 mW for general public use and 100 mW for controlled use.
- KDB 248227 <SAR Measurement Procedures for 802.11 a/b/g Transmitters>
 - Channel 1, 6 and 11 were tested by the definition of “default test channels”.
 - Highest average RF output power channel for the lowest data rate were selected for SAR evaluation. Other mode were not tested since the average output powers were not greater than 0.25 dB than that of the corresponding channel in the lowest data rate IEEE 802.11b mode.
- WLAN transmission was verified using a spectrum analyzer.

Appendix

List

Appendix A	DASY4 Report (Plots of the SAR Measurements)	- 2450 MHz Validation Test - Body Test
Appendix B	Uncertainty Analysis	
Appendix C	Calibration Certificate	- PROBE - DAE3 - DIPOLE



Report File No. : F690501/RF-SAR001997
Date of Issue : 2012-04-17
Page : 21 / 61

Appendix A

Test Plot - DASY4 Report

2450 MHz Body Validation Test

Date: 2012-04-16

Test Laboratory: SGS Korea (Gunpo Laboratory)
 File Name: [Validation 2450 MHz_Body.da4](#)

Input Power : 100 mW

DUT: Dipole 2450 MHz; Type: D2450V2; Serial: D2450V2 - SN:734
Program Name: Validation 2450 MHz_Body

Communication System: CW; Frequency: 2450 MHz; Duty Cycle: 1:1
 Medium parameters used: $f = 2450$ MHz; $\sigma = 1.98$ mho/m; $\epsilon_r = 51.7$; $\rho = 1000$ kg/m³
 Phantom section: Flat Section

DASY4 Configuration:

- Probe: ES3DV3 - SN3068; ConvF(4.28, 4.28, 4.28); Calibrated: 2011-05-20
- Sensor-Surface: 3mm (Mechanical Surface Detection)
- Electronics: DAE3 Sn567; Calibrated: 2012-01-20
- Phantom: SAM MIC #2000-93 with CRP_Right; Type: SAM MIC #2000-93; Serial: TP-1300
- Measurement SW: DASY4, V4.7 Build 80; Postprocessing SW: SEMCAD, V1.8 Build 186

Validation 2450 MHz_Body/Area Scan (61x61x1): Measurement grid: dx=15mm, dy=15mm
 Maximum value of SAR (interpolated) = 6.99 mW/g

Validation 2450 MHz_Body/Zoom Scan (7x7x7)/Cube 0: Measurement grid: dx=5mm, dy=5mm, dz=5mm
 Reference Value = 61.3 V/m; Power Drift = -0.018 dB
 Peak SAR (extrapolated) = 11.1 W/kg
SAR(1 g) = 5.23 mW/g; SAR(10 g) = 2.38 mW/g
 Maximum value of SAR (measured) = 6.90 mW/g

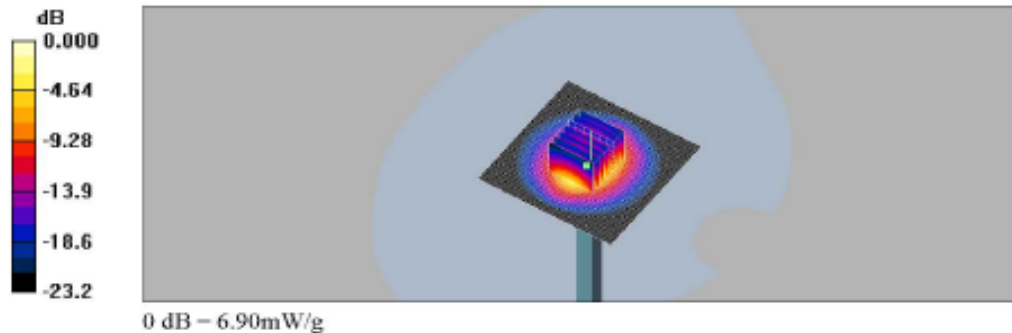

Z Scan

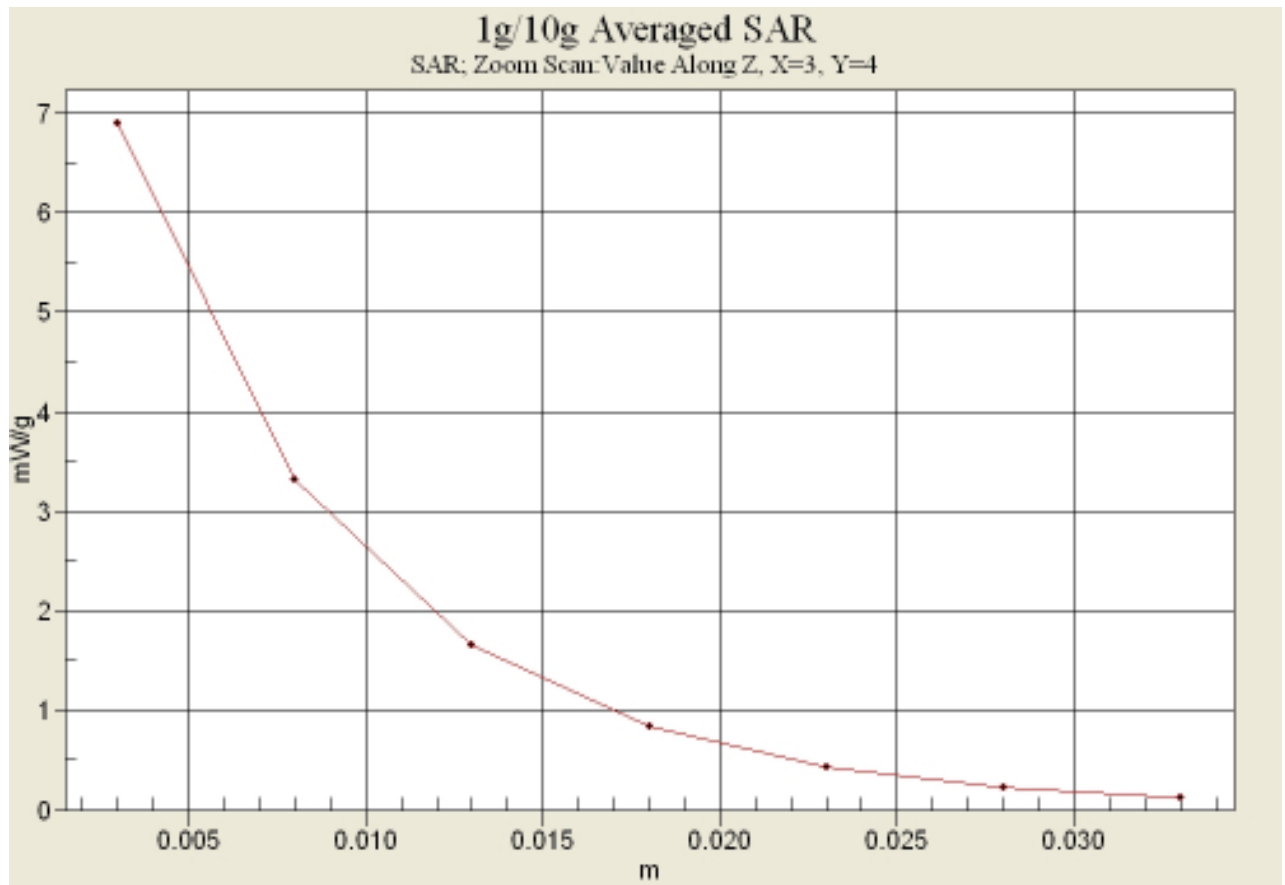

SAR Test Plot

Date: 2012-04-16

Test Laboratory: SGS Korea (Gunpo Laboratory)
 File Name: [Wi-Fi_Front_CH11.da4](#)

DUT: NX1000; Type: Digital Camera; Serial: 0067940
Program Name: WLAN_Body

Communication System: WLAN; Frequency: 2462 MHz; Duty Cycle: 1:1
 Medium parameters used: $f = 2462 \text{ MHz}$; $\sigma = 2 \text{ mho/m}$; $\epsilon_r = 51.6$; $\rho = 1000 \text{ kg/m}^3$
 Phantom section: Flat Section

DASY4 Configuration:

- Probe: ES3DV3 - SN3068; ConvF(4.28, 4.28, 4.28); Calibrated: 2011-05-20
- Sensor-Surface: 4mm (Mechanical Surface Detection)
- Electronics: DAE3 Sn567; Calibrated: 2012-01-20
- Phantom: SAM MIC #2000-93 with CRP_Right; Type: SAM MIC #2000-93; Serial: TP-1300
- Measurement SW: DASY4, V4.7 Build 80; Postprocessing SW: SEMCAD, V1.8 Build 186

WLAN_Front_High gep 0mm/Area Scan (111x111x1): Measurement grid: dx=15mm, dy=15mm
 Maximum value of SAR (interpolated) = 0.082 mW/g

WLAN_Front_High gep 0mm/Zoom Scan (7x7x7)/Cube 0: Measurement grid: dx=5mm, dy=5mm, dz=5mm
 Reference Value = 2.67 V/m; Power Drift = 0.146 dB
 Peak SAR (extrapolated) = 0.146 W/kg
SAR(1 g) = 0.074 mW/g; SAR(10 g) = 0.038 mW/g
 Maximum value of SAR (measured) = 0.082 mW/g

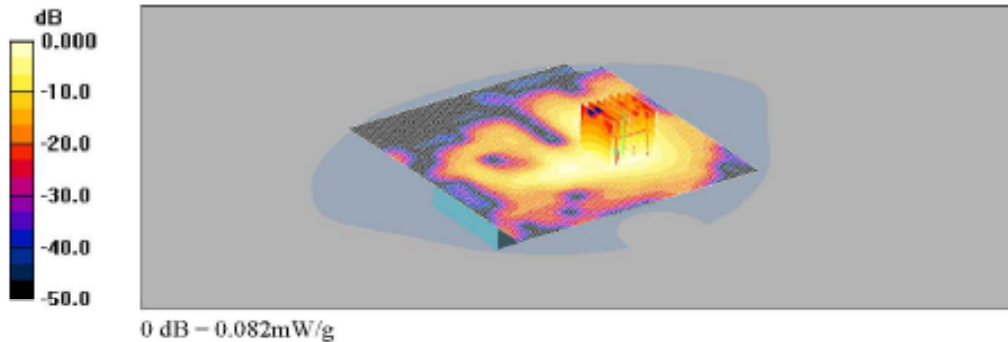

Date: 2012-04-16

Test Laboratory: SGS Korea (Gunpo Laboratory)
 File Name: [Wi-Fi_Back_CH11.da4](#)

DUT: NX1000; Type: Digital Camera; Serial: 0067940
Program Name: WLAN_Body

Communication System: WLAN; Frequency: 2462 MHz; Duty Cycle: 1:1
 Medium parameters used: $f = 2462$ MHz; $\sigma = 2$ mho/m; $\epsilon_r = 51.6$; $\rho = 1000$ kg/m³
 Phantom section: Flat Section

DASY4 Configuration:

- Probe: ES3DV3 - SN3068; ConvF(4.28, 4.28, 4.28); Calibrated: 2011-05-20
- Sensor-Surface: 4mm (Mechanical Surface Detection)
- Electronics: DAE3 Sn567; Calibrated: 2012-01-20
- Phantom: SAM MIC #2000-93 with CRP Right; Type: SAM MIC #2000-93; Serial: TP-1300
- Measurement SW: DASY4, V4.7 Build 80; Postprocessing SW: SEMCAD, V1.8 Build 186

WLAN_Back_High gep 0mm/Area Scan (111x111x1): Measurement grid: dx=15mm, dy=15mm
 Maximum value of SAR (interpolated) = 0.073 mW/g

WLAN_Back_High gep 0mm/Zoom Scan (7x7x7)/Cube 0: Measurement grid: dx=5mm, dy=5mm, dz=5mm
 Reference Value - 1.38 V/m; Power Drift - -0.015 dB
 Peak SAR (extrapolated) = 0.141 W/kg
SAR(1 g) = 0.063 mW/g; SAR(10 g) = 0.031 mW/g
 Maximum value of SAR (measured) - 0.071 mW/g

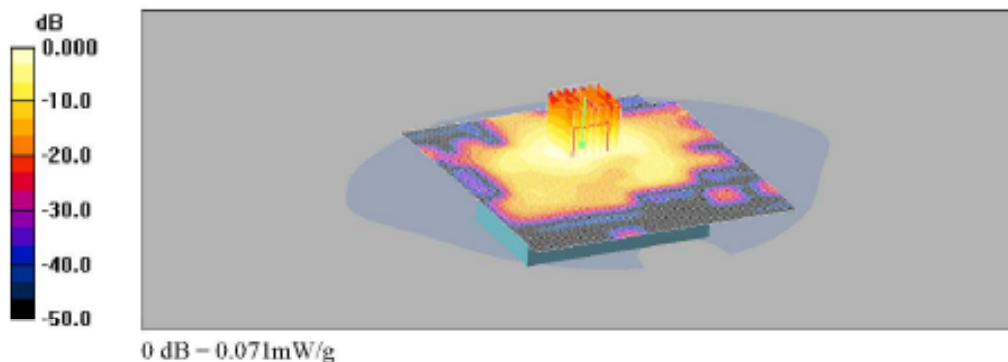

Date: 2012-04-16

Test Laboratory: SGS Korea (Gunpo Laboratory)
 File Name: [Wi-Fi_Right_CH11.da4](#)

DUT: NX1000; Type: Digital Camera; Serial: 0067940
Program Name: WLAN_Body

Communication System: WLAN; Frequency: 2462 MHz; Duty Cycle: 1:1
 Medium parameters used: $f = 2462$ MHz; $\sigma = 2$ mho/m; $\epsilon_r = 51.6$; $\rho = 1000$ kg/m³
 Phantom section: Flat Section

DASY4 Configuration:

- Probe: ES3DV3 - SN3068; ConvF(4.28, 4.28, 4.28); Calibrated: 2011-05-20
- Sensor-Surface: 4mm (Mechanical Surface Detection)
- Electronics: DAE3 Sn567; Calibrated: 2012-01-20
- Phantom: SAM MIC #2000-93 with CRP_Right; Type: SAM MIC #2000-93; Serial: TP-1300
- Measurement SW: DASY4, V4.7 Build 80; Postprocessing SW: SEMCAD, V1.8 Build 186

WLAN_Right_High gep 0mm/Area Scan (81x111x1): Measurement grid: dx=15mm, dy=15mm
 Maximum value of SAR (interpolated) = 0.028 mW/g

WLAN_Right_High gep 0mm/Zoom Scan (7x7x7)/Cube 0: Measurement grid: dx=5mm, dy=5mm, dz=5mm
 Reference Value - 3.25 V/m; Power Drift - 0.057 dB
 Peak SAR (extrapolated) = 0.067 W/kg
SAR(1 g) = 0.027 mW/g; SAR(10 g) = 0.014 mW/g
 Maximum value of SAR (measured) - 0.030 mW/g

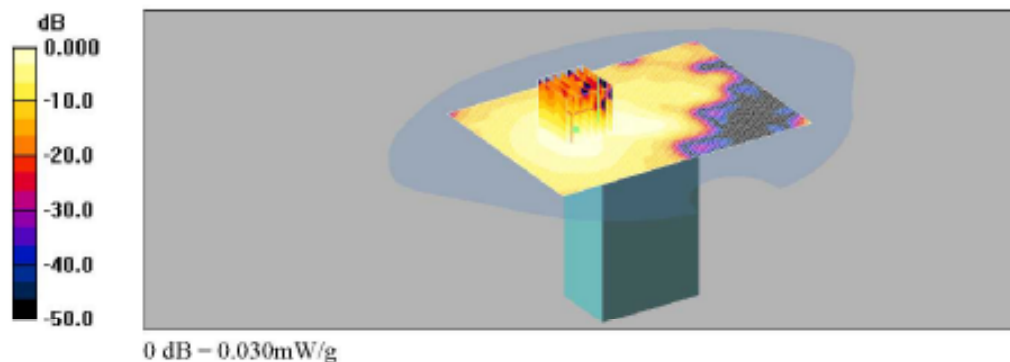

Date: 2012-04-16

Test Laboratory: SGS Korea (Gunpo Laboratory)
 File Name: [Wi-Fi_Left_CH11.da4](#)

DUT: NX1000; Type: Digital Camera; Serial: 0067940
Program Name: WLAN_Body

Communication System: WLAN; Frequency: 2462 MHz; Duty Cycle: 1:1
 Medium parameters used: $f = 2462$ MHz; $\sigma = 2$ mho/m; $v_T = 51.6$; $\rho = 1000$ kg/m³
 Phantom section: Flat Section

DASY4 Configuration:

- Probe: ES3DV3 - SN3068; ConvF(4.28, 4.28, 4.28); Calibrated: 2011-05-20
- Sensor-Surface: 4mm (Mechanical Surface Detection)
- Electronics: DAE3 Sn567; Calibrated: 2012-01-20
- Phantom: SAM MIC #2000-93 with CRP Right; Type: SAM MIC #2000-93; Serial: TP-1300
- Measurement SW: DASY4, V4.7 Build 80; Postprocessing SW: SEMCAD, V1.8 Build 186

WLAN_Left gep 0mm/Area Scan (81x111x1): Measurement grid: dx=15mm, dy=15mm
 Maximum value of SAR (interpolated) = 0.006 mW/g

WLAN_Left gep 0mm/Zoom Scan (7x7x7)/Cube 0: Measurement grid: dx=5mm, dy=5mm, dz=5mm
 Reference Value = 1.03 V/m; Power Drift = -0.070 dB
 Peak SAR (extrapolated) = 0.011 W/kg
SAR(1 g) = 0.00515 mW/g; SAR(10 g) = 0.00238 mW/g
 Maximum value of SAR (measured) = 0.006 mW/g

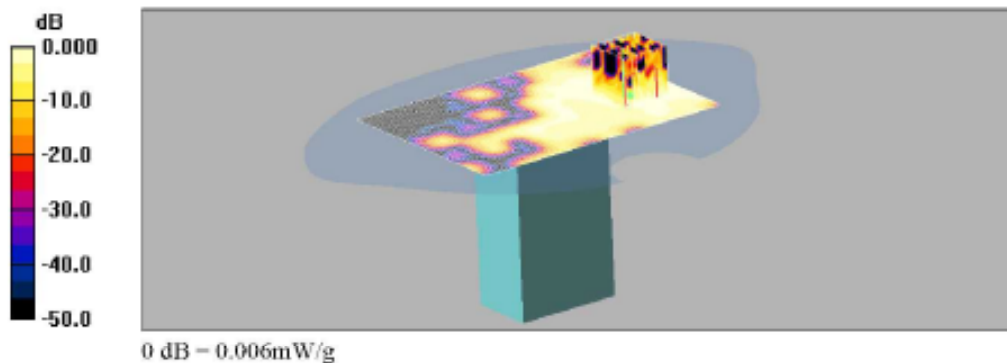

Date: 2012-04-16

Test Laboratory: SGS Korea (Gunpo Laboratory)
 File Name: [Wi-Fi_Bottom_CH11.da4](#)

DUT: NX1000; Type: Digital Camera; Serial: 0067940
Program Name: WLAN_Body

Communication System: WLAN; Frequency: 2462 MHz; Duty Cycle: 1:1
 Medium parameters used: $f = 2462$ MHz; $\sigma = 2$ mho/m; $\epsilon_r = 51.6$; $\rho = 1000$ kg/m³
 Phantom section: Flat Section

DASY4 Configuration:

- Probe: ES3DV3 - SN3068; ConvF(4.28, 4.28, 4.28); Calibrated: 2011-05-20
- Sensor-Surface: 4mm (Mechanical Surface Detection)
- Electronics: DAE3 Sn567; Calibrated: 2012-01-20
- Phantom: SAM MIC #2000-93 with CRP Right; Type: SAM MIC #2000-93; Serial: TP-1300
- Measurement SW: DASY4, V4.7 Build 80; Postprocessing SW: SEMCAD, V1.8 Build 186

WLAN_Bottom_High gep 0mm/Area Scan (81x111x1): Measurement grid: dx=15mm, dy=15mm
 Maximum value of SAR (interpolated) = 0.023 mW/g

WLAN_Bottom_High gep 0mm/Zoom Scan (7x7x7)/Cube 0: Measurement grid: dx=5mm, dy=5mm, dz=5mm
 Reference Value - 1.95 V/m; Power Drift - -0.148 dB
 Peak SAR (extrapolated) = 0.067 W/kg
SAR(1 g) = 0.023 mW/g; SAR(10 g) = 0.010 mW/g
 Maximum value of SAR (measured) - 0.027 mW/g

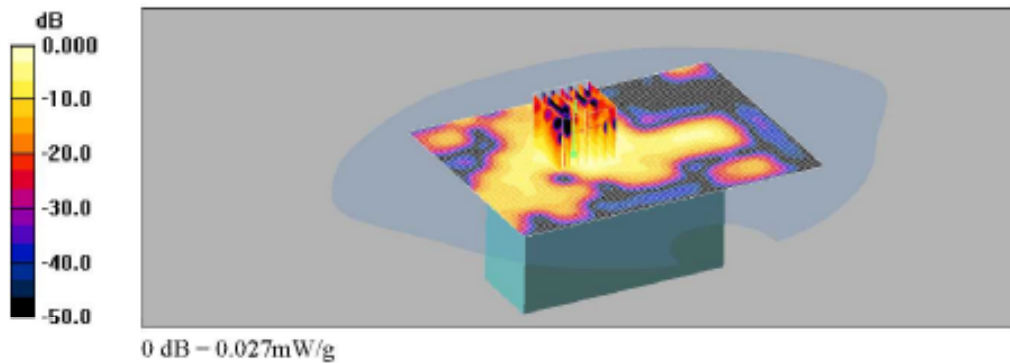

Date: 2012-04-16

Test Laboratory: SGS Korea (Gunpo Laboratory)
 File Name: [Wi-Fi_Top_CH11.da4](#)

DUT: NX1000; Type: Digital Camera; Serial: 0067940
Program Name: WLAN_Body

Communication System: WLAN; Frequency: 2462 MHz; Duty Cycle: 1:1
 Medium parameters used: $f = 2462$ MHz; $\sigma = 2$ mho/m; $\epsilon_r = 51.6$; $\rho = 1000$ kg/m³
 Phantom section: Flat Section

DASY4 Configuration:

- Probe: ES3DV3 - SN3068; ConvF(4.28, 4.28, 4.28); Calibrated: 2011-05-20
- Sensor-Surface: 4mm (Mechanical Surface Detection)
- Electronics: DAE3 Sn567; Calibrated: 2012-01-20
- Phantom: SAM MIC #2000-93 with CRP Right; Type: SAM MIC #2000-93; Serial: TP-1300
- Measurement SW: DASY4, V4.7 Build 80; Postprocessing SW: SEMCAD, V1.8 Build 186

WLAN_Top_High gep 0mm/Area Scan (81x111x1): Measurement grid: dx=15mm, dy=15mm
 Maximum value of SAR (interpolated) = 0.522 mW/g

WLAN_Top_High gep 0mm/Zoom Scan (7x7x7)/Cube 0: Measurement grid: dx=5mm, dy=5mm, dz=5mm
 Reference Value - 9.95 V/m; Power Drift - 0.070 dB
 Peak SAR (extrapolated) = 0.777 W/kg
SAR(1 g) = 0.376 mW/g; SAR(10 g) = 0.182 mW/g
 Maximum value of SAR (measured) - 0.427 mW/g

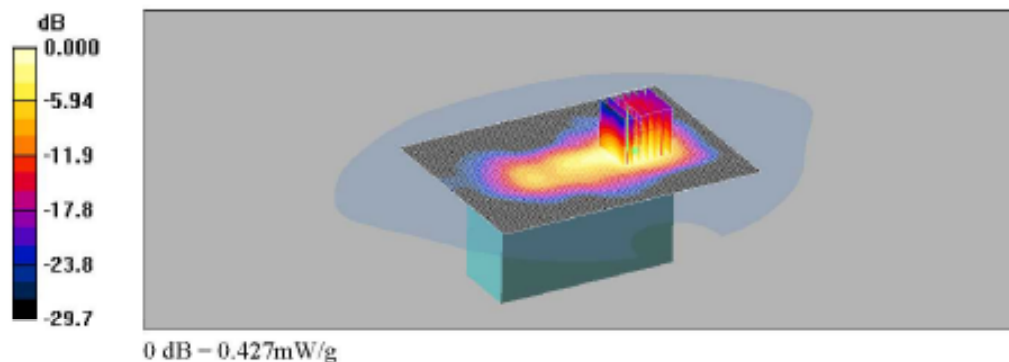

Date: 2012-04-16

Test Laboratory: SGS Korea (Gunpo Laboratory)
 File Name: [Wi-Fi_Top_CH1.da4](#)

DUT: NX1000; Type: Digital Camera; Serial: 0067940
Program Name: WLAN_Body

Communication System: WLAN; Frequency: 2412 MHz; Duty Cycle: 1:1
 Medium parameters used: $f = 2412$ MHz; $\sigma = 1.93$ mho/m; $\epsilon_r = 51.8$; $\rho = 1000$ kg/m³
 Phantom section: Flat Section

DASY4 Configuration:

- Probe: ES3DV3 - SN3068; ConvF(4.28, 4.28, 4.28); Calibrated: 2011-05-20
- Sensor-Surface: 4mm (Mechanical Surface Detection)
- Electronics: DAE3 Sn567; Calibrated: 2012-01-20
- Phantom: SAM MIC #2000-93 with CRP Right; Type: SAM MIC #2000-93; Serial: TP-1300
- Measurement SW: DASY4, V4.7 Build 80; Postprocessing SW: SEMCAD, V1.8 Build 186

WLAN_Top_Low gep 0mm/Area Scan (81x111x1): Measurement grid: dx=15mm, dy=15mm
 Maximum value of SAR (interpolated) = 0.614 mW/g

WLAN_Top_Low gep 0mm/Zoom Scan (7x7x7)/Cube 0: Measurement grid: dx=5mm, dy=5mm, dz=5mm
 Reference Value = 6.54 V/m; Power Drift = 0.118 dB
 Peak SAR (extrapolated) = 1.08 W/kg
SAR(1 g) = 0.532 mW/g; SAR(10 g) = 0.251 mW/g
 Maximum value of SAR (measured) = 0.591 mW/g

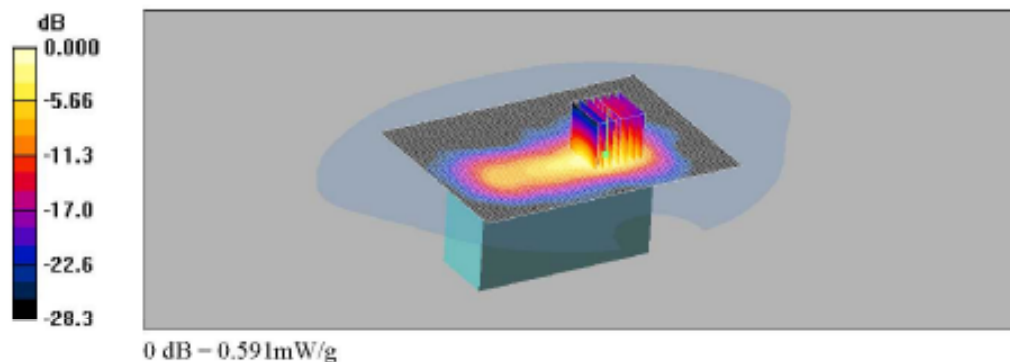

Z-Scan

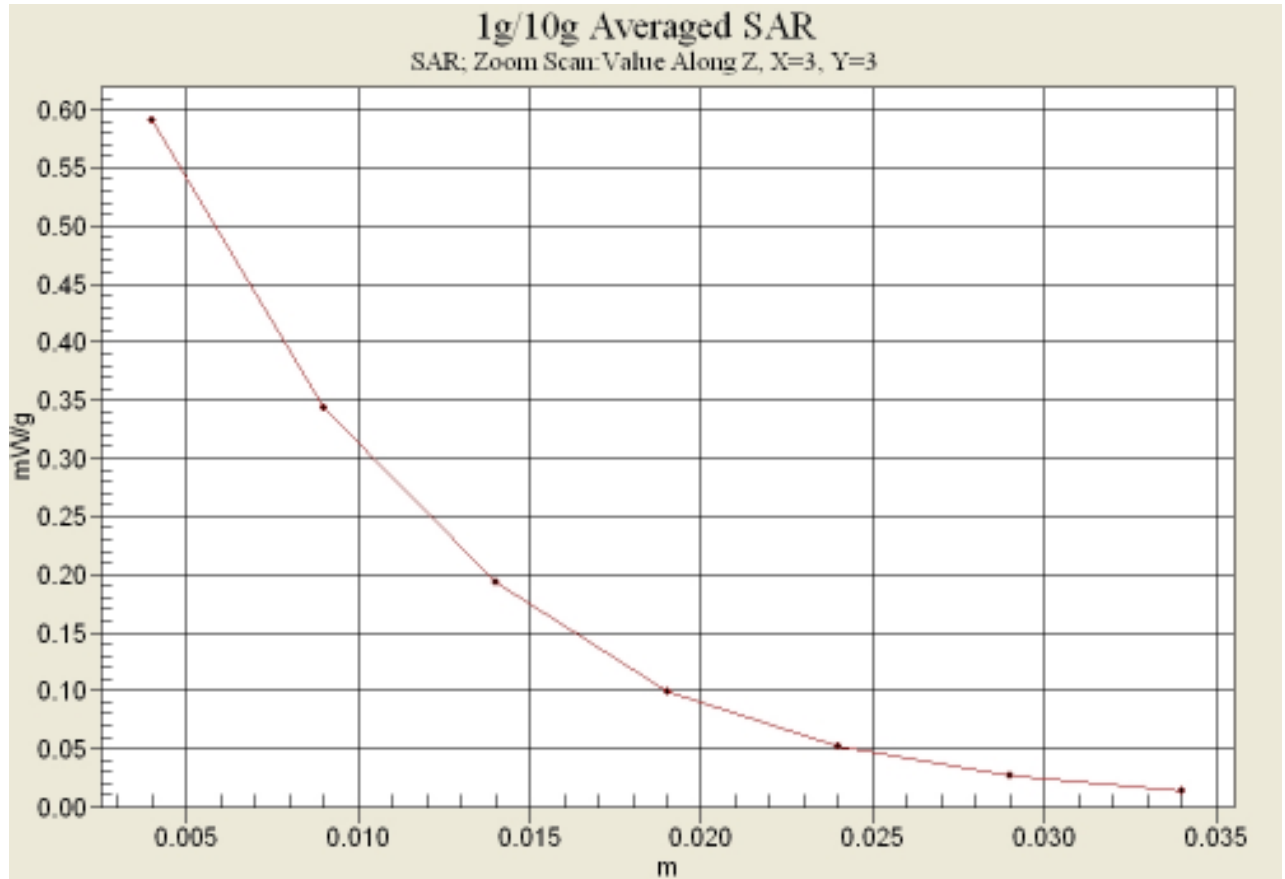

Date: 2012-04-16

Test Laboratory: SGS Korea (Gunpo Laboratory)
 File Name: [Wi-Fi_Top_CH6.da4](#)

DUT: NX1000; Type: Digital Camera; Serial: 0067940
Program Name: WLAN_Body

Communication System: WLAN; Frequency: 2437 MHz; Duty Cycle: 1:1
 Medium parameters used: $f = 2437$ MHz; $\sigma = 1.96$ mho/m; $\epsilon_r = 51.7$; $\rho = 1000$ kg/m³
 Phantom section: Flat Section

DASY4 Configuration:

- Probe: ES3DV3 - SN3068; ConvF(4.28, 4.28, 4.28); Calibrated: 2011-05-20
- Sensor-Surface: 4mm (Mechanical Surface Detection)
- Electronics: DAE3 Sn567; Calibrated: 2012-01-20
- Phantom: SAM MIC #2000-93 with CRP_Right; Type: SAM MIC #2000-93; Serial: TP-1300
- Measurement SW: DASY4, V4.7 Build 80; Postprocessing SW: SEMCAD, V1.8 Build 186

WLAN_Top_Mid gep 0mm/Area Scan (81x111x1): Measurement grid: dx=15mm, dy=15mm
 Maximum value of SAR (interpolated) = 0.533 mW/g

WLAN_Top_Mid gep 0mm/Zoom Scan (7x7x7)/Cube 0: Measurement grid: dx=5mm, dy=5mm, dz=5mm
 Reference Value = 7.54 V/m; Power Drift = 0.051 dB
 Peak SAR (extrapolated) = 0.928 W/kg
SAR(1 g) = 0.447 mW/g; SAR(10 g) = 0.212 mW/g
 Maximum value of SAR (measured) = 0.511 mW/g

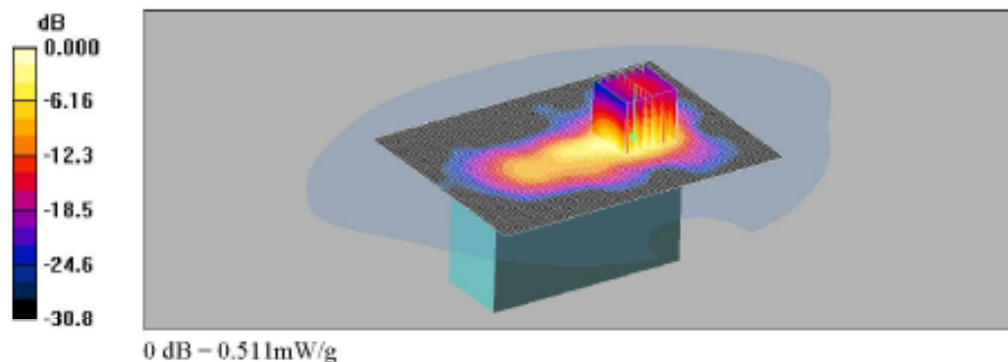

Date: 2012-04-16

Test Laboratory: SGS Korea (Gunpo Laboratory)
 File Name: [Wi-Fi_Front_CH11.da4](#)

DUT: NX1000; Type: Digital Camera; Serial: 0067940
Program Name: WLAN_Body

Communication System: WLAN; Frequency: 2462 MHz; Duty Cycle: 1:1
 Medium parameters used: $f = 2462$ MHz; $\sigma = 2$ mho/m; $\epsilon_r = 51.6$; $\rho = 1000$ kg/m³
 Phantom section: Flat Section

DASY4 Configuration:

- Probe: ES3DV3 - SN3068; ConvF(4.28, 4.28, 4.28); Calibrated: 2011-05-20
- Sensor-Surface: 4mm (Mechanical Surface Detection)
- Electronics: DAE3 Sn567; Calibrated: 2012-01-20
- Phantom: SAM MIC #2000-93 with CRP_Right; Type: SAM MIC #2000-93; Serial: TP-1300
- Measurement SW: DASY4, V4.7 Build 80; Postprocessing SW: SEMCAD, V1.8 Build 186

WLAN_Front_High_Accessory_gep 0mm/Area Scan (111x111x1): Measurement grid:
 dx=15mm, dy=15mm
 Maximum value of SAR (interpolated) = 0.007 mW/g

WLAN_Front_High_Accessory_gep 0mm/Zoom Scan (7x7x7)/Cube 0: Measurement
 grid: dx=5mm, dy=5mm, dz=5mm
 Reference Value = 1.21 V/m; Power Drift = -0.018 dB
 Peak SAR (extrapolated) = 0.018 W/kg
SAR(1 g) = 0.00491 mW/g; SAR(10 g) = 0.00203 mW/g
 Maximum value of SAR (measured) = 0.006 mW/g

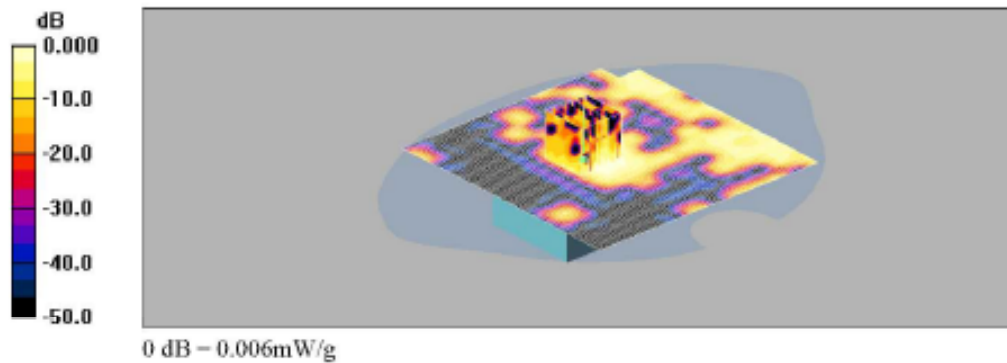

Appendix B

Uncertainty Analysis

a	b	c	d	e = f(d,k)	g	i = cxg/e	k
Uncertainty Component	Section in P1528	Tol (%)	Prob . Dist.	Div.	Ci (1g)	1g ui (%)	Vi (Veff)
Probe calibration	E.2.1	6.3	N	1	1	6.30	∞
Axial isotropy	E.2.2	0.5	R	1.73	0.71	0.20	∞
hemispherical isotropy	E.2.2	2.6	R	1.73	0.71	1.06	∞
Boundary effect	E.2.3	0.8	R	1.73	1	0.46	∞
Linearity	E.2.4	0.6	R	1.73	1	0.35	∞
System detection limit	E.2.5	0.25	R	1.73	1	0.14	∞
Readout electronics	E.2.6	0.3	N	1	1	0.30	∞
Response time	E.2.7	0	R	1.73	1	0.00	∞
Integration time	E.2.8	2.6	R	1.73	1	1.50	∞
RF ambient Condition –Noise	E.6.1	3	R	1.73	1	1.73	∞
RF ambient Condition – reflections	E.6.1	3	R	1.73	1	1.73	∞
Probe positioning– mechanical tolerance	E.6.2	1.5	R	1.73	1	0.87	∞
Probe positioning– with respect to phantom	E.6.3	2.9	R	1.73	1	1.67	∞
Max. SAR evaluation	E.5.2	1	R	1.73	1	0.58	∞
Test sample positioning	E.4.2	2.3	N	1	1	2.30	9
Device holder uncertainty	E.4.1	3.6	N	1	1	3.60	∞
Output power variation–SAR drift measurement	6.62	5	R	1.73	1	2.89	∞
Phantom uncertainty (shape and thickness tolerances)	E.3.1	4	R	1.73	1	2.31	∞
Liquid conductivity – deviation from target values	E.3.2	5	R	1.73	0.64	1.85	∞
Liquid conductivity – measurement uncertainty	E.3.2	1.2	N	1	0.64	0.77	5
Liquid permittivity – deviation from target values	E.3.3	5	R	1.73	0.6	1.73	∞
Liquid permittivity – measurement uncertainty	E.3.3	1.1	N	1	0.6	0.66	5
Combined standard uncertainty				RSS		9.63	2754
Expanded uncertainty (95% CONFIDENCE INTERVAL)				K=2		19.27	

Appendix C

Calibration Certificate

- PROBE

- DAE3

- 2450 MHz Dipole



Report File No. : F690501/RF-SAR001997
Date of Issue : 2012-04-17
Page : 36 / 61

- PROBE Calibration Certificate

**Calibration Laboratory of
 Schmid & Partner
 Engineering AG**
 Zeughausstrasse 43, 8004 Zurich, Switzerland



S Schweizerischer Kalibrierdienst
S Service suisse d'étalonnage
S Servizio svizzero di taratura
S Swiss Calibration Service

Accredited by the Swiss Accreditation Service (SAS)
 The Swiss Accreditation Service is one of the signatories to the EA
 Multilateral Agreement for the recognition of calibration certificates

Accreditation No.: **SCS 108**

Client **Nemko (Dymstec)**

Certificate No: **ES3-3068_May11**

CALIBRATION CERTIFICATE

Object **ES3DV3 - SN:3068**

Calibration procedure(s) **QA CAL-01.v7, QA CAL-23.v4, QA CAL-25.v3
 Calibration procedure for dosimetric E-field probes**



Calibration date: **May 20, 2011**

This calibration certificate documents the traceability to national standards, which realize the physical units of measurements (SI).
 The measurements and the uncertainties with confidence probability are given on the following pages and are part of the certificate.

All calibrations have been conducted in the closed laboratory facility: environment temperature (22 ± 3)°C and humidity < 70%.

Calibration Equipment used (M&TE critical for calibration)

Primary Standards	ID	Cal Date (Certificate No.)	Scheduled Calibration
Power meter E4419B	GB41293874	31-Mar-11 (No. 217-01372)	Apr-12
Power sensor E4412A	MY41498087	31-Mar-11 (No. 217-01372)	Apr-12
Reference 3 dB Attenuator	SN: S5054 (3c)	29-Mar-11 (No. 217-01369)	Apr-12
Reference 20 dB Attenuator	SN: S5086 (20b)	29-Mar-11 (No. 217-01367)	Apr-12
Reference 30 dB Attenuator	SN: S5129 (30b)	29-Mar-11 (No. 217-01370)	Apr-12
Reference Probe ES3DV2	SN: 3013	29-Dec-10 (No. ES3-3013_Dec10)	Dec-11
DAE4	SN: 654	3-May-11 (No. DAE4-654_May11)	May-12
Secondary Standards	ID	Check Date (in house)	Scheduled Check
RF generator HP 8648C	US3642U01700	4-Aug-99 (in house check Oct-09)	In house check: Oct-11
Network Analyzer HP 8753E	US37390585	18-Oct-01 (in house check Oct-10)	In house check: Oct-11

	Name	Function	Signature
Calibrated by:	Jeton Kasrali	Laboratory Technician	
Approved by:	Katja Pokovic	Technical Manager	

Issued: May 23, 2011

This calibration certificate shall not be reproduced except in full without written approval of the laboratory.

Calibration Laboratory of
Schmid & Partner
Engineering AG
 Zeughausstrasse 43, 8004 Zurich, Switzerland



S Schweizerischer Kalibrierdienst
C Service suisse d'étalonnage
S Servizio svizzero di taratura
S Swiss Calibration Service

Accredited by the Swiss Accreditation Service (SAS)

Accreditation No.: **SCS 108**

The Swiss Accreditation Service is one of the signatories to the EA
 Multilateral Agreement for the recognition of calibration certificates

Glossary:

TSL	tissue simulating liquid
NORM _{x,y,z}	sensitivity in free space
ConvF	sensitivity in TSL / NORM _{x,y,z}
DCP	diode compression point
CF	crest factor (1/duty_cycle) of the RF signal
A, B, C	modulation dependent linearization parameters
Polarization ϕ	ϕ rotation around probe axis
Polarization ϑ	ϑ rotation around an axis that is in the plane normal to probe axis (at measurement center), i.e., $\vartheta = 0$ is normal to probe axis

Calibration is Performed According to the Following Standards:

- IEEE Std 1528-2003, "IEEE Recommended Practice for Determining the Peak Spatial-Averaged Specific Absorption Rate (SAR) in the Human Head from Wireless Communications Devices: Measurement Techniques", December 2003
- IEC 62209-1, "Procedure to measure the Specific Absorption Rate (SAR) for hand-held devices used in close proximity to the ear (frequency range of 300 MHz to 3 GHz)", February 2005

Methods Applied and Interpretation of Parameters:

- NORM_{x,y,z}**: Assessed for E-field polarization $\vartheta = 0$ ($f \leq 900$ MHz in TEM-cell; $f > 1800$ MHz: R22 waveguide). NORM_{x,y,z} are only intermediate values, i.e., the uncertainties of NORM_{x,y,z} does not affect the E²-field uncertainty inside TSL (see below ConvF).
- NORM(f)_{x,y,z}** = NORM_{x,y,z} * frequency_response (see Frequency Response Chart). This linearization is implemented in DASY4 software versions later than 4.2. The uncertainty of the frequency response is included in the stated uncertainty of ConvF.
- DCPx,y,z**: DCP are numerical linearization parameters assessed based on the data of power sweep with CW signal (no uncertainty required). DCP does not depend on frequency nor media.
- PAR**: PAR is the Peak to Average Ratio that is not calibrated but determined based on the signal characteristics
- A_{x,y,z}; B_{x,y,z}; C_{x,y,z}** are numerical linearization parameters in dB assessed based on the data of power sweep for specific modulation signal. The parameters do not depend on frequency nor media.
- VR**: VR is the validity range of the calibration related to the average diode voltage or DAE voltage in mV.
- ConvF and Boundary Effect Parameters**: Assessed in flat phantom using E-field (or Temperature Transfer Standard for $f \leq 800$ MHz) and inside waveguide using analytical field distributions based on power measurements for $f > 800$ MHz. The same setups are used for assessment of the parameters applied for boundary compensation (alpha, depth) of which typical uncertainty values are given. These parameters are used in DASY4 software to improve probe accuracy close to the boundary. The sensitivity in TSL corresponds to NORM_{x,y,z} * ConvF whereby the uncertainty corresponds to that given for ConvF. A frequency dependent ConvF is used in DASY version 4.4 and higher which allows extending the validity from ± 50 MHz to ± 100 MHz.
- Spherical Isotropy (3D deviation from isotropy)**: in a field of low gradients realized using a flat phantom exposed by a patch antenna.
- Sensor Offset**: The sensor offset corresponds to the offset of virtual measurement center from the probe tip (on probe axis). No tolerance required.

ES3DV3 – SN:3068

May 20, 2011

Probe ES3DV3

SN:3068

Manufactured: December 14, 2004
Calibrated: May 20, 2011

Calibrated for DASY/EASY Systems
(Note: non-compatible with DASY2 system!)

ES3DV3- SN:3068

May 20, 2011

DASY/EASY - Parameters of Probe: ES3DV3 - SN:3068

Basic Calibration Parameters

	Sensor X	Sensor Y	Sensor Z	Unc (k=2)
Norm ($\mu\text{V}/(\text{V/m})^2$) ^A	1.31	1.30	1.08	$\pm 10.1\%$
DCP (mV) ^B	102.0	99.0	101.8	

Modulation Calibration Parameters

UID	Communication System Name	PAR		A dB	B dB	C dB	VR mV	Unc ^E (k=2)
10000	CW	0.00	X	0.00	0.00	1.00	111.6	$\pm 2.7\%$
			Y	0.00	0.00	1.00	117.5	
			Z	0.00	0.00	1.00	102.0	

The reported uncertainty of measurement is stated as the standard uncertainty of measurement multiplied by the coverage factor k=2, which for a normal distribution corresponds to a coverage probability of approximately 95%.

^A The uncertainties of NormX, Y, Z do not affect the E²-field uncertainty inside TSL (see Pages 5 and 6).

^B Numerical linearization parameter: uncertainty not required.

^E Uncertainty is determined using the max. deviation from linear response applying rectangular distribution and is expressed for the square of the field value.

ES3DV3- SN:3068

May 20, 2011

DASY/EASY - Parameters of Probe: ES3DV3 - SN:3068

Calibration Parameter Determined in Head Tissue Simulating Media

f (MHz) ^C	Relative Permittivity ^F	Conductivity (S/m) ^F	ConvF X	ConvF Y	ConvF Z	Alpha	Depth (mm)	Unct. (k=2)
835	41.5	0.90	6.06	6.06	6.06	1.00	1.00	± 12.0 %
1900	40.0	1.40	5.01	5.01	5.01	1.00	1.06	± 12.0 %
2450	39.2	1.80	4.40	4.40	4.40	0.85	1.16	± 12.0 %

^C Frequency validity of ± 100 MHz only applies for DASY v4.4 and higher (see Page 2), else it is restricted to ± 50 MHz. The uncertainty is the RSS of the ConvF uncertainty at calibration frequency and the uncertainty for the indicated frequency band.

^F At frequencies below 3 GHz, the validity of tissue parameters (ϵ and σ) can be relaxed to ± 10% if liquid compensation formula is applied to measured SAR values. At frequencies above 3 GHz, the validity of tissue parameters (ϵ and σ) is restricted to ± 5%. The uncertainty is the RSS of the ConvF uncertainty for indicated target tissue parameters.

ES3DV3- SN:3068

May 20, 2011

DASY/EASY - Parameters of Probe: ES3DV3- SN:3068

Calibration Parameter Determined in Body Tissue Simulating Media

f (MHz) ^c	Relative Permittivity ^e	Conductivity (S/m) ^e	ConvF X	ConvF Y	ConvF Z	Alpha	Depth (mm)	Unct. (k=2)
835	55.2	0.97	6.02	6.02	6.02	1.00	1.00	± 12.0 %
1900	53.3	1.52	4.78	4.78	4.78	0.78	1.37	± 12.0 %
2450	52.7	1.95	4.28	4.28	4.28	0.85	1.17	± 12.0 %
2600	52.5	2.16	4.11	4.11	4.11	0.85	1.20	± 12.0 %

^c Frequency validity of ± 100 MHz only applies for DASY v4.4 and higher (see Page 2), else it is restricted to ± 50 MHz. The uncertainty is the RSS of the ConvF^e uncertainty at calibration frequency and the uncertainty for the indicated frequency band.

^e At frequencies below 3 GHz, the validity of tissue parameters (ϵ and σ) can be relaxed to ± 10% if liquid compensation formula is applied to measured SAR values. At frequencies above 3 GHz, the validity of tissue parameters (ϵ and σ) is restricted to ± 5%. The uncertainty is the RSS of the ConvF^e uncertainty for indicated target tissue parameters.

ES3DV3- SN:3088

May 20, 2011

Frequency Response of E-Field (TEM-Cell:ifi110 EXX, Waveguide: R22)

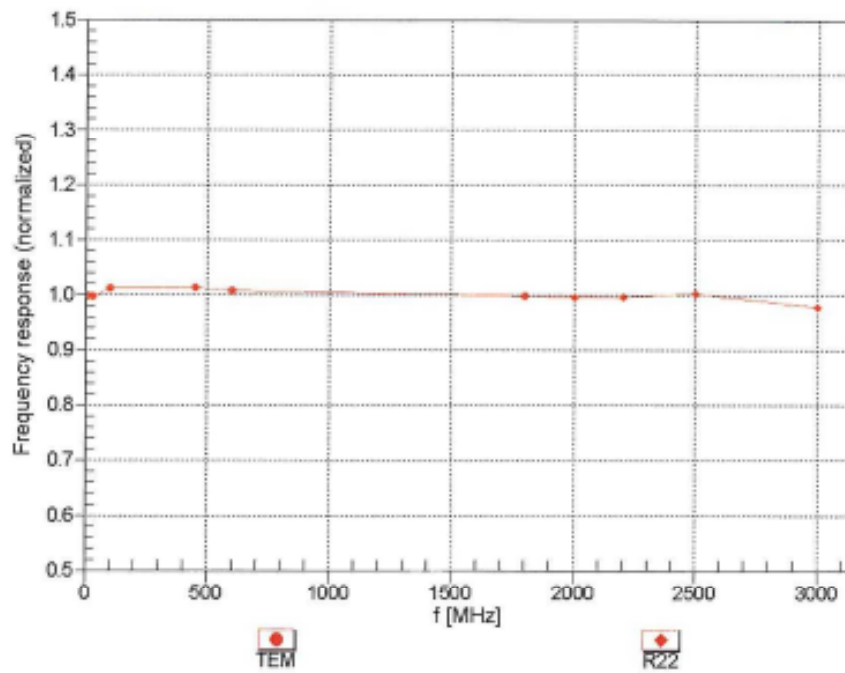

Uncertainty of Frequency Response of E-field: $\pm 6.3\%$ (k=2)

ES3DV3- SN:3068

May 20, 2011

Receiving Pattern (ϕ), $\theta = 0^\circ$

f=600 MHz,TEM

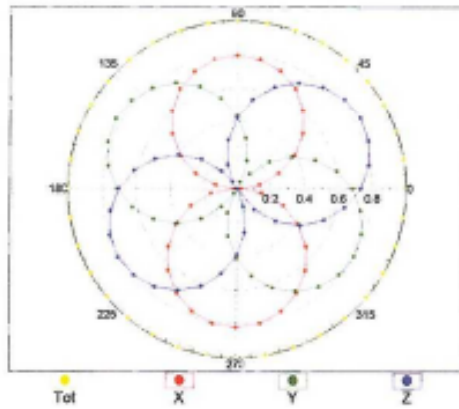

f=1800 MHz,R22

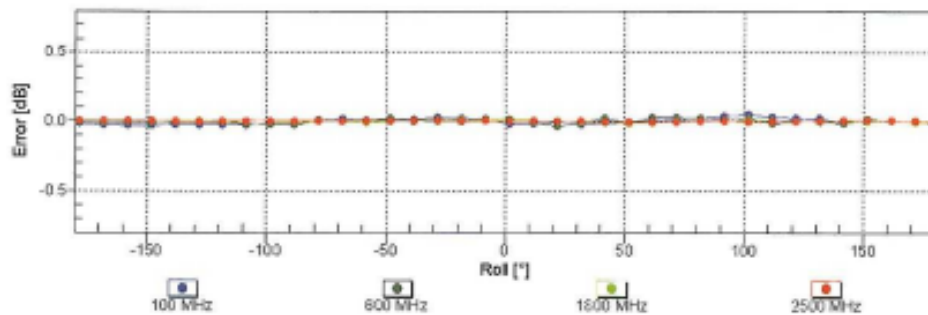
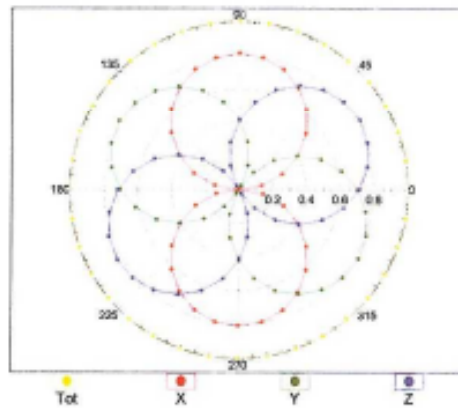

Uncertainty of Axial Isotropy Assessment: $\pm 0.5\%$ (k=2)

ES3DV3- SN:3068

May 20, 2011

Dynamic Range f(SAR_{head}) (TEM cell , f = 900 MHz)

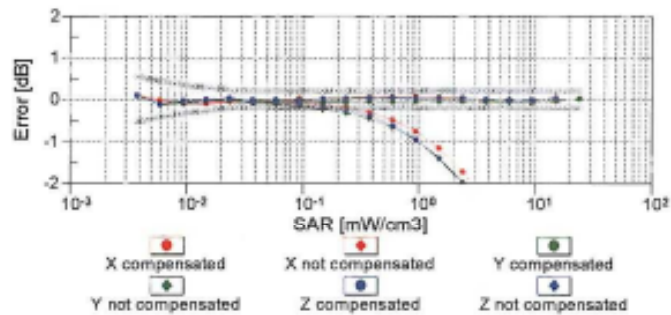
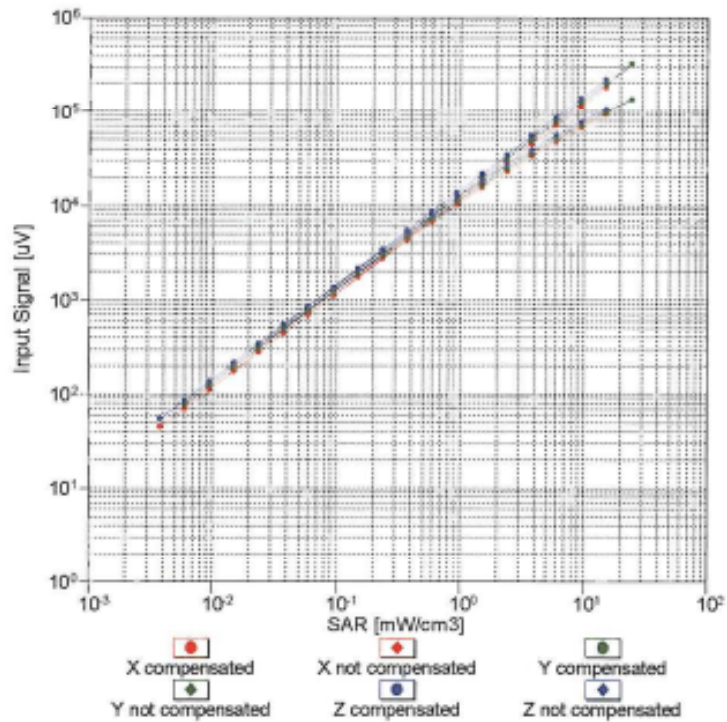

Uncertainty of Linearity Assessment: $\pm 0.6\%$ (k=2)

ES3DV3- SN:3068

May 20, 2011

Conversion Factor Assessment

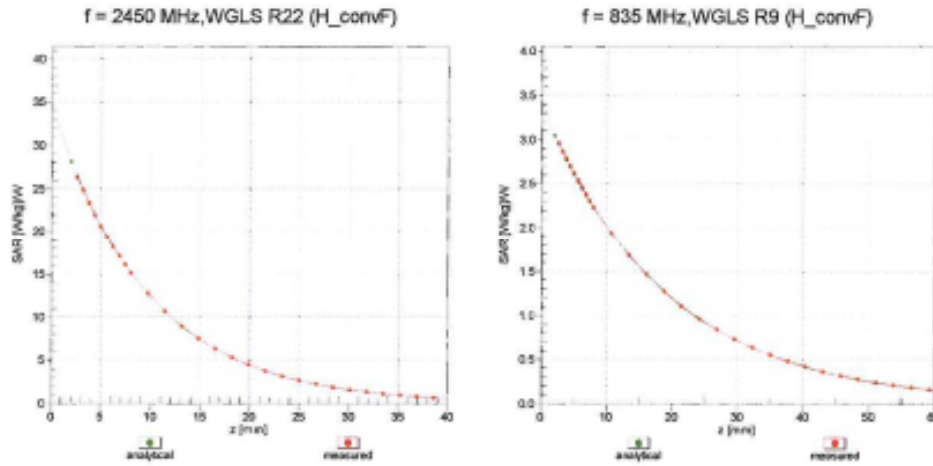

Deviation from Isotropy in Liquid Error (ϕ , θ), f = 900 MHz

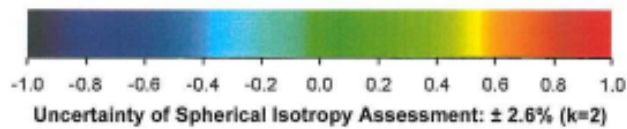
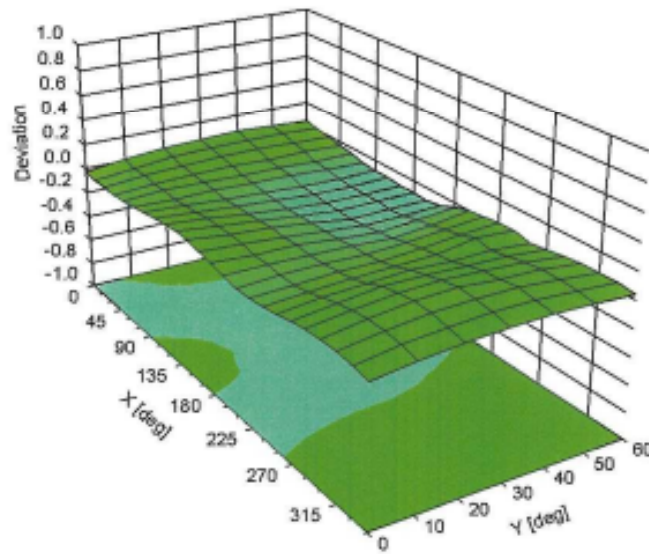

ES3DV3- SN:3068

May 20, 2011

DASY/EASY - Parameters of Probe: ES3DV3 - SN:3068

Other Probe Parameters

Sensor Arrangement	Triangular
Connector Angle (°)	Not applicable
Mechanical Surface Detection Mode	enabled
Optical Surface Detection Mode	disabled
Probe Overall Length	337 mm
Probe Body Diameter	10 mm
Tip Length	10 mm
Tip Diameter	4 mm
Probe Tip to Sensor X Calibration Point	2 mm
Probe Tip to Sensor Y Calibration Point	2 mm
Probe Tip to Sensor Z Calibration Point	2 mm
Recommended Measurement Distance from Surface	3 mm

Annex B.2 DAE Calibration certification

**Calibration Laboratory of
 Schmid & Partner
 Engineering AG**
 Zeughausstrasse 43, 8004 Zurich, Switzerland



S Schweizerischer Kalibrierdienst
C Service suisse d'étalonnage
S Servizio svizzero di taratura
S Swiss Calibration Service

Accredited by the Swiss Accreditation Service (SAS)
 The Swiss Accreditation Service is one of the signatories to the EA
 Multilateral Agreement for the recognition of calibration certificates

Accreditation No.: **SCS 108**

Client **SGS (Dymstec)**

Certificate No: **DAE3-567_Jan12**

CALIBRATION CERTIFICATE

Object **DAE3 - SD 000 D03 AA - SN: 567**

Calibration procedure(s) **QA CAL-06.v24
 Calibration procedure for the data acquisition electronics (DAE)**

Calibration date: **January 20, 2012**

This calibration certificate documents the traceability to national standards, which realize the physical units of measurements (SI).
 The measurements and the uncertainties with confidence probability are given on the following pages and are part of the certificate.

All calibrations have been conducted in the closed laboratory facility: environment temperature (22 ± 3)°C and humidity < 70%.

Calibration Equipment used (M&TE critical for calibration)

Primary Standards	ID #	Cal Date (Certificate No.)	Scheduled Calibration
Keithley Multimeter Type 2001	SN: 0810278	28-Sep-11 (No:11450)	Sep-12
Secondary Standards	ID #	Check Date (in house)	Scheduled Check
Calibrator Box V2.1	SE UWS 063 AA 1001	05-Jan-12 (in house check)	In house check: Jan-13

Calibrated by: **Name** Dominique Steffen **Function** Technician **Signature** 

Approved by: **Name** Fin Bomholt **Function** R&D Director **Signature** 

Issued: January 20, 2012

This calibration certificate shall not be reproduced except in full without written approval of the laboratory.

**Calibration Laboratory of
 Schmid & Partner
 Engineering AG**
 Zeughausstrasse 43, 8004 Zurich, Switzerland



S Schweizerischer Kalibrierdienst
C Service suisse d'étalonnage
S Servizio svizzero di taratura
S Swiss Calibration Service

Accredited by the Swiss Accreditation Service (SAS)
 The Swiss Accreditation Service is one of the signatories to the EA
 Multilateral Agreement for the recognition of calibration certificates

Accreditation No.: **SCS 108**

Glossary

DAE data acquisition electronics
Connector angle information used in DASY system to align probe sensor X to the robot coordinate system.

Methods Applied and Interpretation of Parameters

- *DC Voltage Measurement:* Calibration Factor assessed for use in DASY system by comparison with a calibrated instrument traceable to national standards. The figure given corresponds to the full scale range of the voltmeter in the respective range.
- *Connector angle:* The angle of the connector is assessed measuring the angle mechanically by a tool inserted. Uncertainty is not required.
- The following parameters as documented in the Appendix contain technical information as a result from the performance test and require no uncertainty.
 - *DC Voltage Measurement Linearity:* Verification of the Linearity at +10% and -10% of the nominal calibration voltage. Influence of offset voltage is included in this measurement.
 - *Common mode sensitivity:* Influence of a positive or negative common mode voltage on the differential measurement.
 - *Channel separation:* Influence of a voltage on the neighbor channels not subject to an input voltage.
 - *AD Converter Values with inputs shorted:* Values on the internal AD converter corresponding to zero input voltage
 - *Input Offset Measurement:* Output voltage and statistical results over a large number of zero voltage measurements.
 - *Input Offset Current:* Typical value for information; Maximum channel input offset current, not considering the input resistance.
 - *Input resistance:* Typical value for information: DAE input resistance at the connector, during internal auto-zeroing and during measurement.
 - *Low Battery Alarm Voltage:* Typical value for information. Below this voltage, a battery alarm signal is generated.
 - *Power consumption:* Typical value for information. Supply currents in various operating modes.

DC Voltage Measurement

A/D - Converter Resolution nominal

High Range: 1LSB = 6.1µV , full range = -100...+300 mV

Low Range: 1LSB = 61nV , full range = -1.....+3mV

DASY measurement parameters: Auto Zero Time: 3 sec; Measuring time: 3 sec

Calibration Factors	X	Y	Z
High Range	404.763 ± 0.1% (k=2)	404.411 ± 0.1% (k=2)	404.499 ± 0.1% (k=2)
Low Range	3.95035 ± 0.7% (k=2)	3.97119 ± 0.7% (k=2)	3.95014 ± 0.7% (k=2)

Connector Angle

Connector Angle to be used in DASY system	7.5 ° ± 1 °
---	-------------

Appendix

1. DC Voltage Linearity

High Range	Reading (μV)	Difference (μV)	Error (%)
Channel X + Input	199998.82	3.53	0.00
Channel X + Input	20005.03	4.17	0.02
Channel X - Input	-19996.67	3.44	-0.02
Channel Y + Input	199997.37	2.30	0.00
Channel Y + Input	19999.48	-1.11	-0.01
Channel Y - Input	-19998.88	1.52	-0.01
Channel Z + Input	199994.27	-0.68	-0.00
Channel Z + Input	20001.19	0.52	0.00
Channel Z - Input	-19995.78	4.48	-0.02

Low Range	Reading (μV)	Difference (μV)	Error (%)
Channel X + Input	1999.73	-1.35	-0.07
Channel X + Input	200.29	-1.35	-0.67
Channel X - Input	-197.22	0.97	-0.49
Channel Y + Input	1999.97	-1.02	-0.05
Channel Y + Input	200.82	-0.73	-0.36
Channel Y - Input	-198.58	-0.24	0.12
Channel Z + Input	2000.13	-0.92	-0.05
Channel Z + Input	200.68	-0.79	-0.39
Channel Z - Input	-199.26	-0.95	0.48

2. Common mode sensitivity

DASY measurement parameters: Auto Zero Time: 3 sec; Measuring time: 3 sec

	Common mode Input Voltage (mV)	High Range Average Reading (μV)	Low Range Average Reading (μV)
Channel X	200	6.01	1.84
	-200	-13.55	-1.50
Channel Y	200	-1.13	-2.69
	-200	1.36	1.24
Channel Z	200	4.36	4.11
	-200	-5.92	-6.33

3. Channel separation

DASY measurement parameters: Auto Zero Time: 3 sec; Measuring time: 3 sec

	Input Voltage (mV)	Channel X (μV)	Channel Y (μV)	Channel Z (μV)
Channel X	200	-	-2.44	-2.08
Channel Y	200	7.42	-	-1.51
Channel Z	200	5.84	8.06	-

4. AD-Converter Values with inputs shorted

DASY measurement parameters: Auto Zero Time: 3 sec; Measuring time: 3 sec

	High Range (LSB)	Low Range (LSB)
Channel X	16326	15742
Channel Y	16161	15582
Channel Z	15953	16228

5. Input Offset Measurement

DASY measurement parameters: Auto Zero Time: 3 sec; Measuring time: 3 sec

Input 10M Ω

	Average (μ V)	min. Offset (μ V)	max. Offset (μ V)	Std. Deviation (μ V)
Channel X	0.24	-1.71	1.46	0.53
Channel Y	-0.13	-2.46	1.09	0.49
Channel Z	-0.85	-2.00	0.31	0.42

6. Input Offset Current

Nominal input circuitry offset current on all channels: <25fA

7. Input Resistance (Typical values for information)

	Zeroing (kOhm)	Measuring (MOhm)
Channel X	200	200
Channel Y	200	200
Channel Z	200	200

8. Low Battery Alarm Voltage (Typical values for information)

Typical values	Alarm Level (VDC)
Supply (+ Vcc)	+7.9
Supply (- Vcc)	-7.6

9. Power Consumption (Typical values for information)

Typical values	Switched off (mA)	Stand by (mA)	Transmitting (mA)
Supply (+ Vcc)	+0.01	+6	+14
Supply (- Vcc)	-0.01	-8	-9

**Calibration Laboratory of
 Schmid & Partner
 Engineering AG**
 Zeughausstrasse 43, 8004 Zurich, Switzerland



S Schweizerischer Kalibrierdienst
S Service suisse d'étalonnage
C Servizio svizzero di taratura
S Swiss Calibration Service

Accredited by the Swiss Accreditation Service (SAS)
 The Swiss Accreditation Service is one of the signatories to the EA
 Multilateral Agreement for the recognition of calibration certificates

Accreditation No.: **SCS 108**

Client **SGS (Dymstec)**

Certificate No: **D2450V2-734_May10**

CALIBRATION CERTIFICATE

Object **D2450V2 - SN: 734**

Calibration procedure(s) **QA CAL-05.v7
 Calibration procedure for dipole validation kits**



Calibration date: **May 27, 2010**

This calibration certificate documents the traceability to national standards, which realize the physical units of measurements (SI).
 The measurements and the uncertainties with confidence probability are given on the following pages and are part of the certificate.

All calibrations have been conducted in the closed laboratory facility: environment temperature (22 ± 3)°C and humidity < 70%.

Calibration Equipment used (M&TE critical for calibration)

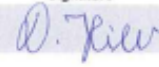
Primary Standards	ID #	Cal Date (Certificate No.)	Scheduled Calibration
Power meter EPM-442A	GB37480704	08-Oct-09 (No. 217-01086)	Oct-10
Power sensor HP 8481A	US37292783	06-Oct-09 (No. 217-01086)	Oct-10
Reference 20 dB Attenuator	SN: 5086 (20g)	30-Mar-10 (No. 217-01158)	Mar-11
Type-N mismatch combination	SN: 5047.2 / 06327	30-Mar-10 (No. 217-01162)	Mar-11
Reference Probe ES3DV3	SN: 3205	30-Apr-10 (No. ES3-3205_Apr10)	Apr-11
DAE4	SN: 601	02-Mar-10 (No. DAE4-601_Mar10)	Mar-11
Secondary Standards	ID #	Check Date (In house)	Scheduled Check
Power sensor HP 8481A	MY41092317	18-Oct-02 (In house check Oct-09)	In house check: Oct-11
RF generator R&S SMT-06	100005	4-Aug-99 (In house check Oct-09)	In house check: Oct-11
Network Analyzer HP 8753E	US37390585 S4205	18-Oct-01 (In house check Oct-09)	In house check: Oct-10

	Name	Function	Signature
Calibrated by:	Dimce Iliev	Laboratory Technician	
Approved by:	Katja Pokovic	Technical Manager	

Issued: May 27, 2010

This calibration certificate shall not be reproduced except in full without written approval of the laboratory.

Calibration Laboratory of
 Schmid & Partner
 Engineering AG
 Zeughausstrasse 43, 8004 Zurich, Switzerland



S Schweizerischer Kalibrierdienst
C Service suisse d'étalonnage
S Servizio svizzero di taratura
S Swiss Calibration Service

Accredited by the Swiss Accreditation Service (SAS)
 The Swiss Accreditation Service is one of the signatories to the EA
 Multilateral Agreement for the recognition of calibration certificates

Accreditation No.: **SCS 108**

Glossary:

TSL tissue simulating liquid
 ConvF sensitivity in TSL / NORM x,y,z
 N/A not applicable or not measured

Calibration is Performed According to the Following Standards:

- a) IEEE Std 1528-2003, "IEEE Recommended Practice for Determining the Peak Spatial-Averaged Specific Absorption Rate (SAR) in the Human Head from Wireless Communications Devices: Measurement Techniques", December 2003
- b) IEC 62209-1, "Procedure to measure the Specific Absorption Rate (SAR) for hand-held devices used in close proximity to the ear (frequency range of 300 MHz to 3 GHz)", February 2005
- c) Federal Communications Commission Office of Engineering & Technology (FCC OET), "Evaluating Compliance with FCC Guidelines for Human Exposure to Radiofrequency Electromagnetic Fields; Additional Information for Evaluating Compliance of Mobile and Portable Devices with FCC Limits for Human Exposure to Radiofrequency Emissions", Supplement C (Edition 01-01) to Bulletin 65

Additional Documentation:

- d) DASY4/5 System Handbook

Methods Applied and Interpretation of Parameters:

- *Measurement Conditions:* Further details are available from the Validation Report at the end of the certificate. All figures stated in the certificate are valid at the frequency indicated.
- *Antenna Parameters with TSL:* The dipole is mounted with the spacer to position its feed point exactly below the center marking of the flat phantom section, with the arms oriented parallel to the body axis.
- *Feed Point Impedance and Return Loss:* These parameters are measured with the dipole positioned under the liquid filled phantom. The impedance stated is transformed from the measurement at the SMA connector to the feed point. The Return Loss ensures low reflected power. No uncertainty required.
- *Electrical Delay:* One-way delay between the SMA connector and the antenna feed point. No uncertainty required.
- *SAR measured:* SAR measured at the stated antenna input power.
- *SAR normalized:* SAR as measured, normalized to an input power of 1 W at the antenna connector.
- *SAR for nominal TSL parameters:* The measured TSL parameters are used to calculate the nominal SAR result.

Measurement Conditions

DASY system configuration, as far as not given on page 1.

DASY Version	DASY5	V5.2
Extrapolation	Advanced Extrapolation	
Phantom	Modular Flat Phantom V4.9	
Distance Dipole Center - TSL	10 mm	with Spacer
Zoom Scan Resolution	dx, dy, dz = 5 mm	
Frequency	2450 MHz ± 1 MHz	

Head TSL parameters

The following parameters and calculations were applied.

	Temperature	Permittivity	Conductivity
Nominal Head TSL parameters	22.0 °C	39.2	1.80 mho/m
Measured Head TSL parameters	(22.0 ± 0.2) °C	39.0 ± 6 %	1.76 mho/m ± 6 %
Head TSL temperature during test	(21.5 ± 0.2) °C	----	----

SAR result with Head TSL

SAR averaged over 1 cm ³ (1 g) of Head TSL	Condition	
SAR measured	250 mW input power	12.8 mW / g
SAR normalized	normalized to 1W	51.2 mW / g
SAR for nominal Head TSL parameters	normalized to 1W	51.7 mW /g ± 17.0 % (k=2)

SAR averaged over 10 cm ³ (10 g) of Head TSL	condition	
SAR measured	250 mW input power	6.03 mW / g
SAR normalized	normalized to 1W	24.1 mW / g
SAR for nominal Head TSL parameters	normalized to 1W	24.2 mW /g ± 16.5 % (k=2)

Body TSL parameters

The following parameters and calculations were applied.

	Temperature	Permittivity	Conductivity
Nominal Body TSL parameters	22.0 °C	52.7	1.95 mho/m
Measured Body TSL parameters	(22.0 ± 0.2) °C	53.6 ± 6 %	1.97 mho/m ± 6 %
Body TSL temperature during test	(21.8 ± 0.2) °C	----	----

SAR result with Body TSL

SAR averaged over 1 cm ³ (1 g) of Body TSL	Condition	
SAR measured	250 mW input power	13.4 mW / g
SAR normalized	normalized to 1W	53.6 mW / g
SAR for nominal Body TSL parameters	normalized to 1W	53.5 mW / g ± 17.0 % (k=2)

SAR averaged over 10 cm ³ (10 g) of Body TSL	condition	
SAR measured	250 mW input power	6.31 mW / g
SAR normalized	normalized to 1W	25.2 mW / g
SAR for nominal Body TSL parameters	normalized to 1W	25.2 mW / g ± 16.5 % (k=2)

Appendix

Antenna Parameters with Head TSL

Impedance, transformed to feed point	53.8 Ω + 3.2 j Ω
Return Loss	- 26.4 dB

Antenna Parameters with Body TSL

Impedance, transformed to feed point	49.8 Ω + 4.4 j Ω
Return Loss	- 27.1 dB

General Antenna Parameters and Design

Electrical Delay (one direction)	1.153 ns
----------------------------------	----------

After long term use with 100W radiated power, only a slight warming of the dipole near the feedpoint can be measured.

The dipole is made of standard semirigid coaxial cable. The center conductor of the feeding line is directly connected to the second arm of the dipole. The antenna is therefore short-circuited for DC-signals.

No excessive force must be applied to the dipole arms, because they might bend or the soldered connections near the feedpoint may be damaged.

Additional EUT Data

Manufactured by	SPEAG
Manufactured on	May 07, 2003

DASY5 Validation Report for Head TSL

Date/Time: 25.05.2010 14:48:31

Test Laboratory: SPEAG, Zurich, Switzerland

DUT: Dipole 2450 MHz; Type: D2450V2; Serial: D2450V2 - SN:734

Communication System: CW; Frequency: 2450 MHz; Duty Cycle: 1:1

Medium: HSL U11 BB

Medium parameters used: $f = 2450$ MHz; $\sigma = 1.76$ mho/m; $\epsilon_r = 39$; $\rho = 1000$ kg/m³

Phantom section: Flat Section

Measurement Standard: DASY5 (IEEE/IEC/ANSI C63.19-2007)

DASY5 Configuration:

- Probe: ES3DV3 - SN3205; ConvF(4.53, 4.53, 4.53); Calibrated: 30.04.2010
- Sensor-Surface: 3mm (Mechanical Surface Detection)
- Electronics: DAE4 Sn601; Calibrated: 02.03.2010
- Phantom: Flat Phantom 5.0 (front); Type: QD000P50AA; Serial: 1001
- Measurement SW: DASY5, V5.2 Build 162; SEMCAD X Version 14.0 Build 61

Pin=250 mW /d=10mm, dist=3.0mm (ES-Probe)/Zoom Scan (7x7x7) /Cube 0: Measurement
 grid: dx=5mm, dy=5mm, dz=5mm

Reference Value = 101.2 V/m; Power Drift = 0.030 dB

Peak SAR (extrapolated) = 26.1 W/kg

SAR(1 g) = 12.8 mW/g; SAR(10 g) = 6.03 mW/g

Maximum value of SAR (measured) = 16.7 mW/g

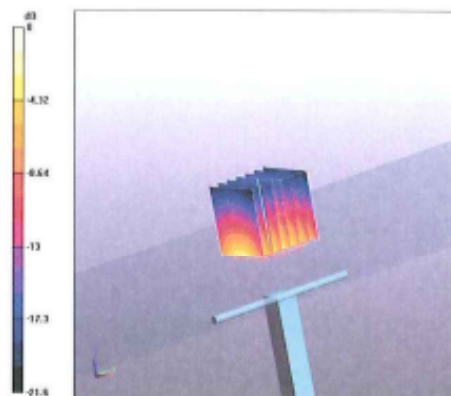

0 dB = 16.7mW/g

Impedance Measurement Plot for Head TSL

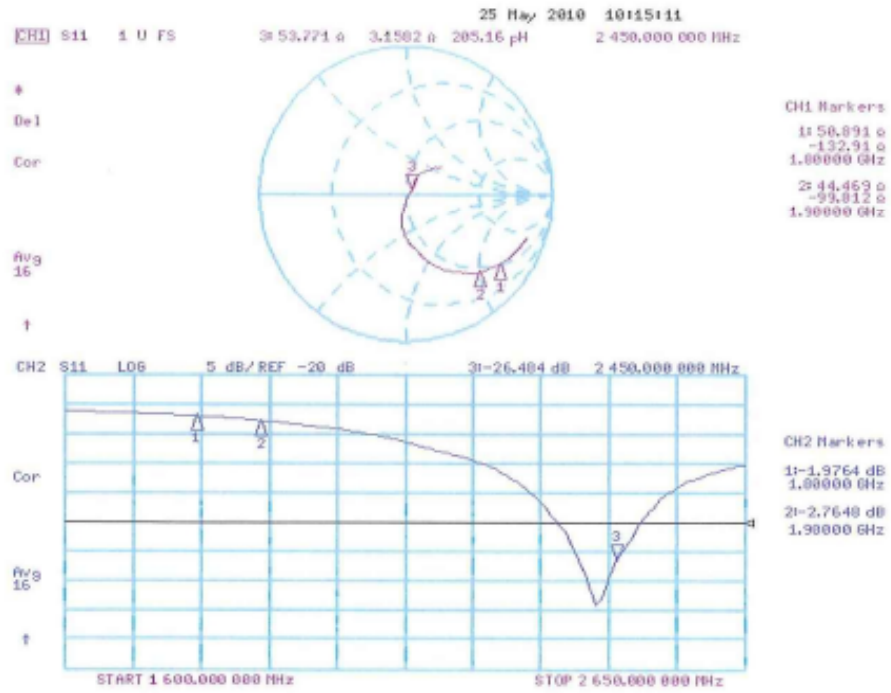

DASY5 Validation Report for Body

Date/Time: 27.05.2010 10:14:45

Test Laboratory: SPEAG, Zurich, Switzerland

DUT: Dipole 2450 MHz; Type: D2450V2; Serial: D2450V2 - SN:734

Communication System: CW; Frequency: 2450 MHz; Duty Cycle: 1:1

Medium: MSL U11 BB

Medium parameters used: $f = 2450$ MHz; $\sigma = 1.97$ mho/m; $\epsilon_r = 53.6$; $\rho = 1000$ kg/m³

Phantom section: Flat Section

Measurement Standard: DASY5 (IEEE/IEC/ANSI C63.19-2007)

DASY5 Configuration:

- Probe: ES3DV3 - SN3205; ConvF(4.31, 4.31, 4.31); Calibrated: 30.04.2010
- Sensor-Surface: 3mm (Mechanical Surface Detection)
- Electronics: DAE4 Sn601; Calibrated: 02.03.2010
- Phantom: Flat Phantom 5.0 (back); Type: QD000P50AA; Serial: 1002
- Measurement SW: DASY5, V5.2 Build 162; SEMCAD X Version 14.0 Build 61

Pin=250 mW /d=10mm, dist=3.0mm (ES-Probe)/Zoom Scan (7x7x7) /Cube 0: Measurement

grid: dx=5mm, dy=5mm, dz=5mm

Reference Value = 96.7 V/m; Power Drift = -0.030 dB

Peak SAR (extrapolated) = 27.3 W/kg

SAR(1 g) = 13.4 mW/g; SAR(10 g) = 6.31 mW/g

Maximum value of SAR (measured) = 17.4 mW/g

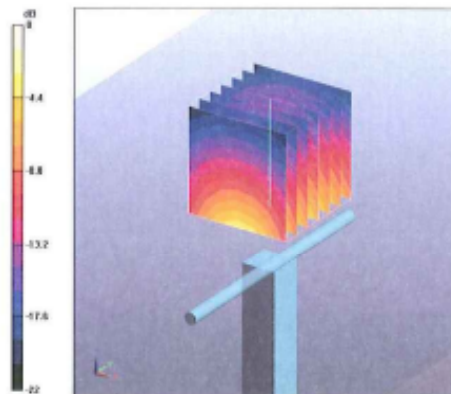

0 dB = 17.4mW/g

Impedance Measurement Plot for Body TSL

