

Viewing files by category in Smart Album

- 1 In the thumbnail view, press **[MENU]**.
- 2 Select **Filter** → a category, and then press **[OK]**.

Option	Description
Type	View files by the file type such as photo or video.
Date*	View files by the date they were saved.
Week	View files by the day of the week they were saved.
Location	View file by the place they were saved. (Only the photos captured with a GPS module have the location information.)

* Default

Viewing files as a folder

Continuous and burst shots appear as a folder. Deleting a folder will delete all photos in the folder.

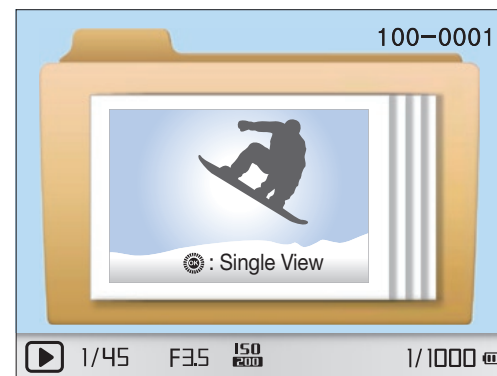

Protecting files

Protect your files from accidental deletion.



- 1 In Playback mode, press **[MENU]** →   → **Protect** → an option. (**Single**, **Select**, **All**)
- 2 Rotate the navigation button or press  / **AF** to select a file, and then press .
- 3 Press **[Fn]**.

Deleting files

Delete files in Playback mode and secure more space on your memory card. Protected files are not deleted.

Deleting a single file

You can select a single file and delete it.

- 1 In Playback mode, select a file, and then press .
 - Alternatively, in Playback mode, press **[MENU]** →   → **Delete** → **Single**.
- 2 When the pop-up message appears, select **Yes**.

Deleting multiple files

You can select multiple files and delete them.

- 1 In Playback mode, press [🗑️] → **Multiple Delete**.
 - Alternatively, in Playback mode, press [MENU] → [▶] [1] → **Delete** → **Select**.
- 2 Select files you want to delete by rotating the navigation button or pressing [👁️/AF], and then press [OK].
 - Press [OK] again to cancel your selection.
- 3 Press [🗑️].
- 4 When the pop-up message appears, select **Yes**.

Deleting all files

You can delete all files on the memory card at once.

- 1 In Playback mode, press [MENU].
- 2 Select [▶] [1] → **Delete** → **All**.
- 3 When the pop-up message appears, select **Yes**.

Viewing photos

Enlarging a photo

You can enlarge photos when viewing them in Playback mode. You can also use the Trim function to extract the portion of the image displayed on the screen and save it as a new file.

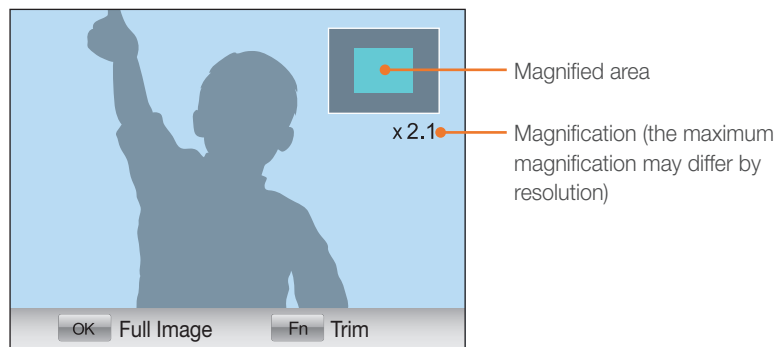

Press **[OK]**, and then rotate the navigation button clockwise to enlarge a photo.

(Rotate the navigation button counter-clockwise to reduce a photo.)

To	Do this
Move magnified area	Press [DISP/⊞] [Z/📷/AF] .
Crop the enlarged image	Press [Fn] . (saved as a new file)
Return to the original image	Press [OK] .

Viewing a slide show

You can view photos in a slide show, apply various effects to the slide show, and play background music.

1 In Playback mode, press **[MENU]**.

2 Select **[📷]** **[T]**.

3 Select a slide show effect option.

- Skip to step 4 to start a slide show with no effects.

Option	Description
Images	Set the photos you want to view as a slide show. <ul style="list-style-type: none"> • All: View all photos in a slide show. • Date: View photos captured on a specific date in a slide show. • Select: View selected photos in a slide show.
Effect	Select a transition effect. Select Off for no effects.
Interval	Select the amount of time each photo is displayed.
Music	Select a background music.

4 Select **Slide Show** → **Play** or **Repeat**.

- Slide show begins right away.

Auto rotating

With Auto Rotate on, the camera automatically rotates photos you have captured vertically so they fit the screen horizontally.

To set auto rotate options,

In Playback mode, press **[MENU]** →  → **Auto Rotate** → an option.

Setting the thumbnail mode

You can select the number of files to view in the thumbnail mode.

To set thumbnail mode options,

In playback mode, press **[MENU]** →  → **Thumbnail mode** → an option.





Playing videos





You can play a video, capture an image from a video, or crop a video.



Video viewing controls

To	Do this
Rewind	Press []. Scan backward in 2X, 4X, and 8X increments each time you press [].
Pause/Play	Press [].
Fast forward	Press [AF]. Scan forward in 2X, 4X, and 8X increments each time you press [AF].
Volume control	Rotate the navigation button to the left or right.
Stop	Press [DISP].

Trimming a video during playback

- 1 Press [] at the point where you want the new video to begin.
- 2 When paused, press [].
- 3 Press [] at the point where you want the new video to end.
- 4 When paused, press [].
- 5 When the pop-up message appears, select Yes.



The cut file is saved as a separate file under a new name.

Capturing an image during playback

- 1 Press [OK] at the point where you want to save a still image.
- 2 Press [⏏].



- The resolution of the captured image is the same as the video resolution.
- The captured file is saved as a separate file under a new name.







Editing photos

Perform photo editing tasks, such as resizing, rotating, eliminating red-eye effects, and adjusting brightness, contrast, or saturation. Edited photos are saved as new files under different file names. 3D photos, panoramic photos, and 3D panoramic photos cannot be edited with the Image Edit function.









To set Image Edit options,

In Playback mode, press **[Fn]** → an option.









Options

Icon	Description
	<p>Smart Filter: Apply various filter effects to photos and create unique images. (Off*, Miniature, Soft Focus, Old Film 1, Old Film 2, Halftone Dots, Sketch, Fish Eye, Defog, Negative)</p> <p> The new file may be smaller than the original.</p>
	<p>Red-eye Fix: Remove red-eyes on a photo. (Off*, On)</p> <p> The new file may be smaller than the original.</p>

* Default

Icon	Description
	<p>Backlight: Correct the brightness of an underexposed photo. (Off*, On)</p> <div style="display: flex; justify-content: space-around;">   </div> <p style="display: flex; justify-content: space-around;"> Before correction After correction </p> <p> The new file may be smaller than the original.</p>
	<p>Resize: Resize the size of a photo.</p> <p> The available resolutions may differ depending on the size of the selected photo.</p>
	<p>Rotate: Rotate a photo. (Off*, Right 90°, Left 90°, 180°, Horizontal, Vertical)</p> <p> You cannot rotate protected files or RAW files.</p>

* Default

Icon	Description
	<p>Face Retouch: Hide facial imperfections.</p> <div data-bbox="241 349 942 436">  <p>The new file may be smaller than the original.</p> </div>
	<p>Brightness: Adjust the brightness of a photo.</p> <div data-bbox="241 504 942 591">  <p>The new file may be smaller than the original.</p> </div>
	<p>Contrast: Adjust the sharpness of a photo.</p> <div data-bbox="241 665 942 751">  <p>The new file may be smaller than the original.</p> </div>
	<p>Vignetting: Apply the retro-looking colors, high contrast, and strong vignette effect of Lomo cameras.</p> <div data-bbox="241 839 942 926">  <p>The new file may be smaller than the original.</p> </div>





Chapter 4





Wireless network

Learn how to connect to wireless local area networks (WLANs) and use functions.





Connecting to a WLAN and configuring network settings

Learn to connect via an access point (AP) when you are in a range of a WLAN. You can also configure network settings.

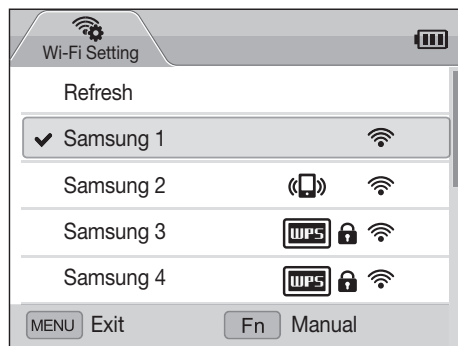
Connecting to a WLAN

- 1 Rotate the mode dial to **Wi-Fi**.
- 2 Select , , , , or .
- 3 Press [**MENU**], and then select **Wi-Fi Setting**.
 - In some modes, press [**MENU**] or follow the on-screen instructions until the Wi-Fi Setting screen appears.
 - The camera automatically searches for available AP devices.
- 4 Select an AP.



Icon/Option	Description
Refresh	Refresh connectable APs.
	Ad hoc AP
	Secured AP
	WPS AP
	Signal strength
WPS button connection	Connect to a WPS AP.
Add wireless network	Add an AP manually.

- Press [**Fn**] to open network setting options.
- When you select a secured AP, a pop-up window appears. Enter the required passwords to connect to the WLAN. For information about entering text, refer to "Entering text". (p. 105)
- When a login page appears, refer to "Using the login browser". (p. 103)
- When you select an unsecured AP, the camera will connect to the WLAN.
- If you select a WPS profile supported AP, select **WPS PIN connection**, and then enter a PIN on the AP device. You can also connect to a WPS profile supported AP by selecting **WPS button connection** on the camera, and then pushing the **WPS** button on the AP device.

Setting network options

- 1 In the Wi-Fi Setting screen, move to an AP, and then press **[Fn]**.
- 2 Select each option and enter the required information.

Option	Description
Authentication	Select a network authentication type.
Data Encryption	Select an encryption type.
Network Key	Enter the network password.
IP Setting	Set the IP address manually.





Manually setting the IP address

- 1 In the Wi-Fi Setting screen, move to an AP, and then press **[Fn]**.
- 2 Select **IP Setting** → **Manual**.
- 3 Select each option, and then enter the required information.

Option	Description
IP	Enter the static IP address.
Subnet Mask	Enter the subnet mask.
Gateway	Enter the gateway.
DNS Server	Enter the DNS address.

Using the login browser

You can enter your login information via the login browser when connecting to some APs, sharing sites, or cloud servers.

Button	Description
[DISP/  /  /  / AF]	Move to an item or scroll the page.
[]	Select an item.
[MENU]	Access the following options: <ul style="list-style-type: none"> • Previous Page: Move to the previous page. • Next Page: Move to the next page. • Reload: Reload the page. • Stop: Stop loading the page. • Exit: Close the login browser.
[]	Close the login browser.



- You can reduce or enlarge a web page by rotating the navigation button.
- You cannot select some items depending on the page you connected to. This does not indicate a malfunction.
- The login browser may not close automatically after you log into some pages. If this occurs, close the login browser by pressing [, and then proceed with the desired operation.
- It may take longer to load the login page due to the page size or network speed. If this occurs, wait until the login information input window appears.







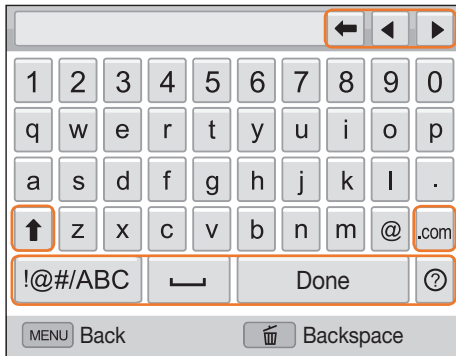

Network connection tips

- The quality of the network connection will be determined by the AP.
- The further the distance between your camera and the AP, the longer it will take to connect to the network.
- If a nearby device is using the same radio frequency signal as your camera, it may interrupt your connection.
- If your AP name is not in English, the camera may not be able to locate the device or the name may appear incorrectly.
- For network settings or a password, contact your network administrator or network service provider.
- If a WLAN requires authentication from the service provider, you may not be able to connect to it. To connect the WLAN, contact your network service provider.
- Depending on the encryption type, the number of digits in the password may differ.
- A WLAN connection may not be possible in all surroundings.
- The camera may display a WLAN enabled printer on the AP List. You cannot connect to the network via a printer.
- You cannot connect your camera to a network and a TV simultaneously. Also, you cannot view photos or videos on a TV while connected to a network.
- Connecting to a network may incur additional charges. Costs will vary based on the conditions of your contract.
- If you cannot connect to a WLAN, try another AP from the available AP list.
- You can also connect to free WLANs in some foreign countries.
- A login page may appear when you select free WLANs provided by some network service providers. Enter your ID and password to connect to the WLAN. For information about registering or the service, contact the network service providers.
- Be cautious when you enter personal information for an AP connection. Do not enter any payment or credit card information on your camera. The manufacturer is not liable for any problem caused by entering such information.
- Available network connections may differ by country.
- The WLAN feature of your camera must comply with radio transmission laws in your region. To ensure compliance, use the WLAN feature only in the country where you purchased the camera.
- The process for adjusting network settings may differ, depending on network conditions.
- Do not access a network that you are not authorized to use.
- Before you connect to a network, ensure your battery is fully charged.
- When a DHCP server is not available you must make an autoip.txt file and copy it to the inserted memory card to connect to the network using Auto IP.

Entering text

Learn how to enter text. The icons in the table below let you move the cursor, change the case, etc. Use the navigation button to scroll to a desired key, and then press  to enter the key.



Icon	Description
	Delete the last letter.
	Move the cursor.
	In ABC mode, change the case.
.COM	Enter ".com".
!@#/ABC	Switch between Symbol mode and ABC mode.
	Enter a space.
Done	Save the displayed text.
	View the entering text guide.



- You can enter only English alphabets, regardless of the display language.
- To move to **Done** directly, press .
- You can enter up to 64 characters.

Sending photos or videos to a smart phone

The camera connects to a smart phone that supports the MobileLink feature via a WLAN. You can easily send photos or videos to your smart phone.



- The MobileLink feature is supported by Galaxy series smart phones with the Android 2.2 OS or higher. If your smart phone uses the Android 2.1 OS, upgrade your smart phone to Android 2.2 or higher. This feature is also supported by 7 and 10.1 inch Galaxy Tab.
- You should install the Samsung MobileLink application on your phone or device before using this feature. You can download the application from Samsung Apps or Android market.
- When there are no files in the camera memory, you cannot use this feature.
- You can view up to 1,000 files and send up to 100 files at a time.
- You cannot send RAW files.

1 On the camera, rotate the mode dial to **Wi-Fi**.

2 On the camera, select .

- If the pop-up message that prompts you to download the application appears, select **Next**.

3 On the camera, select **All Images** or **Selected Images** to select files to share with the smart phone.

- Only the selected files will be displayed on the smart phone.
- If you **Selected Images**, select **Share** on the camera after selecting files to share.

4 On the smart phone, turn on the Samsung MobileLink application.

- Read the on-screen instructions carefully to select and connect to your camera.
- The smart phone can connect to only one camera at a time.

5 On the camera, select **Yes**.

6 On the smart phone, select files to send from the camera to the smart phone.

7 On the smart phone, select **Copy**.

- The camera will send the files.

Using a smart phone as a remote shutter release

The camera connects to a smart phone via a WLAN. Use the smart phone as a remote shutter release with the Remote Viewfinder feature. The captured photo will display on the smart phone.



- The Remote Viewfinder feature is supported by Galaxy series smart phones with the Android 2.2 OS or higher. If your smart phone uses the Android 2.1 OS, upgrade your smart phone to Android 2.2 or higher. This feature is also supported by 7 and 10.1 inch Galaxy Tab.
- You should install the Remote Viewfinder application on your phone or device before using this feature. You can download the application from Samsung Apps or Android market.

1 On the camera, rotate the mode dial to **Wi-Fi**.



2 On the camera, select .



- If the pop-up message that prompts you to download the application appears, select **Yes**.

3 On the smart phone, turn on the Remote Viewfinder application.

- Read the on-screen instructions carefully to select and connect to your camera.
- The smart phone can connect to only one camera at a time.

4 On the smart phone, set the following shooting options.



Icon	Description
	Flash option
	Timer option
	Photo size

- While using this feature, some buttons are not available on your camera.
- The zoom button and the shutter button on your smart phone will not function when using this feature.
- Remote Viewfinder mode supports the  and  photo sizes only.

5 On the smart phone, touch and hold to focus.

- The focus is automatically set to multi-AF.

6 Release to capture the photo.

- The photo will be saved in your camera.
- Touch the photo at the bottom of the screen to save it to the smart phone. If you have captured a photo with the  photo size, the photo will be resized to 1616X1080. If you have captured a photo with the  photo size, the photo will be resized to 640X360.



- When you use this feature, the ideal distance between the camera and the smart phone may vary, depending on your surroundings.
- The smart phone must be within 7 m of the camera to use this feature.
- It will take some time to capture the photo after you release  on the smart phone.
- The Remote Viewfinder function will deactivate when:
 - there is an incoming call on the smart phone
 - either of the camera or the smart phone turn off
 - the memory is full
 - either device loses connection to the WLAN
 - the Wi-Fi connection is poor or unstable



Using photo or video sharing websites

Upload your photos or videos to file sharing websites. Available websites will be displayed on your camera.

Accessing a website

- 1 Rotate the mode dial to **Wi-Fi**.
- 2 Select .
- 3 Select a website.
 - The camera will automatically attempt to connect to a WLAN via the most recently connected AP device.
 - If the camera has not previously been connected to a WLAN, it will search for available AP devices. (p. 101)
- 4 Enter your ID and password, and then select **Login**.
 - For information about entering text, refer to "Entering text". (p. 105)
 - To select an ID from the list, select ▼ → an ID.
 - If you have previously logged in to the website, you may be logged in automatically.



You must have an existing account on the file sharing website to use this feature.



Uploading photos or videos

- 1 Access the website with your camera.
- 2 Scroll to the files you want to upload, and then press .

 - You can select up to 20 files. The total size must be 10 MB or less.

- 3 Select **Upload**.
 - If you connected to Facebook, select **Upload** → **Upload**.
 - If you connected to Facebook, you can enter your comments by selecting the **Comment** box. For information about entering text, refer to "Entering text". (p. 105)



- You cannot upload RAW files.
- You can upload up to 20 files at a time.
- The maximum photo resolution you can upload is 2M, and the longest video you can upload is a video recorded using **240 FPS**. If the selected photo resolution is higher than 2M, it will be automatically resized to a lower resolution. If you connected to Facebook, the photo resolution will be resized to 1M resolution.
- The method of uploading photos or videos may differ depending on the selected website.
- If you cannot access a website because of firewall or user authentication settings, contact your network administrator or network service provider.
- Uploaded photos or videos may be automatically titled with the date they were captured.
- The speed of your internet connection may affect how quickly photos upload or web pages open.
- When there are no files in the camera memory, you cannot use this feature.
- You can also upload photos or videos to file sharing websites in Playback mode by pressing [**MENU**], and then selecting   → **Share(Wi-Fi)** → a desired website.





Sending photos or videos via email

You can change settings in the email menu, and send photos or videos stored on the camera via email.

Changing email settings

In the email menu, you can change settings for storing your information. You can also set or change the email password. For information about entering text, refer to "Entering text". (p. 105)

Storing your information

- 1 Rotate the mode dial to **Wi-Fi**.
- 2 Select .
- 3 Press **[MENU]**.
- 4 Select  → **Sender Setting**.



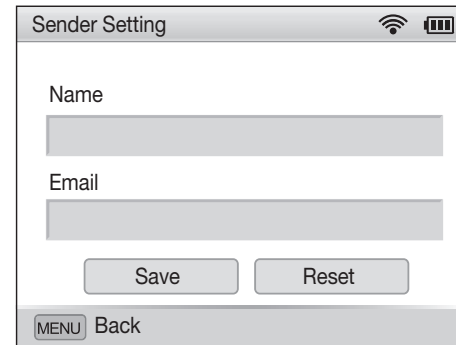



- 5 Select the **Name** box, enter your name, and then select **Done**.



The screenshot shows the 'Sender Setting' menu. At the top, there's a title bar with 'Sender Setting' and icons for Wi-Fi and battery. Below the title bar, there are two text input fields: 'Name' and 'Email'. Underneath these fields are two buttons: 'Save' and 'Reset'. At the very bottom, there is a 'MENU Back' button.

- 6 Select the **Email** box, enter your email address, and then select **Done**.
- 7 Select **Save** to save your changes.
 - To delete your information, select **Reset**.





Setting an email password

- 1 Rotate the mode dial to **Wi-Fi**.
- 2 Select .
- 3 Press [**MENU**].
- 4 Select  → **Setting Password** → **On**.
 - To deactivate the password, select **Off**.
- 5 When the pop-up appears, press [].
 - The pop-up disappears automatically even if you do not press [].
- 6 Enter a 4-digit password.
- 7 Enter the password again.
- 8 When the pop-up appears, press [].
 - The pop-up disappears automatically even if you do not press [].



If you lost your password, you can reset it by selecting **Reset** on the password setting screen. When you reset the information, previously saved user's setting information, email address, and recently sent email list will be deleted.

Changing the email password

- 1 Rotate the mode dial to **Wi-Fi**.
- 2 Select .
- 3 Press [**MENU**].
- 4 Select  → **Change Password**.
- 5 Enter your current 4-digit password.
- 6 Enter a new 4-digit password.
- 7 Enter the new password again.
- 8 When the pop-up appears, press [].
 - The pop-up disappears automatically even if you do not press [].

Sending photos or videos via email

You can send photos or videos stored on the camera via email.
For information about entering text, refer to "Entering text". (p. 105)

- 1 Rotate the mode dial to **Wi-Fi**.
- 2 Select .
- 3 Select the **Sender** box, enter your email address, and then select **Done**.
 - If you have previously saved your information, it will be inserted automatically. (p. 111)
 - To use an address from the list of previous recipients, select ▼ → an address.
- 4 Select the **Receiver** box, enter an email address, and then select **Done**.
 - To use an address from the list of previous recipients, select ▼ → an address.
 - Select **+** to add additional recipients. You can input up to 30 recipients.
 - Select **X** to delete an address from the list.
- 5 Select **Next**.

- 6 Scroll to files to send, and then press [**OK**].
 - You can select up to 20 files. The total size must be 10 MB or less.
- 7 Select **Send**.
- 8 Select the **Comment** box, enter your comments, and then select **Done**.
- 9 Select **Send**.
 - The camera will automatically attempt to connect to a WLAN via the most recently connected AP device and send the email.
 - If the camera has not previously been connected to a WLAN, it will search for available AP devices. (p. 101)



- You cannot send RAW files.
- You can send up to 20 files at a time.
- Even if a photo appears to have transferred successfully, errors with the recipient's email account may cause the photo to be rejected or recognized as spam.
- You may not be able to send an email if no network connection is available or if your email account settings are incorrect.
- The maximum photo resolution you can send is 2M and the longest video you can send is a video recorded using **240 WEB**. If the selected photo resolution is higher than 2M, it will be automatically resized to a lower resolution.
- If you cannot send an email because of firewall or user authentication settings, contact your network administrator or network service provider.
- When there are no files in the camera memory, you cannot use this feature.
- You can also send an email in Playback mode by pressing **[MENU]**, and then selecting **[▶] [T] → Share(Wi-Fi) → Email**.



Uploading photos to a cloud server

You can upload your photos to SkyDrive. To upload files, you must visit the Microsoft website and register before connecting your camera.

1 Rotate the mode dial to **Wi-Fi**.

2 Select .

- If the pop-up message that prompts you to create an account appears, select **OK**.
- The camera will attempt to connect to a WLAN via the most recently connected AP.
- If the camera has not previously been connected to a WLAN, it will search for available AP devices. (p. 101)

3 Log in with your ID and password.

- For information about entering text, refer to "Entering text". (p. 105)
- If you connected to SkyDrive, refer to "Using the login browser". (p. 103)
- Press [**MENU**] to use option menus.

Option	Description
Previous Page	Move to the previous page.
Next Page	Move to the next page.
Reload	Reload the page.
Stop	Stop loading the page.
Exit	Close the login browser.

4 Scroll to the photos you want to upload, and then press [.

5 Select **Upload**.



- You can also upload photos to a cloud server in Playback mode by pressing [**MENU**], and then selecting  → **Share(Wi-Fi)** → a cloud server.
- When there are no photos in the camera memory, you cannot use this feature.

Using Auto Backup to send photos or videos

You can send photos or videos that you captured with the camera to a PC wirelessly. The Auto Backup feature works only with the Windows OS.



Installing the program for Auto Backup on your PC

- 1 Install Intelli-studio on the PC. (p. 141)
- 2 Connect the camera to the PC with the USB cable.
- 3 Click **OK** on the pop-up window.
 - The Auto Backup program is installed on the PC. Follow the on-screen instructions to complete the installation.
- 4 Remove the USB cable.
- 5 Connect the camera to the PC again with the USB cable.
 - The camera stores information about the PC, so that the camera can send files to the PC.



Before installing program, ensure that the PC is connected to a network. If no internet connection is available, you must install the program from the provided CD.

Sending photos or videos to a PC

- 1 Rotate the mode dial to **Wi-Fi**.
- 2 Select .
 - You must configure the backup PC information to use the Auto Backup feature. For more details, refer to “Installing the program for Auto Backup on your PC”. (p. 116)
- 3 Press [**MENU**] to set options.
 - To turn off your PC automatically after the transfer is complete, select  → **Shut down PC after backup** → **On**.
 - To view the help for the Auto Backup function, select  → **Guide**.
- 4 Press [**OK**] to start the backup.
 - To cancel sending, press [**OK**].
 - You cannot select individual files to backup. This function backs up only new files on the camera.
 - The backup's progress will be shown on the PC monitor.
 - When the transfer is completed, the camera will turn off automatically in approximately 30 seconds. Select **Cancel** to return to the previous screen and prevent the camera from turning off automatically.



- If the PC supports the Wake on LAN (WOL) feature, you can turn on the PC automatically by searching for the PC from your camera. (p. 121)
- When you connect the camera to the WLAN, select the AP that is connected to the PC.
- The camera will search for available access points even if you are connecting to the same access point again.
- If you turn off the camera or remove the battery while sending files, the file transfer will be interrupted.
- While you are using this feature, only **[Power]** is available on your camera.
- You can connect only one camera to the PC at a time for sending files.
- The backup may be canceled due to network conditions.
- Photos or videos can be sent to a PC one time only. Files cannot be sent again even if you reconnect your camera to another PC.
- When there are no files in the camera memory, you cannot use this feature.
- You must turn off Windows Firewall and any other firewalls before using this feature.
- You can send up to 1,000 files.
- On the PC software, the server name must be entered in the Latin alphabet and can contain no more than 48 characters.



Viewing photos or videos on a TV Link-enabled TV

TV Link is a technology for sharing media files between a camera and TV connected to the same AP device. With this technology, you can view your photos or videos on a widescreen TV.

1 Rotate the mode dial to **Wi-Fi**.



2 Select .

- If the guide message appears, press .
- The camera will automatically attempt to connect to a WLAN via the most recently connected AP device.
- If the camera has not previously been connected to a WLAN, it will search for available AP devices. (p. 101)

3 Connect your TV to a wireless network via an AP device.

- Refer to your TV's user manual for more information.

4 On the TV, search for the camera and browse the shared photos or videos.

- For information about searching for the camera and browsing the photos or videos on the TV, refer to the TV's user manual.
- Videos may not play smoothly depending on the type of TV or network condition. If this happens, re-record the video in  or  quality and play it again. If videos do not play smoothly on your TV over the wireless connection, try connecting the camera to the TV with the HDMI cable.

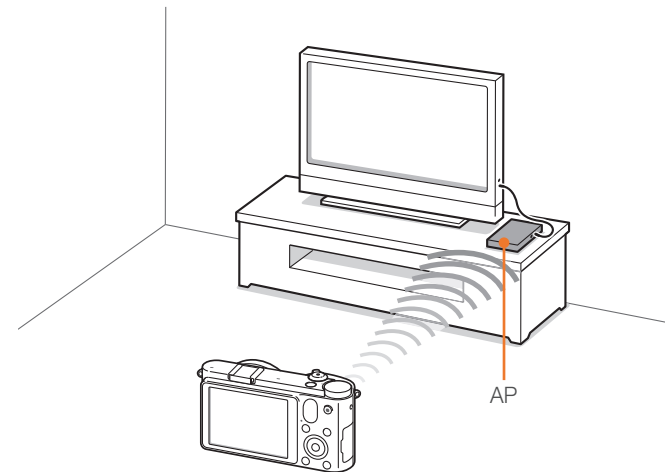





- You cannot share RAW files.
- You can share up to 1,000 photos or videos.
- On a TV screen, you can view only photos or videos captured with your camera.
- The range of the wireless connection between your camera and a TV may vary depending on the specifications of the AP.
- If the camera is connected to 2 TVs, playback may be slower.
- You can use this feature only with TV Link-enabled TVs.
- Photos or videos will be shared in their original sizes.
- Some videos may buffer more slowly than others.
- Shared photos or videos will not be stored on the TV, but they can be stored in the camera to meet the TV's specifications.
- Transferring photos or videos to the TV may take some time depending on the network connection, the number of files to be shared, or sizes of the files.
- If you power off the camera abnormally while viewing photos or videos on a TV (for example, by removing the battery), the TV considers the camera to still be connected.
- The order of photos or videos on the camera may be different than on the TV.
- Depending on the number of photos or videos you want to share, it may take some time to load your photos or videos and complete the initial set-up process.
- While viewing photos or videos on the TV, continuously using the TV remote or performing additional operations on the TV may prevent this feature from working properly.
- If you reorder or sort files on the camera while viewing them on a TV, you must repeat the initial set-up process to update the list of files on the TV.
- When there are no files in the camera memory, you cannot use this feature.



Sending photos using Wi-Fi Direct

When the camera connects via a WLAN to a device that supports the Wi-Fi Direct function, you can send photos to the device. This feature may not be supported on some devices.

- 1 On the device, turn on the Wi-Fi Direct option.
- 2 On the camera, in Playback mode, scroll to a photo.
- 3 Press **[MENU]**, and then select   → **Share(Wi-Fi)** → **Wi-Fi Direct**.
 - When in the single image view, you can send only one photo at a time.
 - When in the thumbnails view, you can select multiple photos by scrolling to thumbnails, and then pressing . Select **Send** when you are finished selecting photos.

4 Select the device from the camera's list of Wi-Fi Direct devices.

- Ensure that the device's Wi-Fi Direct option is turned on.
- You can also select your camera from the device's list of Wi-Fi Direct devices.

5 On the device, allow the camera to connect to the device.

- The photo will be sent to the device.



- You can send up to 20 files at a time.
- When there are no photos in the camera memory, you cannot use this feature.
- If you cancel the connection attempt before it is complete, the camera may not be able to reconnect to the device. In this case, update your device with the latest firmware.

About the Wake on LAN (WOL) feature

With the WOL feature, you can automatically turn on or wake up a PC with your camera. This feature has been available for Samsung desktop PCs for the last 5 years (not available for all-in-one PCs).



Any changes to your PC's BIOS settings other than the ones described below may damage your PC. The manufacturer is not responsible for damage caused by your changing your PC's BIOS settings.

Setting the PC to wake up from sleep mode

- 1 Click **Start**, and then open the **Control Panel**.
- 2 Configure the network connection.
 - Windows 7:
Click **Network and Internet** → **Network and Sharing Center** → **Change adapter settings**.
 - Windows Vista:
Click **Network and Internet** → **Network and Sharing Center** → **Manage network connections**.
 - Windows XP:
Click **Network and Internet Connection** → **Network Connection**.
- 3 Right click **Local Area**, and then click **Properties**.
- 4 Click **Configure** → the **Power manage** tab → **Allow this device to wake the computer**.
- 5 Click **OK**.
- 6 Restart the PC.

Setting the PC to turn on

- 1 Turn on the PC, and then press F2 while the PC is booting.
 - The BIOS setting menu will appear.
- 2 Select **Advanced** tab → **Power management Setup**.
- 3 Select **Resume on PME** → **Enabled**.
- 4 Press F10 to save your changes, and then continue booting.
- 5 Click **Start**, and then open the **Control Panel**.
- 6 Configure the network connection.
 - Windows 7:
Click **Network and Internet** → **Network and Sharing Center** → **Change adapter settings**.
 - Windows Vista:
Click **Network and Internet** → **Network and Sharing Center** → **Manage network connections**.
 - Windows XP:
Click **Network and Internet Connection** → **Network Connection**.

- 7 Select drivers related to network adapter.

- 8 Click **Advanced** tab, and then set WOL menus.



- You cannot use this feature across a firewall or if a security program has been installed.
- To turn on the PC with the WOL feature, the PC must have an active connection to the LAN. Ensure that the indicator light on the PC's LAN port is on indicating that the LAN connection is active.
- Depending on your PC model, the camera may only be able to wake the PC.
- Depending on your PC's OS or drivers, the names of the WOL setting menu may vary.
 - examples of setting menu names: Enable PME, Wake on LAN, etc.
 - examples of setting menu values: Enable, Magic packet, etc.



Chapter 5

Camera settings menu

Learn about the user settings and general settings menu. You can adjust the settings to better suit your needs and preferences.

User settings

You can set the user environment with these settings.

To set user options,

In Shooting mode, press **[MENU]** →  or  → an option.



Available items and the order of them may differ depending on the shooting mode.

ISO Customizing

ISO Step

You can set the size for the ISO sensitivity by either 1/3 or 1 step.

Auto ISO Range

You can set the maximum ISO value under which each EV step is chosen when you set the ISO Auto.

* Default

Option	Value
1 Step	ISO 200, ISO 400, ISO 800*, ISO 1600, ISO 3200
1/3 Step	ISO 125, ISO 160, ISO 200, ISO 250, ISO 320, ISO 400, ISO 500, ISO 640, ISO 800*, ISO 1000, ISO 1250, ISO 1600, ISO 2000, ISO 2500, ISO 3200

Noise Reduction

Use the Noise Reduction to reduce the visual noise in photos.

* Default

Option	Description
High ISO NR	This function reduces noise that may occur when you set a high ISO sensitivity. (Off , On *)
Long Term NR	This function reduces noise when you set the camera for a long exposure. (Off , On *)

DMF (Direct Manual Focus)

You can adjust the focus manually by rotating the focus ring after achieving the focus by half-pressing **[Shutter]**. This feature may not be available with some lenses.

AF Priority

You can set the camera to capture photos only when the subject is in focus.



When you capture continuous or burst shots, the camera will capture photos even if the AF priority function is turned on and the subject is not in focus.

Distortion Correct

You can correct lens distortion that might occur from lenses. This feature may not be available with some lenses.

iFn Customizing

You can select options that can be adjusted when you press **[i-Function]** on an i-Function lens.



Option	Description
Aperture	Set to adjust the aperture value.
Shutter Speed	Set to adjust the shutter speed.
EV	Set to adjust the exposure value.
ISO	Set to adjust ISO sensitivity.
WB	Set to adjust the white balance.
 zoom	Set to adjust the zoom ratio.

User Display

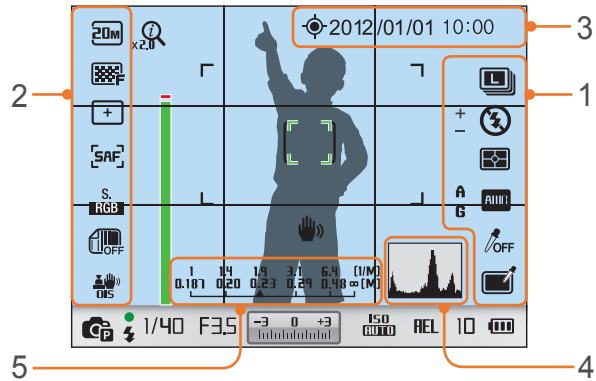
You can add or remove shooting information from the display.

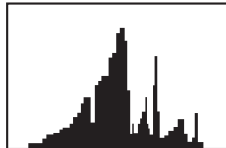
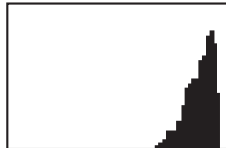

No.	Description
1	Right Icons Set to display icons on the right in Shooting mode.
2	Left Icons Set to display icons on the left in Shooting mode.
3	Date & Time Set to display the date and time.

No.	Description
4	<p>Histogram Set the histogram on the display on or off.</p> <p>About histogram A histogram is a graph that shows the brightness distribution of a photo. A histogram inclined to the left indicates a dark photo. A histogram inclined to the right indicates a bright photo. The height of the graph is related to color information. The graph gets higher if a specific color is more common.</p> <div style="display: flex; justify-content: space-around; align-items: flex-end;">    </div> <p style="text-align: center; font-size: small;">Insufficient exposure Balanced exposure Excessive exposure</p>
5	<p>Distance Scale Set to display the distance between a subject and the camera when you attach a lens that supports the Distance Scale function. (Off, ft, m*)</p> <div style="border: 1px solid #ccc; padding: 5px; margin-top: 10px;">  <p style="font-size: small; margin: 0;">This feature is available only when you attach a lens that supports the Distance Scale function.</p> </div>

Key Mapping

You can change the function assigned to the Custom button or Wi-Fi shortcut button.

* Default

Button	Function
Custom	Set a function of the Custom button. <ul style="list-style-type: none"> • Optical Preview*, which executes the Depth of Field Preview function for the current aperture value. (p. 22) • One Touch WB (White Balance), which executes the Custom White Balance function. • One Touch RAW +, which activates or deactivates the RAW+JPEG feature. • Reset, which resets some settings. • AEL, which executes the auto exposure lock function.
Wi-Fi	Set a function of the Wi-Fi shortcut button. (MobileLink*, Remote Viewfinder, Social Sharing, Email, SkyDrive, Auto Backup, TV Link)

Grid Line

Select a guide to help you compose a scene. (**Off***, **3 X 3**, **4 X 4**, **+**, **X**)

AF Lamp

When shooting in dark places, turn the AF lamp on in order to have a better auto focus. The Auto Focus functions more accurately in dark places when the AF lamp is on.

Setting 1

Learn about the menu items of the Setting 1.

To set Setting 1 options,

In Shooting or Playback mode, press [MENU] →  → an option.

Item	Description
Language	Set a language the camera shows on the display.
File Name	Set the method of creating file names. <ul style="list-style-type: none"> • Standard*: SAM_XXXX.JPG (sRGB)/_SAMXXXX.JPG (Adobe RGB) • Date: <ul style="list-style-type: none"> - sRGB files - MMDDxxxx.JPG. For example, for a photo captured on Jan. 01, the file name would be 0101xxxx.jpg. - Adobe RGB files - MDDxxxx.JPG for the months Jan through Sept. For the months Oct through Dec, the month number is replaced by the letters A (Oct.), B (Nov.) and C (Dec.). For example, for a photo captured on Feb. 03, the file name would be 203xxxx.jpg. For a photo captured on Oct. 05, the file name would be A05xxxx.jpg.

* Default

Item	Description
File Number	Set the method of numbering files and folders. <ul style="list-style-type: none"> • Reset: After using the reset function, the next file name is started at 0001. • Series*: New file numbers continue the existing number sequence, even if you have installed a new memory card, formatted the card, or deleted all photos. <div style="border: 1px solid #ccc; padding: 10px; margin-top: 10px;">  <ul style="list-style-type: none"> • The first folder name is 100PHOTO, if you have selected the sRGB color space and Standard file naming, the first file name is SAM_0001. • File name numbers are increased by 1 from SAM_0001 to SAM_9999. • Folder numbers are increased by 1 from 100PHOTO to 999PHOTO. • The maximum number of files that can be saved in one folder is 9,999. • File numbers are assigned according to DCF (Design rule for Camera File system) specifications. • If you change a file name (for example, on a computer), the camera will not be able to play the file. </div>

* Default

Item	Description
Folder Type	Set the type of folder. <ul style="list-style-type: none">• Standard*: XXXPHOTO• Date: XXX_MMDD
Format	Format the memory card. Formatting prepares a memory card for use in the camera and deletes all existing files including protected files. (Yes, No)  Errors can occur if you use a memory card formatted by another brand of camera, a memory card reader, or a computer. Please format memory cards in the camera before using them to capture photos.
Reset	Reset the setup menu and shooting options to the factory defaults. (Date, time, language, and video output settings do not change.) (Yes, No)



Setting 2

Learn about the menu items of the Setting 2.

To set Setting 2 options,

In Shooting or Playback mode, press [MENU] →  → an option.

Item	Description
Quick View	Set the Quick View time length – the amount of time the camera displays a photo immediately after you captured it. (Off, 1 sec*, 3 sec, 5 sec, Hold)
Display Adjust	Adjust the display brightness, auto brightness setting, or display color. <ul style="list-style-type: none"> • Display Brightness: You can adjust the display brightness manually. • Auto Brightness: Turn auto brightness on or off. (Off, On*) • Display Color: You can adjust the display color manually.
Auto Display Off	Set the display off time. The display turns off if you do not use the camera for the time you set. (Off, 30 sec*, 1 min, 3 min, 5 min, 10 min)

* Default

* Default

Item	Description
Power Save	Set power shut off time. The camera shuts off if you do not use it for the time you set. (30 sec, 1 min*, 3 min, 5 min, 10 min, 30 min) <ul style="list-style-type: none"> • The camera retains the power-off time setting even if you replace the battery. • Power save may not work if the camera is connected to a computer, TV, or printer, playing a slide show or movie.
Date & Time	Set date, time, date format, time zone and whether to imprint the date on photos. (Time Zone, Date, Time, Type, Imprint) <ul style="list-style-type: none"> • The date appears on the lower right side of the photo. • When you print a photo, some printers may not print the date appropriately.
Help Guide Display	Set to display help text about menus and functions. (Off, On*) <p>Press [] to hide the help text.</p>

Setting 3



Learn about the menu items of the Setting 3.

To set Setting 3 options,

In Shooting or Playback mode, press [MENU] →  → an option.

Item	Description
Sound	<ul style="list-style-type: none"> • System Volume: Set the sound volume or turn all sound off entirely. (Off, Low, Medium*, High) • AF Sound: Set the sound the camera makes in AF mode on or off. (Off, On*) • Button Sound: Set the sound the camera makes when you press buttons on or off. (Off, On*)
Sensor Cleaning	<ul style="list-style-type: none"> • Sensor Cleaning: Remove dust from the sensor. • Start-Up Action: When on, the camera performs sensor cleaning each time you turn it on. (Off*, On) <div style="border: 1px solid #ccc; padding: 5px; margin-top: 10px;">  As this product uses interchangeable lenses, the sensor can get dust on it when you change lenses. This can lead to dust particles appearing in the photos you capture. It is recommended not to change lenses when you are in a particularly dusty area. Also, make sure to attach the lens cap to the lens when not using it. </div>
Video Out	<p>Set the video signal output appropriate for your country when connecting the camera to an external video device such as a monitor or TV.</p> <ul style="list-style-type: none"> • NTSC*: USA, Canada, Japan, Korea, Taiwan, Mexico, etc • PAL (Supports only PAL B, D, G, H, or I): Australia, Austria, Belgium, China, Denmark, Finland, France, Germany, England, Italy, Kuwait, Malaysia, New Zealand, Singapore, Spain, Sweden, Switzerland, Thailand, Norway, etc

* Default

Item	Description
Anynet+ (HDMI-CEC)	<p>When you connect the camera to an HDTV that supports Anynet+ (HDMI-CEC), you can control the play function of the camera with the TV remote control.</p> <ul style="list-style-type: none"> • Off: You cannot control the play function of camera with the TV remote control. • On*: You can control the play function of camera with the TV remote control.
HDMI Output	<p>When you connect the camera to an HDTV with an HDMI cable, you can change the resolution of the image.</p> <ul style="list-style-type: none"> • NTSC: Auto*, 1080i, 720p, 576p (activates only when PAL is selected), 480p <div style="border: 1px solid #ccc; padding: 5px; margin-top: 10px;">  If the connected HDTV does not support the resolution you select, the camera sets the resolution one level lower. </div>
Device Information	<p>View the firmware version of the body and the lens, Wi-Fi MAC address, and network certification number, or update the firmware.</p> <ul style="list-style-type: none"> • Firmware Update: Update the firmware of the camera body or lens. (Body Firmware, Lens Firmware) <div style="border: 1px solid #ccc; padding: 5px; margin-top: 10px;">  <ul style="list-style-type: none"> • You can download firmware upgrades from www.samsung.com. • You cannot run a firmware upgrade without a fully charged the battery. Recharge the battery fully before running a firmware upgrade. • If you update the firmware, user settings values will be reset. (Date, time, language, video out will not change.) • Do not turn the camera off while the update is in progress. </div>

* Default

GPS

Learn about the menu items of the GPS setting. You should purchase an optional GPS accessory in order to use the GPS function.

To set GPS options,

In Shooting or Playback mode, press **[MENU]** →  → an option.

* Default

Item	Description
Geotagging	Set to capture photos with location information using the Global Positioning System (GPS). Location information is added to the Exif data associated with the photo. (Off, On*)
GPS Valid Time Settings	Set the time to use the last location information when the camera fails to receive GPS signals. If the camera fails to receive GPS signals after the specified time, the location information will not be recorded onto the photos. (15 sec*, 30 sec, 1 min, 3 min, 10 min, 30 min)
Location Display	Set to display the location information on the top right screen of Shooting mode. The location information will appear in Korean only when you are in Korea and the display language is set to Korean. When another language is set, the location information will appear in English. (Off, On*)
GPS Reset	Set to search for GPS satellites closest to your current position. (Yes, No)



Chapter 6

Connecting to external devices

Make full use of the camera by connecting it to external devices such as a computer, HDTV or photo printer.

Viewing files on an HDTV or a 3D TV

Play back photos or videos by connecting your camera to an HDTV (3D TV) using an optional HDMI cable.

Viewing files on an HDTV

- 1 In Shooting or Playback mode, press **[MENU]** →  → **HDMI Output** → an option.
- 2 Turn off your camera and HDTV.
- 3 Connect the HDTV and the camera using the optional HDMI cable.

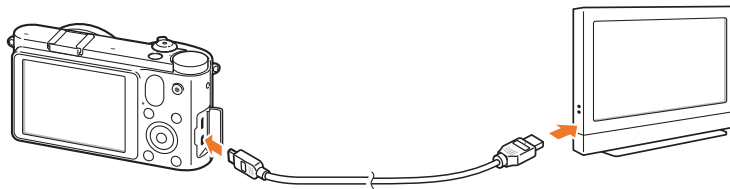

- 4 Make sure that the HDTV and camera are turned on, and then select the HDMI mode on the HDTV.
 - The HDTV screen mirrors the camera's display.
- 5 View the videos and photos using the buttons on the camera.







- When using the HDMI cable, you can connect the camera to an HDTV using the Anynet+(CEC) method.
- The Anynet+(CEC) functions allow you to control connected devices using the TV remote control.
- If the HDTV supports Anynet+(CEC), the TV turns on automatically when used in conjunction with the camera. This feature may not be available on some HDTVs.
- When connected to an HDTV by an HDMI cable, the camera cannot capture a photo or video.
- When connected to an HDTV, some of the camera's playback functions may not be available.
- The length of time after which the camera and an HDTV are connected may vary depending on the memory card that you are using.
- As the main feature of a memory card is to increase the transfer speed, it is not necessarily true to say that a memory card with a faster transfer speed is also fast in using the HDMI function.

Viewing files on a 3D TV

You can view photos captured in 3D mode or 3D Panorama mode on a 3D TV.

- 1 In Shooting or Playback mode, press [MENU] →  → **HDMI Output** → an option.
- 2 Turn off your camera and 3D TV.
- 3 Connect your camera to your 3D TV with the optional HDMI cable.
- 4 Turn on your camera.
 - If you have an Anynet+ compatible Samsung 3D TV and you have turned on your camera's Anynet+ function, the 3D TV turns on automatically and displays the camera screen, while the camera automatically enters Playback mode.
 - If you turn Anynet+ off in your camera, the 3D TV does not turn on automatically.

- 5 Press [ ] on the camera or the mode switching button on the TV to switch to **3D Mode**.
 - Press [ ] or the mode switching button again to switch to **2D Mode**.
- 6 Turn on your TV's 3D function.
 - Refer to your TV's user manual for more details.
- 7 View 3D photos with the buttons on your TV's remote control.



- You cannot view an MPO file in 3D effect on TVs that do not support the file format.
- Use proper 3D glasses when you view an MPO file on a 3D TV.



Do not view the 3D images captured by your camera on a 3D TV or 3D monitor for an extended period of time. It may cause unpleasant symptoms, such as eyestrain, fatigue, nausea, and more.

Printing photos

Print photos on your camera by connecting to printers directly or saving Digital Print Order Format (DPOF) information on a memory card.

Printing photos with a PictBridge photo printer

You can print photos with a PictBridge-compatible printer by connecting your camera directly to the printer.

- 1 With the printer on, connect your camera to the printer with the USB cable.

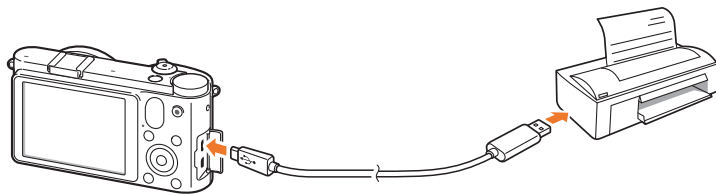

- 2 Turn on your camera.
 - When the pop-up message appears on the camera display, select **Printer**.
- 3 Press [/AF] to select a photo.
 - Press [**MENU**] to set printing options.
- 4 Press [] to print.

Configuring print settings

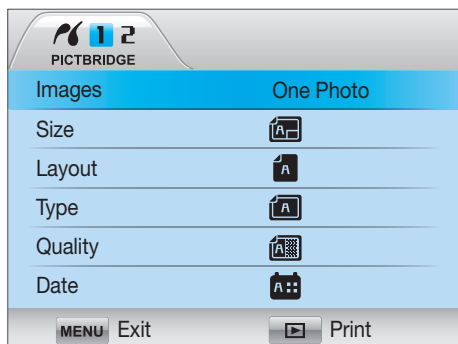

Option	Description
Images	Select whether to print the current photo or all photos.
Size	Specify the size of the print.
Layout	Set the number of photos per page.
Type	Select the type of paper.
Quality	Set the print quality.
Date	Set to print the date.
File Name	Set to print the file name.
Reset	Reset setting to their default values.



Some options may not be supported by some printers.

Creating a print order (DPOF)

DPOF (Digital Print Order Format) lets you set the print size of a photo and the number of copies to be printed. The camera saves the DPOF information in the MISC folder of your memory card. Your camera displays a DPOF indicator when it displays an image with DPOF information. If you have set DPOF information for your images, you can take the memory card to a digital printing shop for printing.

To set DPOF options,

In Playback mode, press **[MENU]** →  → **DPOF** → an item.

DPOF options

Option	Description
Standard	<p>You can select photos to print and the number of copies for photos.</p> <ul style="list-style-type: none"> • Select: Select the number of copies for photos you select. (Scroll to the photos you want to print → Select the number of copies by rotating the navigation button, and then pressing [Fn].) • All: Select the number of copies for all photos. (Select the number of copies by pressing [DISP/☒/☑], and then pressing [OK].) • Reset: Cancel all DPOF printing quantity selections.
Index	<p>This option lets you print all photos set to be printed as thumbnails in a single paper. The print size that you have set is available only with DPOF 1.1-compatible printers.</p>
Size	<p>You can specify the size of the print.</p> <ul style="list-style-type: none"> • Select: Select the print size for photos you choose. (Scroll to the photos you want to print → Select the print size by rotating the navigation button, and then pressing [Fn].) • All: Select the print size of all the photos saved in the memory card. (Select the print size by pressing [DISP/☒/☑], and then pressing [OK].) • Reset: Cancel the DPOF print size for all photos.



Transferring files to your computer

Transfer files on a memory card to your computer by connecting the camera to the PC.

Transferring files to your Windows computer

Connecting the camera as a removable disk

You can connect the camera to your computer as a removable disk.

- 1 Turn off the camera.
- 2 Connect the camera to your computer with the USB cable.

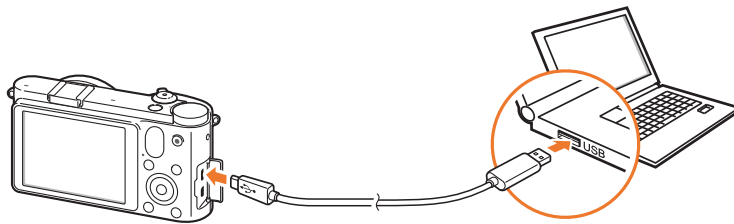

- You must plug the small end of the USB cable into your camera. If the cable is reversed, it may damage your files. The manufacturer is not responsible for any loss of data.
- If you try to plug the USB cable into the HDMI port, the camera may not work properly. If it occurs, restart the camera.

- 3 Turn on the camera.
 - When the pop-up message appears on the camera display, select **Computer**.
- 4 On your computer, select **My Computer** → **Removable Disk** → **DCIM** → **XXXPHOTO** or **XXX_MMDD**.
- 5 Select the files you want, and then drag or save them to your computer.



If the **Folder Type** is set to **Date**, the folder name appears as "XXX_MMDD". For example, if you capture a photo on January 1, the folder name will be "101_0101".

Disconnecting the camera (for Windows XP)

With Windows Vista and Windows 7, the methods for disconnecting the camera are similar.

- 1 Ensure that no data is being transferred between the camera and the computer.
 - If the status lamp on your camera is blinking, it means the data transfer is in progress. Please wait until the status lamp stops blinking.

- 2 Click  on the tool bar at the bottom right of your computer screen.



- 3 Click the pop-up message.
- 4 Click the message box indicating safely removed.
- 5 Remove the USB cable.

Transferring files to your Mac computer

- 1 Turn off the camera.
- 2 Connect your camera to a Macintosh computer with the USB cable.



Mac OS 10.4 or later is supported.



- You must plug the small end of the USB cable into your camera. If the cable is reversed, it may damage your files. The manufacturer is not responsible for any loss of data.
- If you try to plug the USB cable into the HDMI port, the camera may not work properly. If it occurs, restart the camera.

- 3 Turn on the camera.
 - When the pop-up message appears on the camera display, select **Computer**.
- 4 Open the removable disk.
- 5 Transfer photos or videos to the computer.

Using programs on a PC

Digital photos can be edited in a variety of ways through image editing programs. Learn to edit photos using the provided editing programs.

Installing software

- 1 Insert the CD-ROM into your PC.
- 2 When the setting wizard appears, click **Samsung Digital Camera Installer**.
- 3 Select a program you want to install, and then click **Install**.
- 4 Follow the on-screen instructions.
- 5 When the installation is complete, click **Exit**.

Programs contained on the CD

Program	Purpose
Intelli-studio	Edit photos and videos.
Samsung RAW Converter	Convert RAW files into the desired file format.
PC Auto Backup	Send the recorded files to a connected PC via Wi-Fi.



- If your computer does not meet the requirements, videos may not play correctly or it may take longer to edit videos.
- Install DirectX 9.0c or above before you use the program.
- You must use Windows XP/Vista/7 or Mac OS 10.4 or later to connect the camera as a removable disk.



Using a self-assembled PC or a PC and OS that are not supported may void your warranty.

Using Intelli-studio

Intelli-studio is a built-in program that allows you to play back and edit files. You can also upload files to your favorite websites. For details, select **Help** → **Help** in the program.

Requirements

Item	Requirements
OS*	Windows XP SP2, Windows Vista, or Windows 7 (32-bit editions)
CPU	Intel® Core 2 Duo 1.66 GHz or higher/ AMD Athlon™ X2 Dual-Core 2.2 GHz or higher
RAM	Minimum 512 MB RAM (1 GB or more recommended)
Hard disk capacity	250 MB or more (1 GB and above recommended)
Others	<ul style="list-style-type: none"> • CD-ROM drive • 1024x768 pixels, 16-bit color display compatible monitor (1280x1024 pixels, 32-bit color display recommended) • USB 2.0 port • nVIDIA Geforce 7600GT or higher/ ATI X1600 series or higher • Microsoft DirectX 9.0c or later

* A 32-bit version of Intelli-studio will be installed—even on 64-bit editions of Windows XP, Windows Vista and Windows 7.



- The requirements are recommendation only. It may not work properly even when the computer meets the requirements, depending on the condition of your computer.
- Intelli-studio is compatible only with Windows.
- Intelli-studio supports the following formats:
 - **Videos:** MP4 (Video: H.264, Audio: AAC), WMV (WMV 7/8/9), AVI (MJPEG)
 - **Photos:** JPG, GIF, BMP, PNG, TIFF
- You cannot open the RAW format files with the Intelli-studio program.
- You cannot edit files directly on the camera. Transfer files to a folder on your computer before editing.

Using the Intelli-studio Interface



No.	Description
8	View files of the selected folder on your computer.
9	Show or hide files of the connected camera.
10	View files of the selected folder on the camera.
11	View files as thumbnails or on a map.
12	Browse folders in the connected device.
13	Browse folders in your computer.
14	Move to the previous or next folder.
15	Print files, view files on a map, store files in My Folder, or register faces.

No.	Description
1	Open menus.
2	Display files in the selected folder.
3	Change to the Photo edit mode.
4	Change to the Video edit mode.
5	Change to the Sharing mode. (You can send files by email or upload files to websites, such as Flickr or YouTube.)
6	Enlarge or reduce the thumbnails in the list.
7	Select a file type.

Transferring files using Intelli-studio

You can easily transfer files on your camera to your computer by using Intelli-studio.

- 1 Turn off the camera.
- 2 Connect the camera to your computer with the USB cable.

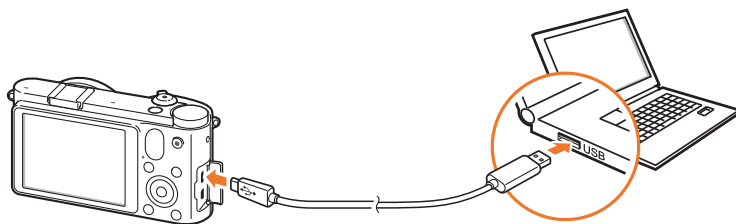

- You must plug the end of the cable with the correct connection plug into your camera. If the cable is reversed, it may damage your files. The manufacturer is not responsible for any loss of data.
- If you try to plug the USB cable into the HDMI port, the camera may not work properly. If it occurs, restart the camera.

- 3 Run Intelli-studio on your computer.
- 4 Turn on the camera.
 - When the pop-up message appears on the camera display, select **Computer**.
- 5 Select a folder on your computer to save new files and select **Yes**.
 - New files will be transferred to the computer.
 - If your camera has no new files, the pop-up window for saving new files will not appear.

Using Samsung RAW Converter

Photos captured by a camera are often transformed to JPEG formats and stored in the memory according to the settings of the camera at the time of shooting. RAW files are not transformed to JPEG formats and are stored in the memory without any changes. With Samsung RAW Converter, you can calibrate exposures, White Balances, tones, contrasts, and colors of photos.

Requirements for Windows

Item	Requirements
OS	Microsoft Windows XP, Windows Vista, or Windows 7 * Administrator rights are needed for installation. * The program runs as a 32-bit application under the 64-bit OS.
CPU	Intel Pentium®, AMD Athlon™ processor-based PC or compatible computer (Pentium4, Athlon XP, or later recommended) * Multi-core processor ready (Intel Core i7, Core 2 Quad, Core 2 Duo, AMD phenom IIX4, Phenom X4, etc.)
RAM	1 GB or more recommended
Hard disk capacity	Please reserve at least 100 MB of space. Please allocate sufficient disk space for image storage. (One image may use more than 10 MB of disk space.)
Others	<ul style="list-style-type: none"> XGA (1024x768), Full Color (24 bit or higher) Keyboard, mouse, or equivalent devices

Requirements for Mac

Item	Requirements
OS	Apple® Mac® OS X v10.4/v10.5/v10.6
CPU	Intel processor-based or compatible computer (Core 2 Quad or later recommended) / PowerPC
RAM	1 GB or more recommended
Hard disk capacity	Please reserve at least 100 MB of space. Please allocate sufficient disk space for image storage. (One image may use more than 10 MB of disk space.)
Others	<ul style="list-style-type: none"> XGA (1024x768), Full Color (24 bit or higher) Keyboard, mouse, or equivalent devices



- Samsung RAW Converter may not perform correctly on some computers, even when the computer meets the requirements.
- The Mac installation program will not autorun. Please manually run the setup file on the provided CD-ROM.

Using the Samsung RAW Converter Interface

For details about using Samsung RAW Converter, click **Help** → **Open software manual**.

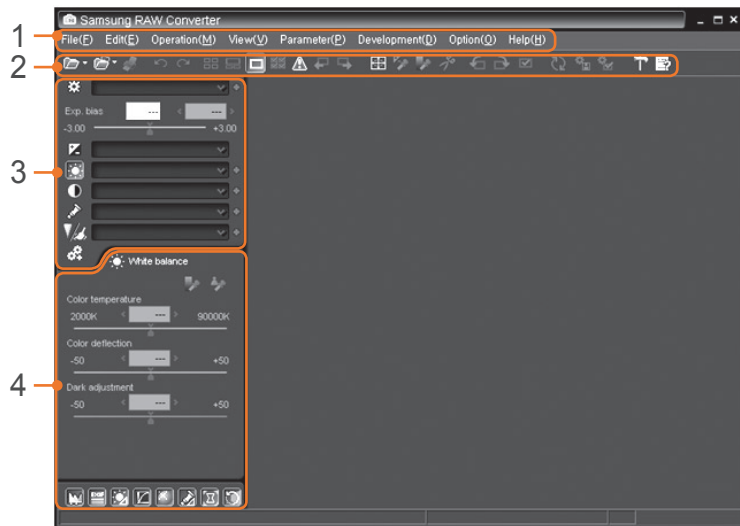

No.	Description
1	Menu
2	Toolbar
3	Editing tools
4	Open/Close the fine adjustment window for the editing tools.

Editing RAW format files

If you edit the RAW format files with the Samsung RAW Converter, you can maintain high image quality. You can also edit JPEG and TIFF format files.

To adjust the exposure of an image

- 1 Select **File** → **Open file** and open a file.
- 2 From the editing tools, select .

3 Adjust the exposure with the scroll bar.



Original image

P Mode, Aperture: f=8,

Shutter Speed: 1/15 sec, ISO=100



Edited image

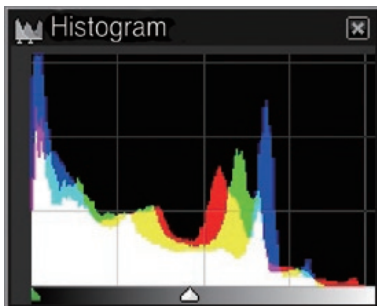

Original image

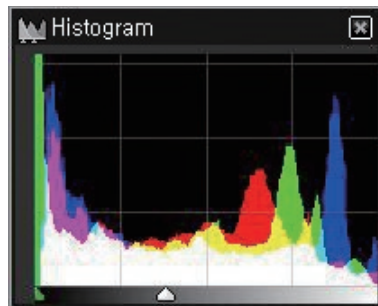

Edited image

To adjust the contrast of an image

- 1 Select **File** → **Open file** and open a file.
- 2 From the editing tools, select .
- 3 Adjust the tone with the scroll bar.

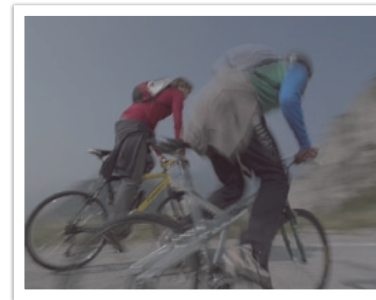

Original image



Edited image

To save RAW files in JPEG or TIFF formats

- 1 Select **File** → **Open file** and open a file.
- 2 Select **File** → **Development**.
- 3 Select a file format (JPEG or TIFF) and select **Save**.



Chapter 7

Appendix

Get information about error messages, camera maintenance, trouble shooting tips, specifications, and optional accessories.

Error messages

When the following error messages appear, try these remedies.

Error messages	Suggested remedies
Lens is locked	The lens is locked. Rotate the lens counter-clockwise until you hear a click. (p. 36)
Card Error	<ul style="list-style-type: none"> • Turn off your camera, and then turn it on again. • Remove your memory card and insert it again. • Format your memory card.
Low Battery	Insert a charged battery or recharge the battery.
No Image File	Capture photos or insert a memory card that contains photos.
File Error	Delete the damaged file or contact a service center.
Memory Full	Delete unnecessary files or insert a new memory card.
Card Locked	You can lock SD, SDHC or SDXC card to prevent files from being deleted. Unlock the card when shooting. (p. 153)

Error messages	Suggested remedies
Folder and file number are max values. Replace the card	File names do not match the DCF standard. Transfer the files on the memory card to your computer and format the card. (p. 129)
Error 00	Turn off your camera and remount the lens. If the message still appears, contact a service center.
Error 01/02	Turn off your camera, remove the battery, and insert again. If the message still appears, contact a service center.

Maintaining the camera

Cleaning the camera

Camera lens and display

Use a brush to remove dust and wipe the lens gently with a soft cloth. If any dust remains, apply lens cleaning liquid to a piece of cleaning paper and wipe gently.

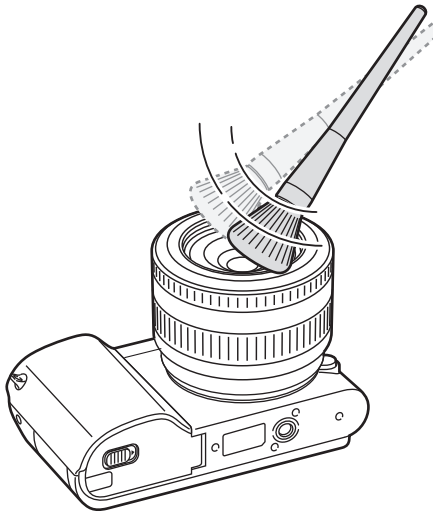

Image sensor

Depending on different shooting conditions, dust may appear in photos because the image sensor is exposed to the external environment. This problem is normal, and the exposure to dust occurs in everyday use of the camera. You can remove dust from the sensor by operating the sensor cleaning function. (p. 131) If dust remains after cleaning the sensor, contact a service center. Do not insert the blower into the mounting opening of the lens.

Camera body

Wipe gently with a soft, dry cloth.



Never use benzene, thinners or alcohol to clean the device. These solutions can damage the camera or cause it to malfunction.

Using or storing the camera

Inappropriate places to use or store the camera

- Avoid exposing the camera to very cold or very hot temperatures.
- Avoid using your camera in areas with extremely high humidity, or where the humidity changes drastically.
- Avoid exposing the camera to direct sunlight and storing it in hot, poorly-ventilated areas, such as in a car during summer time.
- Protect your camera and the display from impact, rough handling, and excessive vibration to avoid serious damage.
- Avoid using or storing your camera in dusty, dirty, humid, or poorly-ventilated areas to prevent damage to moving parts and internal components.
- Do not use your camera near fuels, combustibles, or flammable chemicals. Do not store or carry flammable liquids, gases, or explosive materials in the same compartment as the camera or its accessories.
- Do not store the camera where there are mothballs.

Using on beaches or shores

- Protect your camera from sand and dirt when you use it on beaches or in other similar areas.
- Your camera is not waterproof. Do not handle the battery, or memory card with wet hands. Operating the camera with wet hands may cause damage to your camera.

Storing for extended period of time

- When you store the camera for an extended period, place it in a sealed container with an absorbent material, such as silica gel.
- Remove the batteries from your camera when storing it for an extended period. Installed batteries may leak or corrode over time and cause serious damage to your camera.
- Over time, unused batteries will discharge and must be recharged before use.

Using the camera with caution in humid environments

When you transfer the camera from a cold environment to a warm one, condensation can form on the lens or internal components of the camera. In this situation, turn off the camera and wait for at least 1 hour. If condensation forms on the memory card, remove the memory card from the camera and wait until all moisture has evaporated before reinserting it.

Other cautions

- Do not swing your camera by the strap. This may cause injury to yourself or others or damage to your camera.
- Do not paint your camera, as paint can clog moving parts and prevent proper operation.
- Turn off the camera when not using it.
- Your camera consists of delicate parts. Avoid impacts to the camera.
- Protect the display from external force by keeping it in the case when not in use. Protect the camera from scratches by keeping it away from sand, sharp implements, or loose change.
- Do not use the camera if the screen is cracked or broken. Broken glass or acrylic could cause injury to your hands and face. Take the camera to a Samsung service center to have it repaired.
- Never place cameras, batteries, chargers, or accessories near, on, or in heating devices, such as microwave ovens, stoves, or radiators. These devices may be deformed and can overheat and cause a fire or explosion.
- Do not expose the lens to direct sunlight, as this may discolor the image sensor or cause it to malfunction.
- Protect your lens from fingerprints and scratches. Clean your lens with a soft, clean, debris-free lens cloth.
- The camera may turn off if impacted from the outside. This is to protect the memory card. Turn on the camera to use it again.
- While you use the camera, it may heat up. This is normal and should not affect your camera's lifespan or performance.
- When you use the camera in low temperatures, it may take some time to turn on, the color of the display may be changed temporarily, or after-images may appear. These conditions are not malfunctions and they will correct themselves when the camera is returned to normal temperatures.
- Paint or metal on the outside of the camera may cause allergies, itchy skin, eczema, or swelling for people with sensitive skin. If you experience any of these symptoms, stop using the camera immediately and consult a doctor.

About memory card

Supported memory card

This product supports SD (Secure Digital), SDHC (Secure Digital High Capacity), SDXC (Secure Digital eXtended Capacity), microSD, microSDHC, or microSDXC memory cards.

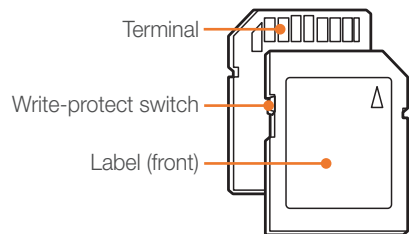

You can prevent files from being deleted by using the write-protect switch on an SD, SDHC or SDXC card. Slide the switch down to lock or slide it up to unlock. Unlock the card when capturing photos and videos.

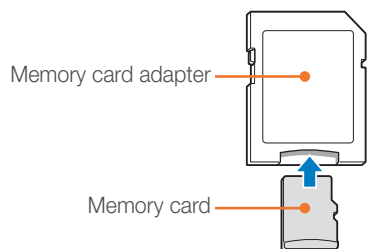

To use micro memory cards with this product, a PC, or a memory card reader, insert the card into an adapter.

Memory card capacity

The memory capacity may differ depending on shooting scenes or shooting conditions. These capacities are based on a 2 GB SD card.

	Size	Quality	
		HQ	Normal
Videos*	1080 30P 1920X1080 (30 FPS)	Approx. XX' XX"	Approx. XX' XX"
	810 24P 1920X810 (24 FPS)	Approx. XX' XX"	Approx. XX' XX"
	720 30P 1280X720 (30 FPS)	Approx. XX' XX"	Approx. XX' XX"
	480 30P 640X480 (30 FPS)	Approx. XX' XX"	Approx. XX' XX"
	240 WEB For Sharing (30 FPS)	Approx. XX' XX"	Approx. XX' XX"

* The recordable time may vary if you use the zoom. Several videos were recorded in succession to determine the total recording time.

	Size	Quality						
		Super Fine	Fine	Normal	RAW	RAW + S.Fine	RAW + Fine	RAW + Normal
Photo	20.0M (5472X3648)	XX	XX	XX	XX	XX	XX	XX
	10.1M (3888X2592)	XX	XX	XX	-	XX	XX	XX
	5.9M (2976X1984)	XX	XX	XX	-	XX	XX	XX
	2.0M (1728X1152)	XX	XX	XX	-	XX	XX	XX
	Burst	XX	XX	XX	-	-	-	-
	16.9M (5472X3080)	XX	XX	XX	-	XX	XX	XX
	7.8M (3712X2088)	XX	XX	XX	-	XX	XX	XX
	4.9M (2944X1656)	XX	XX	XX	-	XX	XX	XX
	2.1M (1920X1080)	XX	XX	XX	-	XX	XX	XX
	13.3M (3648X3648)	XX	XX	XX	-	XX	XX	XX
	7.0M (2640X2640)	XX	XX	XX	-	XX	XX	XX
	4.0M (2000X2000)	XX	XX	XX	-	XX	XX	XX
	1.1M (1024X1024)	XX	XX	XX	-	XX	XX	XX

Cautions when using memory cards

- Avoid memory cards to very cold or very hot temperatures (below 0 °C/32 °F or above 40 °C/104 °F). Extreme temperatures can cause memory cards to malfunction.
 - Insert a memory card in the correct direction. Inserting a memory card in the wrong direction may damage your camera and memory card.
 - Do not use memory cards that have been formatted by other cameras or by a computer. Reformat the memory card with your camera.
 - Turn off the camera when you insert or remove the memory card.
 - Do not remove the memory card or turn off your camera while the lamp is blinking, as this may damage your data.
 - When the lifespan of a memory card has expired, you cannot store any more photos on the card. Use a new memory card.
 - Do not bend, drop, or subject memory cards to heavy impact or pressure.
 - Avoid using or storing memory cards near strong magnetic fields.
 - Avoid using or keeping memory cards in areas with high temperature, high humidity, or corrosive substances.
- Prevent memory cards from making contact with liquids, dirt, or foreign substances. If dirty, wipe the memory card clean with a soft cloth before you insert the memory card in your camera.
 - Do not allow liquids, dirt, or foreign substances to come in contact with memory cards or the memory card slot. Doing so may cause memory cards or the camera to malfunction.
 - When you carry a memory card, use a case to protect the card from electrostatic discharges.
 - Transfer important data to other media, such as a hard disk, CD, or DVD.
 - When you use the camera for an extended period, the memory card may become warm. This is normal and does not indicate a malfunction.
 - Use a memory card that meets the standard requirements.



The manufacturer is not responsible for any loss of data.

About the battery

Use only Samsung-approved batteries.

Battery specifications

Item	Description
Model	BP1030
Type	Lithium-ion battery
Cell capacity	1,030 mAh
Voltage	7.4 V
Charging time (when the camera is switched off)	Approx. 140 min



Personal injury or death can occur if the battery is handled carelessly or improperly. For your safety, follow these instructions for proper battery handling:

- The battery can ignite or explode if not handled properly. If you notice any deformities, cracks, or other abnormalities in the battery, immediately discontinue use of the battery and contact your manufacturer.
- Use only authentic, manufacturer-recommended battery chargers and charge the battery only by the method described in this user manual.
- Do not place the battery near heating devices or expose to excessively warm environments, such as the inside of an enclosed car in the summertime.
- Do not place the battery in a microwave oven.
- Avoid storing or using the battery in hot, humid places, such as spas or shower enclosures.

- Do not rest the device on flammable surfaces, such as bedding, carpets, or electric blankets for a prolonged period.
- When the device is switched on, do not leave it in any confined space for a prolonged period.
- Do not allow battery terminals to come in contact with metallic objects, such as necklaces, coins, keys, or watches.
- Use only authentic, manufacturer-recommended, Lithium-ion replacement batteries.
- Do not disassemble the battery or puncture the battery with any sharp object.
- Avoid exposing the battery to high pressure or crushing forces.
- Avoid exposing the battery to major impacts, such as dropping it from high places.
- Do not expose the battery to temperatures of 60 °C (140 °F) or above.
- Do not allow the battery to come in contact with moisture or liquids.
- Battery shall not be exposed to excessive heat such as sunshine, fire or the like.

Disposal guidelines

- Dispose of the battery with care.
- Do not dispose of the battery in a fire.
- Disposal regulations may differ by country or region. Dispose of the battery in accordance with all local and federal regulations.

Guidelines for charging the battery

Charge the battery only by the method described in this user manual. The battery can ignite or explode if not charged properly.

Battery life

Shooting mode	Average time / Number of photos
Photos	Approx. 165 min/Approx. 330 photos
Videos	Approx. 140 min (Record videos at 1920X1080 resolution and 30 FPS.)

- The figures above are based on Samsung's test standards. Your results may differ depending on your actual usage.
- Available shooting time differs depending on background, shooting interval, and use conditions.
- Several videos were recorded in succession to determine the total recording time.

Low battery message

When the battery has fully discharged, the battery icon will turn red and the "Low Battery" message will appear.

Notes about using the battery

- In temperatures below 0 °C/32 °F, battery capacity and battery life may decrease.
- Battery capacity may decrease in low temperatures but will return to normal in milder temperatures.
- When you use the camera for an extended period, the area around the battery chamber may become warm. This does not affect the normal use of the camera.

Notes about charging the battery

- If the indicator light is off, make sure that the battery is inserted correctly.
- Do not pull on the power supply cord to disconnect the plug from the power outlet. This may cause a fire or electric shock.
- When the battery is completely discharged, charge it at least 10 minutes before using it with your camera.
- If the indicator light blinks orange or does not illuminate, reconnect the cable, or remove the battery and insert it again.
- If you charge the battery when the cable is overheated or the temperature is too high, the indicator light may turn orange. Charging will start when the battery cools down.
- Do not bend or place heavy objects on the AC cable. Doing so may damage the cable.

Before contacting a service center

If you are having trouble with your device, try these troubleshooting solutions before contacting a service professional.



When you leave your camera at a service center, be sure to also leave the other components that may have contributed to the malfunction, such as the memory card and battery.



Situation	Suggested remedies
Cannot turn on the camera	<ul style="list-style-type: none"> • Ensure that the battery is inserted. • Ensure that the battery is inserted correctly. • Charge the battery.
The power turns off suddenly	<ul style="list-style-type: none"> • Charge the battery. • Your camera may be in Power save mode or the display turns off automatically. (p. 130) • The camera may be turned off automatically to prevent the memory card from being damaged due to excessive heat. Turn on your camera again.
The camera is losing battery power quickly	<ul style="list-style-type: none"> • The battery may lose power more quickly in low temperatures (below 0 °C/32 °F). Keep the battery warm by putting it into your pocket. • Using the flash or recording videos depletes the battery quickly. Recharge if needed. • Batteries are consumable parts that must be replaced over time. Get a new battery if the battery life is diminishing quickly.

Situation	Suggested remedies
Cannot capture photos	<ul style="list-style-type: none"> • There is no space on the memory card. Delete unnecessary files or insert a new card. • When the AF Priority function is turned on, you cannot capture a photo unless the focus is set correctly. Set AF Priority to Off or focus on the subject correctly. (p. 125) • Format the memory card. • The memory card is defective. Get a new memory card. • The memory card is locked. Unlock the card. (p. 153) • Ensure that the camera is switched on. • Charge the battery. • Ensure that the battery is inserted correctly.
The camera freezes	Remove the battery and insert it again.
The camera heats up	While using the camera, it may heat up. This is normal and should not affect your camera's lifespan or performance.
The flash fires unexpectedly	The flash may fire due to static electricity. The camera is not malfunctioning.
The flash does not work	<ul style="list-style-type: none"> • The flash option may be set to Off. (p. 76) • You cannot use the flash in some modes.
The date and time are incorrect	Set the date and time under the  menu. (p. 130)

Situation	Suggested remedies
The display or buttons do not work	Remove the battery and insert it again.
The memory card has an error	<ul style="list-style-type: none"> • Turn off your camera, and then turn it on again. • Remove your memory card, and then insert it again. • Format your memory card. See "Cautions when using memory cards" for more details. (p. 155)
Your TV or computer cannot display photos and videos that are stored on an SDXC memory card.	SDXC memory cards use the exFAT file system. Ensure that the external device is compatible with the exFAT file system before connecting the camera to the device.
Your computer does not recognize an SDXC memory card.	SDXC memory cards use the exFAT file system. To use SDXC memory cards on a Windows XP computer, download and update the exFAT file system driver from the Microsoft website.
Cannot display files	If you change the name of a file, your camera may not play the file (the name of the file should meet the DCF standard). If you encounter this situation, display files on your computer.

Situation	Suggested remedies
The photo is blurry	<ul style="list-style-type: none"> • Ensure that the focus option you set is suitable for the kind of shot you are capturing. • Use a tripod to prevent your camera from shaking. • Ensure that the lens is clean. If not, clean the lens. (p. 150)
The colors in the photo do not match the actual scene	An incorrect White Balance can create unrealistic color. Select the proper White Balance option to suit the light source. (p. 61)
The photo is too bright	Your photo is overexposed. <ul style="list-style-type: none"> • Adjust the aperture value or the shutter speed. • Adjust the ISO sensitivity. (p. 60) • Turn off the flash. (p. 76) • Adjust the exposure value. (p. 85)
The photo is too dark	Your photo is underexposed. <ul style="list-style-type: none"> • Adjust the aperture value or the shutter speed. • Adjust the ISO sensitivity. (p. 60) • Turn on the flash. (p. 76) • Adjust the exposure value. (p. 85)

Situation	Suggested remedies
Photos are distorted	This camera can have minute distortion when using a wide-angle lens that enables shooting with a wide angle of view. This is normal, and does not cause malfunction.
Playback screen does not appear on the connected external device	<ul style="list-style-type: none"> • Ensure that HDMI cable is properly connected to the external monitor. • Ensure that the memory card is properly recorded.
Your computer does not recognize your camera	<ul style="list-style-type: none"> • Ensure that the USB cable is connected correctly. • Ensure that your camera is switched on. • Ensure that you are using a supported operating system.
Your computer disconnects the camera while transferring files	The file transfer may be interrupted by static electricity. Disconnect the USB cable and connect it again.
Your computer cannot play videos	Depending on the software you use, video files may not play. To play video files captured with your camera, install and use the Intelli-studio program on your computer. (p. 141)
Intelli-studio is not functioning properly	<ul style="list-style-type: none"> • End Intelli-studio and restart the program. • You cannot use Intelli-studio on Macintosh computers.

Situation	Suggested remedies
Cannot set the DPOF for RAW files	You cannot set the DPOF for RAW files.
Auto Focus does not work	<ul style="list-style-type: none"> • Subject is not in focus. When the subject is outside the AF area, shoot by moving the subject inside the AF area and half pressing [Shutter]. • Subject is too close. Step back from the subject and shoot. • The focus mode is set to MF. Switch the mode to AF.
AEL feature does not work	AEL feature does not work in SMART , M ,  ,  and SCN modes. Select another mode to use this feature.
Lens does not work	<ul style="list-style-type: none"> • Ensure that the lens is properly mounted. • Remove the lens from the camera and re-mount it.
External flash or GPS does not work	Ensure that the external device is properly mounted and turned on.
The date & time settings screen appears when you power on the camera	<ul style="list-style-type: none"> • Set the date and time again. • This screen appears when the camera's internal power source is completely discharged. Insert a fully charged battery and wait at least 72 hours in power off status for the internal power source to be recharged.

Camera specifications

Image Sensor	
Type	CMOS
Sensor size	23.5 X 15.7 mm
Effective pixels	Approx. 20.3 mega-pixels
Total pixels	Approx. 21.6 mega-pixels
Color filter	RGB primary color filter
Lens Mount	
Type	Samsung NX Mount
Available lens	Samsung lenses
Image Stabilization	
Type	Lens shift (depends on lens)
Mode	Mode 1/Mode 2/Off
Distortion Correct	
Lens Distortion Correct on/off (depends on lens)	
i-Function	
<i>i</i> effect (depends on lens), <i>i</i> zoom (X1.2, 1.4, 1.7, 2.0)	
Dust Reduction	
Type	Super sonic drive

Display	
Type	TFT LCD
Size	3.0" (Approx. 7.6 cm)
Resolution	VGA (640X480) Approx. 921 k dots
Field of view	Approx. 100 %
User display	Grid Line, Icons, Histogram, Distance Scale, Level gauge
Focusing	
Type	Contrast AF
Focusing point	<ul style="list-style-type: none"> • Selection: 1 point (free selection) • Multi: Normal 15 points, Close up 35 points • Face detection: Max. 10 faces
Mode	Single AF, Continuous AF, Manual Focus
AF Assist Lamp	Green LED
Shutter	
Type	Electronically controlled vertical-run focal plane shutter
Speed	<ul style="list-style-type: none"> • Auto: 1/4,000–30 sec. • Manual: 1/4,000–30 sec. (1/3 EV Step) • Bulb (time limit: 4 min.)

Exposure	
	TTL 221 (17 X 13) Block segment
Metering system	Metering: Multi, Center-weighted, Spot
	Metering range: EV 0–18 (ISO100 · 30 mm, F2)
Compensation	±3 EV (1/3 EV Step)
AE lock	Custom button
ISO equivalent	<ul style="list-style-type: none"> • 1 Step: Auto, ISO 100, ISO 200, ISO 400, ISO 800, ISO 1600, ISO 3200, ISO 6400, ISO 12800 • 1/3 Step: Auto, ISO 100, ISO 125, ISO 160, ISO 200, ISO 250, ISO 320, ISO 400, ISO 500, ISO 640, ISO 800, ISO 1000, ISO 1250, ISO 1600, ISO 2000, ISO 2500, ISO 3200, ISO 4000, ISO 5000, ISO 6400, ISO 8000, ISO 10000, ISO 12800
Drive Mode	
Mode	Single, Continuous, Burst (5M only), Timer, Bracket (Auto Exposure, White Balance, Picture Wizard)
Continuous shooting	<ul style="list-style-type: none"> • JPEG <ul style="list-style-type: none"> - High (8 fps): up to 11 shots possible - Low (3 fps): up to 15 shots possible • RAW <ul style="list-style-type: none"> - High (8 fps), Low (3 fps): up to 8 shots possible

Burst shooting	<ul style="list-style-type: none"> • 10, 15, or 30 frames per second • Up to 30 shots per shutter-press
Bracket shooting	Auto exposure bracketing (±3 EV), White Balance bracketing, Picture Wizard bracketing
Self-timer	2–30 sec. (1 second interval)
Shutter release	SR2NX02 (via Micro USB port) (optional)
Flash	
Type	External flash only (Bundle with SEF8A)
Mode	Smart Flash, Auto, Auto Red-eye, Fill in, Fill-in Red, 1st Curtain, 2nd Curtain, Off
Guide number	8 (based on ISO 100)
Angle of view	28 mm (35 mm film equivalent)
Sync speed	Less than 1/180 sec.
Flash EV	-2–+2 EV (0.5 EV Step)
External flash	Optional Samsung external flashes: SEF42A, SEF220A
Sync terminal	Hot-shoe
White Balance	
Mode	Auto WB, Daylight, Cloudy, Fluorescent White, Fluorescent NW, Fluorescent Daylight, Tungsten, Flash WB, Custom Set, Color Temperature (Manual)
Micro adjustment	Amber/Blue/Green/Magenta 7 steps respectively

Smart Range	
Smart Range On/Off	
Picture Wizard	
Mode	Standard, Vivid, Portrait, Landscape, Forest, Retro, Cool, Calm, Classic, Custom1, Custom2, Custom3
Parameter	Contrast, Sharpness, Saturation, Color
Shooting	
Mode	Smart Auto, Program, Aperture Priority, Shutter Priority, Manual, Lens Priority, Magic, Scene, Movie, Wi-Fi
Scene mode	Panorama (Live Panorama, 3D), Beauty Shot, Night, Landscape, Portrait, Children, Sports, Close Up, Text, Sunset, Dawn, Backlight, Fireworks, Beach & Snow, 3D
Smart Filter	Vignetting, Miniature, Fish Eye, Sketch, Defog, Halftone Dots, Soft Focus, Old Film 1, Old Film 2, Negative
Magic Frame	Old Album, Old Film, Wave, Full Moon, Old Record, Magazine, Newspaper, Sunny Day, Classic TV, Wall Art, Holiday, Billboard 1, Billboard 2
Selective Color	Red, Green, Blue, Yellow

Size	<ul style="list-style-type: none"> • JPEG (3:2): 20.0M (5472X3648)20.0M (5472X3648), 10.1M (3888X2592), 5.9M (2976X1984), 5.0M (2736X1824) (Burst mode only), 2.0M (1728X1152) • JPEG (16:9): 16.9M (5472X3080), 7.8M (3712X2088), 4.9M (2944X1656), 2.1M (1920X1080) • JPEG (1:1): 13.3M (3648X3648), 7.0M (2640X2640), 4.0M (2000X2000), 1.1M (1024X1024) • RAW: 20.0M (5472X3648)
Quality	Super Fine, Fine, Normal
RAW standard	SRW
Color space	sRGB, Adobe RGB
Video	
Type	MP4 (H.264)
Format	Movie: H.264, Sound: AAC
Movie AE mode	Program, Aperture Priority, Shutter Priority, Manual

Movie clip	Audio on/off (Shooting time: up to 25 min)
Smart Filter	Vignetting, Miniature, Fish Eye, Sketch, Defog, Halftone Dots, Soft Focus, Old Film 1, Old Film 2, Negative
Size	1920X1080, 1920X810, 1280X720, 640X480, 320X240 (For Sharing)
Frame rate	30 or 24 frames per second (24 fps is available only with 1920X810.)
Multi Motion	x0.25 (640X480, 320X240 only), x0.5 (1280X720, 640X480, 320X240 only), x1, x5, x10, x20
Quality	HQ, Normal
Sound	Stereo
Edit	Still image capture, Time trimming
Playback	
Type	Single image, Thumbnails (3/15/40), Slide show, Movie
Edit	Smart Filter, Red-eye Fix, Backlight, Resize, Rotate, Face Retouch, Brightness, Contrast, Vignetting

Smart filter	Miniature, Soft Focus, Old Film 1, Old Film 2, Halftone Dots, Sketch, Fish Eye, Defog, Negative
Smart filter size	<ul style="list-style-type: none"> • JPEG (3:2): 5.9M (2976X1984), 5.0M (2736X1824), 2.0M (1728X1152) • JPEG (16:9): 6.2M (3328X1872), 4.9M (2944X1656), 2.1M (1920X1080) • JPEG (1:1): 6.0M (2448X2448), 4.0M (2000X2000), 1.1M (1024X1024)
Storage	
Media	External memory (optional): SD card (up to 1–2 GB guaranteed), SDHC card (up to 32 GB guaranteed), SDXC card (up to 128 GB guaranteed)
File format	RAW (SRW), JPEG (EXIF 2.21), DCF, DPOF 1.1, PictBridge 1.0
Direct Printing	
PictBridge	
GPS	
Type	Geo-tagging with optional GPS Module (WGS 84)
Feature	<ul style="list-style-type: none"> • Location name (English and Korean only) • Google Map link (with Intelli-studio)

Wireless network	
Type	IEEE 802.11n supported
Function	Social Sharing, Email, MobileLink, Remote Viewfinder, SkyDrive, Auto Backup, TV Link, Wi-Fi Direct
Interface	
Digital output	USB 2.0 (HI-SPEED) (micro USB jack)
Video output	NTSC, PAL (selectable) HDMI 1.4a: (1080i, 720p, 576p/480p)
External release	Included (micro USB)
External microphone	Included
Power Source	
Type	<ul style="list-style-type: none"> • Rechargeable battery: BP1030 (1,030 mAh) • Charger: BC1030 * The power source may differ depending on your region.

Dimensions (W X H X D)
114 X 62.5 X 37.5 mm (without protrusions)
Weight
222 g (without battery and memory card)
Operating Temperature
0–40 °C
Operating Humidity
5–85 %
Software
Intelli-studio, Samsung RAW Converter, PC Auto Backup

* This specifications can change without notice to upgrade a performance.
 * Other brands and products names are trademarks of respective owners.

Glossary

AP (Access Point)

An access point is a device that allows wireless devices to connect to a wired network.

Ad-Hoc network

An ad-hoc network is a temporary connection for sharing files or an internet connection and between computers and devices.

AdobeRGB

Adobe RGB is used for commercial printing and has a larger color range than sRGB. Its wider range of colors helps you to easily edit photos on a computer.

AEB (Auto Exposure Bracket)

This feature automatically captures several images at different exposures to help you capture a properly-exposed image.

AEL (Auto Exposure Lock)

This feature helps you lock the exposure on which you want to calculate the exposure.

AF (Auto Focus)

A system that automatically focuses the camera lens on the subject. Your camera uses the contrast to focus automatically.

AMOLED (Active-matrix organic light-emitting diode) / LCD (Liquid Crystal Display)

AMOLED is a visual display that is very thin and light, as it does not need backlighting. LCD is a visual display commonly used in consumer electronics. This display needs a separate backlight, such as CCFL or LED, to reproduce colors.

Aperture

The aperture controls the amount of light that reaches the camera's sensor.

Camera shake (Blur)

If the camera is moved while the shutter is open, the entire image may appear blurred. This occurs more often when the shutter speed is slow. Prevent camera shake by raising the sensitivity, using the flash, or using a faster shutter speed. Alternatively, use a tripod or the OIS function to stabilize the camera.

Cloud Computing

Cloud computing is a technology that allows you to store data on remote servers and to use them from a device with internet access.

Color space

The range of colors that the camera can see.

Color temperature

Color Temperature is a measurement in degrees Kelvin (K) that indicates the hue of a specific type of light source. As the color temperature increases, the color of the light source has a more bluish quality. As the color temperature decreases, the color of the light source has a more reddish quality. At 5,500 degrees Kelvin, the color of the light source is similar to the sun at midday.

Composition

Composition in photography means arranging objects in a photo. Usually, abiding by the rule of thirds leads to a good composition.

DCF (Design rule for Camera File system)

A specification to define a file format and file system for digital cameras created by the Japan Electronics and Information Technology Industries Association (JEITA).

Depth of field

The distance between the nearest and farthest points that can be acceptably focused in a photograph. Depth of field varies with lens aperture, focal length, and distance from the camera to the subject. Selecting a smaller aperture, for example, will increase the depth of field and blur the background of a composition.

DPOF (Digital Print Order Format)

A format for writing printing information, such as selected images and number of prints, on a memory card. DPOF-compatible printers, sometimes available at photo shops, can read the information from the card for convenient printing.

EV (Exposure Value)

All the combinations of the camera's shutter speed and lens aperture that result in the same exposure.

EV Compensation

This feature allows you to quickly adjust the exposure value measured by the camera, in limited increments, to improve the exposure of your photos.

Exif (Exchangeable Image File Format)

A specification to define an image file format for digital cameras created by the Japan Electronic Industries Development Association (JEIDA).

Exposure

The amount of light allowed to reach the camera's sensor. Exposure is controlled by a combination of the shutter speed, the aperture value, and ISO sensitivity.

Flash

A speed light that helps to create adequate exposure in low-light conditions.

Focal length

The distance from the middle of the lens to its focal point(in millimeters). Longer focal lengths result in narrower angles of view and the subject is magnified. Shorter focal lengths result in wider angles of view.

Histogram

A graphical representation of the brightness of an image. The horizontal axis represents the brightness and the vertical axis represents the number of pixels. High points at the left (too dark) and right (too bright) on the histogram indicate a photo that is improperly exposed.

H.264/MPEG-4

A high-compression video format established by international standard organizations ISO-IEC and ITU-T. This codec is capable of providing good video quality at low bit rates developed by the Joint Video Team (JVT).

Image sensor

The physical part of a digital camera that contains a photosite for each pixel in the image. Each photosite records the brightness of the light that strikes it during an exposure. Common sensor types are CCD (Charge-coupled Device) and CMOS (Complementary Metal Oxide Semiconductor).

IP (Internet protocol) address

An IP address is a unique number that is assigned to every device that is connected to the internet.

ISO sensitivity

The sensitivity of the camera to light, based on the equivalent film speed used in a film camera. At higher ISO sensitivity settings, the camera uses a higher shutter speed, which can reduce blur caused by camera shake and low light. However, images with high sensitivity are more susceptible to noise.

JPEG (Joint Photographic Experts Group)

A lossy method of compression for digital images. JPEG images are compressed to reduce their overall file size with minimal deterioration of the image resolution.

Metering

The metering refers to the way in which the camera measures the quantity of light to set the exposure.

MF (Manual Focus)

A system that manually focuses the camera lens on the subject. You can use the focus ring to focus on a subject.

MJPEG (Motion JPEG)

A video format which is compressed as a JPEG image.

MPO (Multi Picture Object)

An image file format that contains multiple images in a file. An MPO file provides a 3D effect on MPO-compatible displays, such as 3D TVs or 3D monitors.

Noise

Misinterpreted pixels in a digital image that may appear as misplaced or random, bright pixels. Noise usually occurs when photos are shot with a high sensitivity or when a sensitivity is automatically set in a dark place.

NTSC (National Television System Committee)

A video color encoding standard used most commonly in Japan, North America, the Philippines, South America, South Korea, and Taiwan.

Optical zoom

This is a general zoom which can enlarge images with a lens and does not deteriorate quality of images.

PAL (Phase Alternate Line)

A video color encoding standard used in numerous countries throughout Africa, Asia, Europe, and the Middle East.

Quality

An expression of the rate of compression used in a digital image. Higher quality images have a lower rate of compression, which usually results in a larger file size.

RAW (Sensor raw data)

The original, unprocessed data, collected directly from the camera's image sensor. White Balance, contrast, saturation, sharpness, and other data can be manipulated with editing software before the image is compressed into a standard file format.

Resolution

The number of pixels present in a digital image. High resolution images contain more pixels and typically show more detail than low resolution images.

Shutter speed

Shutter speed refers to the amount of time it takes to open and close the shutter, and it is an important factor in the brightness of a photo, as it controls the amount of light which passes through the aperture before it reaches the image sensor. A fast shutter speed allows less time to let light in and the photo becomes darker and more easily freezes subjects in motion.

sRGB (Standard RGB)

International standard of colour space established by the IEC (International Electrotechnical Commission). This is defined from colour space for PC monitors and is also used as the standard colour space for Exif.

Vignetting

A reduction of an image's brightness or saturation at the periphery (outer edges) compared to the center of the image. Vignetting can draw interest to subjects positioned in the center of an image.

White Balance (Color balance)

An adjustment of the intensities of colors (typically the primary colors red, green, and blue), in an image. The goal of adjusting the White Balance, or color balance, is to correctly render the colors in an image.

Wi-Fi

Wi-Fi is a technology that allows electronic devices to exchange data wirelessly over a network.

WPS (Wi-Fi Protected Setup)

WPS is a technology that secures wireless home networks.

Optional accessories

Lens



SAMSUNG 18-55 mm
F3.5-5.6 OIS III



SAMSUNG 20-50 mm
F3.5-5.6 ED II

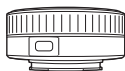

SAMSUNG 16 mm F2.4

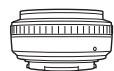

SAMSUNG 20 mm F2.8

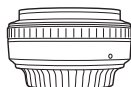

SAMSUNG 30 mm F2

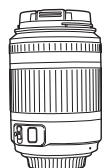

SAMSUNG 50-200 mm
F4-5.6 ED OIS II



SAMSUNG 60 mm F2.8
Macro ED OIS SSA

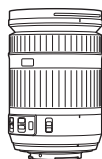

SAMSUNG 18-200 mm
F3.5-6.3 ED OIS

Lens

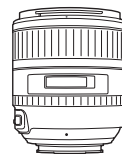

SAMSUNG 85 mm F1.4 ED SSA

External flash

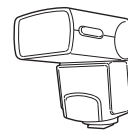

SEF42A

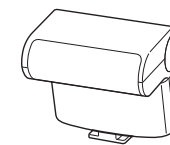





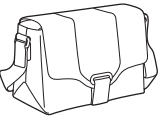

SEF220A

GPS

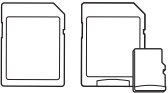
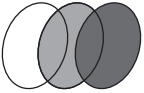
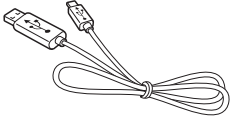
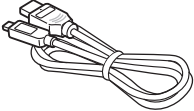

GPS10

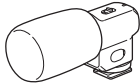
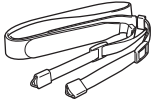
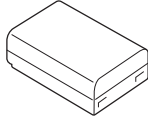
Other accessories	
	<p>Camera bag You can purchase the camera bag separately.</p>
	<p>Camera case You can purchase the camera case separately.</p>
	<p>Memory card This product supports SD (Secure Digital), SDHC (Secure Digital High Capacity), SDXC (Secure Digital eXtended Capacity), microSD, microSDHC, or microSDXC memory cards.</p>
	<p>Filter You can create different colored effects by attaching filters to your lens.</p>
	<p>USB cable You can purchase additional USB cables.</p>
	<p>HDMI cable You can view high-definition photos and videos by connecting the camera to an HDMI-compatible monitor with the HDMI (HDMI type D) cable.</p>

Other accessories	
	<p>Shutter release (micro USB type) Shutter release reduces shakiness when used with a tripod.</p>
	<p>Zoom microphone Zoom microphone picks up the subject's sound more clearly when you record a video with the zoom function.</p>
	<p>Strap You can additionally purchase the straps.</p>
	<p>Battery pack You can purchase additional battery packs.</p>
	<p>Quick battery charger You can purchase an optional quick battery charger.</p>



- These illustrations may differ from your actual items. Refer to the user manuals of these optional accessories for details.
- Use only Samsung-approved accessories. Samsung is not responsible for damage caused by using another manufacturer's accessories.

Index

A

- Aperture 14, 18
- Auto Backup 116
- Auto focus 65

B

- Battery
 - Life 157
 - Specifications 156
- Bracketing 72, 74

C

- Camera
 - Connecting as removable disk 139
 - Connecting to PC 139
 - Disconnecting (Windows) 140
 - Layout 28
- Color space 84
- Custom button 127

D

- Depth of Field (DOF) 15, 20
- Digital Print Order Format (DPOF) 137
- Drive (see Shooting method) 72

E

- E-mail 111
- Exposure Value (EV) 15, 85

F

- Fader 88
- Files
 - Deleting 92
 - Editing RAW format 146
 - Photo format 59
 - Protecting 92
 - Transferring to Mac 140
 - Transferring to PC 139
 - Video format 59

Flash

- Bounce photography 25
- Flash options 76
- Guide number 24
- Intensity 77
- F-number 15
- Focal length 19

G

- Glossary 166

I

- i-Function 48
- Intelli-Studio 142
- ISO sensitivity 17, 18, 60
- i-Zoom 49

L

- Lenses
 - Locking 36
 - Markings 37
 - Unlocking 36

M

- Maintenance 150
- Memory card 153
- Metering 79
- MF assist 70

O

- Optical Image Stabilization (OIS) 71
- Optional accessories
 - Attach the GPS module 41
 - Flash layout 38
 - GPS module layout 41

P

Photos

- Adjusting tone 147
- Editing 98
- Enlarging 94
- Shooting options 57
- Viewing on 3D TV 135
- Viewing on camera 90
- Viewing on HDTV 134

Photo styles 64

PictBridge 136

Picture Wizard 64

Posture 13

R

Red-eye effect 77

Remote Viewfinder 107

Rule of thirds 22

S

Samsung RAW Converter 145

Shooting method 72

Shooting modes

- Aperture Priority 45
- Lens Priority 47
- Manual 46
- Movie 54
- Program 44
- Scene 51
- Shutter Priority 45
- Smart Auto 43

Shutter speed 16, 18

Slide show 94

Smart Album 91

Smart Range 82

T

Timer 73

TV Link 118

V

Videos

- Options 87
- Viewing 96

W

Wireless network 101

3

3D Shot 53



**Correct Disposal of This Product
(Waste Electrical & Electronic Equipment)**

(Applicable in the European Union and other European countries with separate collection systems)

This marking on the product, accessories or literature indicates that the product and its electronic accessories (e.g. charger, headset, USB cable) should not be disposed of with other household waste at the end of their working life. To prevent possible harm to the environment or human health from uncontrolled waste disposal, please separate these items from other types of waste and recycle them responsibly to promote the sustainable reuse of material resources. Household users should contact either the retailer where they purchased this product, or their local government office, for details of where and how they can take these items for environmentally safe recycling. Business users should contact their supplier and check the terms and conditions of the purchase contract. This product and its electronic accessories should not be mixed with other commercial wastes for disposal.



Correct disposal of batteries in this product

(Applicable in the European Union and other European countries with separate battery return systems)

This marking on the battery, manual or packaging indicates that the batteries in this product should not be disposed of with other household waste at the end of their working life. Where marked, the chemical symbols Hg, Cd or Pb indicate that the battery contains mercury, cadmium or lead above the reference levels in EC Directive 2006/66. If batteries are not properly disposed of, these substances can cause harm to human health or the environment.

To protect natural resources and to promote material reuse, please separate batteries from other types of waste and recycle them through your local, free battery return system.

This Class [B] digital apparatus complies with Canadian ICES-003.

Dispose unwanted electronics through an approved recycler.
To find the nearest recycling location, go to our website:
www.samsung.com/recyclingdirect Or call, (877) 278 - 0799

FCC notice

Caution:

Any changes or modifications in construction of this device which are not expressly approved by the party responsible for compliance could void the user's authority to operate the equipment.

NOTE:

This equipment has been tested and found to comply with the limits for a Class B digital device, pursuant to part 15 of the FCC Rules. These limits are designed to provide reasonable protection against harmful interference in a residential installation. This equipment generates, uses and can radiate radio frequency energy and, if not installed and used in accordance with the instructions, may cause harmful interference to radio communications. However, there is no guarantee that interference will not occur in a particular installation. If this equipment does cause harmful interference to radio or television reception, which can be determined by turning the equipment off and on, the user is encouraged to try to correct the interference by one or more of the following measures:

- Reorientate, or relocate, the receiving antenna.
- Increase the distance between the equipment and receiver.
- Connect the equipment into an outlet on a circuit different from that to which the receiver is connected.
- Consult the dealer or an experienced radio/TV technician for help.

Declaration of Conformity

Trade Name : Samsung Electronics America, Inc.

Model No. : Samsung NX1000

Responsible Party : Samsung Electronics America, Inc.

Address : 85 Challenger Road, Ridgefield Park, NJ 07660

Telephone No. : 1-800-SAMSUNG (726-7864)

This device complies with Part 15 of the FCC Rules.

Operation is subject to the following two conditions:

(1) This device may not cause harmful interference, and (2) this device must accept any interference received, including interference that may cause undesired operation.



FCC ID: A3LNX1000

This device complies with part 15 of the FCC Rules. Operation is subject to the following two conditions: (1) This device may not cause harmful interference, and (2) this device must accept any interference received, including interference that may cause undesired operation.

CAUTION

RISK OF EXPLOSION IF BATTERY IS REPLACED BY
AN INCORRECT TYPE.
DISPOSE OF USED BATTERIES ACCORDING
TO THE INSTRUCTIONS

Operation is subject to the following two conditions:

- (1) This device may not cause harmful interference, and
- (2) This device must accept any interference received, including interference that may cause undesired operation.

Caution:

Any changes or modifications to the equipment not expressly approved by the party responsible for compliance could void user's authority to operate the equipment.

IC: 649E-NX1000

This equipment may be operated in all EU countries.
In France, this equipment may only be used indoors.

Le présent appareil est conforme aux CNR d'Industrie Canada applicables aux appareils radio exempts de licence. L'exploitation est autorisée aux deux conditions suivantes : (1) l'appareil ne doit pas produire de brouillage, et (2) l'utilisateur de l'appareil doit accepter tout brouillage radioélectrique subi, même si le brouillage est susceptible d'en compromettre le fonctionnement.

Complies with
IDA Standards
DA100790

Approved by PTA,
year 2011



NO-L-14041/01/2011/ETA/2011
1577/2011/WRLO



Declaration of Conformity

Product details

For the following

Product : DIGITAL CAMERA

Model(s) : NX1000

Declaration & Applicable standards

We hereby declare that the product(s) above is(are) in compliance with the essential requirements and other provisions of the R&TTE Directive (1999/5/EC), the Low Voltage Directive (2006/95/EC) and the Electromagnetic Compatibility Directive (2004/108/EC) by application of:

- | | |
|-------------------------|-------------------------------------|
| EN 60950-1:2006+A1:2010 | EN 55024:1998+A1:2001+A2:2003 |
| EN 55022:2006+A1 :2007 | EN 61000-3-2:2006 +A1:2009 +A2:2009 |
| EN 61000-3-3:2008 | EN 300 328 v1.7.1 |
| EN 301 489-1 v1.8.1 | EN 301 489-17 V2.1.1 |
| EN62311 :2008 | |

and the Eco-Design Directive (2009/125/EC) implemented by Regulations (EC) No 278/2009 for external power supplies.

Representative in the EU

Samsung Electronics Euro QA Lab.
Blackbushe Business Park
Saxony Way, Yateley, Hampshire
GU46 6GG, UK

(YEAR TO BEGIN AFFIXING CE MARKING 2012)

5 April, 2012

Joong-Hoon Choi / Lab. Manager

(Place and date of issue)

(Name and signature of authorized person)

* This is not the address of Samsung Service Centre. For the address or the phone number of Samsung Service Centre, see the warranty card or contact the retailer where you purchased your product.

Declaration sentence in official languages

Nation	Declaration
Cesky	Samsung Electronics tímto prohlašuje, že tento digitální fotoaparát je ve shodě se základními požadavky a dalšími příslušnými ustanoveními směrnice 1999/5/ES.
Dansk	Samsung Electronics erklærer herved, at digitale kameraer overholder de væsentlige krav og øvrige relevante krav i direktiv 1999/5/EF.
Deutsch	Hiermit erklärt Samsung Electronic, dass sich die Digitalkamera in Übereinstimmung mit den grundlegenden Anforderungen und den übrigen einschlägigen Bestimmungen der Richtlinie 1999/5/EG befindet.
Eesti	Käesolevaga kinnitab Samsung Electronics digitaalkamera vastavust direktiivi 1999/5/EÜ põhinõuetele ja nimetatud direktiivist tulenevatele teistele asjakohastele sätetele.
English	Hereby, Samsung Electronics declares that this digital camera is in compliance with the essential requirements and other relevant provisions of Directive 1999/5/EC.
Español	Por medio de la presente Samsung Electronics declara que la cámara digital cumple con los requisitos esenciales y cualesquiera otras disposiciones aplicables o exigibles de la Directiva 1999/5/CE.
Ελληνική	ΜΕ ΤΗΝ ΠΑΡΟΥΣΑ η Samsung Electronics ΔΗΛΩΝΕΙ ΟΤΙ η ψηφιακή φωτογραφική μηχανή ΣΥΜΜΟΡΦΩΝΕΤΑΙ ΠΡΟΣ ΤΙΣ ΟΥΣΙΩΔΕΙΣ ΑΠΑΙΤΗΣΕΙΣ ΚΑΙ ΤΙΣ ΛΟΙΠΕΣ ΣΧΕΤΙΚΕΣ ΔΙΑΤΑΞΕΙΣ ΤΗΣ ΟΔΗΓΙΑΣ 1999/5/EK.
Français	Par la présente Samsung Electronic déclare que l'appareil photo numérique est conforme aux exigences essentielles et aux autres dispositions pertinentes de la directive 1999/5/CE.
Italiano	Con la presente Samsung Electronicsdichiara che questa fotocamera digitale è conforme ai requisiti essenziali e alle altre disposizioni stabilite dalla Direttiva 1999/5/CE.
Latviski	Ar šo Samsung Electronics deklarē, ka digitālā kamera atbilst Direktīvas 1999/5/EK būtiskajām prasībām un citiem ar to saistītajiem noteikumiem.
Lietuvių	Šiuo Samsung Electronics deklaruoja, kad šis skaitmeninis fotoaparatas, atitinka esminius reikalavimus ir kitas 1999/5/EB Direktyvos nuostatas.
Nederlands	Hierbij verklaart Samsung Electronics dat de digitale camera in overeenstemming is met de essentiële eisen en de andere relevante bepalingen van richtlijn 1999/5/EG.
Malti	Hawnhekk, Samsung Electronics, tididikjara li din il-kamera digitali hi konformi mar-rekwiżiti essenzjali u ma' dispożizzjonijiet rilevanti oħrajn ta' Direttiva 1999/5/KE.

Nation	Declaration
Magyar	A Samsung Electronics kijelenti, hogy ez a digitális fényképezőgép megfelel az 1999/5/EK irányelv alapvető követelményeinek és egyéb vonatkozó előírásainak.
Polski	Niniejszym firma Samsung Electronics oświadcza, że ten aparat cyfrowy jest zgodny z zasadniczymi wymogami oraz pozostałymi stosownymi postanowieniami Dyrektywy 1999/5/WE.
Português	Samsung Electronics declara que esta câmara digital está conforme os requisitos essenciais e outras disposições da Directiva 1999/5/CE.
Slovensko	Samsung Electronics izjavlja, da je ta digitalni fotoaparát v skladu z bistvenimi zahtevami in ostalimi relevantnimi določili direktive 1999/5/ES.
Slovensky	Samsung Electronics týmto vyhlasuje, že tento digitálny fotoaparát spĺňa základné požiadavky a všetky príslušné ustanovenia Smernice 1999/5/ES.
Suomi	Samsung Electronics vakuuttaa täten että tämä digitaalikamera on direktiivin 1999/5/EY oleellisten vaatimusten ja sitä koskevien direktiivin muiden ehtojen mukainen.
Svenska	Härmed intygar Samsung Electronicsatt dessa digitalkameror står i överensstämmelse med de väsentliga egenskapskrav och övriga relevanta bestämmelser som framgår av direktiv 1999/5/EG.
Български	С настоящото Samsung Electronics декларира, че този цифров фотоапарат е в съответствие със съществените изисквания и другите приложими разпоредби на Директива 1999/5/EK.
Română	Prin prezenta, Samsung Electronics, declară că această cameră foto digitală este în conformitate cu cerințele esențiale și alte prevederi relevante ale Directivei 1999/5/CE.
Norsk	Samsung Electronicserklærer herved at dette digitalkameraet er i samsvar med de grunnleggende krav og øvrige relevante krav i direktiv 1999/5/EF.
Türkiye	Bu belge ile, Samsung Electronics bu dijital kameranın 1999/5/EC Yönetmeliğinin temel gerekliliklerine ve ilgili hükümlerine uygun olduğunu beyan eder.
Íslenska	Hér með lýsir Samsung Electronics því yfir að þessi stafræna myndavél sé í samræmi við grunnkröfur og önnur ákvæði tilskipunar 1999/5/EB.



Please refer to the warranty that came with your product
or visit our website www.samsung.com for after-sales service or inquiries.

