



FCC RADIO TEST REPORT

Applicant : WENZHOU MTLC ELECTRIC APPLIANCES CO., LTD.
Address : Tiancheng Industrial Zone ,Yueqing, Zhejiang, China
Equipment : TR Duplex Receptacle
Model No. : JWF15R
Trade Name : N/A
FCC ID : ZZH-JWF15R

I HEREBY CERTIFY THAT :

The sample was received on Jun. 04, 2018 and the testing was carried out on Jun. 12, 2018 at CerpPASS Technology Corp. The test result refers exclusively to the test presented test model / sample. Without written approval of CerpPASS Technology Corp., the test report shall not be reproduced except in full.

Approved by:

Mark Liao

Assistant Manager

Laboratory Accreditation:

CerpPASS Technology Corporation Test Laboratory

TAF LAB Code:	1439
---------------	------



CONTENTS

1. Summary of Test Procedure and Test Results	5
1.1 Applicable Standards.....	5
2. Test Configuration of Equipment under Test	6
2.1 Feature of Equipment under Test.....	6
2.2 Carrier Frequency of Channels.....	6
2.3 Test Mode and Test Software.....	6
2.4 Description of Test System.....	7
2.5 General Information of Test.....	8
2.6 Measurement Uncertainty.....	9
2.7 Duty cycle.....	10
3. Test Equipment and Ancillaries Used for Tests	11
4. Antenna Requirements	12
4.1 Standard Applicable.....	12
4.2 Antenna Construction and Directional Gain.....	12
5. Test of AC Power Line Conducted Emission	13
5.1 Test Limit.....	13
5.2 Test Procedures.....	13
5.3 Typical Test Setup.....	13
5.4 Test Result and Data.....	14
6. Test of Spurious Emission (Radiated)	16
6.1 Test Limit.....	16
6.2 Test Procedures.....	16
6.3 Typical Test Setup.....	17
6.4 Test Result and Data (9KHz ~ 30MHz).....	18
6.5 Test Result and Data (30MHz ~ 1GHz).....	18
6.6 Test Result and Data (1GHz ~ 25GHz).....	19
6.7 Restricted Bands of Operation.....	28
6.8 Restrict Band Emission Measurement Data.....	29
7. Test of Spurious Emission (Conducted)	32
7.1 Test Limit.....	32
7.2 Test Procedure.....	32
7.3 Test Setup Layout.....	32
7.4 Test Result and Data.....	33
8. 6dB Bandwidth Measurement Data	37
8.1 Test Limit.....	37
8.2 Test Procedures.....	37
8.3 Test Setup Layout.....	37
8.4 Test Result and Data.....	37
9. Maximum Peak Output Power	40
9.1 Test Limit.....	40
9.2 Test Procedures.....	40
9.3 Test Setup Layout.....	40
9.4 Test Result and Data.....	41
10.Power Spectral Density	42



10.1 Test Limit	42
10.2 Test Procedures	42
10.3 Test Setup Layout.....	42
10.4 Test Result and Data.....	43



1. Summary of Test Procedure and Test Results

1.1 Applicable Standards

ANSI C63.10: 2013

KDB 558074 D01 DTS Meas Guidance v03r05

FCC Rules and Regulations Part 15 Subpart C §15.247

FCC Rule	Description of Test	Result
FCC CFR Title 47 Part 15 Subpart C: Section 15.203/15.247 (b)	. Antenna Requirement	Pass
FCC CFR Title 47 Part 15 Subpart C: Section 15.207	. AC Power Line Conducted Emission	Pass
FCC CFR Title 47 Part 15 Subpart C: Section 15.205/15.209; Part2 section 2.1051, 2.1053, 2.1057	. Spurious Emission(Radiated)	Pass
FCC CFR Title 47 Part 15 Subpart C: Section 15.247(d); Part2 section 2.1051 and 2.1057	. Spurious Emission(Conducted)	Pass
FCC CFR Title 47 Part 15 Subpart C: Section 15.247(a)(2); Part2 section 2.1049	. 6dB Bandwidth	Pass
FCC CFR Title 47 Part 15 Subpart C: Section 15.247(b); Part2 section 2.1046	. Maximum Peak Output Power	Pass
FCC CFR Title 47 Part 15 Subpart C: Section 15.247(e)	. Power Spectral Density	Pass



2. Test Configuration of Equipment under Test

2.1 Feature of Equipment under Test

Equipment	TR Duplex Receptacle
Model No.	JWF15R
Model Discrepancy	N/A
Spreading	802.11b: CCK, DQPSK, DBPSK 802.11g: 64 QAM, 16 QAM, QPSK, BPSK 802.11n: BPSK, QPSK, 16QAM, 64QAM
Frequency Range	802.11b/g/n(20MHz): 2412-2462MHz
Number of Channels	802.11b/g/n (20MHz):11
Data Rate	802.11b: 1, 2, 5.5, 11Mbps 802.11g: 6, 9, 12, 18, 24, 36, 48, 54Mbps 802.11n: Up to MCS7

Note: for more details, please refer to the User's manual of the EUT.

2.2 Carrier Frequency of Channels

802.11b, 802.11g, 802.11n HT 20 (2412MHz~2462MHz)

Channel	Frequency(MHz)	Channel	Frequency(MHz)
*01	2412	07	2442
02	2417	08	2447
03	2422	09	2452
04	2427	10	2457
05	2432	*11	2462
*06	2437	---	---

Note: Channels remarked * are selected to perform test.

2.3 Test Mode and Test Software

- a. During testing, the interface cables and equipment positions were varied according to ANSI C63.4.
- b. The complete test system included support units and EUT for the RF test.
- c. An executive program, "**SecureCRT.exe**" which transmits and receives data through Wireless.
- d. The EUT had been tested under operating condition
After verification, all tests were carried out with the worst case test modes as shown below except radiated spurious emission below 1GHz and power line conducted emissions below 30MHz, which worst case was in normal link mode only.
EUT staying in continuous transmitting mode was programmed.
- e. Test modes:
 - Mode 1: IEEE 802.11b
 - Mode 2: IEEE 802.11g
 - Mode 3: IEEE 802.11n HT20



2.4 Description of Test System

No	Device	Manufacturer	Model No.	Description
1	USB Mouse	DELL	OXN967	R41108
2	Notebook	SONY	PCG-71811P	R33021

Cable:

No.	Cable	Quantity	Description
A	USB Cable	1	1.0m Non Shielding
B	USB Mouse Cable	1	1.8m Non Shielding



2.5 General Information of Test

☒	Test Site	CerpPASS Technology Corporation Test Laboratory Address: No.10, Ln. 2, Lianfu St., Luzhu Dist., Taoyuan City 33848, Taiwan (R.O.C.) Tel:+886-3-3226-888 Fax:+886-3-3226-881 Address: No.68-1, Shihbachongsi, Shihding Township, New Taipei City 223, Taiwan, R.O.C. Tel: +886-2-2663-8582
	FCC	TW1079, TW1061, TW1439
	IC	4934E-1, 4934E-2
	VCCI	T-2205 for Telecommunication Test C-4663 for Conducted emission test R-3428, R-4218 for Radiated emission test G-812, G-813 for radiated disturbance above 1GHz
Frequency Range Investigated:		Conducted: from 150kHz to 30 MHz Radiation: from 30 MHz to 25000MHz
Test Distance:		The test distance of radiated emission from antenna to EUT is 3 M.



2.6 Measurement Uncertainty

Measurement Item	Measurement Frequency	Polarization	Uncertainty
Conducted Emission	9 kHz ~ 30 MHz	LINE/NEUTRAL	±2.71 dB
Radiated Emission	9 kHz ~ 30 MHz	Vertical	±3.65dB
		Horizontal	±3.89dB
Radiated Emission	30 MHz ~ 25GHz	Vertical	±4.11 dB
		Horizontal	±4.10 dB
Occupied Bandwidth	---	---	±7500 Hz
Maximum Peak Output Power	---	---	±1.4 dB
Power Spectral Density	---	---	±2.2 dB



2.7 Duty cycle

Test Item	Duty cycle
Test Date	Jun. 09, 2018

Mode	Frequency (MHz)	Measurement (%)
802.11b	2412	99.76
802.11g	2412	98.72
802.11n(20MHz)	2412	99.69

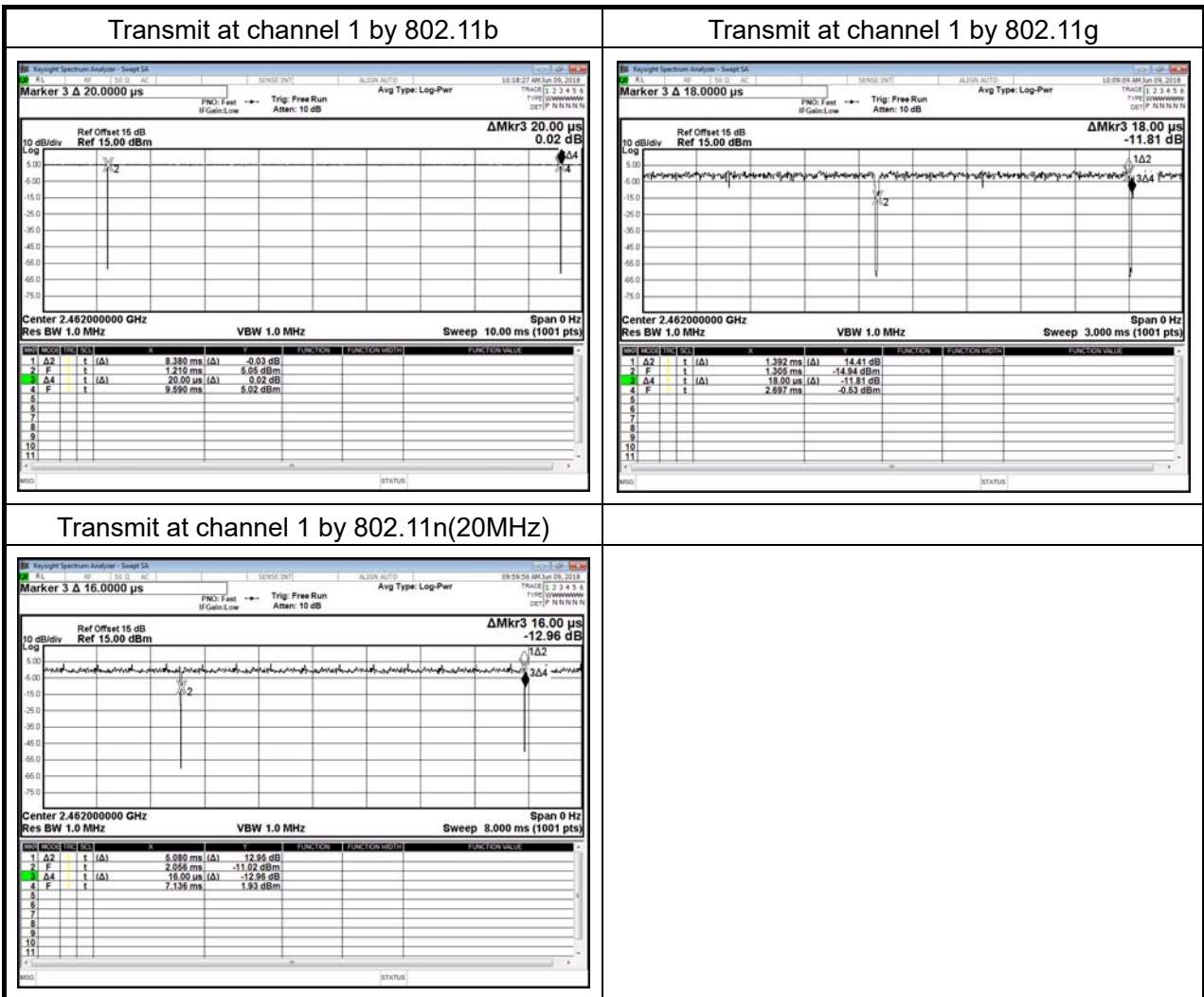



3. Test Equipment and Ancillaries Used for Tests

Instrument	Manufacturer	Model No	Serial No	Calibration Date	Valid Date
EMI Receiver	R&S	ESCI3	100821	2017/09/08	2018/09/07
LISN	Schwarzbeck	NSLK 8127	8127-568	2018/02/26	2019/02/25
Pulse Limiter	R&S	ESH3-Z2	101934	2018/02/22	2019/02/21
Bilog Antenna	Schwarzbeck	VULB9168	275	2017/08/31	2018/08/30
Active Loop Antenna	EMCO	6507	40855	2018/05/22	2019/05/21
Horn Antenna	EMCO	3115	31601	2017/09/11	2018/09/10
Horn Antenna	EMCO	3116	31970	2018/03/23	2019/03/22
Preamplifier	EM	EM330	60658	2017/09/08	2018/09/07
Preamplifier	EMC INSTRUMENTS	EMC051845SE	980333	2017/09/20	2018/09/19
Preamplifier	EMC INSTRUMENTS	EMC184045	980065	2017/11/10	2018/11/09
MXG MW Analog Signal Generator	KEYSIGHT	N5183A	MY50142931	2018/03/23	2019/03/22
Spectrum Analyzer	R&S	FSP40	100219	2017/07/01	2018/06/30
BLUETOOTH TESTER	R&S	CBT	101133	2018/04/02	2019/04/01
Attenuator	KEYSIGHT	8491B	MY39250705	2017/09/04	2018/09/03
Rotary Attenuator	Agilent	8495B	MY42146680	2018/03/29	2019/03/28
Temp & Humi chamber	T-MACHINE	TMJ-9712	T-12-040111	2017/09/04	2018/09/03
Series Power Meter	Anritsu	ML2495A	1224005	2018/03/23	2019/03/22
Power Sensor	Anritsu	MA2411B	1207295	2018/03/23	2019/03/22
Software	Farad	Ez-EMC	ver.ct3a1	N/A	N/A
Software	AUDIX	E3	V8.2014-8-6	N/A	N/A
Software	Keysight	N7607B Signal Studio	V3.0.0.0	N/A	N/A
Software	Keysight	Inservice MonitorUtility	N/A	N/A	N/A



4. Antenna Requirements

4.1 Standard Applicable

For intentional device, according to FCC 47 CFR Section 15.203, an intentional radiator shall be designed to ensure that no antenna other than that furnished by the responsible party shall be used with the device.

And according to FCC 47 CFR Section 15.247 (b), if transmitting antennas of directional gain greater than 6dBi are used, the power shall be reduced by the amount in dB that the directional gain of the antenna exceeds 6dBi.

4.2 Antenna Construction and Directional Gain

No.	Antenna Type	Antenna Gain
1	Internal Antenna	2.0dBi



5. Test of AC Power Line Conducted Emission

5.1 Test Limit

Conducted Emissions were measured from 150 kHz to 30 MHz with a bandwidth of 9 KHz on the 120 VAC power and return leads of the EUT according to the methods defined in ANSI C63.10-2013. The EUT was placed on a nonmetallic stand in a shielded room 0.8 meters above the ground plane as shown in section 6.2.2. The interface cables and equipment positioning were varied within limits of reasonable applications to determine the position produced maximum conducted emissions.

Frequency (MHz)	Quasi Peak (dB μ V)	Average (dB μ V)
0.15 – 0.5	66-56*	56-46*
0.5 – 5.0	56	46
5.0 – 30.0	60	50

*Decreases with the logarithm of the frequency.

5.2 Test Procedures

The EUT was setup according to ANSI C63.10, 2013 and tested according to DTS test procedure of Oct 2014 KDB558074 for compliance to FCC 47CFR 15.247 requirements. The EUT was placed on a platform of nominal size, 1 m by 1.5 m, raised 80 cm above the conducting ground plane. The vertical conducting plane was located 40 cm to the rear of the EUT. All other surfaces of EUT were at least 80 cm from any other grounded conducting surface. The EUT and simulators are connected to the main power through a line impedance stabilization network (LISN). The LISN provides a 50 ohm /50uH coupling impedance for the measuring equipment. The peripheral devices are also connected to the main power through a LISN. (Please refer to the block diagram of the test setup and photographs) Each current-carrying conductor of the EUT power cord, except the ground (safety) conductor, was individually connected through a LISN to the input power source. The excess length of the power cord between the EUT and the LISN receptacle were folded back and forth at the center of the lead to form a bundle not exceeding 40 cm in length. Conducted emissions were investigated over the frequency range from 0.15MHz to 30MHz using a receiver bandwidth of 9kHz.

5.3 Typical Test Setup

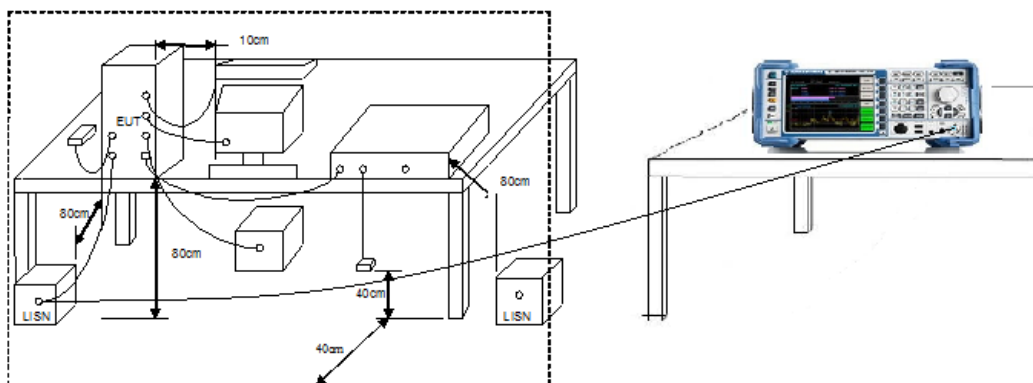



5.4 Test Result and Data

Test Mode :	Normal Link	Phase :	Line
Temperature :	20°C	Humidity:	51%
Pressur(mbar) :	1002	Date:	Jun. 10, 2018

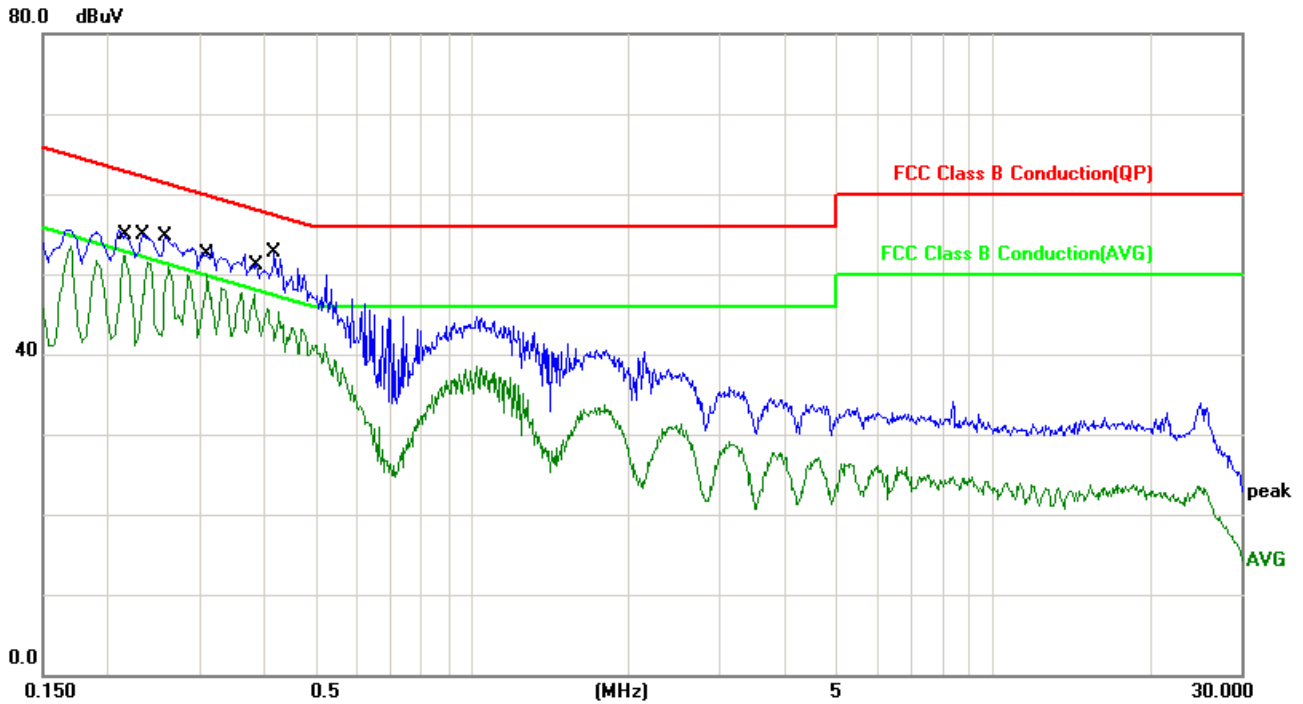

No.	Frequency (MHz)	Factor (dB)	Reading (dBuV)	Level (dBuV)	Limit (dBuV)	Margin (dB)	Detector
1	0.2162	10.05	43.39	53.44	62.96	-9.52	QP
2	0.2162	10.05	41.98	52.03	52.96	-0.93	AVG
3	0.2340	10.04	42.23	52.27	62.30	-10.03	QP
4	0.2340	10.04	41.12	51.16	52.30	-1.14	AVG
5	0.2580	10.03	42.00	52.03	61.49	-9.46	QP
6	0.2580	10.03	40.36	50.39	51.49	-1.10	AVG
7	0.3100	10.00	41.48	51.48	59.97	-8.49	QP
8	0.3100	10.00	39.08	49.08	49.97	-0.89	AVG
9	0.3860	9.95	38.85	48.80	58.15	-9.35	QP
10	0.3860	9.95	36.97	46.92	48.15	-1.23	AVG
11	0.4180	9.94	37.14	47.08	57.49	-10.41	QP
12	0.4180	9.94	36.13	46.07	47.49	-1.42	AVG

Note: Measurement Level = Reading Level + Correct Factor+ Attenuator



Test Mode :	Normal Link	Phase :	Neutral
Temperature :	20°C	Humidity :	51%
Pressur(mbar) :	1002	Date :	Jun. 10, 2018

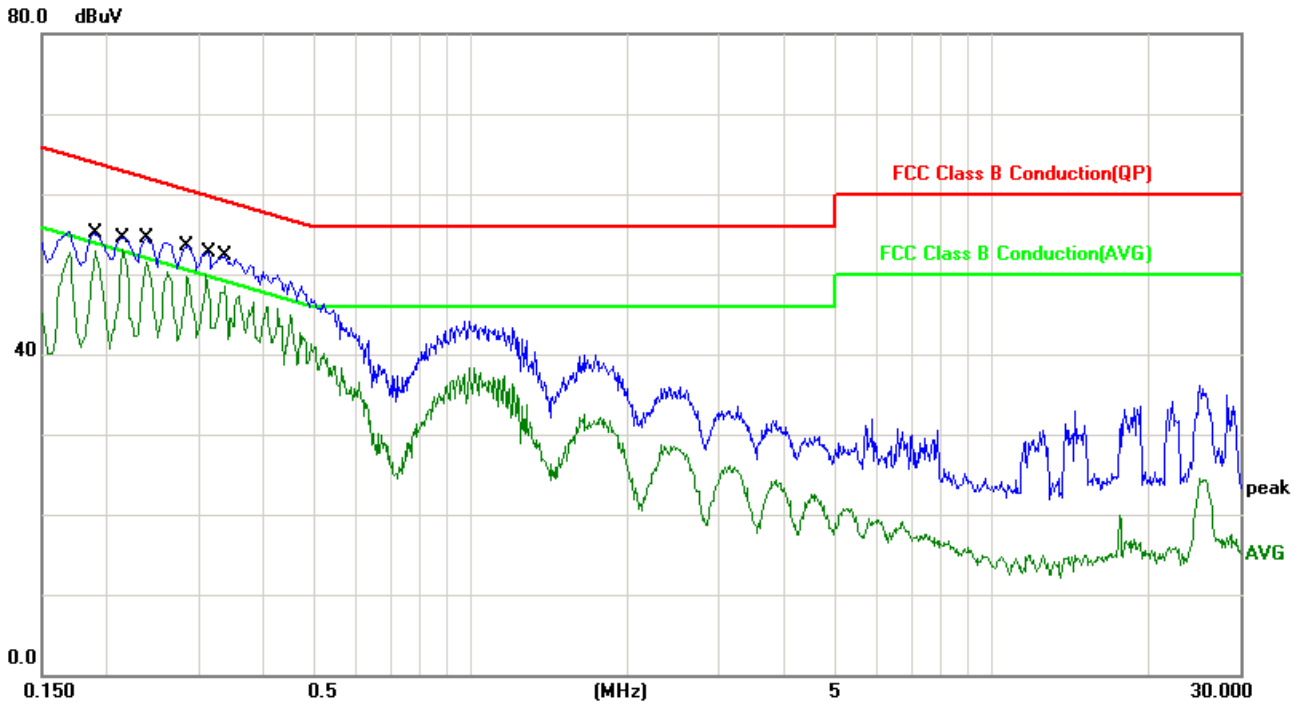

No.	Frequency (MHz)	Factor (dB)	Reading (dBuV)	Level (dBuV)	Limit (dBuV)	Margin (dB)	Detector
1	0.1900	10.06	43.73	53.79	64.03	-10.24	QP
2	0.1900	10.06	42.62	52.68	54.03	-1.35	AVG
3	0.2140	10.05	43.43	53.48	63.04	-9.56	QP
4	0.2140	10.05	41.98	52.03	53.04	-1.01	AVG
5	0.2380	10.04	43.08	53.12	62.16	-9.04	QP
6	0.2380	10.04	41.49	51.53	52.16	-0.63	AVG
7	0.2860	10.01	42.00	52.01	60.64	-8.63	QP
8	0.2860	10.01	39.87	49.88	50.64	-0.76	AVG
9	0.3140	10.00	40.80	50.80	59.86	-9.06	QP
10	0.3140	10.00	38.12	48.12	49.86	-1.74	AVG
11	0.3379	9.98	40.16	50.14	59.25	-9.11	QP
12	0.3379	9.98	37.96	47.94	49.25	-1.31	AVG

Note: Measurement Level = Reading Level + Correct Factor+ Attenuator



6. Test of Spurious Emission (Radiated)

6.1 Test Limit

In any 100kHz bandwidth outside the frequency band in which the spread spectrum or digitally modulated intentional radiator is operating, the radio frequency power that is produced by the intentional radiator shall be at least 20dB below that in the 100kHz bandwidth within the band that contains the highest level of the desired power, based on either an RF conducted or a radiated measurement. If the transmitter measurement is based on the maximum conducted output power, the attenuation required under this paragraph shall be 30dB instead of 20dB. In addition, radiated emissions which fall in section 15.205(a) the restricted bands must also comply with the radiated emission limit specified in section 15.209(a).

FREQUENCIES(MHz)	FIELD STRENGTH (microvolts/meter)	MEASUREMENT DISTANCE(meters)
0.009~0.490	2400/F(kHz)	300
0.490~1.705	24000/F(kHz)	30
1.705~30.0	30	30
30~88	100	3
88~216	150	3
216~960	200	3
Above 960	500	3

6.2 Test Procedures

- The EUT was placed on a rotatable table top 0.8 meter for frequency below 1GHz and 1.5meter for frequency above 1GHz above ground.
- The EUT was set 3 meters from the interference receiving antenna which was mounted on the top of a variable height antenna tower.
- The table was rotated 360 degrees to determine the position of the highest radiation.
- The antenna is a broadband antenna and its height is varied between one meter and four meters above ground to find the maximum value of the field strength both horizontal polarization and vertical polarization of the antenna are set to make the measurement.
- For each suspected emission the EUT was arranged to its worst case and then tune the antenna tower (from 1 M to 4 M) and turn table (from 0 degree to 360 degrees) to find the maximum reading.
- Set the test-receiver system to Peak or CISPR quasi-peak Detect Function and specified bandwidth with Maximum Hold Mode.
- If the emission level of the EUT in peak mode was 3 dB lower than the limit specified, then testing will be stopped and peak values of EUT will be reported, otherwise, the emissions which do not have 3 dB margin will be repeated one by one using the quasi-peak method and reported.
- For testing above 1GHz, the emission level of the EUT in peak mode was 20dB lower than AVG limit (that means the emission level in peak mode also complies with the limit in AVG mode), then testing will be stopped and peak values of EUT will be reported, otherwise, the emissions will be measured in AVG mode again and reported.



6.3 Typical Test Setup

Below 30MHz Test Setup

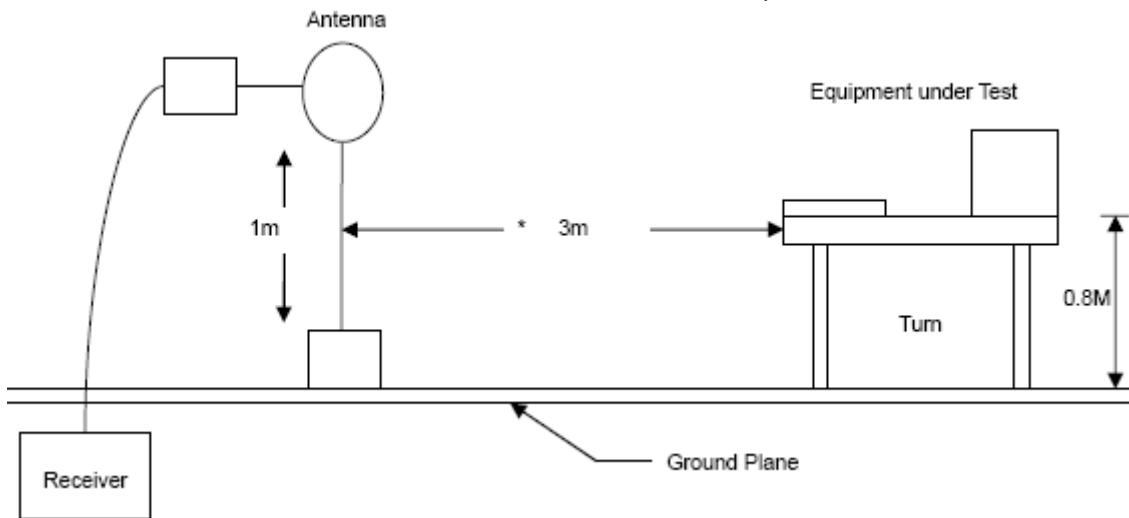

30M - 1GHz Test Setup

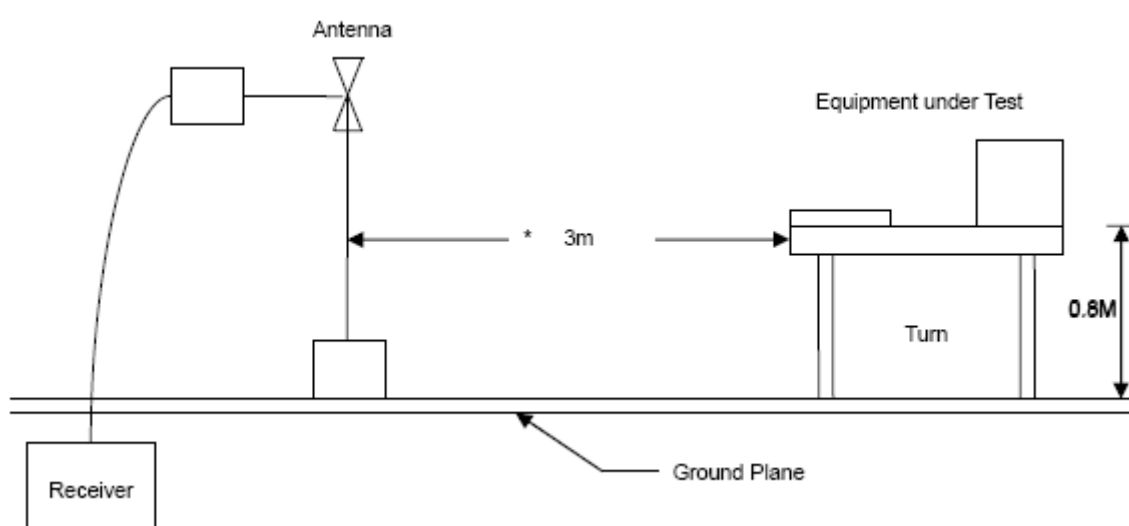

Above 1GHz Test Setup

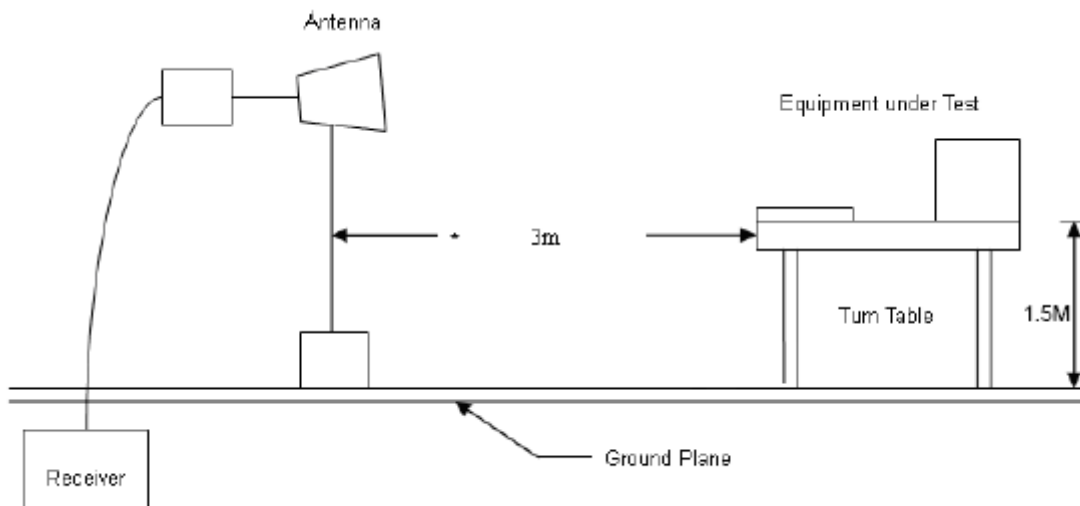



6.4 Test Result and Data (9KHz ~ 30MHz)

The 9kHz-30MHz spurious emission is under limit 20dB more.

6.5 Test Result and Data (30MHz ~ 1GHz)

Power	: AC 120V	Temperature	: 24 °C
Test Mode	: Normal Link	Humidity	: 54 %
Test date	: Jun. 10, 2018	Atmospheric Pressure	: 1010 hpa

Frequency (MHz)	AntPol. H/V	Correct Factor (dB)	Reading level (dBuV)	Measure Level (dBuV/m)	Limit 3m (dBuV/m)	Safe Margin (dB)	Detector mode (PK/QP)
30.0000	H	-3.01	26.45	23.44	40.00	-16.56	peak
207.5100	H	-9.50	35.44	25.94	43.50	-17.56	peak
275.4100	H	-8.94	34.46	25.52	46.00	-20.48	peak
400.5400	H	-5.13	33.94	28.81	46.00	-17.19	peak
480.0800	H	-1.10	32.40	31.30	46.00	-14.70	peak
519.8500	H	-2.63	32.85	30.22	46.00	-15.78	peak
33.8800	V	-5.41	32.77	27.36	40.00	-12.64	peak
43.5800	V	-11.77	41.12	29.35	40.00	-10.65	peak
61.0400	V	-15.54	43.49	27.95	40.00	-12.05	peak
472.3200	V	-1.44	28.98	27.54	46.00	-18.46	peak
519.8500	V	-2.63	30.92	28.29	46.00	-17.71	peak
689.6000	V	-1.23	31.95	30.72	46.00	-15.28	peak

Note: Level = Reading + Factor

Margin = Level – Limit

Factor= Antenna Factor + Cable Loss - Amplifier Factor

**6.6 Test Result and Data (1GHz ~ 25GHz)**

Power	: AC 120V	Temperature	: 24 °C
Test Mode1	802.11b (2412MHz)	Humidity	: 54 %
Test date	: Jun. 10, 2018	Atmospheric Pressure	: 1010 hpa

Frequency (MHz)	AntPol. H/V	Correct Factor (dB)	Reading level (dBuV)	Measure Level (dBuV/m)	Limit 3m (dBuV/m)	Safe Margin (dB)	Detector mode (PK/AV)
1595.000	H	-1.06	42.65	41.59	74.00	-32.41	peak
2416.667	H	3.06	40.01	43.07	74.00	-30.93	peak
3578.333	H	9.67	33.61	43.28	74.00	-30.72	peak
4825.000	H	14.27	47.69	61.96	74.00	-12.04	peak
4825.000	H	14.27	33.12	47.39	54.00	-6.61	AVG
5760.000	H	15.66	31.85	47.51	74.00	-26.49	peak
7120.000	H	18.55	33.45	52.00	74.00	-22.00	peak
1708.333	V	-0.41	47.33	46.92	74.00	-27.08	peak
2416.667	V	3.06	41.13	44.19	74.00	-29.81	peak
3210.000	V	7.87	35.58	43.45	74.00	-30.55	peak
4825.000	V	14.27	50.15	64.42	74.00	-9.58	peak
4825.000	V	14.27	36.04	50.31	54.00	-3.69	AVG
5646.667	V	15.38	33.31	48.69	74.00	-25.31	peak
7205.000	V	18.88	31.22	50.10	74.00	-23.90	peak

Note: Level = Reading + Factor

Margin = Level – Limit

Factor= Antenna Factor + Cable Loss - Amplifier Factor



Power	: AC 120V	Temperature	: 24 °C
Test Mode1	: 802.11b (2437MHz)	Humidity	: 54 %
Test date	: Jun. 10, 2018	Atmospheric Pressure	: 1010 hpa

Frequency (MHz)	AntPol. H/V	Correct Factor (dB)	Reading level (dBuV)	Measure Level (dBuV/m)	Limit 3m (dBuV/m)	Safe Margin (dB)	Detector mode (PK/AV)
2445.000	H	3.18	42.99	46.17	74.00	-27.83	peak
3465.000	H	9.22	34.90	44.12	74.00	-29.88	peak
4881.667	H	14.38	47.47	61.85	74.00	-12.15	peak
4881.667	H	14.38	33.61	47.99	54.00	-6.01	AVG
5278.333	H	14.83	33.11	47.94	74.00	-26.06	peak
6581.667	H	16.72	31.40	48.12	74.00	-25.88	peak
7091.667	H	18.44	31.59	50.03	74.00	-23.97	peak
1595.000	V	-1.06	43.89	42.83	74.00	-31.17	peak
2445.000	V	3.18	41.09	44.27	74.00	-29.73	peak
4598.333	V	13.84	31.81	45.65	74.00	-28.35	peak
4881.667	V	14.38	49.59	63.97	74.00	-10.03	peak
4881.667	V	14.38	34.88	49.26	54.00	-4.74	AVG
5958.333	V	16.16	31.45	47.61	74.00	-26.39	peak
7035.000	V	18.22	30.74	48.96	74.00	-25.04	peak

Note: Level = Reading + Factor

Margin = Level – Limit

Factor= Antenna Factor + Cable Loss - Amplifier Factor



Power	: AC 120V	Temperature	: 24 °C
Test Mode1	802.11b (2462MHz)	Humidity	: 54 %
Test date	: Jun. 10, 2018	Atmospheric Pressure	: 1010 hpa

Frequency (MHz)	AntPol. H/V	Correct Factor (dB)	Reading level (dBuV)	Measure Level (dBuV/m)	Limit 3m (dBuV/m)	Safe Margin (dB)	Detector mode (PK/AV)
2473.333	H	3.31	46.56	49.87	74.00	-24.13	peak
3521.667	H	9.47	33.59	43.06	74.00	-30.94	peak
4541.667	H	13.74	31.85	45.59	74.00	-28.41	peak
4938.333	H	14.48	46.28	60.76	74.00	-13.24	peak
4938.333	H	14.48	32.63	47.11	54.00	-6.89	AVG
5788.333	H	15.74	32.15	47.89	74.00	-26.11	peak
7063.333	H	18.33	31.18	49.51	74.00	-24.49	peak
1680.000	V	-0.57	42.04	41.47	74.00	-32.53	peak
2473.333	V	3.31	41.88	45.19	74.00	-28.81	peak
3323.333	V	8.47	35.32	43.79	74.00	-30.21	peak
4938.333	V	14.48	46.83	61.31	74.00	-12.69	peak
4938.333	V	14.48	32.61	47.09	54.00	-6.91	AVG
5788.333	V	15.74	32.23	47.97	74.00	-26.03	peak
7205.000	V	18.88	31.10	49.98	74.00	-24.02	peak

Note: Level = Reading + Factor

Margin = Level – Limit

Factor= Antenna Factor + Cable Loss - Amplifier Factor



Power	: AC 120V	Temperature	: 24 °C
Test Mode2	: 802.11g (2412MHz)	Humidity	: 54 %
Test date	: Jun. 10, 2018	Atmospheric Pressure	: 1010 hpa

Frequency (MHz)	AntPol. H/V	Correct Factor (dB)	Reading level (dBuV)	Measure Level (dBuV/m)	Limit 3m (dBuV/m)	Safe Margin (dB)	Detector mode (PK/AV)
1595.000	H	-1.06	39.71	38.65	74.00	-35.35	peak
2416.667	H	3.06	38.35	41.41	74.00	-32.59	peak
3521.667	H	9.47	34.02	43.49	74.00	-30.51	peak
4825.000	H	14.27	41.49	55.76	74.00	-18.24	peak
4825.000	H	14.27	26.81	41.08	54.00	-12.92	AVG
5590.000	H	15.24	32.35	47.59	74.00	-26.41	peak
6581.667	H	16.72	31.76	48.48	74.00	-25.52	peak
1595.000	V	-1.06	41.11	40.05	74.00	-33.95	peak
2983.333	V	6.66	35.10	41.76	74.00	-32.24	peak
3578.333	V	9.67	33.67	43.34	74.00	-30.66	peak
4825.000	V	14.27	42.33	56.60	74.00	-17.40	peak
4825.000	V	14.27	26.58	40.85	54.00	-13.15	AVG
6100.000	V	16.30	31.83	48.13	74.00	-25.87	peak
7063.333	V	18.33	31.00	49.33	74.00	-24.67	peak

Note: Level = Reading + Factor

Margin = Level – Limit

Factor= Antenna Factor + Cable Loss - Amplifier Factor



Power	: AC 120V	Temperature	: 24 °C
Test Mode2	: 802.11g (2437MHz)	Humidity	: 54 %
Test date	: Jun. 10, 2018	Atmospheric Pressure	: 1010 hpa

Frequency (MHz)	AntPol. H/V	Correct Factor (dB)	Reading level (dBuV)	Measure Level (dBuV/m)	Limit 3m (dBuV/m)	Safe Margin (dB)	Detector mode (PK/AV)
1595.000	H	-1.06	40.55	39.49	74.00	-34.51	peak
2445.000	H	3.18	40.71	43.89	74.00	-30.11	peak
3550.000	H	9.57	34.05	43.62	74.00	-30.38	peak
4881.667	H	14.38	40.82	55.20	74.00	-18.80	peak
4881.667	H	14.38	23.91	38.29	54.00	-15.71	AVG
5930.000	H	16.09	31.79	47.88	74.00	-26.12	peak
7120.000	H	18.55	31.24	49.79	74.00	-24.21	peak
1595.000	V	-1.06	45.07	44.01	74.00	-29.99	peak
2445.000	V	3.18	40.00	43.18	74.00	-30.82	peak
3408.333	V	8.92	34.46	43.38	74.00	-30.62	peak
4881.667	V	14.38	41.43	55.81	74.00	-18.19	peak
4881.667	V	14.38	24.12	38.50	54.00	-15.50	AVG
6156.667	V	16.32	31.69	48.01	74.00	-25.99	peak
7375.000	V	19.54	29.40	48.94	74.00	-25.06	peak

Note: Level = Reading + Factor

Margin = Level – Limit

Factor= Antenna Factor + Cable Loss - Amplifier Factor



Power	: AC 120V	Temperature	: 24 °C
Test Mode2	: 802.11g (2462MHz)	Humidity	: 54 %
Test date	: Jun. 10, 2018	Atmospheric Pressure	: 1010 hpa

Frequency (MHz)	AntPol. H/V	Correct Factor (dB)	Reading level (dBuV)	Measure Level (dBuV/m)	Limit 3m (dBuV/m)	Safe Margin (dB)	Detector mode (PK/AV)
1595.000	H	-1.06	41.87	40.81	74.00	-33.19	peak
2445.000	H	3.18	45.21	48.39	74.00	-25.61	peak
3521.667	H	9.47	33.47	42.94	74.00	-31.06	peak
4258.333	H	12.43	31.63	44.06	74.00	-29.94	peak
4938.333	H	14.48	38.49	52.97	74.00	-21.03	peak
6100.000	H	16.30	31.76	48.06	74.00	-25.94	peak
1595.000	V	-1.06	43.33	42.27	74.00	-31.73	peak
2473.333	V	3.31	40.48	43.79	74.00	-30.21	peak
4485.000	V	13.58	30.80	44.38	74.00	-29.62	peak
4938.333	V	14.48	39.62	54.10	74.00	-19.90	peak
4938.333	V	14.48	22.69	37.17	54.00	-16.83	AVG
6553.333	V	16.63	31.44	48.07	74.00	-25.93	peak
7063.333	V	18.33	30.90	49.23	74.00	-24.77	peak

Note: Level = Reading + Factor

Margin = Level – Limit

Factor= Antenna Factor + Cable Loss - Amplifier Factor



Power	: AC 120V	Temperature	: 24 °C
Test Mode3	: 802.11n HT20 (2412MHz)	Humidity	: 54 %
Test date	: Jun. 10, 2018	Atmospheric Pressure	: 1010 hpa

Frequency (MHz)	AntPol. H/V	Correct Factor (dB)	Reading level (dBuV)	Measure Level (dBuV/m)	Limit 3m (dBuV/m)	Safe Margin (dB)	Detector mode (PK/AV)
1595.000	H	-1.06	43.64	42.58	74.00	-31.42	peak
2416.667	H	3.06	37.66	40.72	74.00	-33.28	peak
3691.667	H	10.06	33.53	43.59	74.00	-30.41	peak
4825.000	H	14.27	41.70	55.97	74.00	-18.03	peak
4825.000	H	14.27	23.98	38.25	54.00	-15.75	AVG
6043.333	H	16.28	32.02	48.30	74.00	-25.70	peak
7431.667	H	19.76	28.72	48.48	74.00	-25.52	peak
1595.000	V	-1.06	43.90	42.84	74.00	-31.16	peak
2416.667	V	3.06	39.59	42.65	74.00	-31.35	peak
3465.000	V	9.22	34.16	43.38	74.00	-30.62	peak
4825.000	V	14.27	42.90	57.17	74.00	-16.83	peak
4825.000	V	14.27	24.63	38.90	54.00	-15.10	AVG
6610.000	V	16.82	31.80	48.62	74.00	-25.38	peak
7545.000	V	20.05	30.02	50.07	74.00	-23.93	peak

Note: Level = Reading + Factor

Margin = Level – Limit

Factor= Antenna Factor + Cable Loss - Amplifier Factor



Power	: AC 120V	Temperature	: 24 °C
Test Mode3	: 802.11n HT20 (2437MHz)	Humidity	: 54 %
Test date	: Jun. 10, 2018	Atmospheric Pressure	: 1010 hpa

Frequency (MHz)	AntPol. H/V	Correct Factor (dB)	Reading level (dBuV)	Measure Level (dBuV/m)	Limit 3m (dBuV/m)	Safe Margin (dB)	Detector mode (PK/AV)
1595.000	H	-1.06	40.71	39.65	74.00	-34.35	peak
2445.000	H	3.18	41.85	45.03	74.00	-28.97	peak
3521.667	H	9.47	33.80	43.27	74.00	-30.73	peak
4881.667	H	14.38	41.63	56.01	74.00	-17.99	peak
4881.667	H	14.38	24.31	38.69	54.00	-15.31	AVG
6326.667	H	16.39	31.24	47.63	74.00	-26.37	peak
7205.000	H	18.88	31.03	49.91	74.00	-24.09	peak
1595.000	V	-1.06	43.62	42.56	74.00	-31.44	peak
2445.000	V	3.18	39.22	42.40	74.00	-31.60	peak
3521.667	V	9.47	33.81	43.28	74.00	-30.72	peak
4230.000	V	12.28	32.20	44.48	74.00	-29.52	peak
4881.667	V	14.38	42.87	57.25	74.00	-16.75	peak
4881.667	V	14.38	25.16	39.54	54.00	-14.46	AVG
6411.667	V	16.42	31.56	47.98	74.00	-26.02	peak

Note: Level = Reading + Factor

Margin = Level – Limit

Factor= Antenna Factor + Cable Loss - Amplifier Factor



Power	: AC 120V	Temperature	: 24 °C
Test Mode3	: 802.11n HT20 (2462MHz)	Humidity	: 54 %
Test date	: Jun. 10, 2018	Atmospheric Pressure	: 1010 hpa

Frequency (MHz)	AntPol. H/V	Correct Factor (dB)	Reading level (dBuV)	Measure Level (dBuV/m)	Limit 3m (dBuV/m)	Safe Margin (dB)	Detector mode (PK/AV)
2445.000	H	3.18	44.34	47.52	74.00	-26.48	peak
3351.667	H	8.62	34.87	43.49	74.00	-30.51	peak
4938.333	H	14.48	39.99	54.47	74.00	-19.53	peak
4938.333	H	14.48	24.76	39.24	54.00	-14.76	AVG
5391.667	H	14.93	30.53	45.46	74.00	-28.54	peak
6638.333	H	16.91	31.72	48.63	74.00	-25.37	peak
7346.667	H	19.43	29.44	48.87	74.00	-25.13	peak
1595.000	V	-1.06	42.49	41.43	74.00	-32.57	peak
1991.667	V	1.22	41.18	42.40	74.00	-31.60	peak
2445.000	V	3.18	40.76	43.94	74.00	-30.06	peak
4910.000	V	14.43	40.44	54.87	74.00	-19.13	peak
4910.000	V	14.43	24.91	39.34	54.00	-14.66	AVG
6128.333	V	16.31	31.21	47.52	74.00	-26.48	peak
7318.333	V	19.32	29.41	48.73	74.00	-25.27	peak

Note: Level = Reading + Factor

Margin = Level – Limit

Factor= Antenna Factor + Cable Loss - Amplifier Factor



6.7 Restricted Bands of Operation

Only spurious emissions are permitted in any of the frequency bands listed below:

MHz	MHz	MHz	GHz
0.09000 – 0.11000	16.42000 – 16.42300	399.9 – 410.0	4.500 – 5.250
0.49500 – 0.505**	16.69475 – 16.69525	608.0 – 614.0	5.350 – 5.460
2.17350 – 2.19050	16.80425 – 16.80475	960.0 – 1240.0	7.250 – 7.750
4.12500 – 4.12800	25.50000 – 25.67000	1300.0 – 1427.0	8.025 – 8.500
4.17725 – 4.17775	37.50000 – 38.25000	1435.0 – 1626.5	9.000 – 9.200
4.20725 – 4.20775	73.00000 – 74.60000	1645.5 – 1646.5	9.300 – 9.500
6.21500 – 6.21800	74.80000 – 75.20000	1660.0 – 1710.0	10.600 – 12.700
6.26775 – 6.26825	108.00000 – 121.94000	1718.8 – 1722.2	13.250 – 13.400
6.31175 – 6.31225	123.00000 – 138.00000	2200.0 – 2300.0	14.470 – 14.500
8.29100 – 8.29400	149.90000 – 150.05000	2310.0 – 2390.0	15.350 – 16.200
8.36200 – 8.36600	156.52475 – 156.52525	2483.5 – 2500.0	17.700 – 21.400
8.37625 – 8.38675	156.70000 – 156.90000	2655.0 – 2900.0	22.010 – 23.120
8.41425 – 8.41475	162.01250 – 167.17000	3260.0 – 3267.0	23.600 – 24.000
12.29000 – 12.29300	167.72000 – 173.20000	3332.0 – 3339.0	31.200 – 31.800
12.51975 – 12.52025	240.00000 – 285.00000	3345.8 – 3358.0	36.430 – 36.500
12.57675 – 12.57725	322.00000 – 335.40000	3600.0 – 4400.0	Above 38.6
13.36000 – 13.41000			

** : Until February 1, 1999, this restricted band shall be 0.490-0.510 MHz

**6.8 Restrict Band Emission Measurement Data**

Test Date: Jun. 10, 2018

Temperature: 26°C

Atmospheric pressure: 1018 hPa

Humidity: 47%

Modulation Standard: 802.11b

Channel 1		Fundamental Frequency: 2412 MHz					
Frequency (MHz)	Factor (dB/m)	Reading (dBuV)	Level (dBuV/m)	Limit (dBuV/m)	Margin (dB)	Det.	Ant-Pol H/V
2390.000	2.95	61.63	64.58	74.00	-9.42	peak	H
2390.000	2.95	42.51	45.46	54.00	-8.54	AVG	H
2390.000	2.95	57.37	60.32	74.00	-13.68	peak	V
2390.000	2.95	38.12	41.07	54.00	-12.93	AVG	V
Channel 11		Fundamental Frequency: 2462 MHz					
2483.500	3.35	58.45	61.80	74.00	-12.20	peak	H
2483.500	3.35	40.19	43.54	54.00	-10.46	AVG	H
2483.500	3.35	56.96	60.31	74.00	-13.69	peak	V
2483.500	3.35	38.63	41.98	54.00	-12.02	AVG	V

Notes:

1. Result = Meter Reading + Factor
2. Factor = Antenna Factor + Cable Loss – Amplifier
3. The resolution bandwidth of test receiver/spectrum analyzer is 1MHz and video bandwidth is 3 MHz (detector peak mode) for Peak detection at frequency above 1GHz.
4. The resolution bandwidth of test receiver/spectrum analyzer is 1MHz and video bandwidth is 3 MHz (detector sample mode) for Average detection at frequency above 1GHz.



Test Date: Jun. 10, 2018

Temperature: 26°C

Atmospheric pressure: 1018 hPa

Humidity: 47%

Modulation Standard: 802.11g

Channel 1				Fundamental Frequency: 2412 MHz			
Frequency (MHz)	Factor (dB/m)	Reading (dBuV)	Level (dBuV/m)	Limit (dBuV/m)	Margin (dB)	Det.	Ant-Pol H/V
2390.000	2.95	61.55	64.50	74.00	-9.50	peak	H
2390.000	2.95	45.31	48.26	54.00	-5.74	AVG	H
2390.000	2.95	49.50	52.45	74.00	-21.55	peak	V
2390.000	2.95	33.84	36.79	54.00	-17.21	AVG	V
Channel 11				Fundamental Frequency: 2462 MHz			
2483.500	3.35	57.95	61.30	74.00	-12.70	peak	H
2483.500	3.35	42.18	45.53	54.00	-8.47	AVG	H
2483.500	3.35	51.60	54.95	74.00	-19.05	peak	V
2483.500	3.35	33.94	37.29	54.00	-16.71	AVG	V

Notes:

1. Result = Meter Reading + Factor
2. Factor = Antenna Factor + Cable Loss – Amplifier
3. The resolution bandwidth of test receiver/spectrum analyzer is 1MHz and video bandwidth is 3 MHz (detector peak mode) for Peak detection at frequency above 1GHz.
4. The resolution bandwidth of test receiver/spectrum analyzer is 1MHz and video bandwidth is 3 MHz (detector sample mode) for Average detection at frequency above 1GHz.



Test Date: Jun. 10, 2018

Temperature: 26°C

Atmospheric pressure: 1018 hPa

Humidity: 47%

Modulation Standard: 802.11n HT20

Channel 1				Fundamental Frequency: 2412 MHz			
Frequency (MHz)	Factor (dB/m)	Reading (dBuV)	Level (dBuV/m)	Limit (dBuV/m)	Margin (dB)	Det.	Ant-Pol H/V
2390.000	2.95	65.86	68.81	74.00	-5.19	peak	H
2390.000	2.95	49.05	52.00	54.00	-2.00	AVG	H
2390.000	2.95	55.29	58.24	74.00	-15.76	peak	V
2390.000	2.95	39.87	42.82	54.00	-11.18	AVG	V
Channel 11				Fundamental Frequency: 2462 MHz			
2483.500	3.35	61.30	64.65	74.00	-9.35	peak	H
2483.500	3.35	45.13	48.48	54.00	-5.52	AVG	H
2483.500	3.35	49.28	52.63	74.00	-21.37	peak	V
2483.500	3.35	33.61	36.96	54.00	-17.04	AVG	V

Notes:

1. Result = Meter Reading + Factor
2. Factor = Antenna Factor + Cable Loss – Amplifier
3. The resolution bandwidth of test receiver/spectrum analyzer is 1MHz and video bandwidth is 3 MHz (detector peak mode) for Peak detection at frequency above 1GHz.
4. The resolution bandwidth of test receiver/spectrum analyzer is 1MHz and video bandwidth is 3 MHz (detector sample mode) for Average detection at frequency above 1GHz.



7. Test of Spurious Emission (Conducted)

7.1 Test Limit

Below 30dB of the highest emission level of operating band (In 100 kHz Resolution Bandwidth)

7.2 Test Procedure

KDB 558074 D01v03r02 - Section 11.2 & Section 11.3

1. Reference level measurement

- (a) Set instrument center frequency to DTS channel center frequency
- (b) Set the span to ≥ 1.5 times the DTS bandwidth
- (c) Set the RBW = 100 kHz
- (d) Set the VBW $\geq 3 \times$ RBW
- (e) Detector = peak
- (f) Sweep time = auto couple
- (g) Trace mode = max hold
- (h) Allow trace to fully stabilize

2. Emission level measurement

- (a) Set the center frequency and span to encompass frequency range to be measured
- (b) RBW = 100kHz
- (c) VBW = 300kHz
- (d) Detector = Peak
- (e) Trace mode = max hold
- (f) Sweep time = auto couple
- (g) The trace was allowed to stabilize

7.3 Test Setup Layout

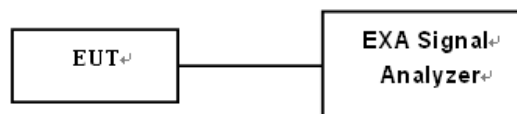



7.4 Test Result and Data

Test Date: Jun. 10, 2018

Temperature: 24°C

Atmospheric pressure: 1014 hPa

Humidity: 47%

Modulation Standard	Frequency (MHz)	Test Result
802.11b	2412	Pass
	2437	Pass
	2462	Pass
802.11g	2412	Pass
	2437	Pass
	2462	Pass
802.11n HT20	2412	Pass
	2437	Pass
	2462	Pass

Note: Test plots refer to the following pages.



Modulation Type: 802.11b
CH01

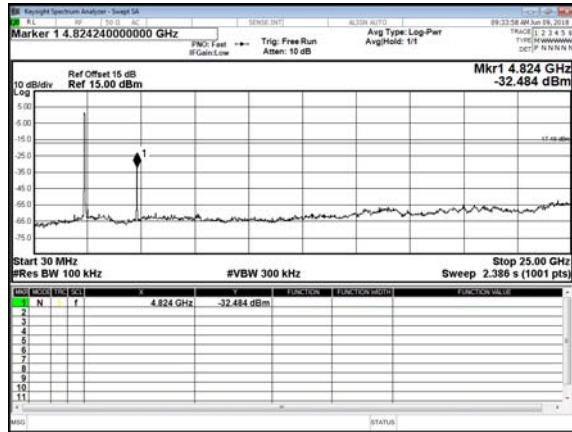
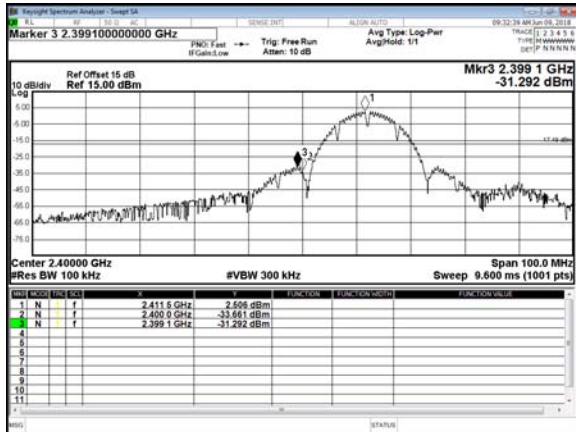

CH06

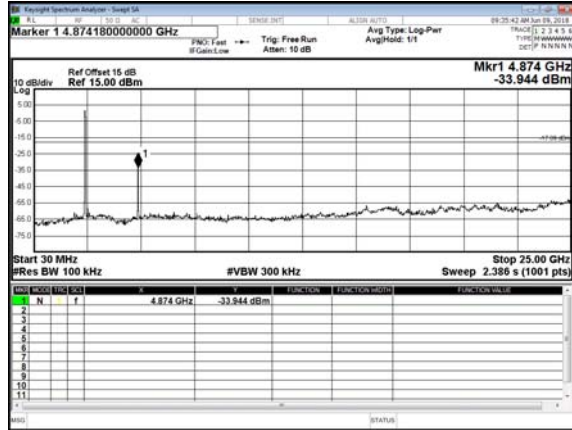
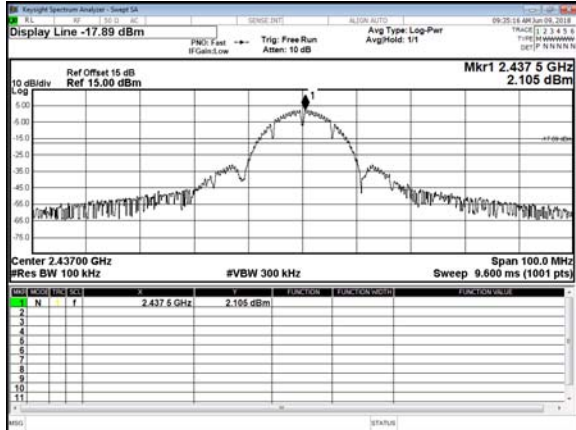

CH11

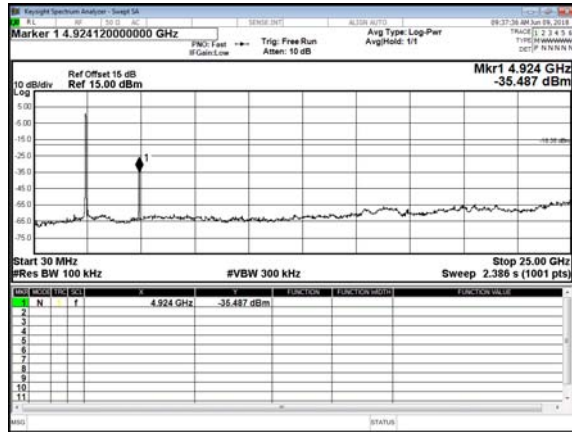



Modulation Type: 802.11g
CH01

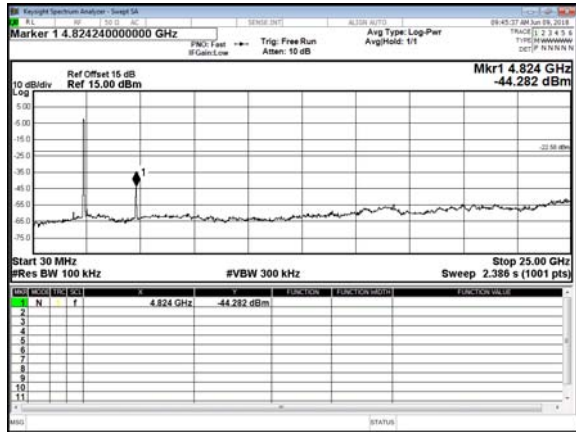

CH06

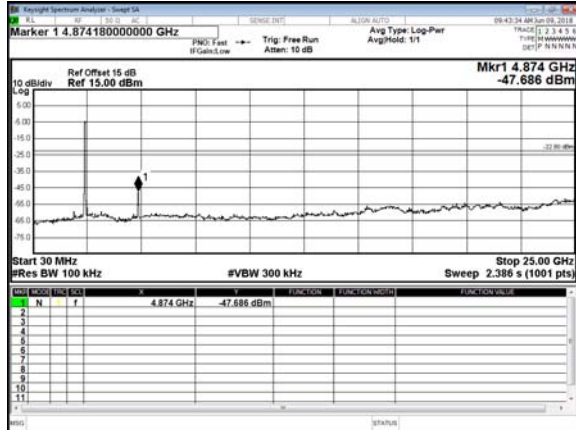

CH11

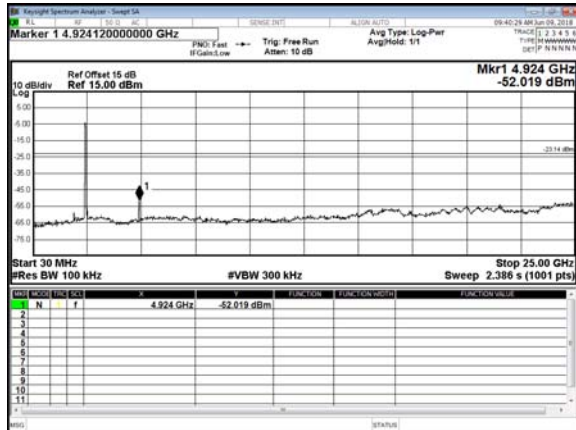
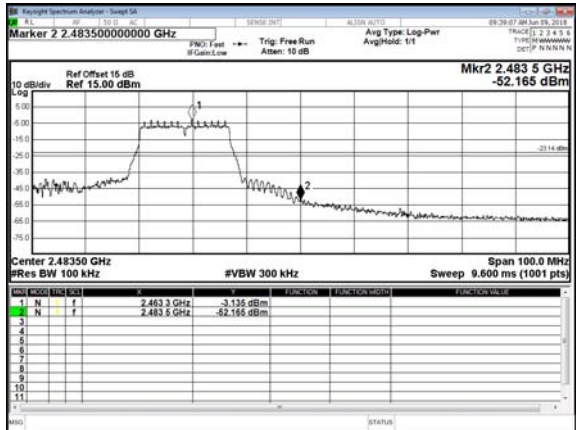



Modulation Type: 802.11n HT20
CH01

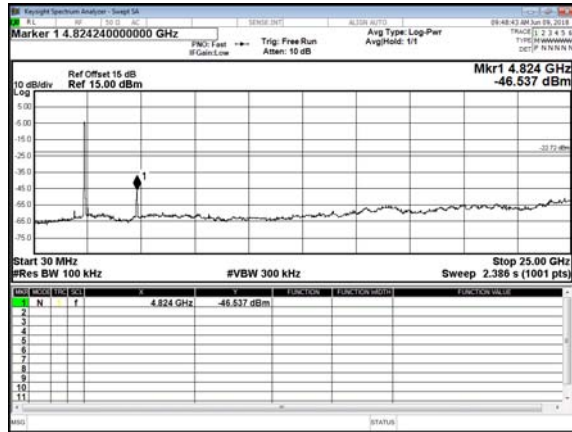

CH06

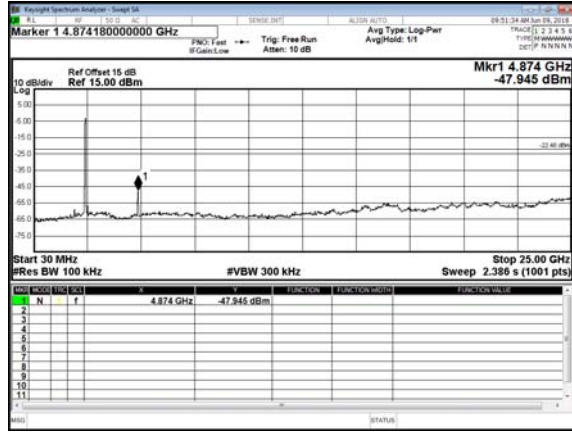

CH11

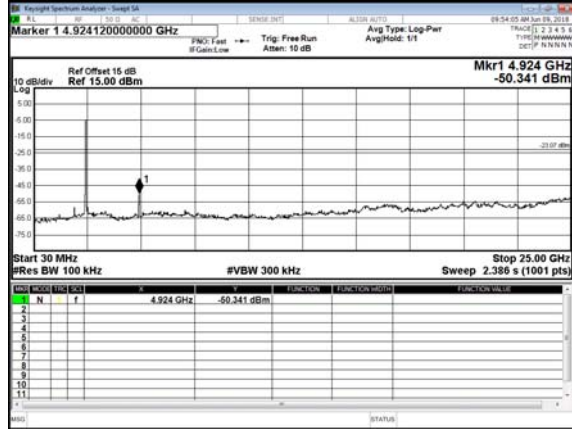



8. 6dB Bandwidth Measurement Data

8.1 Test Limit

The minimum of 6dB Bandwidth Measurement is 0.5 MHz.

8.2 Test Procedures

- a. The transmitter output was connected to the spectrum analyzer.
- b. Set RBW of spectrum analyzer to 100 KHz and VBW to 300 KHz.
- c. Set spectrum analyzer X dB to 6 dB.
- d. Set spectrum analyzer peak detector with maximum hold.

8.3 Test Setup Layout



8.4 Test Result and Data

Test Date: Jun. 08, 2018

Temperature: 24°C

Atmospheric pressure: 1016 hPa

Humidity: 46%

Modulation Type	Channel	Frequency (MHz)	6dB Bandwidth (MHz)
IEEE 802.11b	01	2412	10.06
	06	2437	10.07
	11	2462	10.08
IEEE 802.11g	01	2412	16.41
	06	2437	16.41
	11	2462	16.43
IEEE 802.11n HT20	01	2412	17.66
	06	2437	17.67
	11	2462	17.72



Modulation Type: 802.11b
CH01

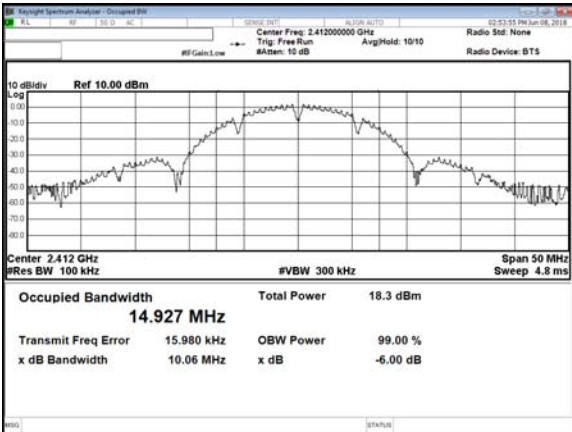

CH06

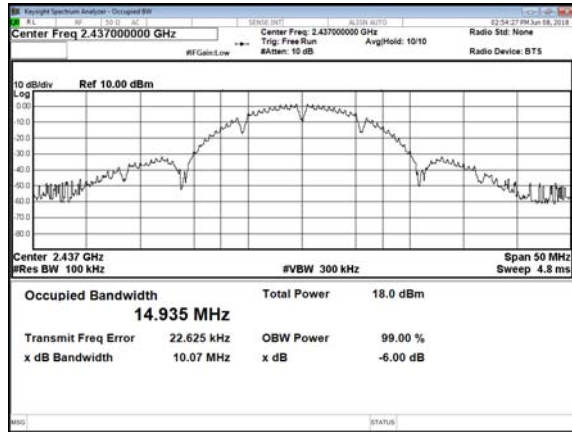

CH11

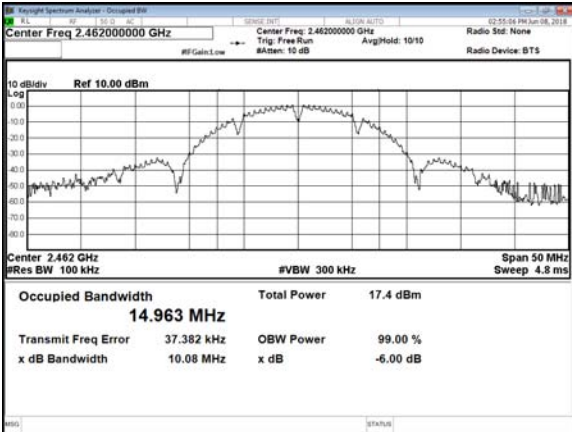

Modulation Type: 802.11g
CH01



CH06

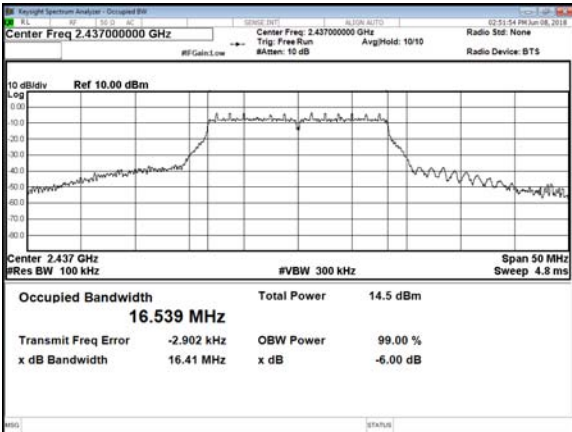

CH11

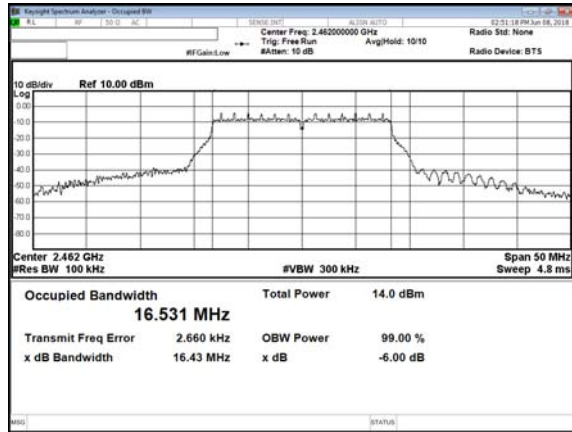



Modulation Type: 802.11n HT20
CH01

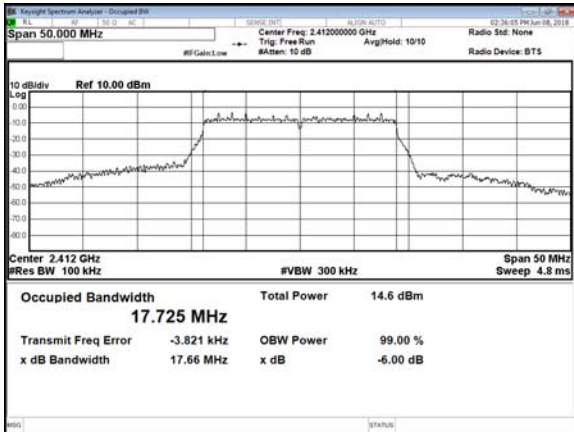

CH06

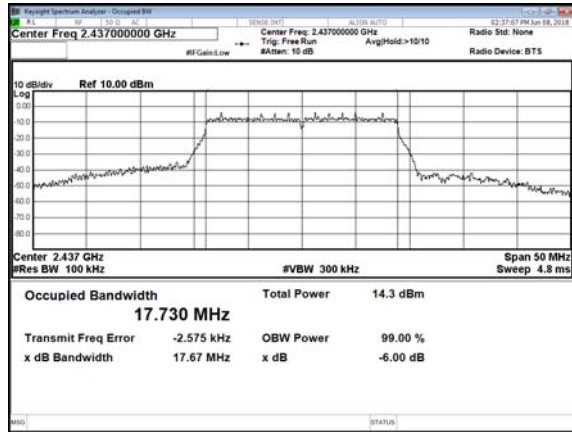

CH11

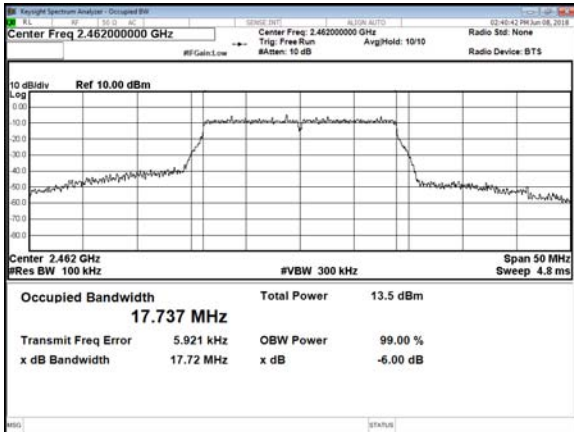



9. Maximum Peak Output Power

9.1 Test Limit

The Maximum Peak Output Power Measurement is 30dBm.

9.2 Test Procedures

Test procedure refers to KDB558074 D01v03r05, section 9.1.2 PKPM1 Peak power meter method.

The antenna port (RF output) of the EUT was connected to the input (RF input) of a power meter. Power was read directly from the meter and cable loss connection was added to the reading to obtain power at the EUT antenna terminal. The EUT Output Power was set to maximum to produce the worse case test result.

9.3 Test Setup Layout

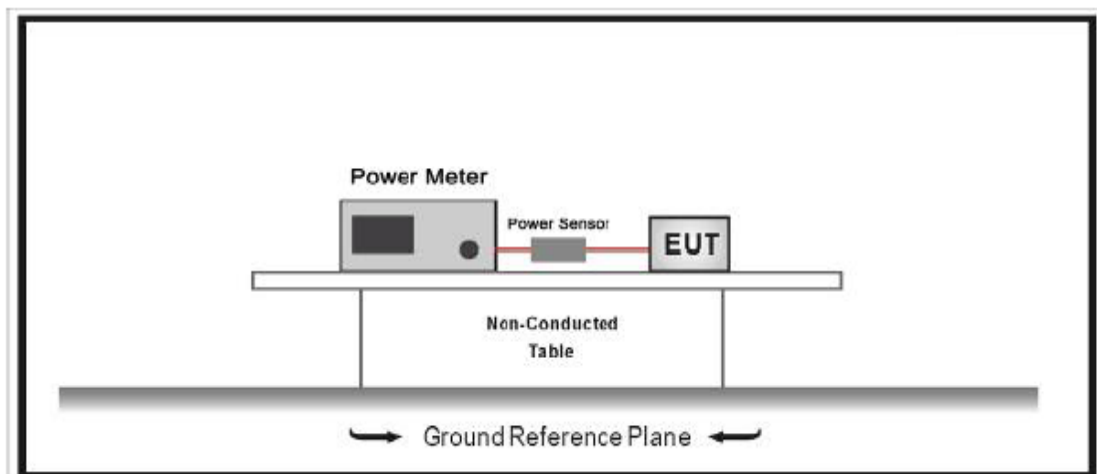



9.4 Test Result and Data

Test Date: Jun. 08, 2018

Temperature: 24°C

Atmospheric pressure: 1016 hPa

Humidity: 46%

Modulation Type	Channel	Frequency (MHz)	Peak Power Output (dBm)	Peak Power Output (mW)
IEEE 802.11b	01	2412	16.97	49.774
	06	2437	16.71	46.881
	11	2462	16.29	42.560
IEEE 802.11g	01	2412	20.25	105.925
	06	2437	20.10	102.329
	11	2462	19.90	97.724
IEEE 802.11n HT20	01	2412	20.74	118.577
	06	2437	20.58	114.288
	11	2462	20.03	100.693



10. Power Spectral Density

10.1 Test Limit

The Maximum of Power Spectral Density Measurement is 8dBm.

10.2 Test Procedures

Test procedure refers to section 10.3 Method AVGPSD-1.

- a) Set instrument center frequency to DTS channel center frequency.
- b) Set span to at least 1.5 times the OBW.
- c) Set RBW to: $3 \text{ kHz} \leq \text{RBW} \leq 100 \text{ kHz}$.
- d) Set VBW $\geq 3 \times \text{RBW}$.
- e) Detector = power averaging (RMS) or sample detector (when RMS not available).
- f) Ensure that the number of measurement points in the sweep $\geq 2 \times \text{span}/\text{RBW}$.
- g) Sweep time = auto couple.
- h) Employ trace averaging (RMS) mode over a minimum of 100 traces.
- j) If measured value exceeds limit, reduce RBW (no less than 3 kHz) and repeat (note that this may require zooming in on the emission of interest and reducing the span in order to meet the minimum measurement point requirement as the RBW is reduced).

10.3 Test Setup Layout

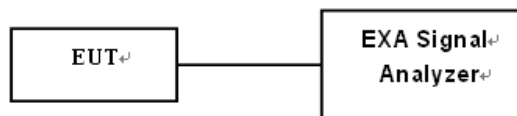



10.4 Test Result and Data

Test Date: Jun. 08, 2018

Temperature: 24°C

Atmospheric pressure: 1014 hPa

Humidity: 47%

Modulation Type	Frequency (MHz)	Power Spectral Density (dBm)
		Antenna
IEEE 802.11b	2412	-14.072
	2437	-13.803
	2462	-13.533
IEEE 802.11g	2412	-19.584
	2437	-19.302
	2462	-19.839
IEEE 802.11n HT20	2412	-19.207
	2437	-19.436
	2462	-19.145



Modulation Type: 802.11b
CH01

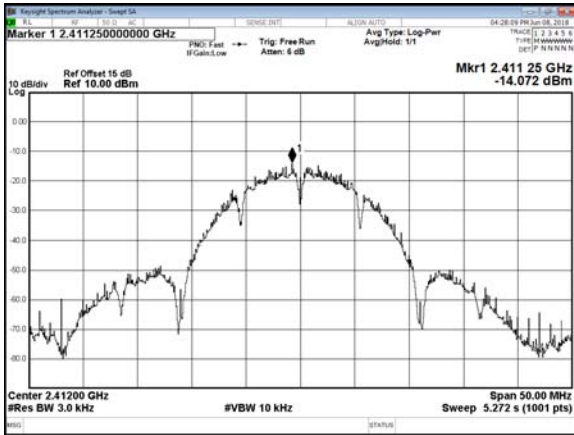

CH06

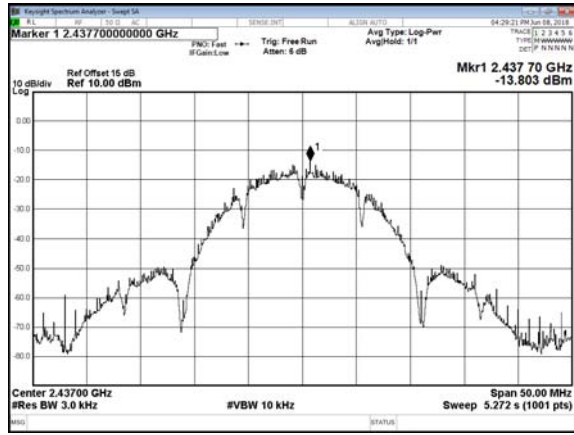

CH11

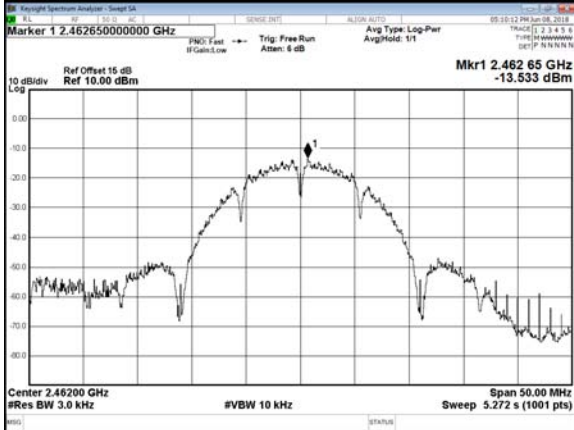

Modulation Type: 802.11g
CH01

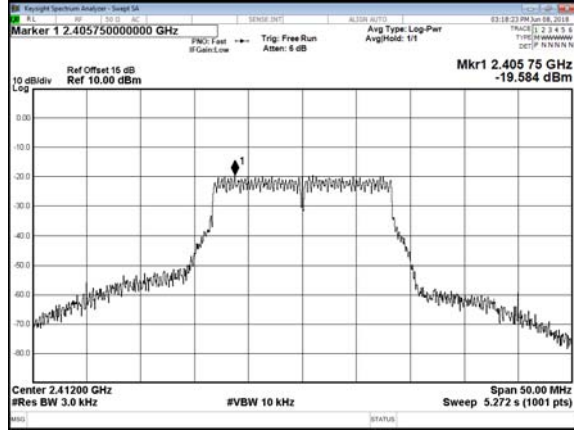

CH06

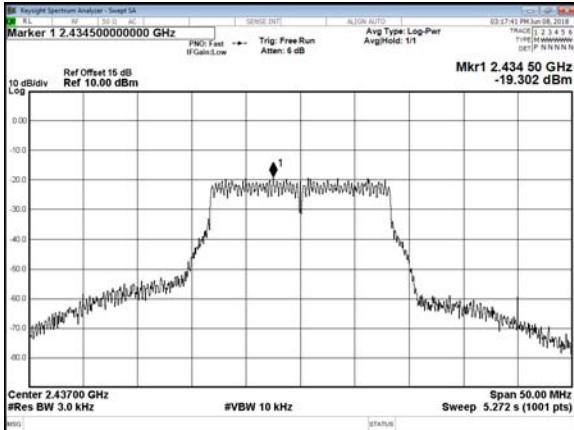

CH11

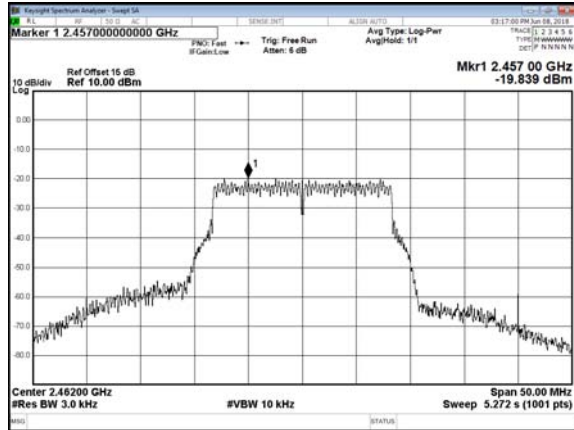



Modulation Type: 802.11n HT20
CH01

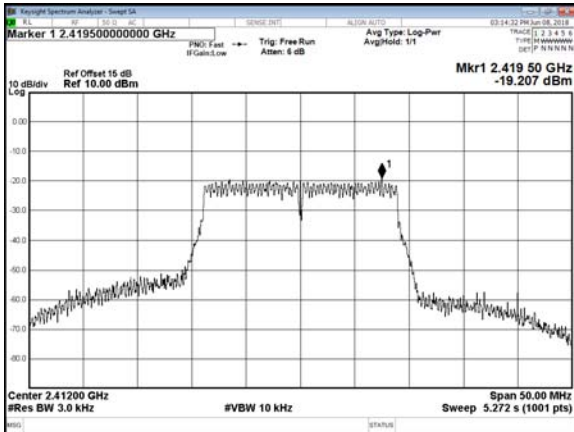

CH06

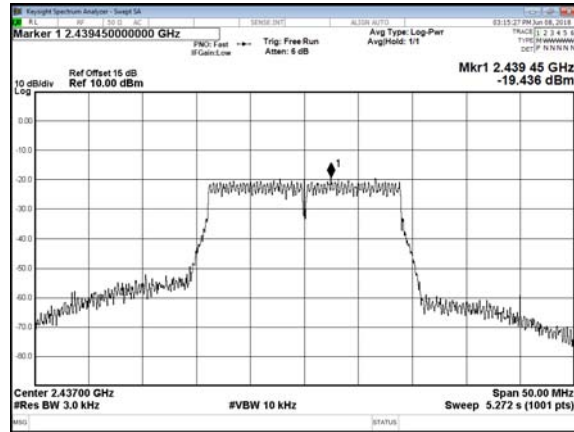

CH11

