



FCC TEST REPORT

**Test report
On Behalf of
Amcrest Technologies LLC
For
Dual Band FM Transceiver
Model No.: BF-F9 V2+**

FCC ID: ZZ2BF-F9V2

Prepared for : Amcrest Technologies LLC
16727 Park Row Dr. Houston, TX 77084

Prepared By : Shenzhen HUAKE Testing Technology Co., Ltd.
1F, B2 Building, Junfeng Zhongcheng Zhizao Innovation Park, Fuhai Street, Bao'an District, Shenzhen City, China

Date of Test: Sept. 29, 2018~Oct. 17, 2018

Date of Report: Nov. 30, 2018

Report Number: HK1810181303E



TEST RESULT CERTIFICATION

Applicant's name : Amcrest Technologies LLC
Address : 16727 Park Row Dr. Houston, TX 77084
Manufacturer's Name : PO FUNG ELECTRONIC(HK) INTERNATIOANL GROUP COMPANY
Address : 3/F FULOK BLDG 131-133 WING LOK ST SHEUNG WAN, Hong Kong

Product description : Dual Band FM Transceiver
Brand Name : BAOFENG
Mode Name : BF-F9 V2+

Standards : FCC Rules and Regulations Part 15B

This publication may be reproduced in whole or in part for non-commercial purposes as long as the Shenzhen HUAKE Testing Technology Co., Ltd. is acknowledged as copyright owner and source of the material. Shenzhen HUAKE Testing Technology Co., Ltd. takes no responsibility for and will not assume liability for damages resulting from the reader's interpretation of the reproduced material due to its placement and context.

Date of Test :
Date (s) of performance of tests : Sept. 29, 2018~Oct. 17, 2018
Date of Issue : Nov. 30, 2018
Test Result : **Pass**

Testing Engineer : 

(Gary Qian)

Technical Manager : 

(Eden Hu)

Authorized Signatory : 

(Jason Zhou)



Revision	Issue Date	Revisions	Revised By
V1.0	Oct. 17, 2018	Initial Issue	Jason Zhou
V1.1	Nov. 23, 2018	Updated P8	Jason Zhou
V1.2	Nov. 30, 2018	Updated Report	Jason Zhou



TABLE OF CONTENTS

1. VERIFICATION OF COMPLIANCE 5

2. PRODUCT INFORMATION 6

3. IDENTIFICATION OF THE RESPONSIBLE TESTING LOCATION 7

4. SUPPORT EQUIPMENT LIST..... 8

5. SYSTEM DESCRIPTION..... 8

6. SUMMARY OF TEST RESULTS 9

7. FCC RADIATED EMISSION TEST 10

 7.1. TEST EQUIPMENT OF RADIATED EMISSION 10

 7.2. LIMITS OF RADIATED EMISSION TEST 10

 7.3 BLOCK DIAGRAM OF RADIATED EMISSION TEST 10

 7.4 PROCEDURE OF RADIATED EMISSION TEST 12

7.5 TEST RESULT OF RADIATED EMISSION TEST 13

8. CONDUCTED EMISSION TEST 15

 8.1 PROVISIONS APPLICABLE 15

 8.2 MEASUREMENT PROCEDURE..... 15

 8.3 TEST SETUP BLOCK DIAGRAM 16

 8.4 TEST RESULT..... 17

9. ANTENNA CONDUCTED POWER FOR RECEIVERS 19

10. SCANNING RECEIVERS AND FREQUENCY CONVERTERS USED WITH SCANNING RECEIVERS... 22

APPENDIX 1 PHOTOGRAPHS OF TEST SETUP 24

APPENDIX 2 PHOTOGRAPHS OF EUT 26



1. VERIFICATION OF COMPLIANCE

Hardware Version	5R-VER20 160113
Software Version	BFS001
Measurement Procedure	ANSI C63.4: 2014
Deviation:	None
Condition of Test Sample	Normal

The test results of this report relate only to the tested sample identified in this report.



2. PRODUCT INFORMATION

The EUT is a Analog Transceiver designed for voice communication. It is designed by way of utilizing the F3E modulation achieves the system operating.

A major technical description of EUT is described as following:

Communication Type	Voice / Tone only
Modulation	FM
RX Frequency Range	Rx:136 MHz -174 MHz, 400MHz -520MHz
Emission Type	F3E
Antenna Designation	Detachable
Antenna Gain	2.15dBi
Power Supply	DC 7.4V 1800mAh, charging with DC 8.4V.
Adapter Parameter	INPUT:AC 100-240V~ 50/60Hz ,0.2A OUTPUT:DC 10V 0.5A
Charger Parameter	INPUT: DC 10V 0.5A OUTPUT:DC 8.4V 0.4A

I/O Port Information (Applicable Not Applicable)

I/O Port of EUT			
I/O Port Type	Q'TY	Cable	Tested with
Microphone	0	0	0
Antenna Connect Port	1	0	1

**3. IDENTIFICATION OF THE RESPONSIBLE TESTING LOCATION**

Site	Shenzhen HUAKE Testing Technology Co., Ltd.
Location	1F, B2 Building, Junfeng Zhongcheng Zhizao Innovation Park, Fuhai Street, Bao'an District, Shenzhen City, China
Designation Number	CN1229
Test Firm Registration Number : 616276	

List Of Test Equipment:

Conducted Emission Shielding Room Test Site (744)					
Equipment	Manufacturer	Model	Serial Number	Cal. Date	Cal. Due
Receiver	R&S	ESCI 7	HKE-010	Dec. 29, 2017	Dec. 28, 2018
LISN	R&S	ENV216	HKE-002	Dec. 29, 2017	Dec. 28, 2018
Conducted test software	Tonscend	TS+ Rev 2.5.0.0	HKE-081	N/A	N/A

TEST EQUIPMENT OF RADIATED EMISSION TEST

Equipment	Manufacturer	Model	S/N	Cal. Date	Cal. Due
Broadband antenna	Schwarzbeck	VULB 9163	HKE-012	Dec. 29, 2017	Dec. 28, 2018
Receiver	R&S	ESCI 7	HKE-010	Dec. 29, 2017	Dec. 28, 2018
Preamplifier	Schwarzbeck	BBV 9743	HKE-006	Dec. 29, 2017	Dec. 28, 2018
Position controller	Taiwan MF	MF7802	HKE-011	Dec. 29, 2017	Dec. 28, 2018
Horn antenna	Schwarzbeck	9120D	HKE-013	Dec. 29, 2017	Dec. 28, 2018
Vector Analyzer	Agilent	E4440A	HKE-101	Mar.01,2018	Feb.28,2019
RF Communication Test Set	HP	HP8920B	HKE-089	June 12, 2018	June 11, 2019



4. SUPPORT EQUIPMENT LIST

Device Type	Manufacturer	Model Name	Serial No.	Data Cable	Power Cable
--	--	--	--	--	--

5. SYSTEM DESCRIPTION

EUT test procedure:

1. Connect EUT and peripheral devices.
2. Power on the EUT, the EUT begins to work.
3. Make sure the EUT normal working.

EMC TEST MODES

No.	TEST MODES
1	Scanning mode
2	Scanning stopped/Receiving at low channel of 136 MHz -174 MHz
3	Scanning stopped/Receiving at middle channel of 136 MHz -174 MHz
4	Scanning stopped/Receiving at high channel of 136 MHz -174 MHz
5	Scanning stopped/Receiving at low channel of 400 MHz -520 MHz
6	Scanning stopped/Receiving at middle channel of 400 MHz -520 MHz
7	Scanning stopped/Receiving at high channel of 400 MHz -520 MHz

Note: Only the result of the worst case was recorded in the report.



6. SUMMARY OF TEST RESULTS

FCC Rules	Description Of Test	Result
§15.107	Conduction Emission	Compliant
§15.109	Radiated Emission	Compliant
§15.111	Antenna Conducted Power for receivers	Compliant



7. FCC RADIATED EMISSION TEST

7.1. TEST EQUIPMENT OF RADIATED EMISSION

7.2. LIMITS OF RADIATED EMISSION TEST

Frequency (MHz)	Distance (m)	Maximum Field Strength Limit (dBuV/m/ Q.P.)
30~88	3	41.0
88~216	3	45.0
216~960	3	48.0
960~2000	3	53.5

**Note: The lower limit shall apply at the transition frequency. Because the EUT RX frequency range up to 480 MHz, so the upper the frequency range up to 2 GHz.

7.3 BLOCK DIAGRAM OF RADIATED EMISSION TEST

RADIATED EMISSION TEST SETUP 30MHz-1000MHz

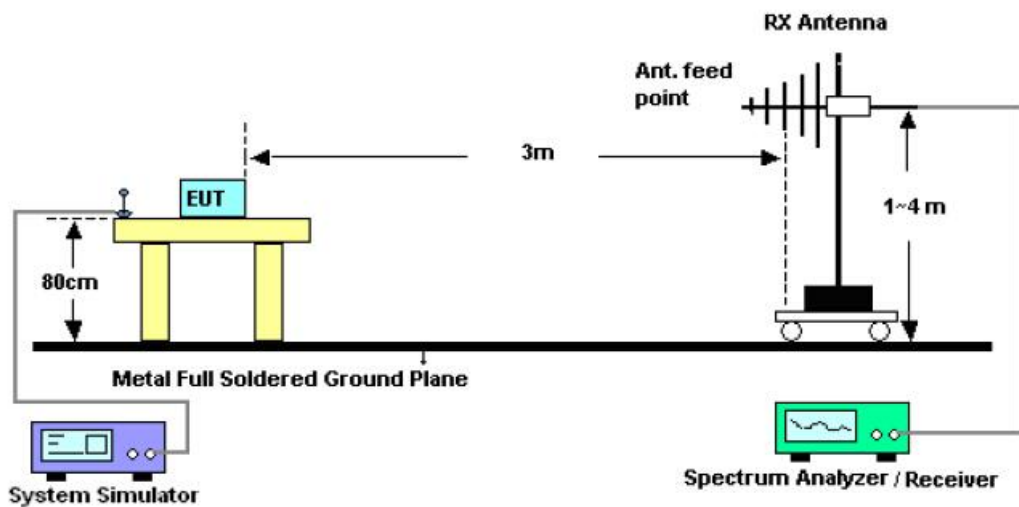



RADIATED EMISSION TEST SETUP ABOVE 1000MHz

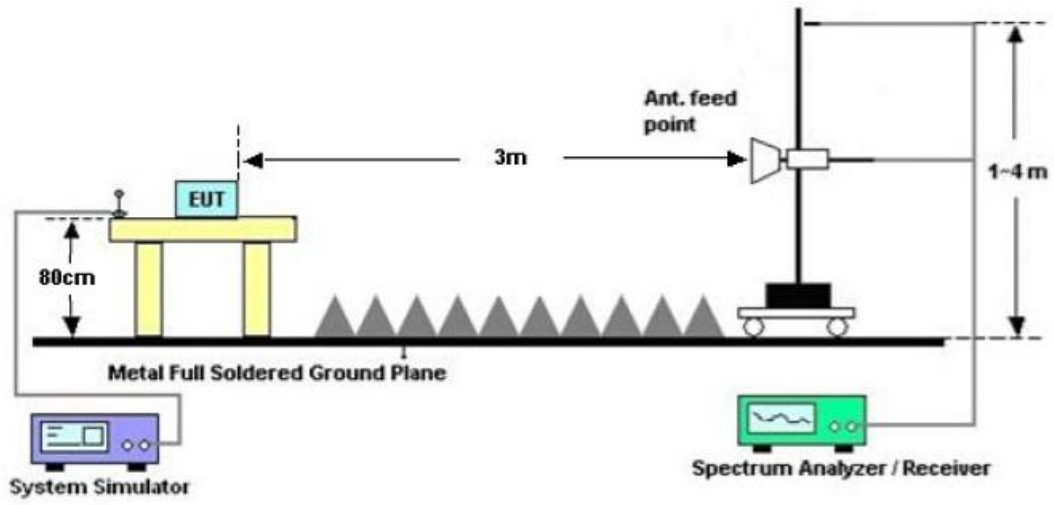



7.4 PROCEDURE OF RADIATED EMISSION TEST

- 1) The equipment was set up as per the test configuration to simulate typical actual usage per the user's manual. When the EUT is a tabletop system, a wooden turntable with a height of 0.8 meters is used which is placed on the ground plane as per ANSI C63.4 (see Test Facility for the dimensions of the ground plane used). When the EUT is floor-standing equipment, it is placed on the ground plane which has a 3-12 mm non-conductive covering to insulate the EUT from the ground plane.
- 2) Support equipment, if needed, was placed as per ANSI C63.4.
- 3) All I/O cables were positioned to simulate typical actual usage as per ANSI C63.4.
- 4) The EUT received power by AC 120V/60Hz.
- 5) The antenna was placed at 3 meter away from the EUT as stated in FCC Part 15. The antenna connected to the Analyzer via a cable and at times a pre-amplifier would be used.
- 6) The Analyzer / Receiver quickly scanned from 30MHz to 1000MHz. The EUT test program was started. Emissions were scanned and measured rotating the EUT to 360 degrees and positioning the antenna 1 to 4 meters above the ground plane, in both the vertical and the horizontal polarization, to maximize the emission reading level.
- 7) The test mode(s) were scanned during the test:
- 8) Recorded at least the six highest emissions. Emission frequency, amplitude, antenna position, polarization and turntable position were recorded into a computer in which correction factors were used to calculate the emission level and compare reading to the applicable limit and Q.P./Peak reading is presented. For emissions below 1GHz, use 120KHz RBW and $VBW \geq 3RBW$ for QP reading.
- 9) For emissions above 1GHz, use 1MHz RBW and 3MHz VBW for peak reading. Then 1MHz RBW and 10Hz VBW for average reading in spectrum analyzer.
- 10) When the radiated emissions limits are expressed in terms of the average value of the emissions, and pulsed operation is employed, the measurement field strength shall be determined by averaging over one complete pulse train, including blanking intervals, as long as the pulse train does not exceed 0.1 seconds. As an alternative (provided the transmitter operates for longer than 0.1 seconds) or in cases where the pulse train exceeds 0.1 seconds, the measured field strength shall be determined from the average absolute voltage during a 0.1 second interval during which the field strength is at its maximum values.
- 11) If the emissions level of the EUT in peak mode was 3 dB lower than the average limit specified, then testing will be stopped and peak values of EUT will be reported, otherwise, the emissions which do not have 3 dB margin will be repeated one by one using the quasi-peak method for below 1GHz.
- 12) For testing above 1GHz, the emissions level of the EUT in peak mode was lower than average limit (that means the emissions level in peak mode also complies with the limit in average mode), then testing will be stopped and peak values of EUT will be reported, otherwise, the emissions will be measured in average mode again and reported.
- 13) In case the emission is lower than 30MHz, loop antenna has to be used for measurement and the recorded data should be QP measured by receiver. High - Low scan is not required in this case.
- 14) The test data of the worst case condition (mode 1) was reported on the following Data page



7.5 TEST RESULT OF RADIATED EMISSION TEST

Radiated Emission Test –Horizontal -3m Below 1G

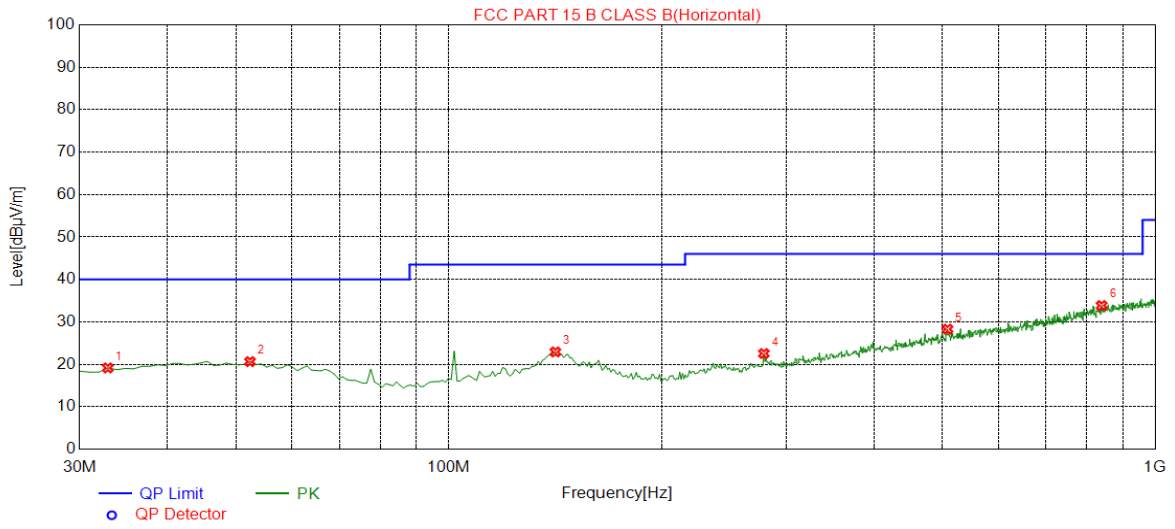

Suspected Data List								
NO.	Freq. [MHz]	Level [dBµV/m]	Factor [dB]	Limit [dBµV/m]	Margin [dB]	Height [cm]	Angle [°]	Polarity
1	32.9100	19.15	13.10	40.00	20.85	200	150	Horizontal
2	52.3100	20.64	14.16	40.00	19.36	100	138	Horizontal
3	141.550	22.92	14.24	43.50	20.58	200	95	Horizontal
4	279.290	22.55	15.30	46.00	23.45	150	3	Horizontal
5	508.210	28.29	21.07	46.00	17.71	100	129	Horizontal
6	839.950	33.84	27.39	46.00	12.16	150	298	Horizontal

RESULT: PASS



Radiated Emission Test –Vertical -3m Below 1G

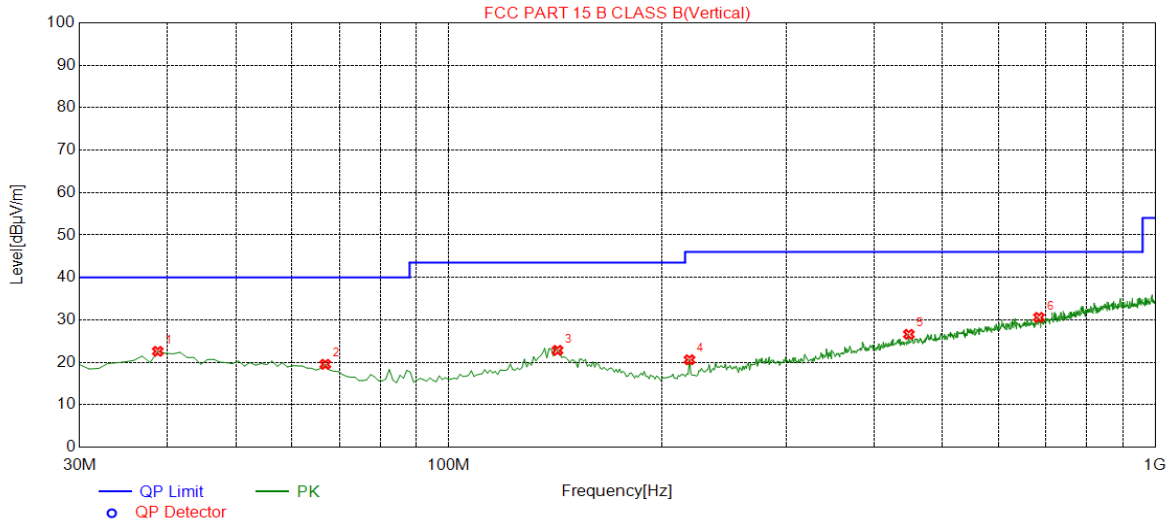

Suspected Data List								
NO.	Freq. [MHz]	Level [dBµV/m]	Factor [dB]	Limit [dBµV/m]	Margin [dB]	Height [cm]	Angle [°]	Polarity
1	38.7300	22.59	14.34	40.00	17.41	100	284	Vertical
2	66.8600	19.53	12.37	40.00	20.47	150	224	Vertical
3	142.520	22.82	14.24	43.50	20.68	100	114	Vertical
4	219.150	20.60	12.45	46.00	25.40	200	3	Vertical
5	448.070	26.60	19.74	46.00	19.40	100	126	Vertical
6	684.750	30.58	24.21	46.00	15.42	150	16	Vertical

RESULT: PASS

- Note:**
1. Factor=Antenna Factor + Cable loss - Amplifier gain, Margin=Measurement-Limit.
 2. The “Factor” value can be calculated automatically by software of measurement system.
 3. Emissions range from 1GHz to 2GHz have 20dB margin. No recording in the test report.
 4. Only the data of the worst case would be record in this test report.



8. CONDUCTED EMISSION TEST

8.1 PROVISIONS APPLICABLE

For an intentional radiator that is designed to be connected to the public utility (AC) power line, the radio frequency voltage that is conducted back onto the AC power line on any frequencies within the band 150 KHz to 30 MHz shall not exceed the limits in the following table, as measured using a 50uH/50 ohms line impedance stabilization network (LISN). Compliance with the provisions of this paragraph shall be based on the measurement of the radio frequency voltage between each power line and ground at the power terminal. The lower limit applies at the boundary between the frequencies ranges.

Frequency of Emission (MHz)	Conducted Limit(dBuV)	
	Quasi-Peak	Average
0.15 – 0.5	66 to 56 *	56 to 46 *
0.5 – 5	56	46
5 – 30	60	50

* Decreases with the logarithm of the frequency.

8.2 MEASUREMENT PROCEDURE

- (1) The equipment was set up as per the test configuration to simulate typical actual usage per the user's manual. When the EUT is a tabletop system, a wooden table with a height of 0.8 meters is used and is placed on the ground plane as per ANSI C63.4 (see Test Facility for the dimensions of the ground plane used). When the EUT is a floor-standing equipment, it is placed on the ground plane which has a 3-12 mm non-conductive covering to insulate the EUT from the ground plane.
- (2) Support equipment, if needed, was placed as per ANSI C63.4.
- (3) All I/O cables were positioned to simulate typical actual usage as per ANSI C63.4.
- (4) The EUT received AC 120V/60Hz power through a Line Impedance Stabilization Network (LISN) which supplied power source and was grounded to the ground plane.
- (5) All support equipments received AC power from a second LISN, if any.
- (6) The EUT test program was started. Emissions were measured on each current carrying line of the EUT using a spectrum Analyzer / Receiver connected to the LISN powering the EUT. The LISN has two monitoring points: Line 1 (Hot Side) and Line 2 (Neutral Side). Two scans were taken: one with Line 1 connected to Analyzer / Receiver and Line 2 connected to a 50 ohm load; the second scan had Line 1 connected to a 50 ohm load and Line 2 connected to the Analyzer / Receiver.
- (7) Analyzer / Receiver scanned from 150 KHz to 30MHz for emissions in each of the test modes.

During the above scans, the emissions were maximized by cable manipulation.



8.3 TEST SETUP BLOCK DIAGRAM

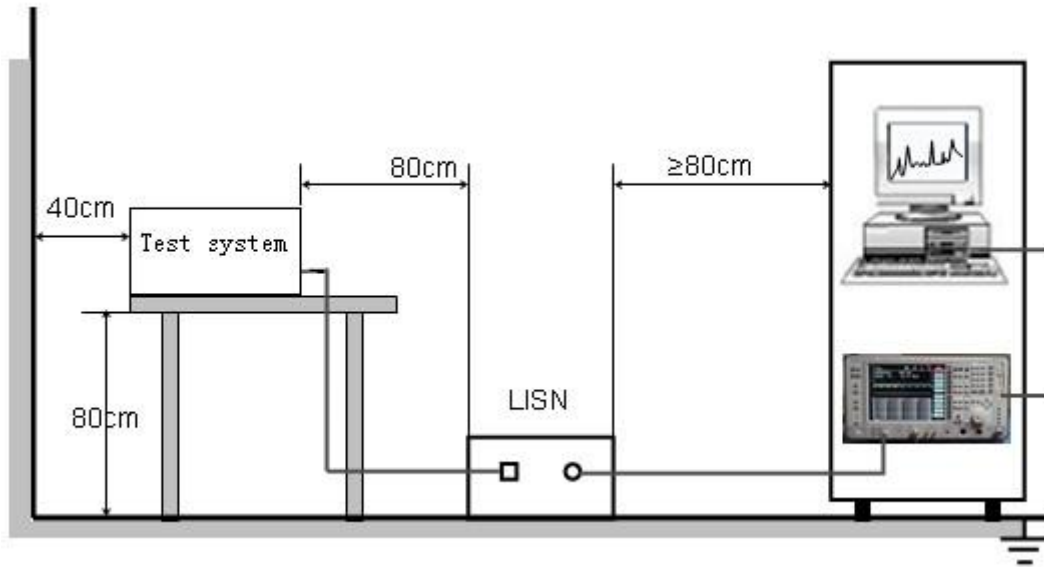



8.4 TEST RESULT

CONDUCTED EMISSION TEST – LINE L

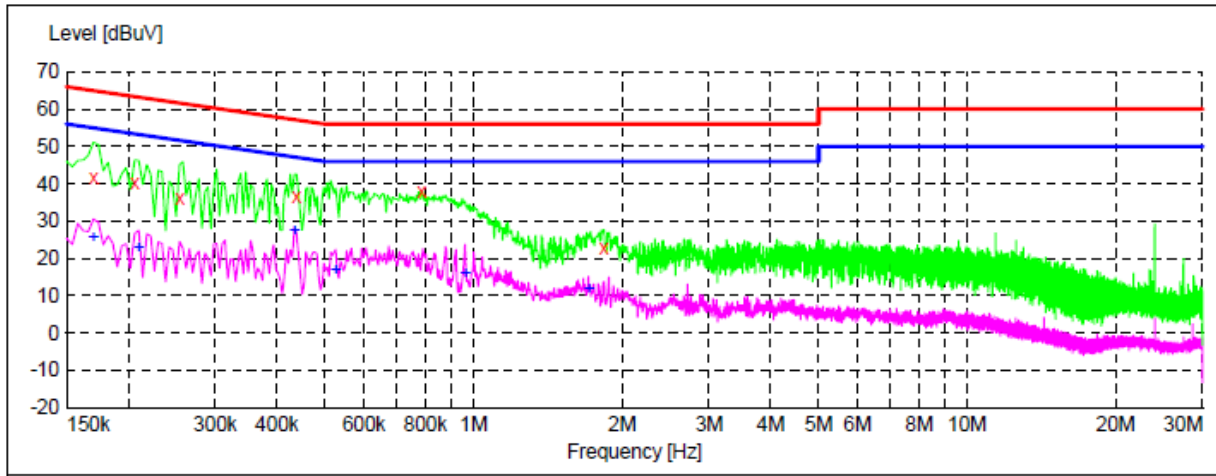

MEASUREMENT RESULT: "TEST_fin"

2018/10/16 15:49

Frequency MHz	Level dBuV	Transd dB	Limit dBuV	Margin dB	Detector	Line	PE
0.170000	41.80	11.4	65	23.2	QP	L1	FLO
0.206000	40.40	11.4	63	23.0	QP	L1	FLO
0.254000	36.10	11.3	62	25.5	QP	L1	FLO
0.438000	36.40	11.4	57	20.7	QP	L1	FLO
0.786000	37.90	11.4	56	18.1	QP	L1	FLO
1.838000	22.90	11.3	56	33.1	QP	L1	FLO

MEASUREMENT RESULT: "TEST_fin2"

2018/10/16 15:49

Frequency MHz	Level dBuV	Transd dB	Limit dBuV	Margin dB	Detector	Line	PE
0.170000	25.70	11.4	55	29.3	AV	L1	FLO
0.210000	22.60	11.4	53	30.6	AV	L1	FLO
0.434000	27.50	11.4	47	19.7	AV	L1	FLO
0.526000	16.70	11.4	46	29.3	AV	L1	FLO
0.962000	15.80	11.3	46	30.2	AV	L1	FLO
1.710000	11.90	11.3	46	34.1	AV	L1	FLO

RESULT: PASS



CONDUCTED EMISSION TEST – LINE N

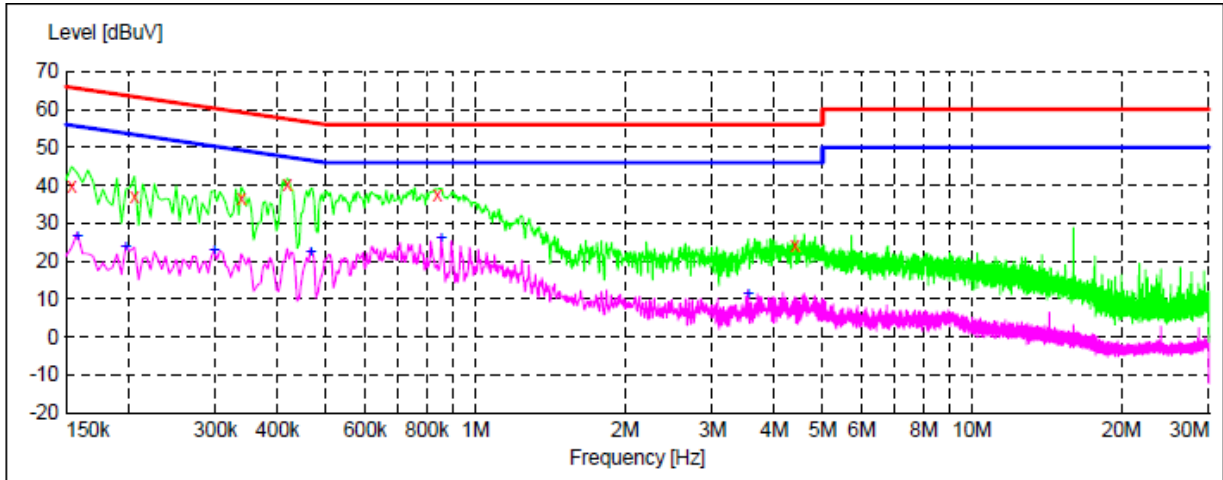

MEASUREMENT RESULT: "TEST_fin"

2018/10/16 16:06

Frequency MHz	Level dBuV	Transd dB	Limit dBuV	Margin dB	Detector	Line	PE
0.154000	39.60	11.4	66	26.2	QP	N	FLO
0.206000	37.20	11.4	63	26.2	QP	N	FLO
0.338000	36.70	11.3	59	22.6	QP	N	FLO
0.418000	40.30	11.4	58	17.2	QP	N	FLO
0.838000	37.40	11.3	56	18.6	QP	N	FLO
4.394000	24.30	11.4	56	31.7	QP	N	FLO

MEASUREMENT RESULT: "TEST_fin2"

2018/10/16 16:07

Frequency MHz	Level dBuV	Transd dB	Limit dBuV	Margin dB	Detector	Line	PE
0.158000	26.50	11.4	56	29.1	AV	N	FLO
0.198000	23.60	11.4	54	30.1	AV	N	FLO
0.298000	22.80	11.3	50	27.5	AV	N	FLO
0.466000	22.30	11.4	47	24.3	AV	N	FLO
0.854000	25.90	11.3	46	20.1	AV	N	FLO
3.542000	11.30	11.4	46	34.7	AV	N	FLO

RESULT: PASS



9. ANTENNA CONDUCTED POWER FOR RECEIVERS

LIMIT

The antenna conducted power of the receiver as defined in §15.111 shall not exceed the values given in the following tables

Frequency Range	9 KHz to 2GHz
Limit	2.0 nW (-57 dBm)

TEST CONFIGURATION

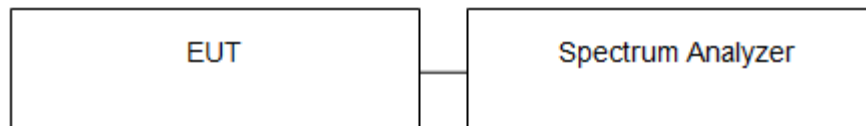

TEST PROCEDURE

1. The receiver antenna terminal connected to a spectrum analyzer.
2. The test data of the worst case condition (mode 1) was reported on the following Data page.



TEST RESULTS

Conducted Measurement (9 KHz to 150 KHz)

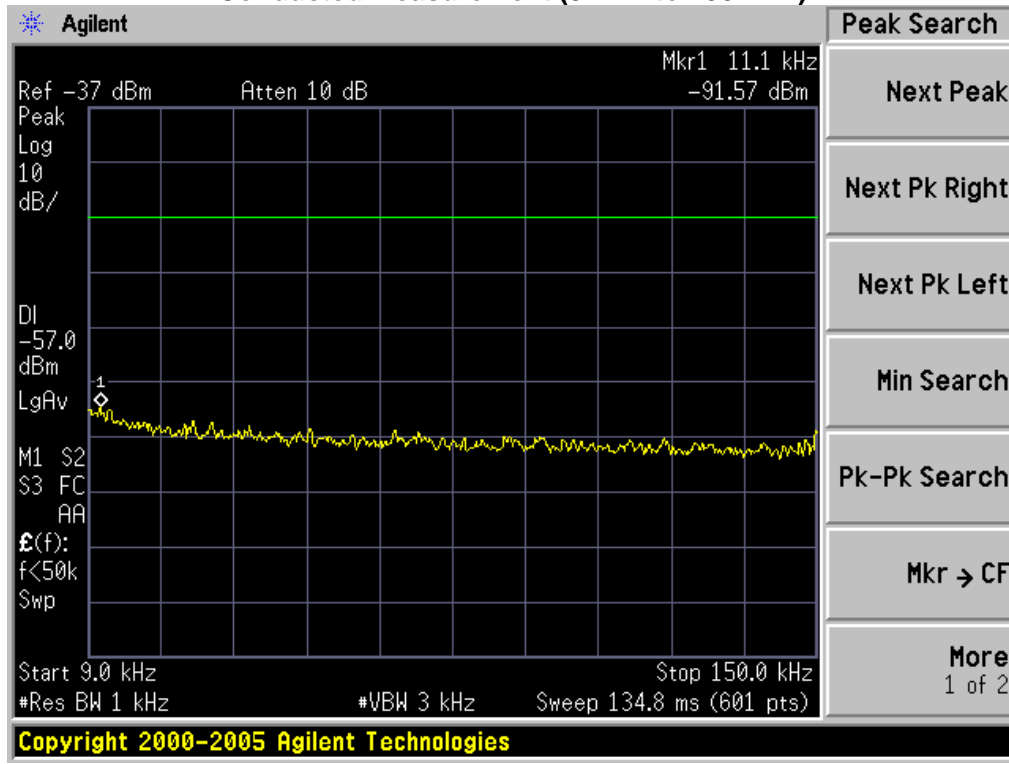

Conducted Measurement (150 KHz to 30MHz)

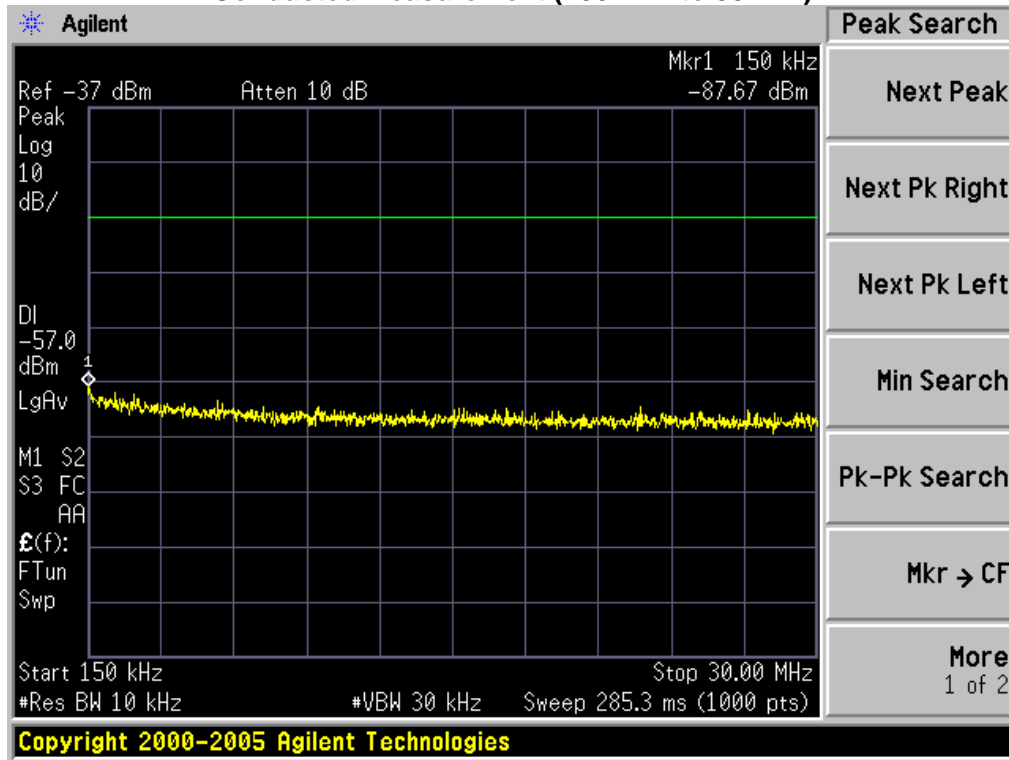



10. SCANNING RECEIVERS AND FREQUENCY CONVERTERS USED WITH SCANNING RECEIVERS.

LIMIT

Except as provided in paragraph (c) of this section, scanning receivers shall reject any signals from the Cellular Radiotelephone Service frequency bands that are 38 dB or lower based upon a 12 dB SINAD measurement, which is considered the threshold where a signal can be clearly discerned from any interference that may be present.

TEST CONFIGURATION

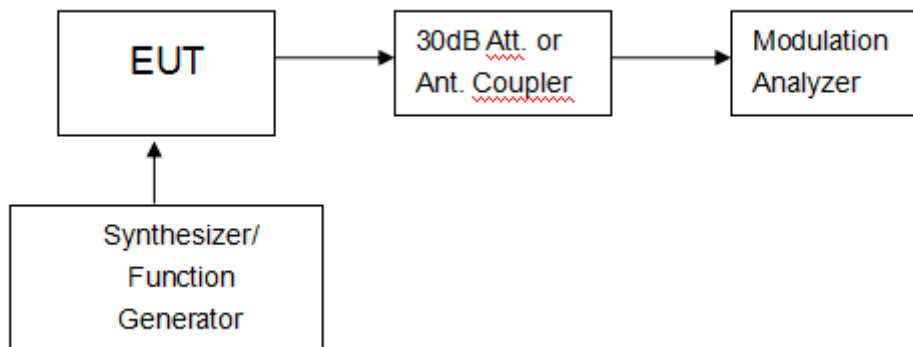

TEST PROCEDURE

Please review the FCC Part 15.121 b section requirements to meet the testing process

TEST RESULTS

VHF:

Frequency Range(MHz)	Channel	Measurement Result (dB)	Limit(dB)	Result
136-174	Bottom	49	> 38	Pass
136-174	Middle	47	> 38	Pass
136-174	Top	52	> 38	Pass

**UHF:**

Frequency Range(MHz)	Channel	Measurement Result (dB)	Limit(dB)	Result
400-520	Bottom	46	> 38	Pass
400-520	Middle	43	> 38	Pass
400-520	Top	49	> 38	Pass

Note:1.This device meets the requirements of FCC PART 15.121.b

2.The test report only shows the worst test results



APPENDIX 1 PHOTOGRAPHS OF TEST SETUP CONDUCTED EMISSION TEST SETUP

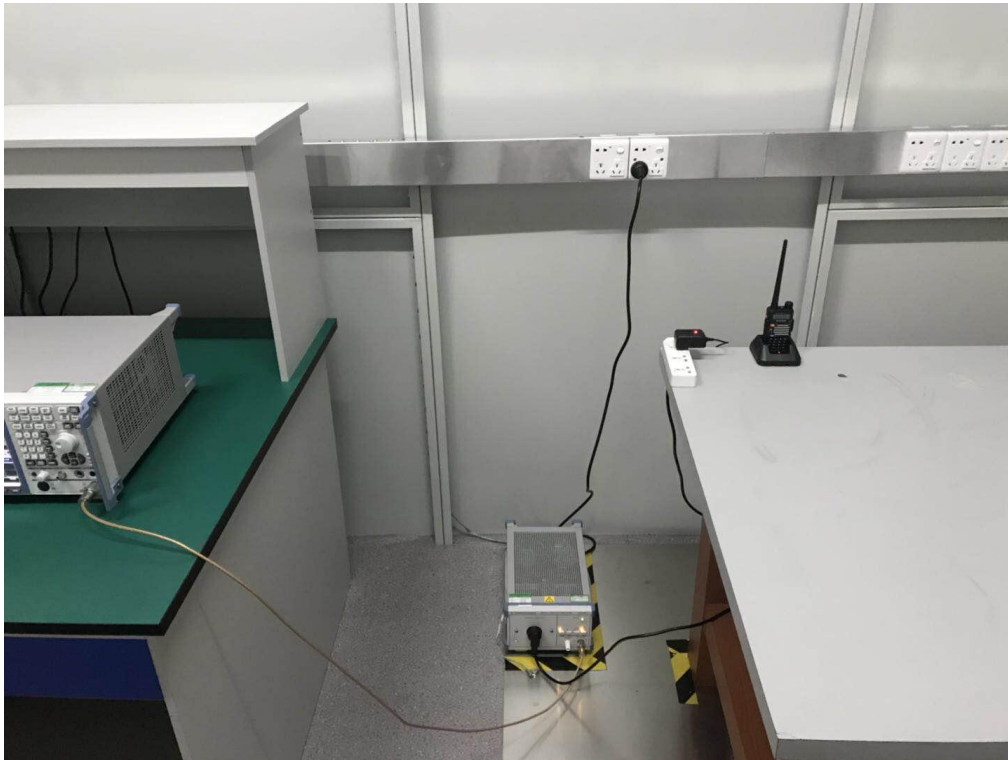

RADIATED EMISSION TEST SETUP

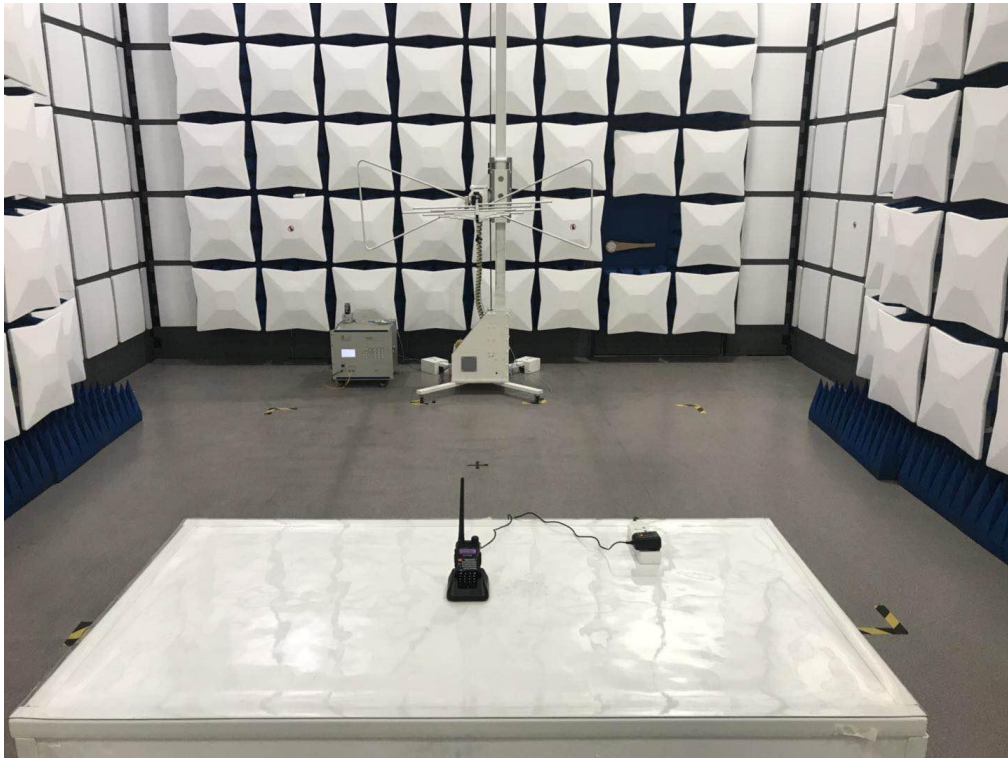



RADIATED EMISSION ABOVE 1G TEST SETUP

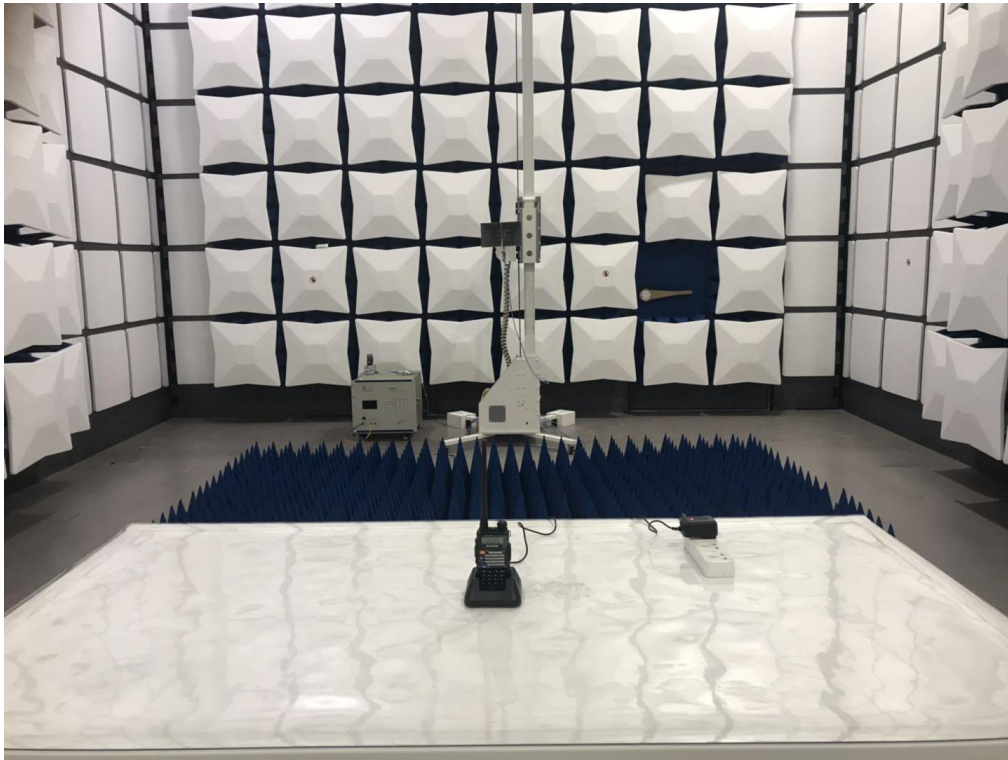



APPENDIX 2 PHOTOGRAPHS OF EUT TOTAL VIEW OF EUT



TOP VIEW OF EUT





BOTTOM VIEW OF EUT



FRONT VIEW OF EUT





BACK VIEW OF EUT



LEFT VIEW OF EUT





RIGHT VIEW OF EUT



OPEN VIEW-1 OF EUT





OPEN VIEW-2 OF EUT



OPEN VIEW-3 OF EUT

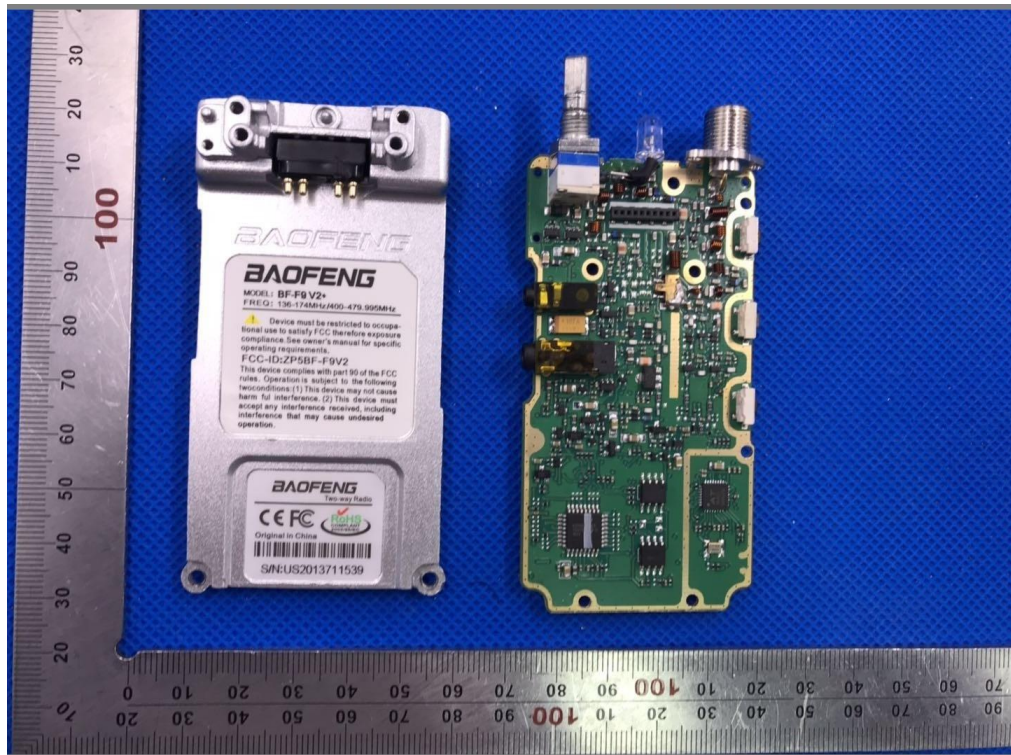



INTERNAL VIEW-1 OF EUT

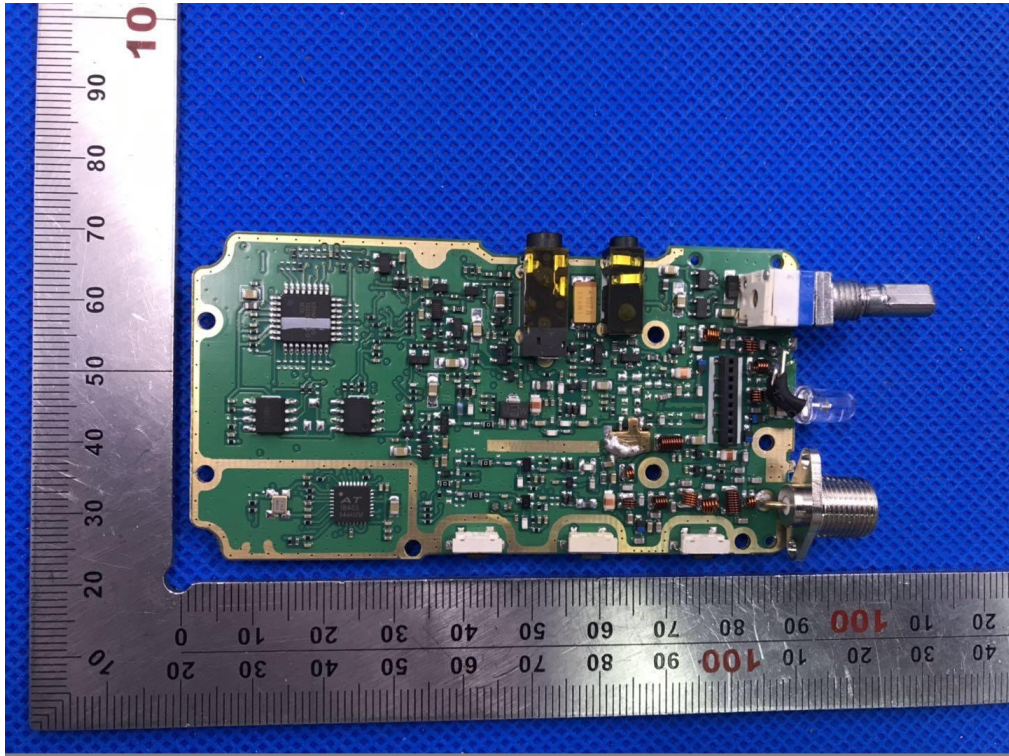

INTERNAL VIEW-2 OF EUT

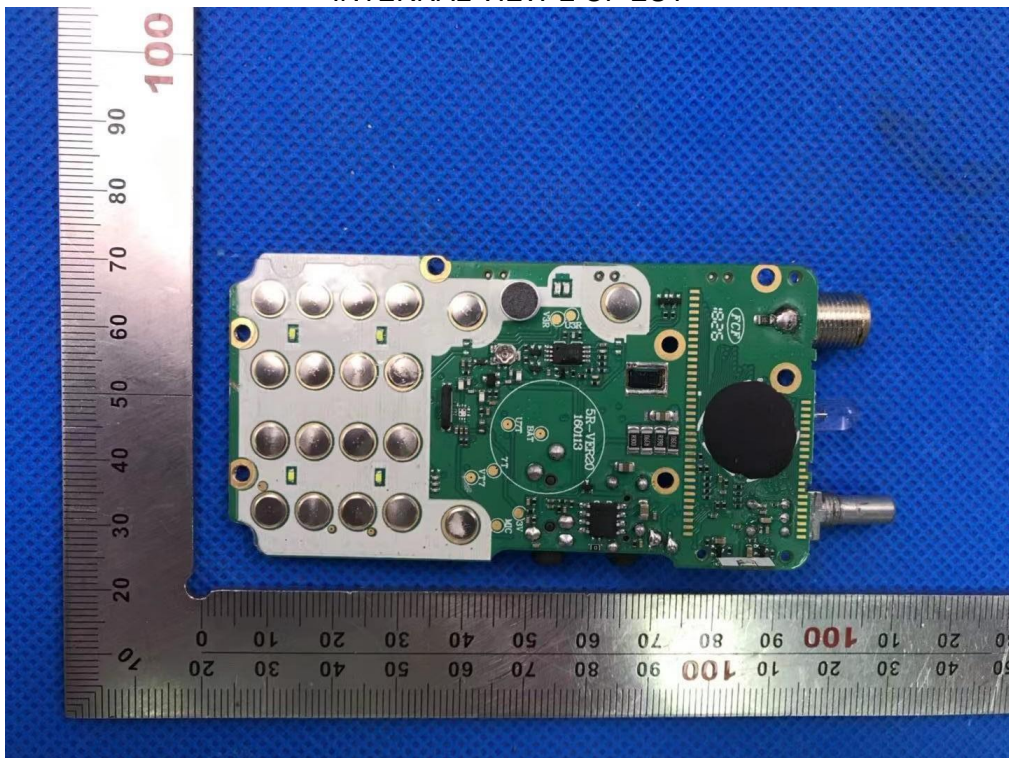



INTERNAL VIEW-3 OF EUT

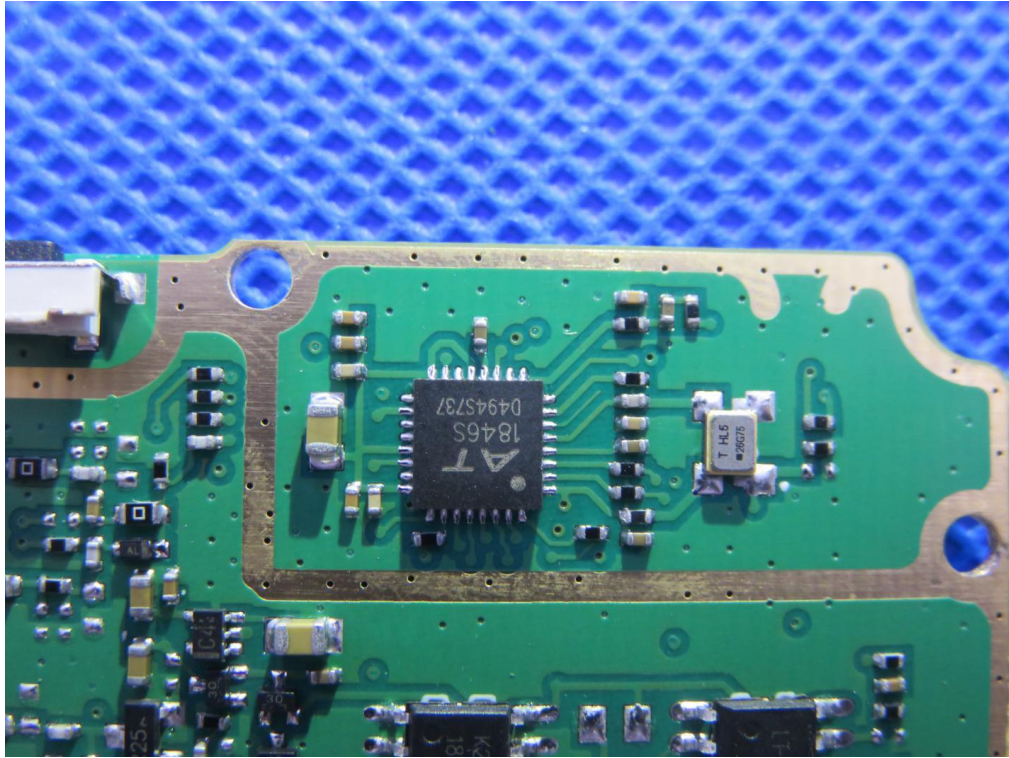

INTERNAL VIEW-4 OF EUT

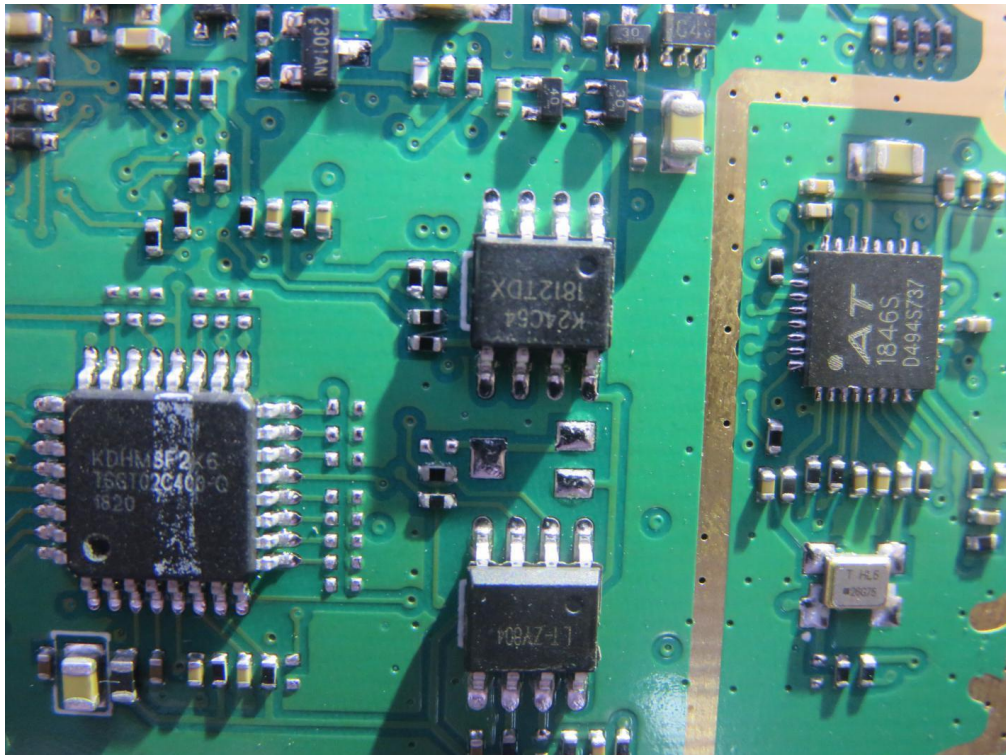

----END OF REPORT----