



No. 1 Workshop, M-10, Middle section, Science & Technology Park, Nanshan District, Shenzhen, Guangdong, China 518057

Telephone: +86 (0) 755 2601 2053
Fax: +86 (0) 755 2671 0594
Email: ee.shenzhen@sgs.com

Report No.: SZEM120500293001
Page: 1 of 17

FCC REPORT

Application No.: SZEM1205002930RF
Applicant: 3M Cogent, Inc
Manufacturer: Cogent Systems (Shenzhen), Inc
Factory: Cogent Systems (Shenzhen), Inc
Product Name: Mini-Gate, Normal CPU, Philips card reader, standard version
Model No.(EUT): ACD100P-CS
Operation Frequency: 13.56MHz
FCC ID: ZYFACD100P-CS
Standards: 47 CFR Part 15, Subpart C (2011)
Date of Receipt: 2012-05-30
Date of Test: 2012-06-06 to 2012-09-04
Date of Issue: 2012-09-28

Test Result :	PASS *
----------------------	---------------

* In the configuration tested, the EUT complied with the standards specified above.

Authorized Signature:



Jack Zhang
EMC Laboratory Manager

The manufacturer should ensure that all products in series production are in conformity with the product sample detailed in this report. If the product in this report is used in any configuration other than that detailed in the report, the manufacturer must ensure the new system complies with all relevant standards. Any mention of SGS International Electrical Approvals or testing done by SGS International Electrical Approvals in connection with, distribution or use of the product described in this report must be approved by SGS International Electrical Approvals in writing.

The report must not be used by the client to claim product certification, approval, or endorsement by NVLAP, NIST, or any agency of the federal government. All test results in this report can be traceable to National or International Standards.

"This document is issued by the Company subject to its General Conditions of Service printed overleaf, available on request or accessible at www.sgs.com/terms_and_conditions.htm and, for electronic format documents, subject to Terms and Conditions for Electronic Documents at www.sgs.com/terms_e-document.htm. Attention is drawn to the limitation of liability, indemnification and jurisdiction issues defined therein. Any holder of this document is advised that information contained hereon reflects the Company's findings at the time of its intervention only and within the limits of Client's instructions, if any. The Company's sole responsibility is to its Client and this document does not exonerate parties to a transaction from exercising all their rights and obligations under the transaction documents. This document cannot be reproduced except in full, without prior written approval of the Company. Any unauthorized alteration, forgery or falsification of the content or appearance of this document is unlawful and offenders may be prosecuted to the fullest extent of the law. Unless otherwise stated the results shown in this test report refer only to the sample(s) tested and such sample(s) are retained for 90 days only."



2 Contents

	Page
1 COVER PAGE	1
2 CONTENTS.....	2
3 TEST SUMMARY	3
4 GENERAL INFORMATION	4
4.1 CLIENT INFORMATION	4
4.2 GENERAL DESCRIPTION OF E.U.T.	4
4.3 TEST ENVIRONMENT AND MODES	4
4.4 DESCRIPTION OF SUPPORT UNITS	4
4.5 TEST LOCATION	5
4.6 OTHER INFORMATION REQUESTED BY THE CUSTOMER	5
4.7 TEST FACILITY	5
4.8 TEST INSTRUMENTS LIST	6
5 TEST RESULT & MEASUREMENT DATA.....	8
5.1 ANTENNA REQUIRMENT	8
5.2 RADIATED EMISSIONS.....	8
5.3 CONDUCTED EMISSIONS	13
5.4 FREQUENCY TOLERANCE.....	16
5.5 OCCUPIED BANDWIDTH	17



3 Test Summary

Test Item	Section in CFR 47	Result
Radiated Emission	Section 15.209;15.225(a)(b)(c)(d)	Pass
Conducted Emission (150kHz to 30MHz)	15.207	Pass
Frequency Tolerance	Section 15.225(e)	Pass
Occupied Bandwidth	Section 15.215	Pass

Remark: Pass: The EUT complies with the essential requirements in the standard.



4 General Information

4.1 Client Information

Applicant:	3M Cogent, Inc
Address of Applicant:	639 N. Rosemead Blvd. Pasadena, CA 91107, USA
Manufacturer:	Cogent Systems (Shenzhen), Inc
Address of Manufacturer:	TINWE INDUSTRIAL PARK PHASE 2, 6 LIUFANG RD, 67 AREA, BAOAN DISTRICT, SHENZHEN, GUANGDONG, 518101, CHINA
Factory:	Cogent Systems (Shenzhen), Inc
Address of Factory:	TINWE INDUSTRIAL PARK PHASE 2, 6 LIUFANG RD, 67 AREA, BAOAN DISTRICT, SHENZHEN, GUANGDONG, 518101, CHINA

4.2 General Description of E.U.T.

Product Name:	Mini-Gate, Normal CPU, Philips card reader, standard version
Model No.:	ACD100P-CS
Trade Mark:	3M
Operation Frequency:	13.56MHz
Modulation Type:	ASK
Power Supply:	AC ADAPTER MODEL: PA-1061-0 INPUT: 100-240V~50-60Hz 1.5A OUTPUT: 12V $\overline{\text{---}}$ 5.0A
AC Cable:	220 cm unshielded
DC Cable:	145 cm unshielded cable with one ferrite core
RJ45 Cable:	100 cm unshielded cable with three ferrite core

4.3 Test Environment and Modes

Operating Environment:	
Temperature:	26.0 °C
Humidity:	56% RH
Atmospheric Pressure:	1006mbar
Test mode:	
Transmitting mode:	Keep the EUT continues transmitting with modulation.

4.4 Description of Support Units

The EUT has been tested independent unit.



4.5 Test Location

All tests were performed at:

SGS-CSTC Standards Technical Services Co., Ltd. Shenzhen Branch E&E Lab

No. 1 Workshop, M-10, Middle section, Science & Technology Park, Shenzhen, Guangdong, China
518057

Telephone: +86 (0) 755 2601 2053 Fax: +86 (0) 755 2671 0594

No tests were sub-contracted.

4.6 Other Information Requested by the Customer

None.

4.7 Test Facility

The test facility is recognized, certified, or accredited by the following organizations:

- **CNAS (No. CNAS L2929)**
CNAS has accredited SGS-CSTC Standards Technical Services Co., Ltd. Shenzhen Branch EMC Lab to ISO/IEC 17025:2005 General Requirements for the Competence of Testing and Calibration Laboratories (CNAS-CL01 Accreditation Criteria for the Competence of Testing and Calibration Laboratories) for the competence in the field of testing.
- **VCCI**
The 3m Semi-anechoic chamber, Full-anechoic Chamber and Shielded Room (7.5m x 4.0m x 3.0m) of SGS-CSTC Standards Technical Services Co., Ltd. have been registered in accordance with the Regulations for Voluntary Control Measures with Registration No.: R-2197, G-416, T-1153 and C-2383 respectively.
- **FCC – Registration No.: 556682**
SGS-CSTC Standards Technical Services Co., Ltd., Shenzhen EMC Laboratory has been registered and fully described in a report filed with the (FCC) Federal Communications Commission. The acceptance letter from the FCC is maintained in our files. Registration No.: 556682.
- **Industry Canada (IC)**
The 3m Semi-anechoic chamber of SGS-CSTC Standards Technical Services Co., Ltd. has been registered by Certification and Engineering Bureau of Industry Canada for radio equipment testing with Registration No.: 4620C-1.



4.8 Test Instruments List

RE in Chamber					
Item	Test Equipment	Manufacturer	Model No.	Inventory No.	Cal.Due date (yyyy-mm-dd)
1	3m Semi-Anechoic Chamber	ETS-LINDGREN	N/A	SEL0017	2013-06-10
2	EMI Test Receiver	Rohde & Schwarz	ESIB26	SEL0023	2013-05-17
3	EMI Test software	AUDIX	E3	SEL0050	N/A
4	Coaxial cable	SGS	N/A	SEL0027	2013-05-29
5	Coaxial cable	SGS	N/A	SEL0189	2013-05-29
6	Coaxial cable	SGS	N/A	SEL0121	2013-05-29
7	Coaxial cable	SGS	N/A	SEL0178	2013-05-29
8	BiConiLog Antenna (26-3000MHz)	ETS-LINDGREN	3142C	SEL0015	2012-10-29
9	Double-ridged horn (1-18GHz)	ETS-LINDGREN	3117	SEL0006	2012-10-29
10	Pre-amplifier (0.1-1300MHz)	Agilent Technologies	8447D	SEL0053	2013-05-17
11	Pre-Amplifier (0.1-26.5GHz)	Compliance Directions Systems Inc.	PAP-0126	SEL0168	2012-11-26
12	Barometer	ChangChun	DYM3	SEL0088	2013-05-24
13	DC Power Supply	Zhao Xin	RXN-305D	SEL0117	2012-10-23
14	Humidity/ Temperature Indicator	Shanghai Qixiang	ZJ1-2B	SEL0103	2012-10-27
15	Signal Generator	Rohde & Schwarz	SMY01	SEL0155	2012-10-23
16	Signal Generator (10M-27GHz)	Rohde & Schwarz	SMR27	SEL0067	2013-05-17
17	Loop Antenna	Beijing Daze	ZN30401	SEL0203	2013-06-04



Conducted Emission					
Item	Test Equipment	Manufacturer	Model No.	Inventory No.	Cal.Due date (yyyy-mm-dd)
1	Shielding Room	ZhongYu Electron	GB-88	SEL0042	2013-06-10
2	LISN	Rohde & Schwarz	ENV216	SEL0152	2012-10-23
3	LISN	ETS-LINDGREN	3816/2	SEL0021	2013-5-17
4	8 Line ISN	Fischer Custom Communications Inc.	FCC-TLISN-T8-02	SEL0162	2012-11-11
5	4 Line ISN	Fischer Custom Communications Inc.	FCC-TLISN-T4-02	SEL0163	2012-11-11
6	2 Line ISN	Fischer Custom Communications Inc.	FCC-TLISN-T2-02	SEL0164	2012-11-11
7	EMI Test Receiver	Rohde & Schwarz	ESCI	SEL0022	2013-5-17
8	Coaxial Cable	SGS	N/A	SEL0025	2013-05-29
9	DC Power Supply	Zhao Xin	RXN-305D	SEL0117	2012-10-23
10	Humidity/ Temperature Indicator	Shanghai Qixiang	ZJ1-2B	SEL0103	2012-10-27
11	Barometer	Chang Chun	DYM3	SEL0088	2013-05-24

"This document is issued by the Company subject to its General Conditions of Service printed overleaf, available on request or accessible at www.sgs.com/terms_and_conditions.htm and, for electronic format documents, subject to Terms and Conditions for Electronic Documents at www.sgs.com/terms_e-document.htm. Attention is drawn to the limitation of liability, indemnification and jurisdiction issues defined therein. Any holder of this document is advised that information contained hereon reflects the Company's findings at the time of its intervention only and within the limits of Client's instructions, if any. The Company's sole responsibility is to its Client and this document does not exonerate parties to a transaction from exercising all their rights and obligations under the transaction documents. This document cannot be reproduced except in full, without prior written approval of the Company. Any unauthorized alteration, forgery or falsification of the content or appearance of this document is unlawful and offenders may be prosecuted to the fullest extent of the law. Unless otherwise stated the results shown in this test report refer only to the sample(s) tested and such sample(s) are retained for 90 days only."



5 Test Result & Measurement Data

5.1 Antenna Requirement

Standard requirement:	FCC Part15 C Section 15.203
15.203 requirement: An intentional radiator shall be designed to ensure that no antenna other than that furnished by the responsible party shall be used with the device. The use of a permanently attached antenna or of an antenna that uses a unique coupling to the intentional radiator, the manufacturer may design the unit so that a broken antenna can be replaced by the user, but the use of a standard antenna jack or electrical connector is prohibited.	

5.2 Radiated Emissions

Test Requirement:	FCC Part15 C Section 15.225
Test Method:	ANSI C63.10: 2009
Measurement Distance:	3m (Semi-Anechoic Chamber)
Requirements:	(a) The field strength of any emissions within the band 13.553-13.567 MHz shall not exceed 15.848 microvolts/meter at 30 meters. (b) Within the bands 13.410-13.553 MHz and 13.567-13.710 MHz, the field strength of any emissions shall not exceed 334 microvolts/meter at 30 meters. (c) Within the bands 13.110-13.410 MHz and 13.710-14.010 MHz the field strength of any emissions shall not exceed 106 microvolts/meter at 30 meters. (d) The field strength of any emissions appearing outside of the 13.110-14.010 MHz band shall not exceed the general radiated emission limits in § 15.209.
Detector:	0.009MHz to 30MHz QP RBW=9KHz VBW=30KHz 30MHz to 1000MHz QP RBW=100KHz VBW=300KHz

Test Procedure:	<ol style="list-style-type: none"> The EUT is placed on a turntable, which is 0.8m above ground plane. The turntable shall be rotated for 360 degrees to determine the position of maximum emission level. EUT is set 3m away from the receiving antenna, which is moved from 1m to 4m to find out the maximum emissions. Maximum procedure was performed on the six highest emissions to ensure EUT compliance. And also, each emission was to be maximized by changing the polarization of receiving antenna both horizontal and vertical. Repeat above procedures until the measurements for all frequencies are complete. The limit 1.705MHz to 30MHz in clause 4.3 are specified at 30 meters, and measurements were made at 3 meters, the limit is translated to 3 meters by using a formula as follows: $Limit\ 3m = Limit30m + 40\log(30m/3)$
Test Instruments:	Refer to section 4.8 for details
Test Result:	The unit does meet the FCC Part 15 C Section 15.225 requirements.

1.705-30MHz Mode

Test Procedure: For testing performed with the loop antenna, testing was performed in accordance to ANSI C63.4: 2009, section 8.2.1. The center of the loop was positioned 1 m above the ground and positioned with its plane vertical at the specified distance from the EUT. During testing the loop was rotated about its vertical axis for maximum response at each azimuth and also investigated with the loop positioned in the horizontal plane. Only the worst position of vertical was shown in the report.

Measurement Data

Intentional emission

Test Frequency (MHz)	Level (dBµV/m)	Limits (dBµV/m)	Margin (dB)
13.56	82.26	124	-41.74

Remark: 1. The EUT was tested at 3m in field chamber.

2. The EUT modulation type is ASK modulation, and duty is 100%.



"This document is issued by the Company subject to its General Conditions of Service printed overleaf, available on request or accessible at www.sgs.com/terms_and_conditions.htm and, for electronic format documents, subject to Terms and Conditions for Electronic Documents at www.sgs.com/terms_e-document.htm. Attention is drawn to the limitation of liability, indemnification and jurisdiction issues defined therein. Any holder of this document is advised that information contained hereon reflects the Company's findings at the time of its intervention only and within the limits of Client's instructions, if any. The Company's sole responsibility is to its Client and this document does not exonerate parties to a transaction from exercising all their rights and obligations under the transaction documents. This document cannot be reproduced except in full, without prior written approval of the Company. Any unauthorized alteration, forgery or falsification of the content or appearance of this document is unlawful and offenders may be prosecuted to the fullest extent of the law. Unless otherwise stated the results shown in this test report refer only to the sample(s) tested and such sample(s) are retained for 90 days only."



30MHz-1GHz

Horizontal

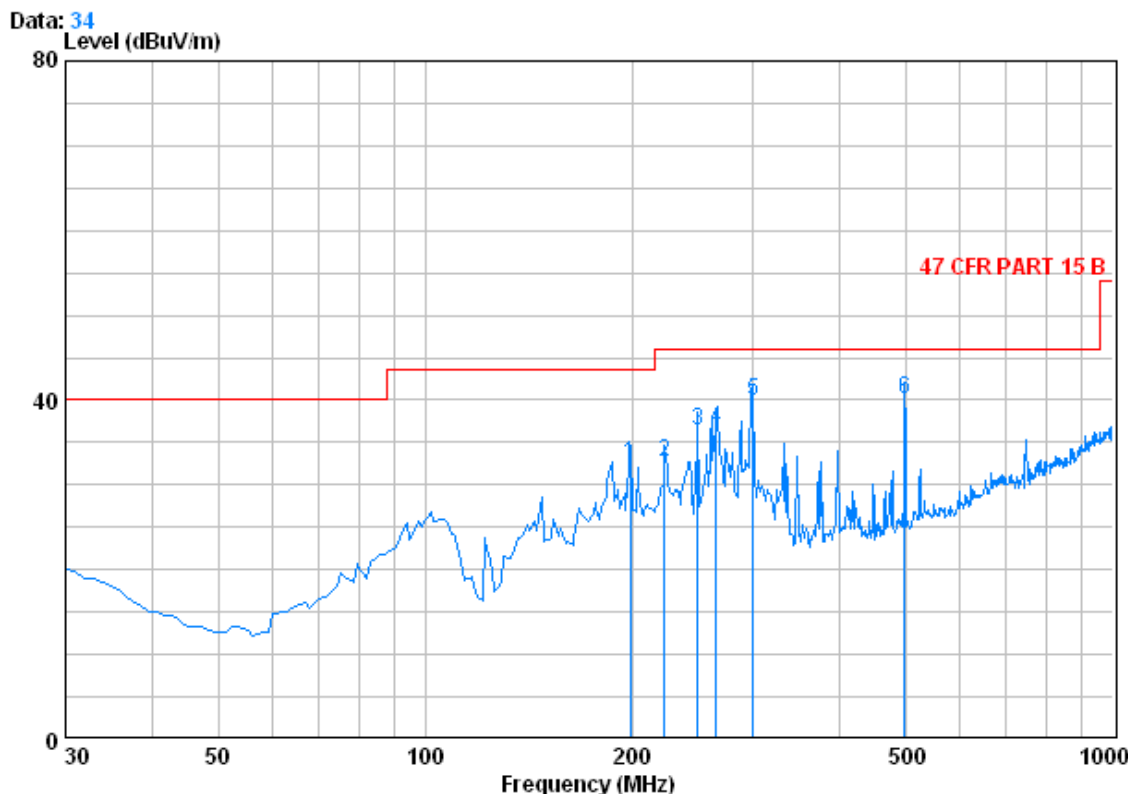

Condition : 47 CFR PART 15 B 3m 3142C HORIZONTAL
Job No. : 2930RF
Mode : Transmitting

	Freq	Cable Loss	Antenna Factor	Preamp Factor	Read Level	Limit	Over
	MHz	dB	dB/m	dB	dBuV	dBuV/m	dB
1	198.780	1.40	10.19	26.70	47.69	32.57	43.50 -10.93
2	223.030	1.53	11.38	26.62	46.45	32.74	46.00 -13.26
3	249.220	1.67	12.27	26.54	49.08	36.48	46.00 -9.52
4	264.740	1.74	12.61	26.49	48.77	36.63	46.00 -9.37
5	299.660	1.90	13.85	26.41	50.46	39.80	46.00 -6.20
6	498.510	2.59	17.80	27.70	47.32	40.01	46.00 -5.99

"This document is issued by the Company subject to its General Conditions of Service printed overleaf, available on request or accessible at www.sgs.com/terms_and_conditions.htm and, for electronic format documents, subject to Terms and Conditions for Electronic Documents at www.sgs.com/terms_e-document.htm. Attention is drawn to the limitation of liability, indemnification and jurisdiction issues defined therein. Any holder of this document is advised that information contained hereon reflects the Company's findings at the time of its intervention only and within the limits of Client's instructions, if any. The Company's sole responsibility is to its Client and this document does not exonerate parties to a transaction from exercising all their rights and obligations under the transaction documents. This document cannot be reproduced except in full, without prior written approval of the Company. Any unauthorized alteration, forgery or falsification of the content or appearance of this document is unlawful and offenders may be prosecuted to the fullest extent of the law. Unless otherwise stated the results shown in this test report refer only to the sample(s) tested and such sample(s) are retained for 90 days only."



Vertical

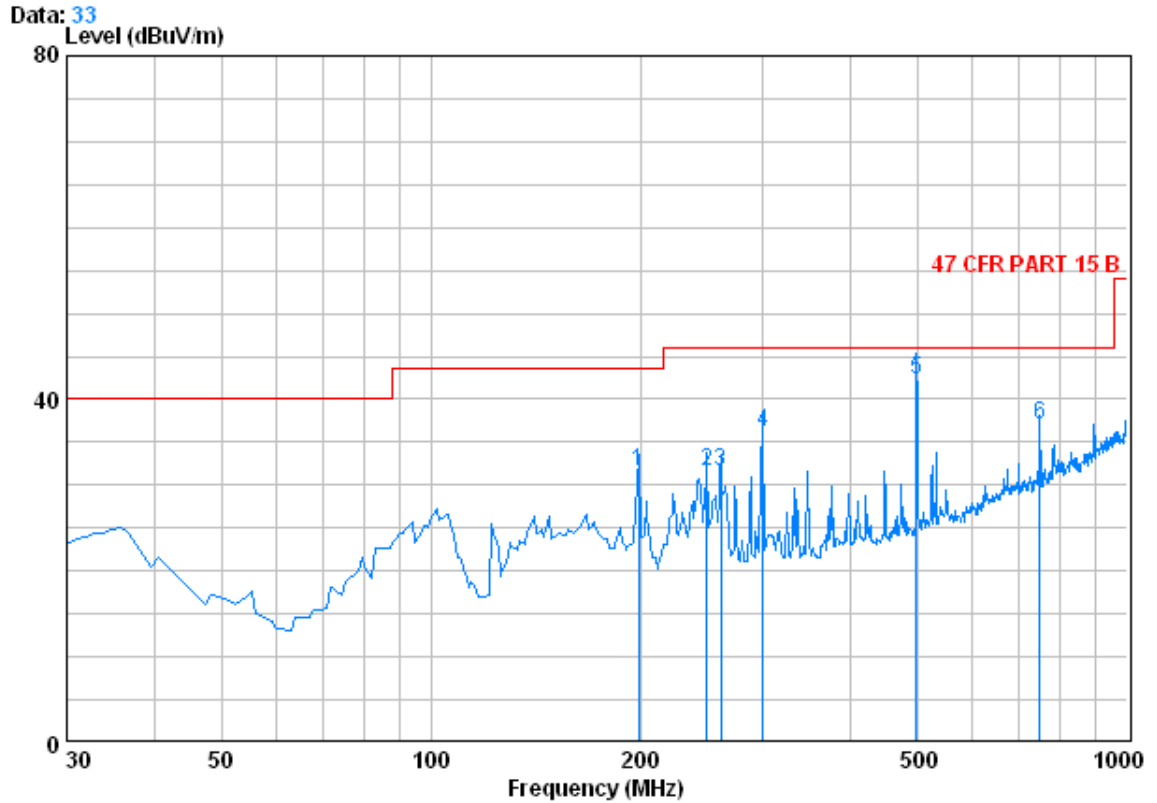

Condition : 47 CFR PART 15 B 3m 3142C VERTICAL
Job No. : 2930RF
Mode : Transmitting

	Freq	CableAntenna Loss	Antenna Factor	Preamp Factor	Read Level	Level	Limit Line	Over Limit
	MHz	dB	dB/m	dB	dBuV	dBuV/m	dBuV/m	dB
1	198.780	1.40	10.19	26.70	46.69	31.57	43.50	-11.93
2	249.220	1.67	12.27	26.54	44.29	31.69	46.00	-14.31
3	260.860	1.73	12.53	26.50	43.81	31.56	46.00	-14.44
4	299.660	1.90	13.85	26.41	46.86	36.20	46.00	-9.80
5 @	498.510	2.59	17.80	27.70	49.57	42.26	46.00	-3.74
6	749.740	3.06	21.70	27.35	39.66	37.06	46.00	-8.94

"This document is issued by the Company subject to its General Conditions of Service printed overleaf, available on request or accessible at www.sgs.com/terms_and_conditions.htm and, for electronic format documents, subject to Terms and Conditions for Electronic Documents at www.sgs.com/terms_e-document.htm. Attention is drawn to the limitation of liability, indemnification and jurisdiction issues defined therein. Any holder of this document is advised that information contained herein reflects the Company's findings at the time of its intervention only and within the limits of Client's instructions, if any. The Company's sole responsibility is to its Client and this document does not exonerate parties to a transaction from exercising all their rights and obligations under the transaction documents. This document cannot be reproduced except in full, without prior written approval of the Company. Any unauthorized alteration, forgery or falsification of the content or appearance of this document is unlawful and offenders may be prosecuted to the fullest extent of the law. Unless otherwise stated the results shown in this test report refer only to the sample(s) tested and such sample(s) are retained for 90 days only."



1.705-30MHz

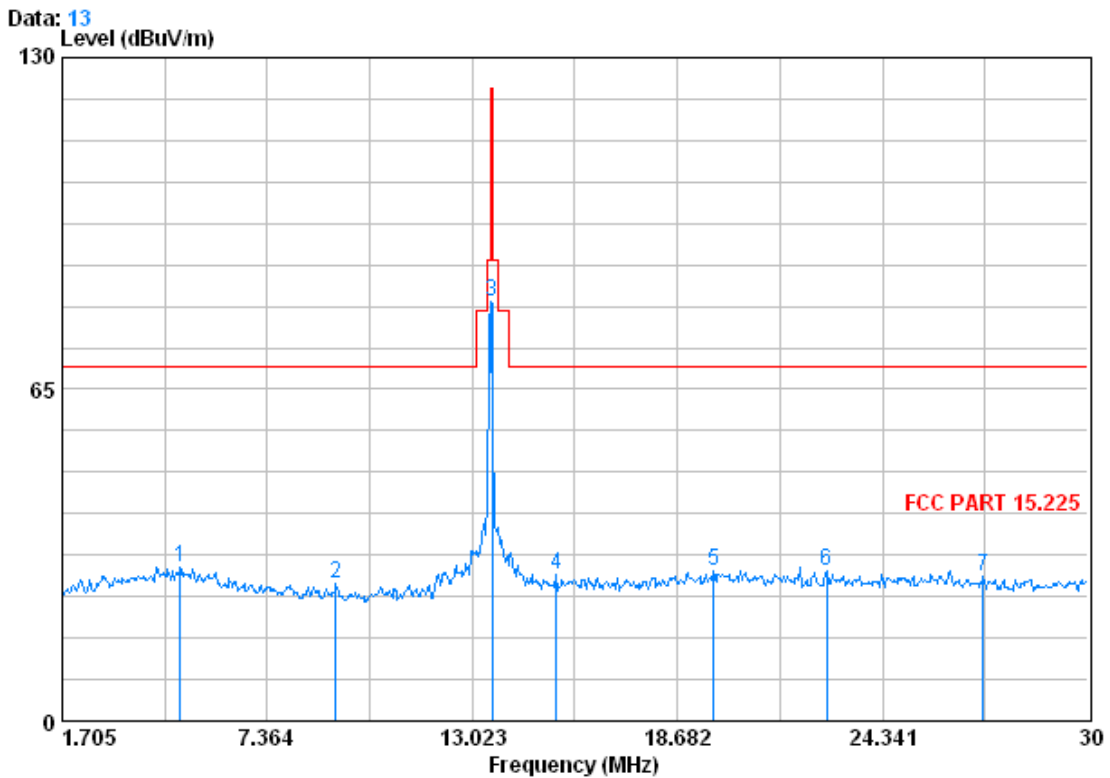

Condition : FCC PART 15.225 3m LOOP ANT 42963
Job No. : 2930RF
Mode : Transmitting

	Freq	CableAntenna Loss	Preamp Factor	Read Level	Limit Level	Over Limit
	MHz	dB	dB/m	dBuV	dBuV/m	dB
1	4.959	0.17	12.50	0.00	17.59	30.27
2	9.260	0.31	11.90	0.00	14.82	27.04
3	13.559	0.46	11.51	0.00	70.28	82.26
4	15.343	0.52	11.36	0.00	16.81	28.69
5	19.672	0.66	10.84	0.00	17.99	29.49
6	22.813	0.76	10.07	0.00	18.60	29.44
7	27.114	0.90	9.29	0.00	18.12	28.31

Remark: The disturbance 9kHz to 1.705MHz was very low, and no obvious signal can be found.

"This document is issued by the Company subject to its General Conditions of Service printed overleaf, available on request or accessible at www.sgs.com/terms_and_conditions.htm and, for electronic format documents, subject to Terms and Conditions for Electronic Documents at www.sgs.com/terms_e-document.htm. Attention is drawn to the limitation of liability, indemnification and jurisdiction issues defined therein. Any holder of this document is advised that information contained hereon reflects the Company's findings at the time of its intervention only and within the limits of Client's instructions, if any. The Company's sole responsibility is to its Client and this document does not exonerate parties to a transaction from exercising all their rights and obligations under the transaction documents. This document cannot be reproduced except in full, without prior written approval of the Company. Any unauthorized alteration, forgery or falsification of the content or appearance of this document is unlawful and offenders may be prosecuted to the fullest extent of the law. Unless otherwise stated the results shown in this test report refer only to the sample(s) tested and such sample(s) are retained for 90 days only."

5.3 Conducted Emissions

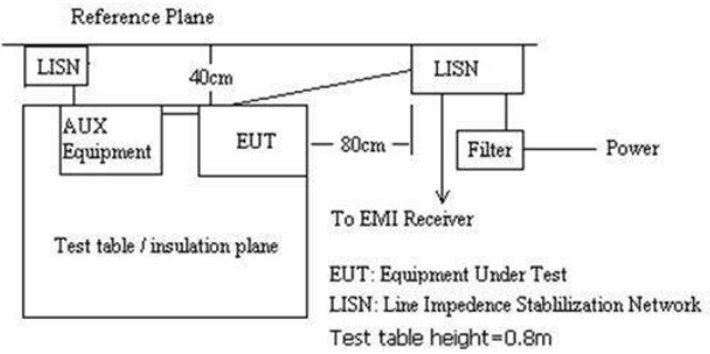
Test Requirement:	FCC Part 15.207
Test Method:	ANSI C63.10: 2009
Frequency Range:	150kHz to 30MHz
Detector:	Peak for pre-scan (9kHz Resolution Bandwidth) Quasi-Peak if maximized peak within 6dB of Quasi-Peak limit
Plan View of Test Setup	
Test Instruments:	Refer to section 4.8 for details
Test Results:	Pass

Measurement Data

An initial pre-scan was performed on the live and neutral lines with peak detector.

Quasi-Peak and Average measurement were performed at the frequencies with maximized peak emission were detected.



Live Line

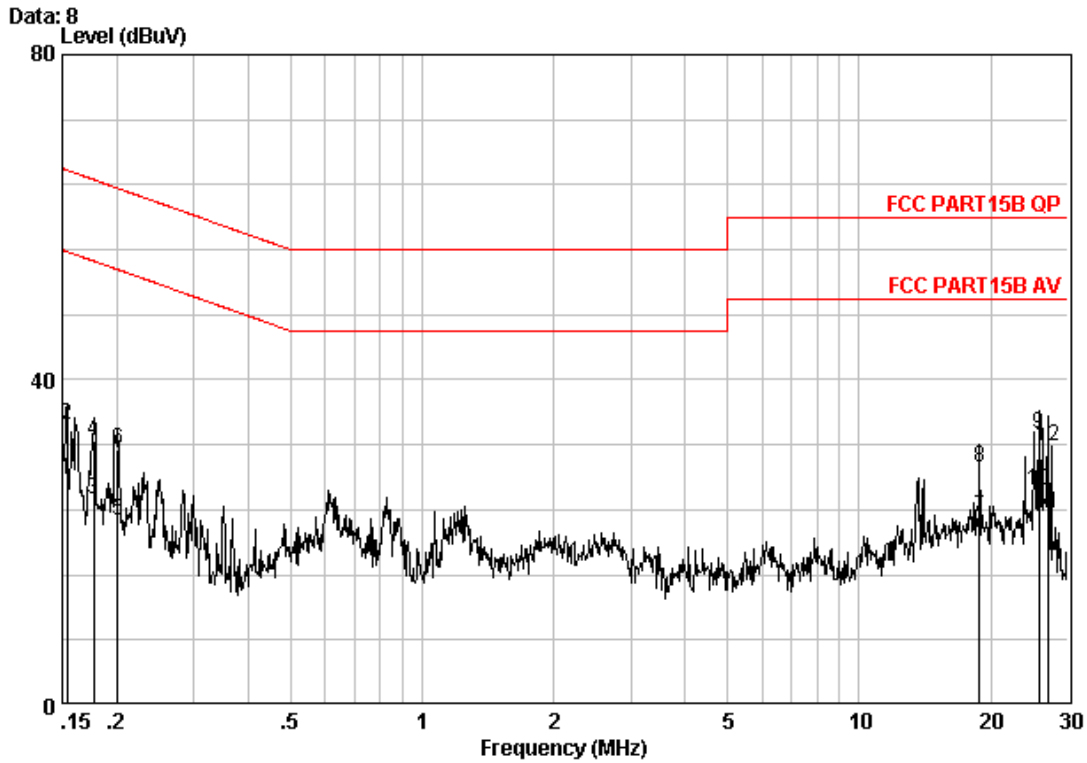

Site : Shielding Room
Condition : FCC PART15B QP CE-20101216 LINE
Job No. : 2930RF
Mode : Transmitting

	Freq	Cable Loss	LISN Factor	Read Level	Level	Limit Line	Over Limit	Remark
	MHz	dB	dB	dBuV	dBuV	dBuV	dB	
1	0.15403	0.04	9.60	18.15	27.79	55.78	-27.99	Average
2	0.15403	0.04	9.60	24.90	34.54	65.78	-31.24	QP
3	0.17678	0.04	9.60	15.60	25.24	54.64	-29.40	Average
4	0.17678	0.04	9.60	22.80	32.44	64.64	-32.20	QP
5	0.20075	0.04	9.60	13.11	22.75	53.58	-30.82	Average
6	0.20075	0.04	9.60	21.70	31.34	63.58	-32.24	QP
7 @	18.820	0.27	10.08	12.67	23.01	50.00	-26.99	Average
8	18.820	0.27	10.08	18.90	29.25	60.00	-30.75	QP
9 @	25.727	0.29	10.10	22.90	33.29	60.00	-26.71	QP
10 @	25.727	0.29	10.10	15.90	26.28	50.00	-23.72	Average
11 @	27.127	0.29	10.10	13.18	23.57	50.00	-26.43	Average
12	27.127	0.29	10.10	21.40	31.79	60.00	-28.21	QP

"This document is issued by the Company subject to its General Conditions of Service printed overleaf, available on request or accessible at www.sgs.com/terms_and_conditions.htm and, for electronic format documents, subject to Terms and Conditions for Electronic Documents at www.sgs.com/terms_e-document.htm. Attention is drawn to the limitation of liability, indemnification and jurisdiction issues defined therein. Any holder of this document is advised that information contained herein reflects the Company's findings at the time of its intervention only and within the limits of Client's instructions, if any. The Company's sole responsibility is to its Client and this document does not exonerate parties to a transaction from exercising all their rights and obligations under the transaction documents. This document cannot be reproduced except in full, without prior written approval of the Company. Any unauthorized alteration, forgery or falsification of the content or appearance of this document is unlawful and offenders may be prosecuted to the fullest extent of the law. Unless otherwise stated the results shown in this test report refer only to the sample(s) tested and such sample(s) are retained for 90 days only."



Neutral Line

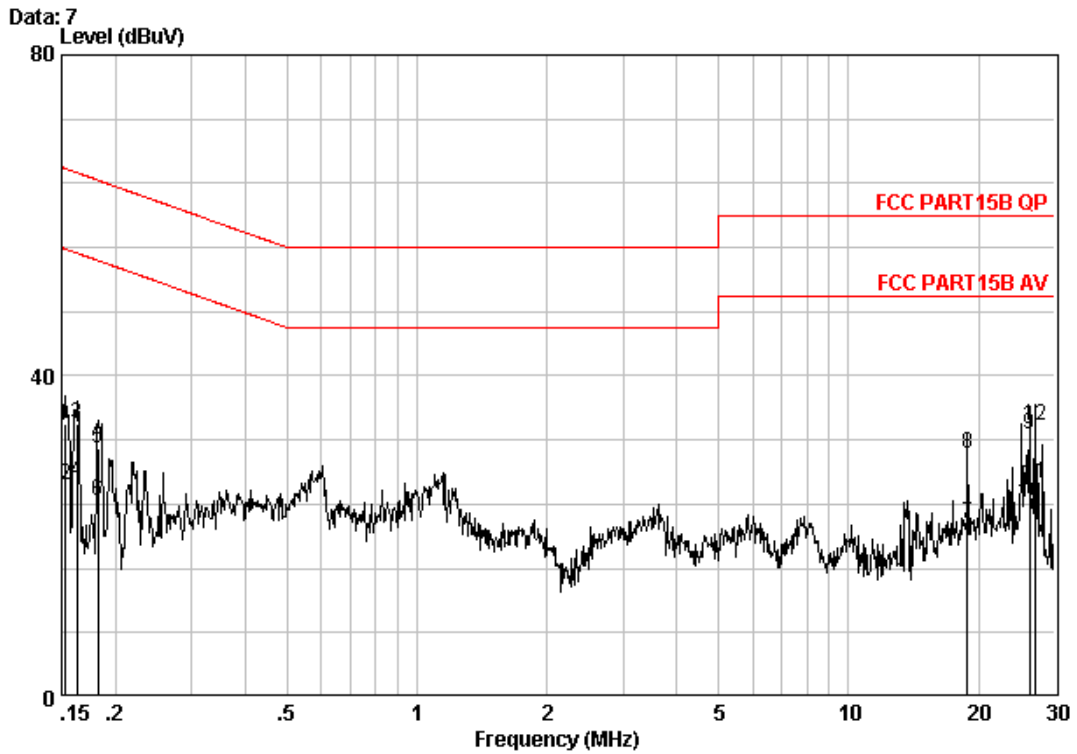

Site : Shielding Room
Condition : FCC PART15B QP CE-20101216 NEUTRAL
Job No. : 2930RF
Mode : Transmitting

	Freq	Cable Loss	LISN Factor	Read Level	Limit Level	Limit Line	Over Limit	Remark
	MHz	dB	dB	dBuV	dBuV	dBuV	dB	
1	0.15321	0.04	9.60	24.40	34.04	65.82	-31.78	QP
2	0.15321	0.04	9.60	16.82	26.46	55.82	-29.36	Average
3	0.16241	0.04	9.60	24.30	33.94	65.34	-31.40	QP
4	0.16241	0.04	9.60	17.16	26.80	55.34	-28.54	Average
5	0.18249	0.04	9.60	21.30	30.94	64.37	-33.43	QP
6	0.18249	0.04	9.60	14.73	24.37	54.37	-30.00	Average
7	18.820	0.27	10.08	11.28	21.62	50.00	-28.38	Average
8	18.820	0.27	10.08	19.90	30.25	60.00	-29.75	QP
9	26.278	0.29	10.10	22.30	32.69	60.00	-27.31	QP
10 @	26.278	0.29	10.10	13.78	24.17	50.00	-25.83	Average
11 @	26.984	0.29	10.10	16.12	26.51	50.00	-23.49	Average
12 @	26.984	0.29	10.10	23.30	33.69	60.00	-26.31	QP

"This document is issued by the Company subject to its General Conditions of Service printed overleaf, available on request or accessible at www.sgs.com/terms_and_conditions.htm and, for electronic format documents, subject to Terms and Conditions for Electronic Documents at www.sgs.com/terms_e-document.htm. Attention is drawn to the limitation of liability, indemnification and jurisdiction issues defined therein. Any holder of this document is advised that information contained herein reflects the Company's findings at the time of its intervention only and within the limits of Client's instructions, if any. The Company's sole responsibility is to its Client and this document does not exonerate parties to a transaction from exercising all their rights and obligations under the transaction documents. This document cannot be reproduced except in full, without prior written approval of the Company. Any unauthorized alteration, forgery or falsification of the content or appearance of this document is unlawful and offenders may be prosecuted to the fullest extent of the law. Unless otherwise stated the results shown in this test report refer only to the sample(s) tested and such sample(s) are retained for 90 days only."



5.4 Frequency Tolerance

Test Requirement:	FCC Part 15 C Section 15.225(e)
Test Method:	ANSI C63.10: 2009
Frequency Range:	Operation within the band 13.110-14.010 MHz
Requirements:	The frequency tolerance of the carrier signal shall be maintained within +/- 0.01% of the operating frequency over a temperature variation of -20 degrees to +50 degrees C at normal supply voltage, and for a variation in the primary supply voltage from 85% to 115% of the rated supply voltage at a temperature of 20 degrees C. For battery operated equipment, the equipment tests shall be performed using a new battery.
Method of Measurement:	The EUT was placed in an environmental test chamber and powered such that control element received normal voltage and the transmitter provided maximum RF output.
Test Result:	The unit does meet the FCC Part 15 C Section 15.225(e) requirements.

Test Frequency: 13.56MHz				Temperature:20°C
Supply Voltage (V) AC	Test Result (MHz)	Deviation (kHz)	Limit (kHz)	Result
120	13.55978	0.24	1.3560	Pass
138	13.55976	0.24	1.3560	Pass
102	13.55974	0.26	1.3560	Pass

Test Frequency: 13.56MHz				Voltage:120V
Temperature (°C)	Test Result (MHz)	Deviation (kHz)	Limit (kHz)	Result
-20	13.55976	0.24	1.3560	Pass
-10	13.55976	0.24	1.3560	
0	13.55976	0.24	1.3560	
10	13.55974	0.26	1.3560	
20	13.55978	0.22	1.3560	
30	13.55976	0.24	1.3560	
40	13.55974	0.26	1.3560	
50	13.55976	0.24	1.3560	

"This document is issued by the Company subject to its General Conditions of Service printed overleaf, available on request or accessible at www.sgs.com/terms_and_conditions.htm and, for electronic format documents, subject to Terms and Conditions for Electronic Documents at www.sgs.com/terms_e-document.htm. Attention is drawn to the limitation of liability, indemnification and jurisdiction issues defined therein. Any holder of this document is advised that information contained hereon reflects the Company's findings at the time of its intervention only and within the limits of Client's instructions, if any. The Company's sole responsibility is to its Client and this document does not exonerate parties to a transaction from exercising all their rights and obligations under the transaction documents. This document cannot be reproduced except in full, without prior written approval of the Company. Any unauthorized alteration, forgery or falsification of the content or appearance of this document is unlawful and offenders may be prosecuted to the fullest extent of the law. Unless otherwise stated the results shown in this test report refer only to the sample(s) tested and such sample(s) are retained for 90 days only."



5.5 Occupied Bandwidth

Test Requirement:	FCC Part 15 C Section 15.215 (C)
Test Method:	ANSI C63.10: 2009
Frequency Range:	Operation within the band 13.110 – 14.010 MHz
Requirements:	Intentional radiators operating under the alternative provisions to the general emission limits, as contained in §15.217 through §15.257 and in subpart E of this part, must be designed to ensure that the 20 dB bandwidth of the emission is contained within the frequency band designated in the rule section under which the equipment is operated. The requirement to contain the 20 dB bandwidth of the emission within the specified frequency band includes the effects from frequency sweeping, frequency hopping and other modulation techniques that may be employed as well as the frequency stability of the transmitter over expected variations in temperature and supply voltage. If frequency stability is not specified in the regulations, it is recommended that the fundamental emission be kept within at least the central 80% of the permitted band in order to minimize the possibility of out-of-band operation.
Method of Measurement:	The useful radiated emission from the EUT was detected by the spectrum analyser with peak detector.
Test Result:	The unit does meet the FCC Part 15 C Section 15.215 requirements.

The graph as below: represents the emissions take for this device.

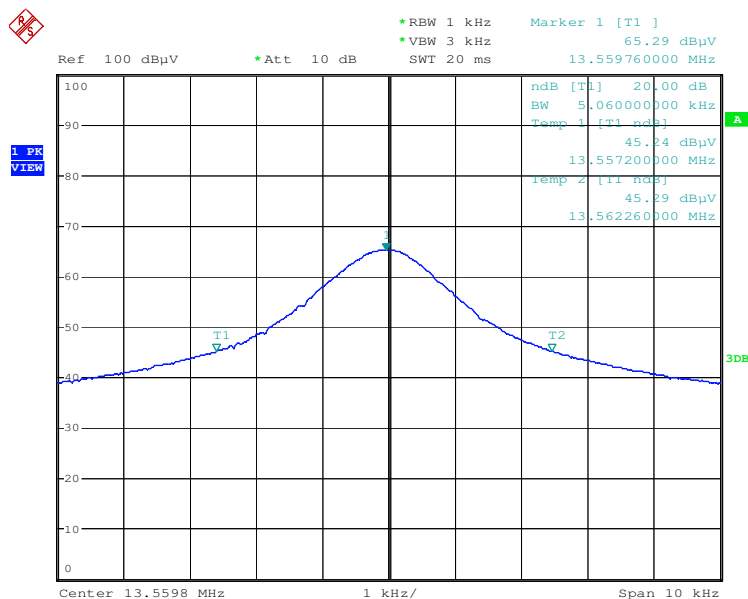

"This document is issued by the Company subject to its General Conditions of Service printed overleaf, available on request or accessible at www.sgs.com/terms_and_conditions.htm and, for electronic format documents, subject to Terms and Conditions for Electronic Documents at www.sgs.com/terms_e-document.htm. Attention is drawn to the limitation of liability, indemnification and jurisdiction issues defined therein. Any holder of this document is advised that information contained hereon reflects the Company's findings at the time of its intervention only and within the limits of Client's instructions, if any. The Company's sole responsibility is to its Client and this document does not exonerate parties to a transaction from exercising all their rights and obligations under the transaction documents. This document cannot be reproduced except in full, without prior written approval of the Company. Any unauthorized alteration, forgery or falsification of the content or appearance of this document is unlawful and offenders may be prosecuted to the fullest extent of the law. Unless otherwise stated the results shown in this test report refer only to the sample(s) tested and such sample(s) are retained for 90 days only."