



Shenzhen Certification Technology Service Co., Ltd.
2F, Building B, East Area of Nanchang Second Industrial Zone,
Gushu 2nd Road, Bao'an District, Shenzhen 518126, P.R. China.

TEST REPORT

FCC ID: ZYF-QS800

Applicant : 3M Cogent, Inc
Address : 639 N. Rosemead Blvd. Pasadena, CA 91107, USA

Equipment under Test (EUT):

Name : Document Reader
Model : QS800

Standards : FCC PART 15, SUBPART C : 2011 (Section 15.225)

Report No. : STE120327317
Date of Test : June 5-14, 2012
Date of Issue : June 15, 2012

Test Result :	PASS *
----------------------	---------------

* In the configuration tested, the EUT complied with the standards specified above

Authorized Signature

(Mark Zhu)
General Manager

The manufacture should ensure that all the products in series production are in conformity with the product sample detailed in this report.

If the product in this report is used in any configuration other than that detailed in the report, the manufacturer must ensure the new system complies with all relevant standards. Any mention of Shenzhen Certification Technology Service Co., Ltd. Or test done by Shenzhen Certification Technology Service Co., Ltd. Approvals in connection with, distribution or use of the product described in this report must be approved by Shenzhen Certification Technology Service Co., Ltd. Approvals in writing.

TABLE OF CONTENT

Description	Page
1 General Information-----	3
1.1 Description of Device (EUT)-----	3
1.2 Description of Test Facility-----	4
2 EMC Equipment List-----	4
3 Test Procedure-----	5
4 Summary of Measurement-----	6
4.1 Summary of test result-----	6
4.2 Test mode-----	6
5 Spurious Emission-----	7
5.1 Radiation Emission-----	7
5.2 Field strength-----	13
6 POWER LINE CONDUCTED EMISSION-----	15
6.1 Conducted Emission Limits(15.209)-----	15
6.2 Test Setup-----	15
6.3 Test Procedure-----	16
6.4 Test Results-----	16
7 Frequency stability-----	19
7.1 Test limit-----	19
7.2 Test Procedure-----	19
7.3 Test Setup-----	19
7.4 Test Results-----	19
8 Bandwidth Test-----	21
8.1 Limit for Bandwidth-----	21
8.2 Method of measurement-----	21
8.3 Test Setup-----	21
8.4 Test Results-----	21
9 Antenna Requirement-----	22
9.1 Standard Requirement-----	22
9.2 Antenna Connected Construction-----	22
9.3 Result-----	22
10 Photographs of Test Setup-----	23
11 Photographs of EUT-----	24

1 General Information

1.1 Description of Device (EUT)

Trade Name : **3M**

EUT : Document Reader

Model No. : QS800

Type of Antenna : Integral Antenna

Antenna Specification : 0dBi

Operation Frequency : 13.56MHz

Notes : This report is only test the SCM Reader transmitter, the other transmitter please see the report STE120428457. the SCM Reader transmitting Antenna is marked, see page 32 of this report.

Channel number : 1

Modulation type : ASK

Power Supply : DC 5V From PC

special accessories : N/A

Applicant : 3M Cogent, Inc

Address : 639 N. Rosemead Blvd. Pasadena, CA 91107, USA

Manufacturer : Cogent Systems (Shenzhen), Inc

Address : 10/F, Tinwe Industrial Park Phase 2, Liufang Road No.6, Area No.67, Baoan District, ShenZhen

1.2 Description of Test Facility

Shenzhen Certification Technology Service Co., Ltd.
 2F, Building B, East Area of Nanchang Second Industrial Zone,
 Gushu 2nd Road, Bao'an District, Shenzhen 518126, P.R. China
 FCC Registered No.: 197647

2 EMC Equipment List

Equipment	Manufacturer	Model No.	Serial No.	Last cal.	Cal Interval
3m Semi-Anechoic	ETS-LINDGREEN	N/A	SEL0017	06/04/2012	1 Year
Spectrum analyzer	Agilent	E4443A	MY46185649	06/04/2012	1 Year
Receiver	R&S	ESCI	100492	06/04/2012	1 Year
Receiver	R&S	ESCI	101202	06/04/2012	1 Year
Loop Antenna	R&S	FMZB1516	1516131	06/04/2012	1 Year
Bilog Antenna	Sunol	JB3	A121206	06/04/2012	1 Year
Horn Antenna	EMCO	3115	640201028-06	06/04/2012	1 Year
Power Meter	Anritsu	ML2487A	6K00001491	02/23/2012	1 Year
ETS Horn Antenna	ETS	3160	SEL0076	08/12/2011	1 Year
Active Loop Antenna	Beijing Daze	ZN30900A	SEL0097	06/04/2012	1 Year
Cable	Resenberger	N/A	No.1	06/04/2012	1 Year
Cable	SCHWARZBECK	N/A	No.2	06/04/2012	1 Year
Cable	SCHWARZBECK	N/A	No.3	06/04/2012	1 Year
Pre-amplifier	R&S	AFS42-00101800-25-S-42	SEL0081	06/04/2012	1 Year
Pre-amplifier	R&S	AFS33-18002650-30-8P-44	SEL0080	06/04/2012	1 Year

3 Test Procedure

POWER LINE CONDUCTED INTERFERENCE: The test procedure used was ANSI Standard C63.4-2003 using a 50 u H LISN. Both Lines were observed. The bandwidth of the receiver was 10kHz with an appropriate sweep speed. The ambient temperature of the EUT was 25°C with a humidity of 58%.

RADIATION INTERFERENCE: The test procedure used was ANSI Standard C63.4-2003 using a ANRITSU spectrum analyzer with a pre-selector. The analyzer was calibrated in dB above a micro volt at the output of the antenna. The resolution bandwidth was 100kHz and the video bandwidth was 300 kHz up to 1 GHz and 1 MHz with a video BW of 3MHz above 1 GHz. The ambient temperature of the EUT was 25°C with a humidity of 58%.

FORMULA OF CONVERSION FACTORS: The Field Strength at 3m was established by adding the meter reading of the spectrum analyzer (which is set to read in units of dBuV) to the antenna correction factor supplied by the antenna manufacturer and cable loss. The antenna correction factors and cable loss are stated in terms of dB. The gain of the Pre-selector was accounted for in the Spectrum Analyzer Meter Reading.

Example:

Freq (MHz) METER READING + ACF + CABLE = FS

33.20 dBuV + 10.36 dB + 0.9 dB= 44.46 dBuV/m @ 3m

ANSI STANDARD C63.4-2003 10.1.7 MEASUREMENT PROCEDURES: The EUT was placed on a table 80 cm high and with dimensions of 1m by 1.5m. The EUT was placed in the center of the table (1.5m side). The table used for radiated measurements is capable of continuous rotation. When an emission was found, the table was rotated to produce the maximum signal strength. At this point, the antenna was raised and lowered from 1m to 4m. The antenna was placed in both the horizontal and vertical planes. The situation was similar for the conducted measurement except that the table did not rotate. The EUT was setup as described in ANSI Standard C63.4-2003 10.1.7 with the EUT 40 cm from the vertical ground wall.

4 Summary of Measurement

4.1 Summary of test result

Test Item	Test Requirement	Standard Paragraph	Result
Spurious Emission	FCC PART 15: 2011	Section 15.225&15.209	Compliance
Conduction Emission	FCC PART 15: 2011	Section 15.207	Compliance
Frequency stability	FCC PART 15: 2011	Section 15.225	Compliance
Bandwidth Requirement	FCC PART 15: 2011	Section 15.215	Compliance
Antenna Requirement	FCC PART 15: 2011	Section 15.203	Compliance

Note: EUT can be powered Supply by Notebook, according to exploratory test, so all the final test were performed using a Notebook.

4.2 Test mode

Tested mode, channel, and data rate information			
Mode	Channel	Data rate(Kbps)	Frequency (MHz)
1	CH1	848	13.56
Note: According exploratory test, EUT will have maximum output power in those data rate. so those data rate were used for all test.			

5 Spurious Emission

5.1 Radiation Emission

5.1.1 Radiation Emission Limits(15.209)

Frequency (MHZ)	Field Strength Limits at 3 metres (watts,e.i.r.p.)		
	uV/m	dB uV/m	Measurement distance(m)
0.009-0.490	2400/F(kHz)	XX	300
0.490-1.705	24000/F(kHz)	XX	30
1.705-30	30	29.5	30
30~88	100(3nW)	40	3
88~216	150(6.8nW)	43.5	3
216~960	200(12nW)	46	3
Above960	500(75nW)	54	3
Carrier frequency	15.848	104(AV)	3
Carrier frequency		124(PK)	3

NOTE:

- a) The tighter limit applies at the band edges.
- b) Emission Level(dB uV/m)=20log Emission Level(Uv/m)

5.1.2 Test Setup

See the next page

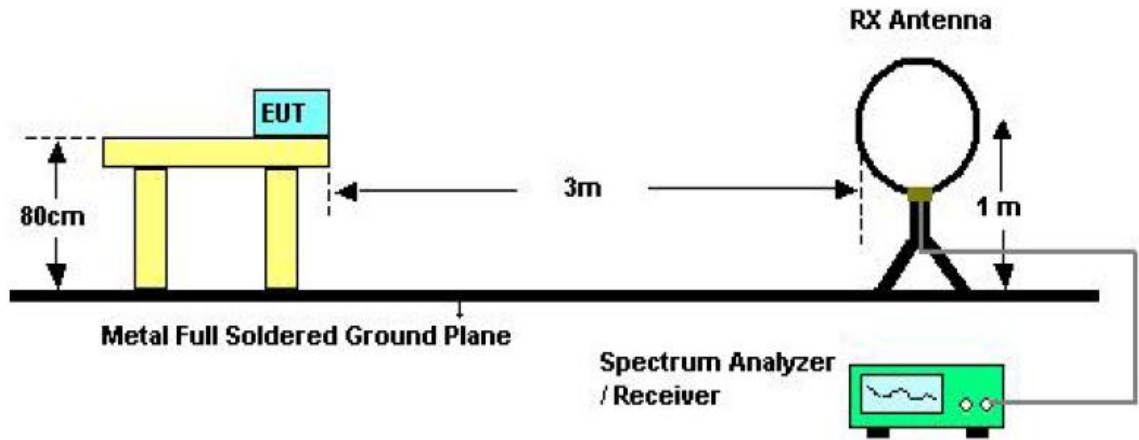

Below 30MHZ Test Setup

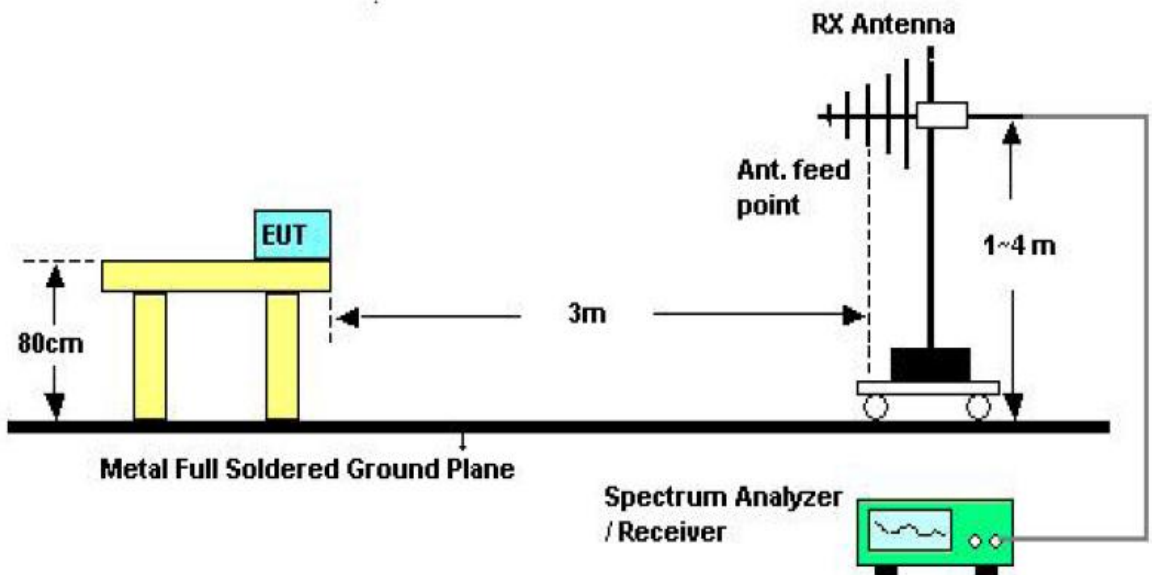

Above 30MHZ Test Setup

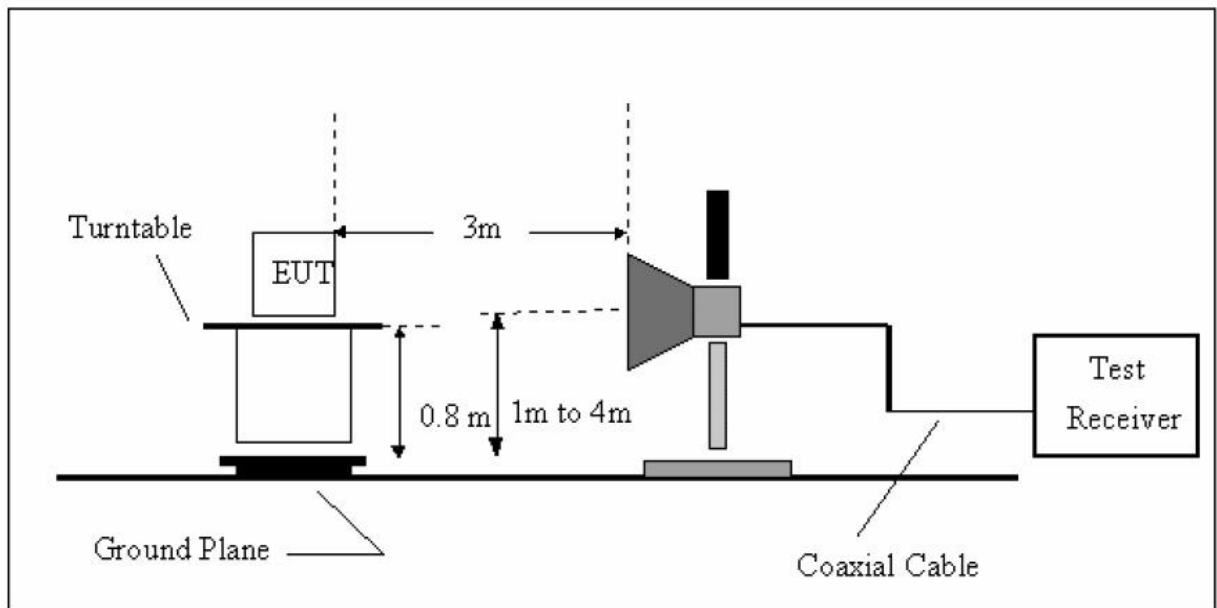

Above 1GHZ Test Setup

5.1.3 Test Procedure

- a) The measuring distance of 3m shall be used for measurements at frequency up to 1GHz and above 1GHz, The EUT was placed on a rotating 0.8 m high above ground, The table was rotated 360 degrees to determine the position of the highest radiation
- b) The Test antenna shall vary between 1m and 4m, Both Horizontal and Vertical antenna are set ot make measurement.
- c) The initial step in collecting conducted emission data is a spectrum analyzer Peak detector mode pre-scanning the measurement frequency range. Significant Peaks are then marked. and then Qusia Peak Detector mode remeasured
- d) If Peak value comply with QP limit Below 1GHz.The EUT deemed to comply with QP limit. But the Peak value and average value both need to comply with applicable limit above 1GHz.
- e) For the actual test configuration, please see the test setup photo.

5.1.4 Test Equipment Setting For emission test. est Result

9KHZ~150KHZ	RBW 200HZ	VBW1KHZ
150KHZ~30MHZ	RBW 9KHZ	VBW 30KHZ
30MHZ~1GHZ	RBW 120KHZ	VBW 300KHZ
Above 1GHZ	RBW 1MHZ	VBW 3MHZ

5.1.5 Test Condition

Continual Transmitting in maximum power.

5.1.6 Test Result

Detailed information please see the following page.

EUT	Document Reader	Model Name	QS800
Temperature	26°C	Relative Humidity	56%
Pressure	960hPa	Test voltage	DC 5V
Test Mode	TX		

Freq. (MHz)	Ant.Pol . H/V	Detector Mode (PK/QP)	Reading (dBuV)	Factor (dB)	Actual FS (dBuV/m)	Limits 3m (dBuV/m)	Margin (dBuV/m)
143.49	V	Peak	45.32	-12.16	33.16	43.50	-10.34
191.99	V	Peak	49.86	-15.23	34.63	43.50	-8.87
239.52	V	Peak	54.06	-14.03	40.03	46.00	-5.97
335.55	V	Peak	46.01	-11.54	34.47	46.00	-11.53
407.33	V	Peak	49.24	-10.00	39.24	46.00	-6.76
600.36	V	Peak	44.47	-6.30	38.17	46.00	-7.83

EUT	Document Reader	Model Name	QS800
Temperature	26°C	Relative Humidity	56%
Pressure	960hPa	Test voltage	DC 5V
Test Mode	TX		

Freq. (MHz)	Ant.Pol . H/V	Detector Mode (PK/QP)	Reading (dBuV)	Factor (dB)	Actual FS (dBuV/m)	Limits 3m (dBuV/m)	Margin (dBuV/m)
143.49	H	Peak	42.89	-12.16	30.73	43.50	-12.77
191.99	H	Peak	47.99	-15.23	32.76	43.50	-10.74
241.46	H	Peak	51.06	-14.00	37.06	46.00	-8.94
335.55	H	Peak	50.30	-11.54	38.76	46.00	-7.24
407.33	H	Peak	50.02	-10.00	40.02	46.00	-5.98
647.89	H	Peak	44.62	-5.44	39.18	46.00	-6.82

Notes: Above is Below 1GHz test data

Radiated Emissions Result of Inside band (13.56MHZ)

EUT	Document Reader	Model Name	QS800
Temperature	26°C	Relative Humidity	58%
Pressure	960hPa	Test voltage	DC 5V
Test Mode	TX	Antenna polarization	H/V
Distance	3m		

Channel (13.56MHZ)									
Fre. MHz	Position X/Y/Z	Reading dBuV	Antenna Factor dB	Cable Loss dB	Amplifier Gain dB	Correct Factor dB	Measure Result dBuV/m	Limit dBuV/m	Margin dB
13.56	X	128.17 (PK)	10.6	0.33	24.65	-13.94	114.26	124	-9.74
13.56	X	110.05 (AV)	10.6	0.33	24.65	-13.94	96.14	104	-7.86
--	X	--	--	--	--	--	--	--	--
13.56	Y	118.26 (PK)	10.6	0.33	24.65	-13.94	104.35	124	-19.65
13.56	Y	104.37 (AV)	10.6	0.33	24.65	-13.94	90.46	104	-13.54
--	Y	--	--	--	--	--	--	--	--
13.56	Z	116.14 (PK)	10.6	0.33	24.65	-13.94	102.23	124	-21.77
13.56	Z	105.22 (AV)	10.6	0.33	24.65	-13.94	91.31	104	-12.69
--	Z	--	--	--	--	--	--	--	--

Notes: --Means other frequency and mode comply with standard requirements and at least have 20dB margin.

Correct Factor=Cable Loss+ Antenna Factor- Amplifier Gain

Measurement Result=Reading + Correct Factor

Margin=Measurement Result-Limit

--Spectrum setting:

a. Peak setting RBW=120KHz, VBW=300KHz.

b. AV setting RBW=1MHz, VBW=10Hz.

5.2 Field strength

5.2.1 Limit

Please see the section 15.225(b) and 15.225(c)

15.225(b): Within the bands 13.410–13.553 MHz and 13.567–13.710 MHz, the field strength of any emissions shall not exceed 334 microvolts/meter (50.5dBuV/m)at 30 meters

15.225(c): Within the bands 13.110–13.410 MHz and 13.710–14.010 MHz the field strength of any emissions shall not exceed 106 microvolts/meter (40.5dBuV/m) at 30 meters

**Note: 30m to 3m correction factor calculation:
 $40 * \text{Log}(30\text{m}/3\text{m})=40$**

5.2.2 Test Result:

EUT	Document Reader	Model Name	QS800
Temperature	26°C	Relative Humidity	56%
Pressure	960hPa	Test voltage	DC 5V
Test Mode	TX	Distance	3m

Freq. (MHz)	Position X/Y/Z	Detector Mode (PK/QP)	Reading (dBuV)	Factor (dB)	Actual FS (dBuV/m)	Limits 3m (dBuV/m)	Margin (dBuV/m)
13.235	X	Peak	46.41	-13.94	32.47	80.50	-48.03
13.434	X	Peak	45.36	-13.94	31.42	90.50	-59.08
13.498	X	Peak	44.28	-13.94	30.34	90.50	-60.16
13.602	X	Peak	57.44	-13.93	43.51	90.50	-46.99
13.815	X	Peak	46.27	-13.93	32.34	80.50	-48.16
13.933	X	Peak	45.43	-13.93	31.50	80.50	-49.00

Freq. (MHz)	Position X/Y/Z	Detector Mode (PK/QP)	Reading (dBuV)	Factor (dB)	Actual FS (dBuV/m)	Limits 3m (dBuV/m)	Margin (dBuV/m)
13.135	Y	Peak	43.36	-13.94	29.42	80.50	-51.08
13.341	Y	Peak	47.44	-13.94	33.50	80.50	-47.00
13.439	Y	Peak	44.58	-13.94	30.64	90.50	-59.86
13.516	Y	Peak	46.69	-13.94	32.75	90.50	-57.75
13.658	Y	Peak	43.73	-13.93	29.80	90.50	-60.70
13.813	Y	Peak	45.62	-13.93	31.69	80.50	-48.81

Freq. (MHz)	Position X/Y/Z	Detector Mode (PK/QP)	Reading (dBuV)	Factor (dB)	Actual FS (dBuV/m)	Limits 3m (dBuV/m)	Margin (dBuV/m)
13.201	Z	Peak	43.88	-13.94	29.94	80.50	-50.56
13.387	Z	Peak	45.02	-13.94	31.08	80.50	-49.42
13.436	Z	Peak	44.36	-13.94	30.42	90.50	-60.08
13.596	Z	Peak	47.64	-13.93	33.71	90.50	-56.79
13.722	Z	Peak	42.53	-13.93	28.60	80.50	-51.90
13.851	Z	Peak	46.28	-13.93	32.35	80.50	-48.15

6 POWER LINE CONDUCTED EMISSION

6.1 Conducted Emission Limits(15.209)

Frequency MHz	Limits dB(μ V)	
	Quasi-peak Level	Average Level
0.15 -0.50	66 -56*	56 - 46*
0.50 -5.00	56	46
5.00 -30.00	60	50

Notes: 1. *Decreasing linearly with logarithm of frequency.

2. The lower limit shall apply at the transition frequencies.

3. The limit decreases in line with the logarithm of the frequency in the rang of 0.15 to 0.50 MHz.

6.2 Test Setup

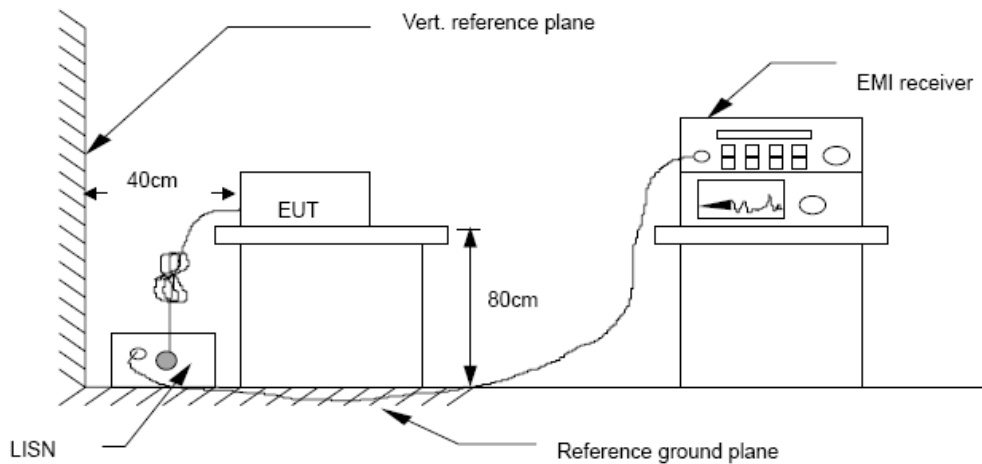

6.3 Test Procedure

The EUT is put on the plane 0.8m high above the ground by insulating support and is connected to the power mains through a line impedance stabilization network (L.I.S.N.). This provides a 50ohm coupling impedance for the EUT system. Please refer the block diagram of the test setup and photographs. Both sides of AC lines are checked to find out the maximum conducted emission. In order to find the maximum emission levels, the relative positions of equipment and all of the interface cables shall be changed according to ANSI C63.4-2003 on Conducted Emission Measurement. The bandwidth of test receiver (R & S ESCS30) is set at 9 kHz.

6.4 Test Results

PASS

Detailed information please see the following page.



Shenzhen Certification Technology Service Co., Ltd.
 2F, Building B, East Area of Nanchang Second Industrial Zone,
 Gushu 2nd Road, Bao'an District, Shenzhen 518126, P.R. China
 Tel: 4006786199 Fax: +86-755-26736857
 Website: http://www.cessz.com Email: Service@cessz.com

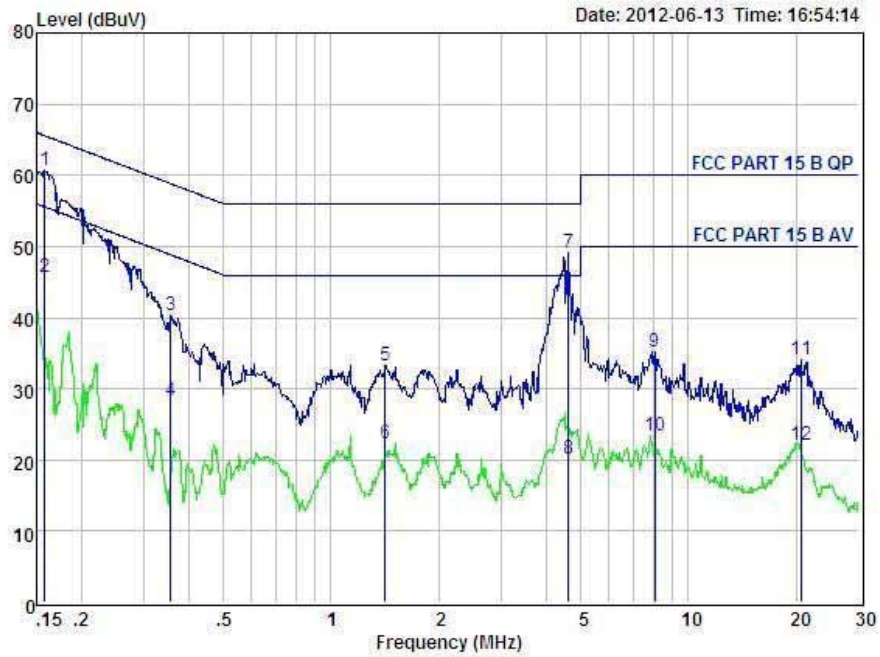

Condition : FCC PART 15 B QP POL: LINE
 EUT : Document Reader
 Model No. : QS800
 Test Mode : Normal
 Power : DC 5V
 Test Engineer: Store
 Remark :

Item	Freq MHz	Read dBuV	LISN Factor dB	Preamp Factor dB	Cable Loss dB	Level dBuV	Limit dBuV	Margin dBuV	Remark
1	0.158	50.76	0.03	-9.72	0.10	60.61	65.56	-4.95	QP
2	0.158	35.76	0.03	-9.72	0.10	45.61	55.56	-9.95	Average
3	0.356	30.38	0.03	-9.72	0.10	40.23	58.83	-18.60	QP
4	0.356	18.38	0.03	-9.72	0.10	28.23	48.83	-20.60	Average
5	1.418	23.41	0.05	-9.71	0.10	33.27	56.00	-22.73	QP
6	1.418	12.41	0.05	-9.71	0.10	22.27	46.00	-23.73	Average
7	4.622	39.25	0.09	-9.68	0.12	49.14	56.00	-6.86	QP
8	4.622	10.25	0.09	-9.68	0.12	20.14	46.00	-25.86	Average
9	8.062	25.51	0.14	-9.47	0.16	35.28	60.00	-24.72	QP
10	8.062	13.51	0.14	-9.47	0.16	23.28	50.00	-26.72	Average
11	20.704	23.90	0.34	-9.50	0.36	34.10	60.00	-25.90	QP
12	20.704	11.90	0.34	-9.50	0.36	22.10	50.00	-27.90	Average



Shenzhen Certification Technology Service Co., Ltd.
 2F, Building B, East Area of Nanchang Second Industrial Zone,
 Gushu 2nd Road, Bao'an District, Shenzhen 518126, P.R. China
 Tel: 4006786199 Fax: +86-755-26736857
 Website: http://www.cessz.com Email: Service@cessz.com

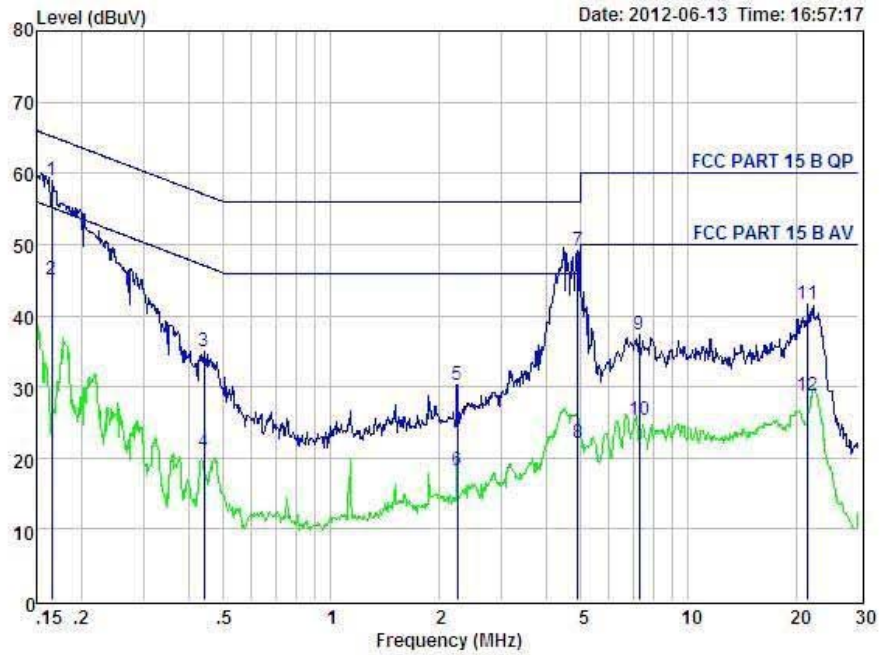

Condition : FCC PART 15 B QP POL: NEUTRAL
 EUT : Document Reader
 Model No. : QS800
 Test Mode : Normal
 Power : DC 5V
 Test Engineer: Store
 Remark :

Item	Freq MHz	Read dBuV	LISN Factor dB	Preamp Factor dB	Cable Loss dB	Level dBuV	Limit dBuV	Margin dBuV	Remark
1	0.165	49.13	0.03	-9.72	0.10	58.98	65.21	-6.23	QP
2	0.165	35.13	0.03	-9.72	0.10	44.98	55.21	-10.23	Average
3	0.442	25.04	0.03	-9.72	0.10	34.89	57.02	-22.13	QP
4	0.442	11.04	0.03	-9.72	0.10	20.89	47.02	-26.13	Average
5	2.261	20.44	0.06	-9.70	0.11	30.31	56.00	-25.69	QP
6	2.261	8.44	0.06	-9.70	0.11	18.31	46.00	-27.69	Average
7	4.900	39.27	0.10	-9.68	0.12	49.17	56.00	-6.83	QP
8	4.900	12.17	0.10	-9.68	0.12	22.07	46.00	-23.93	Average
9	7.290	27.48	0.13	-9.52	0.15	37.28	60.00	-22.72	QP
10	7.290	15.48	0.13	-9.52	0.15	25.28	50.00	-24.72	Average
11	21.600	31.37	0.37	-9.52	0.38	41.64	60.00	-18.36	QP
12	21.600	18.37	0.37	-9.52	0.38	28.64	50.00	-21.36	Average

7 Frequency stability

7.1 Test limit

Please refer section 15.225e.

Regulation 15.225(e) The frequency tolerance of the carrier signal shall be maintained within $\pm 0.01\%$ (± 100 ppm) of the operating frequency over a temperature variation of -20 degrees to $+50$ degrees C at normal supply voltage, and for a variation in the primary supply voltage from 85% to 115% of the rated supply voltage at a temperature of 20 degrees C. For battery operated equipment, the equipment tests shall be performed using a new battery.

7.2 Test Procedure

The following equipment are installed on the emission measurement to meet the commission requirements and operating regulations in a manner which tends to maximize its emission characteristics in normal application.

7.3 Test Setup

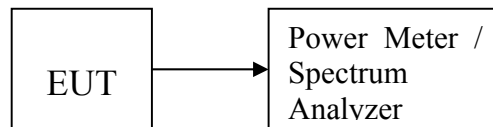

7.4 Test Results

PASS

Detailed information please see the following page.

Assigned Frequency(MHz): 13.56MHz Voltage: DC 5V				
Voltage	Temperature	Measured Frequency (MHz)	Frequency stability	Limit
Low 4.25V	+20°C	13.56073	0.00073	±100 ppm ±0.001356MHz
	-20°C	13.56067	0.00067	
Normal 5V	-10°C	13.55952	-0.00048	
	0°C	13.56038	0.00038	
	+10°C	13.55925	-0.00075	
	+20°C	13.56036	0.00036	
	+30°C	13.56072	0.00072	
	+40°C	13.55995	-0.00005	
	+50°C	13.55963	-0.00037	
High 5.75V	+20°C	13.56068	0.00068	

8 Bandwidth Test

8.1 Limit for Bandwidth

Please see the section 15.215.

8.2 Method of measurement

- a) The bandwidth is measured at an amplitude level reduced 20dB from the reference level. The reference level is the level of the highest amplitude signal observed from the transmitter at the fundamental frequency. Once the reference level is established, the equipment is conditioned with typical modulating signal to produce the worst-case (i.e. the widest) bandwidth.
- b) The test receiver RBW set 10KHZ, VBW set 30KHZ

8.3 Test Setup

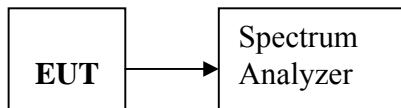

8.4 Test Results

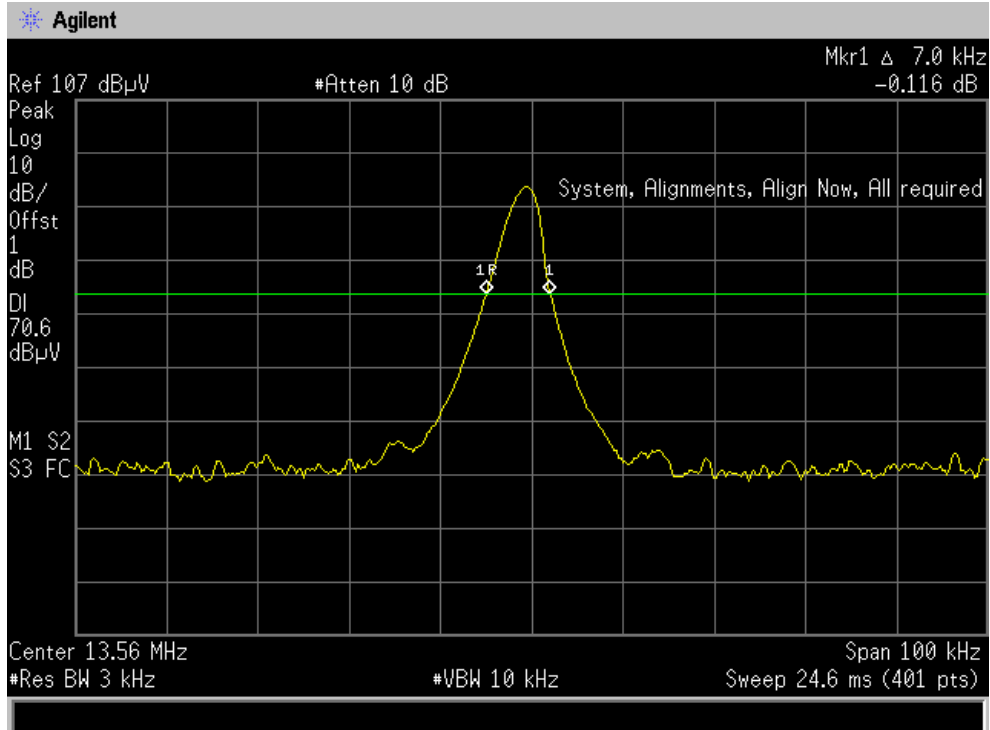

13.56HZ bandwidth test plot

9 Antenna Requirement

9.1 Standard Requirement

Standard: FCC PART 15, SUBPART C : 2011 (Section 15.203)

An intentional radiator shall be designed to ensure that no antenna other than that furnished by the responsible party shall be used with the device. The use of a permanently attached antenna or of an antenna that uses a unique coupling to the intentional radiator shall be considered sufficient to comply with the provisions of this Section. The manufacturer may design the unit so that a broken antenna can be replaced by the user, but the use of a standard antenna jack or electrical connector is prohibited.

9.2 Antenna Connected Construction

The directional gains of antenna used for transmitting is 0 dBi, and the antenna connector is de-signed with permanent attachment and no consideration of replacement. Please see EUT photo for details.

9.3 Result

The EUT antenna is integral Antenna. It comply with the standard requirement.

10 Photographs of Test Setup

Photos of Radiated Emission Test Setup in Chamber

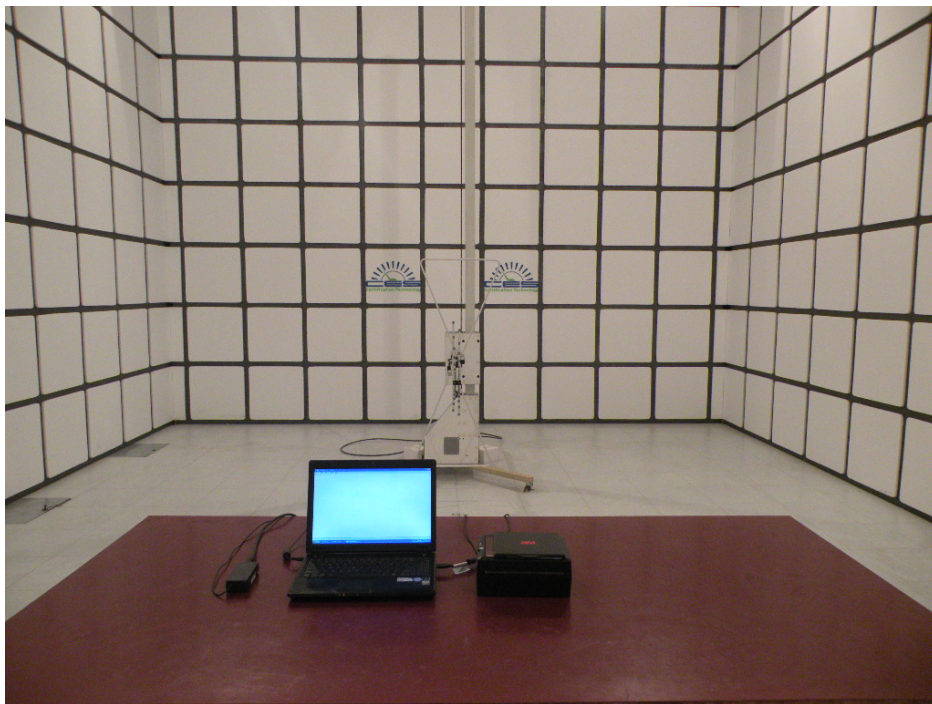
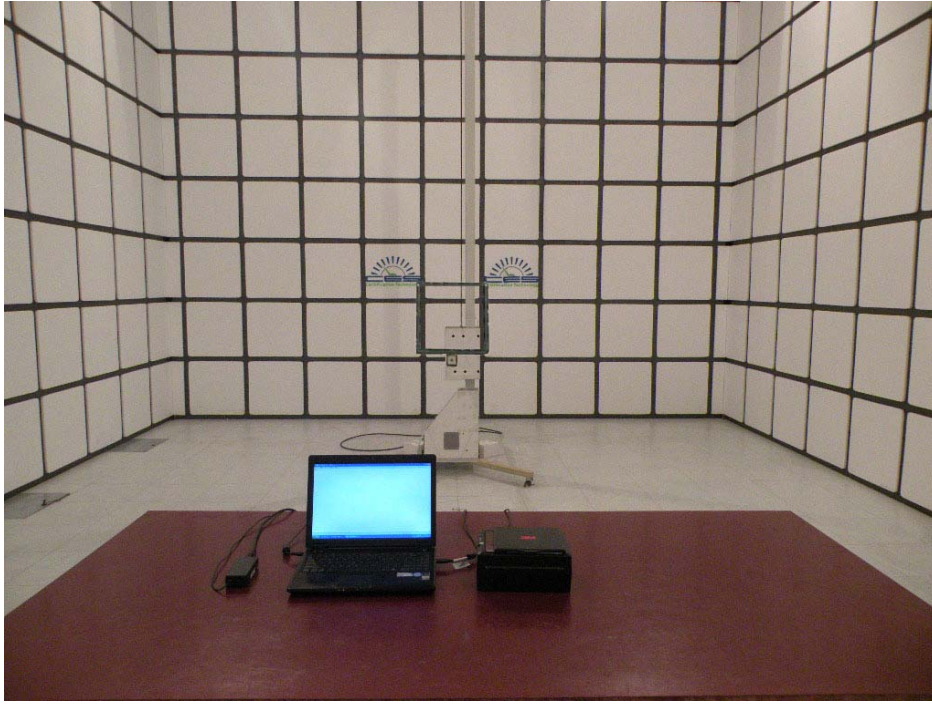

Photos of conducted emission Test Setup



11 Photographs of EUT



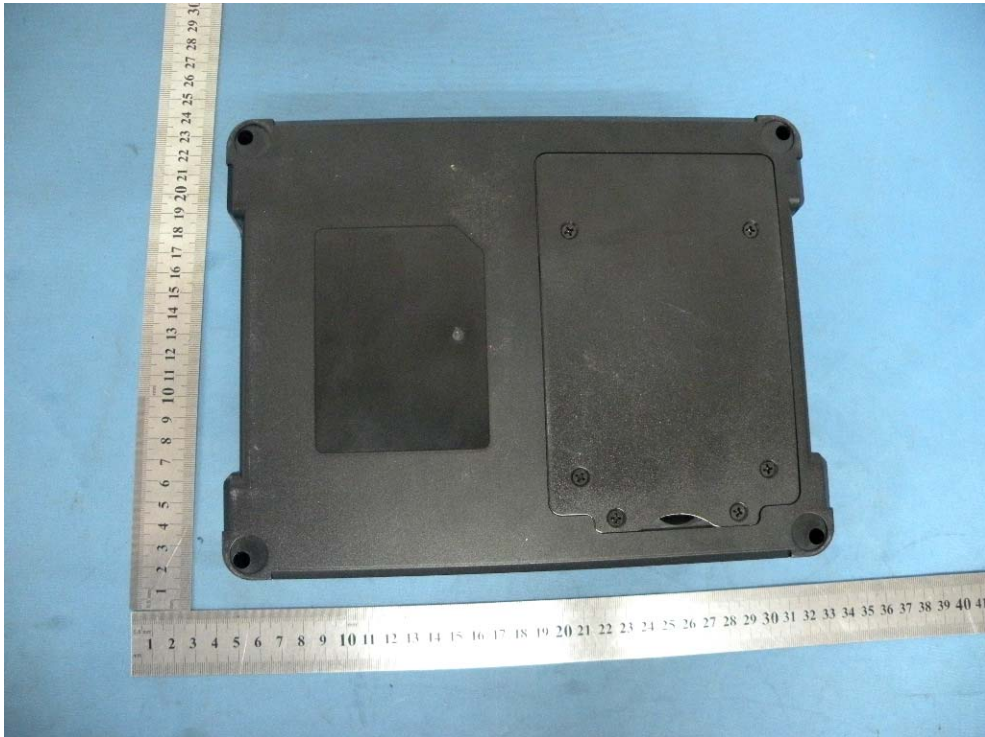





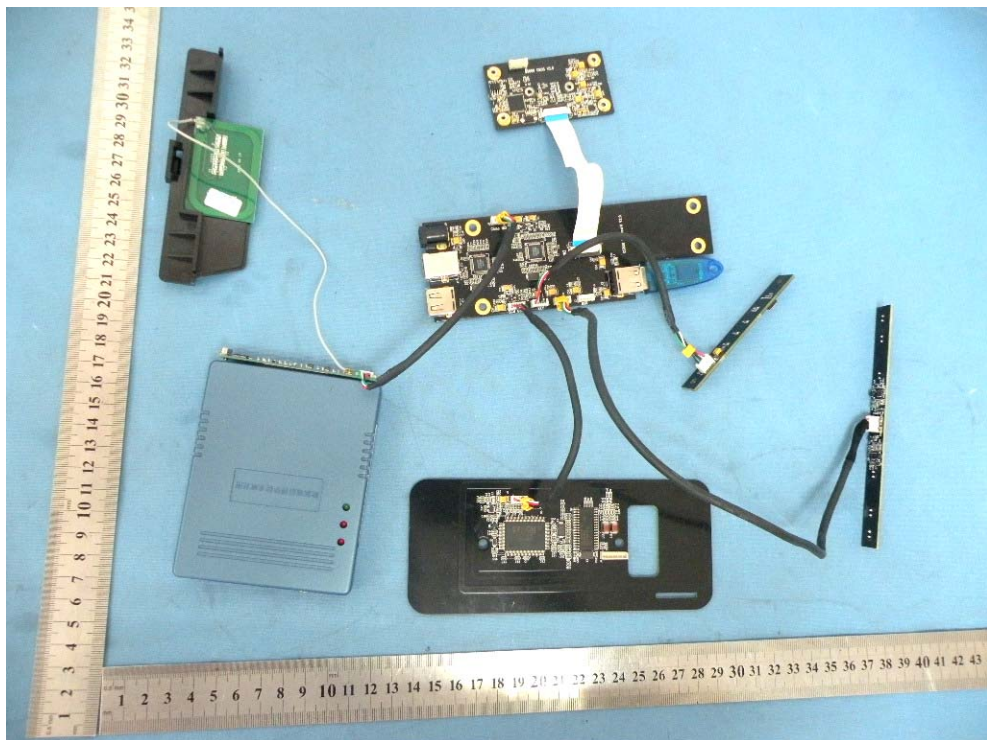
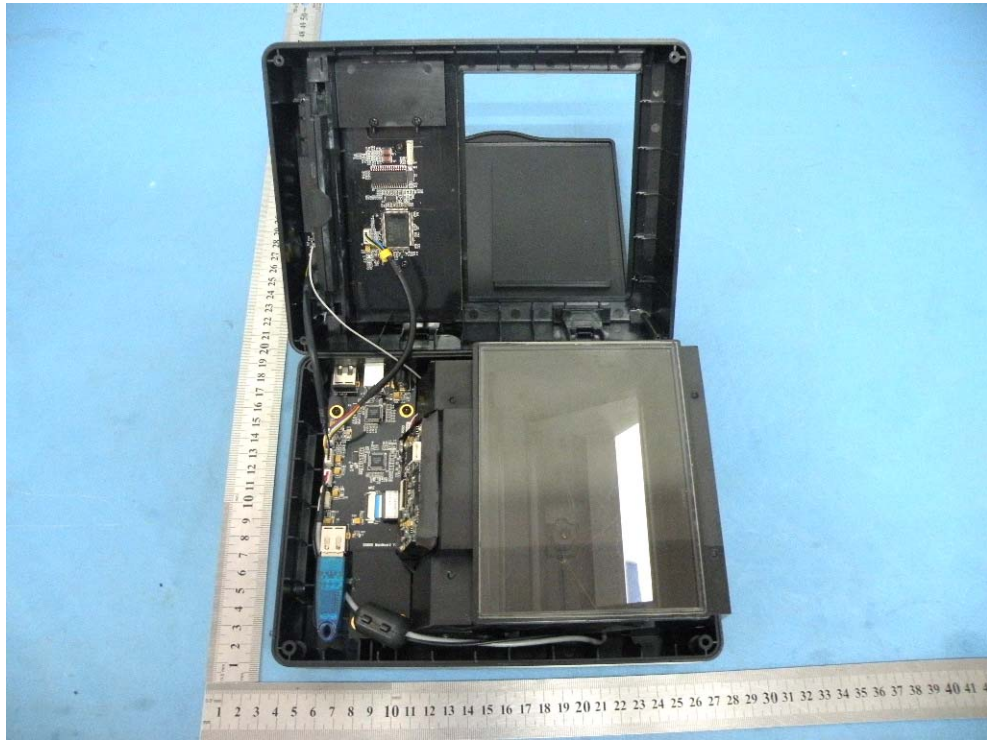

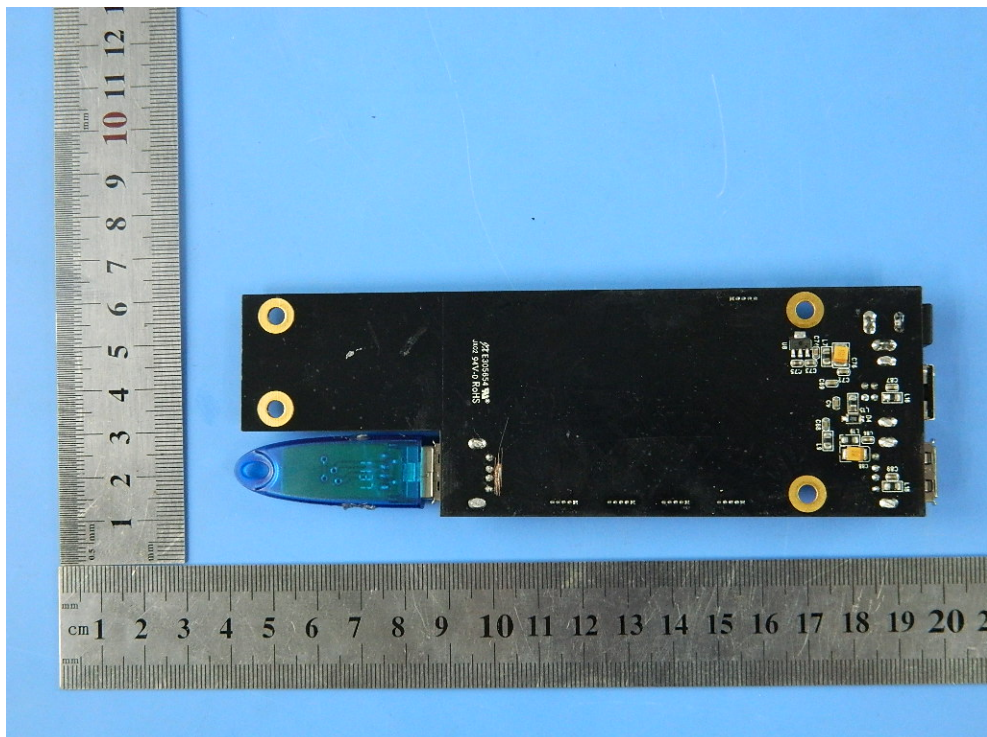
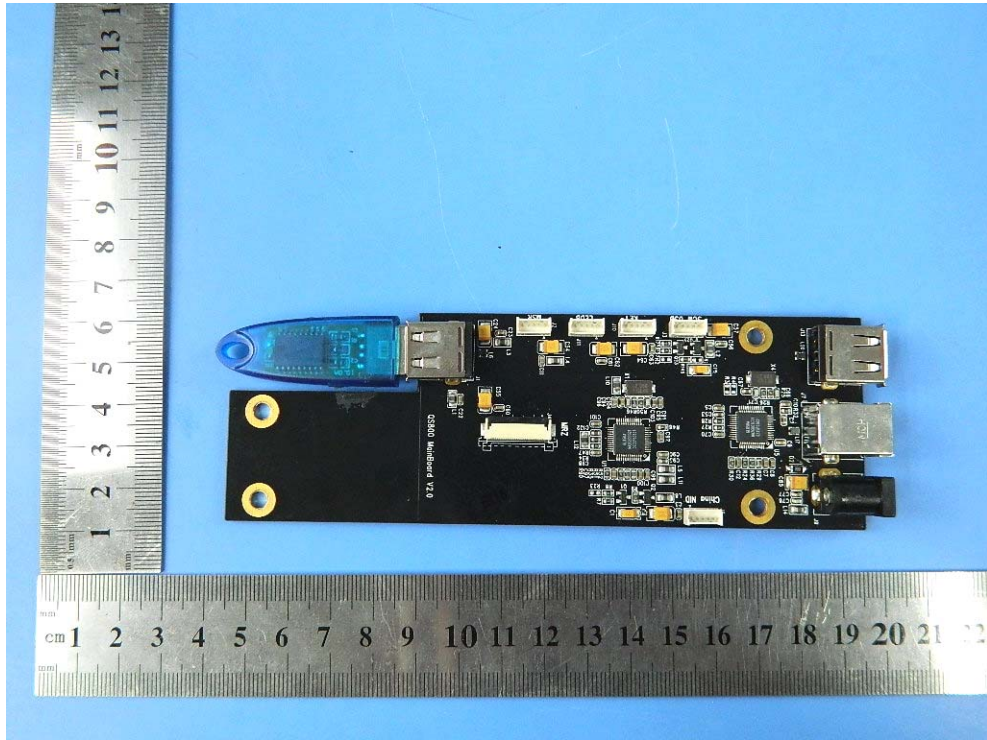

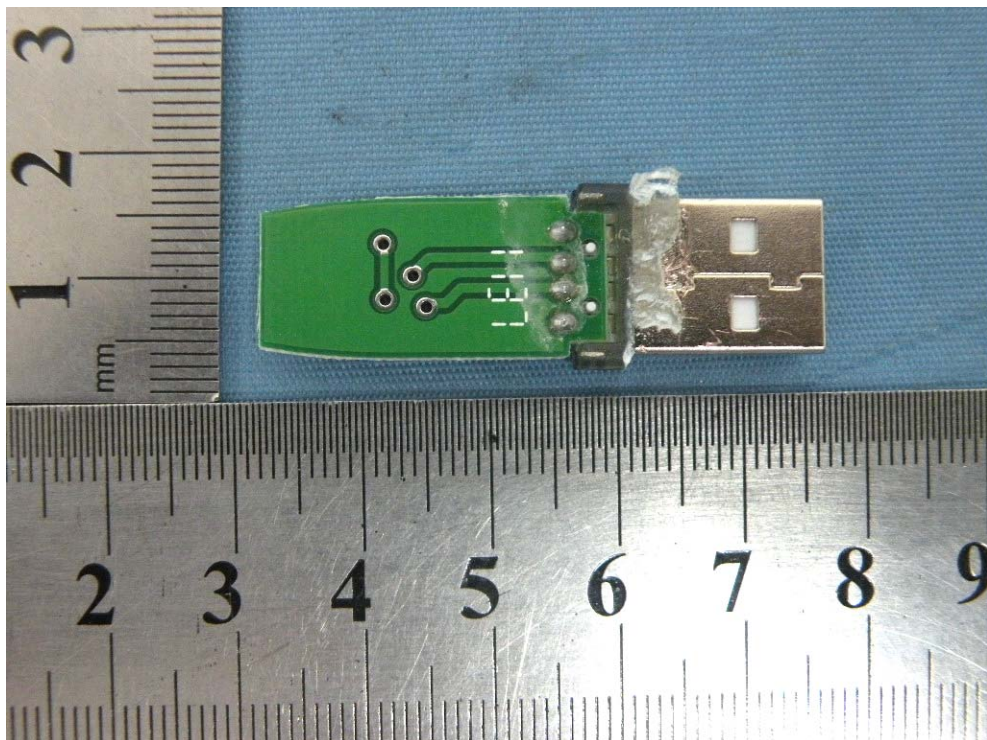
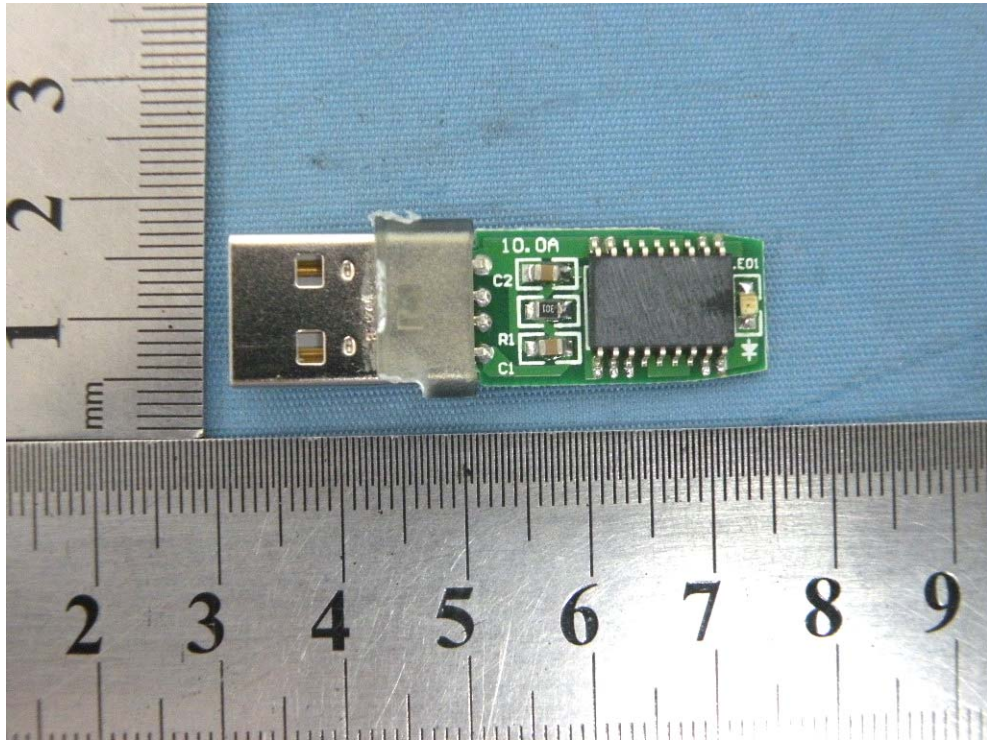

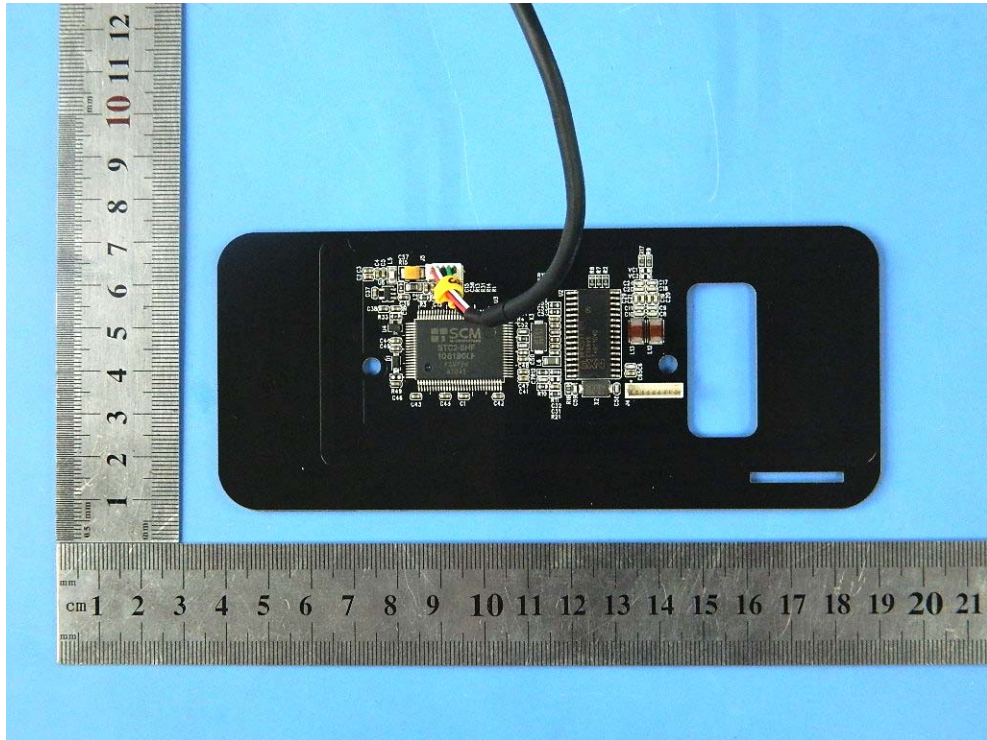

Antenna 1
SCM Reader

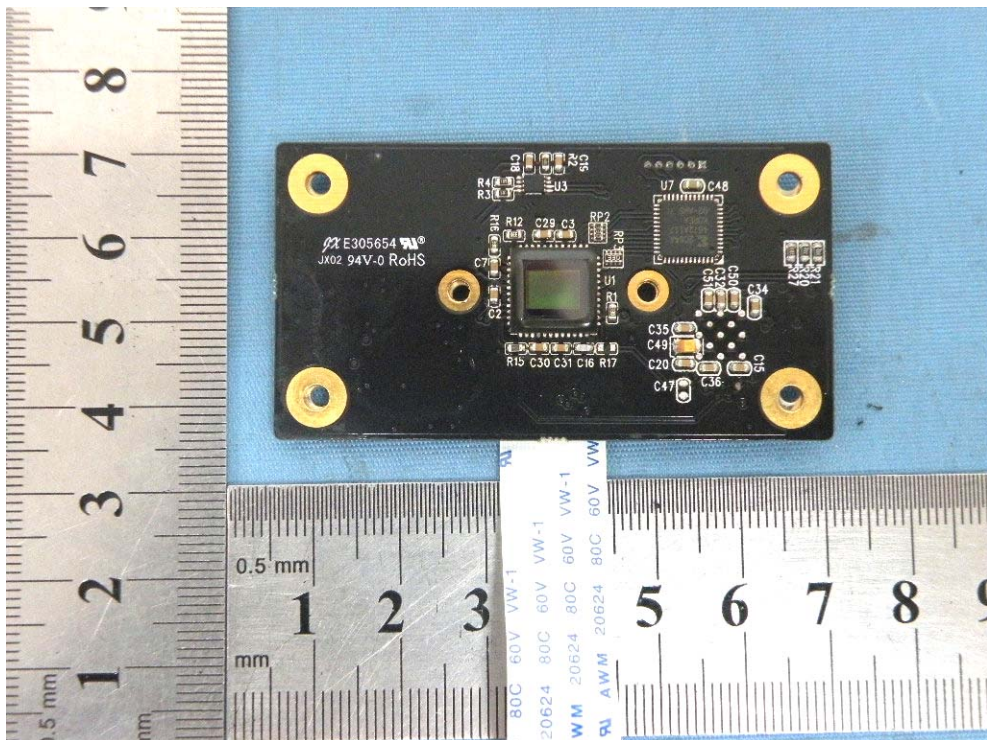
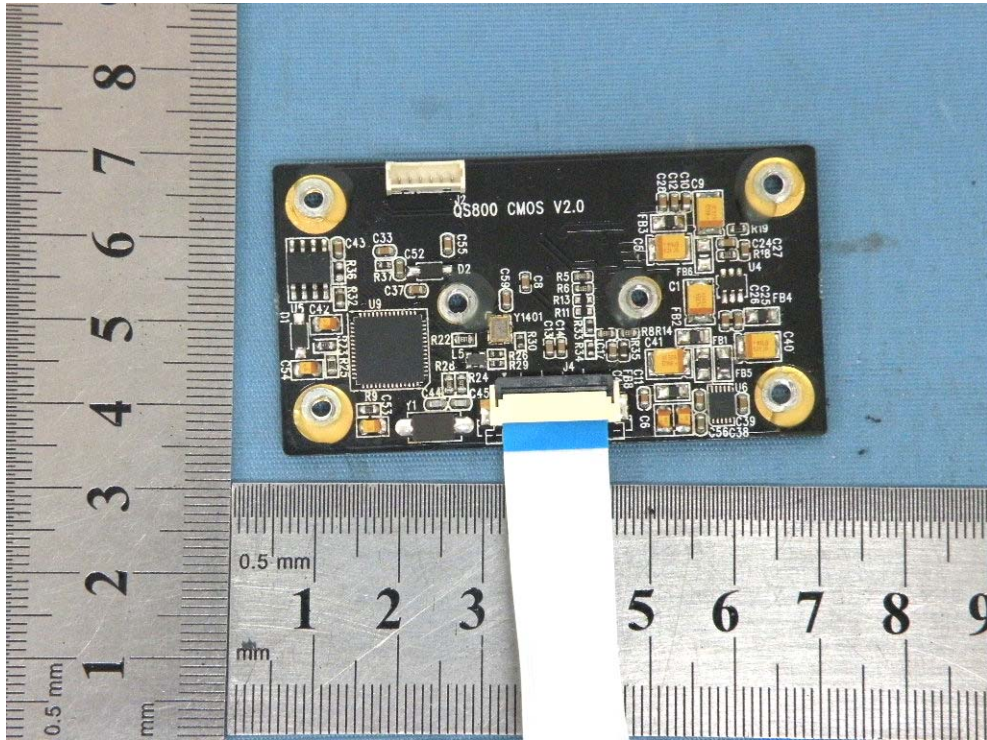

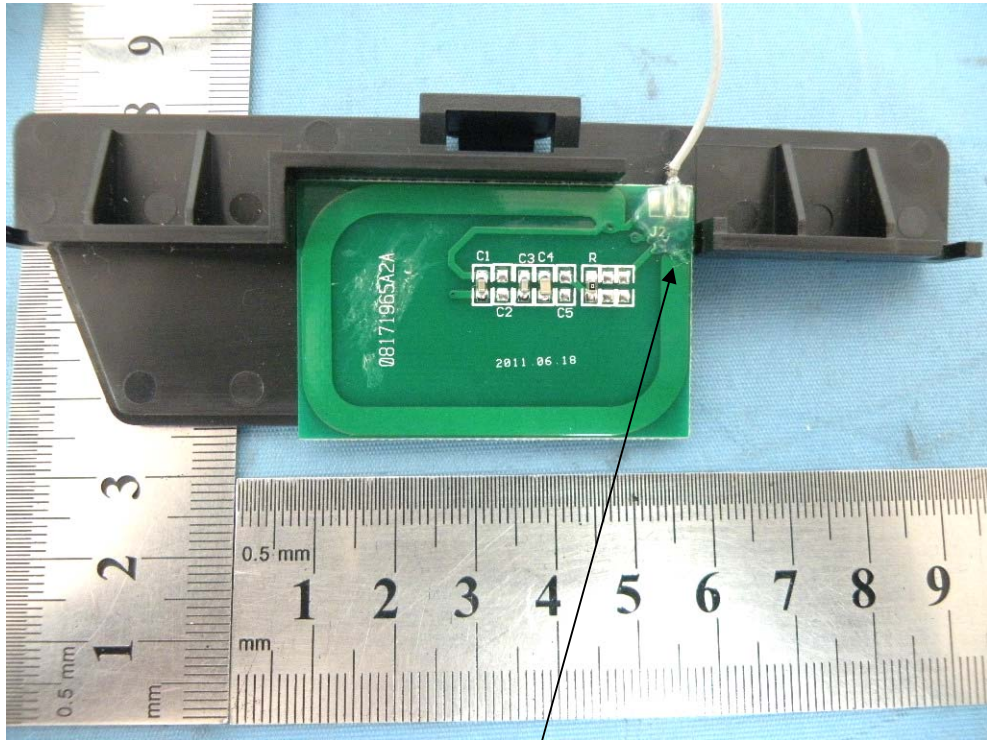

Antenna 2
Card Reader

