

MOTION

MANUAL CM-17

Table remote 4 channel

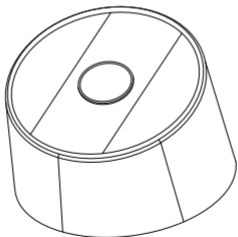

CM-17 is a table remote with 4 channels for operating single blinds or shading networks at the push of a button. Blinds can be moved to any desired position or to a preset favourite position. The organic shape and matte black colour of this remote control perfectly fit the interior of contemporary homes and buildings.

Channels	Max. blinds	Frequency	Range	Frequency emission power	Power supply
4	Unlimited	433.925 MHz	30 m with 1 concrete wall	≤2.32dBm	2 x CR2450 3.0V

Length	Width	Height	Working temperature	Certificates
70,3 mm	62,7 mm	52,3 mm	-10°C-50°C	CE



For the latest information and updated manuals, visit rtube.nl/cm-17

Safety

WARNING: Important safety instructions. Follow all instructions, since incorrect installation can lead to severe injury.

- Do not let children play with the blind and/or remote control.
- Take care that the blind can move freely and is not blocked by any objects.
- Do not paint the device.
- Keep the device dry.
- Do not drop, knock, or shake the device. Rough handling can break internal circuit boards.
- Do not ingest battery, "Chemical Burn Hazard" or equivalent wording
- This product contains a coin / button cell battery. If the coin / button cell battery is swallowed, it can cause severe internal burns in just 2 hours and can lead to death.
- Keep new and used batteries away from children. If the battery compartment does not close securely, stop using the product and keep it away from children. If you think batteries might have been swallowed or placed inside any part of the body, seek immediate medical attention.
- Replacement of a battery with an incorrect type that can defeat a safeguard.
- Disposal of a battery into fire or a hot oven, or mechanically crushing or cutting of a battery, that can result in an explosion.
- Leaving a battery in an extremely high temperature surrounding environment that can result in an explosion or the leakage of flammable liquid or gas.
- A battery subjected to extremely low air pressure that may result in an explosion or the leakage of flammable liquid or gas.

Cleaning

Follow these general rules when cleaning the outside of the device and its components:

- Use a damp, soft, lint-free cloth. Avoid getting moisture in openings.
- Do not use aerosol sprays, solvents, alcohol, or abrasives.

Service & Support

Do not perform repairs yourself. Do not attempt to open the device or disassemble it. You run the risk of electric shock and voiding the limited warranty. No user-serviceable parts are inside.

Warranty Service

First follow the advice in this manual. If the product appears to be damaged or does not function properly, go to your local dealer for instructions on how to obtain warranty service.



Recycle

This marking indicates that this product should not be disposed with other household wastes throughout the EU. To prevent possible harm to the environment or human health from uncontrolled waste disposal, recycle it responsibly to promote the sustainable reuse of material resources. To return your used device, please use the return and collection systems or contact the retailer where the product was purchased. They can take this product for environmental safe recycling.

EU Declaration

Hereby, Coullisse declares that the radio equipment type CM-17 is in compliance with directive 2014/53/EU. The full text of the EU declaration of conformity is available at the following internet address: www.my.coullisse.com

FCC Manual | FCC ID: ZY4CM17

Regulatory Information

1 FCC Information for User

This product does not contain any user-serviceable components and is to be used with approved antennas only. Any product changes or modifications will invalidate all applicable regulatory certifications and approvals.

2 FCC Electronic Emission Notices

This device complies with part 15 of the FCC Rules. Operation is subject to the following two conditions:

1. This device may not cause harmful interference
2. This device must accept any interference received, including interference that may cause undesired operation.

3 FCC Radio Frequency Interference Statement

This equipment has been tested and found to comply with the limits for a class B digital device, pursuant to Part 15 of the FCC Rules. These limits are designed to provide reasonable protection against harmful interference when the equipment is operated in a commercial environment. This equipment generates, uses and can radiate radio-frequency energy and, if not installed and used in accordance with the instructions, may cause harmful interference to radio communications.

Operation of this equipment in a residential area may cause harmful interference, in which case the user will be required to correct the interference at their own expense.

If this equipment does cause harmful interference to radio or television reception, which can be determined by turning the equipment off and on, the user is encouraged to try to correct the interference by one or more of the following measures:

- Reorient or relocate the receiving antenna
- Increase the distance separating the equipment and receiver
- Connect the equipment to an outlet on a circuit different from that to which the receiver is connected
- Consult the dealer or an experienced radio/TV technician for help

1 Buttons

i The center button has two functions: press to stop the blind, hold to move the blind to its favorite position.

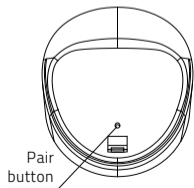
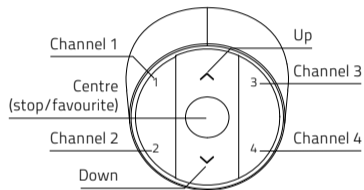

1. BUTTONS

2 Changing the battery

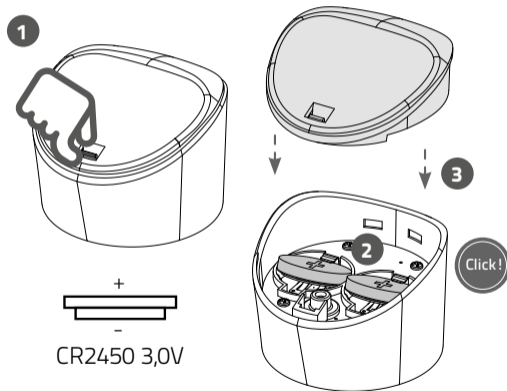

2. CHANGING THE BATTERY

3 Pair a remote

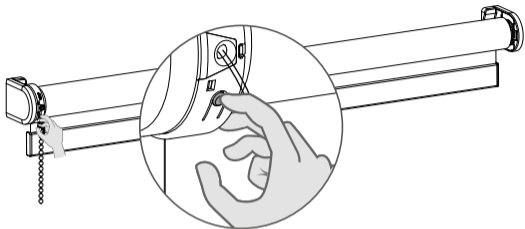

3.1 Shortly press the **program** button on the motor. The blind will start stepping, indicating that program mode has been activated.
(The blind keeps stepping until the program mode is deactivated)

3.2 Select a desired channel for the blind by pressing 1 of the 4 **channel** buttons on the remote control.

3.3 Press the **pair** button on the back of the remote control to pair the blind with the selected channel.
The blind will shortly stop stepping, indicating that the remote has been paired to the blind.

i Repeat steps 3.1 - 3.3 to remove a blind from a channel.

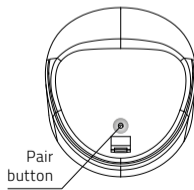
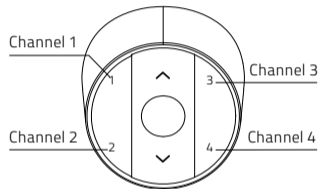

All rights reserved. No part of this publication may be reproduced, stored in a retrieval system, or transmitted, in any form, by any means, electronic, mechanical, photocopying, recording, digital or otherwise without the written permission of the publisher.

Although this manual has been composed with the utmost care, Coulisse b.v. does not accept any responsibility for damage due to mistakes and/or faults in this manual. Coulisse b.v. reserves the right to revise the manual and to revise and/or change its content at any time, without obligation to notify any person or entity of such revisions or changes.