



MODEL: ITVS-750B

WOODEN MUSIC CENTER WITH BLUETOOTH

IMPORTANT SAFETY INSTRUCTIONS	2
PRODUCT OVERVIEW	3
SETUP / BASIC OPERATION	7
REMOTE CONTROL.....	7
LISTENING TO A VINYL RECORD.....	8
LISTENING TO A CD.....	9
LISTENING TO THE RADIO.....	11
LISTENING TO AN EXTERNAL AUDIO DEVICE (AUX MODE)	11
LISTENING TO A CASSETTE TAPE.....	12
RECORDING TO A CD-R / CD-RW	12
MAINTENANCE / PROPER HANDLING.....	15
SPECIFICATIONS.....	16
TROUBLESHOOTING GUIDE.....	17



CAUTION

RISK OF ELECTRIC SHOCK
DO NOT OPEN

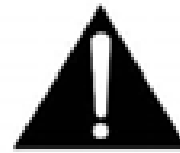

AVERTISSEMENT:

RISQUE DE CHOC ÉLECTRIQUE – NE PAS OUVRIR.

- This lightning flash with arrowhead symbol within an equilateral triangle is intended to alert the user to the presence of non-insulated “dangerous voltage” within the product’s enclosure that may be of sufficient magnitude to constitute a risk of electric shock.

- **Warning:** To reduce the risk of electric shock, do not remove cover (or back) as there are no user-serviceable parts inside. Refer servicing to qualified personnel.

- The exclamation point within an equilateral triangle is intended to alert the user to the presence of important operating and maintenance instructions in the literature accompanying the appliance.

CAUTION: To reduce the risk of fire or electric shock, do not expose this appliance to rain or moisture.

WARNING: To prevent electric shock, do not use this (polarized) plug with an extension cord, receptacle or other outlet unless the blades can be fully inserted to prevent blade exposure

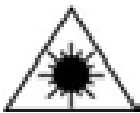

WARNING: Invisible laser radiation when open and interlock failed or defeated. Avoid direct exposure to laser beam.

PRODUCT COMPLIES WITH DHHS RULE 21 CFR SUBCHAPTER J IN EFFECT AT DATE OF MANUFACTURE

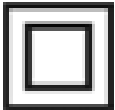

This equipment is a Class II or double insulated electrical appliance. It has been designed in such a way that it does not require a safety connection to electrical earth.

Important Safety Instructions

1. Read these instructions – All the safety and operating instructions should be read before this product is operated.
2. Keep these instructions- The safety and operating instructions should be retained for future reference.
3. Heed all warnings – All warnings on the appliance and in the operating instructions should be adhered to.
4. Follow all instructions – All operating and use instructions should be followed.
5. Do not use this apparatus near water – The appliance should not be used near water or moisture – for example, in a wet basement or near a swimming pool, and the like.
6. Clean only with dry cloth.
7. Do not block any ventilation openings. Install in accordance with the manufacturer’s instructions.
8. Do not install near any heat sources such as radiations, heat registers, stoves, or other apparatus (including amplifiers) that produce heat.
9. Do not defeat the safety purpose of the polarized or grounding plug. A polarized plug has two blades with one wider than the other. A grounding plug has two blades and a third grounding prong. The wide blade or the third prong is provided for your safety. If the provided plug does not fit into your outlet, consult an electrician for replacement of the obsolete outlet.
10. Protect the power cord from being walked on or pinched particularly at the plugs, convenience receptacles, and at the point where they exit from the apparatus.
11. Only use attachments/accessories specified by the manufacturer.
12. Use only with the cart, stand, tripod, bracket, or table specified by the manufacturer, or sold with the apparatus. When a cart or rack is used, use caution when moving the cart/apparatus combination to avoid injury from tip-over.
13. Unplug the apparatus during lightning storms or when unused for long periods of time.
14. Refer all servicing to qualified personnel. Servicing is required when the apparatus has been damaged in any way, such as power supply cord or plug is damaged, liquid has been spilled or objects have



fallen into the apparatus has been exposed to rain or moisture, does not operate normally, or has been dropped.

15.



-This lightning flash with arrowhead symbol within an equilateral triangle is intended to alert the user to the presence of non-insulated “dangerous voltage” within the product’s enclosure that may be of sufficient magnitude to constitute a risk of electric shock.

-Warning: To reduce the risk of electric shock, do not remove cover (or back) as there are no user-serviceable parts inside. Refer servicing to qualified personnel.

-The exclamation point within and equilateral triangle is intended to alert the user to the presence of important operating and maintenance instructions in the literature accompanying the appliance.

16.



This equipment is a Class II or double insulated electrical appliance. It has been designed in such a way that it does not require a safety connection to electrical earth.

17. The mains plug is used as disconnect device, the disconnect device shall remain readily operable.

18. To reduce the risk of fire or electric shock, do not expose this apparatus to rain or moisture. The apparatus shall not be exposed to dripping or splashing and that no objects filled with liquids, such as vases, shall not be placed on apparatus.





19. The use of the equipment in moderate climate.

20. The battery shall not be exposed to excessive heat such as sunshine, fire or the like.

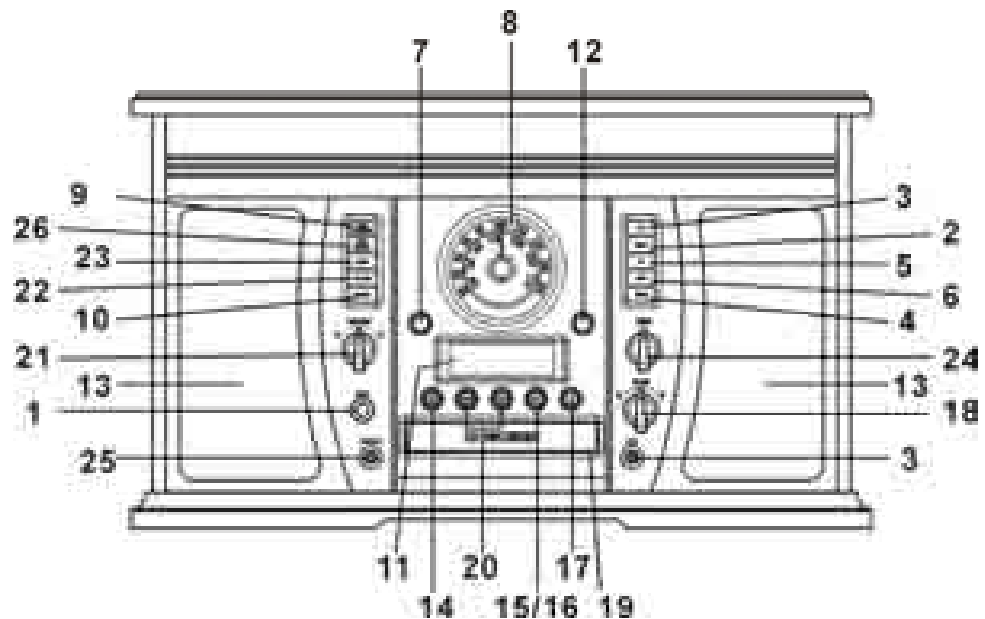
Product Overview

Front View



1. **“POWER”** Push to turn the unit on or off.
2. **“PHONO”** Press to play a vinyl record.
3. **“AUX”, “BT” & AUX IN Jack** Press “AUX/BT” to listen to an external source connected to the AUX IN jack or connected with Bluetooth.
4. **“AM/FM”** Press to listen to the radio. Press again to switch between AM and FM mode.
5. **“CD”** Press to play a CD.
6. **“TAPE”** Press to play a cassette.
7. **REMOTE SENSOR.** When using the remote control, point it towards this sensor.
8. **RADIO TUNER DISPLAY**
9. **“TRACK INCREMENT”** During recording, press to separate tracks.
10. **“RECORD”** Press to enter record pause mode.
11. **LCD DISPLAY**
12. **“TUNED ST” INDICATOR.** Illuminates when a station is correctly tuned in.
13. **STEREO SPEAKERS**
14. **STOP**  Press to stop playback or recording.
- 15/16. **PLAY/PAUSE**  Press to start playback, recording, finalizing or erasing. During playback, press again to pause.
17. **OPEN/CLOSE**  In CD, PHONO or AUX mode, use to open and close the disc tray. (*Note: This button will not work in AM/FM mode.*)
18. **“VOLUME” KNOB** Turn to adjust volume. (*Note: volume ranges from 00 to 32.*)
19. **DISC TRAY**
20. **NEXT/PREVIOUS TRACK & FF/REWIND**  In CD Mode, press once to skip to the next/previous track. Press and hold to fast forward/rewind.
21. **“REC LEVEL” KNOB** In record pause mode, turn to adjust the recording level.
22. **“FINALIZE”** Press to finalize a CD-R/CD-RW disc.
23. **“ERASE”** Press to erase or unfinalize a CD-RW disc.
24. **RADIO TUNER KNOB** In AM/FM mode, turn to tune in a station.
25. **3.5mm EARPHONE JACK** Accepts headphone/earphone plugs.
26. **AUTO /MANUAL** Press to select mode of track number assignment for recording.

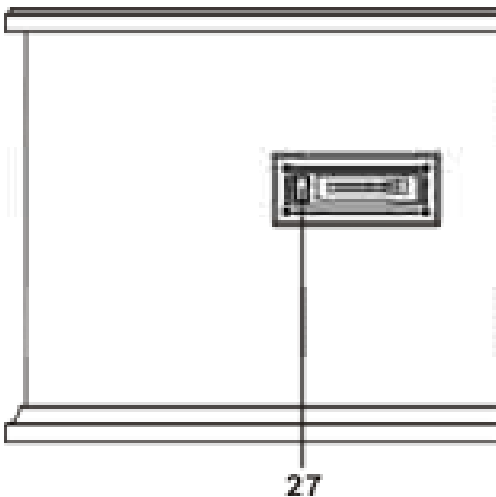

Left side View

27. CASSETTE FF & EJECT Press halfway to fast forward, press all the way to end and eject the tape.

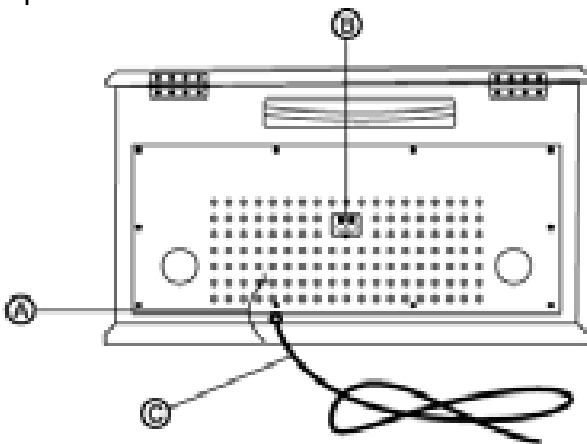

Rear View

A. FM wire antenna

While tuned to a station in FM mode, extend the wire and reposition to adjust for best reception.

B. AUX IN jacks

For audio sources with RCA jacks, insert the white and red plugs on the RCA cable into the unit. Insert the opposite end into the audio source. Be sure to connect the white plug to the white jack (Left) and the red plug to the red jack (Right).

C. AC Power Cord

Plugs into a wall outlet.

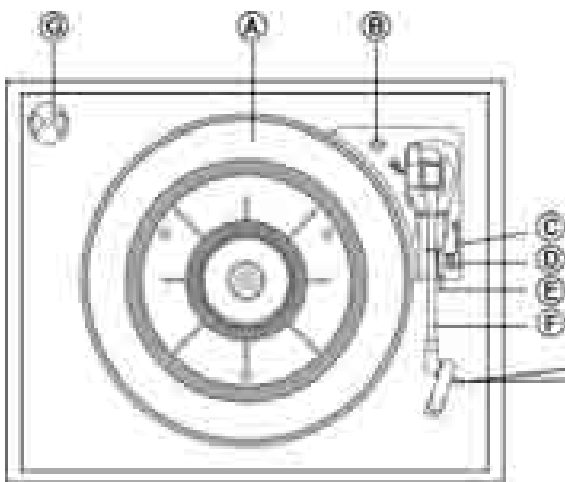

Parts of the Turntable

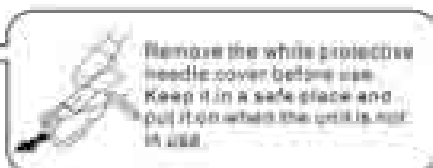

A. Turntable.

B. Safety Screw (for transport) Before using the unit, turn the screw



clockwise using a coin or screwdriver.

Important: *When you transport the unit, turn the screw counterclockwise to secure the turntable.*

The silver screw on the back of the turntable is a balancer for both the turntable as well as for the tone arm.

Please turn this screw with a coin to either left or right and test by moving your tone arm to the middle of the spindle. Please note that this screw is a balancer and will have to be adjusted until the tone arm moves freely to the end of the record (middle of the spindle) without any resistance before using the turntable phonograph.

- C. Cue-lever.** Use this lever to lift the tone arm.
- D. Speed Selector.**
- E. Tone Arm holder.**
- F. Tone Arm.** Before use, completely loosen the fixed rope on the tone arm and lift the tone arm up.
- G. 45 RPM adaptor.**

Setup / Basic Operation

Setup

1. Remove white protective needle cover by gently pulling towards front of unit.
2. Remove any packaging materials from the unit.
3. Connect the AC power cord to a wall outlet.

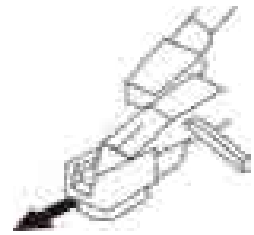
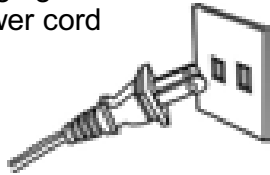

Note: To prevent interference, avoid bundling audio signal cables together with the AC power cord.

Basic Operation

1. Push the POWER button (1) to turn the unit on.
2. Select the source by pressing the corresponding mode button (AUX / PHONO / AM/FM / CD / TAPE) (2).
3. Rotate the VOLUME knob (3) to adjust to the desired sound level.

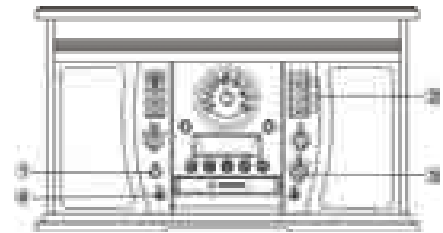

Listening through Earphones/Headphones (*not included*)

For private listening, first reduce the volume level to minimum. Insert your headphones' plug into the 3.5mm jack, then adjust the volume up by turning the VOLUME knob.

Note: The speakers will automatically be deactivated while headphones are plugged in.



CONDENSATION WARNING:

When the unit is moved from a cold or warm place, or is used following a sudden temperature change, there is the danger that water vapor in the air may condense on the unit, preventing proper operation. In such cases, leave the unit for 1-2 hours after plugging it into an AC outlet to allow it to stabilize at the temperature of its surroundings.

Remote Control

When using the remote control, point it towards the remote sensor on the front panel of the unit.

Notes:

- Even if the remote control is operated within the effective range, remote control operation may be impossible if there are any obstacles between the unit and the remote control.
- If the remote control unit is operated near other devices which generate infrared rays, it may not function properly. Conversely, the other devices may not function incorrectly.

Battery Installation

1. Remove the battery compartment cover.
2. Insert 2x "AAA" batteries.
Note: Make sure that they are oriented so their polarity markings, "+" and "-", match the remote's markings.
3. Replace the battery compartment cover.

battery compartment cover

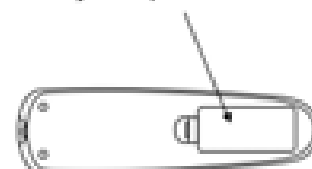

Battery Replacement

When the operating distance between the remote control unit and main unit decreases, it is necessary to replace the battery with new ones.

Battery Precautions

Be sure to insert the batteries with correct positive “+” and negative “-” orientation.

ALWAYS use batteries of the same type. Never mix different types of batteries together.

When using rechargeable batteries, refer to the precautions on their labels.

When the remote control unit is not to be used for a long time (more than a month), remove the batteries to prevent them from leaking.

Do not heat or disassemble batteries, and NEVER dispose of old batteries by throwing them in a fire.

Remote Control Button Functions

- A. “Remote Sensor”
- B. “OPEN/CLOSE” Press to open/close the disc tray.
(Note: This button will not work in AM/FM mode)
- C. “CD” Press to play a CD.
- D. “REPEAT” In CD mode, press to select a repeat mode
- E. “PROGRAM” In CD mode, press to program tracks.
- F. “SHUFFLE” In CD mode, press for shuffle playback.
- G. “DISPLAY” In CD mode, press to change the display.
- H. “TRACK INCREMENT” During recording, Press to divide tracks.
- I. “MANUAL/AUTO INCREMENT”
Press to select the mode of track number assignment.
- J. “RECORD” Press to enter record pause mode.
- K. “REC VOL+”/ “REC VOL -” In record mode, turn to adjust the recording volume.
- L. “FINALIZE” Press to finalize a CD-R/CD-RW disc.
- M. “ERASE”. Press to erase or unfinalize a CD-RW disc.
- N. “CLEAR” In CD mode, Press to clear programmed tracks.
- O. “PHONO” Press to play a vinyl record.
- P. “AUX” Press “AUX” to listen to an external source connected to the AUX IN jack.
- Q. “RADIO” Press to listen to the radio. Press again to switch between AM and FM modes.
- R. “TAPE” Press to listen to an audio cassette tape.
- S. Next/Previous Track (◀◀ / ▶▶)
& FF/Rewind
In CD Mode, press once to skip to the next/previous track. Press and hold to fast forward/rewind.
- T. “VOL+” / “VOL-” Press to adjust the volume.
- U. PLAY/PAUSE ▶|| Press to play/pause recording, finalizing and erasing.
- V. STOP ■ Press to stop playback or recording.
- W. “BT” Press “ ” to listen to an external source connected with Bluetooth.

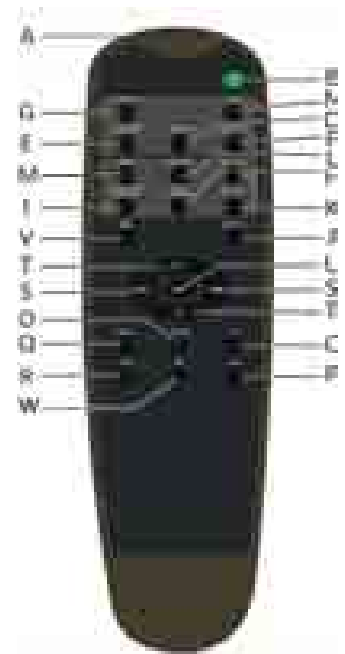

Listening to a Vinyl Record

1. Press the “PHONO” selector button.
2. Gently open the top cover.
Note: Be careful not to pinch your finger when opening/closing the top cover.
3. Place a vinyl record on the turntable. When playing a 45 RPM record, use the included adaptor.

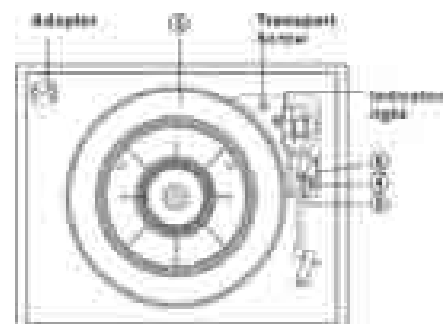

4. Select the appropriate speed (4).

5. Gently push tone arm clip (5) to the right to release the tone arm.

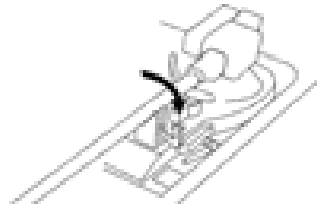

6. Raise the cue lever (6) to lift the tone arm off the tone arm support.

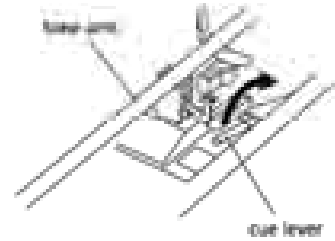

7. Move the tone arm gently to the edge of the record (or the starting point of a track). The turntable will begin to turn.

8. Gently lower the tone arm by slowly releasing the cue lever.

9. When playback is finished, the tone arm will automatically return to its holder and the indicator light will light up. The turntable will stop. To stop playback manually, slightly lift the tone arm using the cue lever and return it to the tone arm holder.

Note: It will take approximately 20 seconds for tone arm to return to its holder when playing a 78 rpm record.

Important:

- Closing the top cover will help prevent dust from settling on the turntable.
- Always relock the tone arm clip before transporting the unit.
- Do not place anything on top of the turntable cover, especially while playing a record.

Listening to a CD

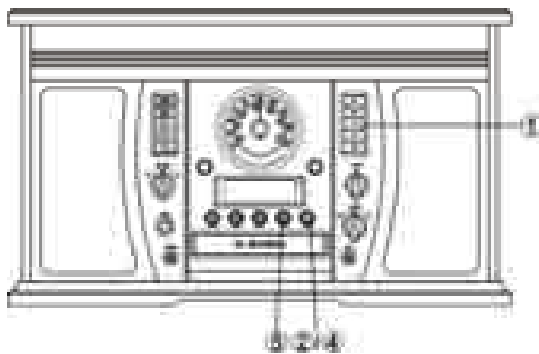

1. Press the "CD" selector button (1).

"--- BUSY CD" will blink for a few seconds.

Note: When no disc is set, "NO DISC" will appear on the display.

2. Press the OPEN/CLOSE (▲) button

(**Note:** This button will not work in AM/FM mode)

3. Place a disc on the tray with the printed label face up.



4. Press the OPEN/CLOSE button (▲) to close the tray.

5. Press the PLAY/PAUSE button (▶||) to begin playback.

6. To temporarily pause playback, press the PLAY/PAUSE button (▶||). Press again to resume.

7. To skip tracks forward or backward, press the corresponding skip button (◀◀ or ▶▶). Pressing ◀◀ once will restart the current track. Pressing ◀◀ twice in succession will return to the beginning of the previous track.

8. To fast forward / rewind within a track, press and hold down the corresponding skip button until the desired position is reached.

9. To stop playback, press the STOP ■ button

Important:

- Never place more than one disc on the tray.
- The disc must be placed in the center of the disc tray. An incorrectly loaded disc can permanently damage the tray door mechanism.
- Do not push the CD tray – always use the OPEN/CLOSE button.
- It takes a moment for the unit to load a disc, during which all buttons will be temporarily deactivated.

Display



Each time the DISPLAY button is pressed, the display mode will cycle between the following options:

- Track Number + Track Play Time (Default Display Mode)
- Track Play Time Countdown
- Track Play Time
- CD Play Time Countdown

Repeat Playback



Each time the REPEAT button is pressed, the repeat mode will cycle through the following options:

REPEAT ALL (Repeat the entire CD)
The entire CD will be played repeatedly.

REPEAT 1(Repeat one track)

The current track will be played repeatedly. If you press the (I◀◀ or ▶▶I) button to select another track, the track you select will be played repeatedly.

Notes:

- If one of the following buttons is pressed, the repeat mode will be cancelled.
OPEN/CLOSE, AM/FM, PHONO, AUX, TAPE
- Repeat playback works with finalized discs only.

Shuffle Playback

To play the tracks on a CD in a random sequence, press the SHUFFLE button during playback.



Notes:

- Pressing (▶▶I) during shuffle playback will randomly select the next track.
- If one of the following buttons is pressed, shuffle mode will be cancelled.
OPEN/CLOSE, AM/FM, PHONO, AUX, TAPE
- When the SHUFFLE playback of all the tracks has been finished, the unit stops and the shuffle mode is cancelled.
- A track cannot be repeated during shuffle playback.
- Shuffle playback does not work during programmed playback.
- Shuffle playback works with finalized discs only.

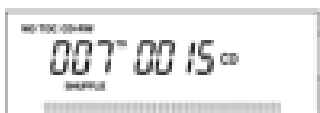

Programmed Playback

Up to 32 tracks can be programmed to play in the desired order.

Notes:

- Shuffle playback does not work during programmed playback.
- Programmed playback works with finalized discs only.

1. Press "CD" to enter CD mode, then load a CD.
2. While the CD is stopped, press the PROGRAM button.
3. "PROGRAM" indicator blinks, and "P-01" appears on the display.



4. Press (I◀◀ or ▶▶I) to select a track number.

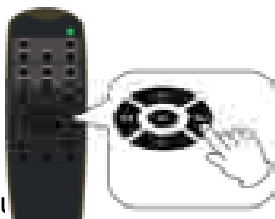

5. Press the PROGRAM button to program the current track.

6. "P-02" is displayed. Repeat steps 4 thru 5 to program the additional tracks.



7. When the selection of track numbers has been finished, press the PLAY button (▶||) to start program playback.

8. To cancel the program mode, press the STOP (■).

To check the programmed order

In the stop mode, press (◀◀ or ▶▶) repeatedly to show the track numbers that have been programmed.

To add a track to the end of the programmed order:

In the stop mode, press the PROGRAM button.

Select a track number by pressing (◀◀ or ▶▶), then press the PROGRAM button.

The current track will be added to the end of the program.

To delete the last track from the programmed order:

In the stop mode, press the CLEAR button to delete the last track from the program.

To clear the programmed order:

Press STOP when the CD is already stopped, or press OPEN/CLOSE, AM/FM, PHONO, or AUX

Listening to the Radio

1. Press the "AM/FM" button (1).
Press again to switch between AM and FM
2. Tune to the desired station
using the Radio Tuner Knob (2).

Note: In FM Mode, the "TUNED/ST" indicator lights up green when tuning the Radio Tuner Knob; The "TUNED/ST" indicator lights up orange when a station is correctly tuned in.

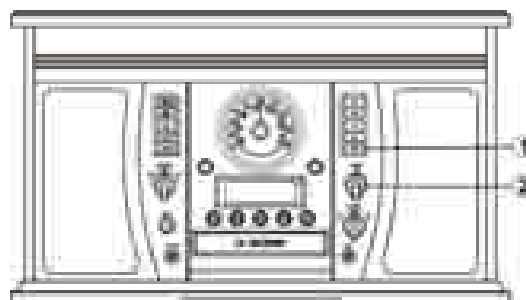

Adjusting for Best Reception

AM broadcast: Rotate the unit to find the best position.

FM broadcast: Extend and reposition the FM antenna.

Listening to an External Audio Device (AUX Mode)

In AUX (auxiliary) mode, this unit can play audio from an external audio source (iPod, MP3 Player, Portable CD Player, etc.)

There are two AUX INs (front and rear). When connecting a device that has a headphone jack, use the cable with 3.5mm plugs on either end with the front AUX IN jack.

The rear set of AUX IN jacks (red and white) can be used with devices that use RCA connections (DVD players, etc.).

1. Plug one end of the AUX IN cable (included) into the AUX IN (on the front or back of the unit).
2. Plug the other end of the cable into the headphone jack (or RCA jacks) of the external audio source.

Important: If both the front and rear AUX INs are connected to AUX IN cables at the same time, only the front one will be active.

AUX OPERATION

Please use this function to record from other sources such as CDs, karaokes and radio. We also recommend using this function to make the cassette tape to CD recording much easier. Please use the included AUX cable and connect one end to the AUX jack on the front. Connect the other end to a portable boom box or any other stereo, CD player, MP3 players, Karaoke, etc... headphone jack. Please leave the function as AUX and follow the recording instructions.

Listening to an External Audio Device (BT Mode)

In BT (Bluetooth) mode, this unit can enjoy music from external devices which have a built - in Bluetooth feature.

GETTING CONNECTED USING BLUETOOTH

1. Press "AUX/BT" selection button and the display will show "bLUE".
2. Set the Bluetooth function of your external device when the apparatus is on.
3. Set to search Bluetooth device on your external device.

NOTE: The effective distance between your external device and this apparatus is 5 meters.

4. Wait for a while then find the "Wooden Music Center" on the paired devices list on your external device and press "Wooden Music Center".

If sometimes A window will ask you a password. Fill in "0000" then press "OK" on your external device.

5. A few seconds later your Bluetooth connection is success.

NOTE: Fast forward / rewind is only available on your external device.

Listening to a Cassette Tape

1. Load an audio cassette tape into the unit (located on the left side of the unit). Playback will automatically begin.
2. Press button halfway to Fast Forward the tape.
Press button lightly and playback will resume.
3. Press button completely down to end playback and eject tape.

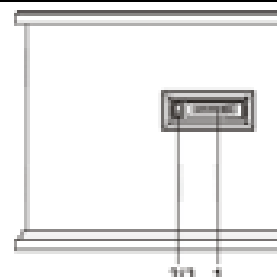

Recording to a CD-R / CD-RW

About CD-R and CD-RW discs

- CD-R discs can be recorded once only, and cannot be erased or re-recorded. However, if space is available on the disc (and the disc has not been finalized), additional material can be recorded.
- CD-RW discs allow you unfinalize the disc, and erase the last track or the entire CD. They may be reused for new recordings.

Note: CD-RW discs may not play correctly on every CD-player. CD-R, by contrast, are playable on most CD players.

Important: Never turn the power off or unplug the power cord while "--- Busy" is displayed.

Whenever "--- Busy" is displayed, all buttons will be temporarily deactivated.

Please read through all the steps below before beginning your recording.

BEFORE RECORDING

Audio from the PHONO, TAPE or AUX sources can be recorded on the CD recorder.

Prepare the audio source for recording

1. Select the desired audio recording source by pressing the corresponding selector button. (“PHONO,” “TAPE,” or “AUX”)
2. Prepare the appropriate audio source for normal play (external audio device / vinyl record / cassette tape).
3. Load a CD-R / CD-RW and close the CD tray.
4. Make sure “NO TOC” and “CD-R”(or “CD-RW”) appear on the top left of the display. If they do not appear, recording functions will not work.



Note: “NO TOC” is an abbreviation of “No table of contents,” indicating a blank CD.

Select Auto Track Increment Selection Mode

Tracks can be set to assign automatically when the input sound level drops below a certain limit (-20db/-30db/-40db) for more than 2 seconds.

Press the AUTO/MANUAL button repeatedly (or MANUAL/AUTO INCREMENT on the remote) to cycle between the following modes:

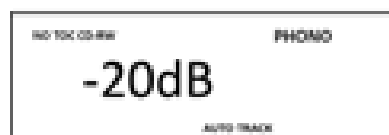

“AUTO TRACK -20db”

A new track will be assigned automatically when the sound level drops below -20db

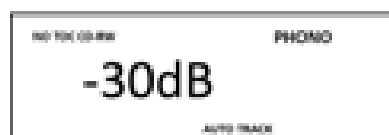

“AUTO TRACK -30db”

A new track will be assigned automatically when the sound level drops below -30db



“AUTO TRACK -40db”

A new track will be assigned automatically when the sound level drops below -40db



Manual Track Selection

Tracks will not be assigned automatically. A new track will be assigned whenever “TRACK INCREMENT” is pressed during recording.

AUTO TRACKING function is to cut the separation for each music/song you are recording to CD by recognizing the silence that is in between the songs on your records or cassette tapes. The decibels (lowest 20-30-40highest) allow you to choose the level of minimal sound that may still exist between the songs to be recognized as the separation before the next song to cut a track. If your source of the recording quality is not of best quality it is recommended to use the “MANUAL TRACKING” function for best result in recording.

RECORDING

- 1) First put the blank CD-R or CD-RW on the CD tray and close the tray.
- 2) Make sure that the display shows “NO TOC CD-R (or CD-RW).
- 3) Pick the source of music and press the button (phono or tape or aux).
- 4) If using a record, put the vinyl on the turntable.
- 5) Press RECORD button.
- 6) Adjust your recording volume to medium (you can adjust on your next recording if too loud or too low).
- 7) Place the needle on the record and then press “play/pause” button (it looks like this ►||).

- 8) Now you are recording.
- 9) When the last song is recorded from the one side of vinyl, press the “play/pause” button (▶||) to pause.
- 10) When paused, flip the record to the other side and place the needle back to play.
- 11) Press the “play/pause” button again to resume recording.
- 12) When all recording is done, wait for about 10 seconds and then press the stop button.

Entering Recording (Paused) Mode



1. Press the “RECORD” button to enter Recording (Paused) Mode. (||) will appear on the left of the screen)

If an AUTO TRACK mode is selected, “AUTO TRACK” will appear on the lower middle of the screen.

2. Test play the audio source to be recorded and adjust “REC LEVEL” Knob to set the recording volume so that its loudest output does not exceed the “OVER” indicator on the meter on the lower right of the display.

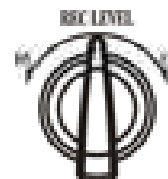

Note: Be sure not to set the recording volume too low – doing so will result in very low playback volume levels.

3. Once the recording volume level is set, reset the audio source so it is ready for recording.

Entering Recording (Play) Mode

1. Press the PLAY/PAUSE (▶||) button to begin recording. (▶) will appear on the left of the screen, indicating that recording is in progress.
2. Begin playing the audio source as normal.*

*Manual Track Increment Assignment

Note: “The TRACK INCREMENT” button works regardless of the MANUAL/AUTO REC setting. During recording, press the TRACK INCREMENT to end the current track and begin a new one. The current track number will be indicated on the display.

To Pause Recording Temporarily (Recording Paused Mode).

Press the PAUSE button (▶||). The recording process will be temporarily paused. To resume recording, press the PLAY/PAUSE button (▶||) again.

Important: Every time recording is paused or stopped, a new track number will always be assigned. It is not possible to record in two “stages” within one track.

3. Press the STOP button (■) to stop recording.

Note: When the rotation of the turntable stops, the recording will stop automatically. However, to avoid unwanted noise from the tone arm, stop the recording manually by using the STOP button.

FINALIZING A CD

- 1) After pressing stop, press the “CD” function button.
- 2) After pressing the “CD” button, “BUSY” will show on the display.
- 3) After “BUSY” disappears, the number of tracks and duration of recorded time on your CD is displayed.
- 4) Press the “FINALIZE” button and “FiN-d” will show on the display.
- 5) Then press the “PLAY/PAUSE” button.
- 6) The CD will turn and you will have “BUSY” again showing on the display.
- 7) When the CD is completely finalized, the CD tray will come out automatically and the recorded and finalized CD can be played in other players.

Before a CD-R or CD-RW can be played in a standard CD Player, it must be finalized. During finalization, a Table of Contents (TOC) is written to the CD.

Once a CD-R disc is finalized, no more tracks can be recorded on it. By contrast, a finalized CD-RW disc can be “unfinalized” to allow additional recording.

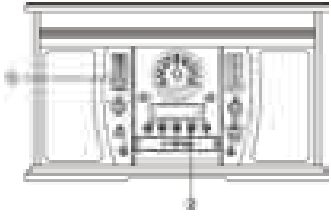

1. Press the “FINALIZE” button when in stopped mode. If you are not in stopped mode, press STOP (■). “FIN—d” will appear on the display.
Note: To cancel the finalizing process at this point, press STOP (■).
2. Press the “PLAY” (▶||) button to start finalizing. “--- BUSY” will appear on the display. Wait until this message disappears. When finalization of the disc is complete, the CD tray will open automatically.

Note: The finalization time is dependent on the contents that have been recorded, and may take a few minutes in some cases.

ERASING A CD-RW (CD-RW ONLY)

Erasing processes will only work on an unfinalized CD-RW disc.

If a CD-RW disc has been finalized, you will need to unfinalize it prior to erasure.

With a CD-RW, it is possible to erase either the last recorded track, or the entire disc.

All erasing processes are permanent – they cannot be undone.

Unfinalizing a Finalized CD

Note: Skip this process if the CD-RW has not been finalized.

1. With a finalized CD-RW loaded, press the “ERASE” button while in stopped mode. “UNF IN—d” will appear on the display.
Note: To cancel the unfinalizing process at this point, press STOP (■).
2. Press the PLAY (▶||) button to start unfinalizing. “--- BUSY” will appear on the display. When this message disappears, the disc is unfinalized.

Note: The unfinalization time is dependent on the contents that have been recorded, and may take a few minutes in some cases.

Erasing the Last Recorded Track.

1. With an unfinalized CD-RW inserted, press the “CD” selector button.
2. In stop mode, press the “ERASE” button. “ErA” and the last recorded track number will appear on the display.
3. Press the (▶||) button to erase the last track. “--- Busy” will appear on the display. It will disappear, indicating that the track has been erased permanently from the CD-RW.
4. Repeat steps 2 and 3 to continue erasing tracks one at a time.

Note: If there are no tracks on the CD-RW, the “ERASE” button will have no effect.

Note: You will not be able to erase the last recorded track from CD-RW discs copied from another device.

Erasing All Tracks

1. With an unfinalized CD-RW inserted, press the “CD” select button.
Note: To cancel the finalization process at this point, press STOP (■).
2. Press and hold the “Erase” button until “ErA ALL” appears on the display.
3. Press the (▶||) button to begin erasing all the tracks on the CD. “--- Busy” will appear on the display. It will disappear, and “000 00:00” will appear to confirm that the disc is clear.

Maintenance / Proper Handling

Compact Disc Handling

- Always place the disc on the disc tray with the label side facing upward (compact discs can be played/recorded only on one side)
- To remove a disc from its storage case, press down on the center of the case and lift the disc upward, holding it carefully by its edges.

- To clean a disc, wipe the surface from the center hole outward towards the outer edge with a soft, dry cloth.
- Never use such chemicals as record spray, antistatic sprays or fluid, benzine or thinner to clean discs; they will irreparably damage the disc's plastic surface.
- Discs should be returned to their cases after use to protect from dust and scratches.
- Do not expose discs to direct sunlight, high humidity, or high temperature for extended periods of time.
- Printable CD-R and CD-RW discs are not recommended, as the label side may become sticky and damage the unit.
- Use a soft oil-based felt-tipped pen to write information on the label side. Never use a ball-point or hard-tipped pen, as doing so may damage the recorded side.
- Do not use irregularly-shaped CDs (octagonal, heart shaped, business card size, etc), as they will damage the unit.
- Read all precautions supplied with any CD-R or CD-RW disc
- Never handle a disc with dirty fingers.
- Never insert a disc that has a crack on the surface.

Handling Vinyl Records

- Do not touch the record's grooves. Only handle records by the edges or the label with clean hands. Touching the record surface will cause your record's quality to deteriorate.
- To clean a record, use a soft anti-static cloth to gently wipe the record surface.
- Keep records in their protective sleeves when not in use.
- Always store records upright on their edges
- Avoid placing records in direct sunlight, close to a heat source (radiators, stoves, etc.), or in a location subject to vibration, excessive dust, heat, cold or moisture.

General Care

- When removing the power plug from the wall outlet, always pull directly on the plug. Never pull the cord.
- To keep the laser pickup clean, do not touch it, and do not forget to close the disc tray.
- Do not attempt to clean the unit with chemical solvents as this might damage the finish.
- For cleaning, only use a clean, dry cloth.
- In order to shut off the power to this product completely, unplug the power cord from the wall outlet. Be sure to unplug the unit if you do not intend to use it for an extended period of time.

How to Replace the Turntable Stylus

The stylus should last about 50 hours under normal use. However, it is recommended that the stylus be replaced as soon as you notice a change in sound quality. Prolonged use of a worn-out stylus may damage the record. The highest speed of 78 RPM records would wear out the stylus more quickly.

Removing the old stylus:

1. Set a screwdriver at the tip of the stylus and push downward (A).
2. Remove the stylus by pulling it simultaneously downward and forward.

Installing a new stylus:

1. Hold the front tip of the stylus and insert its rear edge (B) first.
2. Push the stylus upwards (C) until the tip locks into place.

Caution:

- Do not bend the stylus.
- Do not touch the needle to avoid injury your hand.
- Turn off the unit's power before you replace the stylus.
- Keep out of reach of children.



Specifications

GENERAL

Power Requirements	AC 120 V~ 60 Hz
Power Consumption	43W
Dimensions (W x H x D)	510x300x340mm (approx.)
Weight	12 kg. (approx.)

AMPLIFIER

Output Power 5 W + 5 W
 Frequency Response 60 to 20, 000 Hz

SPEAKER SYSTEM

Type 1-way
 Impedance 16 ohms
 Input Power Max. 10W

FM Radio

Range 88 to 108 MHz

AM Radio

Range 530 to 1710 KHz

CD PLAYER

Frequency Response 60 to 20, 000 Hz +/-4 dB
 Signal-to-Noise Ratio 55 dB (IEC-A)

CASSETTE PLAYER

Track System 4 Track, 2 channel stereo
 Tape Speed 4.8 cm/sec
 Wow and Flutter 0.4% (WRMS)
 Frequency Response 125 to 6300 Hz +/-6 dB

RECORD PLAYER

Motor DC servo motor
 Drive System Belt Drive
 Speeds 33-1/3 rpm, 45 rpm and 78 rpm
 S/N Ratio More than 50 dB
 Cartridge Type Ceramic Stereo Cartridge
 Stylus 402-M208-165

BLUETOOTH

Bluetooth Version Bluetooth V2.1+EDR
 Bluetooth Profiles HFP, A2DP, AVRCP
 Bluetooth Frequency range 2.4GHz-2.480GHz
 Operating Distance 10 meters, class II

Troubleshooting Guide

GENERAL	Symptom	Possible Cause	Solution
	• Unit will not power on.	• Unit is unplugged.	• Connect the unit to the AC power supply.

	<ul style="list-style-type: none"> No sound output from speakers. 	<ul style="list-style-type: none"> The volume level is set too low. The input selector does not match the playback source. 	<ul style="list-style-type: none"> Adjust the volume. Select the correct input source.
	<ul style="list-style-type: none"> Noise/Distortion in sound output. 	<ul style="list-style-type: none"> The unit is too close to a TV set or another interfering device. 	<ul style="list-style-type: none"> Turn off the TV or other appliance, and relocate the unit.
	<ul style="list-style-type: none"> Unit fails to respond. 	<ul style="list-style-type: none"> It might result from external factors such as ESD (Electro-static discharge). 	<ul style="list-style-type: none"> Disconnect the power cord and external audio device. Re-plug the power cord after one minute.
TAPE	<ul style="list-style-type: none"> The tape does not play. 	<ul style="list-style-type: none"> The cassette tape is not inserted properly. The tape has reached the end. 	<ul style="list-style-type: none"> Insert the cassette tape correctly. Flip the cassette.
AM/FM RADIO	<ul style="list-style-type: none"> Cannot listen to any station, or signal appears weak. 	<ul style="list-style-type: none"> The station is not tuned-in properly. A TV set is being used nearby and is interfering with the radio reception. 	<ul style="list-style-type: none"> Properly tune-in the desired station. Turn-off the interfering TV set.
	<ul style="list-style-type: none"> The sound is distorted. 	<ul style="list-style-type: none"> The antenna is not oriented properly. 	<ul style="list-style-type: none"> Re-orient the antenna until reception improves.
CD PLAYER	<ul style="list-style-type: none"> CD stops immediately after starting, or unit pauses or stops during play. 	<ul style="list-style-type: none"> The CD is inserted upside down. The CD is dusty or dirty or there is condensation on the CD. 	<ul style="list-style-type: none"> Insert the CD with the printed side right-side up. Carefully clean and dry the CD.
	<ul style="list-style-type: none"> No sound. 	<ul style="list-style-type: none"> The CD player is paused. 	<ul style="list-style-type: none"> Press the PLAY/PAUSE button.
	<ul style="list-style-type: none"> CD playback is noisy, or playback stops or skips. 	<ul style="list-style-type: none"> The CD is scratched, damaged or warped. The disc is very dirty. 	<ul style="list-style-type: none"> Replace CD with an undamaged one. Carefully clean the CD.
	<ul style="list-style-type: none"> CD tray will not open. 	<ul style="list-style-type: none"> AM/FM mode is selected. 	<ul style="list-style-type: none"> Select AUX, PHONO, CD, or TAPE mode.
	<ul style="list-style-type: none"> Buttons are not functioning correctly. 	<ul style="list-style-type: none"> The unit is processing information (“--- Busy” is displayed) The unit needs to be restarted 	<ul style="list-style-type: none"> Wait until the unit finishes processing. Turn the unit off, then on again.
PHONO	<ul style="list-style-type: none"> Decline in turntable audio performance 	<ul style="list-style-type: none"> The turntable stylus is worn out 	<ul style="list-style-type: none"> Replace the stylus.
AUX	<ul style="list-style-type: none"> No sound output with external audio device plugged into rear AUX in jack. 	<ul style="list-style-type: none"> Both AUX in jacks (front and rear) are plugged. 	<ul style="list-style-type: none"> Unplug the front AUX in Jack.

Bluetooth	<ul style="list-style-type: none"> • No sound 	<ul style="list-style-type: none"> • The unit is not switch to Bluetooth mode • Your device's and/or the unit's volume not turn up. • Your device is too far from the unit or there're some obstacle between your device and the unit 	<ul style="list-style-type: none"> • Ensure the unit is switched to Aux/ BT mode. • Move your Bluetooth device closer to unit • Turn up the volume on your portable device and/or the unit. • Turn off your Bluetooth device and unit then power them both back on
	<ul style="list-style-type: none"> • Sound is garbled 	<ul style="list-style-type: none"> • Your device's and/or the unit's volume not adjust properly. 	<ul style="list-style-type: none"> • Turn down the volume on your device/phone and the unit
	<ul style="list-style-type: none"> • Unable to pair with a Bluetooth device 	<ul style="list-style-type: none"> • Your device doesn't have Bluetooth connectivity. • The Bluetooth pairing is not successful 	<ul style="list-style-type: none"> • Confirm that your device is Bluetooth compatible. • Repair the unit and device again.

FCC Statement

This device complies with Part 15 of the FCC Rules. Operation is subject to the following two conditions:

(1) This device may not cause harmful interference, and (2) this device must accept any interference received, including interference that may cause undesired operation.

NOTE: This equipment has been tested and found to comply with the limits for a Class B digital device, pursuant to Part 15 of the FCC Rules. These limits are designed to provide reasonable protection against harmful interference in a residential installation. This equipment generates uses and can radiate radio frequency energy and, if not installed and used in accordance with the instructions, may cause harmful interference to radio communications. However, there is no guarantee that interference will not occur in a particular installation. If this equipment does cause harmful interference to radio or television reception, which can be determined by turning the equipment off and on, the user is encouraged to try to correct the interference by one of the following measures:

- Reorient or relocate the receiving antenna.
- Increase the separation between the equipment and receiver.
- Connect the equipment into an outlet on a circuit different from that to which the receiver is connected.
- Consult the dealer or an experienced radio/TV technician for help.

WARNING: Any changes or modifications not expressly approved by the party responsible for compliance could void the user's authority to operate this equipment.

The device must not be co-located or operating in conjunction with any other antenna or transmitter.

This device complies with FCC and IC radiation exposure limits set forth for an uncontrolled environment.

The device should be installed and operated with a minimum distance of 20cm between the radiator and your body.

IC statement

This device complies with RSS247 of Industry Canada. Cet appareil se conforme à RSS247 de Canada d'Industrie. This device complies with Industry Canada license-exempt RSS standard(s). Operation is subject to the following two conditions: (1) this device may not cause interference, and (2) this device must accept any interference, including interference that may cause undesired operation of the device. appareils radio exempts de licence. Son fonctionnement est sujet aux deux conditions suivantes: (1) le dispositif ne doit pas produire de brouillage préjudiciable, et (2) ce dispositif doit accepter tout brouillage reçu, y compris un brouillage susceptible de provoquer un fonctionnement indésirable.

Radiation Exposure Statement: The product complies with the Canada mobile RF exposure limit set forth for an uncontrolled environment and are safe for intended operation as described in this manual.

The further RF exposure reduction can be achieved if the product can be kept as far as possible from the user body or set the device to lower output power if such function is available.

Déclaration d'exposition aux radiations : Le produit est conforme aux limites d'exposition pour les appareils mobile RF pour les Etats-Unis et le Canada établies pour un environnement non contrôlé.

Le produit est sûr pour un fonctionnement tel que décrit dans ce manuel. La réduction aux expositions RF peut être augmentée si l'appareil peut être conservé aussi loin que possible du corps de l'utilisateur ou que le dispositif est réglé sur la puissance de sortie la plus faible si une telle fonction est disponible.

CALIFORNIA PROP 65 WARNING

"WARNING" This product contains chemicals known to the State of California to cause birth defects or other reproductive harm. For more information on these regulations and a list of chemicals, log on the following website address :

<http://www.oehha.ca.gov/prop65.html>