



Test Report No.: RF2209WDG0031



TEST REPORT

Applicant	Guangdong Leetac Electronics Technology Co.,Ltd.
Address	No.15 Danli Road, South District, Zhongshan, Guangdong, China.

Manufacturer or Supplier	Guangdong Leetac Electronics Technology Co.,Ltd.
Address	No.15 Danli Road, South District, Zhongshan, Guangdong, China.
Product	Turntable
Brand Name	Leetac, MITCHELL ACOUSTICS
Model	E-E48G
Additional Models & Model Difference	uStream TT2, E-E48x (where "x" can be replaced by digit 0-9 or letter A-Z); See items 3.1
Date of tests	Sep. 08, 2022 ~ Sep. 20, 2022

the tests have been carried out according to the requirements of the following standards:

FCC Part 15, Subpart C, Section 15.247

CONCLUSION: The submitted sample was found to COMPLY with the test requirement

Tested by Andy Zhu
Supervisor / EMC Department

Approved by Glyn He
Assistant Manager / EMC Department

Date: Oct. 27, 2022

This report is governed by, and incorporates by reference, the Conditions of Testing as posted at the date of issuance of this report at <http://www.bureauveritas.com/home/about-us/our-business/cps/about-us/terms-conditions/> and is intended for your exclusive use. Any copying or replication of this report to or for any other person or entity, or use of our name or trademark, is permitted only with our prior written permission. This report sets forth our findings solely with respect to the test samples identified herein. The results set forth in this report are not indicative or representative of the quality or characteristics of the lot from which a test sample was taken or any similar or identical product unless specifically and expressly noted. Our report includes all of the tests requested by you and the results thereof based upon the information that you provided to us. Measurement uncertainty is only provided upon request for accredited tests. Statements of conformity are based on simple acceptance criteria without taking measurement uncertainty into account, unless otherwise requested in writing. You have 60 days from date of issuance of this report to notify us of any material error or omission caused by our negligence or if you require measurement uncertainty; provided, however, that such notice shall be in writing and shall specifically address the issue you wish to raise. A failure to raise such issue within the prescribed time shall constitute your unqualified acceptance of the completeness of this report, the tests conducted and the correctness of the report contents



Test Report No.: RF2209WDG0031

TABLE OF CONTENTS

RELEASE CONTROL RECORD	5
1 SUMMARY OF TEST RESULTS.....	6
2 MEASUREMENT UNCERTAINTY	6
3 GENERAL INFORMATION	7
3.1 GENERAL DESCRIPTION OF EUT.....	7
3.2 DESCRIPTION OF TEST MODES.....	8
3.2.1 CONFIGURATION OF SYSTEM UNDER TEST	9
3.2.2 TEST MODE APPLICABILITY AND TESTED CHANNEL DETAIL.....	9
3.3 GENERAL DESCRIPTION OF APPLIED STANDARDS.....	11
3.4 DESCRIPTION OF SUPPORT UNITS.....	11
3.5 CONFIGURATION OF SYSTEM UNDER TEST.....	11
4 TEST TYPES AND RESULTS.....	12
4.1. CONDUCTED EMISSION MEASUREMENT	12
4.1.1 LIMITS OF CONDUCTED EMISSION MEASUREMENT	12
4.1.2 TEST INSTRUMENTS.....	12
4.1.3 TEST PROCEDURES	13
4.1.4 DEVIATION FROM TEST STANDARD	13
4.1.5 TEST SETUP.....	14
4.1.6 EUT OPERATING CONDITIONS	14
4.1.7 TEST RESULTS.....	15
4.2. RADIATED EMISSION AND BANDEDGE MEASUREMENT	17
4.2.1 LIMITS OF RADIATED EMISSION AND BANDEDGE MEASUREMENT	17
4.2.2 TEST INSTRUMENTS.....	18
4.2.3 TEST PROCEDURES	19
4.2.4 DEVIATION FROM TEST STANDARD	20
4.2.5 TEST SETUP.....	20
4.2.6 EUT OPERATING CONDITIONS	21
4.2.7 TEST RESULTS.....	22
4.3 NUMBER OF HOPPING FREQUENCY USED.....	30
4.3.1 LIMIT OF HOPPING FREQUENCY USED	30
4.3.2 TEST SETUP.....	30
4.3.3 TEST INSTRUMENTS.....	30
4.3.4 TEST PROCEDURES	31
4.3.5 DEVIATION FROM TEST STANDARD	31



Test Report No.: RF2209WDG0031

4.3.6	TEST RESULTS.....	31
4.4	DWELL TIME ON EACH CHANNEL	34
4.4.1	LIMIT OF DWELL TIME USED	34
4.4.2	TEST SETUP	34
4.4.3	TEST INSTRUMENTS.....	34
4.4.4	TEST PROCEDURES	34
4.4.5	DEVIATION FROM TEST STANDARD	35
4.4.6	TEST RESULTS.....	35
4.5	CHANNEL BANDWIDTH.....	38
4.5.1	LIMITS OF CHANNEL BANDWIDTH	38
4.5.2	TEST SETUP	38
4.5.3	TEST INSTRUMENTS.....	38
4.5.4	TEST PROCEDURE	38
4.5.5	DEVIATION FROM TEST STANDARD	38
4.5.6	EUT OPERATING CONDITION.....	38
4.5.7	TEST RESULTS.....	39
4.6	HOPPING CHANNEL SEPARATION	43
4.6.1	LIMIT OF HOPPING CHANNEL SEPARATION	43
4.6.2	TEST SETUP	43
4.6.3	TEST INSTRUMENTS.....	43
4.6.4	TEST PROCEDURES	43
4.6.5	DEVIATION FROM TEST STANDARD	43
4.6.6	TEST RESULTS.....	44
4.7	CONDUCTED OUTPUT POWER	48
4.7.1	LIMITS OF CONDUCTED OUTPUT POWER MEASUREMENT.....	48
4.7.2	TEST SETUP	48
4.7.3	TEST INSTRUMENTS.....	48
4.7.4	TEST PROCEDURES	48
4.7.5	DEVIATION FROM TEST STANDARD	48
4.7.6	EUT OPERATING CONDITION.....	49
4.7.7	TEST RESULTS.....	49
4.8	OUT OF BAND EMISSION MEASUREMENT	51
4.8.1	LIMITS OF OUT OF BAND EMISSION MEASUREMENT	51
4.8.2	TEST INSTRUMENTS.....	51
4.8.3	TEST PROCEDURE	51
4.8.4	DEVIATION FROM TEST STANDARD	51
4.8.5	EUT OPERATING CONDITION.....	51



**BUREAU
VERITAS**

Test Report No.: RF2209WDG0031

4.8.6	TEST RESULTS.....	51
5	PHOTOGRAPHS OF THE TEST CONFIGURATION.....	56
6	APPENDIX A - MODIFICATIONS RECORDERS FOR ENGINEERING CHANGES TO THE EUT BY THE LAB	57



Test Report No.: RF2209WDG0031

RELEASE CONTROL RECORD

ISSUE NO.	REASON FOR CHANGE	DATE ISSUED
RF2209WDG0031	Original release	Oct. 27, 2022

1 SUMMARY OF TEST RESULTS

The EUT has been tested according to the following specifications:

APPLIED STANDARD: FCC Part 15, Subpart C			
STANDARD SECTION	TEST TYPE AND LIMIT	RESULT	REMARK
15.207	AC Power Conducted Emission	PASS	Meet the requirement of limit.
15.247(a)(1)(iii)	Number of Hopping Frequency Used	PASS	Meet the requirement of limit.
15.247(a)(1)(iii)	Dwell Time on Each Channel	PASS	Meet the requirement of limit.
15.247(a)(1)	1. Hopping Channel Separation 2. Spectrum Bandwidth of a Frequency Hopping Sequence Spread Spectrum System	PASS	Meet the requirement of limit.
15.247(b)	Conducted Output Power	PASS	Meet the requirement of limit.
15.247(d)&15.209	Transmitter Radiated Emission	PASS	Meet the requirement of limit.
15.247(d)	Out of band Emission Measurement	PASS	Meet the requirement of limit.
15.203	Antenna Requirement	PASS	No antenna connector is used.

2 MEASUREMENT UNCERTAINTY

Where relevant, the following measurement uncertainty levels have been estimated for tests performed on the EUT as specified in CISPR 16-4-2:

MEASUREMENT	FREQUENCY	UNCERTAINTY
Conducted emissions	9kHz~30MHz	3.36dB
Radiated emissions	9KHz ~ 30MHz	2.66dB
	30MHz ~ 1GMHz	4.06dB
	1GHz ~ 18GHz	4.90dB
	18GHz ~ 40GHz	4.58dB

This uncertainty represents an expanded uncertainty expressed at approximately the 95% confidence level using a coverage factor of k=2.

3 GENERAL INFORMATION

3.1 GENERAL DESCRIPTION OF EUT

PRODUCT	Turntable
MODEL NO.	E-E48G
ADDITIONAL MODELS	uStream TT2, E-E48x (where "x" can be replaced by digit 0-9 or letter A-Z)
FCC ID	ZXNLEETACEE48G
POWER SUPPLY	AC 120-240V 50/60Hz
MODULATION TECHNOLOGY	FHSS
MODULATION TYPE	GFSK, $\pi/4$ DQPSK, 8DPSK
OPERATING FREQUENCY	2402MHz~2480MHz
NUMBER OF CHANNEL	79
PEAK OUTPUT POWER	2.432mW (Max. Measured)
ANTENNA TYPE	PCB Antenna, -0.58dBi Gain
I/O PORTS	Refer to user's manual
CABLE SUPPLIED	USB Line: Shielded, detachable, 1.3m AC Line: Unshielded, detachable, 1.5m Line out Line: Unshielded, detachable, 1.2m
ACCESSORY	N/A

NOTES:

1. For a more detailed features description, please refer to the manufacturer's specifications or the user's manual.
2. For the test results, the EUT had been tested with all conditions. But only the worst case was shown in test report.
3. Please refer to the EUT photo document (Reference No.: 2209WDG0031) for detailed product photo.
4. Additional models (see above table) are identical with the test model E-E48G except the model NO. and exterior color for trading purpose.
5. Leetac can be used for E-E48G and E-E48x. MITGCHELL ACOUSTICS can be used for uStream TT2.

3.2 DESCRIPTION OF TEST MODES

79 channels are provided to this EUT:

CHANNEL	FREQ. (MHz)	CHANNEL	FREQ. (MHz)	CHANNEL	FREQ. (MHz)	CHANNEL	FREQ. (MHz)
0	2402	20	2422	40	2442	60	2462
1	2403	21	2423	41	2443	61	2463
2	2404	22	2424	42	2444	62	2464
3	2405	23	2425	43	2445	63	2465
4	2406	24	2426	44	2446	64	2466
5	2407	25	2427	45	2447	65	2467
6	2408	26	2428	46	2448	66	2468
7	2409	27	2429	47	2449	67	2469
8	2410	28	2430	48	2450	68	2470
9	2411	29	2431	49	2451	69	2471
10	2412	30	2432	50	2452	70	2472
11	2413	31	2433	51	2453	71	2473
12	2414	32	2434	52	2454	72	2474
13	2415	33	2435	53	2455	73	2475
14	2416	34	2436	54	2456	74	2476
15	2417	35	2437	55	2457	75	2477
16	2418	36	2438	56	2458	76	2478
17	2419	37	2439	57	2459	77	2479
18	2420	38	2440	58	2460	78	2480
19	2421	39	2441	59	2461		

3.2.1 CONFIGURATION OF SYSTEM UNDER TEST

Please see section 5 photograph of the test configuration for reference.

3.2.2 TEST MODE APPLICABILITY AND TESTED CHANNEL DETAIL

Pre-Scan has been conducted to determine the worst-case mode from all possible combinations between available modulations, data rates, power supply voltage range and antenna ports. Following channel(s) was (were) selected for the final test as listed below:

EUT CONFIGURE MODE	APPLICABLE TO				DESCRIPTION
	RE<1G	RE≥1G	PLC	APCM	
A	√	√	√	√	AC 120V 60Hz with BT link

Where **RE<1G**: Radiated Emission below 1GHz
PLC: Power Line Conducted Emission

RE≥1G: Radiated Emission above 1GHz
APCM: Antenna Port Conducted Measurement

RADIATED EMISSION TEST (BELOW 1 GHz):

- Pre-Scan has been conducted to determine the worst-case mode from all possible combinations between available modulations, X axis, antenna ports (if EUT with antenna diversity architecture) and packet type.
- Following channel(s) was (were) selected for the final test as listed below.

EUT CONFIGURE MODE	AVAILABLE CHANNEL	TESTED CHANNEL	MODULATION TECHNOLOGY	MODULATION TYPE	PACKET TYPE
A	0 to 78	39	FHSS	GFSK	DH5

For the test results, only the worst case was shown in test report.

RADIATED EMISSION TEST (ABOVE 1 GHz):

- Pre-Scan has been conducted to determine the worst-case mode from all possible combinations between available modulations, X axis, antenna ports (if EUT with antenna diversity architecture) and packet type.
- Following channel(s) was (were) selected for the final test as listed below.

EUT CONFIGURE MODE	AVAILABLE CHANNEL	TESTED CHANNEL	MODULATION TECHNOLOGY	MODULATION TYPE	PACKET TYPE
A	0 to 78	0, 39, 78	FHSS	GFSK	DH5
	0 to 78	0, 39, 78	FHSS	8DPSK	3DH5

POWER LINE CONDUCTED EMISSION TEST:

- Pre-Scan has been conducted to determine the worst-case mode from all possible combinations between available modulations, antenna ports (if EUT with antenna diversity architecture), and packet types.
- Following channel(s) was (were) selected for the final test as listed below.

EUT CONFIGURE MODE	AVAILABLE CHANNEL	TESTED CHANNEL	MODULATION TECHNOLOGY	MODULATION TYPE	PACKET TYPE
A	0 to 78	Hopping	FHSS	GFSK	DH5

ANTENNA PORT CONDUCTED MEASUREMENT:

- This item includes all test value of each mode, but only includes spectrum plot of worst value of each mode.
- Pre-Scan has been conducted to determine the worst-case mode from all possible combinations between available modulations, antenna ports (if EUT with antenna diversity architecture), and packet types.
- Following channel(s) was (were) selected for the final test as listed below.

EUT CONFIGURE MODE	AVAILABLE CHANNEL	TESTED CHANNEL	MODULATION TECHNOLOGY	MODULATION TYPE	PACKET TYPE
A	0 to 78	0, 39, 78	FHSS	GFSK	DH5
	0 to 78	0, 39, 78	FHSS	8DPSK	3DH5

TEST CONDITION:

APPLICABLE TO	ENVIRONMENTAL CONDITIONS	TEST VOLTAGE (SYSTEM)	TESTED BY
RE<1G	25deg. C, 55%RH	AC 120V 60Hz	Jelly
RE≥1G	25deg. C, 55%RH	AC 120V 60Hz	Jelly
PLC	25deg. C, 55%RH	AC 120V 60Hz	Ryker
APCM	25deg. C, 60%RH	AC 120V 60Hz	Ryker

3.3 GENERAL DESCRIPTION OF APPLIED STANDARDS

The EUT is a RF Product. According to the specifications of the manufacturer, it must comply with the requirements of the following standards:

- FCC Part 15, Subpart C. Section 15.247**
- KDB 558074 D01 15.247 Meas Guidance v05r02**
- ANSI C63.10-2013**

All test items have been performed and recorded as per the above standards.

3.4 DESCRIPTION OF SUPPORT UNITS

The EUT has been tested as an independent unit together with other necessary accessories or support units. The following support units or accessories were used to form a representative test configuration during the tests.

NO.	PRODUCT	BRAND	MODEL NO.	SERIAL NO.	FCC ID
1	Dummy load	N/A	N/A	N/A	N/A

NO.	SIGNAL CABLE DESCRIPTION OF THE ABOVE SUPPORT UNITS
1	N/A

3.5 CONFIGURATION OF SYSTEM UNDER TEST

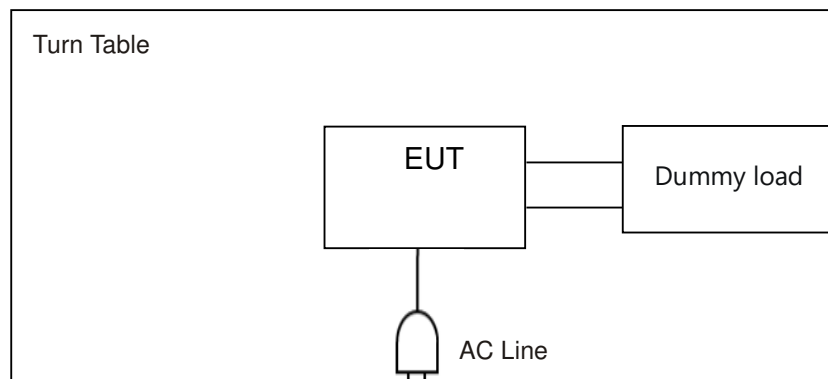

4 TEST TYPES AND RESULTS

4.1. CONDUCTED EMISSION MEASUREMENT

4.1.1 LIMITS OF CONDUCTED EMISSION MEASUREMENT

FREQUENCY OF EMISSION (MHz)	CONDUCTED LIMIT (dB μ V)	
	Quasi-peak	Average
0.15 ~ 0.5	66 to 56	56 to 46
0.5 ~ 5	56	46
5 ~ 30	60	50

- NOTES:**
1. The lower limit shall apply at the transition frequencies.
 2. The limit decreases in line with the logarithm of the frequency in the range of 0.15 to 0.50MHz.
 3. All emanations from a class A/B digital device or system, including any network of conductors and apparatus connected thereto, shall not exceed the level of field strengths specified above.

4.1.2 TEST INSTRUMENTS

Equipment	Manufacturer	Model No.	Serial No.	Next Cal.
EMI Test Receiver	Rohde&Schwarz	ESCI	100666	Jun. 14, 23
Artificial Mains Network	Rohde&Schwarz	ENV216	102477	Jun. 19, 23
Artificial Mains Network	SCHWARZBECK	NSLK 8127	8127713	Apr. 18, 23
Voltage Probe	SCHWARZBECK	TK 9421	9421-0332	Jun. 23, 23
Current Probe	Rohde&Schwarz	EZ-17	0816.2063.02	Apr. 19, 23
ISN	Rohde&Schwarz	ENY81-CA6	101928	Jun. 14, 23
ISN	TESEQ	ISN T800	34373	Feb. 16, 23
Coaxial RF Cable	COMMATE	CFD300-NL	5D-001	Oct. 19, 22
Shielding Room	Burgeon	5m*4m*3m	D3040008DG-1	July 22, 24
Test software	ADT	ADT_Cond_V7.3.7	N/A	N/A

- NOTES:**
1. The test was performed in shielded room 543 (Baodun).
 2. The calibration interval of the above test instruments is 12/24 months. And the calibrations are traceable to CEPREI/CHINA, GRGT/CHINA and NIM/CHINA.



Test Report No.: RF2209WDG0031

4.1.3 TEST PROCEDURES

- a. The EUT was placed 0.4 meters from the conducting wall of the shielded room with EUT being connected to the power mains through a line impedance stabilization network (LISN). Other support units were connected to the power mains through another LISN. The two LISNs provide 50 ohm/ 50uH of coupling impedance for the measuring instrument.
- b. Both lines of the power mains connected to the EUT were checked for maximum conducted interference.
- c. The frequency range from 150kHz to 30MHz was searched. Emission levels under (Limit - 20dB) was not recorded.

NOTE: All modes of operation were investigated and the worst-case emissions are reported.

4.1.4 DEVIATION FROM TEST STANDARD

No deviation.

4.1.5 TEST SETUP

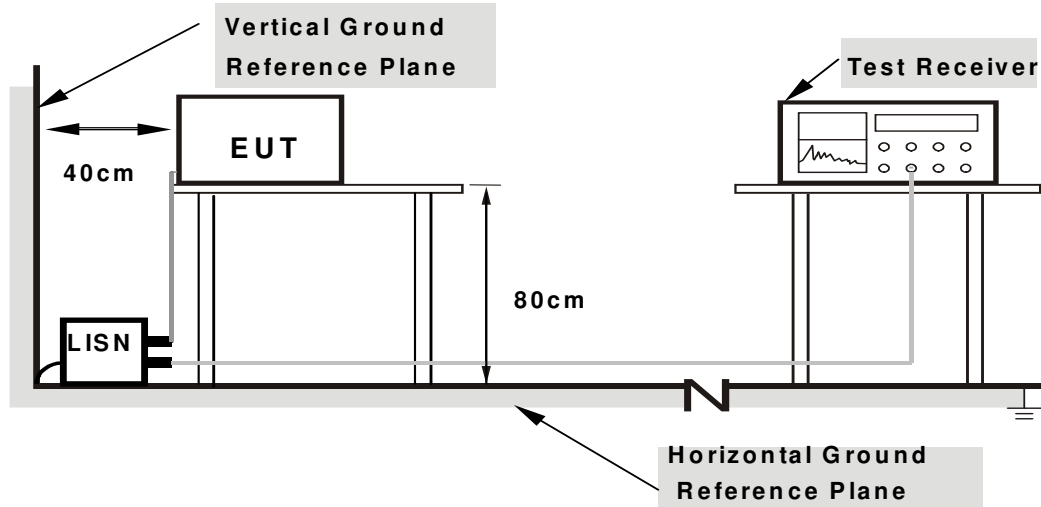

- Note:**
1. Support units were connected to second LISN.
 2. Both of LISNs (AMN) are 80 cm from EUT and at least 80 from other units and other metal planes

For the actual test configuration, please refer to the attached file (Test Setup Photo).

4.1.6 EUT OPERATING CONDITIONS

- a. Turned on the power and connected of all equipment.
- b. EUT was operated according to the type used was description in manufacturer's specifications or the User's Manual.

4.1.7 TEST RESULTS

CONDUCTED WORST-CASE DATA:

PHASE	Line	6dB BANDWIDTH	9kHz
-------	------	---------------	------

No	Freq. [MHz]	Corr. Factor (dB)	Reading Value [dB (uV)]		Emission Level [dB (uV)]		Limit [dB (uV)]		Margin (dB)	
			Q.P.	AV.	Q.P.	AV.	Q.P.	AV.	Q.P.	AV.
1	0.16148	9.92	31.10	14.41	41.02	24.33	65.39	55.39	-24.37	-31.06
2	0.20600	9.90	21.60	4.12	31.50	14.02	63.37	53.37	-31.86	-39.34
3	0.39400	9.91	26.36	17.32	36.27	27.23	57.98	47.98	-21.71	-20.75
4	0.49000	9.91	21.80	14.00	31.71	23.91	56.17	46.17	-24.46	-22.26
5	0.99800	9.89	18.00	10.69	27.89	20.58	56.00	46.00	-28.11	-25.42
6	8.37000	10.04	31.30	25.58	41.34	35.62	60.00	50.00	-18.66	-14.38

- REMARKS:**
1. Q.P. and AV. are abbreviations of quasi-peak and average individually.
 2. "-": The Quasi-peak reading value also meets average limit and measurement with the average detector is unnecessary.
 3. The emission levels of other frequencies were very low against the limit.
 4. Margin value = Emission level - Limit value
 5. Correction factor = Insertion loss + Cable loss
 6. Emission Level = Correction Factor + Reading Value.

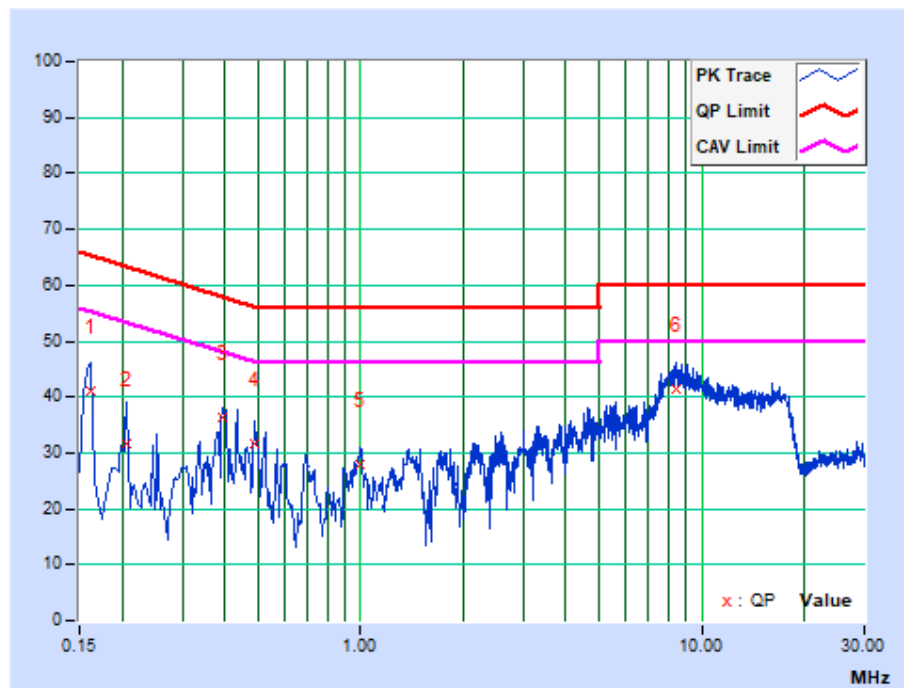

PHASE	Neutral	6dB BANDWIDTH	9kHz
--------------	---------	----------------------	------

No	Freq. [MHz]	Corr. Factor (dB)	Reading Value [dB (uV)]		Emission Level [dB (uV)]		Limit [dB (uV)]		Margin (dB)	
			Q.P.	AV.	Q.P.	AV.	Q.P.	AV.	Q.P.	AV.
1	0.17000	9.89	35.08	20.76	44.97	30.65	64.96	54.96	-19.99	-24.31
2	0.31781	9.90	22.71	11.77	32.61	21.67	59.76	49.76	-27.16	-28.10
3	0.40200	9.89	30.47	24.99	40.36	34.88	57.81	47.81	-17.45	-12.93
4	0.49476	9.89	22.29	16.79	32.18	26.68	56.09	46.09	-23.91	-19.41
5	1.20200	9.89	11.35	4.71	21.24	14.60	56.00	46.00	-34.76	-31.40
6	8.17000	10.03	29.54	24.17	39.57	34.20	60.00	50.00	-20.43	-15.80

- REMARKS:**
1. Q.P. and AV. are abbreviations of quasi-peak and average individually.
 2. "-": The Quasi-peak reading value also meets average limit and measurement with the average detector is unnecessary.
 3. The emission levels of other frequencies were very low against the limit.
 4. Margin value = Emission level - Limit value
 5. Correction factor = Insertion loss + Cable loss
 6. Emission Level = Correction Factor + Reading Value.

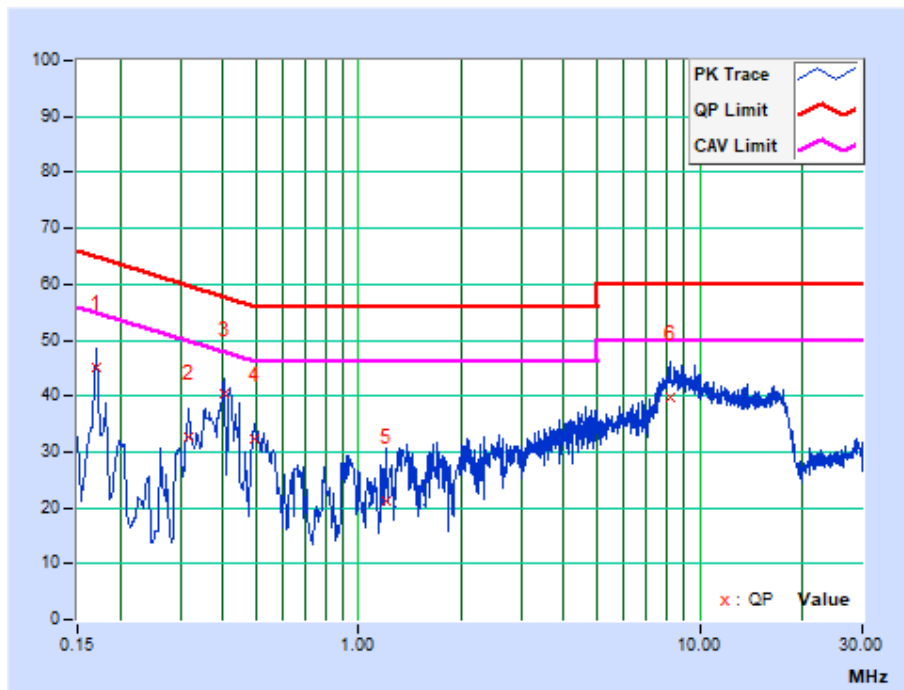

4.2. RADIATED EMISSION AND BANDEGE MEASUREMENT

4.2.1 LIMITS OF RADIATED EMISSION AND BANDEGE MEASUREMENT

Radiated emissions which fall in the restricted bands, as defined in Section 15.205(a), must also comply with the radiated emission limits specified in Section 15.209(a). Other emissions shall be at least 20dB below the highest level of the desired power.

FREQUENCIES (MHz)	FIELD STRENGTH (microvolts/meter)	MEASUREMENT DISTANCE (meters)
0.009 ~ 0.490	2400/F(kHz)	300
0.490 ~ 1.705	24000/F(kHz)	30
1.705 ~ 30.0	30	30
30 ~ 88	100	3
88 ~ 216	150	3
216 ~ 960	200	3
Above 960	500	3

NOTES:

1. The lower limit shall apply at the transition frequencies.
2. Emission level (dBuV/m) = 20 log Emission level (uV/m).
3. As shown in 15.35(b), for frequencies above 1000MHz, the field strength limits are based on average detector, however, the peak field strength of any emission shall not exceed the maximum permitted average limits, specified above by more than 20dB under any condition of modulation.



4.2.2 TEST INSTRUMENTS

Equipment	Manufacturer	Model No.	Serial No.	Next Cal.
Spectrum Analyzer	Rohde&Schwarz	FSV3044	101326	July 20, 23
Bilog Antenna	SCHWARZBECK	VULB 9168	01281	Jun. 19, 23
Pre-Amplifier	Agilent	8447D	2944A10488	Aug. 03, 23
3m Semi-anechoic Chamber	ETS-Lindgren	9m*6m*6m	D3040003DG-1	July 30, 24
Coaxial RF Cable	Joinfront	JFAA6-NMNM-8000	2100033742	July. 11, 23
Coaxial RF Cable	Joinfront	JFAR-NMBNCM-2000	2100033742	July. 11, 23
Coaxial RF Cable	Joinfront	JFAR-BNCMSMM-500	2100033742	July. 11, 23
Test software	ADT	ADT_Radiated_V7.6.15.9.2	N/A	N/A
Horn Antenna	ETS-Lindgren	3117	00240041	Jun. 19, 23
Horn Antenna	SCHWARZBECK	BBHA 9170	01024	Dec. 25, 22
Pre-Amplifier (1GHz-18GHz)	SCHWARZBECK	BBV 9718C	00142	Jun. 14, 23
Pre-Amplifier (18GHz-40GHz)	Rohde&Schwarz	SCU40	100437	Nov. 16, 22
Coaxial RF Cable	Joinfront	JFAA6-NMNM-8000	2100033742	July. 11, 23
Coaxial RF Cable	Joinfront	JFAA6-NMSMM-2000	2100033742	July. 11, 23
Coaxial RF Cable	Joinfront	JFAA6-NMSMM-800	2100033742	July. 11, 23

NOTES:

1. The test was performed in 966 Chamber (Baodun).
2. The calibration interval of the above test instruments is 12/24 months and the calibrations are traceable to CEPREI/CHINA, GRGT/CHINA and NIM/CHINA.
3. The horn antenna is used only for the measurement of emission frequency above 1GHz if tested.
4. The FCC Site Registration No. is 749762.



4.2.3 TEST PROCEDURES

- a. The EUT was placed on the top of a rotating table 1.5 meters (above 1GHz) and 0.8 meters (below 1GHz) above the ground at a 3 meters semi-anechoic chamber. The table was rotated 360 degrees to determine the position of the highest radiation.
- b. The EUT was set 3 meters away from the interference-receiving antenna, which was mounted on the top of a variable-height antenna tower.
- c. For below 1GHz was used bilog antenna, and above 1GHz was used horn antenna, and its height is varied from one meter to four meters above the ground to determine the maximum value of the field strength. Both horizontal and vertical polarizations of the antenna are set to make the measurement.
- d. For each suspected emission, the EUT was arranged to its worst case and then the antenna was tuned to heights from 1 meter to 4 meters and the rotatable table was turned from 0 degrees to 360 degrees to find the maximum reading.
- e. The test-receiver system was set to Peak Detect Function and Specified Bandwidth with Maximum Hold Mode.
- f. For below 30MHz, a loop antenna with its vertical plane is placed 3m from the EUT and rotated about its vertical axis for maximum response at each azimuth about the EUT. And the centre of the loop shall be 1.3m above the ground.
- g. During the test, each emission was maximized by: having the EUT continuously working, investigated all operating modes, rotated about all 3 axis (X, Y & Z) and considered typical configuration to obtain worst position, manipulating interconnecting cables, For battery operated equipment, the equipment tests shall be performed using fresh batteries. The turntable was rotated to maximize the emission level.

NOTES:

1. The resolution bandwidth and video bandwidth of test receiver/spectrum analyzer is 120kHz for Quasi-peak detection at frequency below 1GHz.
2. The resolution bandwidth of test receiver/spectrum analyzer is 1 MHz and video bandwidth is 3MHz for Peak detection at frequency above 1GHz.
3. The resolution bandwidth of test receiver/spectrum analyzer is 1MHz and the video bandwidth is $\geq 1/T$ (Duty cycle < 98%) or 10Hz (Duty cycle > 98%) for Average detection (AV) at frequency above 1GHz.
4. All modes of operation were investigated and the worst-case emissions are reported.
5. The testing of the EUT was performed on all 3 orthogonal axes; the worst-case test configuration was reported on the file test setup photo.

4.2.4 DEVIATION FROM TEST STANDARD

No deviation.

4.2.5 TEST SETUP

Below 30MHz test setup

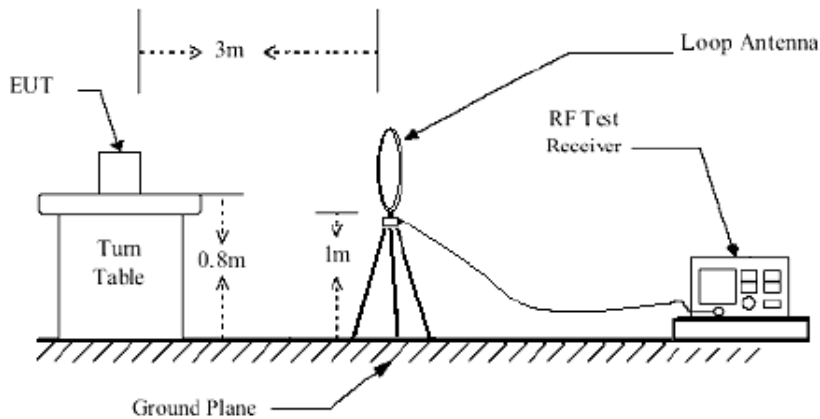

Below 1GHz test setup

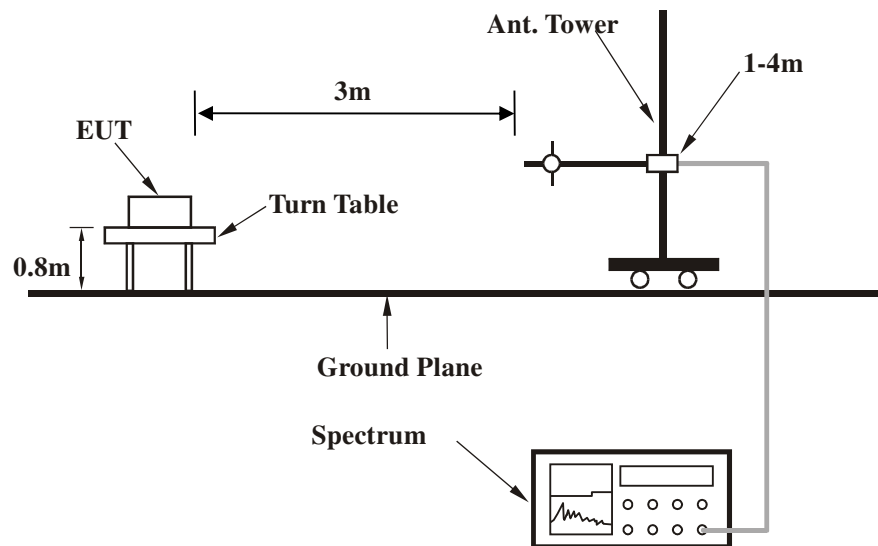

Note: For the actual test configuration, please refer to the attached file (Test Setup Photo).

Above 1GHz test setup

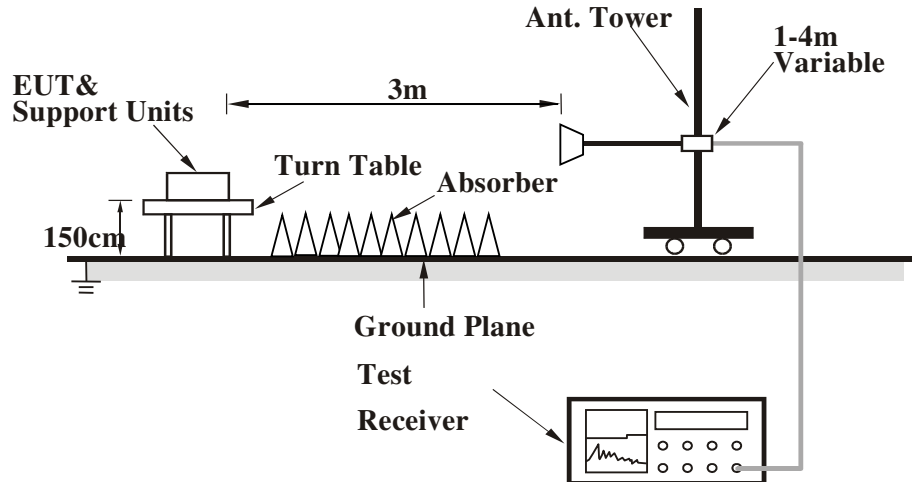

Note: For the actual test configuration, please refer to the attached file (Test Setup Photo).

4.2.6 EUT OPERATING CONDITIONS

- a. Set the EUT under full load condition and placed them on a testing table.
- b. Set the transmitter part of EUT under transmission condition continuously at specific channel frequency.
- c. The necessary accessories enable the EUT in full functions.

4.2.7 TEST RESULTS

BELOW 1GHz WORST-CASE DATA:

GFSK DH5

CHANNEL	Channel 39	DETECTOR FUNCTION	Quasi-Peak (QP)
FREQUENCY RANGE	9KHz ~ 1GHz		

ANTENNA POLARITY & TEST DISTANCE: HORIZONTAL AT 3 M								
NO.	FREQ. (MHz)	EMISSION LEVEL (dBuV/m)	LIMIT (dBuV/m)	MARGIN (dB)	ANTENNA HEIGHT (m)	TABLE ANGLE (Degree)	RAW VALUE (dBuV)	CORRECTIO N FACTOR (dB/m)
1	53.32	2.31 QP	40.00	-37.69	1.00 H	232	16.17	-13.86
2	152.80	3.25 QP	43.50	-40.25	1.00 H	265	16.23	-12.98
3	294.26	3.87 QP	46.00	-42.13	1.00 H	157	16.16	-12.29
4	396.86	4.86 QP	46.00	-41.14	1.00 H	276	15.43	-10.57
5	471.47	5.78 QP	46.00	-40.22	1.00 H	287	14.58	-8.80
6	567.85	7.35 QP	46.00	-38.65	1.00 H	261	14.51	-7.16

REMARKS:

1. Emission level (dBuV/m) = Raw Value (dBuV) + Correction Factor (dB/m).
2. Correction Factor (dB/m) = Antenna Factor (dB/m) + Cable Factor (dB).
3. The emission levels of other frequencies were greater than 20dB margin.
4. 9KHz~30MHz have been test and test data more than 20dB margin.
5. Margin value = Emission level – Limit value

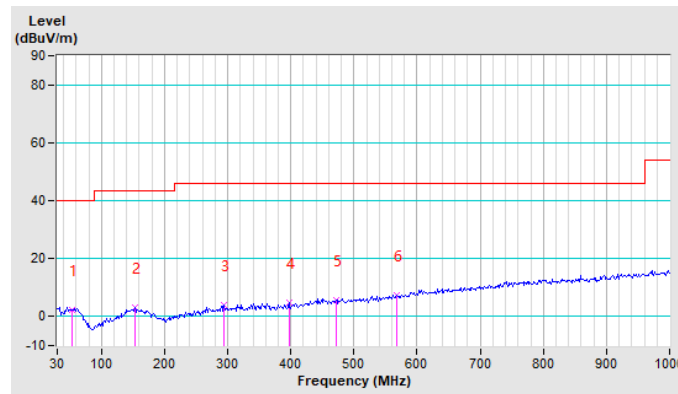

CHANNEL	Channel 39	DETECTOR FUNCTION	Quasi-Peak (QP)
FREQUENCY RANGE	9KHz ~ 1GHz		

ANTENNA POLARITY & TEST DISTANCE: VERTICAL AT 3 M								
NO.	FREQ. (MHz)	EMISSION LEVEL (dBuV/m)	LIMIT (dBuV/m)	MARGIN (dB)	ANTENNA HEIGHT (m)	TABLE ANGLE (Degree)	RAW VALUE (dBuV)	CORRECTIO N FACTOR (dB/m)
1	45.54	3.17 QP	40.00	-36.83	1.00 V	104	17.43	-14.26
2	152.80	3.25 QP	43.50	-40.25	1.00 V	169	16.23	-12.98
3	194.78	0.55 QP	43.50	-42.95	1.00 V	113	16.33	-15.78
4	316.03	4.15 QP	46.00	-41.85	1.00 V	191	16.00	-11.85
5	496.35	5.77 QP	46.00	-40.23	1.00 V	285	14.44	-8.67
6	567.85	7.35 QP	46.00	-38.65	1.00 V	211	14.51	-7.16

REMARKS:

1. Emission level (dBuV/m) = Raw Value (dBuV) + Correction Factor (dB/m).
2. Correction Factor (dB/m) = Antenna Factor (dB/m) + Cable Factor (dB).
3. The emission levels of other frequencies were greater than 20dB margin.
4. 9KHz~30MHz have been test and test data more than 20dB margin.
5. Margin value = Emission level – Limit value

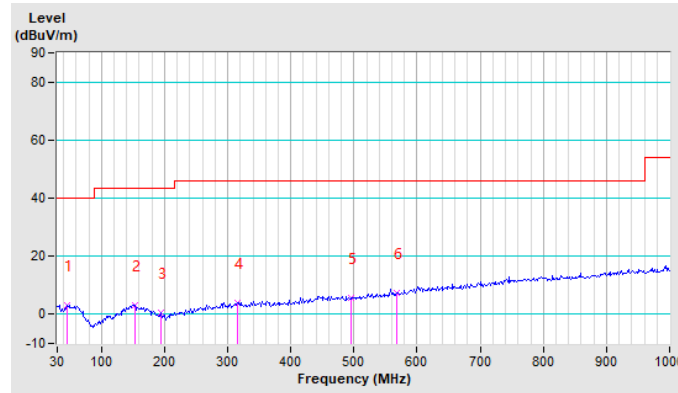



Test Report No.: RF2209WDG0031

ABOVE 1GHz DATA

BT_GFSK

CHANNEL	TX Channel 0	DETECTOR FUNCTION	Peak (PK)
FREQUENCY RANGE	1GHz ~ 25GHz		Average (AV)

ANTENNA POLARITY & TEST DISTANCE: HORIZONTAL AT 3 M								
NO.	FREQ. (MHz)	EMISSION LEVEL (dBuV/m)	LIMIT (dBuV/m)	MARGIN (dB)	ANTENNA HEIGHT (m)	TABLE ANGLE (Degree)	RAW VALUE (dBuV)	CORRECTION FACTOR (dB/m)
1	2390.00	44.65 PK	74.00	-29.35	1.00 H	125	43.09	1.56
2	2390.00	36.05 AV	54.00	-17.95	1.00 H	125	34.49	1.56
3	*2402.00	89.05 PK			1.00 H	125	87.49	1.56
4	*2402.00	88.32 AV			1.00 H	125	86.76	1.56
5	4804.00	51.75 PK	74.00	-22.25	1.00 H	159	44.51	7.24
6	4804.00	42.00 AV	54.00	-12.00	1.00 H	159	34.76	7.24
7	#7206.00	54.00 PK	74.00	-20.00	1.00 H	136	42.55	11.45
8	#7206.00	43.09 AV	54.00	-10.91	1.00 H	136	31.64	11.45

ANTENNA POLARITY & TEST DISTANCE: VERTICAL AT 3 M								
NO.	FREQ. (MHz)	EMISSION LEVEL (dBuV/m)	LIMIT (dBuV/m)	MARGIN (dB)	ANTENNA HEIGHT (m)	TABLE ANGLE (Degree)	RAW VALUE (dBuV)	CORRECTION FACTOR (dB/m)
1	2390.00	41.35 PK	74.00	-32.65	1.00 V	125	39.79	1.56
2	2390.00	34.15 AV	54.00	-19.85	1.00 V	125	32.59	1.56
3	*2402.00	80.56 PK			1.00 V	125	79.00	1.56
4	*2402.00	79.36 AV			1.00 V	125	77.80	1.56
5	4804.00	51.25 PK	74.00	-22.75	1.00 V	158	44.01	7.24
6	4804.00	42.01 AV	54.00	-11.99	1.00 V	158	34.77	7.24
7	#7206.00	54.33 PK	74.00	-19.67	1.00 V	160	42.88	11.45
8	#7206.00	44.85 AV	54.00	-9.15	1.00 V	160	33.40	11.45

REMARKS:

1. Emission level (dBuV/m) = Raw Value (dBuV) + Correction Factor (dB/m).
2. Correction Factor (dB/m) = Antenna Factor (dB/m) + Cable Factor (dB).
3. The emission levels of other frequencies were greater than 20dB margin.
4. Margin value = Emission level – Limit value.
5. " * ": Fundamental frequency.
6. " # ": The radiated frequency is out of the restricted band.

Bureau Veritas Shenzhen Co., Ltd.
Dongguan Branch

No. 96, Guantai Road (Houjie Section), Houjie
Town, Dongguan City, Guangdong Province.
523942. People's Republic of China.

Tel: +86 769 8998 2098
Fax: +86 769 8593 1080
Email: customerservice.dg@bureauveritas.com



Test Report No.: RF2209WDG0031

CHANNEL	TX Channel 39	DETECTOR FUNCTION	Peak (PK)
FREQUENCY RANGE	1GHz ~ 25GHz		Average (AV)

ANTENNA POLARITY & TEST DISTANCE : HORIZONTAL AT 3 M

NO.	FREQ. (MHz)	EMISSION LEVEL (dBuV/m)	LIMIT (dBuV/m)	MARGIN (dB)	ANTENNA HEIGHT (m)	TABLE ANGLE (Degree)	RAW VALUE (dBuV)	CORRECTION FACTOR (dB/m)
1	*2441.00	89.01 PK			1.00 H	154	87.43	1.58
2	*2441.00	88.05 AV			1.00 H	154	86.47	1.58
3	4882.00	51.99 PK	74.00	-22.01	1.00 H	157	44.33	7.66
4	4882.00	43.07 AV	54.00	-10.93	1.00 H	157	35.41	7.66
5	7323.00	54.35 PK	74.00	-19.65	1.00 H	152	42.76	11.59
6	7323.00	45.06 AV	54.00	-8.94	1.00 H	152	33.47	11.59

ANTENNA POLARITY & TEST DISTANCE : VERTICAL AT 3 M

NO.	FREQ. (MHz)	EMISSION LEVEL (dBuV/m)	LIMIT (dBuV/m)	MARGIN (dB)	ANTENNA HEIGHT (m)	TABLE ANGLE (Degree)	RAW VALUE (dBuV)	CORRECTION FACTOR (dB/m)
1	*2441.00	81.96 PK			1.00 V	145	80.38	1.58
2	*2441.00	81.22 AV			1.00 V	145	79.64	1.58
3	4882.00	51.36 PK	74.00	-22.64	1.00 V	185	43.70	7.66
4	4882.00	43.05 AV	54.00	-10.95	1.00 V	185	35.39	7.66
5	7323.00	54.15 PK	74.00	-19.85	1.00 V	168	42.56	11.59
6	7323.00	43.69 AV	54.00	-10.31	1.00 V	168	32.10	11.59

REMARKS:

1. Emission level (dBuV/m) = Raw Value (dBuV) + Correction Factor (dB/m).
2. Correction Factor (dB/m) = Antenna Factor (dB/m) + Cable Factor (dB).
3. The emission levels of other frequencies were greater than 20dB margin.
4. Margin value = Emission level – Limit value.
5. " * ": Fundamental frequency.

CHANNEL	TX Channel 78	DETECTOR FUNCTION	Peak (PK)
FREQUENCY RANGE	1GHz ~ 25GHz		Average (AV)

ANTENNA POLARITY & TEST DISTANCE : HORIZONTAL AT 3 M								
NO.	FREQ. (MHz)	EMISSION LEVEL (dBuV/m)	LIMIT (dBuV/m)	MARGIN (dB)	ANTENNA HEIGHT (m)	TABLE ANGLE (Degree)	RAW VALUE (dBuV)	CORRECTION FACTOR (dB/m)
1	2390.00	44.31 PK	74.00	-29.69	1.00 H	145	42.75	1.56
2	2390.00	35.00 AV	54.00	-19.00	1.00 H	145	33.44	1.56
3	*2480.00	89.12 PK			1.00 H	145	87.53	1.59
4	*2480.00	88.41 AV			1.00 H	145	86.82	1.59
5	4960.00	53.20 PK	74.00	-20.80	1.55 H	120	45.13	8.07
6	4960.00	45.00 AV	54.00	-9.00	1.55 H	120	36.93	8.07
7	7440.00	54.02 PK	74.00	-19.98	1.00 H	165	42.28	11.74
8	7440.00	45.03 AV	54.00	-8.97	1.00 H	165	33.29	11.74
ANTENNA POLARITY & TEST DISTANCE : VERTICAL AT 3 M								
NO.	FREQ. (MHz)	EMISSION LEVEL (dBuV/m)	LIMIT (dBuV/m)	MARGIN (dB)	ANTENNA HEIGHT (m)	TABLE ANGLE (Degree)	RAW VALUE (dBuV)	CORRECTION FACTOR (dB/m)
1	*2480.00	82.00 PK			1.00 V	166	80.41	1.59
2	*2480.00	81.12 AV			1.00 V	166	79.53	1.59
3	2483.50	42.01 PK	74.00	-31.99	1.00 V	166	40.42	1.59
4	2483.50	34.56 AV	54.00	-19.44	1.00 V	166	32.97	1.59
5	4960.00	53.00 PK	74.00	-21.00	1.00 V	158	44.93	8.07
6	4960.00	43.65 AV	54.00	-10.35	1.00 V	158	35.58	8.07
7	7440.00	54.86 PK	74.00	-19.14	1.00 V	12	43.12	11.74
8	7440.00	45.00 AV	54.00	-9.00	1.00 V	12	33.26	11.74

REMARKS:

1. Emission level (dBuV/m) = Raw Value (dBuV) + Correction Factor (dB/m).
2. Correction Factor (dB/m) = Antenna Factor (dB/m) + Cable Factor (dB).
3. The emission levels of other frequencies were greater than 20dB margin.
4. Margin value = Emission level – Limit value.
5. " * " : Fundamental frequency.



Test Report No.: RF2209WDG0031

BT_8DPSK

CHANNEL	TX Channel 0	DETECTOR FUNCTION	Peak (PK)
FREQUENCY RANGE	1GHz ~ 25GHz		Average (AV)

ANTENNA POLARITY & TEST DISTANCE : HORIZONTAL AT 3 M

NO.	FREQ. (MHz)	EMISSION LEVEL (dBuV/m)	LIMIT (dBuV/m)	MARGIN (dB)	ANTENNA HEIGHT (m)	TABLE ANGLE (Degree)	RAW VALUE (dBuV)	CORRECTION FACTOR (dB/m)
1	2390.00	43.25 PK	74.00	-30.75	1.00 H	145	41.69	1.56
2	2390.00	34.12 AV	54.00	-19.88	1.00 H	145	32.56	1.56
3	*2402.00	89.01 PK			1.00 H	145	87.45	1.56
4	*2402.00	85.35 AV			1.00 H	145	83.79	1.56
5	4804.00	53.04 PK	74.00	-20.96	1.00 H	148	45.80	7.24
6	4804.00	43.62 AV	54.00	-10.38	1.00 H	148	36.38	7.24
7	#7206.00	54.08 PK	74.00	-19.92	1.00 H	182	42.63	11.45
8	#7206.00	45.06 AV	54.00	-8.94	1.00 H	182	33.61	11.45

ANTENNA POLARITY & TEST DISTANCE : VERTICAL AT 3 M

NO.	FREQ. (MHz)	EMISSION LEVEL (dBuV/m)	LIMIT (dBuV/m)	MARGIN (dB)	ANTENNA HEIGHT (m)	TABLE ANGLE (Degree)	RAW VALUE (dBuV)	CORRECTION FACTOR (dB/m)
1	2390.00	42.65 PK	74.00	-31.35	1.00 V	158	41.09	1.56
2	2390.00	34.40 AV	54.00	-19.60	1.00 V	158	32.84	1.56
3	*2402.00	81.59 PK			1.00 V	122	80.03	1.56
4	*2402.00	77.89 AV			1.00 V	122	76.33	1.56
5	4804.00	51.77 PK	74.00	-22.23	1.00 V	157	44.53	7.24
6	4804.00	42.95 AV	54.00	-11.05	1.00 V	157	35.71	7.24
7	#7206.00	54.33 PK	74.00	-19.67	1.00 V	129	42.88	11.45
8	#7206.00	45.06 AV	54.00	-8.94	1.00 V	129	33.61	11.45

REMARKS:

1. Emission level (dBuV/m) = Raw Value (dBuV) + Correction Factor (dB/m).
2. Correction Factor (dB/m) = Antenna Factor (dB/m) + Cable Factor (dB).
3. The emission levels of other frequencies were greater than 20dB margin.
4. Margin value = Emission level – Limit value.
5. " * ": Fundamental frequency.
6. " # ": The radiated frequency is out of the restricted band.

Bureau Veritas Shenzhen Co., Ltd.
Dongguan Branch

No. 96, Guantai Road (Houjie Section), Houjie
Town, Dongguan City, Guangdong Province.
523942. People's Republic of China.

Tel: +86 769 8998 2098
Fax: +86 769 8593 1080
Email: customerservice.dg@bureauveritas.com



Test Report No.: RF2209WDG0031

CHANNEL	TX Channel 39	DETECTOR FUNCTION	Peak (PK)
FREQUENCY RANGE	1GHz ~ 25GHz		Average (AV)

ANTENNA POLARITY & TEST DISTANCE : HORIZONTAL AT 3 M

NO.	FREQ. (MHz)	EMISSION LEVEL (dBuV/m)	LIMIT (dBuV/m)	MARGIN (dB)	ANTENNA HEIGHT (m)	TABLE ANGLE (Degree)	RAW VALUE (dBuV)	CORRECTION FACTOR (dB/m)
1	*2441.00	89.55 PK			1.00 H	360	87.97	1.58
2	*2441.00	85.00 AV			1.00 H	360	83.42	1.58
3	4882.00	53.21 PK	74.00	-20.79	1.00 H	166	45.55	7.66
4	4882.00	43.05 AV	54.00	-10.95	1.00 H	166	35.39	7.66
5	7323.00	54.33 PK	74.00	-19.67	1.00 H	167	42.74	11.59
6	7323.00	45.06 AV	54.00	-8.94	1.00 H	167	33.47	11.59

ANTENNA POLARITY & TEST DISTANCE : VERTICAL AT 3 M

NO.	FREQ. (MHz)	EMISSION LEVEL (dBuV/m)	LIMIT (dBuV/m)	MARGIN (dB)	ANTENNA HEIGHT (m)	TABLE ANGLE (Degree)	RAW VALUE (dBuV)	CORRECTION FACTOR (dB/m)
1	*2441.00	81.57 PK			1.00 V	126	79.99	1.58
2	*2441.00	78.80 AV			1.00 V	126	77.22	1.58
3	4882.00	53.11 PK	74.00	-20.89	1.00 V	164	45.45	7.66
4	4882.00	42.69 AV	54.00	-11.31	1.00 V	164	35.03	7.66
5	7323.00	54.11 PK	74.00	-19.89	1.00 V	169	42.52	11.59
6	7323.00	45.01 AV	54.00	-8.99	1.00 V	169	33.42	11.59

REMARKS:

1. Emission level (dBuV/m) = Raw Value (dBuV) + Correction Factor (dB/m).
2. Correction Factor (dB/m) = Antenna Factor (dB/m) + Cable Factor (dB).
3. The emission levels of other frequencies were greater than 20dB margin.
4. Margin value = Emission level – Limit value.
5. " * ": Fundamental frequency.

Bureau Veritas Shenzhen Co., Ltd.
Dongguan Branch

No. 96, Guantai Road (Houjie Section), Houjie
Town, Dongguan City, Guangdong Province.
523942. People's Republic of China.

Tel: +86 769 8998 2098
Fax: +86 769 8593 1080
Email: customerservice.dg@bureauveritas.com

CHANNEL	TX Channel 78	DETECTOR FUNCTION	Peak (PK)
FREQUENCY RANGE	1GHz ~ 25GHz		Average (AV)

ANTENNA POLARITY & TEST DISTANCE : HORIZONTAL AT 3 M								
NO.	FREQ. (MHz)	EMISSION LEVEL (dBuV/m)	LIMIT (dBuV/m)	MARGIN (dB)	ANTENNA HEIGHT (m)	TABLE ANGLE (Degree)	RAW VALUE (dBuV)	CORRECTION FACTOR (dB/m)
1	*2480.00	89.95 PK			1.00 H	125	88.36	1.59
2	*2480.00	84.59 AV			1.00 H	125	83.00	1.59
3	2483.50	43.69 PK	74.00	-30.31	1.00 H	125	42.10	1.59
4	2483.50	36.00 AV	54.00	-18.00	1.00 H	125	34.41	1.59
5	4960.00	53.44 PK	74.00	-20.56	1.00 H	157	45.37	8.07
6	4960.00	43.08 AV	54.00	-10.92	1.00 H	157	35.01	8.07
7	7440.00	54.79 PK	74.00	-19.21	1.00 H	157	43.05	11.74
8	7440.00	45.02 AV	54.00	-8.98	1.00 H	157	33.28	11.74
ANTENNA POLARITY & TEST DISTANCE : VERTICAL AT 3 M								
NO.	FREQ. (MHz)	EMISSION LEVEL (dBuV/m)	LIMIT (dBuV/m)	MARGIN (dB)	ANTENNA HEIGHT (m)	TABLE ANGLE (Degree)	RAW VALUE (dBuV)	CORRECTION FACTOR (dB/m)
1	*2480.00	82.00 PK			1.00 V	125	80.41	1.59
2	*2480.00	77.98 AV			1.00 V	125	76.39	1.59
3	2483.50	54.12 PK	74.00	-19.88	1.00 V	147	52.53	1.59
4	2483.50	43.56 AV	54.00	-10.44	1.00 V	147	41.97	1.59
5	4960.00	54.01 PK	74.00	-19.99	1.00 V	18	45.94	8.07
6	4960.00	43.80 AV	54.00	-10.20	1.00 V	18	35.73	8.07
7	7440.00	54.88 PK	74.00	-19.12	1.00 V	187	43.14	11.74
8	7440.00	44.74 AV	54.00	-9.26	1.00 V	187	33.00	11.74

REMARKS:

1. Emission level (dBuV/m) = Raw Value (dBuV) + Correction Factor (dB/m).
2. Correction Factor (dB/m) = Antenna Factor (dB/m) + Cable Factor (dB).
3. The emission levels of other frequencies were greater than 20dB margin.
4. Margin value = Emission level – Limit value.
5. " * " : Fundamental frequency.

4.3 NUMBER OF HOPPING FREQUENCY USED

4.3.1 LIMIT OF HOPPING FREQUENCY USED

At least 15 channels frequencies, and should be equally spaced.

4.3.2 TEST SETUP

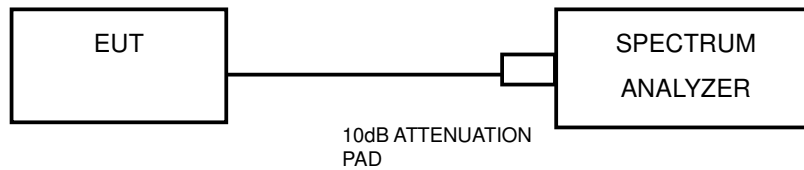

4.3.3 TEST INSTRUMENTS

Equipment	Manufacturer	Model No.	Serial No.	Next Cal.
Wireless Connectivity Tester	Rohde&Schwarz	CMW270	101601	Nov. 21, 22
MXA signal analyzer	Agilent	N9020A	MY49100060	Apr. 18, 23
Spectrum Analyzer	Rohde&Schwarz	FSV40	101094	Jan. 16, 23
Frequency Analyzer	Keysight	N9010B	MY60240432	Nov. 25, 22
Programmable Temperature&Humidity Chamber	Hongjin	HYC-TH-225DH	DG-180746	Feb. 16, 23
Attenuator	MINI	BW-S10W2+	S130129FGE2	N/A
DC Source	Agilent	E3640A	MY40004013	Feb. 23, 23
Test software	ADT	ADT_RF Test Software V6.6.5.3	N/A	N/A
Test software	ADT	ADT_RF Test Software V6.6.5.4	N/A	N/A

- NOTE:**
1. The test was performed in RF Test Shielded Room (Baodun).
 2. The calibration interval of the above test instruments is 12 months and the calibrations are traceable to CEPREI/CHINA, GRGT/CHINA and NIM/CHINA.



4.3.4 TEST PROCEDURES

- a. Check the calibration of the measuring instrument (SA) using either an internal calibrator or a known signal from an external generator.
- b. Turn on the EUT and connect its antenna terminal to measurement via a low loss cable. Then set it to any one measured frequency within its operating range and make sure the instrument is operated in its linear range.
- c. Set the SA on MaxHold Mode, and then keep the EUT in hopping mode. Record all the signals from each channel until each one has been recorded.
- d. Set the SA on View mode and then plot the result on SA screen.
- e. Repeat above procedures until all frequencies measured were completed.

4.3.5 DEVIATION FROM TEST STANDARD

No deviation.

4.3.6 TEST RESULTS

There are 79 hopping frequencies in the hopping mode. Please refer to next two pages for the test result. On the plots, it shows that the hopping frequencies are equally spaced.



Test Report No.: RF2209WDG0031

GFSK

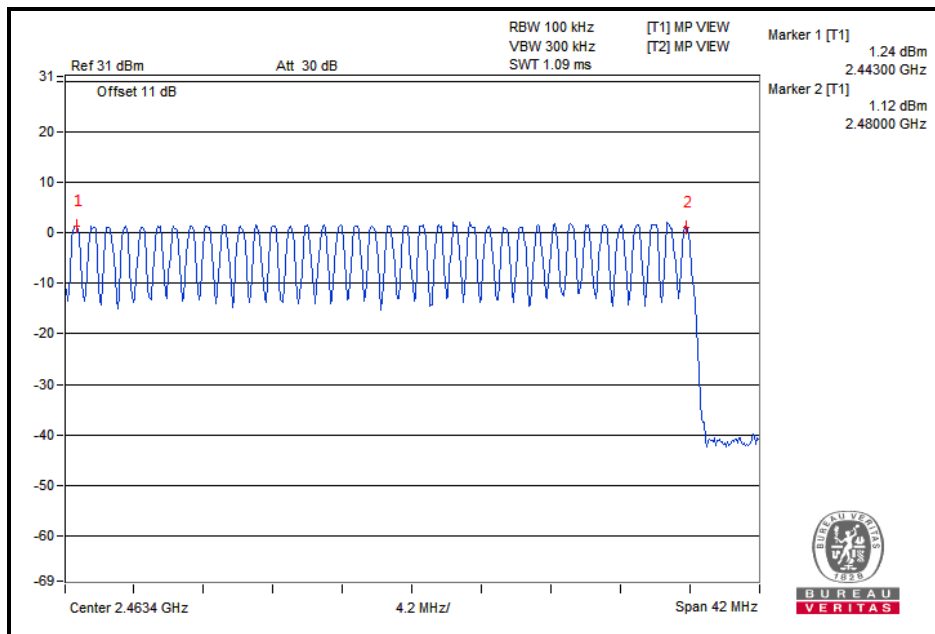
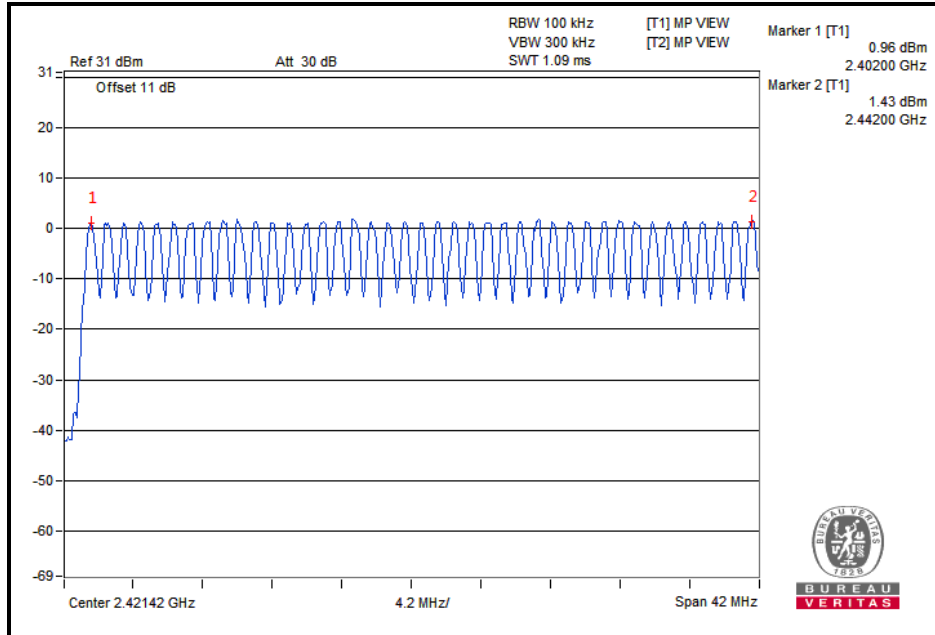

Bureau Veritas Shenzhen Co., Ltd.
Dongguan Branch

No. 96, Guantai Road (Houjie Section), Houjie
Town, Dongguan City, Guangdong Province.
523942. People's Republic of China.

Tel: +86 769 8998 2098
Fax: +86 769 8593 1080
Email: customerservice.dg@bureauveritas.com



Test Report No.: RF2209WDG0031

8DPSK

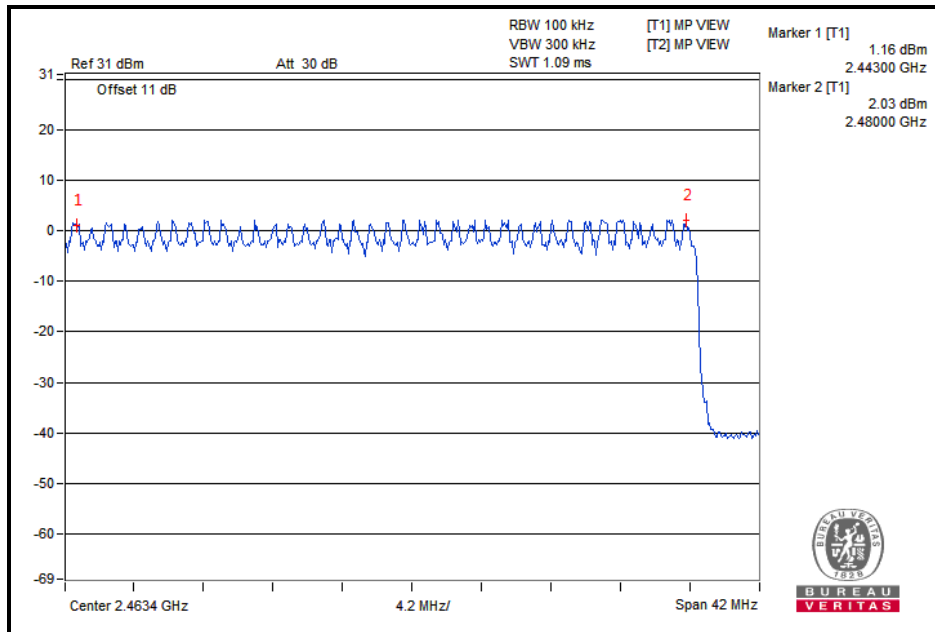
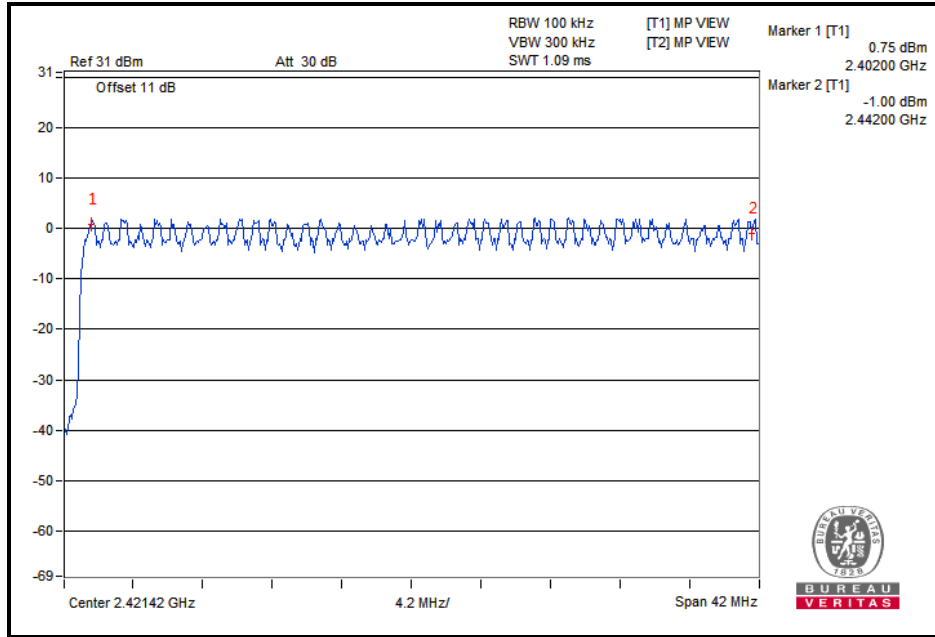

Bureau Veritas Shenzhen Co., Ltd.
Dongguan Branch

No. 96, Guantai Road (Houjie Section), Houjie
Town, Dongguan City, Guangdong Province.
523942. People's Republic of China.

Tel: +86 769 8998 2098
Fax: +86 769 8593 1080
Email: customerservice.dg@bureauveritas.com

4.4 DWELL TIME ON EACH CHANNEL

4.4.1 LIMIT OF DWELL TIME USED

The average time of occupancy on any channel shall not be greater than 0.4 seconds within a period of 0.4 seconds multiplied by the number of hopping channels employed.

4.4.2 TEST SETUP

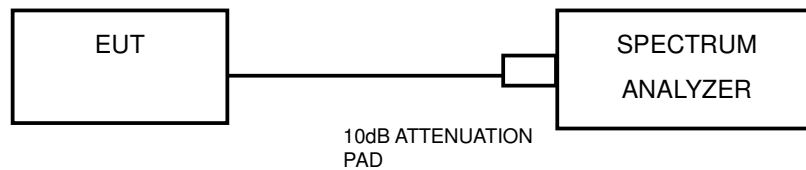

4.4.3 TEST INSTRUMENTS

Refer to section 4.3.3 to get information of above instrument.

4.4.4 TEST PROCEDURES

- a. Check the calibration of the measuring instrument (SA) using either an internal calibrator or a known signal from an external generator.
- b. Turn on the EUT and connect its antenna terminal to measurement via a low loss cable. Then set it to any one measured frequency within its operating range and make sure the instrument is operated in its linear range.
- c. Adjust the center frequency of SA on any frequency be measured and set SA to zero span mode. And then, set RBW and VBW of spectrum analyzer to proper value.
- d. Measure the time duration of one transmission on the measured frequency. And then plot the result with time difference of this time duration.
- e. Repeat above procedures until all different time-slot modes have been completed.



4.4.5 DEVIATION FROM TEST STANDARD

No deviation.

4.4.6 TEST RESULTS

GFSK

Mode	Number of Hopping Channel	Number of transmission in a period(channel number*0.4 sec)				Length of transmission time (msec)	Result (msec)	Limit (msec)	PASS / FAIL
		period (sec)	sweep time (sec)	times in a sweep	times in a period				
DH1	79	31.6	5	50	316.00	0.456	144.10	400	PASS
DH3	79	31.6	5	24	151.68	1.740	263.92	400	PASS
DH5	79	31.6	5	17	107.44	2.944	316.30	400	PASS

8DPSK

Mode	Number of Hopping Channel	Number of transmission in a period(channel number*0.4 sec)				Length of transmission time (msec)	Result (msec)	Limit (msec)	PASS / FAIL
		period (sec)	sweep time (sec)	times in a sweep	times in a period				
3DH1	79	31.6	5	50	316.00	0.420	132.72	400	PASS
3DH3	79	31.6	5	27	170.64	1.730	295.21	400	PASS
3DH5	79	31.6	5	17	107.44	3.040	326.62	400	PASS

NOTE: Test plots of the transmitting time slot are shown on next page.



BUREAU VERITAS

Test Report No.: RF2209WDG0031

GFSK



Bureau Veritas Shenzhen Co., Ltd.
Dongguan Branch

No. 96, Guantai Road (Houjie Section), Houjie
Town, Dongguan City, Guangdong Province.
523942, People's Republic of China.

Tel: +86 769 8998 2098
Fax: +86 769 8593 1080
Email: customerservice.dg@bureauveritas.com



BUREAU VERITAS

Test Report No.: RF2209WDG0031

8DPSK

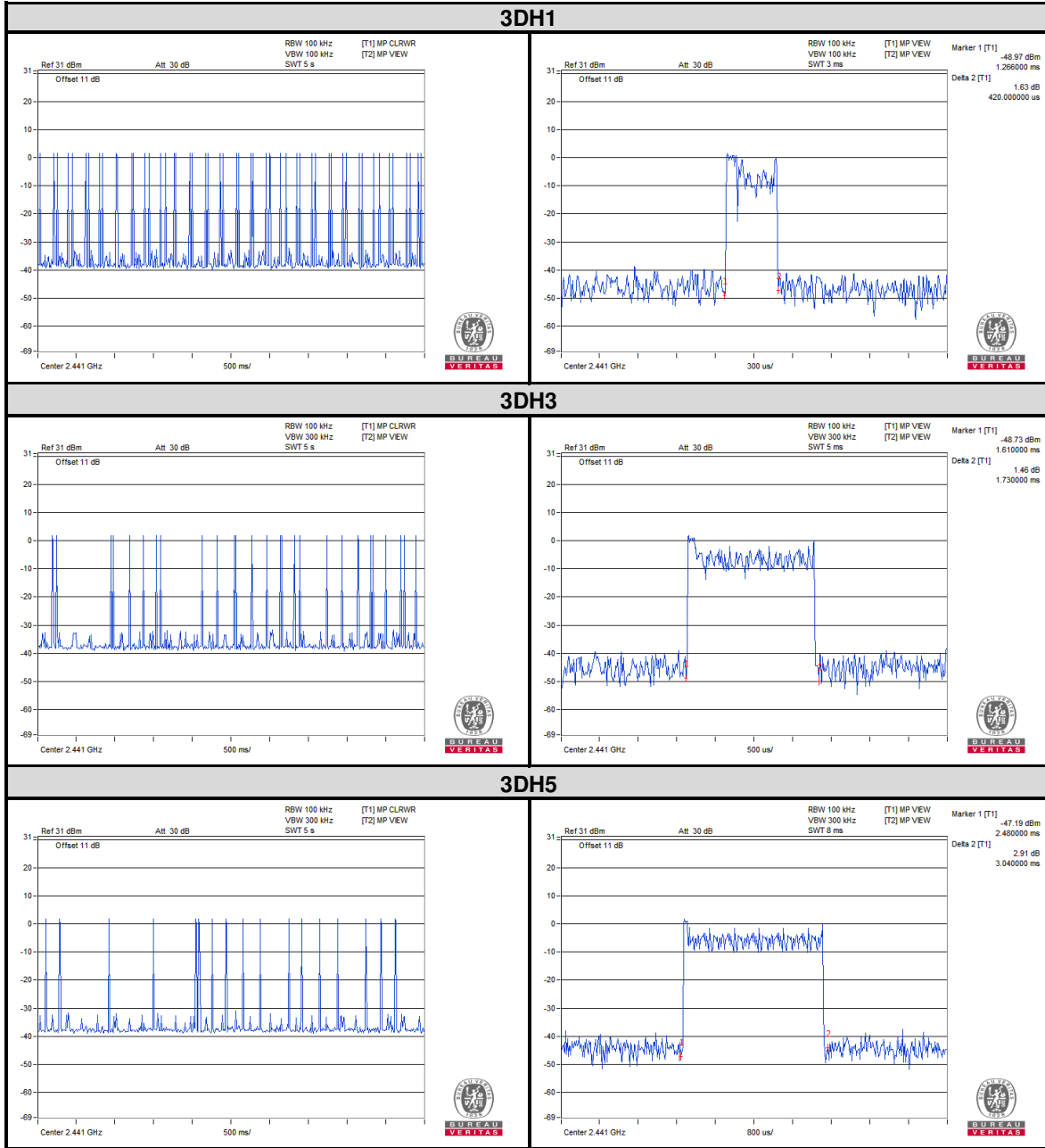

Bureau Veritas Shenzhen Co., Ltd.
Dongguan Branch

No. 96, Guantai Road (Houjie Section), Houjie
Town, Dongguan City, Guangdong Province.
523942, People's Republic of China.

Tel: +86 769 8998 2098
Fax: +86 769 8593 1080
Email: customerservice.dg@bureauveritas.com

4.5 CHANNEL BANDWIDTH

4.5.1 LIMITS OF CHANNEL BANDWIDTH

For frequency hopping system operating in the 2400-2483.5MHz, If the 20dB bandwidth of hopping channel is greater than 25kHz, two-thirds 20dB bandwidth of hopping channel shall be a minimum limit for the hopping channel separation.

4.5.2 TEST SETUP

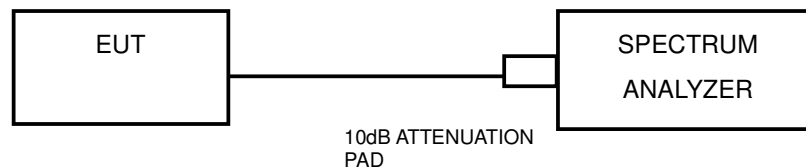

4.5.3 TEST INSTRUMENTS

Refer to section 4.3.3 to get information of above instrument.

4.5.4 TEST PROCEDURE

- a. Check the calibration of the measuring instrument using either an internal calibrator or a known signal from an external generator.
- b. Turn on the EUT and connect it to measurement instrument. Then set it to any one convenient frequency within its operating range. Set a reference level on the measuring instrument equal to the highest peak value.
- c. Measure the frequency difference of two frequencies that were attenuated 20dB from the reference level. Record the frequency difference as the emission bandwidth.
- d. Repeat above procedures until all frequencies measured were complete.

4.5.5 DEVIATION FROM TEST STANDARD

No deviation.

4.5.6 EUT OPERATING CONDITION

The software provided by client to enable the EUT under transmission condition continuously at lowest, middle and highest channel frequencies individually.

4.5.7 TEST RESULTS

GFSK

CHANNEL	CHANNEL FREQUENCY (MHz)	20dB BANDWIDTH (MHz)
0	2402	1.02
39	2441	1.03
78	2480	1.03

CH 0

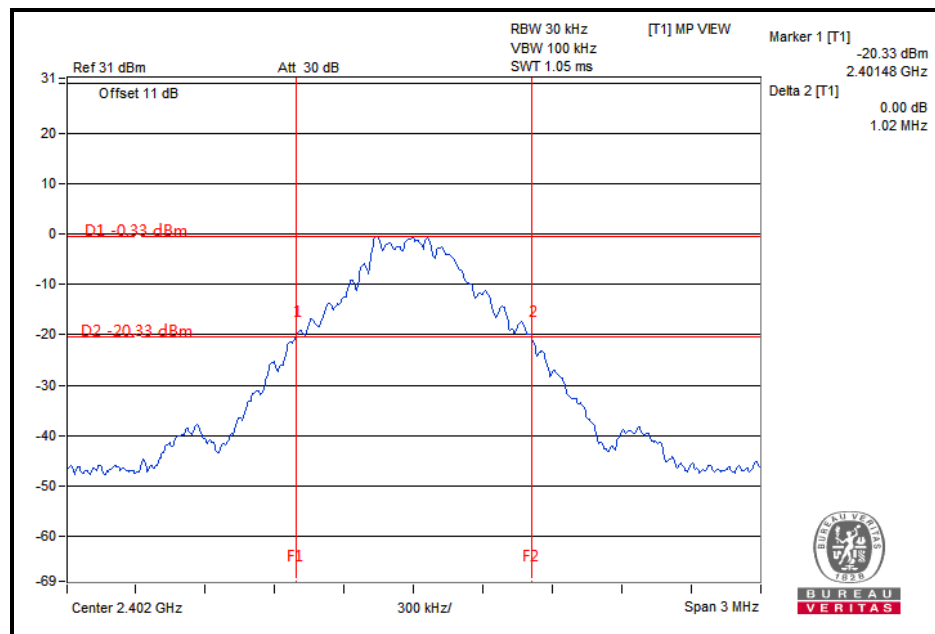

CH 39

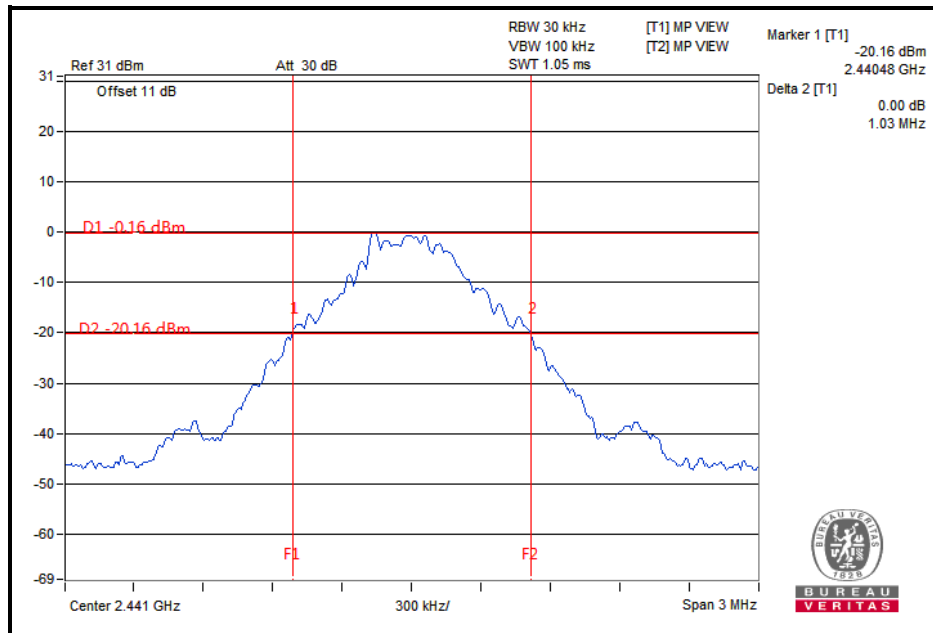

CH 78

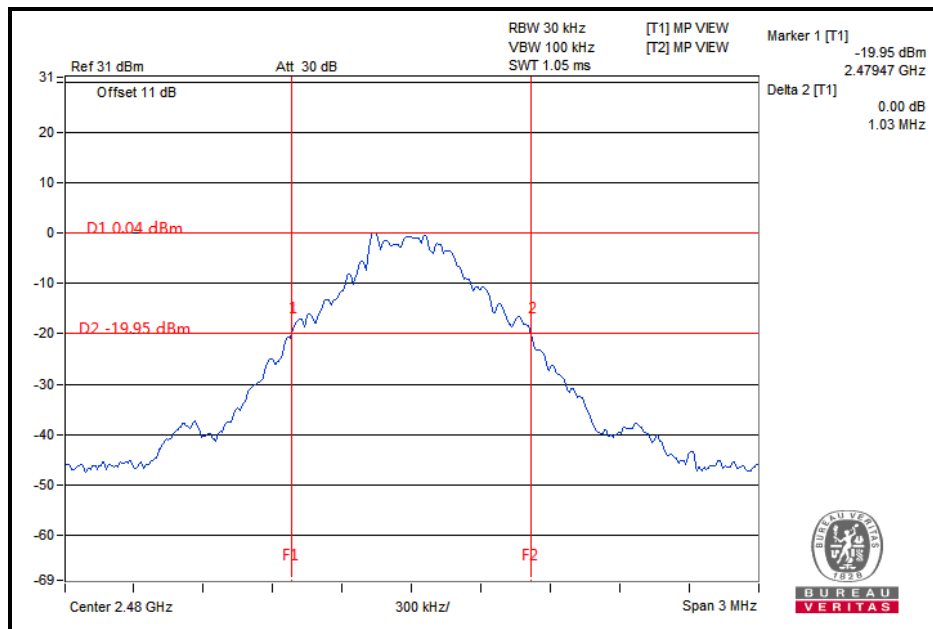

8DPSK

CHANNEL	CHANNEL FREQUENCY (MHz)	20dB BANDWIDTH (MHz)
0	2402	1.29
39	2441	1.29
78	2480	1.29

CH 0

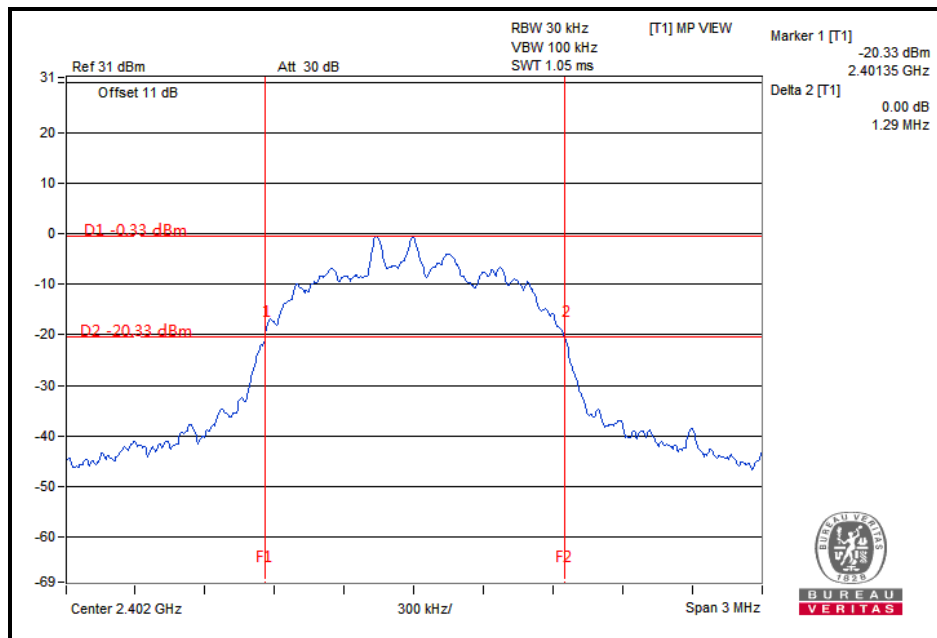

CH 39

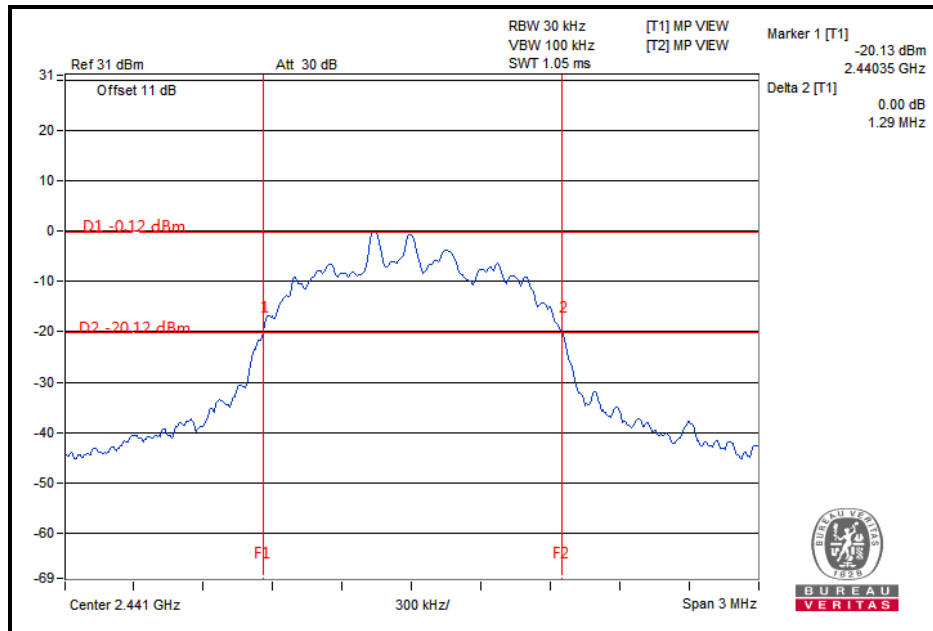

CH 78

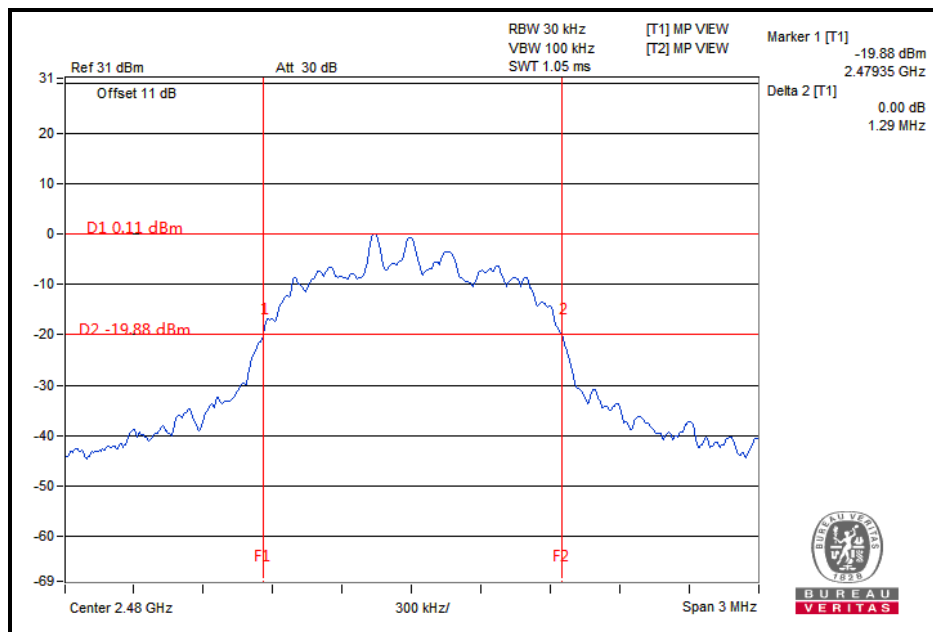

4.6 HOPPING CHANNEL SEPARATION

4.6.1 LIMIT OF HOPPING CHANNEL SEPARATION

At least 25kHz or two-third of 20dB hopping channel bandwidth (whichever is greater).

4.6.2 TEST SETUP

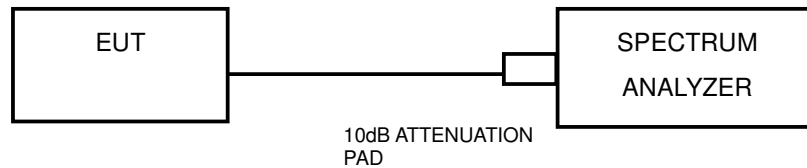

4.6.3 TEST INSTRUMENTS

Refer to section 4.3.3 to get information of above instrument.

4.6.4 TEST PROCEDURES

1. Check the calibration of the measuring instrument using either an internal calibrator or a known signal from an external generator.
2. Turn on the EUT and connect it to measurement instrument. Then set it to any one convenient frequency within its operating range.
3. By using the MaxHold function record the separation of two adjacent channels.
4. Measure the frequency difference of these two adjacent channels by SA MARK function. And then plot the result on SA screen.
5. Repeat above procedures until all frequencies measured were complete.

4.6.5 DEVIATION FROM TEST STANDARD

No deviation.

4.6.6 TEST RESULTS

GFSK

CHANNEL	FREQUENCY (MHz)	ADJACENT CHANNEL SEPARATION (MHz)	20dB BANDWIDTH (MHz)	MINIMUM LIMIT (MHz)	PASS / FAIL
0	2402	1.00	1.02	0.68	PASS
39	2441	1.00	1.03	0.69	PASS
78	2480	1.00	1.03	0.69	PASS

NOTE: The minimum limit is two-third 20dB bandwidth.

CH 0

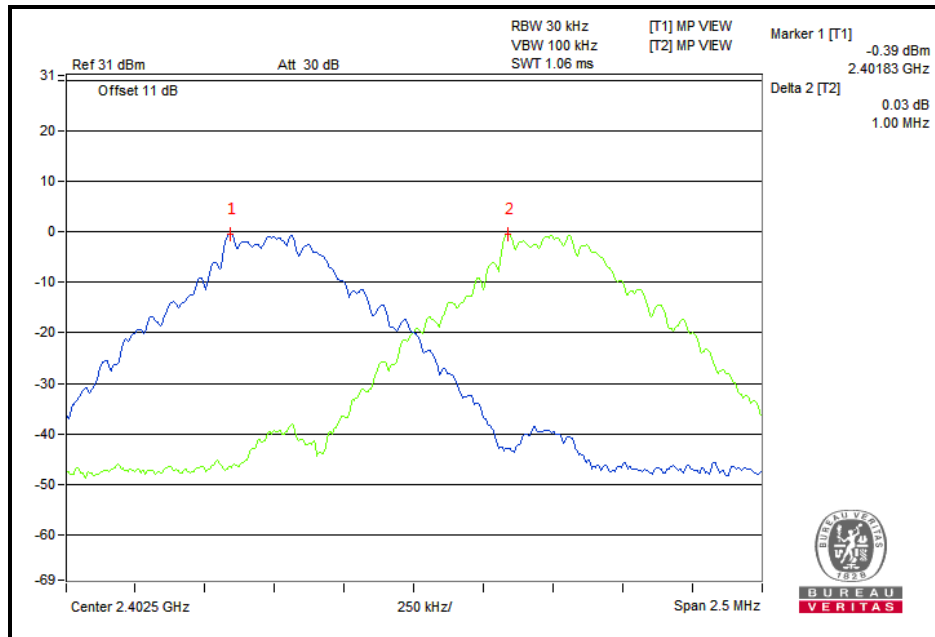

CH 39

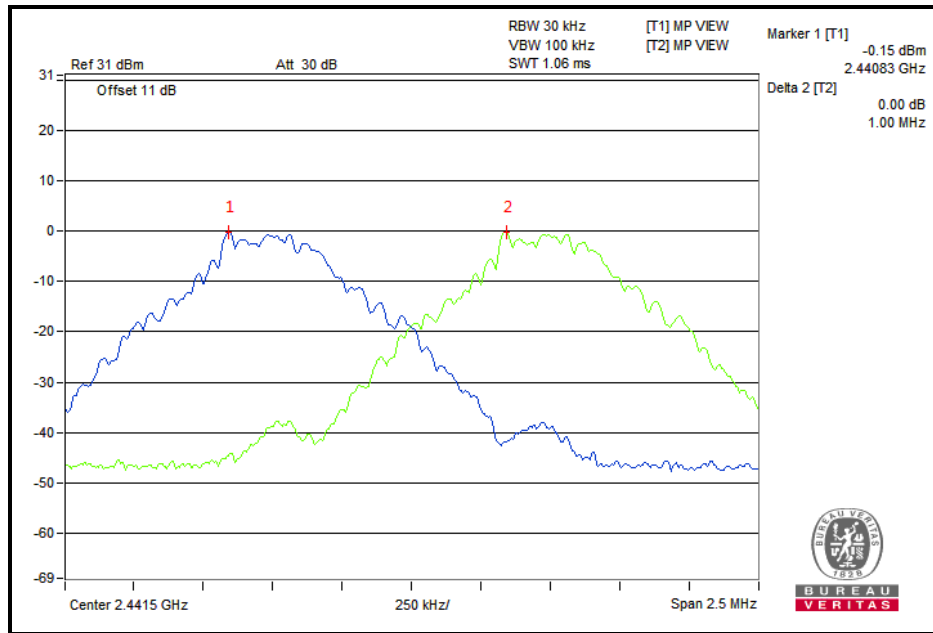

CH 78

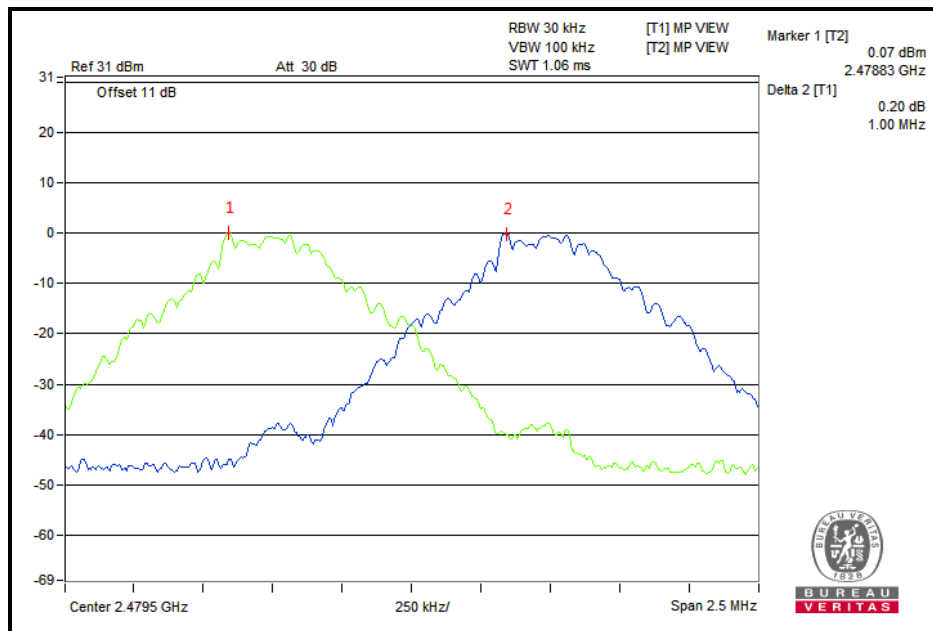

8DPSK

CHANNEL	FREQUENCY (MHz)	ADJACENT CHANNEL SEPARATION (MHz)	20dB BANDWIDTH (MHz)	MINIMUM LIMIT (MHz)	PASS / FAIL
0	2402	1.00	1.29	0.86	PASS
39	2441	1.00	1.29	0.86	PASS
78	2480	1.00	1.29	0.86	PASS

NOTE: The minimum limit is two-third 20dB bandwidth.

CH 0

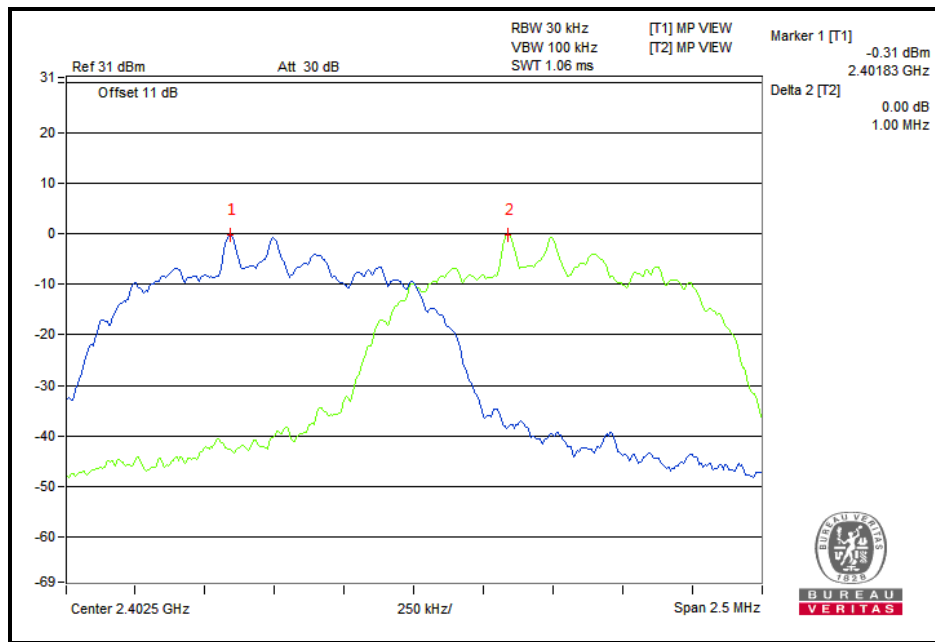

CH 39

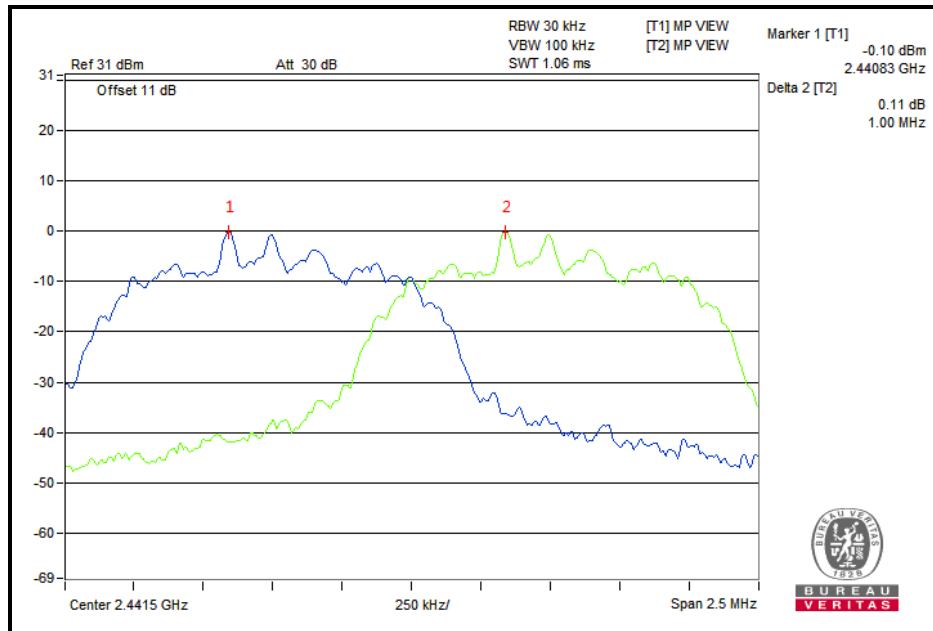

CH 78

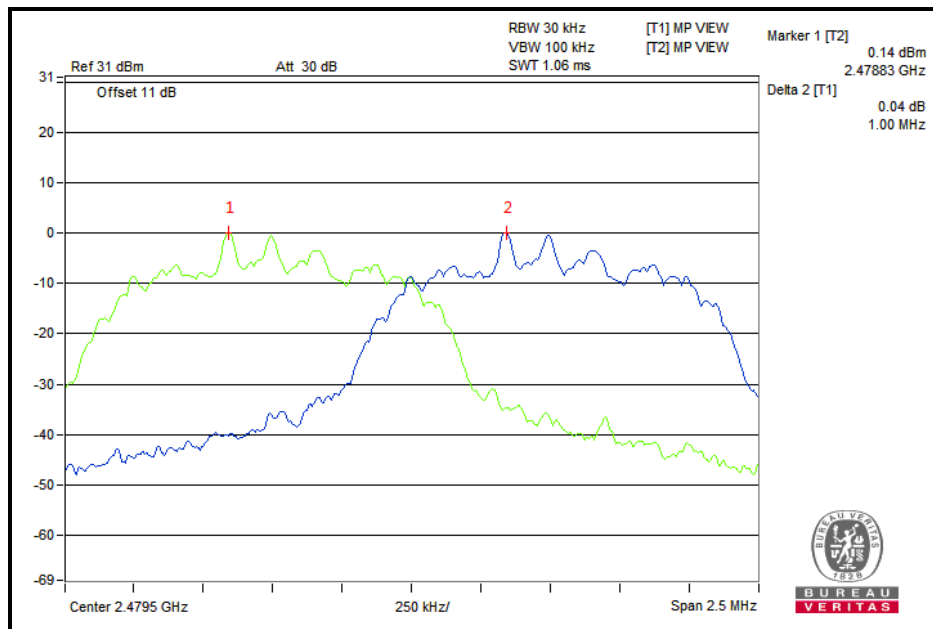

4.7 CONDUCTED OUTPUT POWER

4.7.1 LIMITS OF CONDUCTED OUTPUT POWER MEASUREMENT

The Maximum Output Power Measurement is 125mW.

4.7.2 TEST SETUP

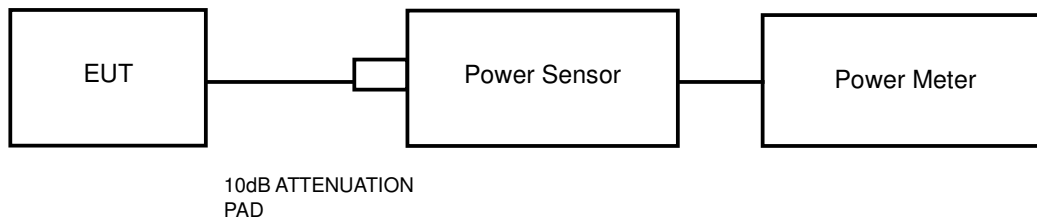

4.7.3 TEST INSTRUMENTS

Refer to section 4.3.3 to get information of above instrument.

4.7.4 TEST PROCEDURES

A peak power sensor was used on the output port of the EUT. A power meter was used to read the response of the peak power sensor and set the detector to PEAK. Record the power level.

An average power sensor was used on the output port of the EUT. A power meter was used to read the response of the average power sensor and set the detector to AVERAGE. Record the power level.

4.7.5 DEVIATION FROM TEST STANDARD

No deviation.



4.7.6 EUT OPERATING CONDITION

The software provided by client to enable the EUT under transmission condition continuously at lowest, middle and highest channel frequencies individually.

4.7.7 TEST RESULTS

MAXIMUM PEAK OUTPUT POWER

GFSK

CHANNEL	CHANNEL FREQUENCY (MHz)	PEAK POWER (dBm)	PEAK POWER (mW)	PEAK POWER LIMIT (mW)	PASS/FAIL
0	2402	2.26	1.683	125	PASS
39	2441	2.42	1.746	125	PASS
78	2480	2.61	1.824	125	PASS

8DPSK

CHANNEL	CHANNEL FREQUENCY (MHz)	PEAK POWER (dBm)	PEAK POWER (mW)	PEAK POWER LIMIT (mW)	PASS/FAIL
0	2402	3.48	2.228	125	PASS
39	2441	3.67	2.328	125	PASS
78	2480	3.86	2.432	125	PASS

AVERAGE OUTPUT POWER(FOR REFERENCE)

GFSK

CHANNEL	CHANNEL FREQUENCY (MHz)	AVERAGE POWER (dBm)	AVERAGE POWER (mW)
0	2402	0.78	1.197
39	2441	0.93	1.239
78	2480	1.12	1.294

8DPSK

CHANNEL	CHANNEL FREQUENCY (MHz)	AVERAGE POWER (dBm)	AVERAGE POWER (mW)
0	2402	0.82	1.208
39	2441	0.96	1.247
78	2480	1.15	1.303



4.8 OUT OF BAND EMISSION MEASUREMENT

4.8.1 LIMITS OF OUT OF BAND EMISSION MEASUREMENT

Below -20dB of the highest emission level of operating band (in 100KHz RBW).

4.8.2 TEST INSTRUMENTS

Refer to section 4.3.3 to get information of above instrument.

4.8.3 TEST PROCEDURE

The transmitter output was connected to the spectrum analyzer via a low loss cable. of Spectrum Analyzer was set RBW to 100 kHz and VBW to 300 kHz with suitable frequency span including 100 MHz bandwidth from band edge. Detector = PEAK and Trace mode = Max Hold. The band edges was measured and recorded.

4.8.4 DEVIATION FROM TEST STANDARD

No deviation.

4.8.5 EUT OPERATING CONDITION

The software provided by client to enable the EUT under transmission condition continuously at lowest, middle and highest channel frequencies individually.

4.8.6 TEST RESULTS

The spectrum plots are attached on the following images. D1 line indicates the highest level. D2 line indicates the 20dB offset below D1. It shows compliance to the requirement.



BUREAU VERITAS

Test Report No.: RF2209WDG0031

GFSK

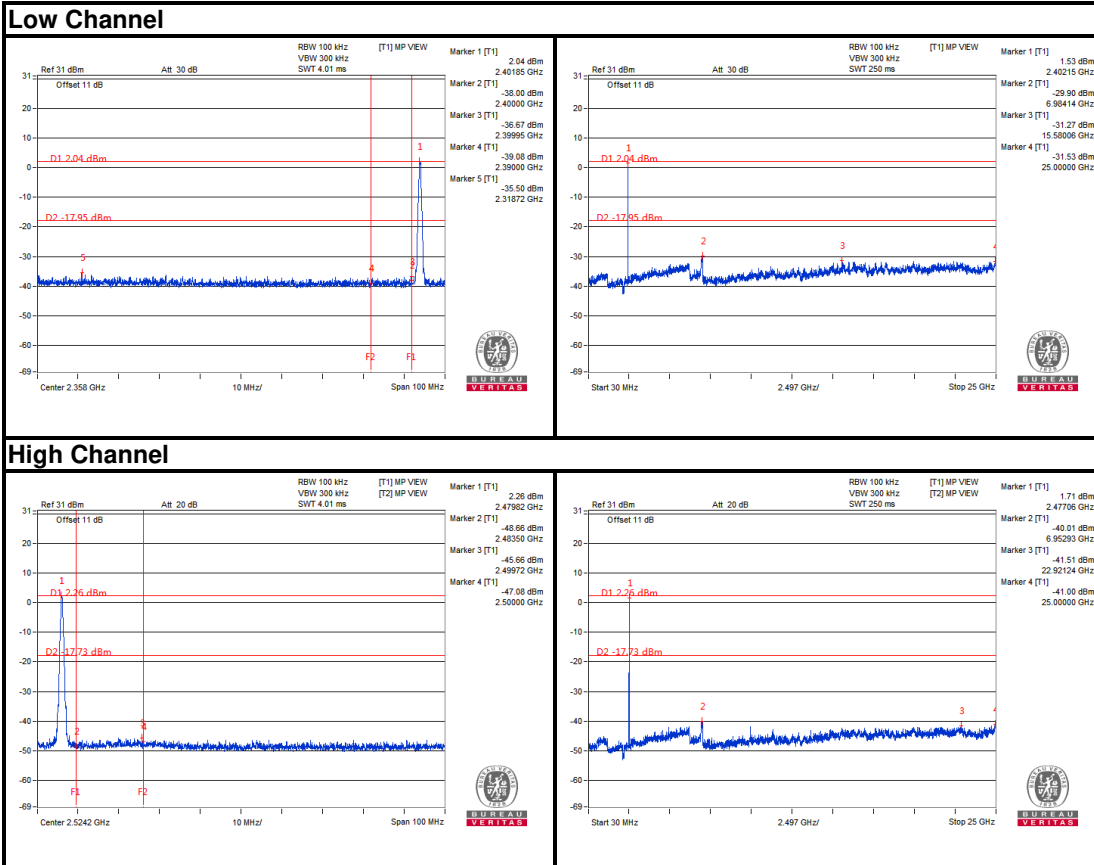

Bureau Veritas Shenzhen Co., Ltd.
Dongguan Branch

No. 96, Guantai Road (Houjie Section), Houjie
Town, Dongguan City, Guangdong Province.
523942, People's Republic of China.

Tel: +86 769 8998 2098
Fax: +86 769 8593 1080
Email: customerservice.dg@bureauveritas.com



BUREAU VERITAS

Test Report No.: RF2209WDG0031

8DPSK

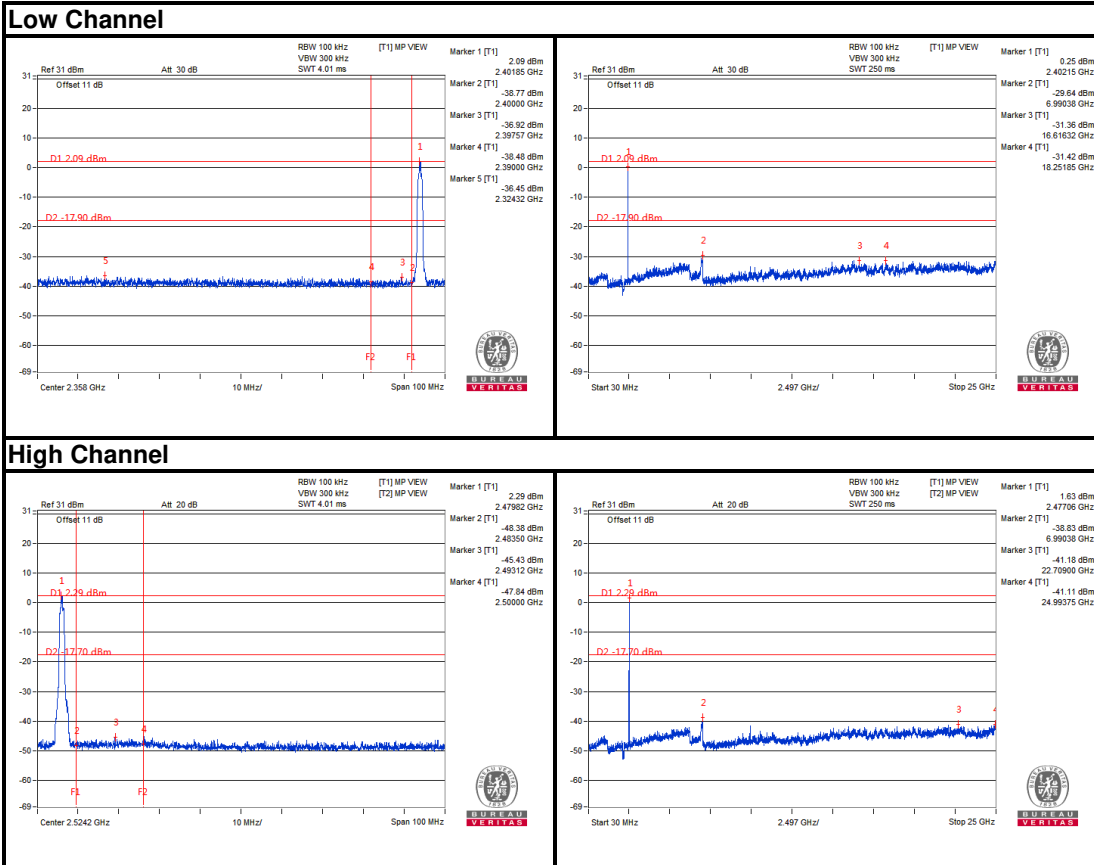

Bureau Veritas Shenzhen Co., Ltd.
Dongguan Branch

No. 96, Guantai Road (Houjie Section), Houjie
Town, Dongguan City, Guangdong Province.
523942, People's Republic of China.

Tel: +86 769 8998 2098
Fax: +86 769 8593 1080
Email: customerservice.dg@bureauveritas.com



BUREAU VERITAS

Test Report No.: RF2209WDG0031

GFSK

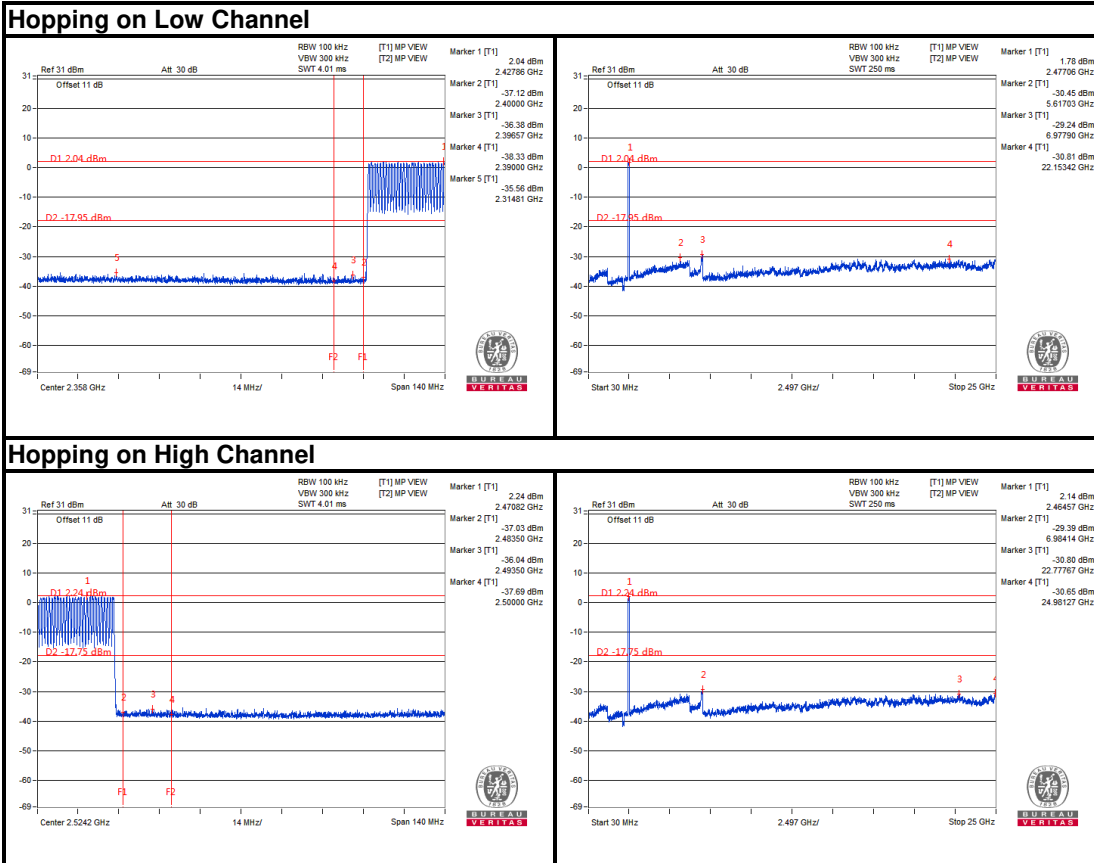

Bureau Veritas Shenzhen Co., Ltd.
Dongguan Branch

No. 96, Guantai Road (Houjie Section), Houjie
Town, Dongguan City, Guangdong Province.
523942, People's Republic of China.

Tel: +86 769 8998 2098
Fax: +86 769 8593 1080
Email: customerservice.dg@bureauveritas.com



BUREAU VERITAS

Test Report No.: RF2209WDG0031

8DPSK

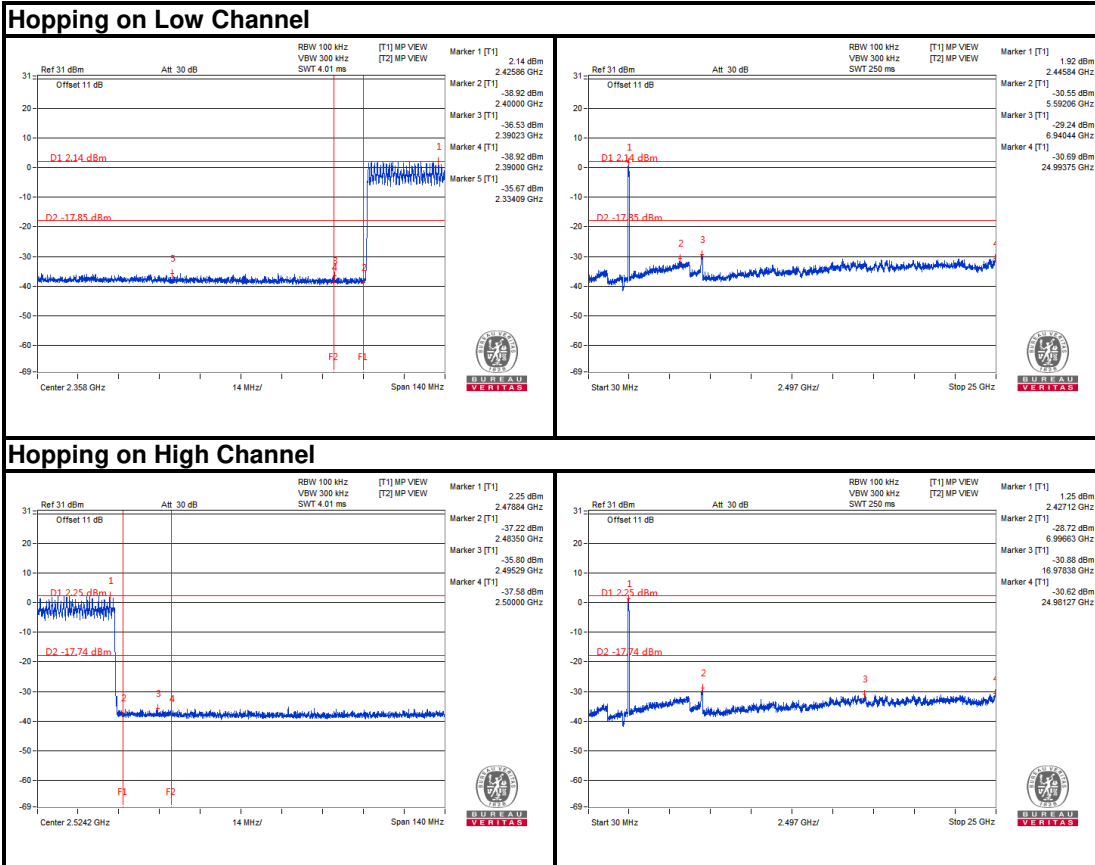

Bureau Veritas Shenzhen Co., Ltd.
Dongguan Branch

No. 96, Guantai Road (Houjie Section), Houjie
Town, Dongguan City, Guangdong Province.
523942, People's Republic of China.

Tel: +86 769 8998 2098
Fax: +86 769 8593 1080
Email: customerservice.dg@bureauveritas.com



Test Report No.: RF2209WDG0031

5 PHOTOGRAPHS OF THE TEST CONFIGURATION

Please refer to the attached file (Test Setup Photo).



Test Report No.: RF2209WDG0031

6 APPENDIX A - MODIFICATIONS RECORDERS FOR ENGINEERING CHANGES TO THE EUT BY THE LAB

No any modifications are made to the EUT by the lab during the test.

---END---