

Hearing Aid Compatibility (HAC) RF Emissions Test Report

APPLICANT : Joyous LLC
EQUIPMENT : Mobile Phone
MODEL NAME : SD4930UR
FCC ID : ZWH-1210
STANDARD : FCC 47 CFR §20.19
ANSI C63.19-2011
M CATEGORY : M4

The testing completed on Apr. 03, 2014. We, SPORTON INTERNATIONAL INC., would like to declare that the tested sample has been evaluated in accordance with the procedures and shown the compliance with the applicable technical standards.

The test results in this report apply exclusively to the tested model / sample. Without written approval of SPORTON INTERNATIONAL INC., the test report shall not be reproduced except in full.

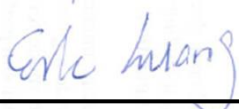

Reviewed by: Eric Huang / Deputy Manager



Approved by: Jones Tsai / Manager



SPORTON INTERNATIONAL INC.

No. 52, Hwa Ya 1st Rd., Hwa Ya Technology Park, Kwei-Shan Hsiang, Tao Yuan Hsien, Taiwan, R.O.C.

Table of Contents

Revision History.....	3
1. Statement of Compliance.....	4
2. Administration Data.....	5
3. General Information.....	6
3.1 Description of Equipment Under Test (EUT).....	6
3.2 Air Interface and Operating Mode.....	7
3.3 Applied Standards.....	7
4. HAC RF Emission.....	8
5. Measurement System Specification.....	9
5.1 Test Arch Phantom.....	9
5.2 E-Field Probe System.....	10
5.3 System Hardware.....	10
5.4 Data Storage and Evaluation.....	11
5.5 Test Equipment List.....	12
6. Measurement System Validation.....	13
6.1 Purpose of System Performance Check.....	13
6.2 System Setup.....	13
6.3 Verification Results.....	14
7. Modulation Interference Factor.....	15
8. RF Emissions Test Procedure.....	18
9. Conducted RF Output Power (Unit: dBm).....	21
10. Low-power Exemption.....	30
11. HAC RF Emission Test Results.....	32
11.1 E-Field Emission.....	32
12. Uncertainty Assessment.....	33
13. References.....	35
Appendix A. Plots of System Performance Check	
Appendix B. Plots of RF Emission Measurement	
Appendix C. DASY Calibration Certificate	
Appendix D. Test Setup Photos	

Revision History

REPORT NO.	VERSION	DESCRIPTION	ISSUED DATE
HA372301-01A	Rev. 01	Initial issue of report	Apr. 14, 2014
HA372301-01A	Rev. 02	In page 30, corrected MIF value for LTE band 5.	Apr. 16, 2014

1. Statement of Compliance

The maximum results of RF Emission of Hearing Aid Compliance (HAC) found during testing for the **Joyous LLC Mobile Phone, SD4930UR** are follows:

Band	HAC Rating
GSM850	M4
GSM1900	M4
WCDMA Band V	M4
WCDMA Band IV	M4
WCDMA Band II	M4
LTE Band 17	M4
LTE Band 5	M4
LTE Band 4	M4
LTE Band 2	M4
LTE Band 7	M4

They are in compliance with HAC limits specified in guidelines FCC 47 CFR §20.19 and ANSI Standard ANSI C63.19.

HAC Rating = M4 (ANSI C63.19-2011)

2. Administration Data

Testing Laboratory	
Test Site	SPORTON INTERNATIONAL INC.
Test Site Location	No. 52, Hwa Ya 1 st Rd., Hwa Ya Technology Park, Kwei-Shan Hsiang, Tao Yuan Hsien, Taiwan, R.O.C. TEL: +886-3-327-3456 FAX: +886-3-328-4978
Test Site No.	Sporton Site No. :
	SAR04-HY
Applicant	
Company Name	Joyous LLC
Address	1090 Vermont Avenue NW Suite 430 Washington, DC 20005
Application Details	
Test dates	Jan. 23, 2014 ~ Apr. 03, 2014

3. General Information

3.1 Description of Equipment Under Test (EUT)

Product Feature & Specification	
EUT Type	Mobile Phone
Model Name	SD4930UR
FCC ID	ZWH-1210
Wireless Technology and Frequency Range	GSM850: 824.2 MHz ~ 848.8 MHz GSM1900: 1850.2 MHz ~ 1909.8 MHz WCDMA Band V: 826.4 MHz ~ 846.6 MHz WCDMA Band IV: 1712.4 MHz ~ 1752.6 MHz WCDMA Band II: 1852.4 MHz ~ 1907.6 MHz LTE Band 17: 706.5 MHz ~ 713.5 MHz LTE Band 5: 824.7 MHz ~ 848.3 MHz LTE Band 4: 1710.7 MHz ~ 1754.3 MHz LTE Band 2: 1850.7 MHz ~ 1909.3 MHz LTE Band 7: 2502.5 MHz ~ 2567.5 MHz WLAN 2.4GHz Band: 2412 MHz ~ 2462 MHz WLAN 5.2GHz Band: 5180 MHz ~ 5240 MHz WLAN 5.8GHz Band: 5745 MHz ~ 5825 MHz Bluetooth: 2402 MHz ~ 2480 MHz NFC : 13.56 MHz
Antenna Type	WWAN Fixed Internal Antenna WLAN Fixed Internal Antenna Bluetooth: Fixed Internal Antenna NFC: Fixed Internal Antenna
Mode	<ul style="list-style-type: none"> • GSM/GPRS/EGPRS • WCDMA • HSDPA • HSUPA • LTE: QPSK, 16QAM • 802.11a/b/g/n/ac HT20/HT40/VHT20/VHT40/VHT80 • Bluetooth v3.0+EDR , Bluetooth v4.0-LE • NFC:ASK

3.2 Air Interface and Operating Mode

Air Interface	Band MHz	Type	C63.19 Tested	Simultaneous Transmitter	OTT	Power Reduction
GSM	850	VO	Yes	WLAN, BT	NA	No
	1900			WLAN, BT	NA	No
	GPRS/EDGE	DT	No	WLAN, BT	Yes	No
WCDMA	850	VO	Yes	WLAN, BT	NA	No
	1700			WLAN, BT	NA	No
	1900			WLAN, BT	NA	No
	HSPA	DT	No	WLAN, BT	Yes	No
LTE	Band 2	VD	No(*)	WLAN, BT	NA	No
	Band 4			WLAN, BT		No
	Band 5			WLAN, BT		No
	Band 7			WLAN, BT		No
	Band 17			WLAN, BT		No
WLAN	2450	DT	No	GSM, WCDMA,LTE	Yes	No
	5200			GSM, WCDMA,LTE		No
	5800			GSM, WCDMA,LTE		No
BT	2450	DT	No	GSM, WCDMA,LTE	NA	No
VO=CMRS Voice Service DT=Digital Transport VD=CMRS IP Voice Service and Digital Transport (*)No Associated T-Coil measurement has been made in accordance with 285076 D02 T-Coil testing for CMRS IP						

3.3 Applied Standards

- FCC CFR47 Part 20.19
- ANSI C63.19 2011-version
- FCC KDB 285076 D01 HAC Guidance v04
- FCC KDB 285076 D02 T Coil testing for CMRS IP v01r01

4. HAC RF Emission

FCC wireless hearing aid compatibility rules ensure that consumers with hearing loss are able to access wireless communications services through a wide selection of handsets without experiencing disabling radio frequency (RF) interference or other technical obstacles.

To define and measure the hearing aid compatibility of handsets, in CFR47 part 20.19 ANSI C63.19 is referenced. A handset is considered hearing aid-compatible for acoustic coupling if it meets a rating of at least M3 under ANSI C63.19, and A handset is considered hearing aid compatible for inductive coupling if it meets a rating of at least T3.

According to ANSI C63.19 2011 version, for acoustic coupling, the RF electric field emissions of wireless communication devices should be measured and rated according to the emission level as below.

Emission Categories	E-field emissions	
	<960Mhz	>960Mhz
M1	50 to 55 dB (V/m)	40 to 45 dB (V/m)
M2	45 to 50 dB (V/m)	35 to 40 dB (V/m)
M3	40 to 45 dB (V/m)	30 to 35 dB (V/m)
M4	<40 dB (V/m)	<30 dB (V/m)

Table 4.1 Telephone near-field categories in linear units

5. Measurement System Specification

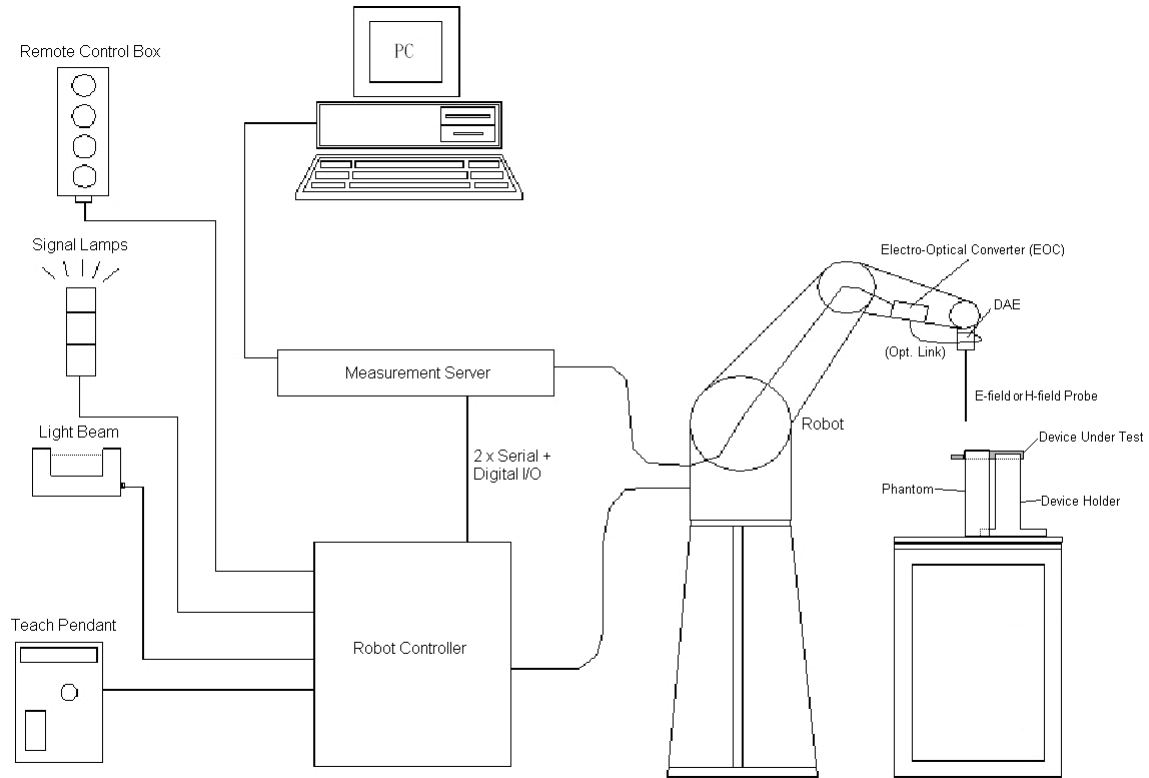

Fig 5.1 SPEAG DASY5 System Configurations

5.1 Test Arch Phantom

Construction :	Enables easy and well defined positioning of the phone and validation dipoles as well as simple teaching of the robot.	
Dimensions :	370 370 x 370 mm	

Fig 5.8 Photo of Arch Phantom

5.2 E-Field Probe System

E-Field Probe Specification

<ER3DV6>

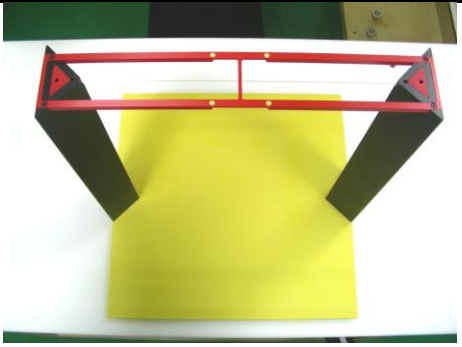
Construction	One dipole parallel, two dipoles normal to probe axis Built-in shielding against static charges
Calibration	In air from 100 MHz to 3.0 GHz (absolute accuracy $\pm 6.0\%$, $k=2$)
Frequency	100 MHz to 6 GHz; Linearity: ± 2.0 dB (100 MHz to 3 GHz)
Directivity	± 0.2 dB in air (rotation around probe axis) ± 0.4 dB in air (rotation normal to probe axis)
Dynamic Range	2 V/m to 1000 V/m (M3 or better device readings fall well below diode compression point)
Linearity	± 0.2 dB
Dimensions	Overall length: 330 mm (Tip: 16 mm) Tip diameter: 8 mm (Body: 12 mm) Distance from probe tip to dipole centers: 2.5 mm



Fig 5.2 Photo of E-field Probe

Probe Tip Description:

HAC field measurements take place in the close near field with high gradients. Increasing the measuring distance from the source will generally decrease the measured field values (in case of the validation dipole approx. 10% per mm).

5.3 System Hardware

DAE
The data acquisition electronics (DAE) consists of a highly sensitive electrometer-grade preamplifier with auto-zeroing, a channel and gain-switching multiplexer, a fast 16 bit AD-converter and a command decoder and control logic unit.
Robot
The SPEAG DASY system uses the high precision robots (DASY5: TX90XL) type from Stäubli SA (France). For the 6-axis controller system, the robot controller version (DASY5: CS8c) from Stäubli is used.

5.4 Data Storage and Evaluation

The DASY software stores the assessed data from the data acquisition electronics as raw data (in microvolt readings from the probe sensors), together with all the necessary software parameters for the data evaluation (probe calibration data, and device frequency and modulation data) in measurement files.

Probe parameters :	- Sensitivity	Norm _i , a _{i0} , a _{i1} , a _{i2}
	- Conversion factor	ConvF _i
	- Diode compression point	dcp _i
Device parameters :	- Frequency	f
	- Crest factor	cf
Media parameters :	- Conductivity	σ
	- Density	ρ

The formula for each channel can be given as :

$$V_i = U_i + U_i^2 \cdot \frac{cf}{dcp_i}$$

with V_i = compensated signal of channel i , ($i = x, y, z$)
 U_i = input signal of channel i , ($i = x, y, z$)
cf = crest factor of exciting field (DASY parameter)
dcp_i = diode compression point (DASY parameter)

From the compensated input signals, the primary field data for each channel can be evaluated :

$$\text{E-field Probes : } E_i = \sqrt{\frac{V_i}{\text{Norm}_i \cdot \text{ConvF}}}$$

with V_i = compensated signal of channel i , ($i = x, y, z$)
Norm_i = sensor sensitivity of channel i , ($i = x, y, z$), $\mu\text{V}/(\text{V}/\text{m})^2$ for E-field Probes
ConvF = sensitivity enhancement in solution
f = carrier frequency [GHz]
 E_i = electric field strength of channel i in V/m

The RSS value of the field components gives the total field strength (Hermitian magnitude) :

$$E_{\text{tot}} = \sqrt{E_x^2 + E_y^2 + E_z^2}$$

The primary field data are used to calculate the derived field units.

5.5 Test Equipment List

Manufacturer	Name of Equipment	Type/Model	Serial Number	Calibration	
				Last Cal.	Due Date
SPEAG	835MHz Calibration Dipole	CD835V3	1045	Jun. 14, 2012	Jun. 13, 2015
SPEAG	1880MHz Calibration Dipole	CD1880V3	1038	Jun. 14, 2012	Jun. 13, 2015
SPEAG	Data Acquisition Electronics	DAE4	778	Aug. 21, 2013	Aug. 20, 2014
SPEAG	Data Acquisition Electronics	DAE4	1279	Jan. 28, 2013	Jan. 27, 2014
SPEAG	Isotropic E-Field Probe	ER3DV6R	2256	Feb. 18, 2013	Feb. 17, 2014
SPEAG	Isotropic E-Field Probe	ER3DV6R	2358	Jan. 30, 2014	Jan. 29, 2015
Wisewind	Thermometer	ETP-101	TM560	Oct. 22, 2013	Oct. 21, 2014
SPEAG	Test Arch Phantom	N/A	N/A	NCR	NCR
SPEAG	Phone Positioner	N/A	N/A	NCR	NCR
Anritsu	Power Meter	ML2495A	1132003	Aug. 28, 2013	Aug. 27, 2014
Anritsu	Power Sensor	MA2411B	1126017	Aug. 27, 2013	Aug. 26, 2014
Agilent	Signal Generator	E4438C	MY49070755	Oct. 08, 2013	Oct. 07, 2014
Agilent	Wireless Communication Test Set	E5515C	MY50266977	May. 06, 2013	May. 05, 2015
Agilent	Dual Directional Coupler	778D	50422	NCR	NCR
Woken	Attenuator	WK0602-XX	N/A	NCR	NCR
AR	Power Amplifier	5S1G4M2	0328767	NCR	NCR

Table 5.1 Test Equipment List

Note: ER3DV6R SN: 2256 was used for testing GSM1900 band on Jan. 23, 2014.

6. Measurement System Validation

Each DASY system is equipped with one or more system validation kits. These units, together with the predefined measurement procedures within the DASY software, enable the user to conduct the system performance check and system validation. System validation kit includes a dipole, tripod holder to fix it underneath the test Arch and a corresponding distance holder.

6.1 Purpose of System Performance Check

The system performance check verifies that the system operates within its specifications. System and operator errors can be detected and corrected. It is recommended that the system performance check be performed prior to any usage of the system in order to guarantee reproducible results. The system performance check uses normal HAC measurements in a simplified setup with a well characterized source. This setup was selected to give a high sensitivity to all parameters that might fail or vary over time. The system check does not intend to replace the calibration of the components, but indicates situations where the system uncertainty is exceeded due to drift or failure.

6.2 System Setup

1. In the simplified setup for system evaluation, the EUT is replaced by a calibrated dipole and the power source is replaced by a continuous wave which comes from a signal generator.
2. The center point of the probe element(s) is 15mm from the closest surface of the dipole elements.
3. The calibrated dipole must be placed beneath the arch phantom. The equipment setup is shown below:

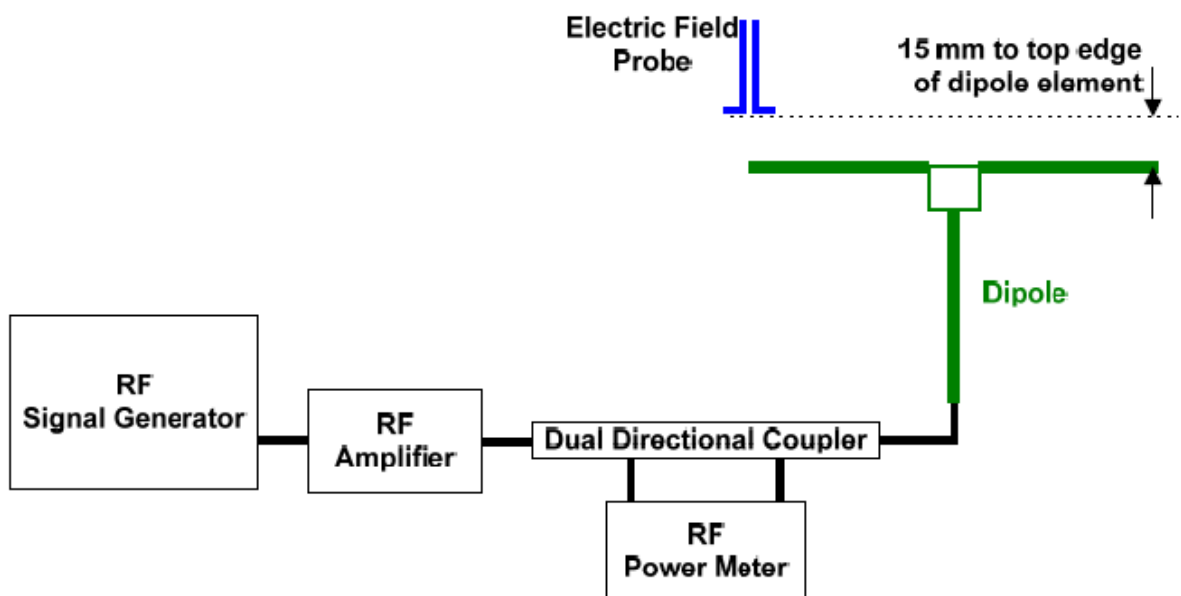

Fig. 6.1 System Validation Setup

The output power on dipole port must be calibrated to 20dBm (100mW) before dipole is connected.

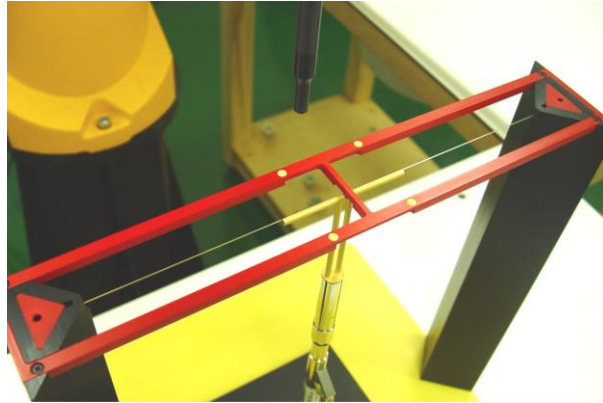

Fig 7.2 Dipole Setup

6.3 Verification Results

Comparing to the original E-field value provided by SPEAG, the verification data should be within its specification of 25 %. Table 6.1 shows the target value and measured value. The table below indicates the system performance check can meet the variation criterion and the plots can be referred to appendix A of this report.

Frequency (MHz)	Input Power (dBm)	Target Value (V/m)	E-Field above high end (V/m)	E-Field above low end (V/m)	Average Value (V/m)	Deviation (%)	Date
835	20	107.7	114	113.5	113.75	5.62	2014/4/3
1880	20	89.2	87.72	83.5	85.61	-4.02	2014/1/23

Table 6.1 Test Results of System Validation

Note: Deviation = ((Average E-field Value) - (Target value)) / (Target value) * 100%

7. Modulation Interference Factor

The HAC Standard ANSI C63.19-2011 defines a new scaling using the Modulation Interference Factor (MIF).

For any specific fixed and repeatable modulated signal, a modulation interference factor (MIF, expressed in dB) may be developed that relates its interference potential to its steady-state rms signal level or average power level. This factor is a function only of the audio-frequency amplitude modulation characteristics of the signal and is the same for field-strength and conducted power measurements. It is important to emphasize that the MIF is valid only for a specific repeatable audio-frequency amplitude modulation characteristic. Any change in modulation characteristic requires determination and application of a new MIF

The Modulation Interference factor (MIF, in dB) is added to the measured average E-field (in dBV/m) and converts it to the RF Audio Interference level (in dBV/m). This level considers the audible amplitude modulation components in the RF E-field. CW fields without amplitude modulation are assumed to not interfere with the hearing aid electronics. Modulations without time slots and low fluctuations at low frequencies have low MIF values, TDMA modulations with narrow transmission and repetition rates of few 100 Hz have high MIF values and give similar classifications as ANSI C63.19-2007.

ER3D, EF3D and EU2D E-field probes have a bandwidth <10 kHz and can therefore not evaluate the RF envelope in the full audio band. DASY52 is therefore using the indirect measurement method according to ANSI C63.19-2011 which is the primary method. These near field probes read the averaged E-field measurement. Especially for the new high peak-to-average (PAR) signal types, the probes shall be linearized by PMR calibration in order to not overestimate the field reading. Probe Modulation Response (PMR) calibration linearizes the probe response over its dynamic range for specific modulations which are characterized by their UID and result in an uncertainty specified in the probe calibration certificate. The MIF is characteristic for a given waveform envelope and can be used as a constant conversion factor if the probe has been PMR calibrated.

The evaluation method for the MIF is defined in ANSI C63.19-2011 section D.7. An RMS demodulated RF signal is fed to a spectral filter (similar to an A weighting filter) and forwarded to a temporal filter acting as a quasi-peak detector. The averaged output of these filtering is scaled to a 1 kHz 80% AM signal as reference. MIF measurement requires additional instrumentation and is not well suited for evaluation by the end user with reasonable uncertainty. It may alternatively be determined through analysis and simulation, because it is constant and characteristic for a communication signal. DASY52 uses well-defined signals for PMR calibration. The MIF of these signals has been determined by simulation and it is automatically applied.

MIF values applied in this test report were provided by the HAC equipment provider, SPEAG, and the values are listed below

UID	Communication System Name	MIF(dB)
10021	GSM-FDD(TDMA,GMSK)	3.63
10011	UMTS-FDD(WCDMA)	-27.23
10100	LTE-FDD(SC-FDMA,100%RB,20MHz,QPSK)	-23.48
10101	LTE-FDD(SC-FDMA,100%RB,20MHz,16-QAM)	-17.86
10108	LTE-FDD(SC-FDMA,100%RB,10MHz,QPSK)	-21.57
10109	LTE-FDD(SC-FDMA,100%RB,10MHz,16-QAM)	-16.87
10110	LTE-FDD(SC-FDMA,100%RB,5MHz,QPSK)	-23.39
10111	LTE-FDD(SC-FDMA,100%RB,5MHz,16-QAM)	-16.35
10139	LTE-FDD(SC-FDMA,100%RB,15MHz,QPSK)	-20.11
10140	LTE-FDD(SC-FDMA,100%RB,15MHz,16-QAM)	-19.37
10142	LTE-FDD(SC-FDMA,100%RB,3MHz,QPSK)	-22.36
10143	LTE-FDD(SC-FDMA,100%RB,3MHz,16-QAM)	-14.75
10145	LTE-FDD(SC-FDMA,100%RB,1.4MHz,QPSK)	-17.39
10146	LTE-FDD(SC-FDMA,100%RB,1.4MHz,16-QAM)	-13.6
10148	LTE-FDD(SC-FDMA,50%RB,20MHz,QPSK)	-21.56
10149	LTE-FDD(SC-FDMA,50%RB,20MHz,16-QAM)	-16.87
10154	LTE-FDD(SC-FDMA,50%RB,10MHz,QPSK)	-23.42
10155	LTE-FDD(SC-FDMA,50%RB,10MHz,16-QAM)	-16.36
10156	LTE-FDD(SC-FDMA,50%RB,5MHz,QPSK)	-21.71
10157	LTE-FDD(SC-FDMA,50%RB,5MHz,16-QAM)	-15.78
10160	LTE-FDD(SC-FDMA,50%RB,15MHz,QPSK)	-17.95
10161	LTE-FDD(SC-FDMA,50%RB,15MHz,16-QAM)	-17.54
10163	LTE-FDD(SC-FDMA,50%RB,3MHz,QPSK)	-20.24
10164	LTE-FDD(SC-FDMA,50%RB,3MHz,16-QAM)	-14.38
10166	LTE-FDD(SC-FDMA,50%RB,1.4MHz,QPSK)	-18.1
10167	LTE-FDD(SC-FDMA,50%RB,1.4MHz,16-QAM)	-12.15
10169	LTE-FDD(SC-FDMA,1RB,20MHz,QPSK)	-15.63
10170	LTE-FDD(SC-FDMA,1RB,20MHz,16-QAM)	-9.76
10175	LTE-FDD(SC-FDMA,1RB,10MHz,QPSK)	-15.63
10176	LTE-FDD(SC-FDMA,1RB,10MHz,16-QAM)	-9.76
10177	LTE-FDD(SC-FDMA,1RB,5MHz,QPSK)	-15.63
10178	LTE-FDD(SC-FDMA,1RB,5MHz,16-QAM)	-9.76
10181	LTE-FDD(SC-FDMA,1RB,15MHz,QPSK)	-15.63
10182	LTE-FDD(SC-FDMA,1RB,15MHz,16-QAM)	-9.76
10184	LTE-FDD(SC-FDMA,1RB,3MHz,QPSK)	-15.62
10185	LTE-FDD(SC-FDMA,1RB,3MHz,16-QAM)	-9.76
10187	LTE-FDD(SC-FDMA,1RB,1.4MHz,QPSK)	-15.62
10188	LTE-FDD(SC-FDMA,1RB,1.4MHz,16-QAM)	-9.76

Remark:

For LTE air interface, the worst MIF values of QPSK and 16QAM modulation among all RB configurations occur in 1 RB configurations.

The MIF measurement uncertainty is estimated as follows, declared by HAC equipment provider SPEAG, for modulation frequencies from slotted waveforms with fundamental frequency and at least 2 harmonics within 10 kHz:

- i) 0.2 dB for MIF: -7 to +5 dB,
- ii) 0.5 dB for MIF: -13 to +11 dB
- iii) 1 dB for MIF: > -20 dB

8. RF Emissions Test Procedure

Referenced from ANSI C63.19 -2011 section 5.5.1

- a) Confirm the proper operation of the field probe, probe measurement system, and other instrumentation and the positioning system.
- b) Position the WD in its intended test position.
- c) Set the WD to transmit a fixed and repeatable combination of signal power and modulation characteristic that is representative of the worst case (highest interference potential) encountered in normal use. Transiently occurring start-up, changeover, or termination conditions, or other operations likely to occur less than 1% of the time during normal operation, may be excluded from consideration.
- d) The center sub-grid shall be centered on the T-Coil mode perpendicular measurement point or the acoustic output, as appropriate. Locate the field probe at the initial test position in the 50 mm by 50 mm grid, which is contained in the measurement plane, refer to illustrated in Figure 8.2. If the field alignment method is used, align the probe for maximum field reception.
- e) Record the reading at the output of the measurement system.
- f) Scan the entire 50 mm by 50 mm region in equality spaced increments and record the reading at each measurement point, The distance between measurement points shall be sufficient to assure the identification of the maximum reading.
- g) Identify the five contiguous sub-grids around the center sub-grid whose maximum reading is the lowest of all available choices. This eliminates the three sub-grids with the maximum readings. Thus, the six areas to be used to determine the WD's highest emissions are identified.
- h) Identify the maximum reading within the non-excluded sub-grids identified in step g).
- i) *Indirect measurement method*
The RF audio interference level in dB (V/m) is obtained by adding the MIF (in dB) to the maximum steady-state rms field-strength reading, in dB (V/m)
- j) Compare this RF audio interference level with the categories in ANSI C63.19-2011 clause 8 and record the resulting WD category rating.
- k) For the T-Coil mode M-rating assessment, determine whether the chosen perpendicular measurement point is contained in an included sub-grid of the first scan. If so, then a second scan is not necessary. The first scan and resultant category rating may be used for the T-Coil mode M rating.

Otherwise, repeat step a) through step i), with the grid shifted so that it is centered on the perpendicular measurement point. Record the WD category rating.

Test Instructions

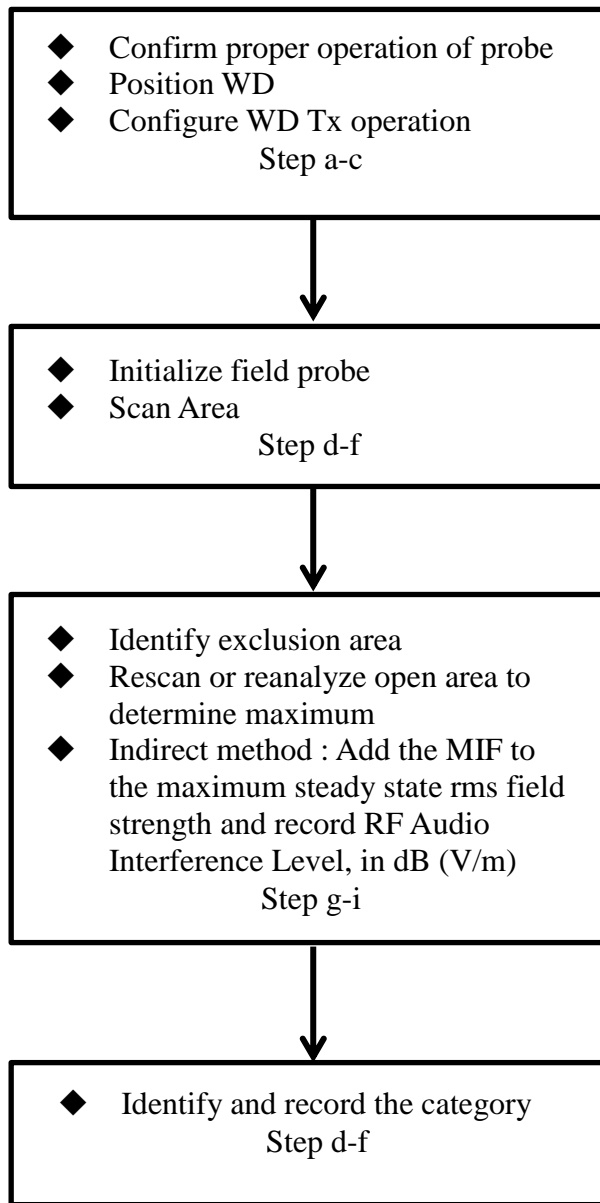

Fig 8.1 Flow Chart of HAC RF Emission



Fig 8.2 EUT reference and plane for HAC RF emission measurements

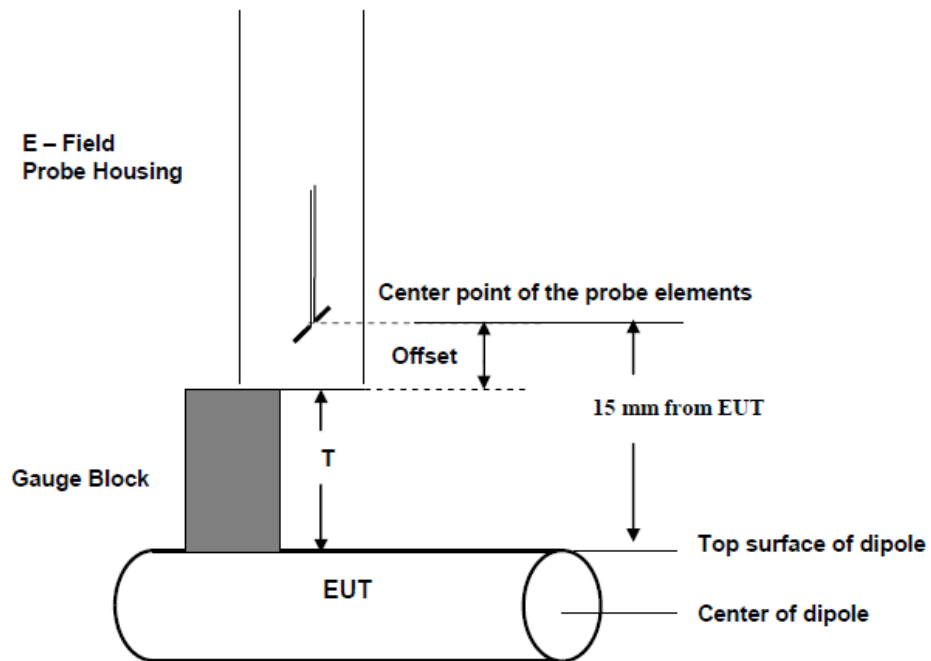

Fig. 8.3 Gauge block with E-field probe

9. Conducted RF Output Power (Unit: dBm)

<GSM Average Input Power>

Band	GSM850			GSM1900		
Channel	128	189	251	512	661	810
Frequency (MHz)	824.2	836.4	848.8	1850.2	1880.0	1909.8
Average Antenna Input Power (dBm)	32.61	32.94	32.96	29.85	29.96	29.83

<WCDMA Average Input Power >

Band	WCDMA Band V			WCDMA Band II			WCDMA IV		
Channel	4132	4182	4233	9262	9400	9538	1312	1413	1513
Frequency (MHz)	826.4	836.4	846.6	1852.4	1880.0	1907.6	1712.4	1732.6	1752.6
Average Antenna Input Power (dBm)	23.45	23.48	23.43	23.45	23.30	23.15	23.40	23.35	23.33

<LTE Average Input Power>

<LTE Band 17>

Channel				23780	23790	23800
Frequency (MHz)				709	710	711
BW [MHz]	Modulation	RB Size	RB Offset	Power(dBm)	Power(dBm)	Power(dBm)
10	QPSK	1	0	22.81	22.85	22.92
10	QPSK	1	24	22.51	22.85	22.79
10	QPSK	1	49	22.30	22.61	22.49
10	QPSK	25	0	22.31	21.98	21.98
10	QPSK	25	12	21.98	22.02	22.00
10	QPSK	25	24	21.97	22.00	22.00
10	QPSK	50	0	21.92	22.00	21.99
10	16QAM	1	0	21.96	21.83	21.87
10	16QAM	1	24	21.89	21.86	21.75
10	16QAM	1	49	21.79	21.89	21.82
10	16QAM	25	0	20.98	21.00	21.00
10	16QAM	25	12	20.98	20.97	20.95
10	16QAM	25	24	21.00	20.96	20.98
10	16QAM	50	0	20.96	20.94	20.93
Channel				23755	23790	23825
Frequency (MHz)				706.5	710	713.5
BW [MHz]	Modulation	RB Size	RB Offset	Power(dBm)	Power(dBm)	Power(dBm)
5	QPSK	1	0	22.90	22.84	22.72
5	QPSK	1	12	22.88	22.69	22.76
5	QPSK	1	24	22.61	22.51	22.35
5	QPSK	12	0	22.35	22.01	22.05
5	QPSK	12	6	22.36	22.00	21.96
5	QPSK	12	11	22.03	22.02	21.93
5	QPSK	25	0	22.03	21.99	21.95
5	16QAM	1	0	21.94	21.78	21.75
5	16QAM	1	12	21.92	21.84	21.75
5	16QAM	1	24	21.89	21.88	21.64
5	16QAM	12	0	21.05	20.98	21.01
5	16QAM	12	6	21.02	20.97	20.94
5	16QAM	12	11	21.06	20.98	20.96
5	16QAM	25	0	21.02	20.96	20.97

<LTE Band 5>

BW [MHz]	Modulation	RB Size	RB Offset	Power Low Ch. / Freq.	Power Middle Ch. / Freq.	Power High Ch. / Freq.
Channel				20450	20525	20600
Frequency (MHz)				829	836.5	844
10	QPSK	1	0	22.92	22.83	22.94
10	QPSK	1	24	22.80	22.74	22.84
10	QPSK	1	49	22.91	22.88	22.92
10	QPSK	25	0	21.87	21.83	21.87
10	QPSK	25	12	21.79	21.95	21.87
10	QPSK	25	24	21.79	21.73	21.94
10	QPSK	50	0	21.87	21.77	21.85
10	16QAM	1	0	21.92	21.73	21.76
10	16QAM	1	24	21.75	21.68	21.74
10	16QAM	1	49	21.83	21.76	21.84
10	16QAM	25	0	20.86	20.79	20.80
10	16QAM	25	12	20.83	20.74	20.81
10	16QAM	25	24	20.80	20.75	20.91
10	16QAM	50	0	20.78	20.69	20.77
BW [MHz]	Modulation	RB Size	RB Offset	Power Low Ch. / Freq.	Power Middle Ch. / Freq.	Power High Ch. / Freq.
Channel				20425	20525	20625
Frequency (MHz)				826.5	836.5	846.5
5	QPSK	1	0	22.92	22.87	22.79
5	QPSK	1	12	22.83	22.75	22.88
5	QPSK	1	24	22.83	22.83	22.88
5	QPSK	12	0	21.91	21.79	21.84
5	QPSK	12	6	21.90	21.78	21.90
5	QPSK	12	11	21.89	21.75	21.89
5	QPSK	25	0	21.89	21.76	21.95
5	16QAM	1	0	21.92	21.79	21.77
5	16QAM	1	12	21.75	21.71	21.81
5	16QAM	1	24	21.72	21.76	21.77
5	16QAM	12	0	20.87	20.78	20.80
5	16QAM	12	6	20.84	20.76	20.88
5	16QAM	12	11	20.85	20.74	20.86
5	16QAM	25	0	20.82	20.74	20.90
BW [MHz]	Modulation	RB Size	RB Offset	Power Low Ch. / Freq.	Power Middle Ch. / Freq.	Power High Ch. / Freq.
Channel				20415	20525	20635
Frequency (MHz)				825.5	836.5	847.5
3	QPSK	1	0	22.82	22.57	22.74
3	QPSK	1	7	22.65	22.58	22.70
3	QPSK	1	14	22.68	22.70	22.71
3	QPSK	8	0	21.73	21.61	21.71
3	QPSK	8	4	21.70	21.56	21.75
3	QPSK	8	7	21.72	21.60	21.76
3	QPSK	15	0	21.69	21.61	21.73
3	16QAM	1	0	21.72	21.51	21.63
3	16QAM	1	7	21.57	21.52	21.62
3	16QAM	1	14	21.60	21.61	21.63
3	16QAM	8	0	20.65	20.58	20.69
3	16QAM	8	4	20.69	20.55	20.73
3	16QAM	8	7	20.68	20.54	20.72
3	16QAM	15	0	20.64	20.52	20.67

BW [MHz]	Modulation	RB Size	RB Offset	Power Low Ch. / Freq.	Power Middle Ch. / Freq.	Power High Ch. / Freq.
Channel				20407	20525	20643
Frequency (MHz)				824.7	836.5	848.3
1.4	QPSK	1	0	22.82	22.86	22.75
1.4	QPSK	1	2	22.81	22.60	22.73
1.4	QPSK	1	5	22.70	22.61	22.74
1.4	QPSK	3	0	22.85	22.60	22.74
1.4	QPSK	3	1	22.85	22.59	22.71
1.4	QPSK	3	2	22.70	22.59	22.77
1.4	QPSK	6	0	21.76	21.61	21.78
1.4	16QAM	1	0	21.75	21.52	21.67
1.4	16QAM	1	2	21.78	21.56	21.67
1.4	16QAM	1	5	21.65	21.56	21.67
1.4	16QAM	3	0	21.77	21.57	21.72
1.4	16QAM	3	1	21.75	21.57	21.67
1.4	16QAM	3	2	21.68	21.58	21.65
1.4	16QAM	6	0	20.55	20.53	20.58

<LTE Band 4>

BW [MHz]	Modulation	RB Size	RB Offset	Power Low Ch. / Freq.	Power Middle Ch. / Freq.	Power High Ch. / Freq.
Channel				20050	20175	20300
Frequency (MHz)				1720	1732.5	1745
20	QPSK	1	0	23.70	23.75	23.74
20	QPSK	1	49	23.59	23.64	23.64
20	QPSK	1	99	23.56	23.67	23.61
20	QPSK	50	0	22.70	22.94	22.90
20	QPSK	50	24	22.73	22.91	22.83
20	QPSK	50	49	22.69	22.88	22.83
20	QPSK	100	0	22.66	22.84	22.74
20	16QAM	1	0	22.62	22.63	22.71
20	16QAM	1	49	22.54	22.71	22.60
20	16QAM	1	99	22.56	22.62	22.58
20	16QAM	50	0	21.65	21.85	21.83
20	16QAM	50	24	21.64	21.82	21.77
20	16QAM	50	49	21.69	21.79	21.78
20	16QAM	100	0	21.65	21.82	21.76
BW [MHz]	Modulation	RB Size	RB Offset	Power Low Ch. / Freq.	Power Middle Ch. / Freq.	Power High Ch. / Freq.
Channel				20025	20175	20325
Frequency (MHz)				1717.5	1732.5	1747.5
15	QPSK	1	0	23.58	23.56	23.69
15	QPSK	1	37	23.56	23.54	23.68
15	QPSK	1	74	23.47	23.57	23.66
15	QPSK	36	0	22.65	22.71	22.79
15	QPSK	36	18	22.67	22.67	22.75
15	QPSK	36	37	22.68	22.71	22.82
15	QPSK	75	0	22.68	22.76	22.79
15	16QAM	1	0	22.55	22.53	22.63
15	16QAM	1	37	22.56	22.47	22.62
15	16QAM	1	74	22.46	22.52	22.60
15	16QAM	36	0	21.56	21.63	21.72
15	16QAM	36	18	21.56	21.67	21.69
15	16QAM	36	37	21.57	21.66	21.75
15	16QAM	75	0	21.67	21.73	21.79
BW [MHz]	Modulation	RB Size	RB Offset	Power Low Ch. / Freq.	Power Middle Ch. / Freq.	Power High Ch. / Freq.
Channel				20000	20175	20350
Frequency (MHz)				1715	1732.5	1750
10	QPSK	1	0	23.34	23.49	23.50
10	QPSK	1	24	23.37	23.44	23.49
10	QPSK	1	49	23.35	23.43	23.49
10	QPSK	25	0	22.44	22.46	22.60
10	QPSK	25	12	22.38	22.47	22.61
10	QPSK	25	24	22.43	22.44	22.54
10	QPSK	50	0	22.48	22.62	22.69
10	16QAM	1	0	22.34	22.40	22.50
10	16QAM	1	24	22.32	22.38	22.46
10	16QAM	1	49	22.33	22.39	22.44
10	16QAM	25	0	21.43	21.46	21.55
10	16QAM	25	12	21.42	21.48	21.56
10	16QAM	25	24	21.38	21.46	21.56
10	16QAM	50	0	21.45	21.53	21.62

BW [MHz]	Modulation	RB Size	RB Offset	Power Low Ch. / Freq.	Power Middle Ch. / Freq.	Power High Ch. / Freq.
Channel				19975	20175	20375
Frequency (MHz)				1712.5	1732.5	1752.5
5	QPSK	1	0	23.35	23.47	23.53
5	QPSK	1	12	23.34	23.34	23.52
5	QPSK	1	24	23.39	23.38	23.49
5	QPSK	12	0	22.41	22.53	22.62
5	QPSK	12	6	22.42	22.51	22.64
5	QPSK	12	11	22.43	22.42	22.62
5	QPSK	25	0	22.46	22.47	22.60
5	16QAM	1	0	22.33	22.40	22.51
5	16QAM	1	12	22.30	22.29	22.48
5	16QAM	1	24	22.32	22.29	22.45
5	16QAM	12	0	21.42	21.50	21.62
5	16QAM	12	6	21.42	21.49	21.63
5	16QAM	12	11	21.41	21.41	21.63
5	16QAM	25	0	21.39	21.51	21.63
BW [MHz]	Modulation	RB Size	RB Offset	Power Low Ch. / Freq.	Power Middle Ch. / Freq.	Power High Ch. / Freq.
Channel				19965	20175	20385
Frequency (MHz)				1711.5	1732.5	1753.5
3	QPSK	1	0	23.41	23.47	23.59
3	QPSK	1	7	23.34	23.32	23.47
3	QPSK	1	14	23.40	23.36	23.50
3	QPSK	8	0	22.44	22.53	22.60
3	QPSK	8	4	22.40	22.51	22.49
3	QPSK	8	7	22.42	22.41	22.57
3	QPSK	15	0	22.47	22.48	22.57
3	16QAM	1	0	22.32	22.39	22.53
3	16QAM	1	7	22.31	22.29	22.41
3	16QAM	1	14	22.34	22.35	22.50
3	16QAM	8	0	21.42	21.49	21.66
3	16QAM	8	4	21.45	21.49	21.57
3	16QAM	8	7	21.41	21.40	21.55
3	16QAM	15	0	21.39	21.46	21.52
BW [MHz]	Modulation	RB Size	RB Offset	Power Low Ch. / Freq.	Power Middle Ch. / Freq.	Power High Ch. / Freq.
Channel				19957	20175	20393
Frequency (MHz)				1710.7	1732.5	1754.3
1.4	QPSK	1	0	23.41	23.51	23.58
1.4	QPSK	1	2	23.43	23.52	23.52
1.4	QPSK	1	5	23.44	23.42	23.57
1.4	QPSK	3	0	23.45	23.48	23.55
1.4	QPSK	3	1	23.43	23.50	23.53
1.4	QPSK	3	2	23.43	23.54	23.52
1.4	QPSK	6	0	22.50	22.56	22.61
1.4	16QAM	1	0	22.37	22.48	22.48
1.4	16QAM	1	2	22.40	22.47	22.56
1.4	16QAM	1	5	22.41	22.32	22.50
1.4	16QAM	3	0	22.42	22.47	22.51
1.4	16QAM	3	1	22.40	22.48	22.49
1.4	16QAM	3	2	22.40	22.49	22.55
1.4	16QAM	6	0	21.30	21.37	21.46

<LTE Band 2>

BW [MHz]	Modulation	RB Size	RB Offset	Power Low Ch. / Freq.	Power Middle Ch. / Freq.	Power High Ch. / Freq.
Channel				18700	18900	19100
Frequency (MHz)				1860	1880	1900
20	QPSK	1	0	23.07	23.44	23.09
20	QPSK	1	49	22.97	23.20	22.78
20	QPSK	1	99	23.01	23.01	22.76
20	QPSK	50	0	22.34	22.43	22.20
20	QPSK	50	24	22.49	22.56	22.15
20	QPSK	50	49	22.29	22.37	21.90
20	QPSK	100	0	22.20	22.21	21.75
20	16QAM	1	0	22.26	22.81	22.22
20	16QAM	1	49	22.42	22.45	22.14
20	16QAM	1	99	22.24	22.25	21.96
20	16QAM	50	0	21.17	21.29	20.86
20	16QAM	50	24	21.34	21.43	20.96
20	16QAM	50	49	21.24	21.27	20.81
20	16QAM	100	0	20.84	20.87	20.49
BW [MHz]	Modulation	RB Size	RB Offset	Power Low Ch. / Freq.	Power Middle Ch. / Freq.	Power High Ch. / Freq.
Channel				18675	18900	19125
Frequency (MHz)				1857.5	1880	1902.5
15	QPSK	1	0	23.43	23.37	23.08
15	QPSK	1	37	23.38	23.35	23.05
15	QPSK	1	74	23.29	23.32	23.06
15	QPSK	36	0	22.88	22.95	22.49
15	QPSK	36	18	22.98	22.92	22.49
15	QPSK	36	37	22.95	22.97	22.50
15	QPSK	75	0	22.22	22.25	21.76
15	16QAM	1	0	22.54	22.60	22.42
15	16QAM	1	37	22.71	22.74	22.32
15	16QAM	1	74	22.75	22.68	22.30
15	16QAM	36	0	21.76	21.93	21.47
15	16QAM	36	18	21.87	21.99	21.50
15	16QAM	36	37	21.87	21.92	21.42
15	16QAM	75	0	20.90	20.99	20.80
BW [MHz]	Modulation	RB Size	RB Offset	Power Low Ch. / Freq.	Power Middle Ch. / Freq.	Power High Ch. / Freq.
Channel				18650	18900	19150
Frequency (MHz)				1855	1880	1905
10	QPSK	1	0	23.07	23.42	22.97
10	QPSK	1	24	23.13	23.30	22.88
10	QPSK	1	49	23.27	23.30	22.82
10	QPSK	25	0	22.94	22.93	22.60
10	QPSK	25	12	22.97	22.91	22.50
10	QPSK	25	24	22.91	22.92	22.42
10	QPSK	50	0	22.89	22.97	22.52
10	16QAM	1	0	22.36	22.66	22.22
10	16QAM	1	24	22.41	22.55	22.15
10	16QAM	1	49	22.57	22.57	22.16
10	16QAM	25	0	21.92	21.98	21.49
10	16QAM	25	12	21.95	21.97	21.48
10	16QAM	25	24	21.94	21.99	21.52
10	16QAM	50	0	21.96	21.94	21.50

BW [MHz]	Modulation	RB Size	RB Offset	Power Low Ch. / Freq.	Power Middle Ch. / Freq.	Power High Ch. / Freq.
Channel				18625	18900	19175
Frequency (MHz)				1852.5	1880	1907.5
5	QPSK	1	0	23.05	23.38	22.91
5	QPSK	1	12	22.95	23.29	22.86
5	QPSK	1	24	22.91	23.34	22.90
5	QPSK	12	0	22.31	22.69	22.41
5	QPSK	12	6	22.60	22.91	22.42
5	QPSK	12	11	22.55	22.92	22.43
5	QPSK	25	0	21.91	22.03	21.58
5	16QAM	1	0	22.32	22.60	22.12
5	16QAM	1	12	22.41	22.57	22.16
5	16QAM	1	24	22.43	22.59	22.21
5	16QAM	12	0	21.63	21.87	21.44
5	16QAM	12	6	21.70	21.90	21.46
5	16QAM	12	11	21.72	21.92	21.42
5	16QAM	25	0	20.65	20.83	20.42
BW [MHz]	Modulation	RB Size	RB Offset	Power Low Ch. / Freq.	Power Middle Ch. / Freq.	Power High Ch. / Freq.
Channel				18615	18900	19185
Frequency (MHz)				1851.5	1880	1908.5
3	QPSK	1	0	23.03	23.32	22.84
3	QPSK	1	7	22.81	23.31	22.88
3	QPSK	1	14	22.86	23.31	22.87
3	QPSK	8	0	22.68	22.96	22.55
3	QPSK	8	4	22.58	22.91	22.50
3	QPSK	8	7	22.63	22.88	22.51
3	QPSK	15	0	22.36	22.56	22.11
3	16QAM	1	0	22.27	22.59	22.11
3	16QAM	1	7	22.37	22.57	22.10
3	16QAM	1	14	22.41	22.54	22.09
3	16QAM	8	0	21.57	21.92	21.45
3	16QAM	8	4	21.64	21.87	21.53
3	16QAM	8	7	21.67	21.86	21.54
3	16QAM	15	0	21.31	21.54	21.05
BW [MHz]	Modulation	RB Size	RB Offset	Power Low Ch. / Freq.	Power Middle Ch. / Freq.	Power High Ch. / Freq.
Channel				18607	18900	19193
Frequency (MHz)				1850.7	1880	1909.3
1.4	QPSK	1	0	23.05	23.32	22.85
1.4	QPSK	1	2	23.13	23.24	22.88
1.4	QPSK	1	5	23.07	23.26	22.82
1.4	QPSK	3	0	22.91	22.95	22.53
1.4	QPSK	3	1	22.85	22.89	22.45
1.4	QPSK	3	2	22.76	22.85	22.42
1.4	QPSK	6	0	22.68	22.73	22.30
1.4	16QAM	1	0	22.22	22.57	22.07
1.4	16QAM	1	2	22.35	22.48	22.08
1.4	16QAM	1	5	22.27	22.49	22.02
1.4	16QAM	3	0	21.99	21.99	21.54
1.4	16QAM	3	1	21.88	21.93	21.46
1.4	16QAM	3	2	21.85	21.84	21.44
1.4	16QAM	6	0	21.73	21.74	21.28

<LTE Band 7>

BW [MHz]	Modulation	RB Size	RB Offset	Power Low Ch. / Freq.	Power Middle Ch. / Freq.	Power High Ch. / Freq.
Channel				20850	21100	21350
Frequency (MHz)				2510	2535	2560
20	QPSK	1	0	23.22	23.62	23.46
20	QPSK	1	49	23.08	23.52	23.45
20	QPSK	1	99	22.95	23.24	23.31
20	QPSK	50	0	22.20	22.65	22.35
20	QPSK	50	24	22.45	22.52	22.31
20	QPSK	50	49	22.48	22.47	22.29
20	QPSK	100	0	22.42	22.56	22.17
20	16QAM	1	0	21.98	22.33	22.41
20	16QAM	1	49	22.25	22.38	22.00
20	16QAM	1	99	22.16	22.14	21.97
20	16QAM	50	0	21.32	21.78	21.39
20	16QAM	50	24	21.42	21.55	21.33
20	16QAM	50	49	21.53	21.48	21.33
20	16QAM	100	0	21.42	21.62	21.20
BW [MHz]	Modulation	RB Size	RB Offset	Power Low Ch. / Freq.	Power Middle Ch. / Freq.	Power High Ch. / Freq.
Channel				20825	21100	21375
Frequency (MHz)				2507.5	2535	2562.5
15	QPSK	1	0	23.12	23.61	23.12
15	QPSK	1	37	23.38	23.37	23.11
15	QPSK	1	74	23.59	23.17	23.20
15	QPSK	36	0	22.28	22.53	22.11
15	QPSK	36	18	22.30	22.49	22.14
15	QPSK	36	37	22.38	22.37	22.28
15	QPSK	75	0	22.30	22.47	22.16
15	16QAM	1	0	22.41	22.34	21.98
15	16QAM	1	37	22.19	22.29	21.97
15	16QAM	1	74	22.01	22.14	22.10
15	16QAM	36	0	21.30	21.67	21.24
15	16QAM	36	18	21.33	21.55	21.16
15	16QAM	36	37	21.47	21.39	21.23
15	16QAM	75	0	21.46	21.58	21.22
BW [MHz]	Modulation	RB Size	RB Offset	Power Low Ch. / Freq.	Power Middle Ch. / Freq.	Power High Ch. / Freq.
Channel				20800	21100	21400
Frequency (MHz)				2505	2535	2565
10	QPSK	1	0	23.14	23.59	23.21
10	QPSK	1	24	23.11	23.40	23.28
10	QPSK	1	49	22.98	23.21	23.33
10	QPSK	25	0	22.40	22.43	22.09
10	QPSK	25	12	22.01	22.43	22.28
10	QPSK	25	24	21.98	22.24	22.30
10	QPSK	50	0	21.91	22.40	22.20
10	16QAM	1	0	21.93	22.37	22.04
10	16QAM	1	24	22.21	22.21	22.12
10	16QAM	1	49	22.20	22.22	22.11
10	16QAM	25	0	21.39	21.51	21.16
10	16QAM	25	12	21.46	21.50	21.29
10	16QAM	25	24	21.39	21.34	21.28
10	16QAM	50	0	21.29	21.41	21.20

BW [MHz]	Modulation	RB Size	RB Offset	Power Low Ch. / Freq.	Power Middle Ch. / Freq.	Power High Ch. / Freq.
Channel				20775	21100	21425
Frequency (MHz)				2502.5	2535	2567.5
5	QPSK	1	0	23.11	23.36	23.30
5	QPSK	1	12	23.01	23.17	23.31
5	QPSK	1	24	22.98	23.17	23.30
5	QPSK	12	0	22.51	22.35	22.27
5	QPSK	12	6	22.12	22.30	22.29
5	QPSK	12	11	22.12	22.27	22.26
5	QPSK	25	0	22.04	22.30	22.28
5	16QAM	1	0	22.21	22.16	22.12
5	16QAM	1	12	22.02	22.10	22.13
5	16QAM	1	24	21.93	22.09	22.12
5	16QAM	12	0	21.02	21.39	21.24
5	16QAM	12	6	21.11	21.32	21.26
5	16QAM	12	11	21.18	21.31	21.26
5	16QAM	25	0	21.13	21.41	21.32

10. Low-power Exemption

According to ANSI C63.19 2011-version, an RF air interface technology of a device is exempt from testing when its average antenna input power plus its MIF is ≤ 17 dBm for any of its operating modes.

For LTE air interface, the low power exemption of QPSK and 16QAM modulation was determined by the highest antenna input power and the worst MIF values among all RB configurations.

Band	BW (MHz)	RB Size	Modulation	Average Antenna Input Power (dBm)	MIF (dB)	Conducted Power + MIF (dBm)	C63.19 test required
GSM850				32.96	3.63	36.59	Yes
GSM1900				29.96	3.63	33.59	Yes
WCDMA V				23.48	-27.23	-3.75	No
WCDMA IV				23.40	-27.23	-3.83	No
WCDMA II				23.45	-27.23	-3.78	No
LTE Band 17	10	1RB	QPSK	22.92	-15.63	7.29	No
LTE Band 17	10	1RB	16QAM	21.87	-9.76	12.11	No
LTE Band 17	5	1RB	QPSK	22.76	-15.63	7.13	No
LTE Band 17	5	1RB	16QAM	21.75	-9.76	11.99	No
LTE Band 5	10	1RB	QPSK	22.94	-15.63	7.31	No
LTE Band 5	10	1RB	16QAM	21.84	-9.76	12.08	No
LTE Band 5	5	1RB	QPSK	22.88	-15.63	7.25	No
LTE Band 5	5	1RB	16QAM	21.81	-9.76	12.05	No
LTE Band 5	3	1RB	QPSK	22.74	-15.62	7.12	No
LTE Band 5	3	1RB	16QAM	21.63	-9.76	11.87	No
LTE Band 5	1.4	1RB	QPSK	22.77	-15.62	7.15	No
LTE Band 5	1.4	1RB	16QAM	21.72	-9.76	11.96	No
LTE Band 7	20	1RB	QPSK	23.46	-15.63	7.83	No
LTE Band 7	20	1RB	16QAM	22.41	-9.76	12.65	No
LTE Band 7	15	1RB	QPSK	23.20	-15.63	7.57	No
LTE Band 7	15	1RB	16QAM	22.10	-9.76	12.34	No
LTE Band 7	10	1RB	QPSK	23.33	-15.63	7.70	No
LTE Band 7	10	1RB	16QAM	22.12	-9.76	12.36	No
LTE Band 7	5	1RB	QPSK	23.31	-15.63	7.68	No
LTE Band 7	5	1RB	16QAM	22.13	-9.76	12.37	No

Band	BW	RB Size	Mode	Maximum Average Conducted Power (dBm)	MIF (dB)	Power + MIF(dB)	C63.19 test required
LTE Band 2	20	1RB	QPSK	23.09	-15.63	7.46	No
LTE Band 2	20	1RB	16QAM	22.22	-9.76	12.46	No
LTE Band 2	15	1RB	QPSK	23.08	-15.63	7.45	No
LTE Band 2	15	1RB	16QAM	22.42	-9.76	12.66	No
LTE Band 2	10	1RB	QPSK	22.97	-15.63	7.34	No
LTE Band 2	10	1RB	16QAM	22.22	-9.76	12.46	No
LTE Band 2	5	1RB	QPSK	22.91	-15.63	7.28	No
LTE Band 2	5	1RB	16QAM	22.21	-9.76	12.45	No
LTE Band 2	3	1RB	QPSK	22.88	-15.62	7.26	No
LTE Band 2	3	1RB	16QAM	22.11	-9.76	12.35	No
LTE Band 2	1.4	1RB	QPSK	22.88	-15.62	7.26	No
LTE Band 2	1.4	1RB	16QAM	22.08	-9.76	12.32	No
LTE Band 4	20	1RB	QPSK	23.74	-15.63	8.11	No
LTE Band 4	20	1RB	16QAM	22.71	-9.76	12.95	No
LTE Band 4	15	1RB	QPSK	23.69	-15.63	8.06	No
LTE Band 4	15	1RB	16QAM	22.63	-9.76	12.87	No
LTE Band 4	10	1RB	QPSK	23.50	-15.63	7.87	No
LTE Band 4	10	1RB	16QAM	22.50	-9.76	12.74	No
LTE Band 4	5	1RB	QPSK	23.53	-15.63	7.90	No
LTE Band 4	5	1RB	16QAM	22.51	-9.76	12.75	No
LTE Band 4	3	1RB	QPSK	23.59	-15.62	7.97	No
LTE Band 4	3	1RB	16QAM	22.53	-9.76	12.77	No
LTE Band 4	1.4	1RB	QPSK	23.58	-15.62	7.96	No
LTE Band 4	1.4	1RB	16QAM	22.56	-9.76	12.80	No

Conclusion: Low power exemption is applicable to WCDMA and LTE, and HAC rating is M4 for both air interfaces.

11. HAC RF Emission Test Results

11.1 E-Field Emission

Emission Categories	E-field emissions	
	<960Mhz	>960Mhz
M1	50 to 55 dB (V/m)	40 to 45 dB (V/m)
M2	45 to 50 dB (V/m)	35 to 40 dB (V/m)
M3	40 to 45 dB (V/m)	30 to 35 dB (V/m)
M4	<40 dB (V/m)	<30 dB (V/m)

Plot No.	Band	Mode	Channel	MIF(dB)	RF audio Interference level (dBV/m)	Margin to FCC M3 limit (dB)	HAC Rating
1	GSM850	GSM Voice	128	3.63	34.98	10.02	M4
2	GSM850	GSM Voice	189	3.63	35.77	9.23	M4
3	GSM850	GSM Voice	251	3.63	36.43	8.57	M4
7	GSM1900	GSM Voice	512	3.63	25.88	9.12	M4
8	GSM1900	GSM Voice	661	3.63	27.48	7.52	M4
9	GSM1900	GSM Voice	810	3.63	26.29	8.71	M4

Remark:

1. The HAC measurement system applies MIF value onto the measured RMS E-field, which is indirect method in ANSI C63.19 2011 version, and reports the RF audio interference level.
2. The uncertainty is 0.2dB of MIF ranges from -7dB to +5dB. GSM850 band HAC rating M4, GSM1900 band HAC rating M4 would not be affected considering the MIF uncertainty.
3. There is no special HAC mode software on this EUT.

Test Engineer : Aaron Chen.

12. Uncertainty Assessment

The component of uncertainty may generally be categorized according to the methods used to evaluate them. The evaluation of uncertainty by the statistical analysis of a series of observations is termed a Type A evaluation of uncertainty. The evaluation of uncertainty by means other than the statistical analysis of a series of observation is termed a Type B evaluation of uncertainty. Each component of uncertainty, however evaluated, is represented by an estimated standard deviation, termed standard uncertainty, which is determined by the positive square root of the estimated variance.

The combined standard uncertainty of the measurement result represents the estimated standard deviation of the result. It is obtained by combining the individual standard uncertainties of both Type A and Type B evaluation using the usual “root-sum-squares” (RSS) methods of combining standard deviations by taking the positive square root of the estimated variances. Expanded uncertainty is a measure of uncertainty that defines an interval about the measurement result within which the measured value is confidently believed to lie. It is obtained by multiplying the combined standard uncertainty by a coverage factor. For purpose of this document, a coverage factor two is used, which corresponds to confidence interval of about 95 %. The DASY uncertainty Budget is showed in Table 12.1.

Error Description	Uncertainty Value (±%)	Probability Distribution	Divisor	Ci (E)	Standard Uncertainty (E)
Measurement System					
Probe Calibration	5.1	Normal	1	1	± 5.1 %
Axial Isotropy	4.7	Rectangular	$\sqrt{3}$	1	± 2.7 %
Sensor Displacement	16.5	Rectangular	$\sqrt{3}$	1	± 9.5 %
Boundary Effects	2.4	Rectangular	$\sqrt{3}$	1	± 1.4 %
Phantom Boundary Effects	7.2	Rectangular	$\sqrt{3}$	1	± 4.1 %
Linearity	4.7	Rectangular	$\sqrt{3}$	1	± 2.7 %
Scaling with PMF Calibration	10.0	Rectangular	$\sqrt{3}$	1	± 5.77 %
System Detection Limit	1.0	Rectangular	$\sqrt{3}$	1	± 0.6 %
Readout Electronics	0.3	Normal	1	1	± 0.3 %
Response Time	0.8	Rectangular	$\sqrt{3}$	1	± 0.5 %
Integration Time	2.6	Rectangular	$\sqrt{3}$	1	± 1.5 %
RF Ambient Conditions	3.0	Rectangular	$\sqrt{3}$	1	± 1.7 %
RF Reflections	12.0	Rectangular	$\sqrt{3}$	1	± 6.9 %
Probe Positioner	1.2	Rectangular	$\sqrt{3}$	1	± 0.7 %
Probe Positioning	4.7	Rectangular	$\sqrt{3}$	1	± 2.7 %
Extrap. and Interpolation	1.0	Rectangular	$\sqrt{3}$	1	± 0.6 %
Test Sample Related					
Device Positioning Vertical	4.7	Rectangular	$\sqrt{3}$	1	± 2.7 %
Device Positioning Lateral	1.0	Rectangular	$\sqrt{3}$	1	± 0.6 %
Device Holder and Phantom	2.4	Rectangular	$\sqrt{3}$	1	± 1.4 %
Power Drift	5.0	Rectangular	$\sqrt{3}$	1	± 2.9 %
Phantom and Setup Related					
Phantom Thickness	2.4	Rectangular	$\sqrt{3}$	1	± 1.4 %
Combined Standard Uncertainty					± 16.30 %
Coverage Factor for 95 %					K = 2
Expanded Std. Uncertainty on Power					± 32.6 %
Expanded Std. Uncertainty on Field					± 16.3 %

Table 12.1 Uncertainty Budget of HAC free field assessment

Remark:

Worst-Case uncertainty budget for HAC free field assessment according to ANSIC63.19 [1], [2]. The budget is valid for the frequency range 700 MHz - 3 GHz and represents a worst case analysis.

13. References

- [1] ANSI C63.19-2011, "American National Standard for Methods of Measurement of Compatibility between Wireless Communications Devices and Hearing Aids", 27 May 2011
- [2] SPEAG DASY System Handbook