



# FCC PART 15.247

## TEST REPORT

For

### BYD Precision Manufacture Co., Ltd

Baohe Road, Baolong Industrial, Longgang, Shenzhen, 518116, P.R.China

**FCC ID: ZW9-T11B13**

<b>Report Type:</b> Original Report	<b>Product Type:</b> Tablet PC
<b>Test Engineer:</b> Allen Qiao	<i>Allen Qiao</i>
<b>Report Number:</b> R2DG140115001-00B	
<b>Report Date:</b> 2014-02-18	
<b>Reviewed By:</b> Ivan Cao RF Leader	<i>Ivan Cao</i>
<b>Test Laboratory:</b> Bay Area Compliance Laboratories Corp. (Dongguan) No.69 Pulongcun, Puxinhu Industrial Zone, Tangxia, Dongguan, Guangdong, China Tel: +86-769-86858888 Fax: +86-769-86858891 <a href="http://www.baclcorp.com.cn">www.baclcorp.com.cn</a>	

Note: This test report is prepared for the customer shown above and for the device described herein. It may not be duplicated or used in part without prior written consent from Bay Area Compliance Laboratories Corp. This report must not be used by the customer to claim product certification, approval, or endorsement by NVLAP\*, or any agency of the Federal Government.

\* This report may contain data that are not covered by the NVLAP accreditation and shall be marked with an asterisk "★" (Rev.2), This report is valid only with a valid digital signature. The digital signature may be available only under the Adobe software above version 7.0.

## TABLE OF CONTENTS

<b>GENERAL INFORMATION.....</b>	<b>4</b>
PRODUCT DESCRIPTION FOR EQUIPMENT UNDER TEST (EUT).....	4
OBJECTIVE.....	4
RELATED SUBMITTAL(S)/GRANT(S).....	4
TEST METHODOLOGY.....	4
TEST FACILITY.....	5
<b>SYSTEM TEST CONFIGURATION.....</b>	<b>6</b>
DESCRIPTION OF TEST CONFIGURATION.....	6
EUT EXERCISE SOFTWARE.....	6
EQUIPMENT MODIFICATIONS.....	6
SUPPORT EQUIPMENT LIST AND DETAILS.....	6
EXTERNAL I/O CABLE.....	6
BLOCK DIAGRAM OF TEST SETUP.....	7
<b>SUMMARY OF TEST RESULTS.....</b>	<b>8</b>
<b>FCC §15.247 (i) &amp; §1.1310 &amp; §2.1093- RF EXPOSURE.....</b>	<b>9</b>
APPLICABLE STANDARD.....	9
<b>FCC §15.203 - ANTENNA REQUIREMENT.....</b>	<b>10</b>
APPLICABLE STANDARD.....	10
ANTENNA CONNECTOR CONSTRUCTION.....	10
<b>FCC §15.207 (a) – AC LINE CONDUCTED EMISSIONS.....</b>	<b>11</b>
APPLICABLE STANDARD.....	11
MEASUREMENT UNCERTAINTY.....	11
EUT SETUP.....	11
EMI TEST RECEIVER SETUP.....	12
TEST PROCEDURE.....	12
TEST EQUIPMENT LIST AND DETAILS.....	12
CORRECTED AMPLITUDE & MARGIN CALCULATION.....	12
TEST RESULTS SUMMARY.....	13
TEST RESULTS SUMMARY.....	13
TEST DATA.....	13
<b>FCC §15.209, §15.205 &amp; §15.247(d) - SPURIOUS EMISSIONS.....</b>	<b>16</b>
APPLICABLE STANDARD.....	16
MEASUREMENT UNCERTAINTY.....	16
EUT SETUP.....	16
EMI TEST RECEIVER & SPECTRUM ANALYZER SETUP.....	17
TEST PROCEDURE.....	17
CORRECTED AMPLITUDE & MARGIN CALCULATION.....	18
TEST EQUIPMENT LIST AND DETAILS.....	18
TEST RESULTS SUMMARY.....	18
TEST DATA.....	19
<b>FCC §15.247(a) (2) – 6 dB EMISSION BANDWIDTH.....</b>	<b>23</b>
APPLICABLE STANDARD.....	23
TEST PROCEDURE.....	23
TEST EQUIPMENT LIST AND DETAILS.....	23
TEST DATA.....	23

**FCC §15.247(b) (3) - MAXIMUM PEAK OUTPUT POWER .....26**  
    APPLICABLE STANDARD .....26  
    TEST PROCEDURE .....26  
    TEST EQUIPMENT LIST AND DETAILS.....26  
    TEST DATA .....26

**FCC §15.247(d) – 100 kHz BANDWIDTH OF FREQUENCY BAND EDGE.....29**  
    APPLICABLE STANDARD .....29  
    TEST PROCEDURE .....29  
    TEST EQUIPMENT LIST AND DETAILS.....29  
    TEST DATA .....29

**FCC §15.247(e) - POWER SPECTRAL DENSITY .....31**  
    APPLICABLE STANDARD .....31  
    TEST PROCEDURE .....31  
    TEST EQUIPMENT LIST AND DETAILS.....31  
    TEST DATA .....31

## GENERAL INFORMATION

---

### Product Description for Equipment under Test (EUT)

The *BYD Precision Manufacture Co., Ltd*'s product, model number: *T11B (FCC ID: ZW9-T11B13)* (the "EUT") in this report was a *Tablet PC*, the tablet was measured approximately: 30.5 cm (L) x 19.5 cm (W) x 1.1 cm (H), rated input voltage: DC 19.0V from adapter or DC 11.1V from Li-ion Polymer Battery.

#### Accessory Information:

##### Keyboard:

Model: DOK-K8275U

Approximately: 30.0 cm (L) x 21.5 cm (W) x 0.6 cm (H)

Power rating: 5V, 7mA

Manufacturer: Shenzhen Doking Electronic Technology Co., Ltd.

##### Adapter:

Model: ADS-40SG-19-3 19030G

Input: AC 100-240V, 50/60Hz, 1.0A

Output: DC 19V, 1.58A

Manufacturer: SHENZHEN HONOR ELECTRONIC CO., LTD.

*\* All measurement and test data in this report was gathered from production sample serial number: 140115001 (Assigned by BACL.Dongguan). The EUT was received on 2014-01-16*

### Objective

This report is prepared on behalf of *BYD Precision Manufacture Co., Ltd* in accordance with Part 2-Subpart J, Part 15-Subparts A, B and C of the Federal Communications Commission's rules.

The tests were performed in order to determine the compliance of the EUT with FCC Part 15-Subpart C, section 15.203, 15.205, 15.207, 15.209 and 15.247 rules.

### Related Submittal(s)/Grant(s)

FCC Part15C DSS submissions with FCC ID: *ZW9-T11B13 for Bluetooth BDR, EDR mode.*

FCC Part15C DTS submissions with FCC ID: *ZW9-T11B13 for wifi.*

### Test Methodology

All measurements contained in this report were conducted with ANSI C63.4-2003, American National Standard for Methods of Measurement of Radio-Noise Emissions from Low-Voltage Electrical and Electronic Equipment in the range of 9 kHz to 40 GHz.

All emissions measurement was performed and Bay Area Compliance Laboratories Corp. (Dongguan). The radiated testing was performed at an antenna-to-EUT distance of 3 meters.

## Test Facility

The Test site used by Bay Area Compliance Laboratories Corp. (Dongguan) to collect test data is located on the No.69 Pulongcun, Puxinhu Industrial Zone, Tangxia, Dongguan, Guangdong, China

Test site at Bay Area Compliance Laboratories Corp. (Dongguan) has been fully described in reports submitted to the Federal Communications Commission (FCC). The details of these reports have been found to be in compliance with the requirements of Section 2.948 of the FCC Rules on February 02, 2012. The facility also complies with the radiated and AC line conducted test site criteria set forth in ANSI C63.4-2003.

The Federal Communications Commission has the reports on file and is listed under FCC Registration No.: 273710. The test site has been approved by the FCC for public use and is listed in the FCC Public Access Link (PAL) database.

Additionally, Bay Area Compliance Laboratories Corp. (Dongguan) is an ISO/IEC 17025 accredited laboratory, and is accredited by National Voluntary Laboratory Accredited Program (Lab Code 500069-0).



The current scope of accreditations can be found at <http://ts.nist.gov/standards/scopes/5000690.htm>

## SYSTEM TEST CONFIGURATION

### Description of Test Configuration

The system was configured for testing in an engineering mode, which was provided by manufacturer. The engineering mode was configured the system transmitting with maximum power.

For Bluetooth LE mode, 40 channels are provided for testing:

Channel	Frequency (MHz)	Channel	Frequency (MHz)
0	2402	20	2442
1	2404	...	...
...	...	...	...
...	...	...	...
..	...	38	2478
19	2440	39	2480

EUT was tested with channel 0, 19 and 39.

### EUT Exercise Software

The software “BtUSB\_Vi\_0\_B18.5” was used.

### Equipment Modifications

No modification was made to the EUT.

### Support Equipment List and Details

Manufacturer	Description	Model	Serial Number
SAMSUNG	Monitor	S22C330H	ZXDCHTHD10149K
TOSHIBA	Hard Disk	V63700-A	7283T8CUTSJ2
SAMSUNG	TF Card	N/A	N/A
APPLE	Earphone	N/A	N/A

### External I/O Cable

Cable Description	Shielding Type	Ferrite Core	Length (m)	From Port	To
HDMI Cable	Yes	No	1.0	HDMI Port of Monitor	EUT
USB Cable	Yes	No	0.6	USB Port of Hard Disk	EUT
Adapter Power Cable	Yes	No	2.7	Adapter	EUT
Earphone Cable	No	No	1.2	EUT	Earphone

### Block Diagram of Test Setup

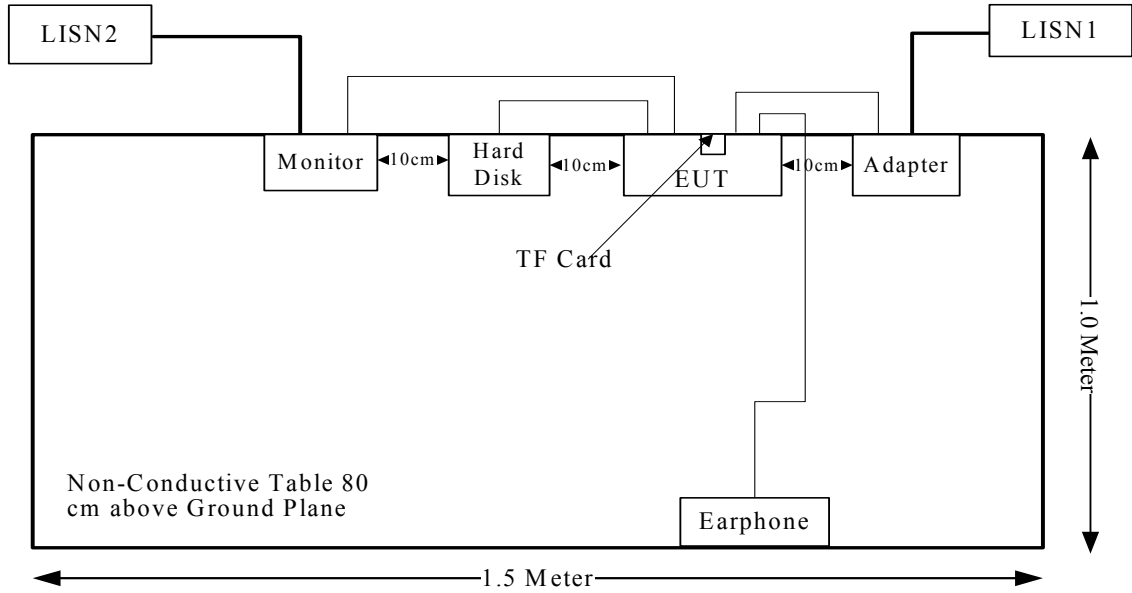

**SUMMARY OF TEST RESULTS**

<b>FCC Rules</b>	<b>Description of Test</b>	<b>Result</b>
FCC §15.247 (i) & §1.1310 & §2.1093	RF EXPOSURE	Compliance
§15.203	Antenna Requirement	Compliance
§15.207 (a)	AC Line Conducted Emissions	Compliance
§15.247(d)	Spurious Emissions at Antenna Port	Compliance
§15.205, §15.209, §15.247(d)	Spurious Emissions	Compliance
§15.247 (a)(2)	6 dB Emission Bandwidth	Compliance
§15.247(b)(3)	Maximum Peak Output Power	Compliance
§15.247(d)	100 kHz Bandwidth of Frequency Band Edge	Compliance
§15.247(e)	Power Spectral Density	Compliance



---

## **FCC §15.247 (i) & §1.1310 & §2.1093- RF EXPOSURE**

---

### **Applicable Standard**

According to §15.247(i) and §1.1310, systems operating under the provisions of this section shall be operated in a manner that ensure that the public is not exposed to radio frequency energy level in excess of the Commission's guideline.

According to KDB447498 D01 General RF Exposure Guidance v05r02 Appendix A, SAR can be exempted if the output power is less than the SAR exclusion threshold:

For  $f=2450\text{MHz}$ , the output power is less 10mW at distance of 5mm.

### **Measurement Result**

Peak conducted output power= 1.49 dBm  
SAR exclusion threshold 10 mW (10dBm) > 1.49 dBm

**So the stand-alone SAR evaluation is not necessary.  
The simultaneous transmission SAR please refer to the SAR report: R1DG140115001-20.**

---

## **FCC §15.203 - ANTENNA REQUIREMENT**

---

### **Applicable Standard**

According to § 15.203, an intentional radiator shall be designed to ensure that no antenna other than that furnished by the responsible party shall be used with the device. The use of a permanently attached antenna or of an antenna that uses a unique coupling to the intentional radiator shall be considered sufficient to comply with the provisions of this section. The manufacturer may design the unit so that a broken antenna can be replaced by the user, but the user of a standard antenna jack or electrical connector is prohibited. The structure and application of the EUT were analyzed to determine compliance with section §15.203 of the rules. §15.203 state that the subject device must meet the following criteria:

- a. Antenna must be permanently attached to the unit.
  - b. Antenna must use a unique type of connector to attach to the EUT.
- Unit must be professionally installed, and installer shall be responsible for verifying that the correct antenna is employed with the unit.

### **Antenna Connector Construction**

The EUT has an internal antenna for Bluetooth, which the maximum gain is -2.78dBi, please refer to the internal photos.

**Result:** Compliance.

**FCC §15.207 (a) – AC LINE CONDUCTED EMISSIONS**

**Applicable Standard**

FCC§15.207

**Measurement Uncertainty**

Compliance or non-compliance with a disturbance limit shall be determined in the following manner:

If  $U_{lab}$  is less than or equal to  $U_{cispr}$  of Table 1, then:

- compliance is deemed to occur if no measured disturbance level exceeds the disturbance limit;
- non-compliance is deemed to occur if any measured disturbance level exceeds the disturbance limit.

If  $U_{lab}$  is greater than  $U_{cispr}$  of Table 1, then:

- compliance is deemed to occur if no measured disturbance level, increased by  $(U_{lab} - U_{cispr})$ , exceeds the disturbance limit;
- non-compliance is deemed to occur if any measured disturbance level, increased by  $(U_{lab} - U_{cispr})$ , exceeds the disturbance limit.

Based on CISPR 16-4-2: 2011, measurement uncertainty of conducted disturbance at mains port using AMN at Bay Area Compliance Laboratories Corp. (Dongguan) is 3.46 dB (150 kHz to 30 MHz).

Table 1 – Values of  $U_{cispr}$

Measurement	$U_{cispr}$
Conducted disturbance at mains port using AMN (150 kHz to 30 MHz)	3.4 dB

**EUT Setup**

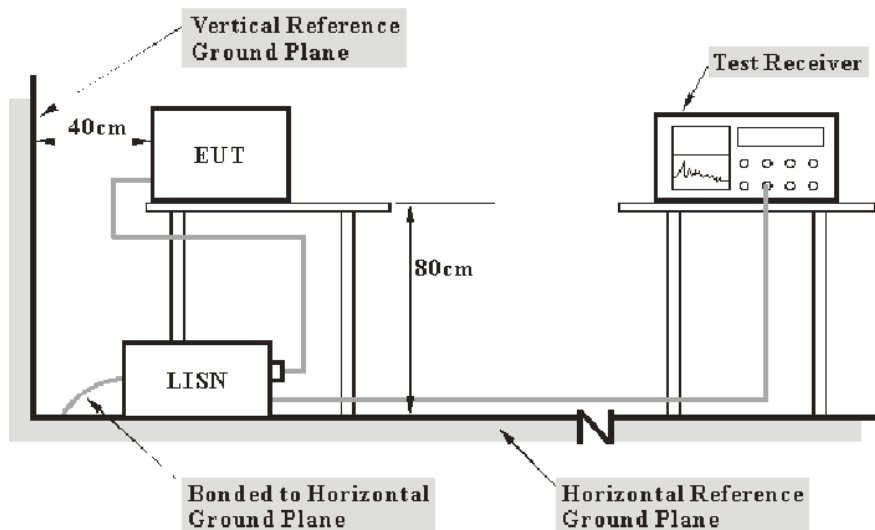

Note: 1. Support units were connected to second LISN.  
 2. Both of LISNs (AMN) 80 cm from EUT and at the least 80 cm from other units and other metal planes support units.

The setup of EUT is according with per ANSI C63.4-2003 measurement procedure. The specification used was with the FCC Part 15.207 limits.

The spacing between the peripherals was 10 cm.

The adapter was connected to a 120 VAC/60 Hz power source

### EMI Test Receiver Setup

The EMI test receiver was set to investigate the spectrum from 150 kHz to 30 MHz.

During the conducted emission test, the EMI test receiver was set with the following configurations:

Frequency Range	IF B/W
150 kHz – 30 MHz	9 kHz

### Test Procedure

During the conducted emission test, the adapter was connected to the outlet of the first LISN and the other support equipments were connected to the outlet of the second LISN.

Maximizing procedure was performed on the six (6) highest emissions of the EUT.

All data was recorded in the Quasi-peak and average detection mode.

### Test Equipment List and Details

Manufacturer	Description	Model	Serial Number	Calibration Date	Calibration Due Date
R&S	EMI TEST RECEIVER	ESCS 30	830245/006	2013-11-20	2014-11-19
R&S	Two-line V-network	ENV216	3560.6550.12	2014-1-22	2015-1-21
R&S	L.I.S.N	ESH3-Z5	100113	N/A	N/A
BACL	Test Software	BACL-EMC	V1.0-2010	N/A	N/A

\* **Statement of Traceability:** Bay Area Compliance Laboratories Corp. (Dongguan) attests that all calibrations have been performed in accordance to NVLAP requirements, traceable to National Primary Standards and International System of Units (SI).

### Corrected Amplitude & Margin Calculation

The basic equation is as follows:

$$V_C = V_R + A_C + VDF$$

$$C_f = A_C + VDF$$

Herein,

$V_C$  (cord. Reading): corrected voltage amplitude

$V_R$ : reading voltage amplitude  
 $A_C$ : attenuation caused by cable loss  
VDF: voltage division factor of AMN  
 $C_f$ : Correction Factor

The “**Margin**” column of the following data tables indicates the degree of compliance within the applicable limit. For example, a margin of 7dB means the emission is 7dB below the maximum limit. The equation for margin calculation is as follows:

$$\text{Margin} = \text{Limit} - \text{Corrected Amplitude}$$

### Test Results Summary

According to the recorded data in following table, the EUT complied with the FCC Part 15.207, with the worst margin reading of:

### Test Results Summary

According to the recorded data in following table, the EUT complied with the FCC Part 15.207, with the worst margin reading of:

**7.81 dB at 0.780 MHz** in the **Line** conducted mode.

### Test Data

#### Environmental Conditions

<b>Temperature:</b>	19.9 °C
<b>Relative Humidity:</b>	37 %
<b>ATM Pressure:</b>	102 kPa

*The testing was performed by Allen Qiao on 2014-01-20.*

Test Mode: Transmitting

AC 120V/60 Hz, Line

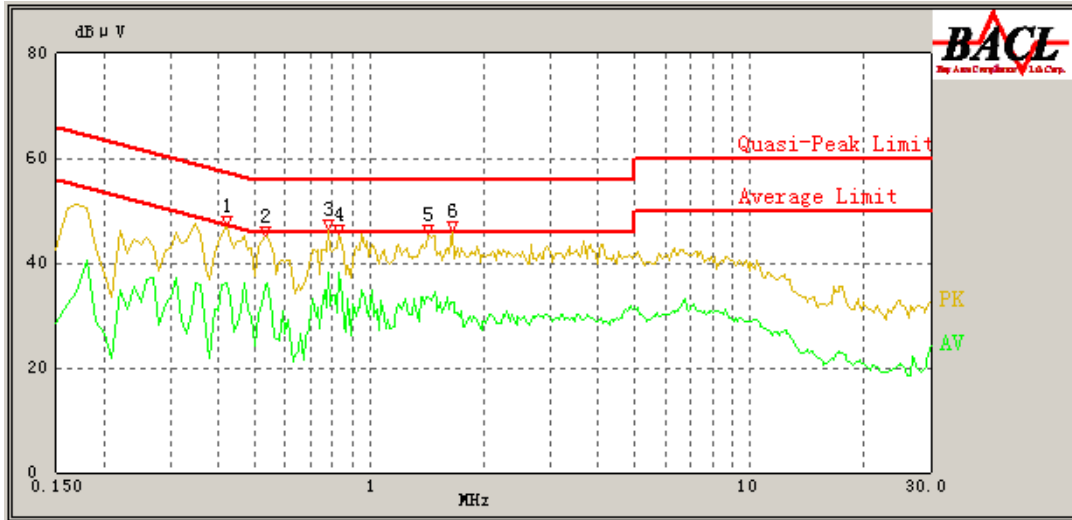

Frequency (MHz)	Corrected Amplitude (dBμV)	Correction Factor (dB)	Limit (dBμV)	Margin (dB)	Detector (PK/ QP/Ave.)
0.420	44.21	9.67	57.45	13.24	QP
0.420	36.22	9.67	47.45	11.23	AV
0.530	42.10	9.66	56.00	13.90	QP
0.530	35.55	9.66	46.00	10.45	AV
0.780	42.95	9.67	56.00	13.05	QP
0.780	38.19	9.67	46.00	7.81	AV
0.830	42.95	9.67	56.00	13.05	QP
0.830	38.09	9.67	46.00	7.91	AV
1.430	41.14	9.68	56.00	14.86	QP
1.430	33.50	9.68	46.00	12.50	AV
1.650	39.70	9.68	56.00	16.30	QP
1.670	32.59	9.68	46.00	13.41	AV

AC 120V/60 Hz, Neutral

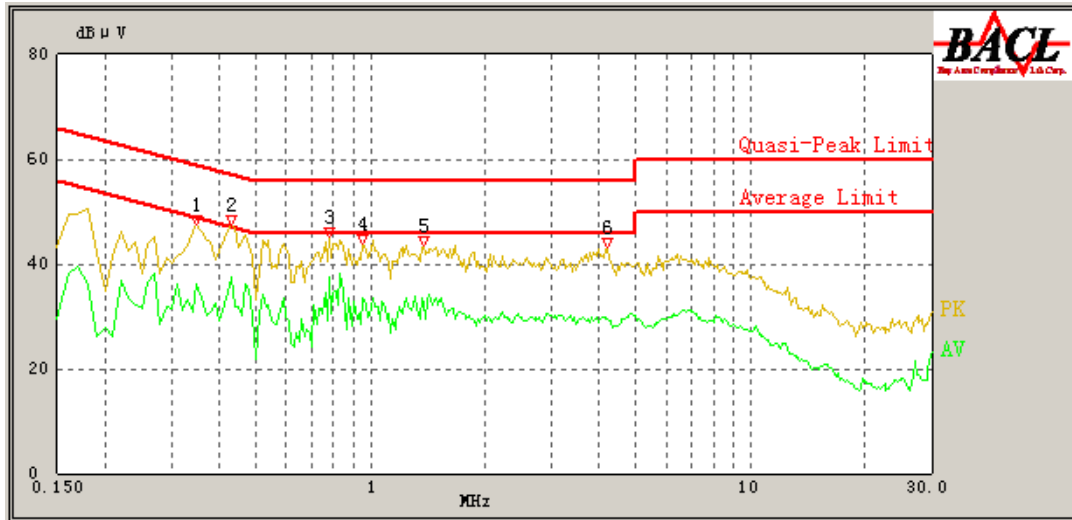

Frequency (MHz)	Corrected Amplitude (dBμV)	Correction Factor (dB)	Limit (dBμV)	Margin (dB)	Detector (PK/ QP/Ave.)
0.350	37.80	9.68	58.96	21.16	QP
0.350	36.02	9.68	48.96	12.94	AV
0.430	45.42	9.67	57.25	11.83	QP
0.430	37.53	9.67	47.25	9.72	AV
0.780	41.98	9.68	56.00	14.02	QP
0.780	37.39	9.68	46.00	8.61	AV
0.950	39.59	9.69	56.00	16.41	QP
0.950	33.40	9.69	46.00	12.60	AV
1.380	38.99	9.69	56.00	17.01	QP
1.380	32.67	9.69	46.00	13.33	AV
4.190	34.55	9.73	56.00	21.45	QP
4.170	29.74	9.73	46.00	16.26	AV

**FCC §15.209, §15.205 & §15.247(d) - SPURIOUS EMISSIONS**

**Applicable Standard**

FCC §15.247 (d); §15.209; §15.205;

**Measurement Uncertainty**

Compliance or non-compliance with a disturbance limit shall be determined in the following manner:

If  $U_{lab}$  is less than or equal to  $U_{cispr}$  of Table 2, then:

- compliance is deemed to occur if no measured disturbance level exceeds the disturbance limit;
- non-compliance is deemed to occur if any measured disturbance level exceeds the disturbance limit.

If  $U_{lab}$  is greater than  $U_{cispr}$  of Table 1, then:

- compliance is deemed to occur if no measured disturbance level, increased by  $(U_{lab} - U_{cispr})$ , exceeds the disturbance limit;
- non-compliance is deemed to occur if any measured disturbance level, increased by  $(U_{lab} - U_{cispr})$ , exceeds the disturbance limit.

Based on CISPR 16-4-2: 2011, measurement uncertainty of radiated emission at a distance of 3m at Bay Area Compliance Laboratories Corp. (Dongguan) is:

30M~200MHz: 5.0 dB

200M~1GHz: 6.2 dB

1G~6GHz: 4.45 dB

6G~18GHz: 5.23 dB

Table 2 – Values of  $U_{cispr}$

Measurement	$U_{cispr}$
Radiated disturbance (electric field strength at an OATS or in a SAC) (30 MHz to 1000 MHz)	6.3 dB
Radiated disturbance (electric field strength in a FAR) (1 GHz to 6 GHz)	5.2 dB
Radiated disturbance (electric field strength in a FAR) (6 GHz to 18 GHz)	5.5 dB

**EUT Setup**

**Below 1GHz:**

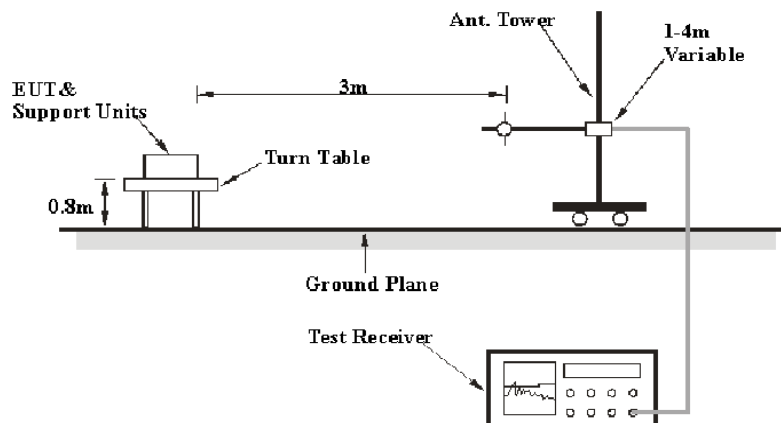



**Above 1GHz:**

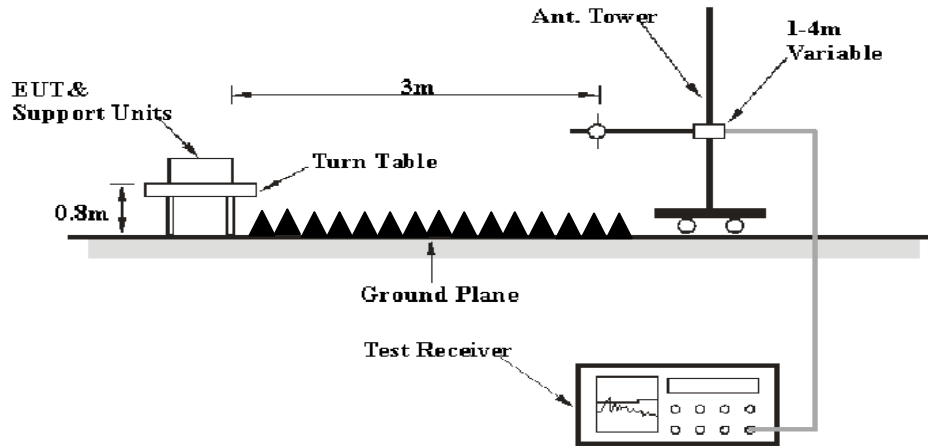

The radiated emission tests were performed in the 3 meters test site, using the setup accordance with the ANSI C63.4-2003. The specification used was the FCC 15.209, and FCC 15.247 limits.

The external I/O cables were draped along the test table and formed a bundle 30 to 40 cm long in the middle.

The spacing between the peripherals was 10 cm.

The adapter was connected to a 120 VAC/60 Hz power source.

**EMI Test Receiver & Spectrum Analyzer Setup**

The system was investigated from 30 MHz to 25 GHz.

During the radiated emission test, the EMI test receiver & Spectrum Analyzer Setup were set with the following configurations:

Frequency Range	RBW	Video B/W	IF B/W	Detector
30MHz – 1000 MHz	120 kHz	300 kHz	120kHz	QP
Above 1 GHz	1MHz	3 MHz	/	PK
	1MHz	10 Hz	/	Ave.

**Test Procedure**

During the radiated emissions, the adapter was connected to the AC floor outlet and the other support equipments were connected to the second AC floor outlet.##

Maximizing procedure was performed on the highest emissions to ensure that the EUT complied with all installation combinations.

Data was recorded in Quasi-peak detection mode for frequency range of 30 MHz-1 GHz, peak and Average detection modes for frequencies above 1 GHz.

## Corrected Amplitude & Margin Calculation

The Corrected Amplitude is calculated by adding the Antenna Factor and Cable Loss, and subtracting the Amplifier Gain from the Meter Reading. The basic equation is as follows:

$$\text{Corrected Amplitude} = \text{Meter Reading} + \text{Antenna Factor} + \text{Cable Loss} - \text{Amplifier Gain}$$

The “**Margin**” column of the following data tables indicates the degree of compliance with the applicable limit. For example, a margin of 7dB means the emission is 7dB below the limit. The equation for margin calculation is as follows:

$$\text{Margin} = \text{Limit} - \text{Corrected Amplitude}$$

## Test Equipment List and Details

Manufacturer	Description	Model	Serial Number	Calibration Date	Calibration Due Date
R&S	EMI TEST RECEIVER	ESCI	100224	2013-5-6	2014-5-5
Sunol Sciences	Antenna	JB3	A060611-1	2011-9-6	2014-9-5
HP	AMPLIFIER	8447E	2434A02181	2013-09-06	2014-09-05
R&S	Spectrum analyzer	FSEM	DE31388	2013-5-7	2014-5-6
ETS-Lindgren	horn antenna	3115	000 527 35	2012-9-6	2015-9-5
Mini-Circuit	Amplifier	ZVA-213-S+	054201245	2013-04-06	2014-04-05
R&S	Spectrum Analyzer	FSP 38	100478	2013-6-16	2014-6-15
Ducommun Technologies	horn antenna	ARH-4223-02	1007726-01 1304	2013-6-16	2014-6-15
Quinstar	Amplifier	QLW-18405536-JO	15964001001	2013-09-06	2014-09-05

\* **Statement of Traceability:** Bay Area Compliance Laboratories Corp. (Dongguan) attests that all calibrations have been performed in accordance to NVLAP requirements, traceable to National Primary Standards and International System of Units (SI).

## Test Results Summary

According to the recorded data in following table, the EUT complied with the FCC Title 47, Part 15, Section 15.205, 15.209 and 15.247, with the worst margin reading of:

**5.07 dB at 431.49 MHz in the Horizontal polarization**

**Test Data**

**Environmental Conditions**

<b>Temperature:</b>	20.6 °C
<b>Relative Humidity:</b>	40 %
<b>ATM Pressure:</b>	102.1 kPa

*\* The testing was performed by Allen Qiao on 2014-01-22.*

Mode: Transmitting

Frequency (MHz)	Receiver		Rx Antenna		Cable loss (dB)	Amplifier Gain (dB)	Corrected Amplitude (dBµV/m)	FCC 15.247	
	Reading (dBµV)	Detector (PK/QP/AV)	Polar (H/V)	Factor (dB)				Limit (dBµV/m)	Margin (dB)
Low Channel: 2402(MHz)									
2402	63.06	PK	H	25.65	4.42	0.00	93.13	N/A	N/A
2402	55.78	AV	H	25.65	4.42	0.00	85.85	N/A	N/A
2402	64.69	PK	V	25.65	4.42	0.00	94.76	N/A	N/A
2402	59.62	AV	V	25.65	4.42	0.00	89.69	N/A	N/A
2390	27.12	PK	H	25.61	4.39	0.00	57.12	74.00	16.88
2390	14.19	AV	H	25.61	4.39	0.00	44.19	54.00	9.81
4804	45.06	PK	V	30.59	5.98	27.26	54.37	74.00	19.63
4804	33.42	AV	V	30.59	5.98	27.26	42.73	54.00	11.27
7206	33.61	PK	H	34.09	7.45	26.30	48.85	74.00	25.15
7206	18.38	AV	H	34.09	7.45	26.30	33.62	54.00	20.38
9608	33.18	PK	V	35.96	8.80	26.22	51.72	74.00	22.28
9608	18.45	AV	V	35.96	8.80	26.22	36.99	54.00	17.01
2071.78	37.05	PK	H	24.79	3.91	27.17	38.58	74.00	35.42
2071.78	22.21	AV	H	24.79	3.91	27.17	23.74	54.00	30.26
431.49	43.50	QP	H	16.78	2.50	21.85	40.93	46.00	5.07*
Middle Channel: 2440(MHz)									
2440	62.02	PK	H	25.74	4.40	0.00	92.16	N/A	N/A
2440	54.89	AV	H	25.74	4.40	0.00	85.03	N/A	N/A
2440	62.42	PK	V	25.74	4.40	0.00	92.56	N/A	N/A
2440	55.27	AV	V	25.74	4.40	0.00	85.41	N/A	N/A
4880	41.25	PK	V	30.79	6.08	27.26	50.86	74.00	23.14
4880	30.19	AV	V	30.79	6.08	27.26	39.80	54.00	14.20
7320	32.06	PK	H	34.37	7.51	26.53	47.41	74.00	26.59
7320	18.33	AV	H	34.37	7.51	26.53	33.68	54.00	20.32
9760	33.02	PK	V	36.32	8.83	25.63	52.54	74.00	21.46
9760	18.56	AV	V	36.32	8.83	25.63	38.08	54.00	15.92
1651.47	35.69	PK	H	23.90	3.41	26.93	36.07	74.00	37.93
1651.47	21.85	AV	H	23.90	3.41	26.93	22.23	54.00	31.77
2072.53	37.32	PK	H	24.79	3.91	27.17	38.85	74.00	35.15
2072.53	22.41	AV	H	24.79	3.91	27.17	23.94	54.00	30.06
431.72	43.30	QP	V	16.79	2.50	21.85	40.74	46.00	5.26*
High Channel: 2480(MHz)									
2480	61.97	PK	H	25.85	4.48	0.00	92.30	N/A	N/A
2480	54.88	AV	H	25.85	4.48	0.00	85.21	N/A	N/A
2480	62.29	PK	V	25.85	4.48	0.00	92.62	N/A	N/A
2480	55.29	AV	V	25.85	4.48	0.00	85.62	N/A	N/A
2483.5	27.58	PK	H	25.86	4.49	0.00	57.93	74.00	16.07
2483.5	14.16	AV	H	25.86	4.49	0.00	44.51	54.00	9.49
4960	33.35	PK	V	31.00	5.90	27.27	42.98	74.00	31.02
4960	21.22	AV	V	31.00	5.90	27.27	30.85	54.00	23.15
7440	31.29	PK	H	34.66	7.58	26.56	46.97	74.00	27.03
7440	17.85	AV	H	34.66	7.58	26.56	33.53	54.00	20.47
9920	31.87	PK	V	36.71	8.87	25.50	51.95	74.00	22.05
9920	18.53	AV	V	36.71	8.87	25.50	38.61	54.00	15.39
2075.69	37.46	PK	H	24.80	3.90	27.18	38.98	74.00	35.02
2075.69	22.53	AV	H	24.80	3.90	27.18	24.05	54.00	29.95
431.95	43.10	QP	V	16.79	2.50	21.85	40.54	46.00	5.46*

\*Within measurement uncertainty!

### Conducted Spurious Emissions at Antenna Port

#### Low Channel

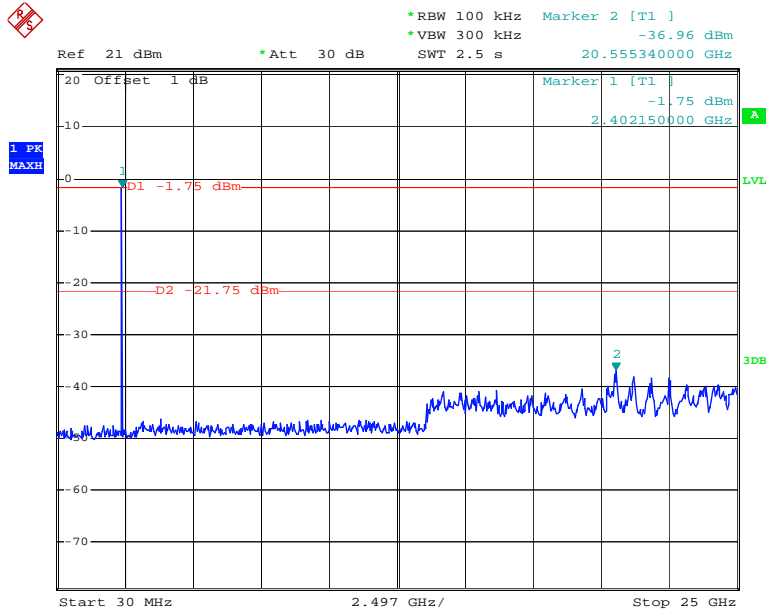

Date: 22.JAN.2014 18:23:14

#### Middle Channel

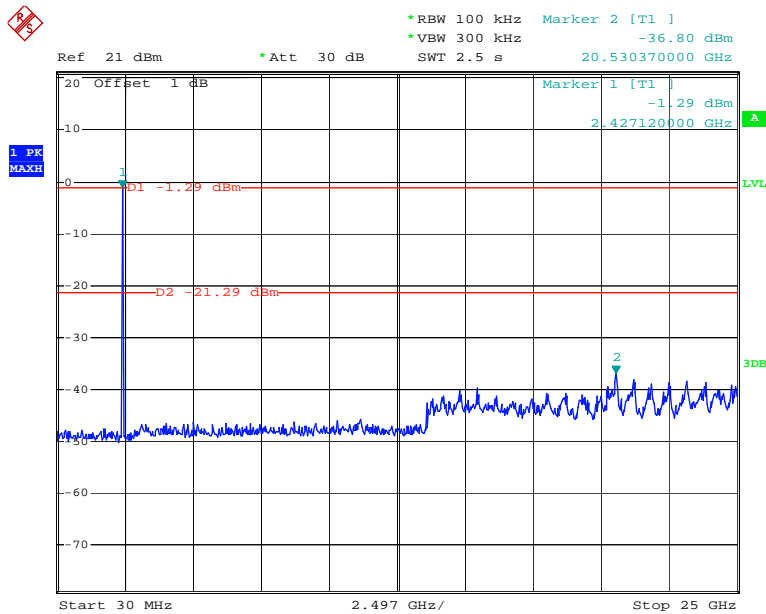

Date: 22.JAN.2014 18:28:50

### High Channel

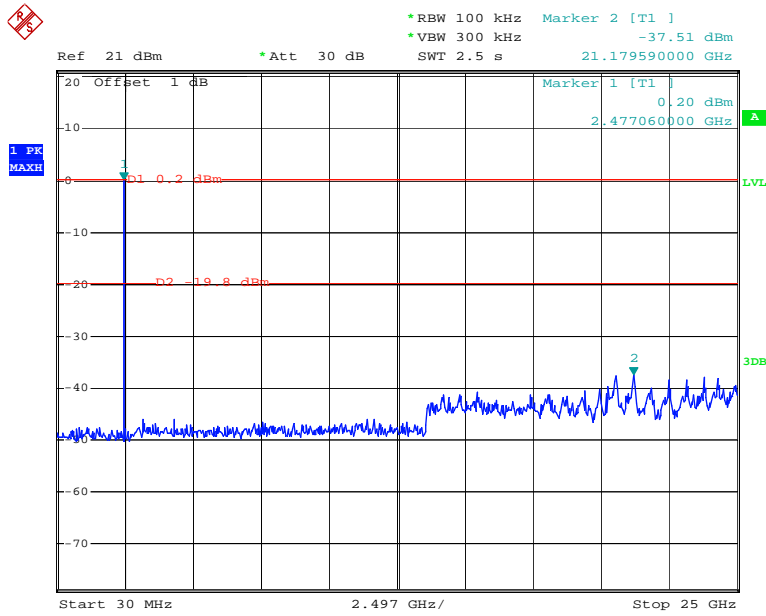

Date: 22.JAN.2014 18:26:38

## FCC §15.247(a) (2) – 6 dB EMISSION BANDWIDTH

### Applicable Standard

Systems using digital modulation techniques may operate in the 902–928 MHz, 2400–2483.5 MHz, and 5725–5850 MHz bands. The minimum 6 dB bandwidth shall be at least 500 kHz.

### Test Procedure

1. Check the calibration of the measuring instrument using either an internal calibrator or a known signal from an external generator.
2. Position the EUT without connection to measurement instrument. Turn on the EUT and connect it to measurement instrument. Then set it to any one convenient frequency within its operating range. Set a reference level on the measuring instrument equal to the highest peak value.
3. Measure the frequency difference of two frequencies that were attenuated 6 dB from the reference level. Record the frequency difference as the emission bandwidth.
4. Repeat above procedures until all frequencies measured were complete.

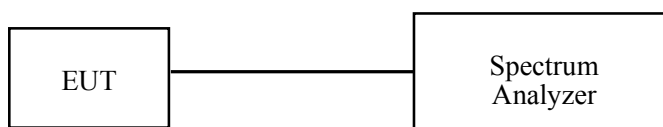

### Test Equipment List and Details

Manufacturer	Description	Model	Serial Number	Calibration Date	Calibration Due Date
R&S	Spectrum analyzer	FSP 38	100478	2013-6-16	2014-6-15

\* **Statement of Traceability:** Bay Area Compliance Laboratories Corp. (Dongguan) attests that all calibrations have been performed in accordance to NVLAP requirements, traceable to National Primary Standards and International System of Units (SI).

### Test Data

#### Environmental Conditions

<b>Temperature:</b>	20.8 °C
<b>Relative Humidity:</b>	38 %
<b>ATM Pressure:</b>	102.1 kPa

\* The testing was performed by Allen Qiao on 2014-01-22.

**Test Result:** Pass.

Please refer to the following tables and plots.

Channel	Frequency	6 dB Bandwidth	Limit
	(MHz)	(MHz)	(kHz)
Low	2402	0.662	>500
Middle	2440	0.668	>500
High	2480	0.664	>500

Low Channel

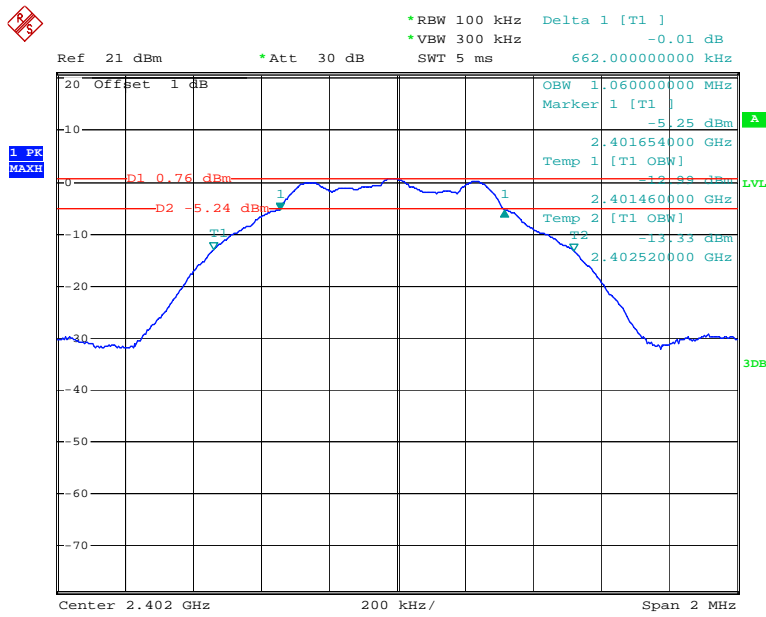

Date: 22.JAN.2014 18:16:44



### Middle Channel

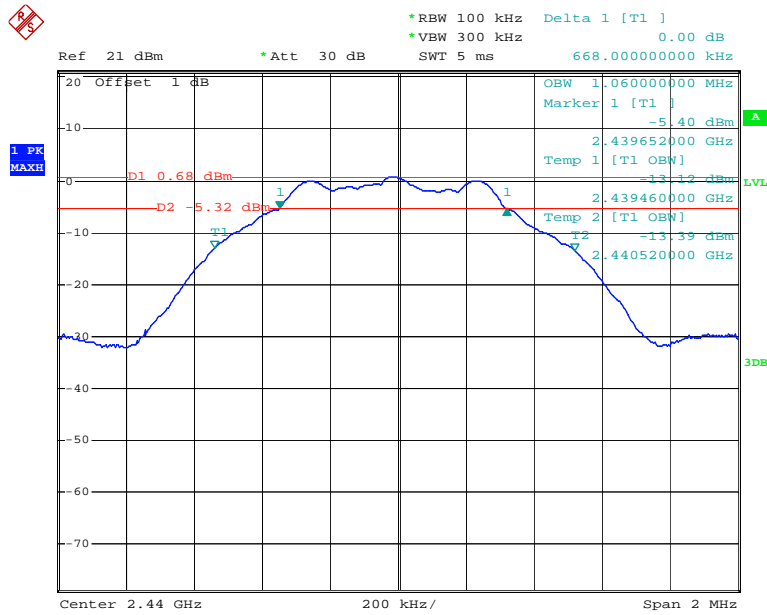

Date: 22.JAN.2014 18:15:37

### High Channel

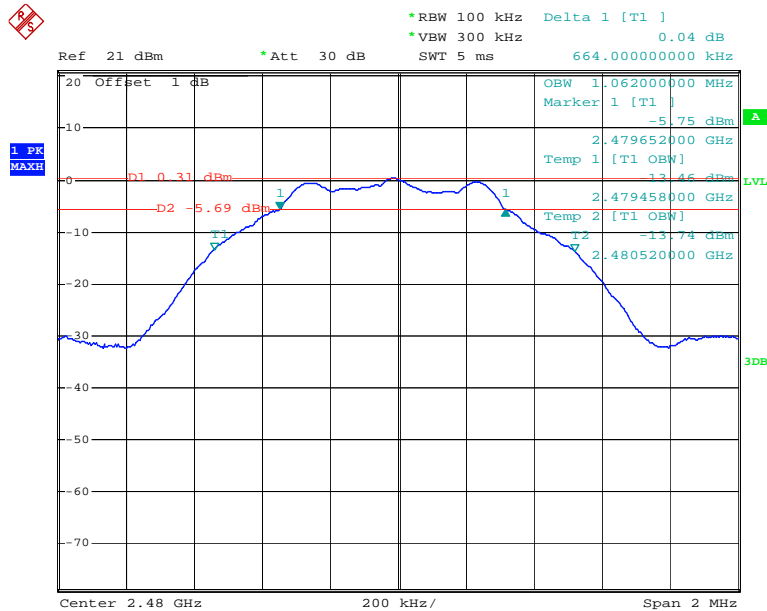

Date: 22.JAN.2014 18:18:23

## FCC §15.247(b) (3) - MAXIMUM PEAK OUTPUT POWER

### Applicable Standard

According to FCC §15.247(b) (3), for systems using digital modulation in the 902-928 MHz, 2400-2483.5 MHz, and 5725-5850 MHz bands: 1 Watt. As an alternative to a peak power measurement, compliance with the one Watt limit can be based on a measurement of the maximum conducted output power. Maximum Conducted Output Power is defined as the total transmit power delivered to all antennas and antenna elements averaged across all symbols in the signaling alphabet when the transmitter is operating at its maximum power control level. Power must be summed across all antennas and antenna elements. The average must not include any time intervals during which the transmitter is off or is transmitting at a reduced power level. If multiple modes of operation are possible (e.g., alternative modulation methods), the maximum conducted output power is the highest total transmit power occurring in any mode.

### Test Procedure

1. Place the EUT on a bench and set it in transmitting mode.
2. Remove the antenna from the EUT and then connect a low loss RF cable from the antenna port to a Spectrum Analyzer.
3. Add a correction factor to the display.

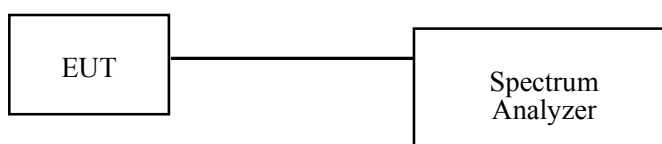

### Test Equipment List and Details

Manufacturer	Description	Model	Serial Number	Calibration Date	Calibration Due Date
R&S	Spectrum analyzer	FSP 38	100478	2013-6-16	2014-6-15

\* **Statement of Traceability:** Bay Area Compliance Laboratories Corp. (Dongguan) attests that all calibrations have been performed in accordance to NVLAP requirements, traceable to National Primary Standards and International System of Units (SI).

### Test Data

#### Environmental Conditions

Temperature:	20.8 °C
Relative Humidity:	38 %
ATM Pressure:	102.1 kPa

\* The testing was performed by Allen Qiao on 2014-01-22.

Test Mode: Transmitting

Channel	Frequency	Conducted Output Power	Limit	Result
	(MHz)	(dBm)	(dBm)	
Low	2402	1.49	30	PASS
Middle	2440	1.23	30	PASS
High	2480	0.96	30	PASS

Please refer to the following plots

**RF Output Power, Low Channel**

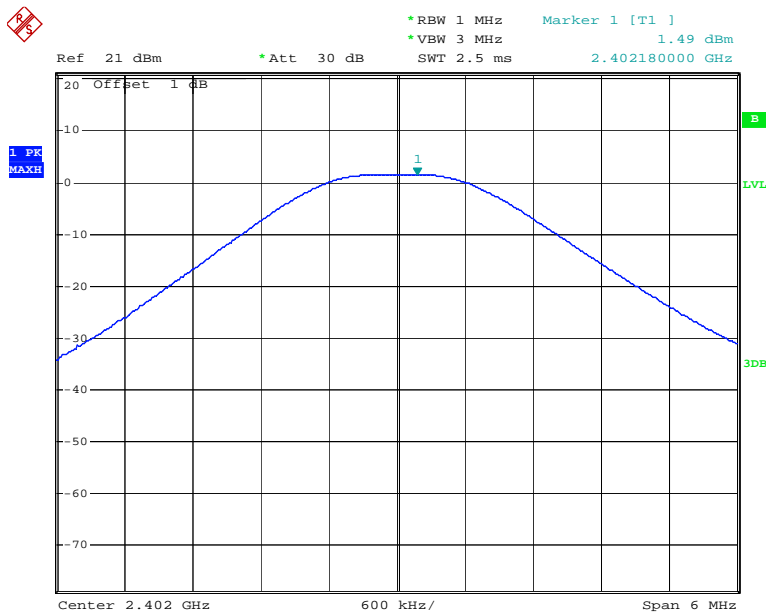

Date: 22.JAN.2014 18:04:25

### RF Output Power, Middle Channel

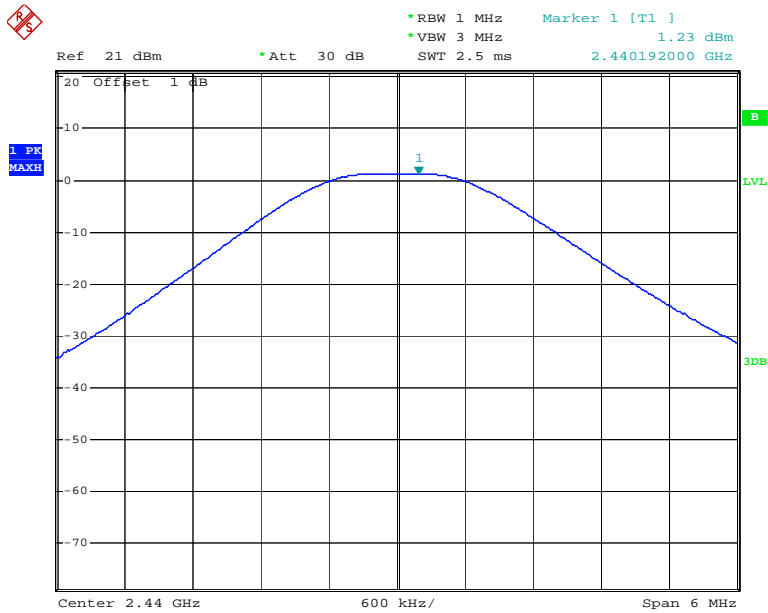

Date: 22.JAN.2014 18:03:51

### RF Output Power, High Channel

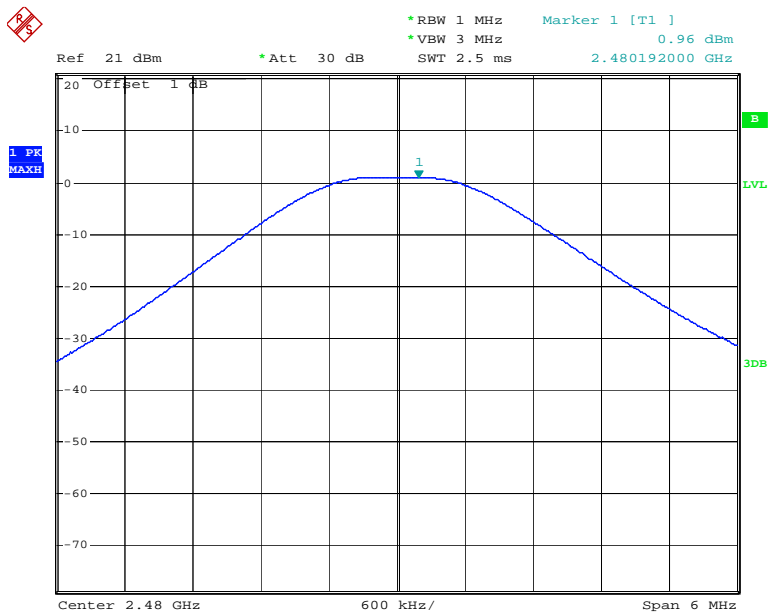

Date: 22.JAN.2014 18:03:17

## **FCC §15.247(d) – 100 kHz BANDWIDTH OF FREQUENCY BAND EDGE**

### **Applicable Standard**

In any 100 kHz bandwidth outside the frequency band in which the spread spectrum or digitally modulated intentional radiator is operating, the radio frequency power that is produced by the intentional radiator shall be at least 20 dB below that in the 100 kHz bandwidth within the band that contains the highest level of the desired power, based on either an RF conducted or a radiated measurement, provided the transmitter demonstrates compliance with the peak conducted power limits. If the transmitter complies with the conducted power limits based on the use of RMS averaging over a time interval, as permitted under paragraph (b)(3) of this section, the attenuation required under this paragraph shall be 30 dB instead of 20 dB. Attenuation below the general limits specified in §15.209(a) is not required. In addition, radiated emissions which fall in the restricted bands, as defined in §15.205(a), must also comply with the radiated emission limits specified in §15.209(a) (see §15.205(c)).

### **Test Procedure**

1. Check the calibration of the measuring instrument using either an internal calibrator or a known signal from an external generator.
2. Position the EUT without connection to measurement instrument. Turn on the EUT and connect its antenna terminal to measurement instrument via a low loss cable. Then set it to any one measured frequency within its operating range, and make sure the instrument is operated in its linear range.
3. Set RBW to 100 kHz and VBW of spectrum analyzer to 300 kHz with a convenient frequency span including 100 kHz bandwidth from band edge.
4. Measure the highest amplitude appearing on spectral display and set it as a reference level. Plot the graph with marking the highest point and edge frequency.
5. Repeat above procedures until all measured frequencies were complete.

### **Test Equipment List and Details**

<b>Manufacturer</b>	<b>Description</b>	<b>Model</b>	<b>Serial Number</b>	<b>Calibration Date</b>	<b>Calibration Due Date</b>
R&S	Spectrum analyzer	FSP 38	100478	2013-6-16	2014-6-15

\* **Statement of Traceability:** Bay Area Compliance Laboratories Corp. (Dongguan) attests that all calibrations have been performed in accordance to NVLAP requirements, traceable to National Primary Standards and International System of Units (SI).

### **Test Data**

#### **Environmental Conditions**

<b>Temperature:</b>	20.8 °C
<b>Relative Humidity:</b>	38 %
<b>ATM Pressure:</b>	102.1 kPa

\* The testing was performed by Allen Qiao on 2014-01-22.

#### **Test Result: Compliance**

Please refer to following plots.

### Band Edge, Left Side

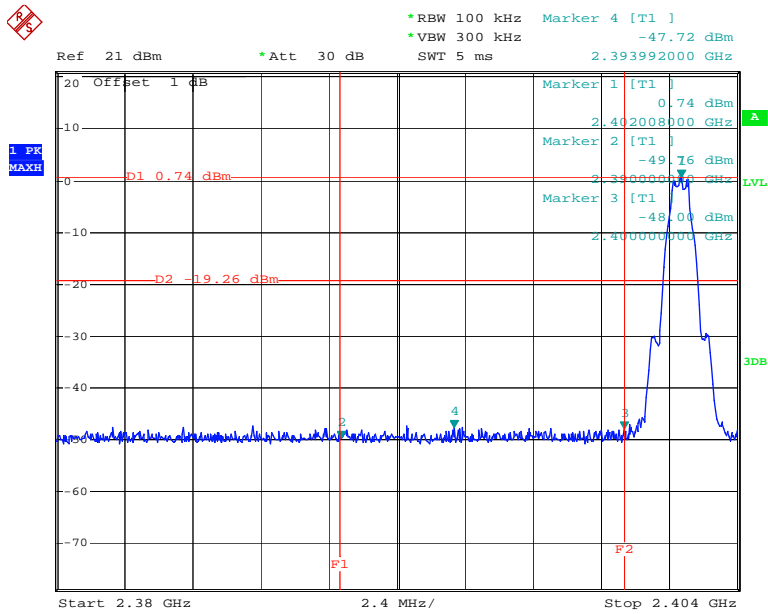

Date: 22.JAN.2014 18:24:17

### Band Edge, Right Side

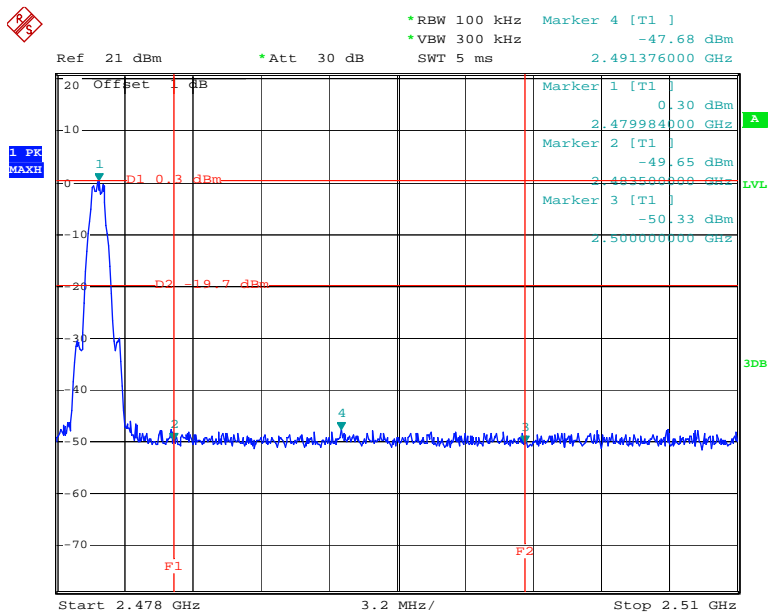

Date: 22.JAN.2014 18:25:43

## FCC §15.247(e) - POWER SPECTRAL DENSITY

### Applicable Standard

For digitally modulated systems, the power spectral density conducted from the intentional radiator to the antenna shall not be greater than 8 dBm in any 3 kHz band during any time interval of continuous transmission. This power spectral density shall be determined in accordance with the provisions of paragraph (b) of this section. The same method of determining the conducted output power shall be used to determine the power spectral density.

### Test Procedure

1. Check the calibration of the measuring instrument using either an internal calibrator or a known signal from an external generator.
2. Position the EUT was set without connection to measurement instrument. Turn on the EUT and connect its antenna terminal to measurement instrument via a low loss cable. Then set it to any one measured frequency within its operating range, and make sure the instrument is operated in its linear range.
3. According to KDB 558074 D01 DTS Meas Guidance v03r01, set the RBW = 3 kHz, VBW = 10 kHz, Set the span to 1.5 times the DTS channel bandwidth.
4. Use the peak marker function to determine the maximum power level in any 3 kHz band.

### Test Equipment List and Details

Manufacturer	Description	Model	Serial Number	Calibration Date	Calibration Due Date
R&S	Spectrum analyzer	FSP 38	100478	2013-6-16	2014-6-15

\* **Statement of Traceability:** Bay Area Compliance Laboratories Corp. (Dongguan) attests that all calibrations have been performed in accordance to NVLAP requirements, traceable to National Primary Standards and International System of Units (SI).

### Test Data

#### Environmental Conditions

Temperature:	20.8 °C
Relative Humidity:	38 %
ATM Pressure:	102.1 kPa

\* The testing was performed by Allen Qiao on 2014-01-22.

Test Mode: Transmitting

Test Result: Pass

Channel	Frequency	PSD	Limit	Result
	MHz	(dBm/3kHz)	(dBm/3kHz)	
Low	2402	-14.37	8	PASS
Middle	2440	-14.23	8	PASS
High	2480	-14.70	8	PASS

Please refer to the following plots

Power Spectral Density, Low Channel

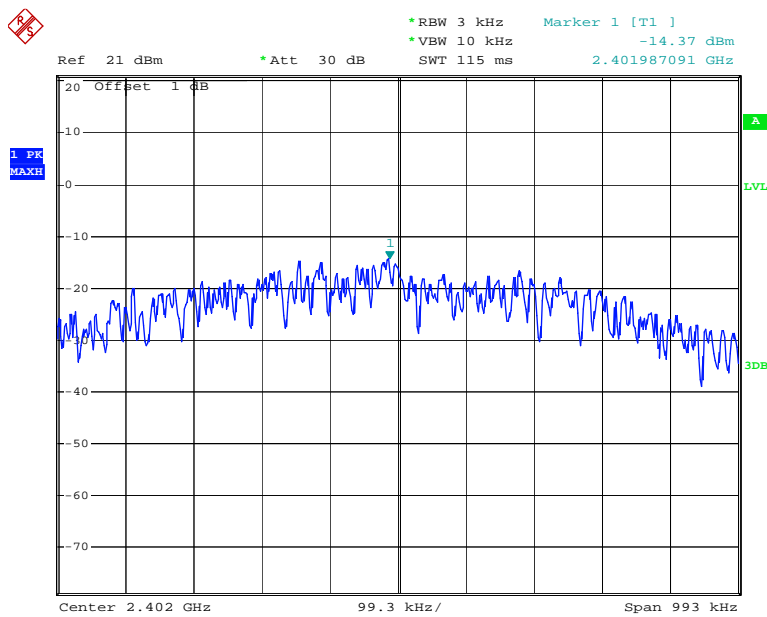

Date: 22.JAN.2014 18:22:23



### Power Spectral Density, Middle Channel

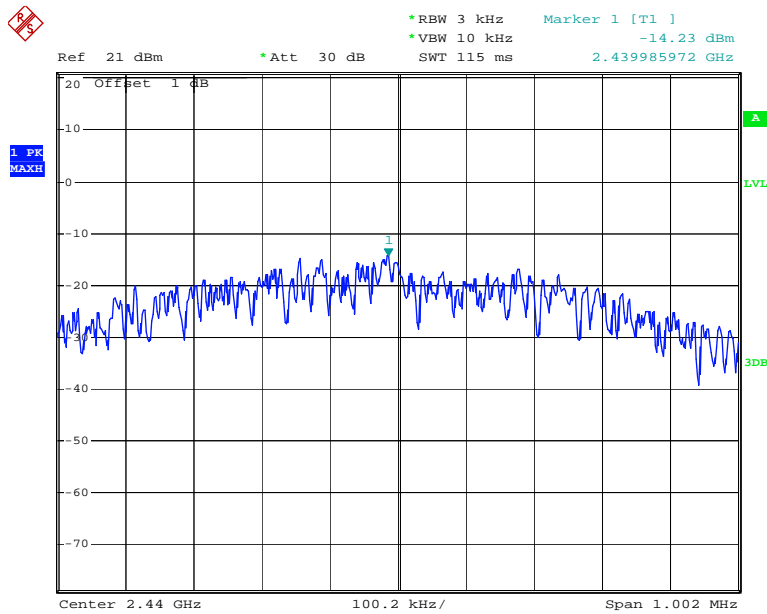

Date: 22.JAN.2014 18:21:16

### Power Spectral Density, High Channel

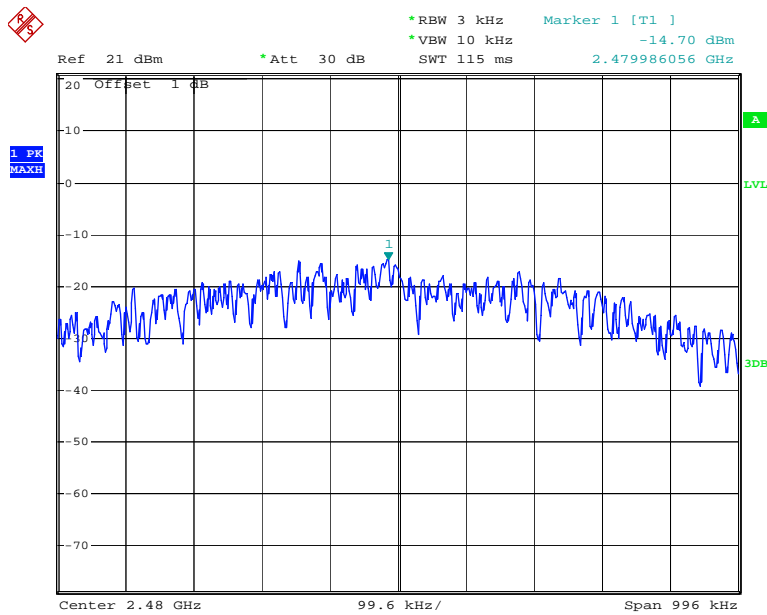

Date: 22.JAN.2014 18:20:00

\*\*\*\*\* END OF REPORT \*\*\*\*\*