



# FCC PART 15.247 TEST REPORT

For

**invoxia**

87 rue du Gouverneur General Eboue Issy Les Moulineaux, France

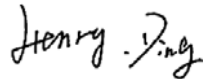
**FCC ID: ZVS-NVX-DCK2**

|   |  |
|---|--|
| <b>Report Type:</b><br>Original Report  | <b>Product Type:</b><br>Audiooffice dock<br>(Bluetooth device)                       |
| <b>Test Engineer:</b> Henry Ding  |  |
| <b>Report Number:</b> RSZ130311001-00B  |  |
| <b>Report Date:</b> 2013-03-19  |  |
| <b>Reviewed By:</b> RF Leader   |  |
| <b>Prepared By:</b> Bay Area Compliance Laboratories Corp. (Shenzhen)<br>6/F, the 3rd Phase of WanLi Industrial Building<br>ShiHua Road, FuTian Free Trade Zone<br>Shenzhen, Guangdong, China<br>Tel: +86-755-33320018<br>Fax: +86-755-33320008<br><a href="http://www.baclcorp.com.cn">www.baclcorp.com.cn</a> |  |

**Note:** This test report is prepared for the customer shown above and for the equipment described herein. It may not be duplicated or used in part without prior written consent from Bay Area Compliance Laboratories Corp.

**TABLE OF CONTENTS**

**GENERAL INFORMATION.....4**

    PRODUCT DESCRIPTION FOR EQUIPMENT UNDER TEST (EUT).....4

    OBJECTIVE .....4

    RELATED SUBMITTAL(S)/GRANT(S).....4

    TEST METHODOLOGY .....4

    TEST FACILITY .....5

**SYSTEM TEST CONFIGURATION .....6**

    DESCRIPTION OF TEST CONFIGURATION .....6

    EQUIPMENT MODIFICATIONS .....6

    EUT EXERCISE SOFTWARE .....6

    EXTERNAL I/O CABLE .....6

    BLOCK DIAGRAM OF TEST SETUP .....6

**SUMMARY OF TEST RESULTS .....7**

**FCC §15.247 (i) & §2.1093 – RF EXPOSURE .....8**

    APPLICABLE STANDARD .....8

    RESULT .....8

**FCC §15.203 – ANTENNA REQUIREMENT .....9**

    APPLICABLE STANDARD .....9

    ANTENNA CONNECTOR CONSTRUCTION .....9

**FCC §15.207 (a) – AC LINE CONDUCTED EMISSIONS .....10**

    APPLICABLE STANDARD .....10

    EUT SETUP.....10

    EMI TEST RECEIVER SETUP.....10

    TEST PROCEDURE .....11

    TEST EQUIPMENT LIST AND DETAILS.....11

    CORRECTED FACTOR & MARGIN CALCULATION .....11

    TEST RESULTS SUMMARY .....11

    TEST DATA .....11

**FCC §15.205, §15.209 & §15.247(d) – RADIATED EMISSIONS.....14**

    APPLICABLE STANDARD .....14

    EUT SETUP .....14

    EMI TEST RECEIVER & SPECTRUM ANALYZER SETUP .....15

    TEST PROCEDURE .....15

    CORRECTED AMPLITUDE & MARGIN CALCULATION .....15

    TEST EQUIPMENT LIST AND DETAILS.....15

    TEST RESULTS SUMMARY .....16

    TEST DATA .....16

**FCC §15.247(a) (1)-CHANNEL SEPARATION TEST .....19**

    APPLICABLE STANDARD .....19

    TEST PROCEDURE .....19

    TEST EQUIPMENT LIST AND DETAILS.....19

    TEST DATA .....19

**FCC §15.247(a) (1) – 20 dB EMISSION BANDWIDTH.....26**

    APPLICABLE STANDARD .....26

    TEST PROCEDURE .....26

TEST EQUIPMENT LIST AND DETAILS.....26  
 TEST DATA .....26

**FCC §15.247(a) (1) (iii)-QUANTITY OF HOPPING CHANNEL TEST .....32**  
 APPLICABLE STANDARD .....32  
 TEST PROCEDURE .....32  
 TEST EQUIPMENT LIST AND DETAILS.....32  
 TEST DATA .....32

**FCC §15.247(a) (1) (iii) -TIME OF OCCUPANCY (DWELL TIME).....35**  
 APPLICABLE STANDARD .....35  
 TEST PROCEDURE .....35  
 TEST EQUIPMENT LIST AND DETAILS.....35  
 TEST DATA .....35

**FCC §15.247(b) (1) - PEAK OUTPUT POWER MEASUREMENT .....51**  
 APPLICABLE STANDARD .....51  
 TEST PROCEDURE .....51  
 TEST EQUIPMENT LIST AND DETAILS.....51  
 TEST DATA .....51

**FCC §15.247(d) - BAND EDGES TESTING .....57**  
 APPLICABLE STANDARD .....57  
 TEST PROCEDURE .....57  
 TEST EQUIPMENT LIST AND DETAILS.....57  
 TEST DATA .....58

## GENERAL INFORMATION

---

### Product Description for Equipment under Test (EUT)

The *invoxia*'s product, model number: *Audiooffice (FCC ID: ZVS-NVX-DCK2)* or the "EUT" in this report was a NVX2, which was measured approximately: 29.0 cm (L) x 14.0 cm (W) x 6.0 cm (H), rated input voltage: DC 12V from adapter.

#### Adapter Information:

Model: KSAP0361200300D5

Input: 100-240V~50/60Hz, 0.8A

Output: DC 12V, 3.0A

*\* All measurement and test data in this report was gathered from production sample serial number: 0231330010005DE (Assigned by the applicant). The EUT supplied by the applicant was received on 2013-03-11.*

### Objective

This test report is prepared on behalf of *invoxia* in accordance with Part 2-Subpart J, Part 15-Subparts A, B and C of the Federal Communication Commissions rules.

The tests were performed in order to determine compliance with FCC Part 15, Subpart C, section 15.203, 15.205, 15.207, 15.209 and 15.247 rules.

### Related Submittal(s)/Grant(s)

N/A

### Test Methodology

All measurements contained in this report were conducted with ANSI C63.4-2003, American National Standard for Methods of Measurement of Radio-Noise Emissions from Low-Voltage Electrical and Electronic Equipment in the range of 9 kHz to 40 GHz.

All emissions measurement was performed and Bay Area Compliance Laboratories Corp. (Shenzhen). The radiated testing was performed at an antenna-to-EUT distance of 3 meters.

## **Test Facility**

The Test site used by Bay Area Compliance Laboratories Corp. (Shenzhen) to collect test data is located on the 6/F, the 3<sup>rd</sup> Phase of WanLi Industrial Building, ShiHua Road, FuTian Free Trade Zone Shenzhen, Guangdong, China.

Test site at Bay Area Compliance Laboratories Corp. (Shenzhen) has been fully described in reports submitted to the Federal Communication Commission (FCC). The details of these reports have been found to be in compliance with the requirements of Section 2.948 of the FCC Rules on December 06, 2010. The facility also complies with the radiated and AC line conducted test site criteria set forth in ANSI C63.4-2003.

The Federal Communications Commission has the reports on file and is listed under FCC Registration No.: 382179. The test site has been approved by the FCC for public use and is listed in the FCC Public Access Link (PAL) database.

## SYSTEM TEST CONFIGURATION

### Description of Test Configuration

The system was configured for testing with test software.

### Equipment Modifications

No modification was made to the EUT tested.

### EUT Exercise Software

CSR Bluesuite

### External I/O Cable

| Cable Description                  | Length (m) | From Port | To      |
|------------------------------------|------------|-----------|---------|
| Unshielding Detachable Power Cable | 1.5        | EUT       | Adapter |

### Block Diagram of Test Setup

For conducted emission

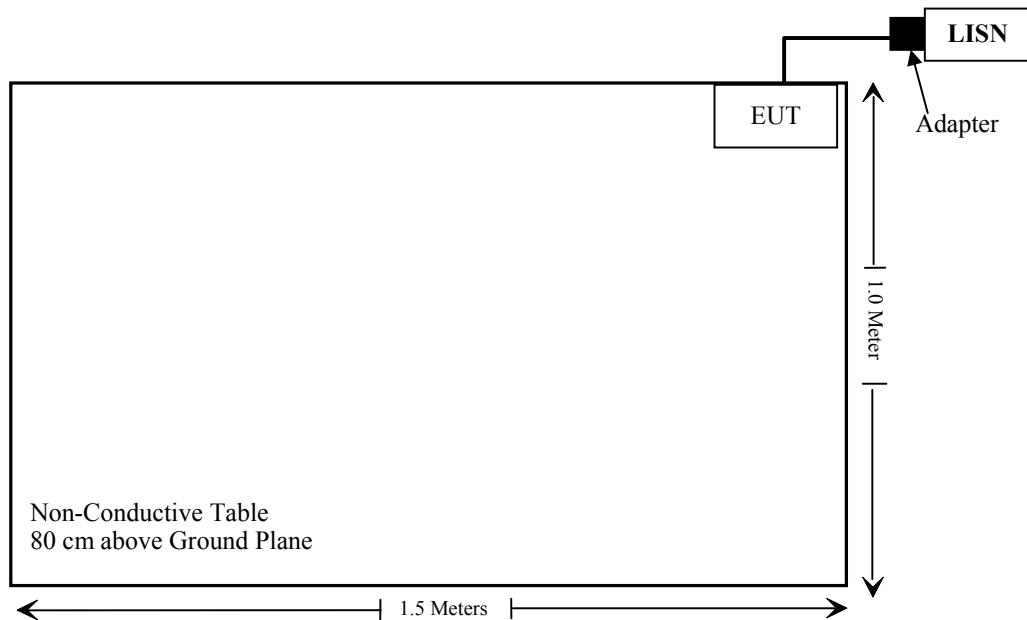

**SUMMARY OF TEST RESULTS**

| <b>FCC Rules</b>              | <b>Description of Test</b>       | <b>Result</b> |
|-------------------------------|----------------------------------|---------------|
| §15.247 (i), §2.1093          | RF Exposure                      | Compliance    |
| §15.203                       | Antenna Requirement              | Compliance    |
| §15.207(a)                    | AC Line Conducted Emissions      | Compliance    |
| §15.205, §15.209 & §15.247(d) | Radiated Emissions               | Compliance    |
| §15.247(a)(1)                 | 20 dB Emission Bandwidth         | Compliance    |
| §15.247(a)(1)                 | Channel Separation Test          | Compliance    |
| §15.247(a)(1)(iii)            | Time of Occupancy (Dwell Time)   | Compliance    |
| §15.247(a)(1)(iii)            | Quantity of hopping channel Test | Compliance    |
| §15.247(b)(1)                 | Peak Output Power Measurement    | Compliance    |
| §15.247(d)                    | Band edges                       | Compliance    |

---

## **FCC §15.247 (i) & §2.1093 – RF EXPOSURE**

---

### **Applicable Standard**

According to FCC §2.1093 and §1.1307(b) (1), systems operating under the provisions of this section shall be operated in a manner that ensure that the public is not exposed to radio frequency energy level in excess of the Commission's guideline.

According to KDB 447498 D01 General RF Exposure Guidance v05

### **Result**

According to FCC KDB 447498 D01 General RF Exposure Guidance v05 generic portable criteria

The distance between antenna and test point is 5 mm

The Max output power: 2.698 mW

According to the Appendix A of KDB 447498, the exclusion thresholds for 2450 MHz is 10 mW.

### **Conclusion:**

The time-averaged output power is 2.698 mW < the exclusion thresholds 10 mW, so SAR evaluation is not required.



---

## **FCC §15.203 – ANTENNA REQUIREMENT**

---

### **Applicable Standard**

According to FCC § 15.203, an intentional radiator shall be designed to ensure that no antenna other than that furnished by the responsible party shall be used with the device. The use of a permanently attached antenna or of an antenna that uses a unique coupling to the intentional radiator shall be considered sufficient to comply with the provisions of this Section. The manufacturer may design the unit so that a broken antenna can be replaced by the user, but the use of a standard antenna jack or electrical connector is prohibited.

### **Antenna Connector Construction**

The EUT has an integral antenna arrangement for bluetooth, which was permanently attached, the antenna gain is 2 dBi, fulfill the requirement of this section. Please refer to the internal photos.

**Result:** Compliance.

## FCC §15.207 (a) – AC LINE CONDUCTED EMISSIONS

### Applicable Standard

FCC §15.207(a)

### EUT Setup

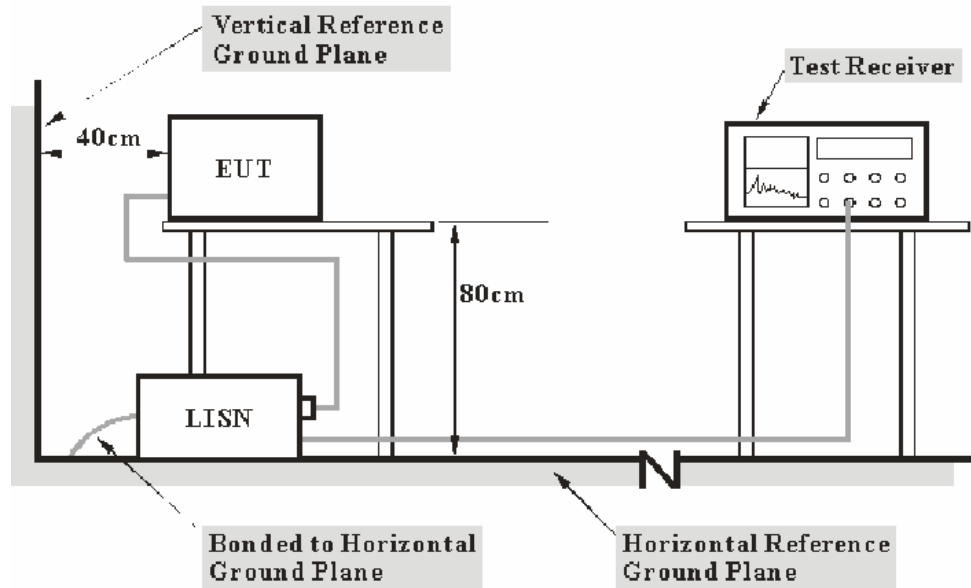

- Note: 1. Support units were connected to second LISN.  
 2. Both of LISNs (AMN) 80 cm from EUT and at the least 80 cm from other units and other metal planes support units.

The measurement procedure of EUT setup is according with ANSI C63.4-2003. The related limit was specified in FCC Part 15.207.

The adapter was connected to a 120 VAC/60 Hz power source.

### EMI Test Receiver Setup

The EMI test receiver was set to investigate the spectrum from 150 kHz to 30 MHz.

During the conducted emission test, the EMI test receiver was set with the following configurations:

| Frequency Range  | IF B/W |
|------------------|--------|
| 150 kHz – 30 MHz | 9 kHz  |

## Test Procedure

During the conducted emission test, the adapter was connected to the outlet of the LISN.

Maximizing procedure was performed on the six (6) highest emissions of the EUT.

All data was recorded in the Quasi-peak and average detection mode.

## Test Equipment List and Details

| Manufacturer    | Description       | Model   | Serial Number | Calibration Date | Calibration Due Date |
|-----------------|-------------------|---------|---------------|------------------|----------------------|
| Rohde & Schwarz | EMI Test Receiver | ESCS30  | 100176        | 2012-11-24       | 2013-11-23           |
| Rohde & Schwarz | L.I.S.N.          | ESH2-Z5 | 892107/021    | 2012-08-22       | 2013-08-21           |
| Rohde & Schwarz | Pulse limiter     | ESH3Z2  | DE25985       | 2012-07-08       | 2013-07-07           |
| BACL            | CE Test software  | BACL-CE | V1.0          | -                | -                    |

\* **Statement of Traceability:** Bay Area Compliance Laboratories Corp. (Shenzhen) attests that all calibrations have been performed in accordance to requirements, traceable to National Primary Standards and International System of Units (SI).

## Corrected Factor & Margin Calculation

The Corrected factor is calculated by adding LISN/ISN VDF (Voltage Division Factor), Cable Loss and Pulse Limiter Attenuation. The basic equation is as follows:

$$\text{Correction Factor} = \text{LISN VDF} + \text{Cable Loss} + \text{Pulse Limiter Attenuation}$$

The “**Margin**” column of the following data tables indicates the degree of compliance with the applicable limit. For example, a margin of 7dB means the emission is 7 dB below the limit. The equation for margin calculation is as follows:

$$\text{Margin} = \text{Limit} - \text{Corrected Amplitude}$$

## Test Results Summary

According to the recorded data in following table, the EUT complied with the FCC Part 15.207, with the worst margin reading of:

**22.17 dB at 0.155 MHz in the Line conducted mode**

## Test Data

### Environmental Conditions

|                           |           |
|---------------------------|-----------|
| <b>Temperature:</b>       | 25 °C     |
| <b>Relative Humidity:</b> | 55 %      |
| <b>ATM Pressure:</b>      | 101.0 kPa |

*The testing was performed by Henry Ding on 2013-03-15.*

EUT operation mode: Transmitting

AC 120 V, 60 Hz, Line:

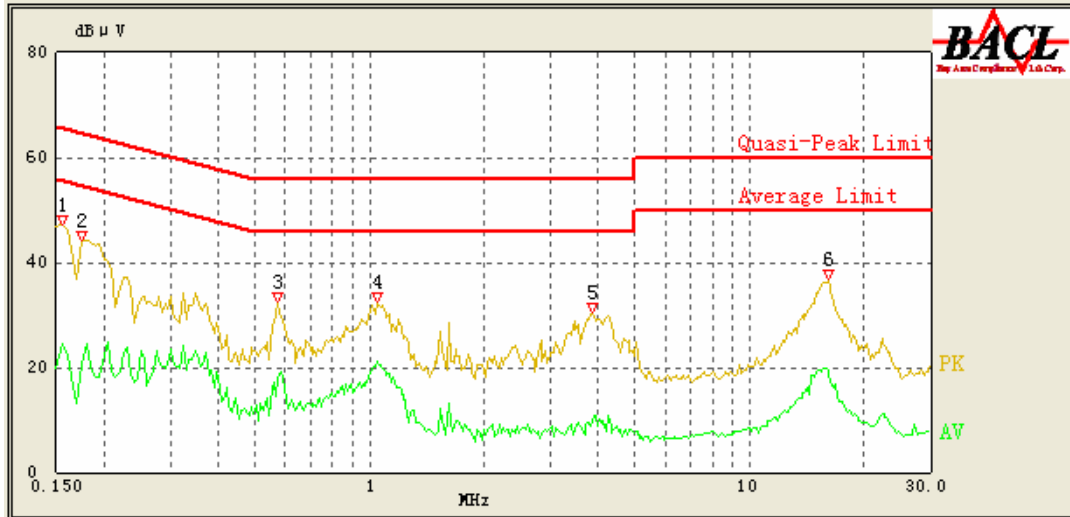

| Frequency (MHz) | Corrected Amplitude (dBµV) | Correction Factor (dB) | Limit (dBµV) | Margin (dB) | Detector (PK/Ave./QP) |
|-----------------|----------------------------|------------------------|--------------|-------------|-----------------------|
| 0.155           | 43.69                      | 10.10                  | 65.86        | 22.17       | QP                    |
| 1.050           | 21.02                      | 10.20                  | 46.00        | 24.98       | Ave.                  |
| 0.175           | 38.65                      | 10.10                  | 65.29        | 26.64       | QP                    |
| 0.575           | 28.08                      | 10.20                  | 56.00        | 27.92       | QP                    |
| 0.575           | 17.93                      | 10.20                  | 46.00        | 28.07       | Ave.                  |
| 1.050           | 27.35                      | 10.20                  | 56.00        | 28.65       | QP                    |
| 16.105          | 18.78                      | 10.62                  | 50.00        | 31.22       | Ave.                  |
| 0.155           | 24.45                      | 10.10                  | 55.86        | 31.41       | Ave.                  |
| 16.105          | 26.42                      | 10.62                  | 60.00        | 33.58       | QP                    |
| 0.175           | 20.51                      | 10.10                  | 55.29        | 34.78       | Ave.                  |
| 3.900           | 10.93                      | 10.20                  | 46.00        | 35.07       | Ave.                  |
| 3.900           | 20.71                      | 10.20                  | 56.00        | 35.29       | QP                    |

**AC 120V, 60 Hz, Neutral:**

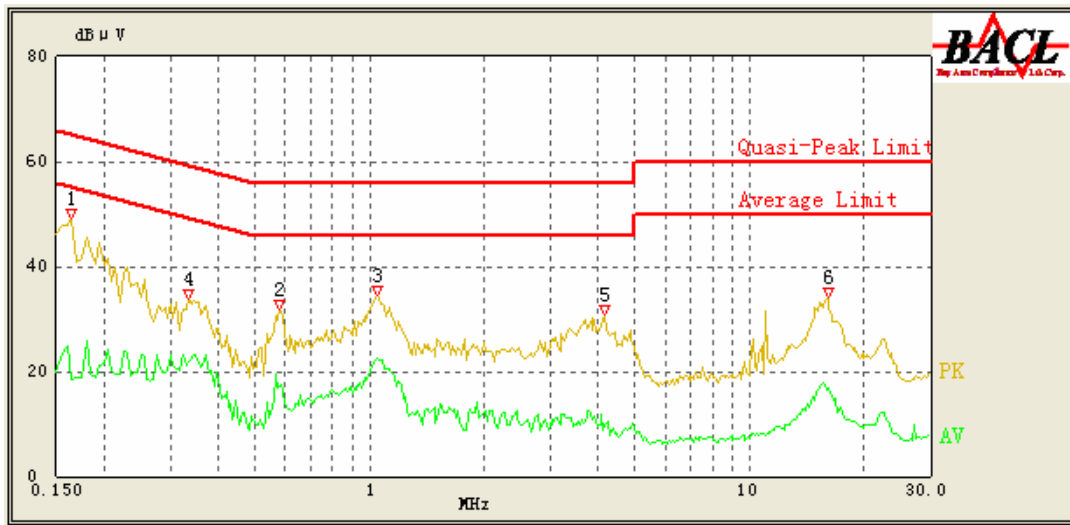

| Frequency (MHz) | Corrected Amplitude (dBµV) | Correction Factor (dB) | Limit (dBµV) | Margin (dB) | Detector (PK/Ave./QP) |
|-----------------|----------------------------|------------------------|--------------|-------------|-----------------------|
| 1.050           | 22.57                      | 10.20                  | 46.00        | 23.43       | Ave.                  |
| 1.050           | 28.14                      | 10.20                  | 56.00        | 27.86       | QP                    |
| 0.580           | 28.11                      | 10.20                  | 56.00        | 27.89       | QP                    |
| 0.580           | 17.58                      | 10.20                  | 46.00        | 28.42       | Ave.                  |
| 0.165           | 36.76                      | 10.10                  | 65.57        | 28.81       | QP                    |
| 0.335           | 21.88                      | 10.10                  | 50.71        | 28.83       | Ave.                  |
| 0.335           | 28.38                      | 10.10                  | 60.71        | 32.33       | QP                    |
| 16.065          | 16.41                      | 10.60                  | 50.00        | 33.59       | Ave.                  |
| 4.140           | 20.58                      | 10.20                  | 56.00        | 35.42       | QP                    |
| 16.065          | 24.29                      | 10.60                  | 60.00        | 35.71       | QP                    |
| 0.165           | 18.54                      | 10.10                  | 55.57        | 37.03       | Ave.                  |
| 4.140           | 8.85                       | 10.20                  | 46.00        | 37.15       | Ave.                  |

**Note:**

- 1) Correction Factor = LISN/ISN VDF (Voltage Division Factor) + Cable Loss + Pulse Limiter Attenuation  
The corrected factor has been input into the transducer of the test software.
- 2) Corrected Amplitude = Reading + Correction Factor
- 3) Margin = Limit - Corrected Amplitude

**FCC §15.205, §15.209 & §15.247(d) – RADIATED EMISSIONS**

**Applicable Standard**

FCC §15.205; §15.209; §15.247(d)

**EUT Setup**

**Below 1 GHz:**

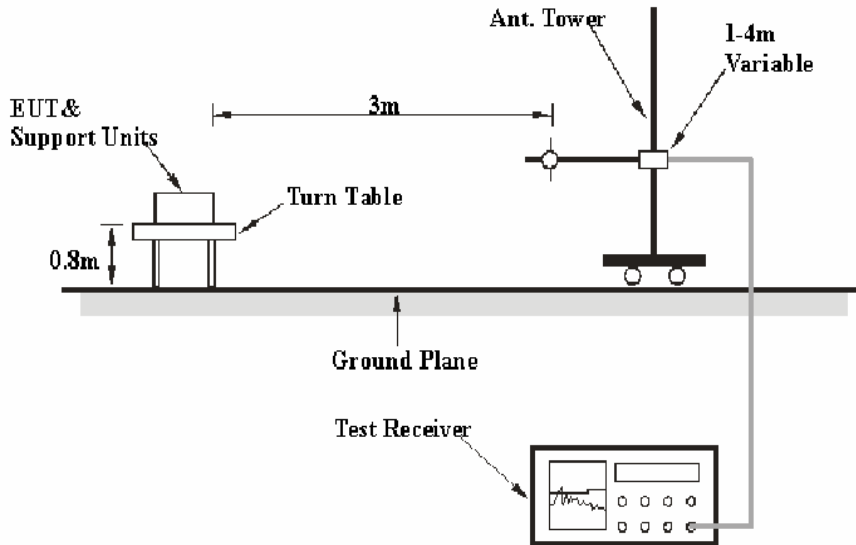

**Above 1 GHz:**

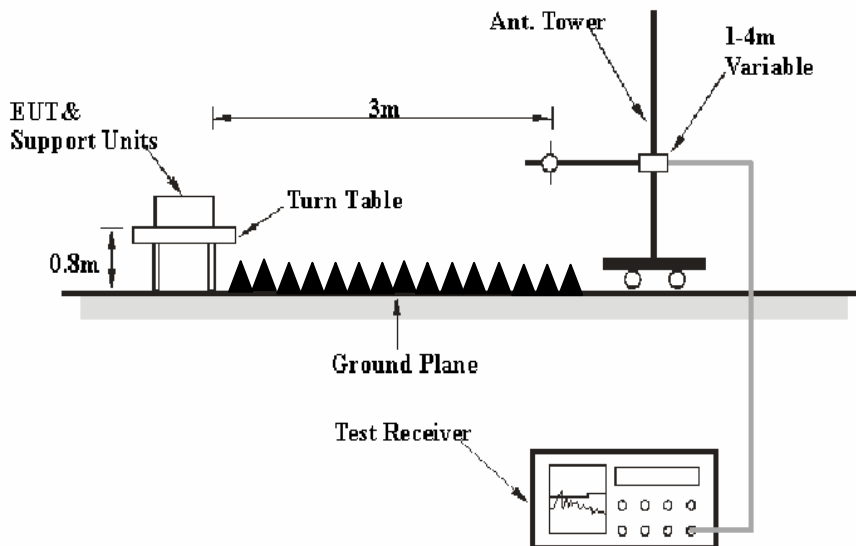

The radiated emission tests were performed in the 3 meters, using the setup accordance with the ANSI C63.4-2003. The specification used was the FCC 15.209 and FCC 15.247 limits.

## EMI Test Receiver & Spectrum Analyzer Setup

The system was investigated from 30 MHz to 25 GHz.

During the radiated emission test, the EMI test receiver & Spectrum Analyzer Setup were set with the following configurations:

| Frequency Range   | RBW     | Video B/W | IF B/W  | Detector |
|-------------------|---------|-----------|---------|----------|
| 30 MHz – 1000 MHz | 100 kHz | 300 kHz   | 120 kHz | QP       |
| Above 1 GHz       | 1MHz    | 3 MHz     | /       | PK       |
|                   | 1MHz    | 10 Hz     | /       | Ave.     |

## Test Procedure

Maximizing procedure was performed on the highest emissions to ensure that the EUT complied with all installation combinations.

Data was recorded in Quasi-peak detection mode for frequency range of 30 MHz -1 GHz and peak and Average detection modes for frequencies above 1 GHz.

## Corrected Amplitude & Margin Calculation

The Corrected Amplitude is calculated by adding the Antenna Factor and Cable Loss, and subtracting the Amplifier Gain from the Meter Reading. The basic equation is as follows:

$$\begin{aligned} \text{Corrected Factor} &= \text{Antenna Factor} + \text{Cable Loss} - \text{Amplifier Gain} \\ \text{Corrected Amplitude} &= \text{Meter Reading} + \text{Corrected Factor} \end{aligned}$$

The “**Margin**” column of the following data tables indicates the degree of compliance with the applicable limit. For example, a margin of 7 dB means the emission is 7 dB below the maximum limit. The equation for margin calculation is as follows:

$$\text{Margin} = \text{Limit} - \text{Corrected Amplitude}$$

## Test Equipment List and Details

| Manufacturer              | Description       | Model    | Serial Number | Calibration Date | Calibration Due Date |
|---------------------------|-------------------|----------|---------------|------------------|----------------------|
| HP                        | Amplifier         | 8447E    | 1937A01046    | 2012-11-24       | 2013-11-23           |
| Rohde & Schwarz           | EMI Test Receiver | ESCI     | 101122        | 2012-08-08       | 2013-08-07           |
| Sunol Sciences            | Broadband Antenna | JB1      | A040904-2     | 2011-11-28       | 2014-11-27           |
| SUPER ULTRA               | Amplifier         | ZVA-213+ | N/A           | 2012-11-24       | 2013-11-23           |
| Sunol Sciences            | Horn Antenna      | DRH-118  | A052304       | 2011-12-01       | 2014-11-30           |
| Rohde & Schwarz           | Signal Analyzer   | FSIQ26   | 8386001028    | 2012-11-24       | 2013-11-23           |
| Agilent                   | Spectrum Analyzer | 8564E    | 3943A01781    | 2012-05-17       | 2013-05-16           |
| the electro-Mechanics Co. | Horn Antenna      | 3116     | 9510-2270     | 2010-10-14       | 2013-10-13           |

\* **Statement of Traceability:** Bay Area Compliance Laboratories Corp. (Shenzhen) attests that all calibrations have been performed in accordance to requirements, traceable to National Primary Standards and International System of Units (SI).

## Test Results Summary

According to the recorded data in following table, the EUT complied with the FCC Title 47, Part 15, Subpart C, section 15.205, 15.209 and 15.247.

**1.59 dB at 33.61 MHz in the Vertical polarization**

## Test Data

### Environmental Conditions

|                           |           |
|---------------------------|-----------|
| <b>Temperature:</b>       | 25 °C     |
| <b>Relative Humidity:</b> | 55 %      |
| <b>ATM Pressure:</b>      | 101.0 kPa |

*The testing was performed by Henry Ding on 2013-03-15.*



EUT operation mode: Transmitting

30 MHz -25 GHz: (Scan with GFSK,  $\pi/4$ -DQPSK, 8-DPSK, the worst case is BDR Mode (GFSK))

| Frequency (MHz)           | Receiver       |                       | Turntable Degree | Rx Antenna |             | Corrected Factor (dB) | Corrected Amplitude (dBuV/m) | FCC Part 15.247/205/209 |             |
|---------------------------|----------------|-----------------------|------------------|------------|-------------|-----------------------|------------------------------|-------------------------|-------------|
|                           | Reading (dBuV) | Detector (PK/QP/Ave.) |                  | Height (m) | Polar (H/V) |                       |                              | Limit (dBuV/m)          | Margin (dB) |
| Low Channel (2402 MHz)    |                |                       |                  |            |             |                       |                              |                         |             |
| 33.61                     | 48.01          | QP                    | 58               | 1.0        | V           | -9.6                  | 38.41                        | 40                      | 1.59        |
| 33.61                     | 43.02          | QP                    | 167              | 1.2        | H           | -9.6                  | 33.42                        | 40                      | 6.58        |
| 2402.0                    | 92.33          | PK                    | 35               | 1.1        | H           | 6.13                  | 98.46                        | /                       | /           |
| 2402.0                    | 81.90          | Ave.                  | 35               | 1.1        | H           | 6.13                  | 88.03                        | /                       | /           |
| 2402.0                    | 95.53          | PK                    | 102              | 1.2        | V           | 6.13                  | 101.66                       | /                       | /           |
| 2402.0                    | 84.26          | Ave.                  | 102              | 1.2        | V           | 6.13                  | 90.39                        | /                       | /           |
| 7206.0                    | 21.51          | Ave.                  | 76               | 1.1        | H           | 17.06                 | 38.57                        | 54                      | 15.43       |
| 9608.0                    | 18.65          | Ave.                  | 94               | 1.0        | H           | 19.28                 | 37.93                        | 54                      | 16.07       |
| 4804.0                    | 22.26          | Ave.                  | 24               | 1.2        | V           | 12.40                 | 34.66                        | 54                      | 19.34       |
| 9608.0                    | 31.18          | PK                    | 94               | 1.0        | H           | 19.28                 | 50.46                        | 74                      | 23.54       |
| 2484.7                    | 22.73          | Ave.                  | 93               | 1.3        | H           | 7.21                  | 29.94                        | 54                      | 24.06       |
| 7206.0                    | 32.73          | PK                    | 76               | 1.1        | H           | 17.06                 | 49.79                        | 74                      | 24.21       |
| 4804.0                    | 36.66          | PK                    | 24               | 1.2        | V           | 12.40                 | 49.06                        | 74                      | 24.94       |
| 2383.7                    | 22.47          | Ave.                  | 88               | 1.1        | V           | 6.13                  | 28.60                        | 54                      | 25.40       |
| 2332.4                    | 22.32          | Ave.                  | 136              | 1.0        | V           | 5.48                  | 27.80                        | 54                      | 26.20       |
| 2484.7                    | 35.92          | PK                    | 93               | 1.3        | H           | 7.21                  | 43.13                        | 74                      | 30.87       |
| 2383.7                    | 36.72          | PK                    | 88               | 1.1        | V           | 6.13                  | 42.85                        | 74                      | 31.15       |
| 2332.4                    | 35.65          | PK                    | 136              | 1.0        | V           | 5.48                  | 41.13                        | 74                      | 32.87       |
| Middle Channel (2441 MHz) |                |                       |                  |            |             |                       |                              |                         |             |
| 33.61                     | 47.29          | QP                    | 230              | 1.0        | V           | -9.6                  | 37.69                        | 40                      | 2.31        |
| 33.61                     | 44.72          | QP                    | 124              | 1.2        | H           | -9.6                  | 35.12                        | 40                      | 4.88        |
| 2441.0                    | 92.81          | PK                    | 35               | 1.0        | H           | 7.21                  | 100.02                       | /                       | /           |
| 2441.0                    | 81.56          | Ave.                  | 35               | 1.0        | H           | 7.21                  | 88.77                        | /                       | /           |
| 2441.0                    | 95.39          | PK                    | 11               | 1.1        | V           | 7.21                  | 102.60                       | /                       | /           |
| 2441.0                    | 84.63          | Ave.                  | 11               | 1.1        | V           | 7.21                  | 91.84                        | /                       | /           |
| 9764.0                    | 19.03          | Ave.                  | 155              | 1.0        | H           | 19.40                 | 38.43                        | 54                      | 15.57       |
| 4882.0                    | 25.03          | Ave.                  | 82               | 1.1        | V           | 12.46                 | 37.49                        | 54                      | 16.51       |
| 7323.0                    | 20.76          | Ave.                  | 67               | 1.2        | H           | 16.49                 | 37.25                        | 54                      | 16.75       |
| 4882.0                    | 42.22          | PK                    | 82               | 1.1        | V           | 12.46                 | 54.68                        | 74                      | 19.32       |
| 9764.0                    | 31.66          | PK                    | 155              | 1.0        | H           | 19.40                 | 51.06                        | 74                      | 22.94       |
| 2492.7                    | 23.78          | Ave.                  | 64               | 1.2        | V           | 7.21                  | 30.99                        | 54                      | 23.01       |
| 7323.0                    | 32.59          | PK                    | 67               | 1.2        | H           | 16.49                 | 49.08                        | 74                      | 24.92       |
| 2336.9                    | 23.34          | Ave.                  | 137              | 1.3        | V           | 5.48                  | 28.82                        | 54                      | 25.18       |
| 2362.9                    | 22.33          | Ave.                  | 88               | 1.5        | V           | 5.48                  | 27.81                        | 54                      | 26.19       |
| 2492.7                    | 37.14          | PK                    | 64               | 1.2        | V           | 7.21                  | 44.35                        | 74                      | 29.65       |
| 2336.9                    | 38.36          | PK                    | 137              | 1.3        | V           | 5.48                  | 43.84                        | 74                      | 30.16       |
| 2362.9                    | 38.31          | PK                    | 88               | 1.5        | V           | 5.48                  | 43.79                        | 74                      | 30.21       |

| Frequency (MHz)         | Receiver       |                       | Turntable Degree | Rx Antenna |             | Corrected Factor (dB) | Corrected Amplitude (dBuV/m) | FCC Part 15.247/205/209 |             |
|-------------------------|----------------|-----------------------|------------------|------------|-------------|-----------------------|------------------------------|-------------------------|-------------|
|                         | Reading (dBuV) | Detector (PK/QP/Ave.) |                  | Height (m) | Polar (H/V) |                       |                              | Limit (dBuV/m)          | Margin (dB) |
| High Channel (2480 MHz) |                |                       |                  |            |             |                       |                              |                         |             |
| 33.61                   | 47.72          | QP                    | 122              | 1.0        | V           | -9.6                  | 38.12                        | 40                      | 1.88        |
| 33.61                   | 43.18          | QP                    | 57               | 1.2        | H           | -9.6                  | 33.58                        | 40                      | 6.42        |
| 2480.0                  | 92.06          | PK                    | 55               | 1.2        | H           | 7.21                  | 99.27                        | /                       | /           |
| 2480.0                  | 81.69          | Ave.                  | 55               | 1.2        | H           | 7.21                  | 88.90                        | /                       | /           |
| 2480.0                  | 93.96          | PK                    | 101              | 1.1        | V           | 7.21                  | 101.17                       | /                       | /           |
| 2480.0                  | 83.19          | Ave.                  | 101              | 1.1        | V           | 7.21                  | 90.40                        | /                       | /           |
| 9920.0                  | 19.73          | Ave.                  | 36               | 1.0        | H           | 19.38                 | 39.11                        | 54                      | 14.89       |
| 7440.0                  | 21.73          | Ave.                  | 122              | 1.2        | V           | 15.90                 | 37.63                        | 54                      | 16.37       |
| 4960.0                  | 24.06          | Ave.                  | 77               | 1.3        | H           | 12.50                 | 36.56                        | 54                      | 17.44       |
| 2483.5                  | 48.77          | PK                    | 36               | 1.1        | V           | 7.21                  | 55.98                        | 74                      | 18.02       |
| 2483.5                  | 25.42          | Ave.                  | 36               | 1.1        | V           | 7.21                  | 32.63                        | 54                      | 21.37       |
| 9920.0                  | 32.06          | PK                    | 36               | 1.0        | H           | 19.38                 | 51.44                        | 74                      | 22.56       |
| 7440.0                  | 35.22          | PK                    | 122              | 1.2        | V           | 15.90                 | 51.12                        | 74                      | 22.88       |
| 4960.0                  | 37.36          | PK                    | 77               | 1.3        | H           | 12.50                 | 49.86                        | 74                      | 24.14       |
| 2349.9                  | 24.04          | Ave.                  | 13               | 1.2        | H           | 5.48                  | 29.52                        | 54                      | 24.48       |
| 2376.2                  | 23.13          | Ave.                  | 88               | 1.0        | H           | 5.48                  | 28.61                        | 54                      | 25.39       |
| 2376.2                  | 40.93          | PK                    | 88               | 1.0        | H           | 5.48                  | 46.41                        | 74                      | 27.59       |
| 2349.9                  | 40.57          | PK                    | 13               | 1.2        | H           | 5.48                  | 46.05                        | 74                      | 27.95       |

## FCC §15.247(a) (1)-CHANNEL SEPARATION TEST

### Applicable Standard

Frequency hopping systems shall have hopping channel carrier frequencies separated by a minimum of 25 kHz or the 20 dB bandwidth of the hopping channel, whichever is greater. Alternatively, frequency hopping systems operating in the 2400-2483.5 MHz band may have hopping channel carrier frequencies that are separated by 25 kHz or two-thirds of the 20 dB bandwidth of the hopping channel, whichever is greater provided the systems operate with an output power no greater than 125 mW.

### Test Procedure

1. Set the EUT in transmitting mode, maxhold the channel.
2. Set the adjacent channel of the EUT and maxhold another trace.
3. Measure the channel separation.

### Test Equipment List and Details

| Manufacturer    | Description       | Model | Serial Number | Calibration Date | Calibration Due Date |
|-----------------|-------------------|-------|---------------|------------------|----------------------|
| Rohde & Schwarz | EMI Test Receiver | ESCI  | 101122        | 2012-08-08       | 2013-08-07           |

\* **Statement of Traceability:** Bay Area Compliance Laboratories Corp. (Shenzhen) attests that all calibrations have been performed in accordance to requirements, traceable to National Primary Standards and International System of Units (SI).

### Test Data

#### Environmental Conditions

|                    |           |
|--------------------|-----------|
| Temperature:       | 25 °C     |
| Relative Humidity: | 50 %      |
| ATM Pressure:      | 100.1 kPa |

\* The testing was performed by Henry Ding on 2013-03-07.

EUT operation mode: Transmitting

Test Result: Compliance. Please refer to following tables and plots

| Mode                   | Channel  | Frequency (MHz) | Channel Separation (MHz) | ≥Limit (MHz) | Result |
|------------------------|----------|-----------------|--------------------------|--------------|--------|
| <b>BDR (GFSK)</b>      | Low      | 2402            | 1.002                    | 0.613        | Pass   |
|                        | Adjacent | 2403            |                          |              |        |
|                        | Middle   | 2441            | 1.002                    | 0.613        | Pass   |
|                        | Adjacent | 2442            |                          |              |        |
|                        | High     | 2480            | 1.002                    | 0.613        | Pass   |
|                        | Adjacent | 2479            |                          |              |        |
| <b>EDR (π/4-DQPSK)</b> | Low      | 2402            | 1.002                    | 0.812        | Pass   |
|                        | Adjacent | 2403            |                          |              |        |
|                        | Middle   | 2441            | 1.002                    | 0.812        | Pass   |
|                        | Adjacent | 2442            |                          |              |        |
|                        | High     | 2480            | 0.996                    | 0.812        | Pass   |
|                        | Adjacent | 2479            |                          |              |        |
| <b>EDR (8DPSK)</b>     | Low      | 2402            | 1.002                    | 0.816        | Pass   |
|                        | Adjacent | 2403            |                          |              |        |
|                        | Middle   | 2441            | 1.002                    | 0.829        | Pass   |
|                        | Adjacent | 2442            |                          |              |        |
|                        | High     | 2480            | 1.002                    | 0.835        | Pass   |
|                        | Adjacent | 2479            |                          |              |        |

Note: Limit = 20 dB bandwidth \*2/3

### BDR (GFSK): Low Channel

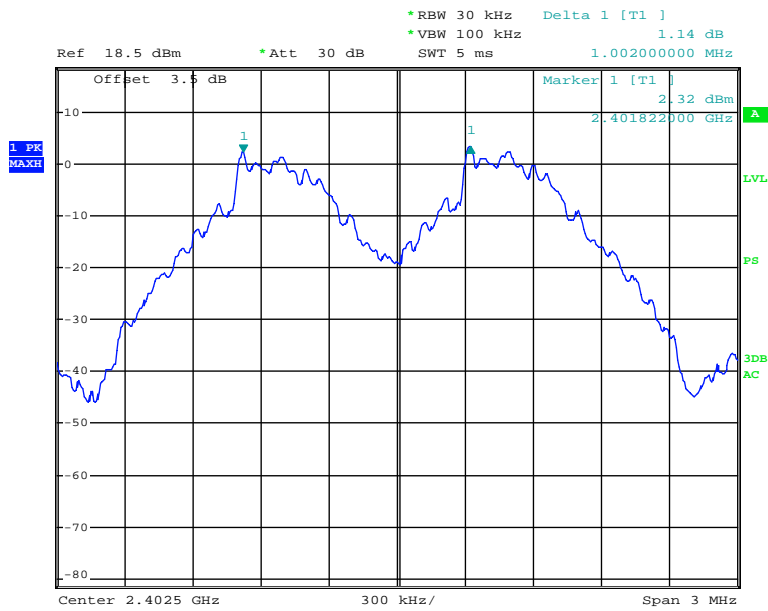

Date: 7.MAR.2013 12:00:28

### BDR (GFSK): Middle Channel

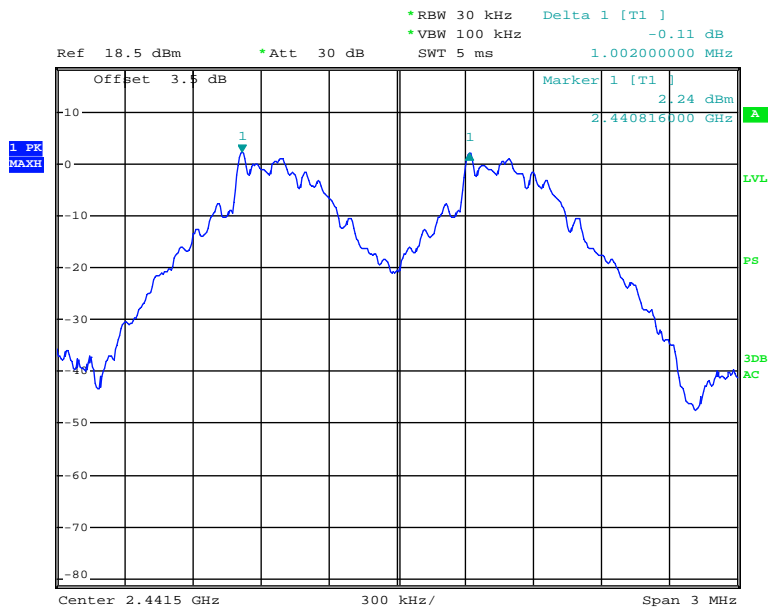

Date: 7.MAR.2013 12:01:18

### BDR (GFSK): High Channel

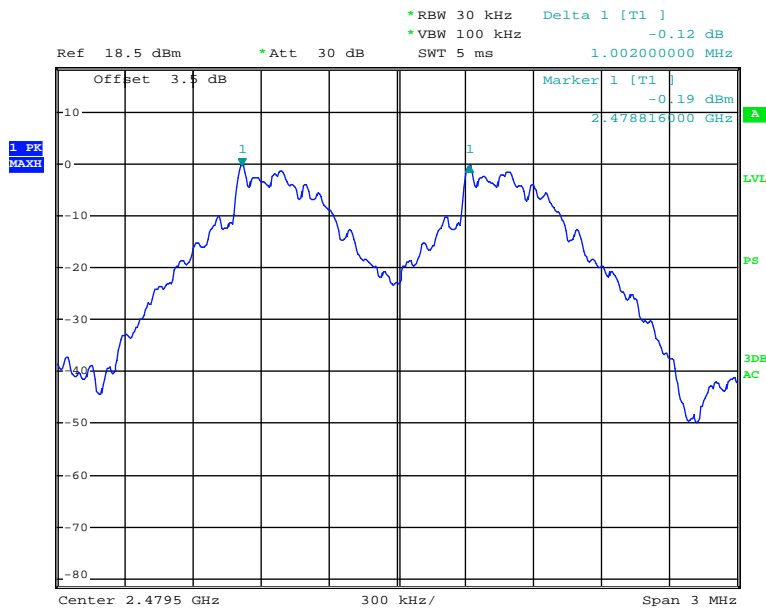

Date: 7.MAR.2013 12:02:13

### EDR ( $\pi/4$ -DQPSK): Low Channel

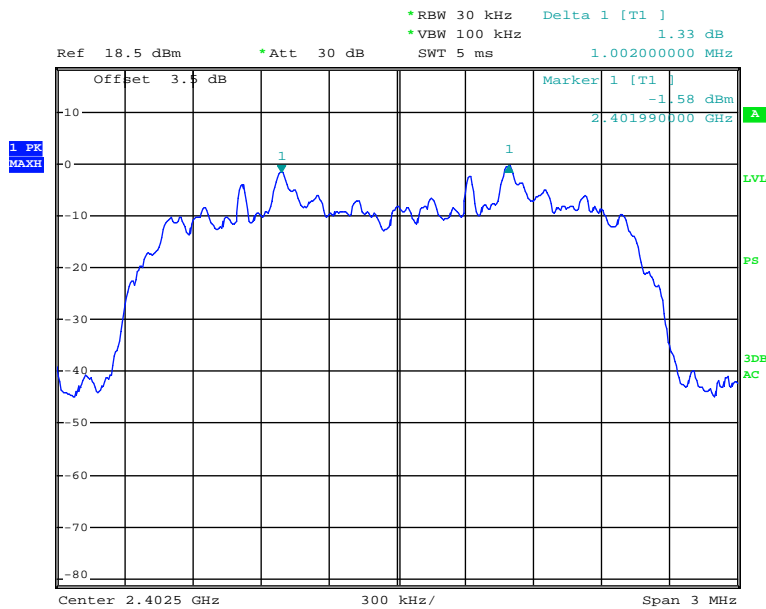

Date: 7.MAR.2013 12:41:47

### EDR ( $\pi/4$ -DQPSK): Middle Channel

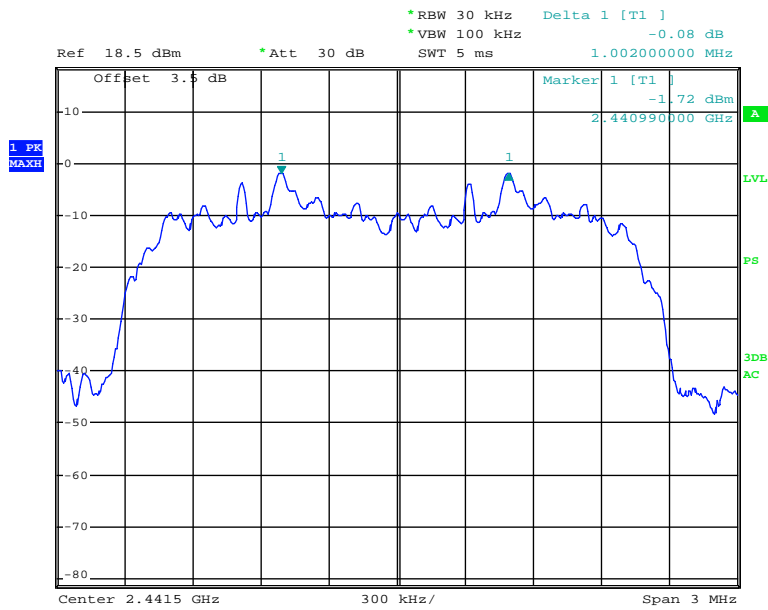

Date: 7.MAR.2013 12:40:33

### EDR ( $\pi/4$ -DQPSK): High Channel

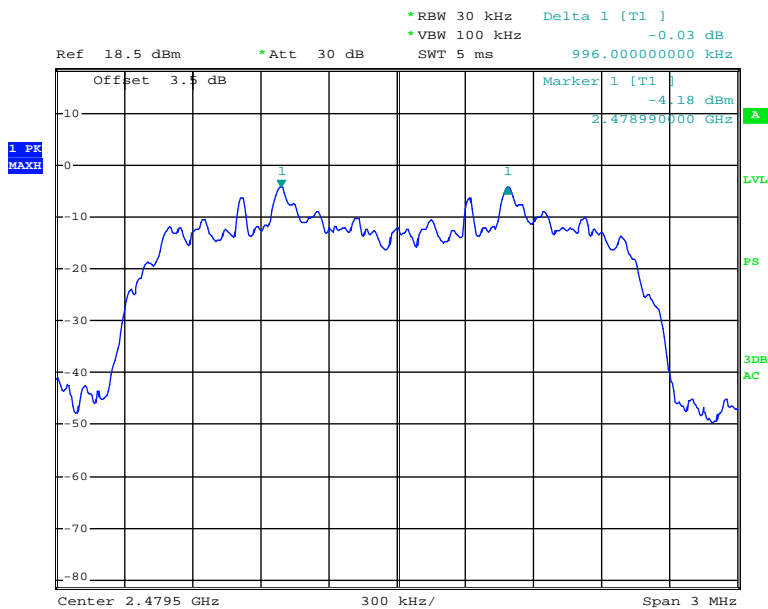

Date: 7.MAR.2013 12:39:28

### EDR (8DPSK): Low Channel

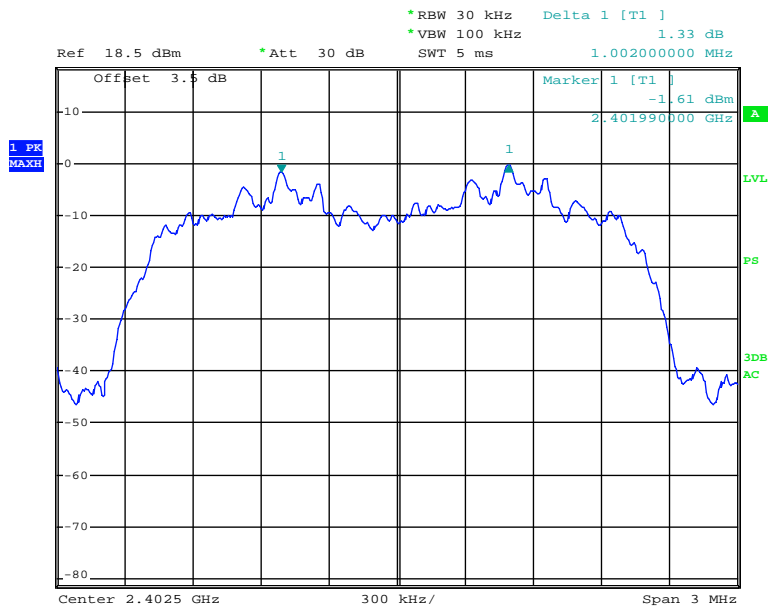

Date: 7.MAR.2013 12:56:51

### EDR (8DPSK): Middle Channel

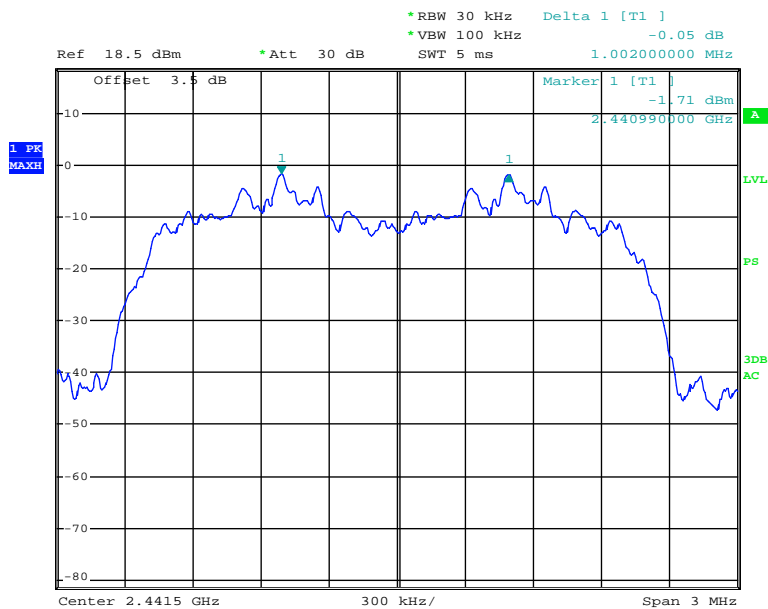

Date: 7.MAR.2013 12:56:01



### EDR (8DPSK): High Channel

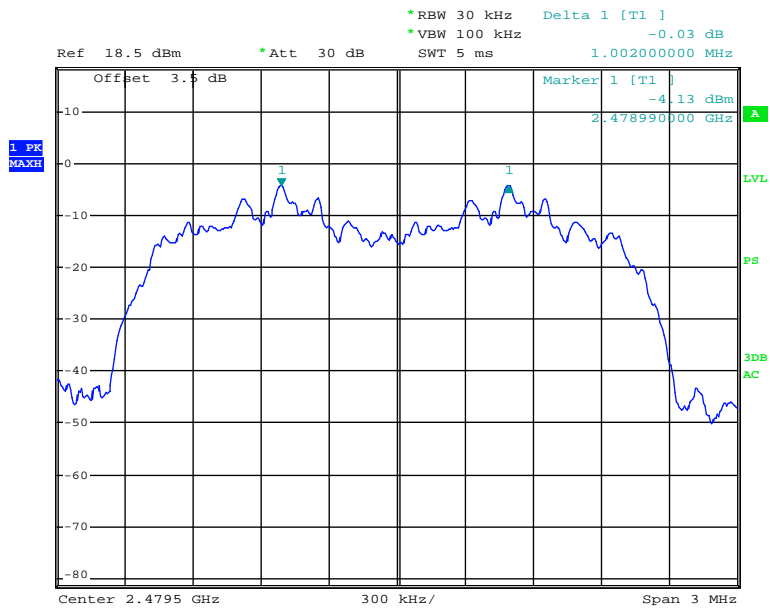

Date: 7.MAR.2013 12:55:08

## FCC §15.247(a) (1) – 20 dB EMISSION BANDWIDTH

### Applicable Standard

Alternatively, frequency hopping systems operating in the 2400–2483.5 MHz band may have hopping channel carrier frequencies that are separated by 25 kHz or two-thirds of the 20 dB bandwidth of the hopping channel, whichever is greater, provided the systems operate with an output power no greater than 125 mW.

### Test Procedure

1. Check the calibration of the measuring instrument using either an internal calibrator or a known signal from an external generator.
2. Position the EUT without connection to measurement instrument. Turn on the EUT and connect it to measurement instrument. Then set it to any one convenient frequency within its operating range. Set a reference level on the measuring instrument equal to the highest peak value.
3. Measure the frequency difference of two frequencies that were attenuated 20 dB from the reference level. Record the frequency difference as the emission bandwidth.
4. Repeat above procedures until all frequencies measured were complete.

### Test Equipment List and Details

| Manufacturer    | Description       | Model | Serial Number | Calibration Date | Calibration Due Date |
|-----------------|-------------------|-------|---------------|------------------|----------------------|
| Rohde & Schwarz | EMI Test Receiver | ESCI  | 101122        | 2012-08-08       | 2013-08-07           |

\* **Statement of Traceability:** Bay Area Compliance Laboratories Corp. (Shenzhen) attests that all calibrations have been performed in accordance to requirements, traceable to National Primary Standards and International System of Units (SI).

### Test Data

#### Environmental Conditions

|                    |                 |
|--------------------|-----------------|
| Temperature:       | 24~25 °C        |
| Relative Humidity: | 50~56 %         |
| ATM Pressure:      | 100.0~100.1 kPa |

\* The testing was performed by Henry Ding on 2013-03-07 and 2013-03-18.

EUT operation mode: Transmitting

Test Result: Compliance. Please refer to following tables and plots

| Mode                                  | Channel | Frequency (MHz) | 20 dB Bandwidth (MHz) |
|---------------------------------------|---------|-----------------|-----------------------|
| <b>BDR (GFSK)</b>                     | Low     | 2402            | 0.920                 |
|                                       | Middle  | 2441            | 0.920                 |
|                                       | High    | 2480            | 0.920                 |
| <b>EDR (<math>\pi/4</math>-DQPSK)</b> | Low     | 2402            | 1.218                 |
|                                       | Middle  | 2441            | 1.218                 |
|                                       | High    | 2480            | 1.218                 |
| <b>EDR (8DPSK)</b>                    | Low     | 2402            | 1.224                 |
|                                       | Middle  | 2441            | 1.244                 |
|                                       | High    | 2480            | 1.252                 |

**BDR (GFSK): Low Channel**

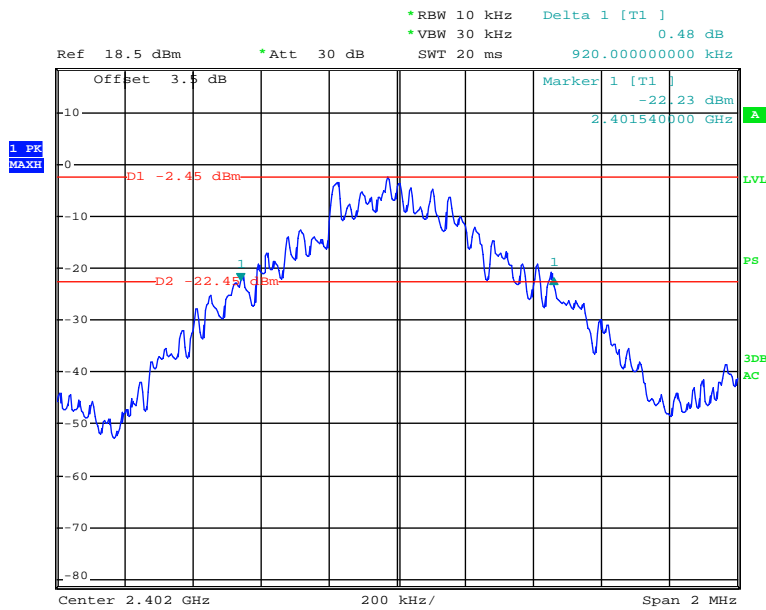

Date: 7.MAR.2013 11:54:15

### BDR (GFSK): Middle Channel

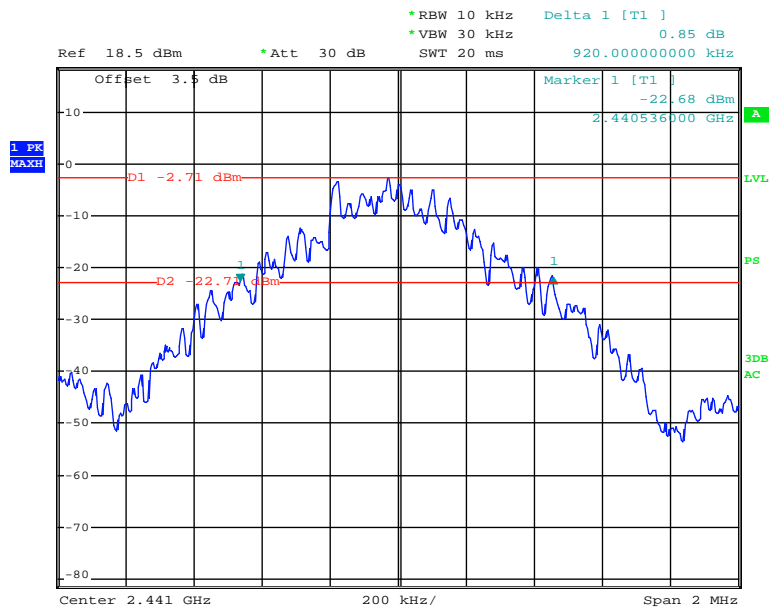

Date: 7.MAR.2013 11:56:12

### BDR (GFSK): High Channel

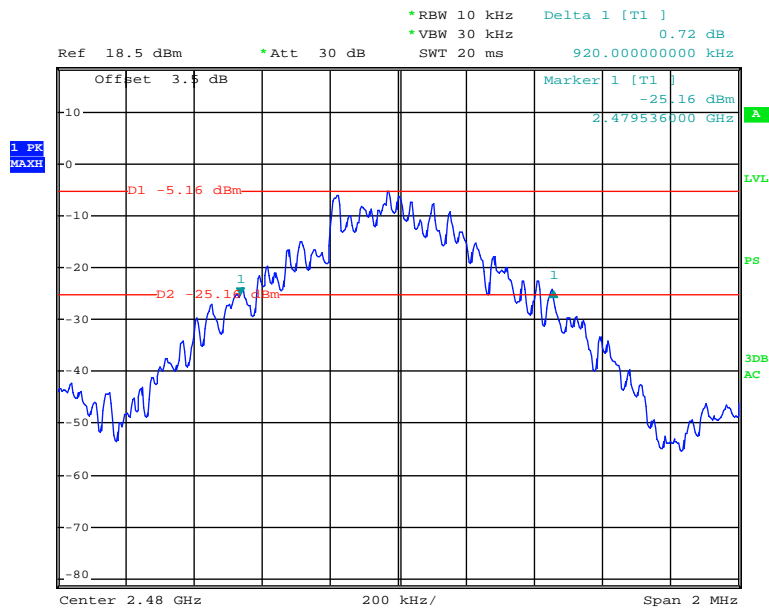

Date: 7.MAR.2013 11:57:12

### EDR ( $\pi/4$ -DQPSK): Low Channel

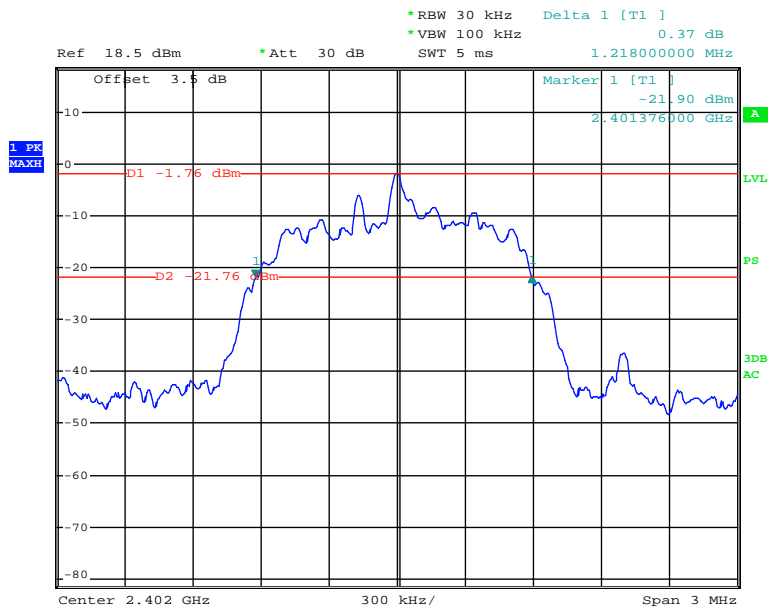

Date: 18.MAR.2013 18:20:28

### EDR ( $\pi/4$ -DQPSK): Middle Channel

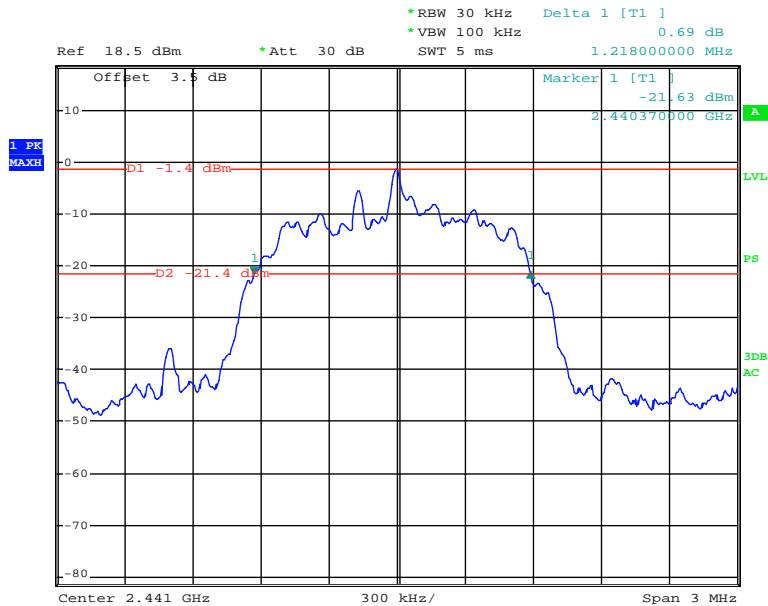

Date: 18.MAR.2013 18:21:48

### EDR ( $\pi/4$ -DQPSK): High Channel

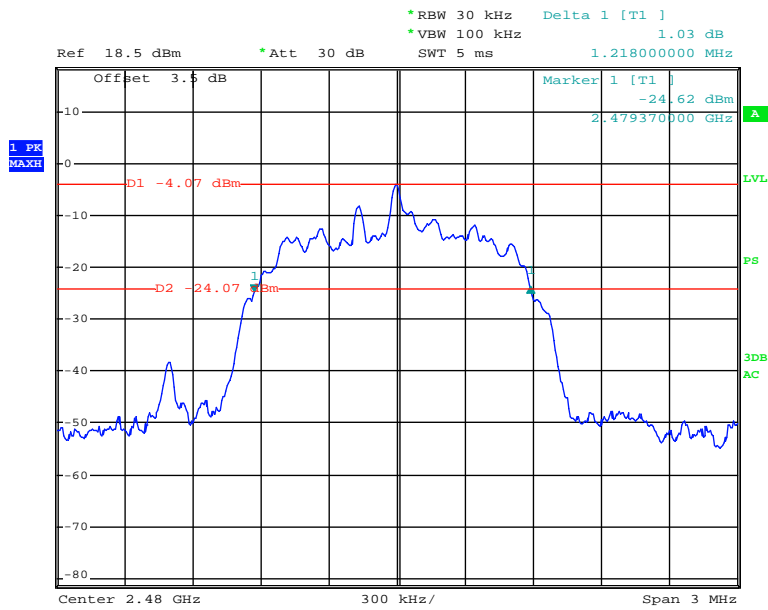

Date: 18.MAR.2013 18:24:40

### EDR (8DPSK): Low Channel

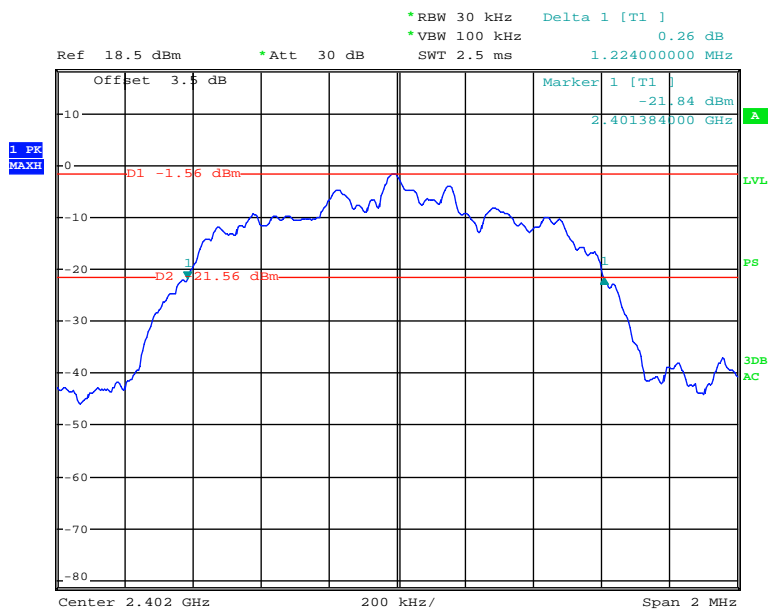

Date: 7.MAR.2013 12:43:43

**EDR (8DPSK): Middle Channel**

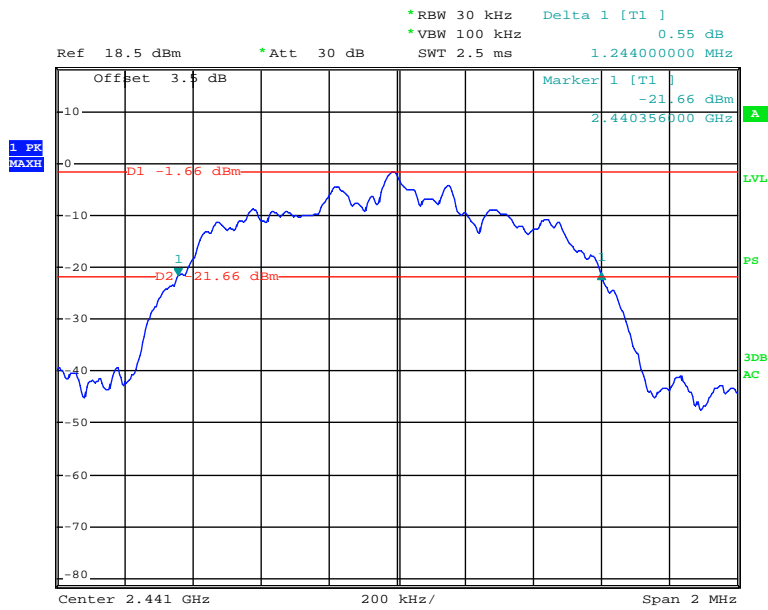

Date: 7.MAR.2013 12:44:59

**EDR (8DPSK): High Channel**

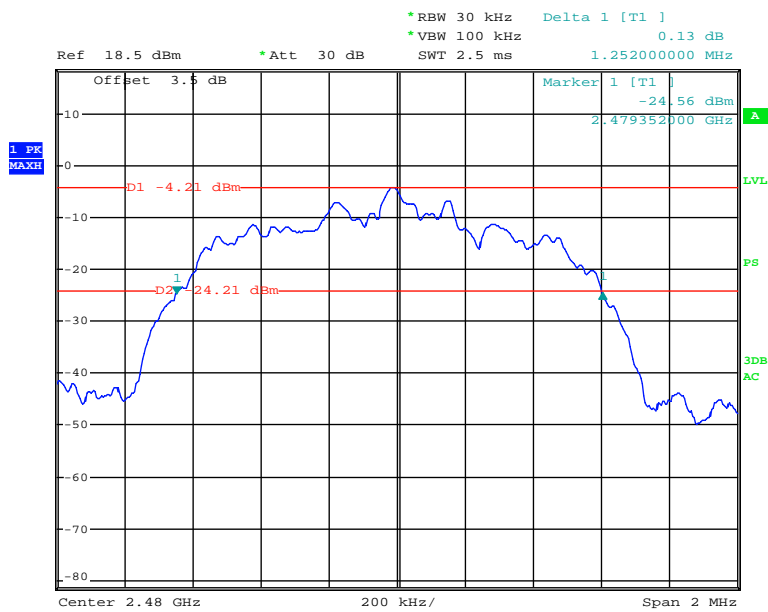

Date: 7.MAR.2013 12:46:12

## **FCC §15.247(a) (1) (iii)-QUANTITY OF HOPPING CHANNEL TEST**

### **Applicable Standard**

Frequency hopping systems in the 2400–2483.5 MHz band shall use at least 15 channels. The average time of occupancy on any channel shall not be greater than 0.4 seconds within a period of 0.4 seconds multiplied by the number of hopping channels employed. Frequency hopping systems may avoid or suppress transmissions on a particular hopping frequency provided that a minimum of 15 channels are used.

### **Test Procedure**

1. Check the calibration of the measuring instrument (SA) using either an internal calibrator or a known signal from an external generator.
2. Set the EUT in hopping mode from first channel to last.
3. By using the max-hold function record the quantity of the channel.

### **Test Equipment List and Details**

| <b>Manufacturer</b> | <b>Description</b> | <b>Model</b> | <b>Serial Number</b> | <b>Calibration Date</b> | <b>Calibration Due Date</b> |
|---------------------|--------------------|--------------|----------------------|-------------------------|-----------------------------|
| Rohde & Schwarz     | EMI Test Receiver  | ESCI         | 101122               | 2012-08-08              | 2013-08-07                  |

\* **Statement of Traceability:** Bay Area Compliance Laboratories Corp. (Shenzhen) attests that all calibrations have been performed in accordance to requirements, traceable to National Primary Standards and International System of Units (SI).

### **Test Data**

#### **Environmental Conditions**

|                           |           |
|---------------------------|-----------|
| <b>Temperature:</b>       | 25 °C     |
| <b>Relative Humidity:</b> | 50 %      |
| <b>ATM Pressure:</b>      | 100.1 kPa |

*The testing was performed by Henry Ding on 2013-03-07.*

*EUT operation mode: Transmitting*

*Test Result: Compliance. Please refer to following tables and plots*



| Mode            | Frequency Range (MHz) | Number of Hopping Channel (CH) | Limit (CH) |
|-----------------|-----------------------|--------------------------------|------------|
| BDR (GFSK)      | 2400-2483.5           | 79                             | ≥15        |
| EDR (π/4-DQPSK) | 2400-2483.5           | 79                             | ≥15        |
| EDR (8DPSK)     | 2400-2483.5           | 79                             | ≥15        |

**BDR (GFSK): Number of Hopping Channels**

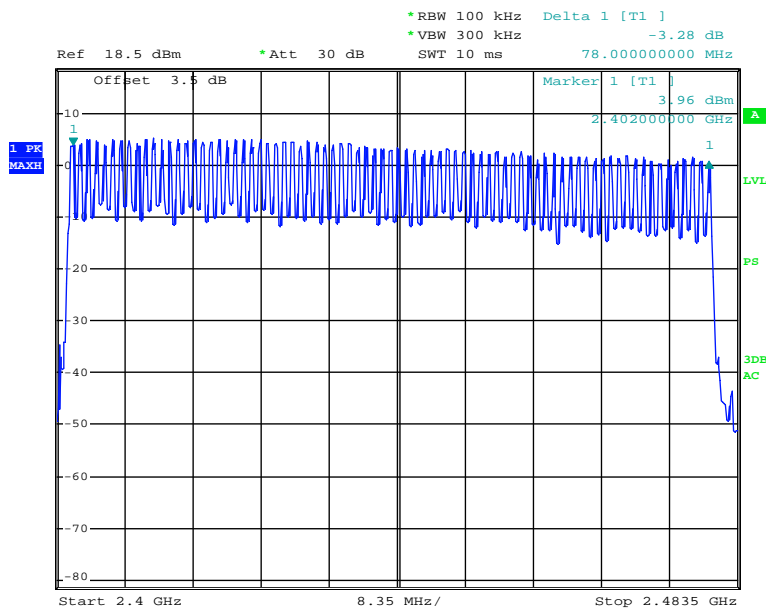

Date: 7.MAR.2013 11:51:42

### EDR ( $\pi/4$ -DQPSK): Number of Hopping Channels

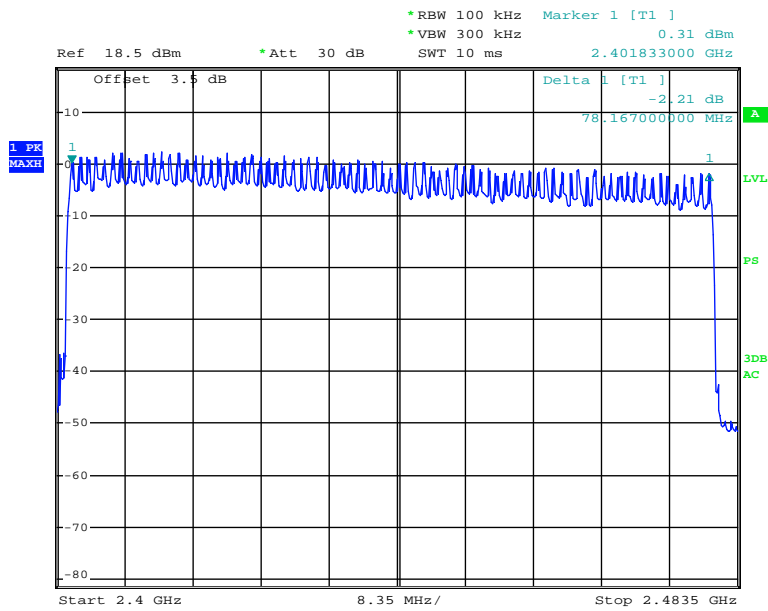

Date: 7.MAR.2013 12:24:52

### (8DPSK): Number of Hopping Channels

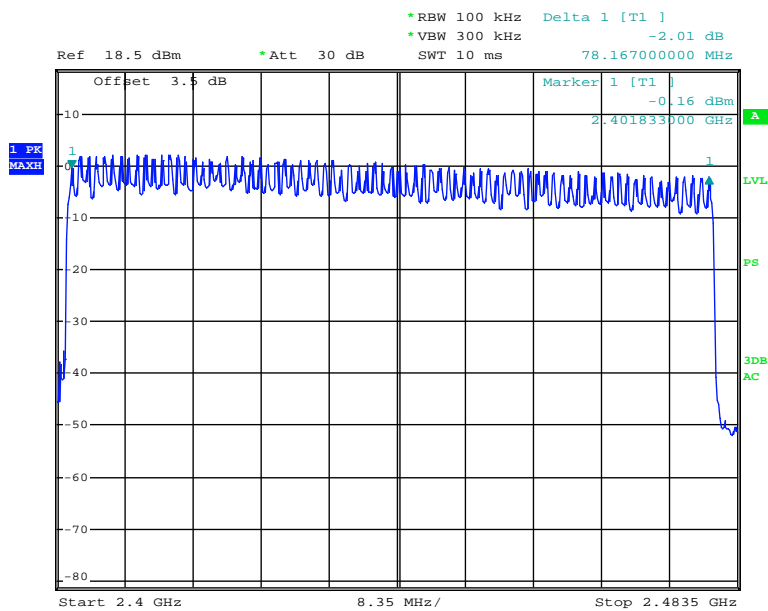

Date: 7.MAR.2013 12:49:49

## **FCC §15.247(a) (1) (iii) -TIME OF OCCUPANCY (DWELL TIME)**

### **Applicable Standard**

Frequency hopping systems in the 2400-2483.5 MHz shall use at least 15 channels. The average time of occupancy on any channel shall not be greater than 0.4 seconds within a period of 0.4 seconds multiplied by the number of hopping channels employed. Frequency hopping systems may avoid or suppress transmissions on a particular hopping frequency provided that a minimum of 15 channels are used.

### **Test Procedure**

The EUT was worked in channel hopping; Spectrum SPAN was set as 0. Sweep was set as 0.4 X channel no. (s), the quantity of pulse was get from single sweep. In addition, the time of single pulses was tested.

Dwell time = Pulse time\*hop rate/number of hopping channels\*31.6S

Hop rate=1600/S

### **Test Equipment List and Details**

| Manufacturer    | Description       | Model | Serial Number | Calibration Date | Calibration Due Date |
|-----------------|-------------------|-------|---------------|------------------|----------------------|
| Rohde & Schwarz | EMI Test Receiver | ESCI  | 101122        | 2012-08-08       | 2013-08-07           |

\* **Statement of Traceability:** Bay Area Compliance Laboratories Corp. (Shenzhen) attests that all calibrations have been performed in accordance to requirements, traceable to National Primary Standards and International System of Units (SI).

### **Test Data**

#### **Environmental Conditions**

|                           |           |
|---------------------------|-----------|
| <b>Temperature:</b>       | 25 °C     |
| <b>Relative Humidity:</b> | 50 %      |
| <b>ATM Pressure:</b>      | 100.1 kPa |

*The testing was performed by Henry Ding on 2013-03-07.*

*EUT operation mode: Transmitting*

*Test Result: Compliance. Please refer to following tables and plots*

| Mode  |   | Channel | Pulse Width (ms) | Dwell Time (S) | Limit (S) | Result |      |
|---|---|---------|------------------|----------------|-----------|--------|------|
| BDR (GFSK)  | DH 1  | Low     | 0.426            | 0.1363         | 0.4       | Pass   |      |
|   |   | Middle  | 0.426            | 0.1363         | 0.4       | Pass   |      |
|   |   | High    | 0.426            | 0.1363         | 0.4       | Pass   |      |
|   | Note: DH1:Dwell time = Pulse time*(1600/2/79)*31.6S |         |                  |                |           |        |      |
|   | DH 3  | Low     | 1.704            | 0.2726         | 0.4       | Pass   |      |
|   |   | Middle  | 1.704            | 0.2726         | 0.4       | Pass   |      |
|   |   | High    | 1.704            | 0.2726         | 0.4       | Pass   |      |
|   | Note: DH3:Dwell time = Pulse time*(1600/4/79)*31.6S |         |                  |                |           |        |      |
|   | DH 5  | Low     | 2.954            | 0.3151         | 0.4       | Pass   |      |
|   |   | Middle  | 2.954            | 0.3151         | 0.4       | Pass   |      |
|   |   | High    | 2.954            | 0.3151         | 0.4       | Pass   |      |
|   | Note: DH5:Dwell time = Pulse time*(1600/6/79)*31.6S |         |                  |                |           |        |      |
|   | EDR (π/4-DQPSK)                                     | DH 1    | Low              | 0.444          | 0.1421    | 0.4    | Pass |
| Middle  |   |         | 0.438            | 0.1402         | 0.4       | Pass   |      |
| High  |   |         | 0.440            | 0.1408         | 0.4       | Pass   |      |
| Note: DH1:Dwell time = Pulse time*(1600/2/79)*31.6S |   |         |                  |                |           |        |      |
| DH 3  |   | Low     | 1.706            | 0.2730         | 0.4       | Pass   |      |
|   |   | Middle  | 1.700            | 0.2720         | 0.4       | Pass   |      |
|   |   | High    | 1.712            | 0.2739         | 0.4       | Pass   |      |
| Note: DH3:Dwell time = Pulse time*(1600/4/79)*31.6S |   |         |                  |                |           |        |      |
| DH 5  |   | Low     | 2.986            | 0.3185         | 0.4       | Pass   |      |
|   |   | Middle  | 2.956            | 0.3153         | 0.4       | Pass   |      |
|   |   | High    | 2.956            | 0.3153         | 0.4       | Pass   |      |
| Note: DH5:Dwell time = Pulse time*(1600/6/79)*31.6S |   |         |                  |                |           |        |      |
| EDR (8DPSK)   |   | DH 1    | Low              | 0.442          | 0.1414    | 0.4    | Pass |
|   | Middle  |         | 0.442            | 0.1414         | 0.4       | Pass   |      |
|   | High  |         | 0.442            | 0.1414         | 0.4       | Pass   |      |
|   | Note: DH1:Dwell time = Pulse time*(1600/2/79)*31.6S |         |                  |                |           |        |      |
|   | DH 3  | Low     | 1.708            | 0.2733         | 0.4       | Pass   |      |
|   |   | Middle  | 1.702            | 0.2723         | 0.4       | Pass   |      |
|   |   | High    | 1.702            | 0.2723         | 0.4       | Pass   |      |
|   | Note: DH3:Dwell time = Pulse time*(1600/4/79)*31.6S |         |                  |                |           |        |      |
|   | DH 5  | Low     | 2.958            | 0.3155         | 0.4       | Pass   |      |
|   |   | Middle  | 2.958            | 0.3155         | 0.4       | Pass   |      |
|   |   | High    | 2.958            | 0.3155         | 0.4       | Pass   |      |
|   | Note: DH5:Dwell time = Pulse time*(1600/6/79)*31.6S |         |                  |                |           |        |      |

**BDR (GFSK):**

**Pulse time, Low Channel, DH1**

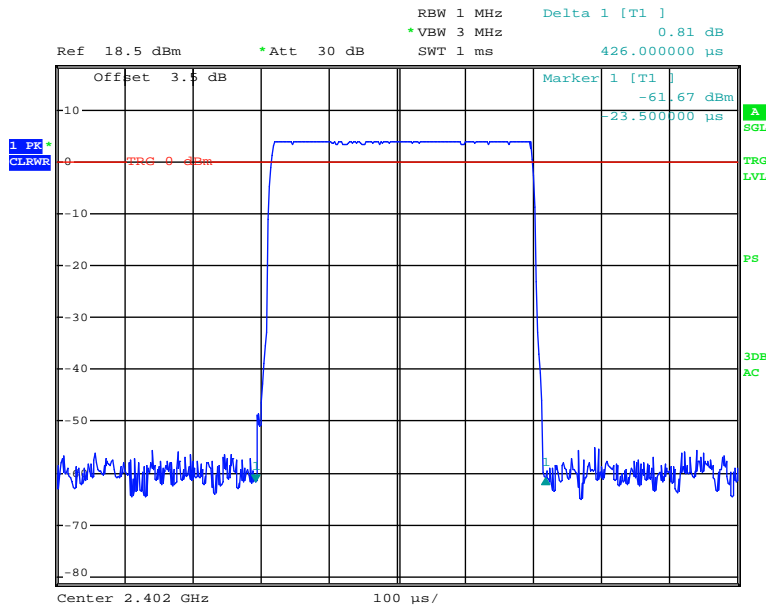

Date: 7.MAR.2013 12:08:59

**Pulse time, Middle Channel, DH1**

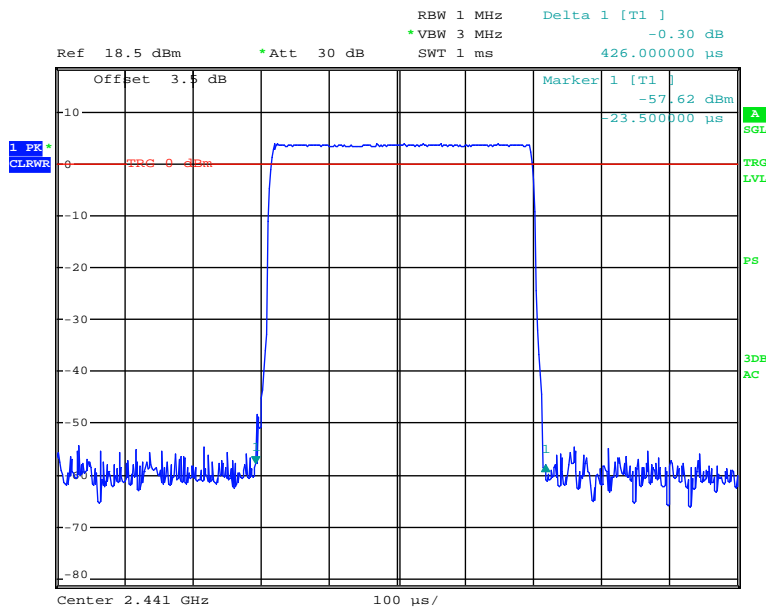

Date: 7.MAR.2013 12:09:32

### Pulse time, High Channel, DH1

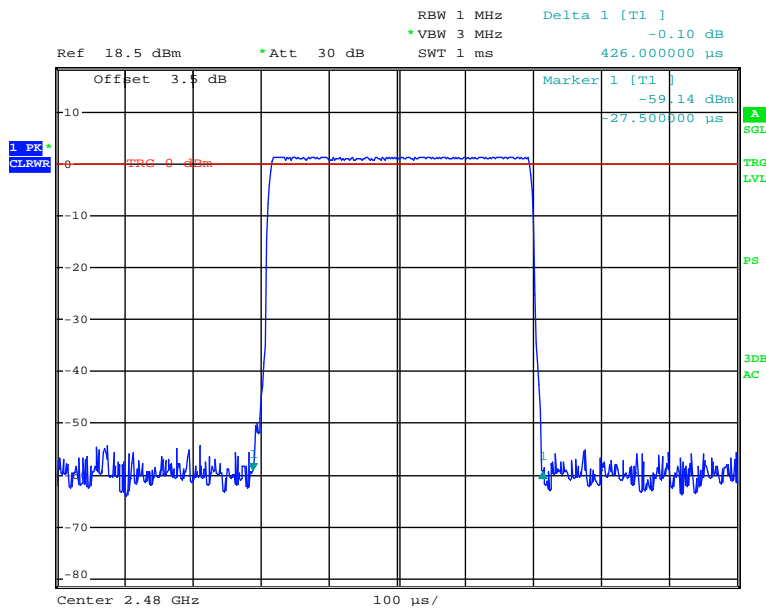

Date: 7.MAR.2013 12:10:18

### Pulse time, Low Channel, DH3

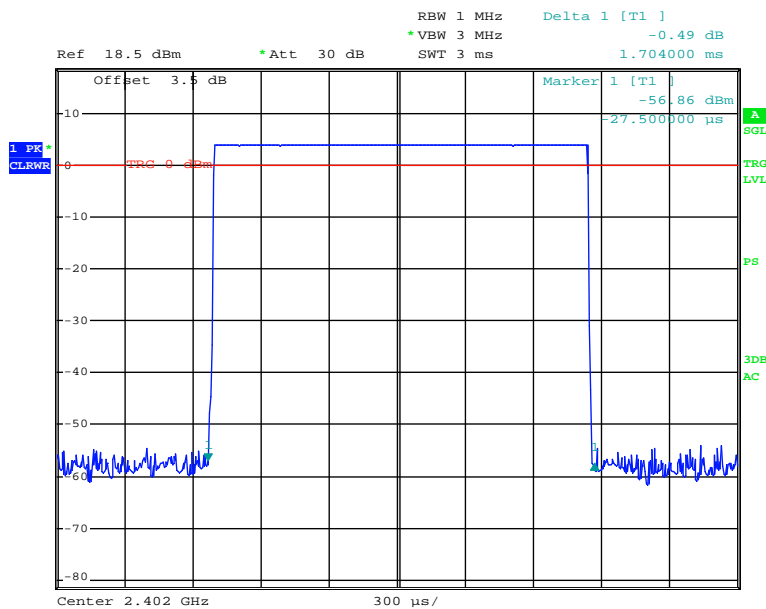

Date: 7.MAR.2013 12:12:32

### Pulse time, Middle Channel, DH3

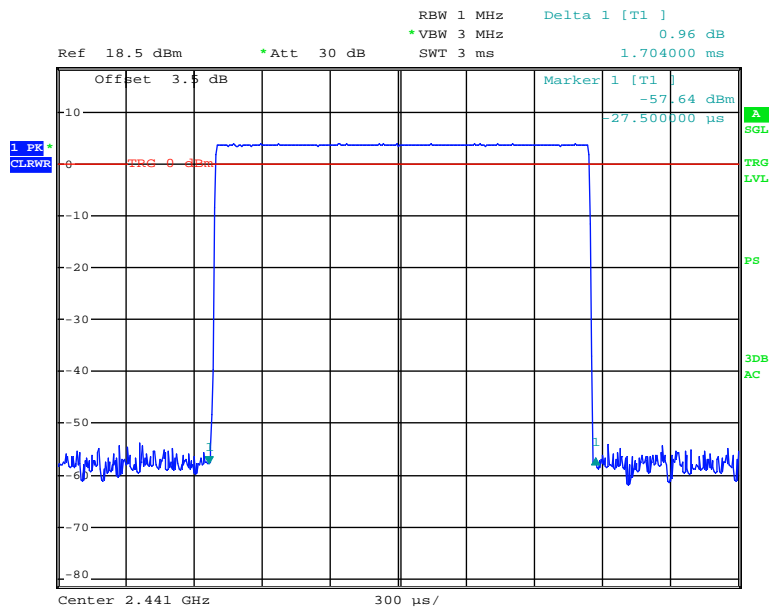

Date: 7.MAR.2013 12:12:05

### Pulse time, High Channel, DH3

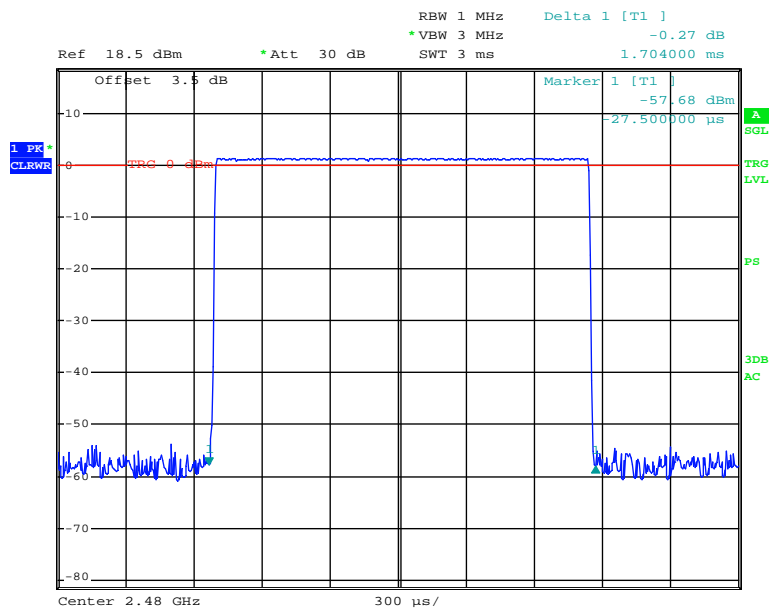

Date: 7.MAR.2013 12:11:48

### Pulse time, Low Channel, DH5

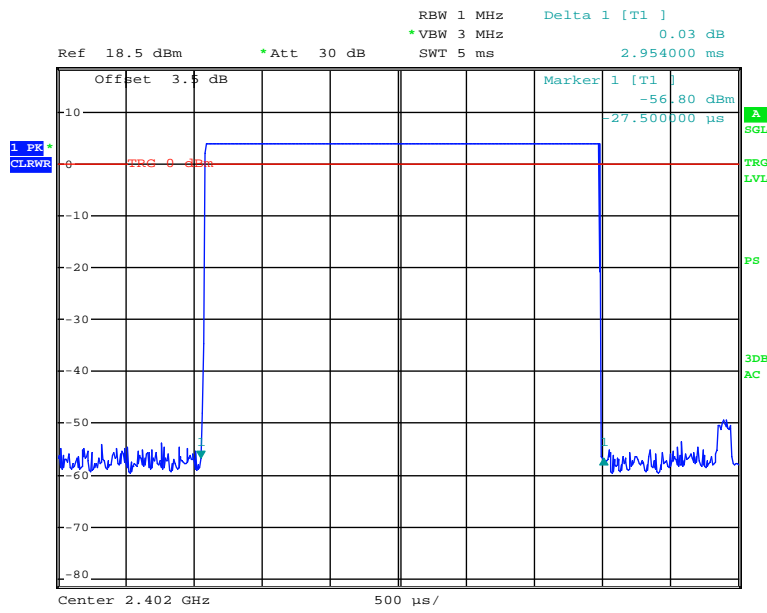

Date: 7.MAR.2013 12:13:43

### Pulse time, Middle Channel, DH5

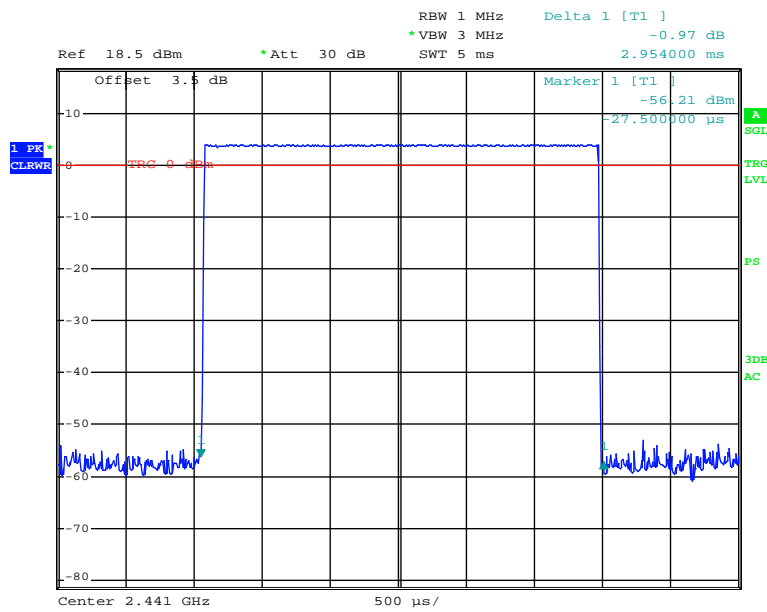

Date: 7.MAR.2013 12:14:01



### Pulse time, High Channel, DH5

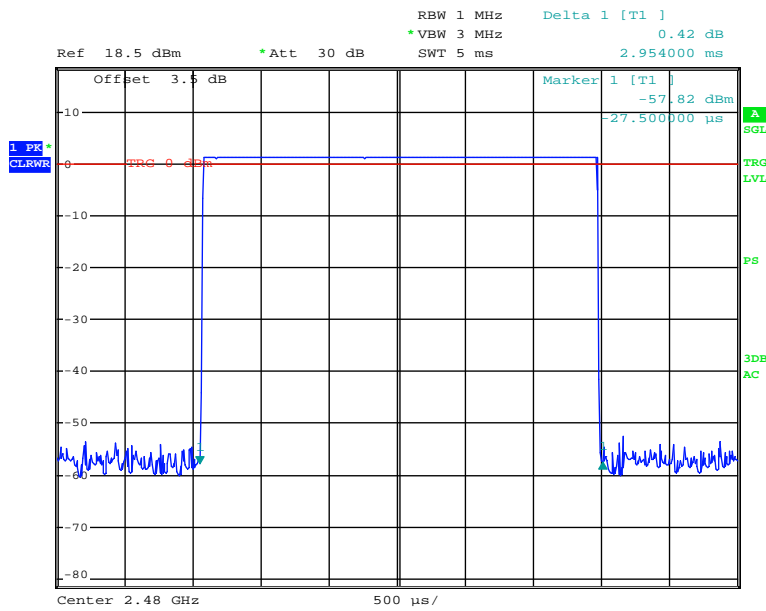

Date: 7.MAR.2013 12:14:15

### EDR ( $\pi/4$ -DQPSK):

### Pulse time, Low Channel, DH1

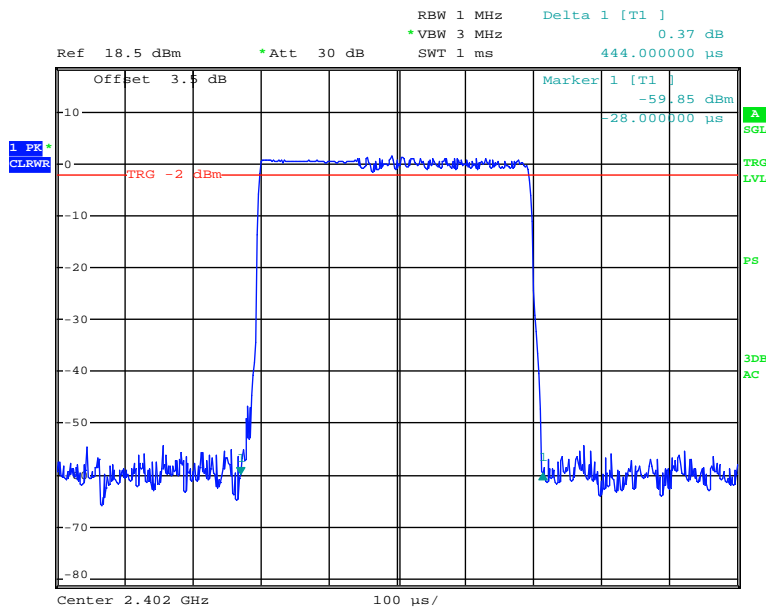

Date: 7.MAR.2013 12:27:16

### Pulse time, Middle Channel, DH1

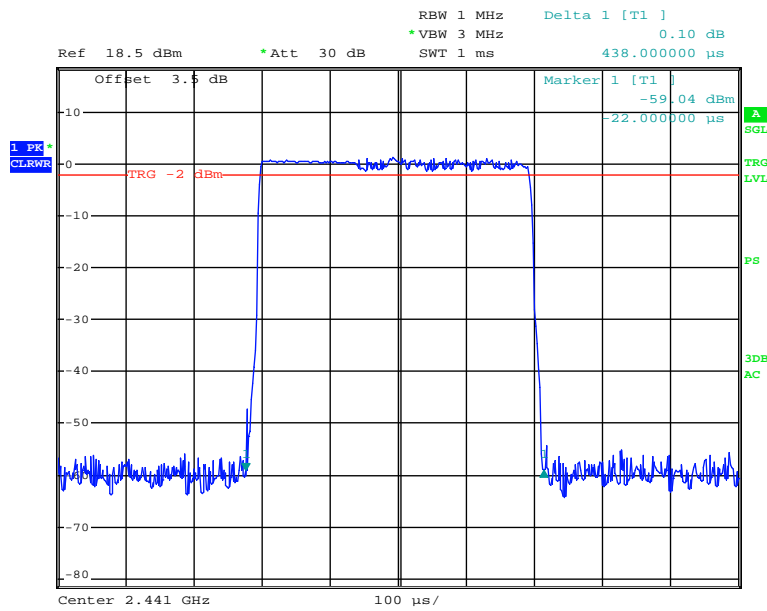

Date: 7.MAR.2013 12:28:02

### Pulse time, High Channel, DH1

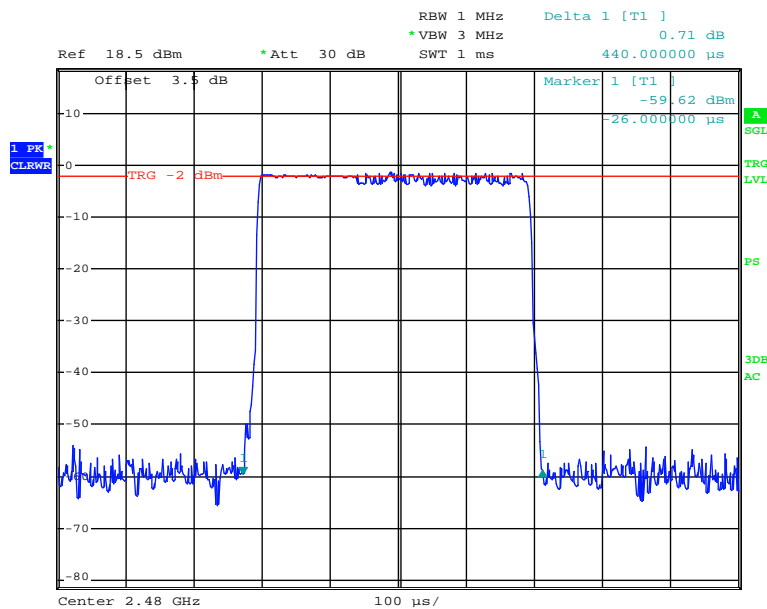

Date: 7.MAR.2013 12:28:38

### Pulse time, Low Channel, DH3

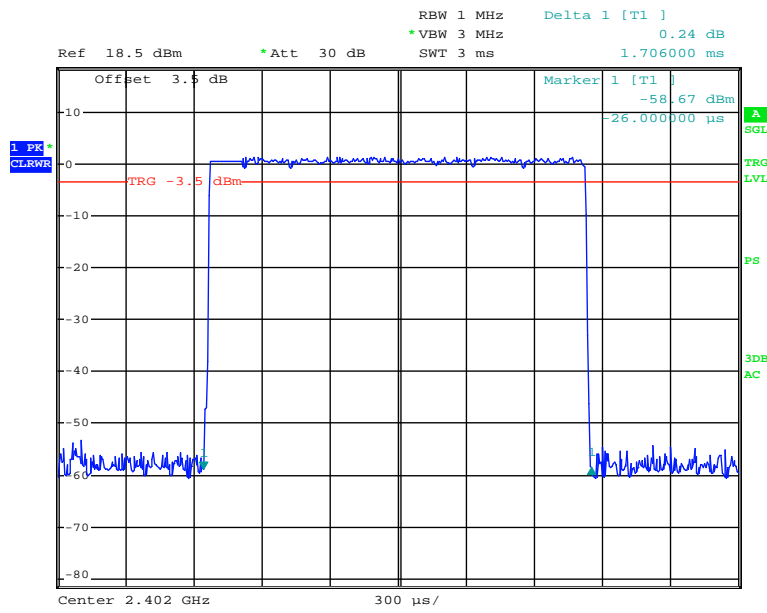

Date: 7.MAR.2013 12:30:49

### Pulse time, Middle Channel, DH3

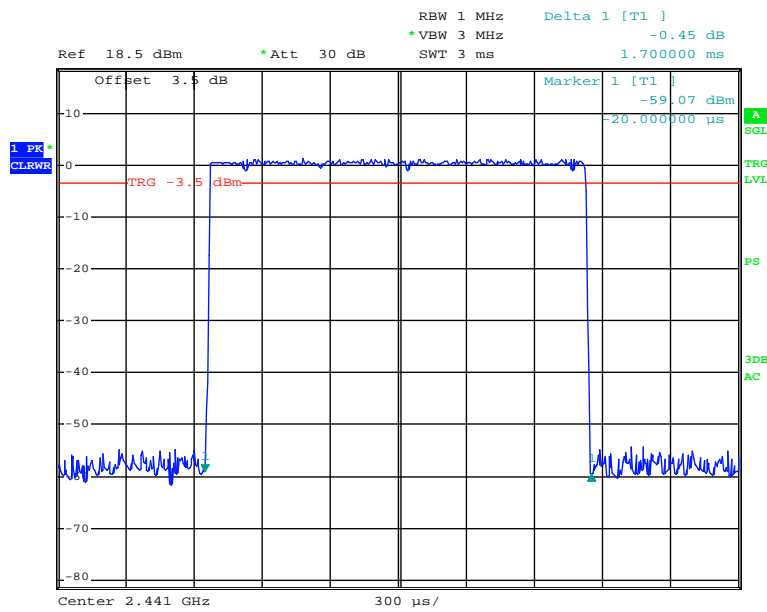

Date: 7.MAR.2013 12:30:13

### Pulse time, High Channel, DH3

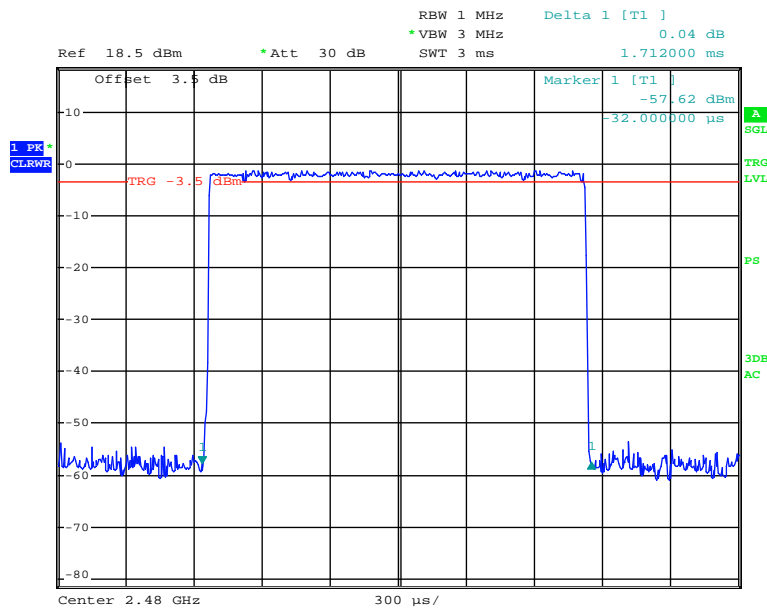

Date: 7.MAR.2013 12:29:50

### Pulse time, Low Channel, DH5

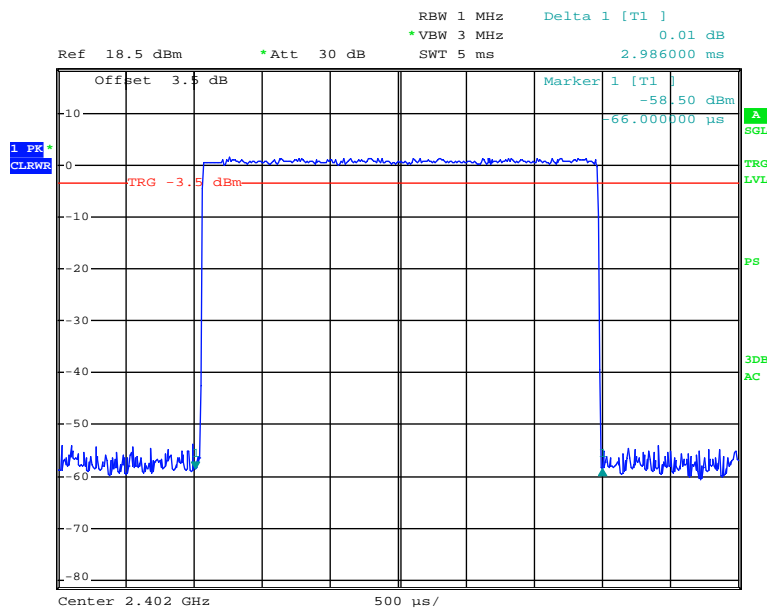

Date: 7.MAR.2013 12:31:49

### Pulse time, Middle Channel, DH5

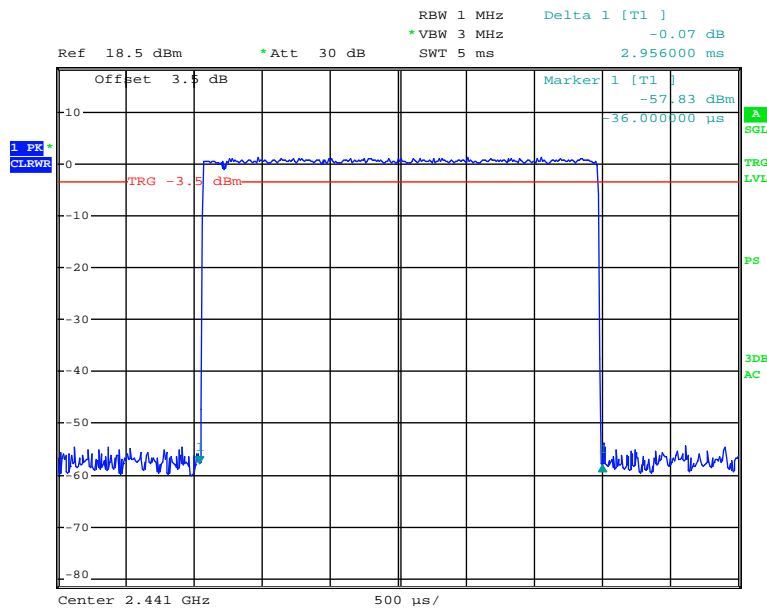

Date: 7.MAR.2013 12:32:50

### Pulse time, High Channel, DH5

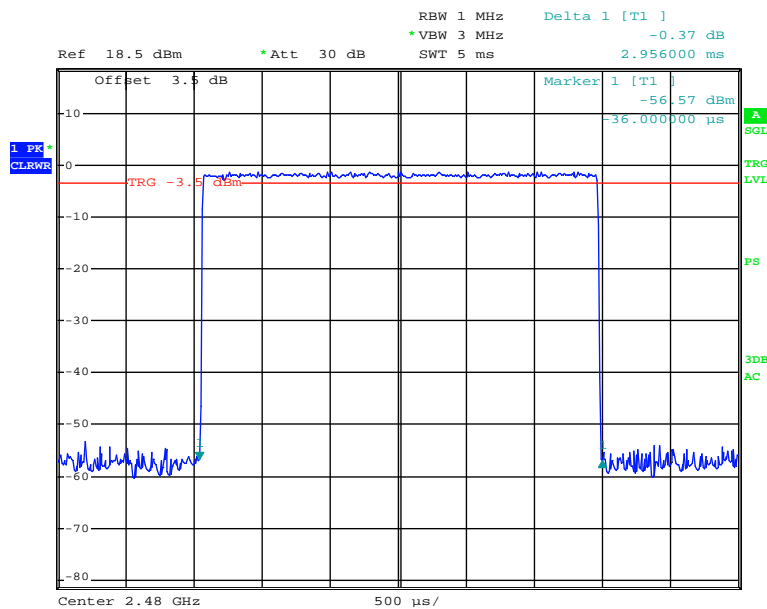

Date: 7.MAR.2013 12:33:06

**EDR (8DPSK):**

**Pulse time, Low Channel, DH1**

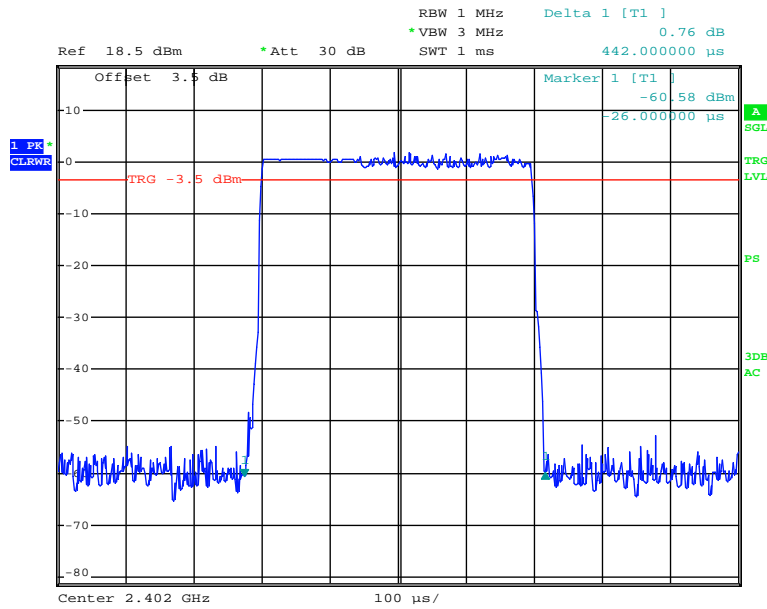

Date: 7.MAR.2013 12:58:10

**Pulse time, Middle Channel, DH1**

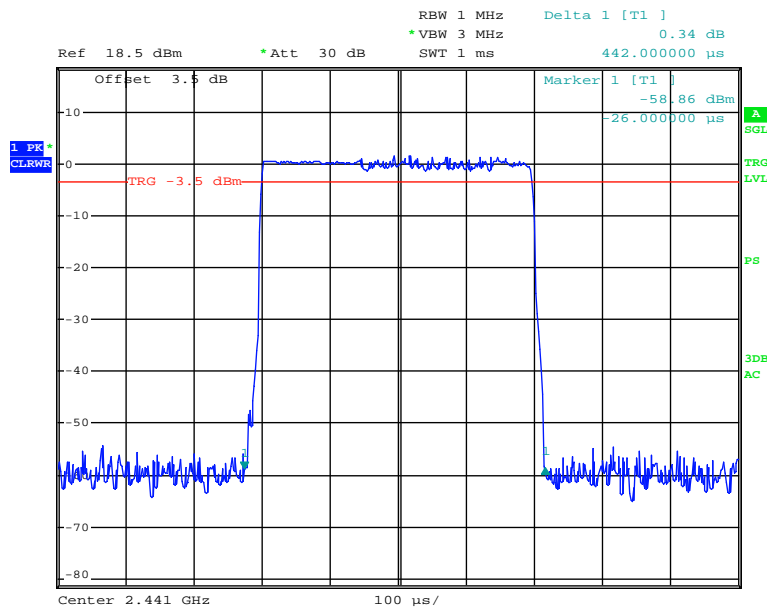

Date: 7.MAR.2013 12:58:40

### Pulse time, High Channel, DH1

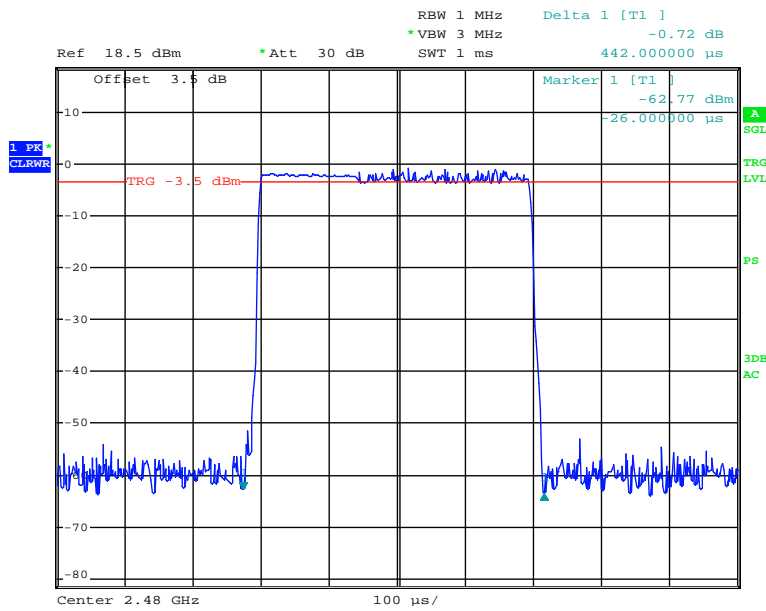

Date: 7.MAR.2013 12:58:57

### Pulse time, Low Channel, DH3

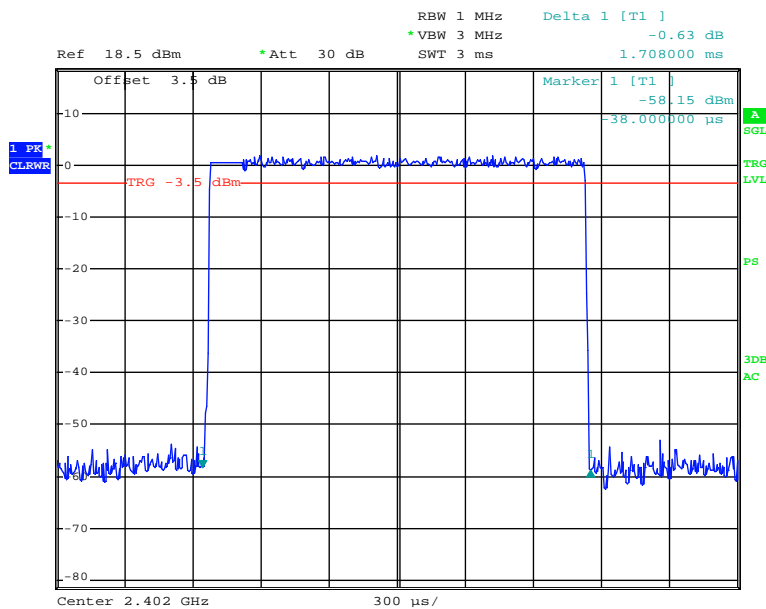

Date: 7.MAR.2013 13:01:15

### Pulse time, Middle Channel, DH3

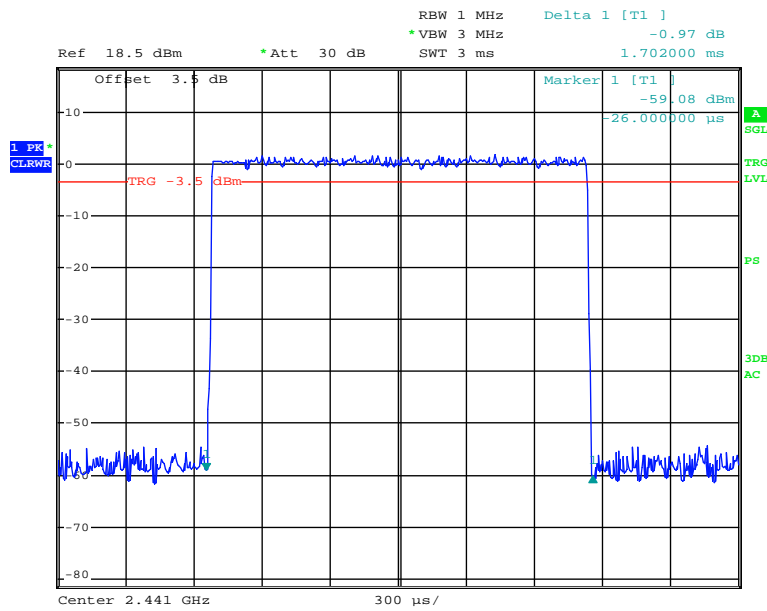

Date: 7.MAR.2013 13:00:51

### Pulse time, High Channel, DH3

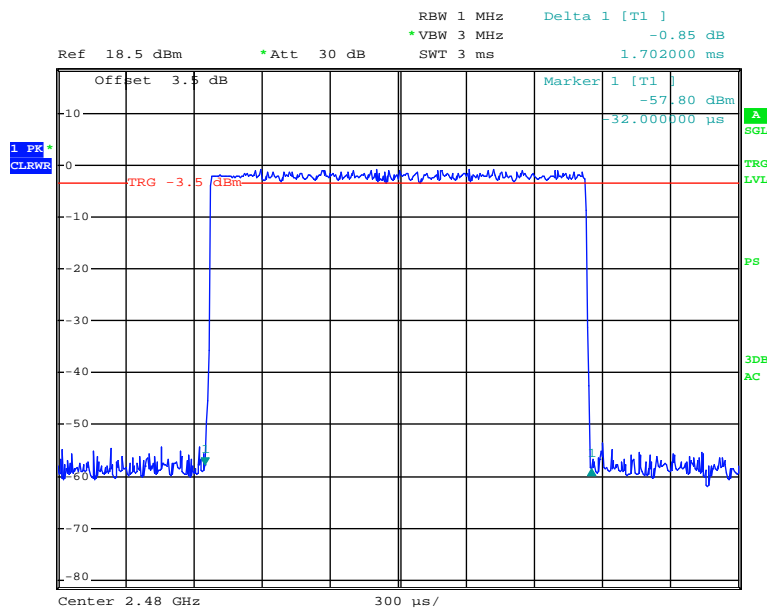

Date: 7.MAR.2013 13:00:05



### Pulse time, Low Channel, DH5

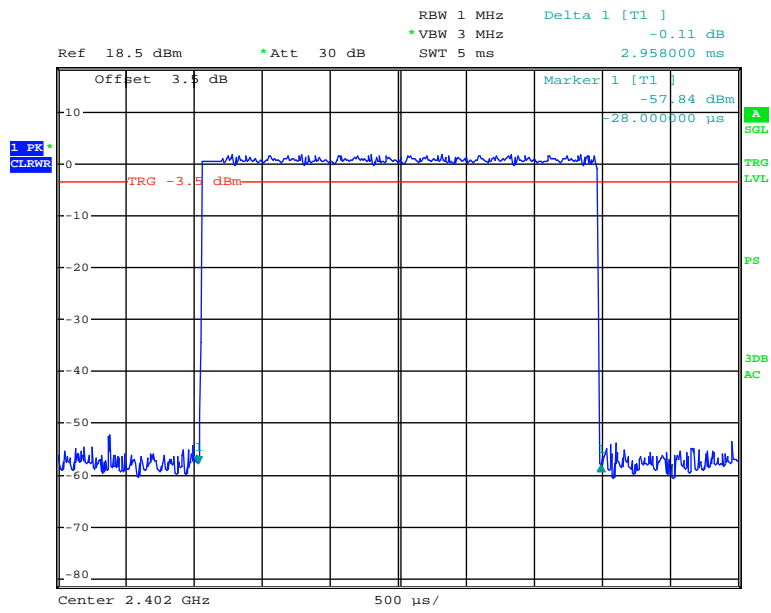

Date: 7.MAR.2013 13:02:19

### Pulse time, Middle Channel, DH5

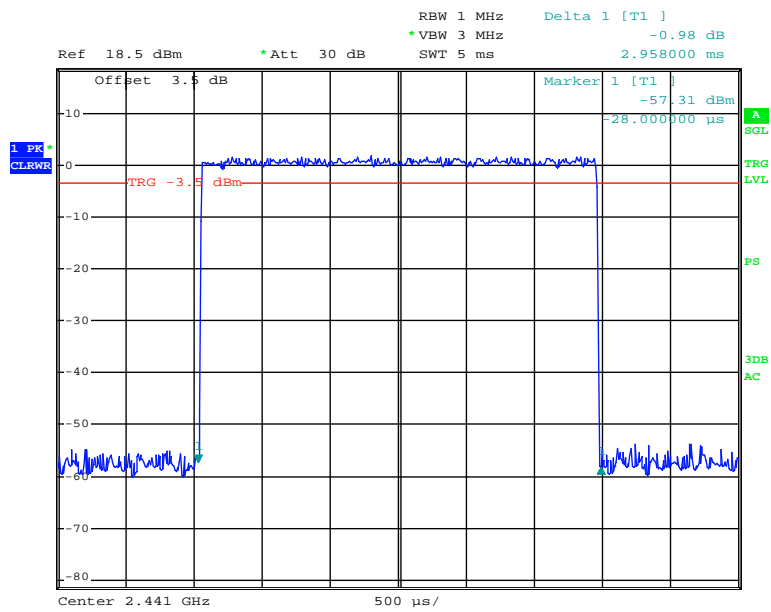

Date: 7.MAR.2013 13:02:45

### Pulse time, High Channel, DH5

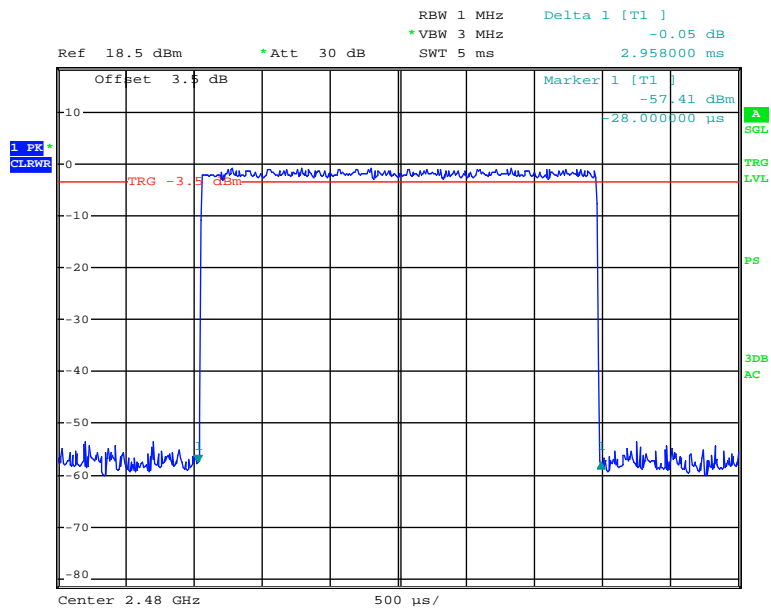

Date: 7.MAR.2013 13:03:02

## **FCC §15.247(b) (1) - PEAK OUTPUT POWER MEASUREMENT**

### **Applicable Standard**

According to §15.247(b) (1), for frequency hopping systems operating in the 2400–2483.5 MHz band employing at least 75 non-overlapping hopping channels, and all frequency hopping systems in the 5725–5850 MHz band: 1 watt. And for all other frequency hopping systems in the 2400–2483.5 MHz band: 0.125 watts.

### **Test Procedure**

1. Place the EUT on a bench and set in transmitting mode.
2. Remove the antenna from the EUT and then connect a low loss RF cable from the antenna port to an EMI test receiver.
3. Add a correction factor to the display.

### **Test Equipment List and Details**

| Manufacturer    | Description       | Model | Serial Number | Calibration Date | Calibration Due Date |
|-----------------|-------------------|-------|---------------|------------------|----------------------|
| Rohde & Schwarz | EMI Test Receiver | ESCI  | 101122        | 2012-08-08       | 2013-08-07           |

\* **Statement of Traceability:** Bay Area Compliance Laboratories Corp. (Shenzhen) attests that all calibrations have been performed in accordance to requirements, traceable to National Primary Standards and International System of Units (SI).

### **Test Data**

#### **Environmental Conditions**

|                           |           |
|---------------------------|-----------|
| <b>Temperature:</b>       | 25 °C     |
| <b>Relative Humidity:</b> | 50 %      |
| <b>ATM Pressure:</b>      | 100.1 kPa |

*The testing was performed by Henry Ding on 2013-03-07.*

*EUT operation mode: Transmitting*

*Test Result: Compliance. Please refer to following tables and plots*

| Mode                                  | Channel | Frequency (MHz) | Conducted Output Power |       | Limit (mW) |
|---------------------------------------|---------|-----------------|------------------------|-------|------------|
|                                       |         |                 | (dBm)                  | (mW)  |            |
| <b>BDR (GFSK)</b>                     | Low     | 2402            | 4.31                   | 2.698 | 1000       |
|                                       | Middle  | 2441            | 4.10                   | 2.570 | 1000       |
|                                       | High    | 2480            | 1.54                   | 1.426 | 1000       |
| <b>EDR (<math>\pi/4</math>-DQPSK)</b> | Low     | 2402            | 2.00                   | 1.585 | 1000       |
|                                       | Middle  | 2441            | 1.78                   | 1.507 | 1000       |
|                                       | High    | 2480            | -0.79                  | 0.834 | 1000       |
| <b>EDR (8DPSK)</b>                    | Low     | 2402            | 2.47                   | 1.766 | 1000       |
|                                       | Middle  | 2441            | 2.29                   | 1.694 | 1000       |
|                                       | High    | 2480            | -0.23                  | 0.948 | 1000       |

**BDR (GFSK): Low Channel**

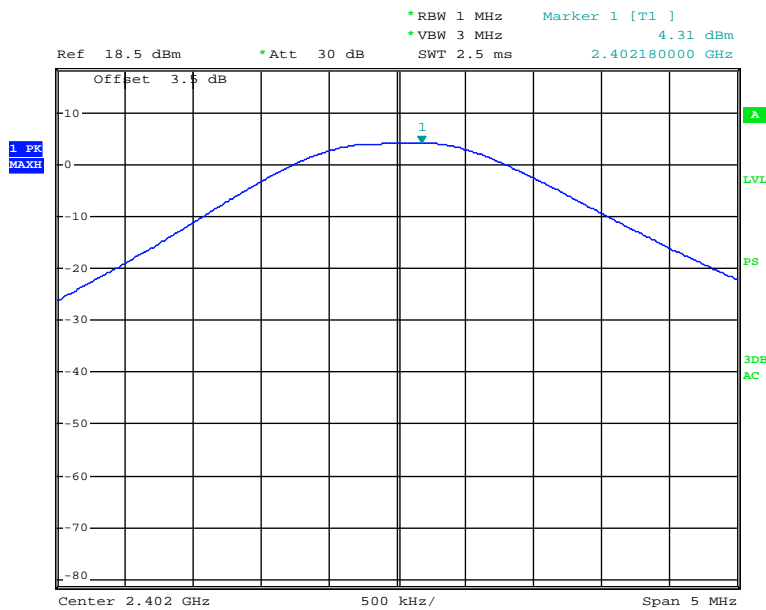

Date: 7.MAR.2013 11:59:15

### BDR (GFSK): Middle Channel

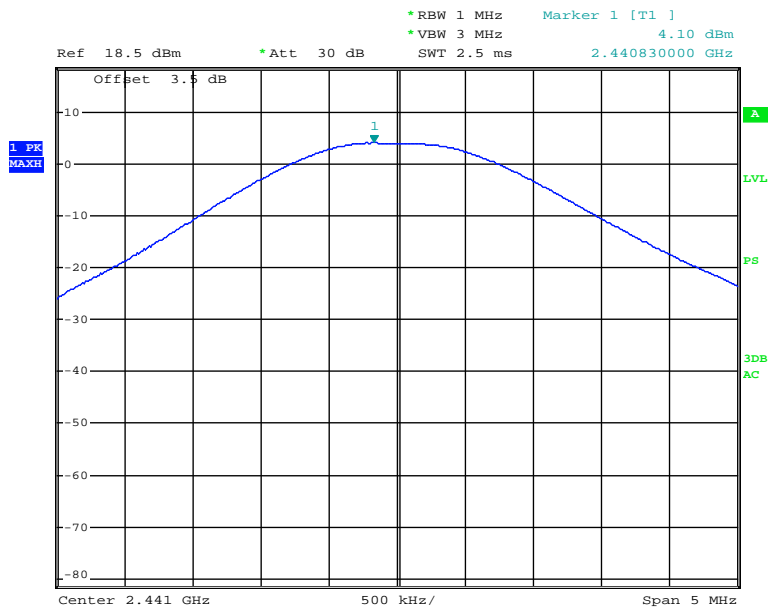

Date: 7.MAR.2013 11:58:45

### BDR (GFSK): High Channel

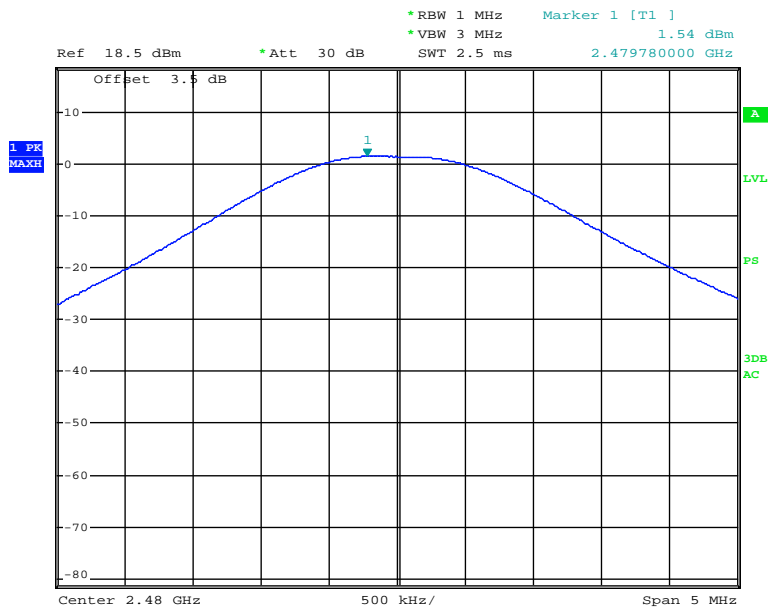

Date: 7.MAR.2013 11:58:08

### EDR( $\pi/4$ -DQPSK): Low Channel

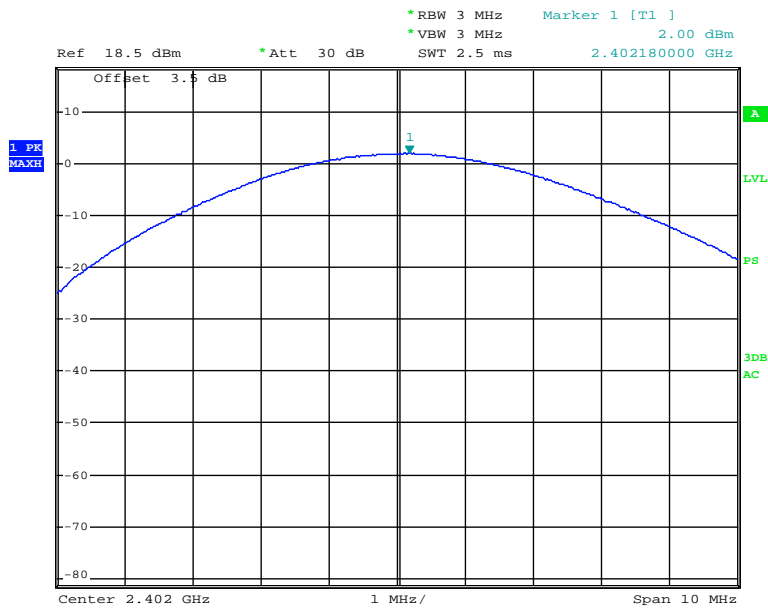

Date: 7.MAR.2013 12:35:44

### EDR( $\pi/4$ -DQPSK): Middle Channel

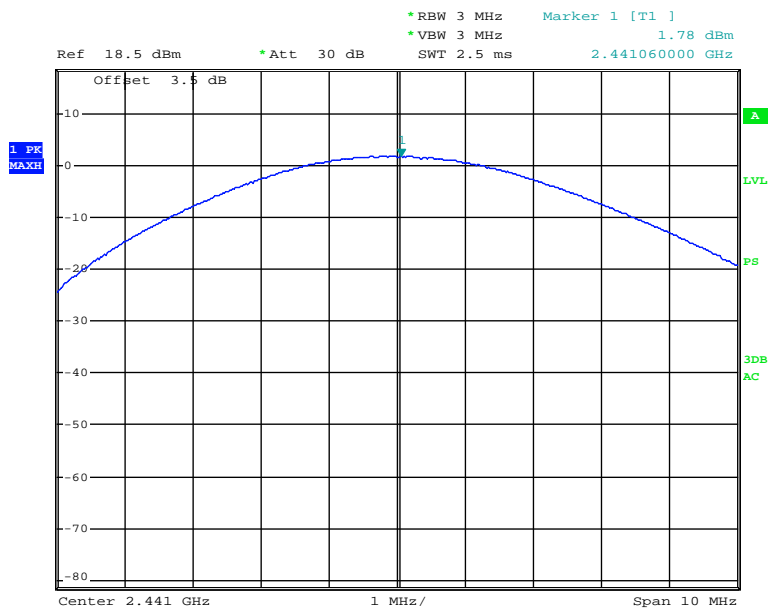

Date: 7.MAR.2013 12:35:10

### EDR( $\pi/4$ -DQPSK): High Channel

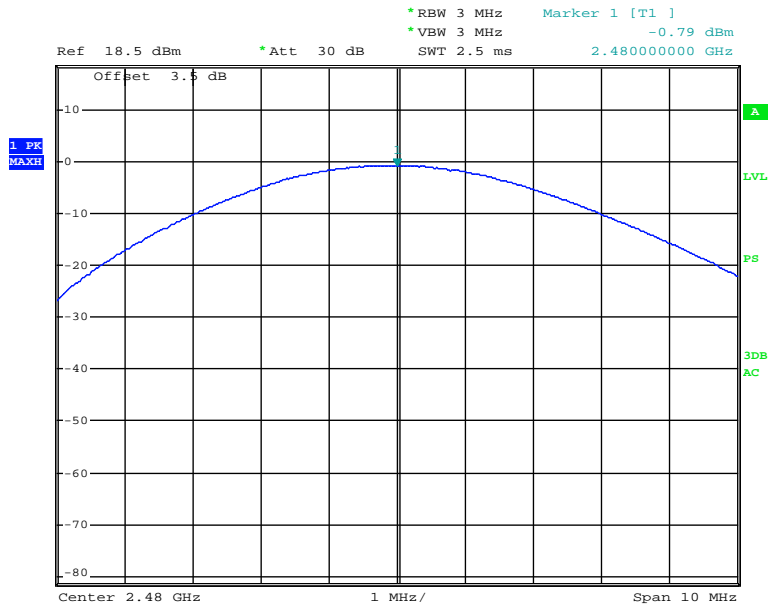

Date: 7.MAR.2013 12:34:38

### EDR(8DPSK): Low Channel

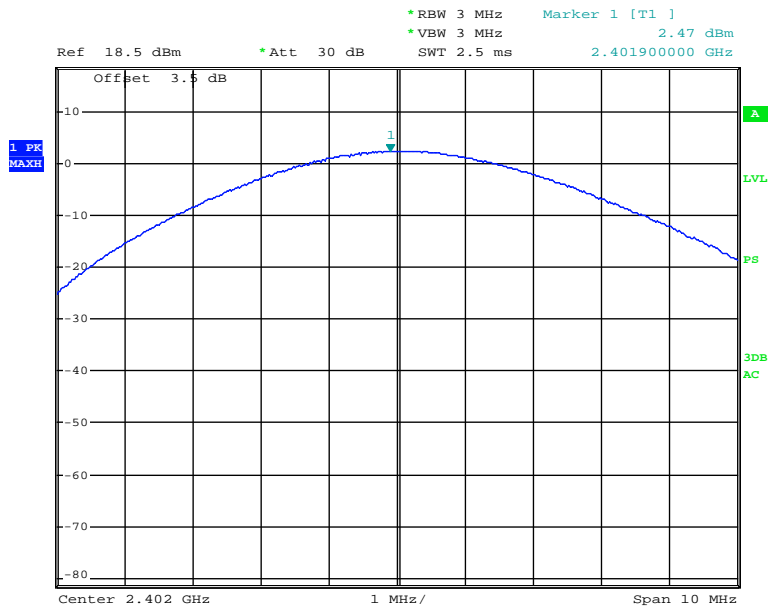

Date: 7.MAR.2013 12:51:43

### EDR(8DPSK): Middle Channel

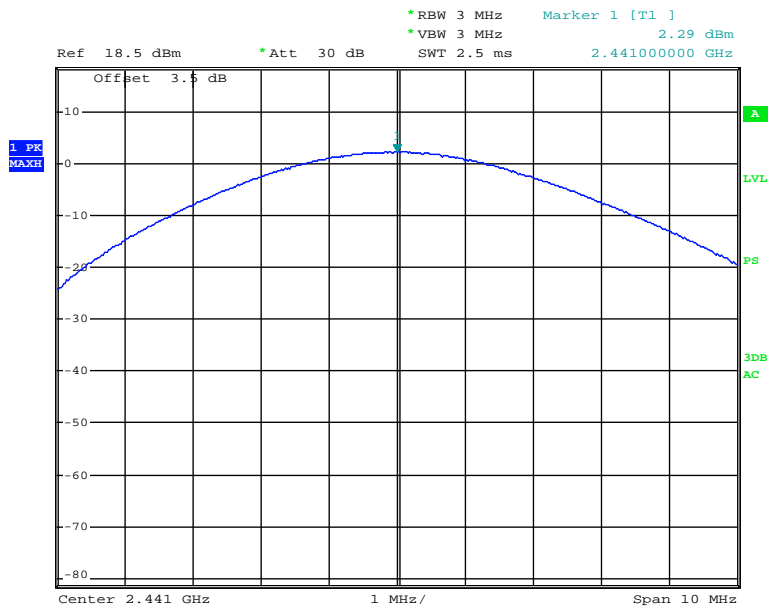

Date: 7.MAR.2013 12:51:14

### EDR(8DPSK): High Channel

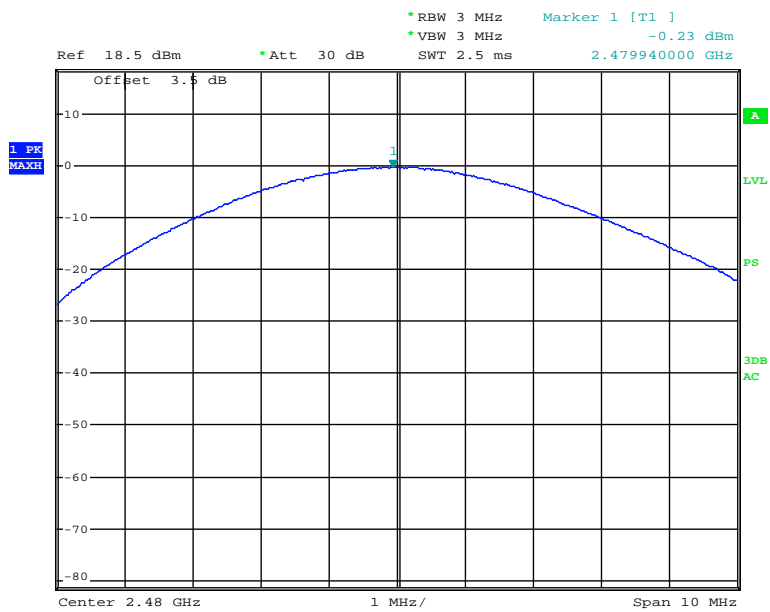

Date: 7.MAR.2013 12:50:48



## **FCC §15.247(d) - BAND EDGES TESTING**

### **Applicable Standard**

In any 100 kHz bandwidth outside the frequency band in which the spread spectrum or digitally modulated intentional radiator is operating, the radio frequency power that is produced by the intentional radiator shall be at least 20 dB below that in the 100 kHz bandwidth within the band that contains the highest level of the desired power, based on either an RF conducted or a radiated measurement, provided the transmitter demonstrates compliance with the peak conducted power limits. If the transmitter complies with the conducted power limits based on the use of RMS averaging over a time interval, as permitted under paragraph (b)(3) of this section, the attenuation required under this paragraph shall be 30 dB instead of 20 dB. Attenuation below the general limits specified in §15.209(a) is not required. In addition, radiated emissions which fall in the restricted bands, as defined in §15.205(a), must also comply with the radiated emission limits specified in §15.209(a) (see §15.205(c)).

### **Test Procedure**

1. Check the calibration of the measuring instrument using either an internal calibrator or a known signal from an external generator.
2. Remove the antenna from the EUT and then connect to a low loss RF cable from the antenna port to a EMI test receiver, then turn on the EUT and make it operate in transmitting mode. Then set it to Low Channel and High Channel within its operating range, and make sure the instrument is operated in its linear range.
3. Set RBW of spectrum analyzer to 100 kHz with a convenient frequency span including 100 kHz bandwidth from band edge.
4. Measure the highest amplitude appearing on spectral display and set it as a reference level. Plot the graph with marking the highest point and edge frequency.
5. Repeat above procedures until all measured frequencies were complete.

### **Test Equipment List and Details**

| <b>Manufacturer</b> | <b>Description</b> | <b>Model</b> | <b>Serial Number</b> | <b>Calibration Date</b> | <b>Calibration Due Date</b> |
|---------------------|--------------------|--------------|----------------------|-------------------------|-----------------------------|
| Rohde & Schwarz     | EMI Test Receiver  | ESCI         | 101122               | 2012-08-08              | 2013-08-07                  |

\* **Statement of Traceability:** Bay Area Compliance Laboratories Corp. (Shenzhen) attests that all calibrations have been performed in accordance to requirements, traceable to National Primary Standards and International System of Units (SI).

**Test Data**

**Environmental Conditions**

|                           |           |
|---------------------------|-----------|
| <b>Temperature:</b>       | 25 °C     |
| <b>Relative Humidity:</b> | 50 %      |
| <b>ATM Pressure:</b>      | 100.1 kPa |

*The testing was performed by Henry Ding on 2013-03-07.*

*EUT operation mode: Transmitting*

*Test Result: Compliance. Please refer to following table and plots*

| Frequency Band             | Delta Peak to band emission (dBc) | ≥ Limit (dBc) | Result |
|----------------------------|-----------------------------------|---------------|--------|
| BDR mode (GFSK)            |                                   |               |        |
| Left-band                  | 45.77                             | 20            | Pass   |
| Right-band                 | 50.85                             | 20            | Pass   |
| EDR Mode ( $\pi/4$ -DQPSK) |                                   |               |        |
| Left-band                  | 48.83                             | 20            | Pass   |
| Right-band                 | 49.13                             | 20            | Pass   |
| EDR Mode (8 DPSK)          |                                   |               |        |
| Left-band                  | 48.60                             | 20            | Pass   |
| Right-band                 | 49.59                             | 20            | Pass   |

**BDR (GFSK): Band Edge-Left Side**

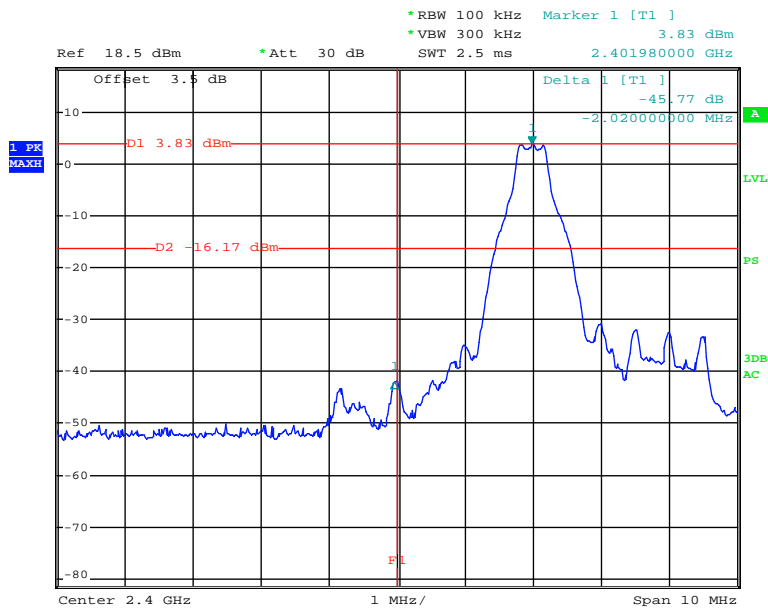

Date: 7.MAR.2013 12:06:56

**BDR (GFSK): Band Edge-Right Side**

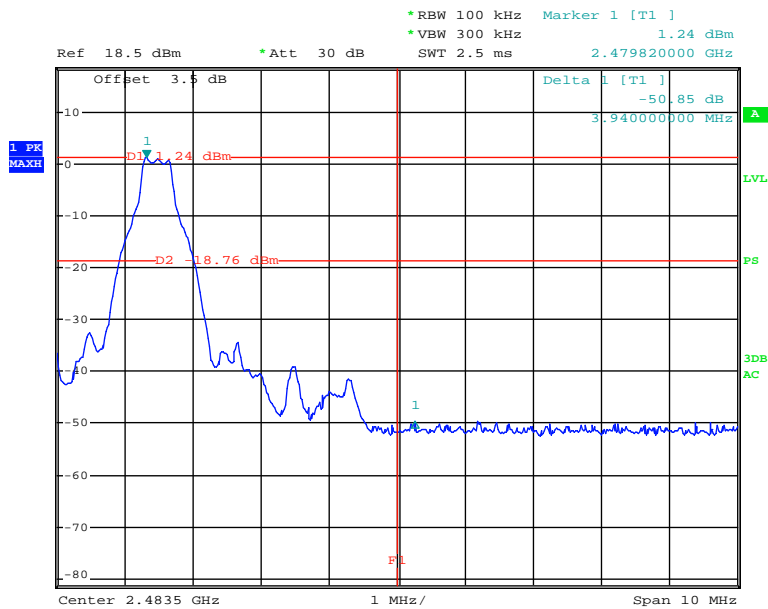

Date: 7.MAR.2013 12:05:30

### EDR ( $\pi/4$ -DQPSK): Band Edge-Left Side

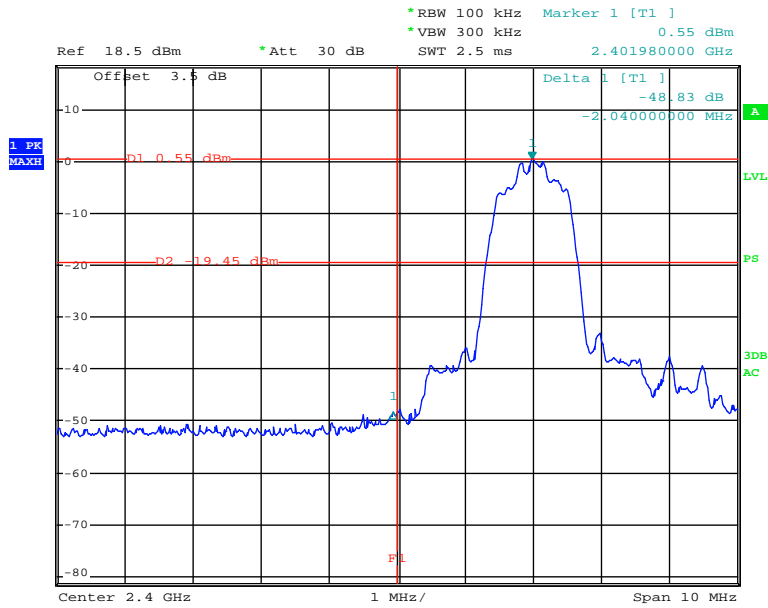

Date: 7.MAR.2013 12:37:02

### EDR ( $\pi/4$ -DQPSK): Band Edge-Right Side

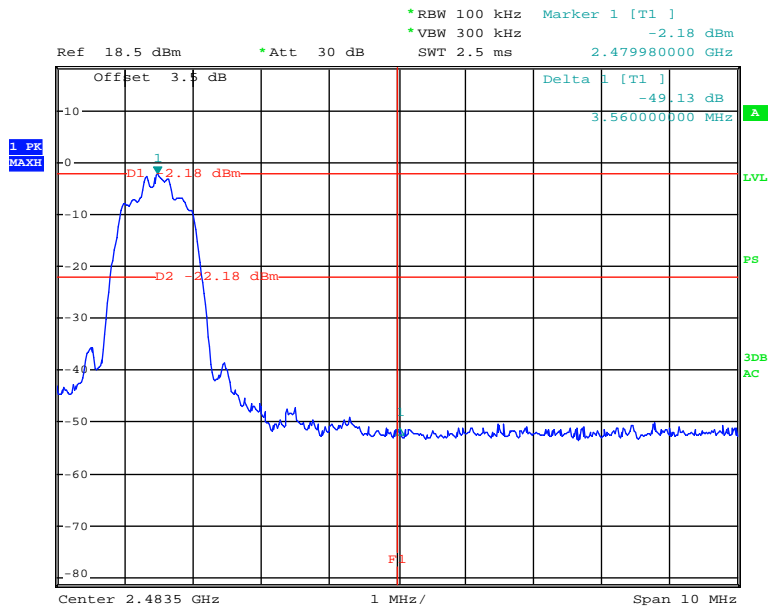

Date: 7.MAR.2013 12:38:08

**EDR (8DPSK): Band Edge-Left Side**

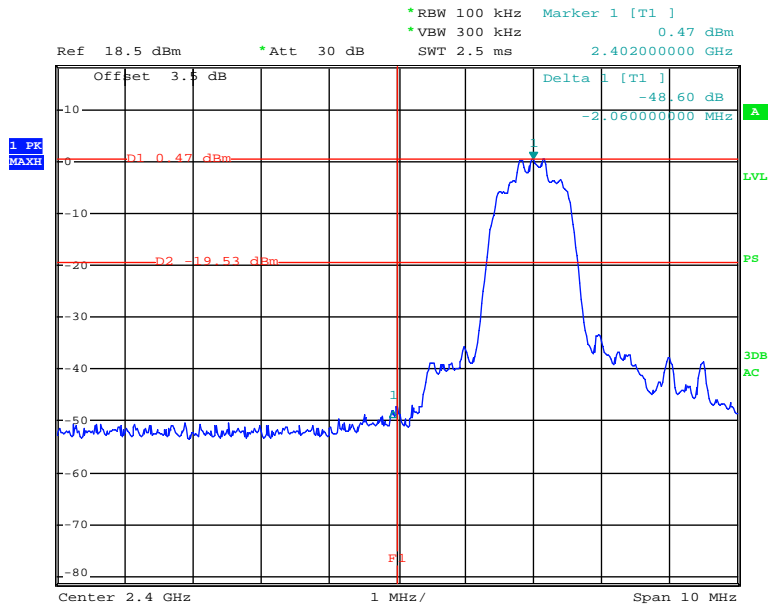

Date: 7.MAR.2013 12:52:44

**BDR (8DPSK): Band Edge-Right Side**

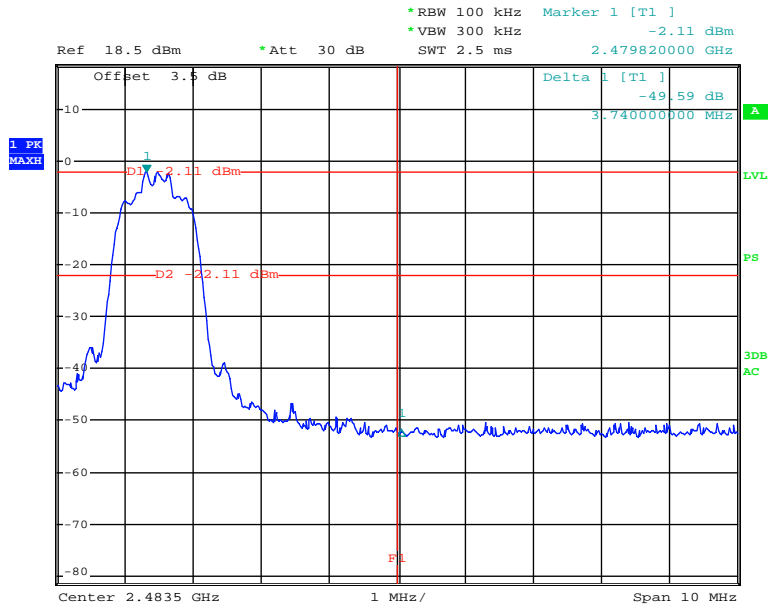

Date: 7.MAR.2013 12:53:50

\*\*\*\*\* END OF REPORT \*\*\*\*\*