

Dear Customer!

Congratulations on buying this emporia mobile telephone! You have made the right decision.

Scope of delivery: Mobile telephone, charging device, battery, instructions

1 Controls

Speaker

Display (= Screen)

Arrow Keys

- On standby:
- ☑ Favourites (pre-set: Alarm Settings)
- ☑ Enter phone book contact list
- In menu and phonebook: scrolling

☑ Pick-up/OK/Call list-Key

- Calling: Enter the number, then press ☑

- Answering an incoming call: Press ☑

- In menu: Confirm selection

- On standby: Enter call list (dialed, received, missed)

☑ Voicemail

- Press and hold to connect with voicemail (= answering machine)

☑ Key

- In standby:
- Press twice: + (for international prefix, e.g. +44 for UK)
- For SMS: Special characters:
(.,'?:;!";@_~&+-()<> [] % = / \ # * \$ % ...)

☑ Key

- For SMS: Space

☑ Key

- SMS: Switch between capital, small letters & numbers
- Silent mode activate/deactivate

16. SAFETY INSTRUCTIONS

Switch off mobile telephone in **hospitals** or near medical devices. There should be a minimal distance between pacemakers and switched-on telephones.

Do not drive a **vehicle** while holding a mobile phone in your hand. Follow the laws and traffic rules of the country you are in.

The mobile phone must be switched off while you are in an **airplane**.

The telephone must be switched off near **petrol stations** or other areas with explosive materials.

Never direct **LED flashlight** into the eyes of humans or animals! (Protection class 3)

17 INTENDED USE

This mobile telephone is robust and intended for mobile use. It is to be protected from moisture (rain, bathroom...) and impacts. Do not expose to prolonged direct sunlight.

Other use as described above leads to damage of product and furthermore is associated with hazards such as electrical shock, fire and so on. The entire product may not be altered nor rebuilt nor can the housing be opened.

18 TECHNICAL DATA

Dual band GSM 900/1800MHz
size: 103 x 51 x 18,5
weight: 110 g

Battery: Li-Ion 3.7V / 1000mAh
standby: 320 h
talktime: 240 min

☑ End/Back/Delete/Menu/ On/Off-Key

- In standby: Enter the menu
- In menu: One step back
- Writing numbers or text: Delete
- During a call: Terminate
- On/ Off: Press for 2 sec.

LED-lamps:

- ☑ Envelope: New Message
- ☑ Earphone: Missed call
- ☑ Battery:
 - Blinking: Low battery, Charging

Kamera

Torchlight

Camera-key

-Trigger button

Emergency button

Volume Control ☑ & ☑

Control the handset volume
☑ incoming call: turn ringer off

Battery door



emporia**CLICK**

Emporia Clicker Industrieweg 16, 40231 Lenz, Aachen, Westfalen
Emporia Clicker Industrieweg 16, 40231 Lenz, Aachen, Westfalen
Emporia Clicker Industrieweg 16, 40231 Lenz, Aachen, Westfalen



2 INSERT SIM CARD

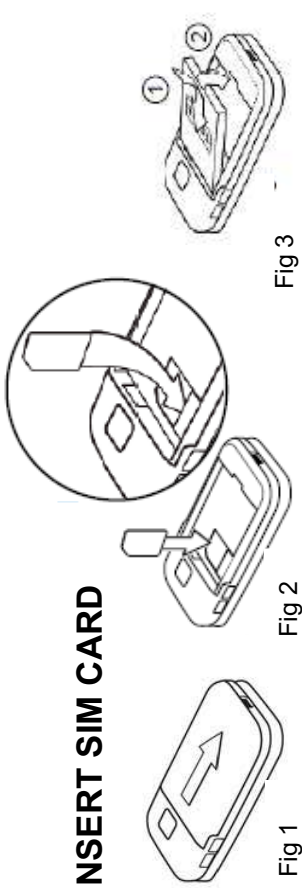

Fig. 1: Remove battery cover (as shown).

Fig. 2: Slide SIM card in with the gold contact facing down.

3 INSERT BATTERY AND CHARGING

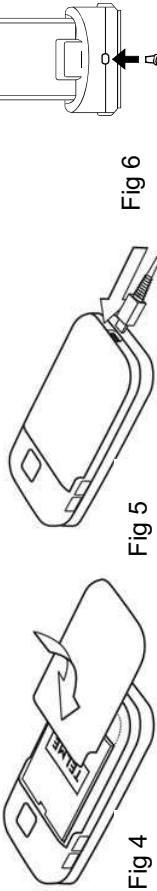

Fig. 3: Insert battery (gold contacts on right front side).

Fig. 4: Close battery door: slide cover to closed position with a 'click'.

Fig. 5: Plug charging cable into the socket on the lower narrow side of the phone or

Fig. 6: in the plug on the back of the desktop charger

Charging: Battery indication bars in upper right corner of the display are moving

The led on the upper side of the closed phone is on.

Full battery: Bars in upper right display corner are solid.

Note: Charge battery for at least 2 hours before first use!

4 DISPLAY SYMBOLS (SCREEN)

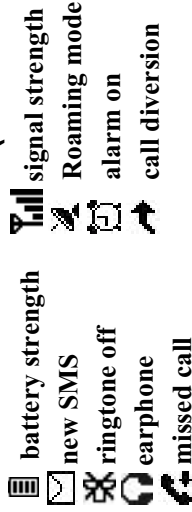

5 FIRST STEPS

Switch on the phone by pressing the power on/off-key  for at least 2 seconds.

Switch off by pressing power on/off  for 2 seconds again.

When using a new SIM card, enter the 4 digit PIN Code (Personal Identification Number) and confirm with .

PIN-Code: The PIN-Code is a 4-digit number combination preventing others from switching on your mobile phone.

Switch off your PIN-Code: In menu: **Settings** → **Security Settings** → **PIN** → **PIN off**.

Entering Menu:

- Press  - key.
- Scroll through menu points: with  and .
- Confirm: with .

Note: due to inactivity, the phone lights and screen turn off after a while. To turn on again, press any key.

Incoming Call:

- Pick up call: Press  - key.
- Reject call: Press  - key.
- End call:** Press  - key.

Dial: Enter the telephone number via the keypad (including area code with 0) - start call with .





Redial list: press -key, scroll through call list with   (all dialled, missed and received calls) and select a number and start call with .

Handsfree Speaking:











During a call handsfree function can be switched on or off: press  **Options** →  **Handsfree**.

6 PHONE BOOK

Saving names and numbers (start with international prefix, e.g. +44 for UK).





Enter menu in standby modus (Standby-Modus: chapter 5) with , then , ,  → Menu-Points: **Search name**, **Add contact**, **Own Number**, **Emergency numbers** (add, change, delete, status on/off), **Copy All**, **Edit Contact**, **Delete**, **Settings**;

Storing phone book entries (Name & Number):

Enter menu with  → continue to **Phone book**: , , ,  → continue to **Add contact**: ,  → Enter name via the keypad (See chapter 8, *Write SMS* for text entry), , → Enter number, ,  to **Save**.

Searching phone book entries:

Open the phone book with :

- Scroll through the entries with  and . Or:
- Search names: enter the initial letters of the searched name via the keypad (scroll through with ). When the requested name is shown, press  to start a call.

7 EMERGENCY FUNCTION

You can store a total of 5 emergency numbers (family, neighbours, friends, emergency services). In case of emergency these preselected numbers will be dialed automatically in a sequence, if the emergency key on the back of the phone gets pressed and held.

A continuous warning tone then starts in “loudspeaker mode” during emergency, so you and people nearby are warned due to the emergency! If the first number cannot be reached, the second number will be called automatically. If the second number in row cannot be reached, the third will be called. (max. 3 rotations of the 5 numbers).

Note: To avoid getting caught on a mailbox, the reached person has to confirm your emergency by calling back.

If no emergency number is saved or if your calling card has expired or you have no access to a foreign network (e.g. roaming not permitted), 112 will be dialed.

Saving emergency numbers: Enter menu → **Phone book** → **Emergency numbers** → **Add emergency number** → choose Emergency number (1-5) → pick contact from phone book → done

Note: select emergency number: private number (has to confirm as explained above) or official service number, f.i.: ambulance, police, etc. (no confirmation call required).

Switch emergency function On / Off: In menu **Phone book** → **Emergency numbers** → **Status** → **On / Off**.

Note: If you want to save emergency numbers from official services, police, fire department, etc., you have to clarify this with the certain institution. No liability will be assumed for possible costs incurred if you dial accidentally.

8 SMS MESSAGES

SMS (Short Message Service) are written messages with a maximum of 160 characters.

Receive SMS: A short signal and a registration on the display inform you about a new, incoming SMS message. With  you can read the message immediately or see a list of messages which have already been received in the menu **Messages** → **SMS** → **Received SMS**.

Write SMS: Enter menu with  → **Messages** → **SMS** → **Write new SMS:** The text entry is done by the keypad. (e.g. 2x , 2x , 3x , 3x , 3x  for Hello).

Each key carries several characters, appearing by multiple presses.

1 . , ! ? " ' @ : 1 5 j k l 5 £ 9 w x y z 9 ý þ
2 a b c 2 ä æ å à 6 m n o 6 ö ø ó 0 Space; 0
3 d e f 3 è è é 7 p q r s 7 ß \$ * Special
4 g h i 4 ï ï 8 t u v 8 ü ú characters: . , ? ; : ! " ' @ _ ~

Switch between different entry methods by pressing #:

abc-only small ABC-only CAPITAL 123-Numbers

Send SMS: Select **Send** with 2x and enter number or select from phone book (2x , select contact with). Press to send SMS.

9 MMS MESSAGES

MMS (Multimedia Message Service) are messages incl. pictures, audio, etc.

First time use: Menu → **MMS** → **MMS Settings** → **MMS account** → choose operator

Send MMS: enter Menu with → **Messages** → **MMS** → **Create new MMS:**

- (Edit)** → Add number: Enter number/ select phone book entry →
- to **Subject** (this will be the headline of the message) → **(Edit)** → Insert message text → **(Done)**.
- Edit content:** 1x → **(Edit)** → Insert text or picture: → **(Options)** → to **Add picture:** → **open phone:** → **open pictures:** → scroll to picture with → → choose picture with → → **(done)**.

If you have problems at the first time sending MMS, contact your operator to check MMS settings.

10 CAMERA:

Take picture: press camera-button → picture detail OK, press , store with

Camera settings: , : Settings, picture size, white balance

Picture gallery: menu → select picture, scroll to next picture with .

▪ Pictures: → option: **View, Send as MMS, Use as background, Use for contact** (choose the phone book entry, (note: only contacts from phone memory, not from SIM-card). Calls to/from this contact will then show the linked picture on the display), **Rename, Delete, Delete all files** **(OK)**.

11 TOOLS:

Bluetooth:



- Switch on: In menu → **Tools** → **Bluetooth** → **Bluetooth on/off**
- Pairing: menu **Tools** → **Bluetooth** → **Connections** → **Search for new device** to search for devices → select the device you want to pair, select . Next time you turn on Bluetooth connection will start automatically.

Alarm

Standby 1x in menu → **On/Off:** to switch Alarm clock on or off → **Change:** to set the time and repetition (once, daily, personal setting).

If the alarm rings, end with . Use mute function with to reactivate the alarm after 1 minute.

12 OTHER FUNCTIONS IN SETTINGS

Enter menu with  → continue to **Settings**: ,  →

- **Sound & Alert**: To choose a phone profile (f.i. Silent) and configure your personal settings.
- **Call waiting**: You can activate/deactivate and check status to get a notification about an incoming call while having a phone talk.
- **Network settings**: Choose **automatic** (automatic boot in a network) or **manual selection** (select a network manually).
- **Favorites** : your favorite functions pressing 1 button
- **Auto power on/Auto power off**
- **Voicemail number**: Change the voicemail number
- **Security settings**: Activate, deactivate or change PIN and phonecode (default phone code: 1234).
- **Restore Factory**: Reset the phone to factory settings.

13 DISPOSAL

Disposal of packaging: Packaging materials are recyclable and shall enter the recycling process.



Disposal of battery: Do not insert battery into household trash for disposal! You are obligated to return used batteries. These can be handed into local collection areas or to specialty shops.

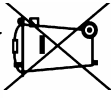

Disposal of Device: When this product is taken out of service, please do not throw it into the household trash. Take care of the environment by bringing it to a collection place, where old devices are accepted and brought into an environmentally-friendly disposal/recycling procedure.



14 FREQUENTLY ASKED QUESTIONS

- **Screen shows “Insert SIM card! Only emergency call 112“**: Check the direction of the SIM card
- **A call failed**: Check the selected telephone number and area code again for accuracy (area code entered?).
- The mobile telephone **display is blank/black**: Telephone is in energy saving mode (press any key) or it is switched off (press  for 2 seconds to switch on).
- The mobile phone **does not react**: Remove battery, re-insert and switch on the device. If there is still no reaction, refer to the service centre.
- **The charging procedure does not begin**: This can take several minutes. If there is no reaction after 10 minutes, refer phone to service centre.

15 Warning

FCC Warning:

This device complies with part 15 of the FCC Rules. Operation is subject to the following two conditions: (1) This device may not cause harmful interference, and (2) this device must accept any interference received, including interference that may cause undesired operation.

Changes or modifications not expressly approved by the party responsible for compliance could void the user's authority to operate the equipment.

Specific Absorption Rate (SAR) information

SAR tests are conducted using standard operating positions accepted by the FCC with the Phone transmitting at its highest certified power level in all tested frequency bands, although the SAR is determined at the highest certified power level, the actual SAR level of the phone While operating can be well below the maximum value, in general, the closer you are to a Wireless base station antenna, the lower the power output.

Before a new model phone is available for sale to the public, it must be tested and certified to the FCC that it does not exceed the exposure limit established by the FCC, Tests for each phone are performed in positions and locations (e.g. at the ear and worn on the body)as required by the FCC.

For body worn operation, this model phone has been tested and meets the FCC RF exposure guidelines when used with an accessory designated for this product or when used with an accessory that Contains no metal and that positions the handset a minimum of 1.5 cm from the body. Non-compliance with the above restrictions may result in violation of RF exposure guidelines.