



Test Report No.: RF2212WDG0106-4



TEST REPORT



Applicant	Tonly Technology Co., Ltd.
Address	Section 37, Zhongkai High-tech Development Zone, Huizhou City, GuangDong Province, P.R. China

Manufacturer or Supplier	Sony Corporation
Address	1-7-1 Konan Minato-ku Tokyo, 108-0075 Japan
Product	ACTIVE FRONT SPEAKER
Brand Name	SONY
Model	YY2078C1
Additional Model & Model Difference	N/A
Date of tests	Feb. 18, 2023 ~ Feb. 23, 2023

The tests have been carried out according to the requirements of the following standard:

FCC Part 15, Subpart C, Section 15.247

CONCLUSION: The submitted sample was found to COMPLY with the test requirement

Tested by Lucas Chen Project Engineer / EMC Department	Approved by Glyn He Assistant Manager / EMC Department
	 Date: Mar. 03, 2023

This report is governed by, and incorporates by reference, the Conditions of Testing as posted at the date of issuance of this report at <http://www.bureauveritas.com/home/about-us/our-business/cps/about-us/terms-conditions/> and is intended for your exclusive use. Any copying or replication of this report to or for any other person or entity, or use of our name or trademark, is permitted only with our prior written permission. This report sets forth our findings solely with respect to the test samples identified herein. The results set forth in this report are not indicative or representative of the quality or characteristics of the lot from which a test sample was taken or any similar or identical product unless specifically and expressly noted. Our report includes all of the tests requested by you and the results thereof based upon the information that you provided to us. Measurement uncertainty is only provided upon request for accredited tests. Statements of conformity are based on simple acceptance criteria without taking measurement uncertainty into account, unless otherwise requested in writing. You have 60 days from date of issuance of this report to notify us of any material error or omission caused by our negligence or if you require measurement uncertainty; provided, however, that such notice shall be in writing and shall specifically address the issue you wish to raise. A failure to raise such issue within the prescribed time shall constitute your unqualified acceptance of the completeness of this report, the tests conducted and the correctness of the report contents.



TABLE OF CONTENTS

RELEASE CONTROL RECORD	4
1 SUMMARY OF TEST RESULTS.....	5
2 MEASUREMENT UNCERTAINTY	5
3 GENERAL INFORMATION	6
3.1 GENERAL DESCRIPTION OF EUT	6
3.2 DESCRIPTION OF TEST MODES	7
3.2.1. CONFIGURATION OF SYSTEM UNDER TEST	7
3.2.2. TEST MODE APPLICABILITY AND TESTED CHANNEL DETAIL.....	7
3.3 GENERAL DESCRIPTION OF APPLIED STANDARDS	9
3.4 DESCRIPTION OF SUPPORT UNITS	9
3.5 CONFIGURATION OF SYSTEM UNDER TEST	10
4 TEST TYPES AND RESULTS.....	11
4.1 CONDUCTED EMISSION MEASUREMENT	11
4.1.1 LIMITS OF CONDUCTED EMISSION MEASUREMENT	11
4.1.2 TEST INSTRUMENTS.....	11
4.1.3 TEST PROCEDURES	12
4.1.4 DEVIATION FROM TEST STANDARD	12
4.1.5 TEST SETUP	13
4.1.6 EUT OPERATING CONDITIONS	13
4.1.7 TEST RESULTS	14
4.2 RADIATED EMISSION MEASUREMENT	16
4.2.1 LIMITS OF RADIATED EMISSION MEASUREMENT	16
4.2.2 TEST INSTRUMENTS.....	17
4.2.3 TEST PROCEDURES	18
4.2.4 DEVIATION FROM TEST STANDARD	19
4.2.5 TEST SETUP	19
4.2.6 EUT OPERATING CONDITIONS	20
4.2.7 TEST RESULTS	21
4.3 6DB BANDWIDTH MEASUREMENT	27
4.3.1 LIMITS OF 6DB BANDWIDTH MEASUREMENT	27
4.3.2 TEST INSTRUMENTS.....	27
4.3.3 TEST PROCEDURE.....	28
4.3.4 DEVIATION FROM TEST STANDARD	28



4.3.5 TEST SETUP 29

4.3.6 EUT OPERATING CONDITIONS 29

4.3.7 TEST RESULTS 30

4.4 CONDUCTED OUTPUT POWER..... 32

4.4.1 LIMITS OF CONDUCTED OUTPUT POWER MEASUREMENT 32

4.4.2 TEST SETUP 32

4.4.3 TEST INSTRUMENTS..... 32

4.4.4 TEST PROCEDURES 32

4.4.5 DEVIATION FROM TEST STANDARD 32

4.4.6 EUT OPERATING CONDITIONS 32

4.4.7 TEST RESULTS 33

4.4.7.1 MAXIMUM PEAK OUTPUT POWER 33

4.4.7.2 AVERAGE OUTPUT POWER (FOR REFERENCE)..... 34

4.5 POWER SPECTRAL DENSITY MEASUREMENT 35

4.5.1 LIMITS OF POWER SPECTRAL DENSITY MEASUREMENT 35

4.5.2 TEST SETUP 35

4.5.3 TEST INSTRUMENTS..... 35

4.5.4 TEST PROCEDURE..... 35

4.5.5 DEVIATION FROM TEST STANDARD 35

4.5.6 EUT OPERATING CONDITION 35

4.5.7 TEST RESULTS 36

4.6 OUT OF BAND EMISSION MEASUREMENT 38

4.6.1 LIMITS OF OUT OF BAND EMISSION MEASUREMENT 38

4.6.2 TEST SETUP 38

4.6.3 TEST INSTRUMENTS..... 38

4.6.4 TEST PROCEDURE..... 38

4.6.5 DEVIATION FROM TEST STANDARD 39

4.6.6 EUT OPERATING CONDITION 39

4.6.7 TEST RESULTS 40

5 PHOTOGRAPHS OF THE TEST CONFIGURATION 42

**6 APPENDIX A - MODIFICATIONS RECORDERS FOR ENGINEERING CHANGES TO THE EUT
BY THE LAB 43**



**BUREAU
VERITAS**

Test Report No.: RF2212WDG0106-4

RELEASE CONTROL RECORD

ISSUE NO.	REASON FOR CHANGE	DATE ISSUED
RF2212WDG0106-4	Original release	Mar. 03, 2023



1 SUMMARY OF TEST RESULTS

The EUT has been tested according to the following specifications:

APPLIED STANDARD: FCC PART 15, SUBPART C (SECTION 15.247)			
STANDARD SECTION	TEST TYPE AND LIMIT	RESULT	REMARK
15.207	AC Power Conducted Emission	PASS	Meet the requirement of limit.
15.205 15.209	Radiated Emission	PASS	Meet the requirement of limit.
15.247(d)	Out of band Emission Measurement	PASS	Meet the requirement of limit.
15.247(a)(2)	6dB bandwidth	PASS	Meet the requirement of limit.
15.247(b)	Conducted Output power	PASS	Meet the requirement of limit.
15.247(e)	Power Spectral Density	PASS	Meet the requirement of limit.
15.203	Antenna Requirement	PASS	No antenna connector is used.

2 MEASUREMENT UNCERTAINTY

Where relevant, the following measurement uncertainty levels have been estimated for tests performed on the EUT as specified in CISPR 16-4-2:

MEASUREMENT	FREQUENCY	UNCERTAINTY
Conducted emissions	0.15MHz ~ 30MHz	2.68dB
Radiated emissions	9KHz ~ 30MHz	2.80dB
	30MHz ~ 1GMHz	4.62dB
	1GHz ~ 18GHz	4.96dB
	18GHz ~ 40GHz	4.50dB

This uncertainty represents an expanded uncertainty expressed at approximately the 95% confidence level using a coverage factor of k = 2.



3 GENERAL INFORMATION

3.1 GENERAL DESCRIPTION OF EUT

PRODUCT	ACTIVE FRONT SPEAKER
MODEL NO.	YY2078C1
ADDITIONAL MODEL	N/A
FCC ID	ZVAYY2078C1
NOMINAL VOLTAGE	DC 5/9/12/15V from USB Host Unit or DC 7.2V from Li-ion Battery
MODULATION TECHNOLOGY	DTS
MODULATION TYPE	BT-LE GFSK
OPERATING FREQUENCY	2402-2480MHz
PEAK OUTPUT POWER	2.965mW (Max. Measured)
ANTENNA TYPE	PCB Antenna, 3.4dBi Gain
I/O PORTS	Refer to user's manual
CABLE SUPPLIED	N/A

NOTE:

1. For a more detailed features description, please refer to the manufacturer's specifications or the user's manual.
2. For the test results, the EUT had been tested with all conditions. But only the worst case was shown in test report.
3. Please refer to the EUT photo document (Reference No.: 2212WDG0106-3) for detailed product photo.
4. The EUT has two modules, the "BM82A" and the "BM65T", they can transmit simultaneously, as for radiated emission (above 1GHz), the simultaneous transmission of two modules was also tested, but the report only shows the worst channel.
5. The EUT was powered by the following adapter:

ADAPTER	
BRAND:	SONY
MODEL:	AC-045AX7T
INPUT:	AC 100-240V, 50/60Hz 1.4A
OUTPUT:	DC 5/9/12/15V 3A or DC 20V 2.25A
TYPE-C CABLE:	Shielded, detachable, 150cm



3.2 DESCRIPTION OF TEST MODES

40 channels are provided for BT-LE (GFSK):

CHANNEL	FREQ. (MHZ)	CHANNEL	FREQ. (MHZ)	CHANNEL	FREQ. (MHZ)	CHANNEL	FREQ. (MHZ)
0	2402	10	2422	20	2442	30	2462
1	2404	11	2424	21	2444	31	2464
2	2406	12	2426	22	2446	32	2466
3	2408	13	2428	23	2448	33	2468
4	2410	14	2430	24	2450	34	2470
5	2412	15	2432	25	2452	35	2472
6	2414	16	2434	26	2454	36	2474
7	2416	17	2436	27	2456	37	2476
8	2418	18	2438	28	2458	38	2478
9	2420	19	2440	29	2460	39	2480

3.2.1. CONFIGURATION OF SYSTEM UNDER TEST

Please see section 5 photographs of the test configuration for reference.

3.2.2. TEST MODE APPLICABILITY AND TESTED CHANNEL DETAIL

Pre-Scan has been conducted to determine the worst-case mode from all possible combinations between available modulations, data rates, XYZ axis, power supply voltage range and antenna ports. The worst case was found when positioned on X axis for radiated emission. Following test modes were selected for the final test, and the final worst case is marked in boldface and recorded in the report:

EUT CONFIGURE MODE	APPLICABLE TO				DESCRIPTION
	RE<1G	RE≥1G	PLC	APCM	
A	√	√	√	√	Powered By Adapter Input AC 120V/60Hz with BT link

Where **RE<1G**: Radiated Emission below 1GHz **RE≥1G**: Radiated Emission above 1GHz
PLC: Power Line Conducted Emission **APCM**: Antenna Port Conducted Measurement



RADIATED EMISSION TEST (BELOW 1GHz):

- Pre-Scan has been conducted to determine the worst-case mode from all possible combinations between available modulations, data rates, XYZ axis and antenna ports (if EUT with antenna diversity architecture).
- Following channel(s) was (were) selected for the final test as listed below.

EUT CONFIGURE MODE	AVAILABLE CHANNEL	TESTED CHANNEL	MODULATION TECHNOLOGY	MODULATION TYPE	DATA RATE (Mbps)
A	0 to 39	39	DTS	GFSK	1 Mbps

For the test results, only the worst case was shown in test report.

RADIATED EMISSION TEST (ABOVE 1GHz):

- Pre-Scan has been conducted to determine the worst-case mode from all possible combinations between available modulations, data rates, XYZ axis and antenna ports (if EUT with antenna diversity architecture).
- Following channel(s) was (were) selected for the final test as listed below.

EUT CONFIGURE MODE	AVAILABLE CHANNEL	TESTED CHANNEL	MODULATION TECHNOLOGY	MODULATION TYPE	DATA RATE (Mbps)
A	0 to 39	39	DTS	GFSK	1 Mbps

POWER LINE CONDUCTED EMISSION TEST:

- Pre-Scan has been conducted to determine the worst-case mode from all possible combinations between available modulations, antenna ports (if EUT with antenna diversity architecture), and packet types.
- Following channel(s) was (were) selected for the final test as listed below.

EUT CONFIGURE MODE	TESTED CONDITION
A	BT Link

ANTENNA PORT CONDUCTED MEASUREMENT:

- This item includes all test value of each mode, but only includes spectrum plot of worst value of each mode.
- Pre-Scan has been conducted to determine the worst-case mode from all possible combinations between available modulations, antenna ports (if EUT with antenna diversity architecture), and packet types.
- Following channel(s) was (were) selected for the final test as listed below.

EUT CONFIGURE MODE	AVAILABLE CHANNEL	TESTED CHANNEL	MODULATION TECHNOLOGY	MODULATION TYPE	DATA RATE (Mbps)
A	0 to 39	39	DTS	GFSK	1 Mbps



TEST CONDITION:

APPLICABLE TO	ENVIRONMENTAL CONDITIONS	INPUT POWER	TESTED BY
RE<1G	20deg. C, 50%RH	Powered By Adapter Input AC 120V/60Hz	Stalker
RE≥1G	20deg. C, 50%RH	Powered By Adapter Input AC 120V/60Hz	Stalker
PLC	25deg. C, 58%RH	Powered By Adapter Input AC 120V/60Hz	Summer
APCM	24deg. C, 56%RH	Powered By Adapter Input AC 120V/60Hz	Vincent

3.3 GENERAL DESCRIPTION OF APPLIED STANDARDS

The EUT is a RF Product. According to the specifications of the manufacturer, it must comply with the requirements of the following standards:

FCC Part 15, Subpart C, Section 15.247

558074 D01 15.247 Meas Guidance v05r02

ANSI C63.10-2013

Note: All test items have been performed and recorded as per the above standards.

3.4 DESCRIPTION OF SUPPORT UNITS

The EUT has been tested as an independent unit together with other necessary accessories or support units. The following support units or accessories were used to form a representative test configuration during the tests.

NO.	PRODUCT	BRAND	MODEL NO.	SERIAL NO.	FCC ID
1	iPhone 6 Plus	Apple	A1522/A1524	N/A	BCG-E2817A
2	ACTIVE REAR SPEAKER	SONY	YY2078C2/YY2078C3	N/A	N/A

NO.	SIGNAL CABLE DESCRIPTION OF THE ABOVE SUPPORT UNITS
1	N/A
2	N/A



3.5 CONFIGURATION OF SYSTEM UNDER TEST

For Conducted Emission Test

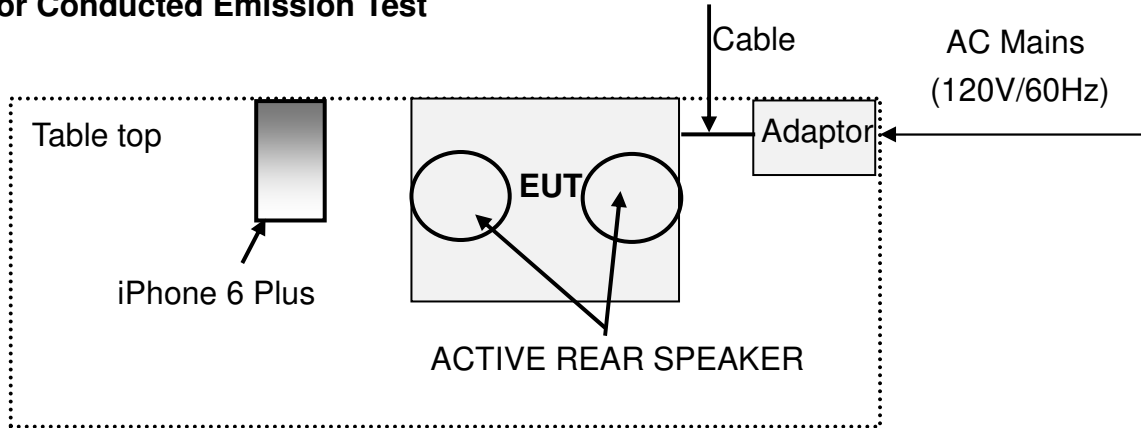

Note: For the actual test configuration, please refer to the attached file (Test Setup Photo).

For Radiated Emission Test

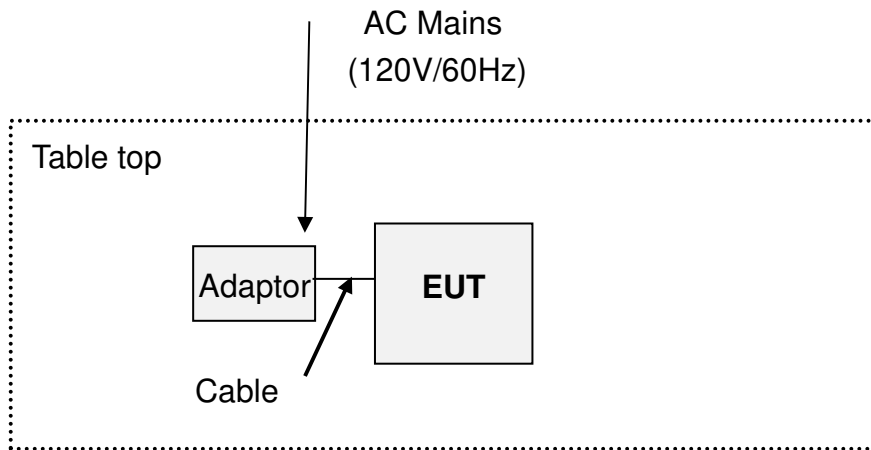

Note: For the actual test configuration, please refer to the attached file (Test Setup Photo).



4 TEST TYPES AND RESULTS

4.1 CONDUCTED EMISSION MEASUREMENT

4.1.1 LIMITS OF CONDUCTED EMISSION MEASUREMENT

FREQUENCY OF EMISSION (MHz)	CONDUCTED LIMIT (dBµV)	
	Quasi-peak	Average
0.15 ~ 0.5	66 to 56	56 to 46
0.5 ~ 5	56	46
5 ~ 30	60	50

- NOTE:** 1. The lower limit shall apply at the transition frequencies.
2. The limit decreases in line with the logarithm of the frequency in the range of 0.15 to 0.50MHz.
3. All emanations from a class A/B digital device or system, including any network of conductors and apparatus connected thereto, shall not exceed the level of field strengths specified above.

4.1.2 TEST INSTRUMENTS

Equipment	Manufacturer	Model No.	Serial No.	Next Cal.
EMI Test Receiver	Rohde&Schwarz	ESR7	101494	Jan. 18, 24
Artificial Mains Network	Rohde&Schwarz	ENV216	101173	Jan. 23, 24
Artificial Mains Network	Rohde&Schwarz	ESH3-Z5	100317	Jan. 18, 24
Voltage probe	SCHWARZBECK	TK 9421	TK 9421-176	Jul. 27, 23
Coaxial RF Cable	/	CE CABLE	C2310066DG	Jul. 24, 23
Test software	ADT	ADT_Cond_V7.3.7	N/A	N/A
Shielded Room 553	CHANGMAO	5m*5m*3m	E1-010034	Jan. 27,24

- NOTES:** 1. The test was performed at Shielded Room 553.
2. The calibration interval of the above test equipment (except shielded room and chamber) is 12 months. And the calibrations are traceable to CEPREI/CHINA, GRGT/CHINA and NIM/CHINA.



4.1.3 TEST PROCEDURES

- a. The EUT was placed 0.4 meters from the conducting wall of the shielded room with EUT being connected to the power mains through a line impedance stabilization network (LISN). Other support units were connected to the power mains through another LISN. The two LISNs provide 50 ohm/ 50uH of coupling impedance for the measuring instrument.
- b. Both lines of the power mains connected to the EUT were checked for maximum conducted interference.
- c. The frequency range from 150kHz to 30MHz was searched. Emission levels under (Limit - 20dB) was not recorded.

NOTE: All modes of operation were investigated and the worst-case emissions are reported.

4.1.4 DEVIATION FROM TEST STANDARD

No deviation.



4.1.5 TEST SETUP

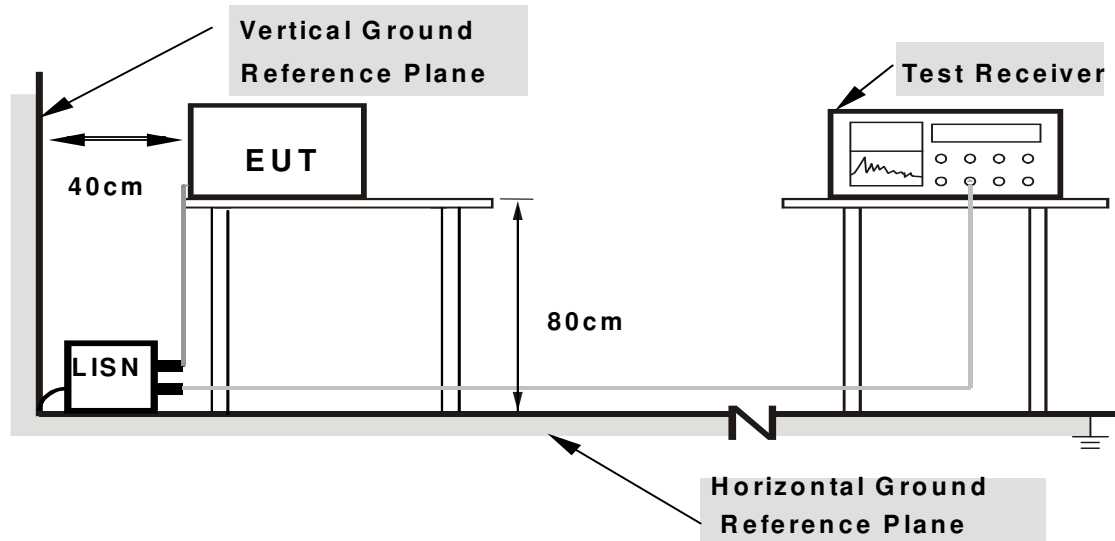

- Note: 1. Support units were connected to second LISN.**
2. Both of LISNs (AMN) are 80 cm from EUT and at least 80 cm from other units and other metal planes

For the actual test configuration, please refer to the attached file (Test Setup Photo).

4.1.6 EUT OPERATING CONDITIONS

- a. Turned on the power and connected of all equipment.
- b. EUT was operated according to the type used was description in manufacturer's specifications or the User's Manual.



4.1.7 TEST RESULTS

CONDUCTED WORST-CASE DATA: BT Link

PHASE	Line	6dB BANDWIDTH	9kHz
--------------	------	----------------------	------

No.	Freq. [MHz]	Corr. Factor (dB)	Reading Value		Emission Level		Limit		Margin	
			[dB (uV)]		[dB (uV)]		[dB (uV)]		(dB)	
			Q.P.	AV.	Q.P.	AV.	Q.P.	AV.	Q.P.	AV.
1	0.15000	9.95	31.22	8.25	41.17	18.20	66.00	56.00	-24.83	-37.80
2	0.17374	9.98	29.70	14.43	39.68	24.41	64.78	54.78	-25.10	-30.37
3	0.45185	10.14	28.68	26.20	38.82	36.34	56.84	46.84	-18.02	-10.50
4	0.48750	10.16	26.59	23.68	36.75	33.84	56.21	46.21	-19.46	-12.37
5	11.88600	10.74	23.69	16.23	34.43	26.97	60.00	50.00	-25.57	-23.03
6	18.81375	11.09	24.03	13.46	35.12	24.55	60.00	50.00	-24.88	-25.45

REMARKS: The emission levels of other frequencies were very low against the limit.

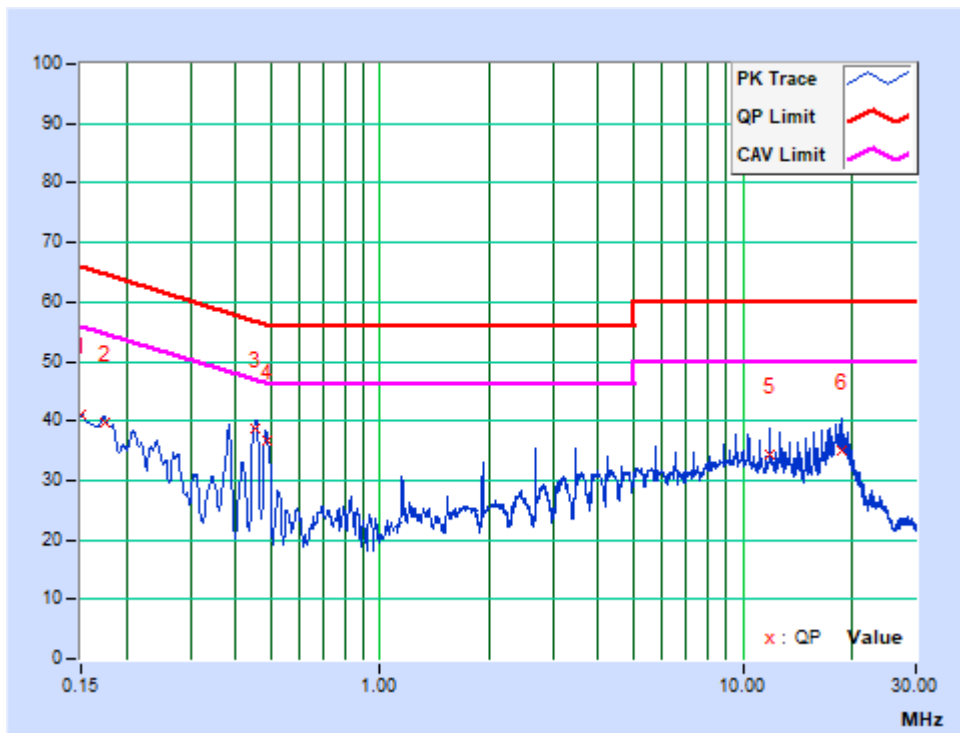



**BUREAU
VERITAS**

Test Report No.: RF2212WDG0106-4

PHASE	Neutral	6dB BANDWIDTH	9kHz
--------------	---------	----------------------	------

No.	Freq. [MHz]	Corr. Factor (dB)	Reading Value		Emission Level		Limit		Margin	
			[dB (uV)]		[dB (uV)]		[dB (uV)]		(dB)	
			Q.P.	AV.	Q.P.	AV.	Q.P.	AV.	Q.P.	AV.
1	0.15000	9.87	31.47	13.04	41.34	22.91	66.00	56.00	-24.66	-33.09
2	0.24231	9.96	25.01	19.62	34.97	29.58	62.02	52.02	-27.05	-22.44
3	0.45600	10.01	32.99	30.70	43.00	40.71	56.77	46.77	-13.76	-6.05
4	0.56703	10.03	24.37	13.94	34.40	23.97	56.00	46.00	-21.60	-22.03
5	11.92650	10.83	23.73	16.66	34.56	27.49	60.00	50.00	-25.44	-22.51
6	17.26800	11.02	22.77	16.01	33.79	27.03	60.00	50.00	-26.21	-22.97

REMARKS: The emission levels of other frequencies were very low against the limit.

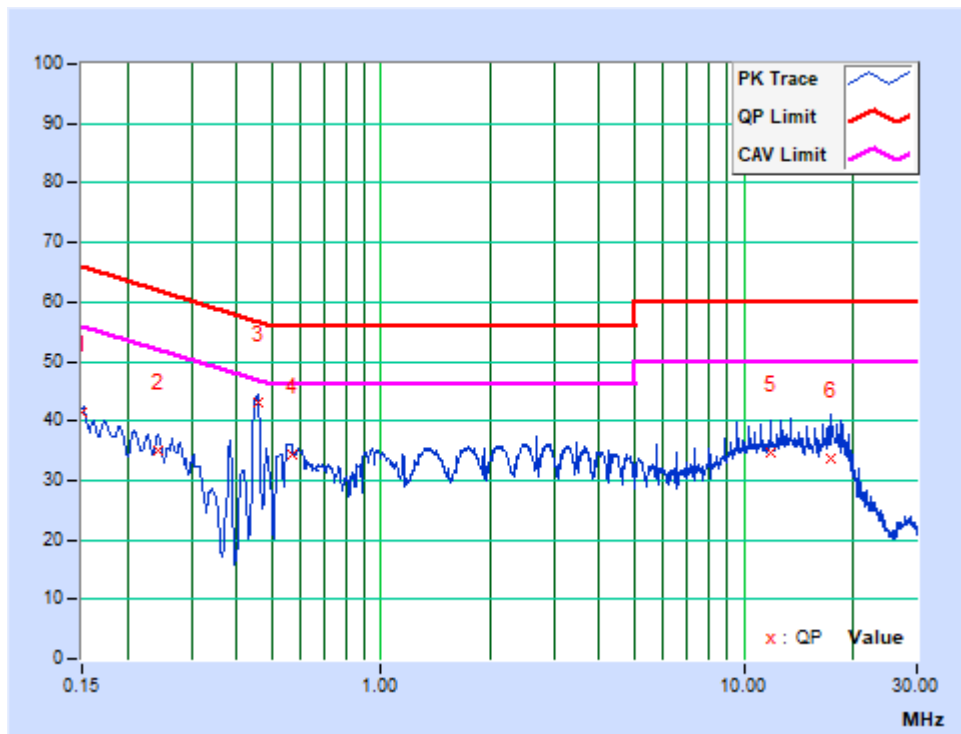



4.2 RADIATED EMISSION MEASUREMENT

4.2.1 LIMITS OF RADIATED EMISSION MEASUREMENT

Radiated emissions which fall in the restricted bands, as defined in Section 15.205(a), must also comply with the radiated emission limits specified in Section 15.209(a).

FREQUENCIES (MHz)	FIELD STRENGTH (microvolts/meter)	MEASUREMENT DISTANCE (meters)
0.009 ~ 0.490	2400/F(kHz)	300
0.490 ~ 1.705	24000/F(kHz)	30
1.705 ~ 30.0	30	30
30 ~ 88	100	3
88 ~ 216	150	3
216 ~ 960	200	3
Above 960	500	3

NOTE:

1. The lower limit shall apply at the transition frequencies.
2. Emission level (dBuV/m) = 20 log Emission level (uV/m).
3. As shown in 15.35(b), for frequencies above 1000MHz, the field strength limits are based on average detector, however, the peak field strength of any emission shall not exceed the maximum permitted average limits, specified above by more than 20dB under any condition of modulation.



4.2.2 TEST INSTRUMENTS

Equipment	Manufacturer	Model No.	Serial No.	Next Cal.
EMI Test Receiver	Rohde&Schwarz	ESU40	100449	Jan. 10, 24
Signal and Spectrum Analyzer	Rohde&Schwarz	FSV7	102331	May 09, 23
Active Loop Antenna (9KHz -30MHz)	SCHWARZBECK	FMZB 1519B	1519B-045	May 20, 23
Amplifier (9KHz -1GHz)	Burgeon	BPA-530	100210	Mar. 08, 23
Trilog-Broadband Antenna(20M-2G)	SCHWARZBECK	VULB 9168	01263	Sep. 30, 23
Horn Antenna (1GHz -18GHz)	ETS -Lindgren	3117	00062558	May 21, 23
Horn Antenna (18GHz -40GHz)	SCHWARZBECK	BBHA 9170	BBHA9170147	May 14, 23
3m Semi-anechoic Chamber	ETS-LINDGREN	9m*6m*6m	NSEMC003	May 22, 23
Test Software	ADT	ADT_Radiated_V7.6.15.9.2	N/A	N/A
Broadband Preamplifier (1GHz~18GHz)	SCHWARZBECK	BBV9718	305	May 12, 23
Pre-Amplifier (18GHz-40GHz)	EMCI	EMC 184045	980102	Jan. 10, 24
Test Software	ADT	ADT_Radiated_V7.6.15.9.2	N/A	N/A
BLUETOOTH TESTER	Rohde&Schwarz	CBT32	100811	N/A

NOTES:

1. The test was performed in 966 Chamber.
2. The calibration interval of the above test instruments is 12 months and the calibrations are traceable to CEPREI/CHINA, GRGT/CHINA and NIM/CHINA.
3. The horn antenna is used only for the measurement of emission frequency above 1GHz if tested.
4. The FCC Site Registration No. is 749762.



4.2.3 TEST PROCEDURES

- a. The EUT was placed on the top of a rotating table 1.5 meters (above 1GHz) and 0.8 meters (below 1GHz) above the ground at a 3 meters semi-anechoic chamber. The table was rotated 360 degrees to determine the position of the highest radiation.
- b. The EUT was set 3 meters away from the interference-receiving antenna, which was mounted on the top of a variable-height antenna tower.
- c. The antenna is a broadband antenna, and its height is varied from one meter to four meters above the ground to determine the maximum value of the field strength. Both horizontal and vertical polarizations of the antenna are set to make the measurement.
- d. For each suspected emission, the EUT was arranged to its worst case and then the antenna was tuned to heights from 1 meter to 4 meters and the rotatable table was turned from 0 degrees to 360 degrees to find the maximum reading.
- e. The test-receiver system was set to Peak Detect Function and Specified Bandwidth with Maximum Hold Mode.
- f. For below 30MHz, a loop antenna with its vertical plane is place 3m from the EUT and rotated about its vertical axis for maximum response at each azimuth about the EUT. And the centre of the loop shall be 1.3m above the ground.
- g. During the test, each emission was maximized by: having the EUT continuously working, investigated all operating modes, rotated about all 3 axis (X, Y & Z) and considered typical configuration to obtain worst position, manipulating interconnecting cables, For battery operated equipment, the equipment tests shall be perform using fresh batteries. The turntable was rotated to maximize the emission level.

NOTE:

1. The resolution bandwidth and video bandwidth of test receiver/spectrum analyzer is 120kHz for Quasi-peak detection at frequency below 1GHz.
2. The resolution bandwidth of test receiver/spectrum analyzer is 1 MHz and video bandwidth is 3MHz for Peak detection at frequency above 1GHz.
3. The resolution bandwidth of test receiver/spectrum analyzer is 1MHz and the video bandwidth is $\geq 1/T$ (Duty cycle < 98%) or 10Hz(Duty cycle > 98%) for Average detection (AV) at frequency above 1GHz.
4. All modes of operation were investigated and the worst-case emissions are reported.
5. The testing of the EUT was performed on all 3 orthogonal axes; the worst-case test configuration was reported on the file test setup photo.



4.2.4 DEVIATION FROM TEST STANDARD

No deviation.

4.2.5 TEST SETUP

Below 30MHz test setup

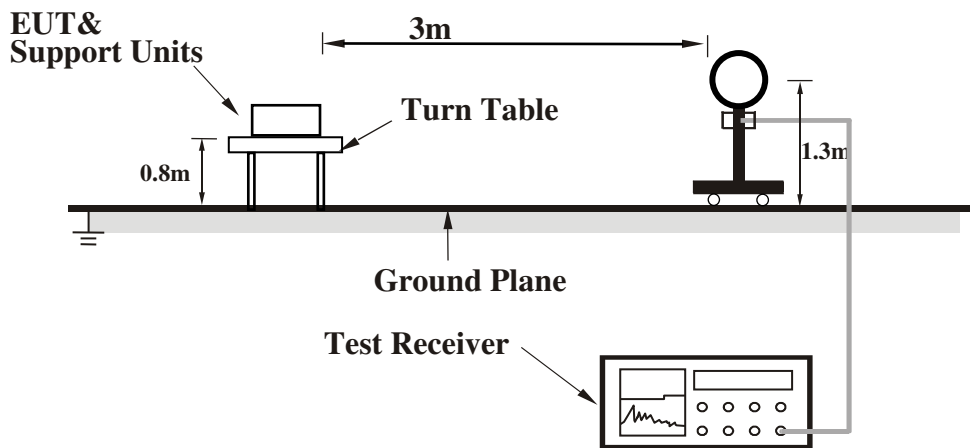

Below 1GHz test setup

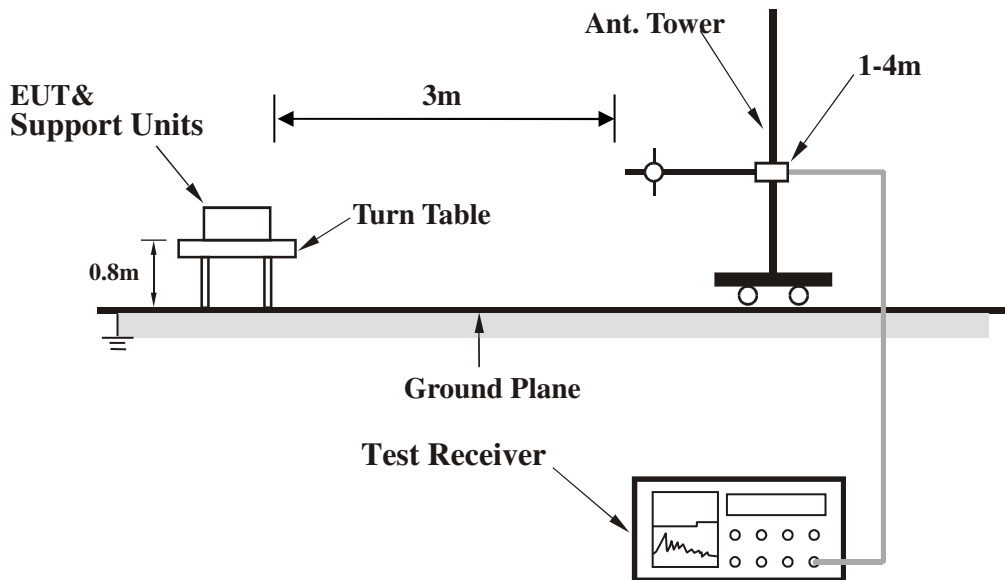

Note: For the actual test configuration, please refer to the attached file (Test Setup Photo).



Above 1GHz test setup

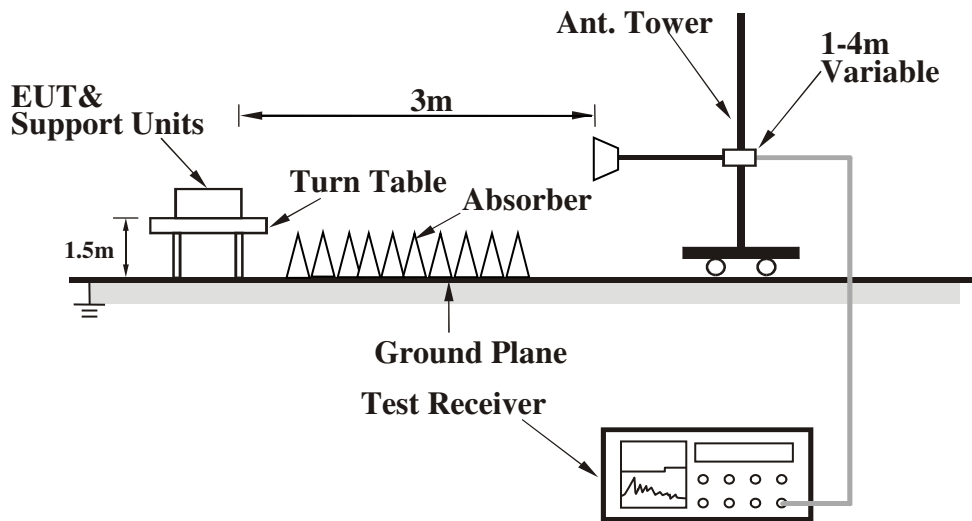

Note: For the actual test configuration, please refer to the attached file (Test Setup Photo).

4.2.6 EUT OPERATING CONDITIONS

- Set the EUT under full load condition and placed them on a testing table.
- Set the transmitter part of EUT under transmission condition continuously at specific channel frequency.
- The necessary accessories enable the EUT in full functions.



4.2.7 TEST RESULTS

BELOW 1GHz WORST-CASE DATA:

BT-LE GFSK

CHANNEL	TX Channel 39	DETECTOR FUNCTION	Quasi-Peak (QP)
FREQUENCY RANGE	9KHz ~ 1GHz		

ANTENNA POLARITY & TEST DISTANCE: HORIZONTAL AT 3 M								
NO.	FREQ. (MHz)	EMISSION LEVEL (dBuV/m)	LIMIT (dBuV/m)	MARGIN (dB)	ANTENNA HEIGHT (m)	TABLE ANGLE (Degree)	RAW VALUE (dBuV)	CORRECTION FACTOR (dB/m)
1	168.35	13.29 QP	43.50	-30.21	1.82 H	297	29.40	-16.11
2	261.62	20.47 QP	46.00	-25.53	1.96 H	313	36.30	-15.83
3	340.90	15.29 QP	46.00	-30.71	2.00 H	327	28.73	-13.44
4	508.78	19.52 QP	46.00	-26.48	2.00 H	342	28.63	-9.11
5	619.15	21.76 QP	46.00	-24.24	2.00 H	355	28.25	-6.49
6	807.24	25.81 QP	46.00	-20.19	2.00 H	0	29.29	-3.48

REMARKS:

1. Emission level (dBuV/m) = Raw Value (dBuV) + Correction Factor (dB/m).
2. Correction Factor (dB/m) = Antenna Factor (dB/m) + Cable Factor (dB).
3. The emission levels of other frequencies were greater than 20dB margin.
4. 9KHz~30MHz have been test and test data more than 20dB margin.
5. Margin value = Emission level – Limit value

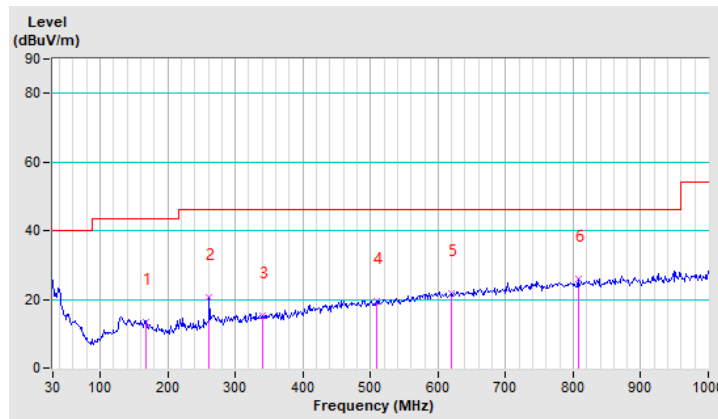



**BUREAU
VERITAS**

Test Report No.: RF2212WDG0106-4

CHANNEL	TX Channel 39	DETECTOR FUNCTION	Quasi-Peak (QP)
FREQUENCY RANGE	9KHz ~ 1GHz		

ANTENNA POLARITY & TEST DISTANCE: VERTICAL AT 3 M								
NO.	FREQ. (MHz)	EMISSION LEVEL (dBuV/m)	LIMIT (dBuV/m)	MARGIN (dB)	ANTENNA HEIGHT (m)	TABLE ANGLE (Degree)	RAW VALUE (dBuV)	CORRECTION FACTOR (dB/m)
1	168.35	13.63 QP	43.50	-29.87	1.50 V	74	29.74	-16.11
2	261.62	14.79 QP	46.00	-31.21	1.50 V	90	30.62	-15.83
3	418.62	15.89 QP	46.00	-30.11	1.47 V	148	27.06	-11.17
4	462.15	17.14 QP	46.00	-28.86	1.50 V	135	26.99	-9.85
5	580.29	21.65 QP	46.00	-24.35	1.50 V	105	28.98	-7.33
6	685.99	21.48 QP	46.00	-24.52	1.50 V	119	26.90	-5.42

REMARKS:

1. Emission level (dBuV/m) = Raw Value (dBuV) + Correction Factor (dB/m).
2. Correction Factor (dB/m) = Antenna Factor (dB/m) + Cable Factor (dB).
3. The emission levels of other frequencies were greater than 20dB margin.
4. 9KHz~30MHz have been test and test data more than 20dB margin.
5. Margin value = Emission level – Limit value

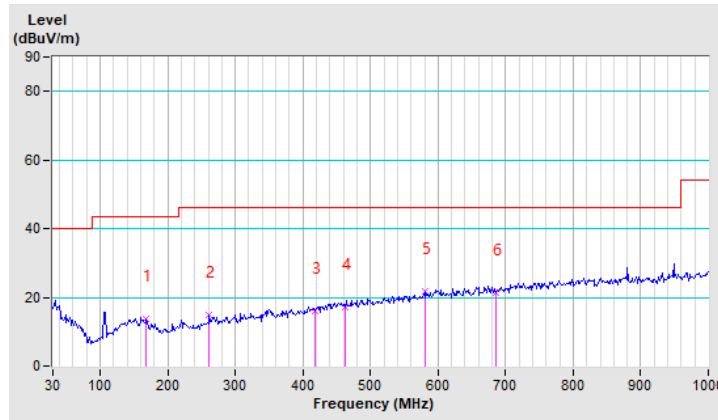

**Bureau Veritas Shenzhen Co., Ltd.
Dongguan Branch**

No. 96, Guantai Road (Houjie Section), Houjie
Town, Dongguan City, Guangdong Province.
523942. People's Republic of China.

Tel: +86 769 8998 2098
Fax: +86 769 8593 1080
Email: customerservice.dg@bureauveritas.com



ABOVE 1GHz TEST DATA:

BT-LE GFSK

CHANNEL	TX Channel 0	DETECTOR FUNCTION	Peak (PK)
FREQUENCY RANGE	1GHz ~ 25GHz		Average (AV)

ANTENNA POLARITY & TEST DISTANCE : HORIZONTAL AT 3 M

NO.	FREQ. (MHz)	EMISSION LEVEL (dBuV/m)	LIMIT (dBuV/m)	MARGIN (dB)	ANTENNA HEIGHT (m)	TABLE ANGLE (Degree)	RAW VALUE (dBuV)	CORRECTION FACTOR (dB/m)
1	2390.00	48.15 PK	74.00	-25.85	2.49 H	345	45.35	2.80
2	2390.00	36.80 AV	54.00	-17.20	2.49 H	345	34.00	2.80
3	*2402.00	99.35 PK			2.49 H	345	96.51	2.84
4	*2402.00	98.54 AV			2.49 H	345	95.70	2.84
5	4804.00	50.27 PK	74.00	-23.73	1.72 H	85	43.21	7.06
6	4804.00	38.80 AV	54.00	-15.20	1.72 H	85	31.74	7.06
7	#7206.00	49.62 PK	74.00	-24.38	2.20 H	50	39.67	9.95
8	#7206.00	37.80 AV	54.00	-16.20	2.20 H	50	27.85	9.95

ANTENNA POLARITY & TEST DISTANCE : VERTICAL AT 3 M

NO.	FREQ. (MHz)	EMISSION LEVEL (dBuV/m)	LIMIT (dBuV/m)	MARGIN (dB)	ANTENNA HEIGHT (m)	TABLE ANGLE (Degree)	RAW VALUE (dBuV)	CORRECTION FACTOR (dB/m)
1	2390.00	44.80 PK	74.00	-29.20	1.42 V	346	42.00	2.80
2	2390.00	36.25 AV	54.00	-17.75	1.42 V	346	33.45	2.80
3	*2402.00	101.59 PK			1.42 V	346	98.75	2.84
4	*2402.00	100.09 AV			1.42 V	346	97.25	2.84
5	4804.00	48.63 PK	74.00	-25.37	1.45 V	95	41.57	7.06
6	4804.00	39.20 AV	54.00	-14.80	1.45 V	95	32.14	7.06
7	#7206.00	50.02 PK	74.00	-23.98	1.54 V	300	40.07	9.95
8	#7206.00	39.87 AV	54.00	-14.13	1.54 V	300	29.92	9.95

REMARKS:

1. Emission level (dBuV/m) = Raw Value (dBuV) + Correction Factor (dB/m).
2. Correction Factor (dB/m) = Antenna Factor (dB/m) + Cable Factor (dB).
3. The emission levels of other frequencies were greater than 20dB margin.
4. Margin value = Emission level – Limit value.
5. " * ": Fundamental frequency.
6. " # ": The radiated frequency is out of the restricted band.



**BUREAU
VERITAS**

Test Report No.: RF2212WDG0106-4

CHANNEL	TX Channel 19	DETECTOR FUNCTION	Peak (PK)
FREQUENCY RANGE	1GHz ~ 25GHz		Average (AV)

ANTENNA POLARITY & TEST DISTANCE : HORIZONTAL AT 3 M								
NO.	FREQ. (MHz)	EMISSION LEVEL (dBuV/m)	LIMIT (dBuV/m)	MARGIN (dB)	ANTENNA HEIGHT (m)	TABLE ANGLE (Degree)	RAW VALUE (dBuV)	CORRECTION FACTOR (dB/m)
1	*2440.00	99.37 PK			1.24 H	318	96.42	2.95
2	*2440.00	99.04 AV			1.24 H	318	96.09	2.95
3	4880.00	48.59 PK	74.00	-25.41	1.78 H	85	40.97	7.62
4	4880.00	39.25 AV	54.00	-14.75	1.78 H	85	31.63	7.62
5	7320.00	50.08 PK	74.00	-23.92	1.04 H	87	39.98	10.10
6	7320.00	39.70 AV	54.00	-14.30	1.04 H	87	29.60	10.10
ANTENNA POLARITY & TEST DISTANCE : VERTICAL AT 3 M								
NO.	FREQ. (MHz)	EMISSION LEVEL (dBuV/m)	LIMIT (dBuV/m)	MARGIN (dB)	ANTENNA HEIGHT (m)	TABLE ANGLE (Degree)	RAW VALUE (dBuV)	CORRECTION FACTOR (dB/m)
1	*2440.00	100.81 PK			1.24 V	341	97.86	2.95
2	*2440.00	100.31 AV			1.24 V	341	97.36	2.95
3	4880.00	48.24 PK	74.00	-25.76	1.24 V	178	40.62	7.62
4	4880.00	38.79 AV	54.00	-15.21	1.24 V	178	31.17	7.62
5	7320.00	49.18 PK	74.00	-24.82	1.47 V	241	39.08	10.10
6	7320.00	38.10 AV	54.00	-15.90	1.47 V	241	28.00	10.10

REMARKS:

1. Emission level (dBuV/m) = Raw Value (dBuV) + Correction Factor (dB/m).
2. Correction Factor (dB/m) = Antenna Factor (dB/m) + Cable Factor (dB).
3. The emission levels of other frequencies were greater than 20dB margin.
4. Margin value = Emission level – Limit value.
5. " * ": Fundamental frequency.

Bureau Veritas Shenzhen Co., Ltd.
Dongguan Branch

No. 96, Guantai Road (Houjie Section), Houjie
Town, Dongguan City, Guangdong Province.
523942. People's Republic of China.

Tel: +86 769 8998 2098
Fax: +86 769 8593 1080
Email: customerservice.dg@bureauveritas.com



CHANNEL	TX Channel 39	DETECTOR FUNCTION	Peak (PK)
FREQUENCY RANGE	1GHz ~ 25GHz		Average (AV)

ANTENNA POLARITY & TEST DISTANCE : HORIZONTAL AT 3 M

NO.	FREQ. (MHz)	EMISSION LEVEL (dBuV/m)	LIMIT (dBuV/m)	MARGIN (dB)	ANTENNA HEIGHT (m)	TABLE ANGLE (Degree)	RAW VALUE (dBuV)	CORRECTION FACTOR (dB/m)
1	*2480.00	98.70 PK			1.60 H	316	95.63	3.07
2	*2480.00	98.11 AV			1.60 H	316	95.04	3.07
3	2483.50	49.50 PK	74.00	-24.50	1.60 H	219	46.42	3.08
4	2483.50	58.20 PK	74.00	-15.80	1.60 H	316	55.12	3.08
5	2483.50	35.84 AV	54.00	-18.16	1.60 H	219	32.76	3.08
6	2483.50	38.24 AV	54.00	-15.76	1.60 H	316	35.16	3.08
7	7440.00	51.20 PK	74.00	-22.80	2.54 H	95	40.93	10.27
8	7440.00	38.69 AV	54.00	-15.31	2.54 H	95	28.42	10.27

ANTENNA POLARITY & TEST DISTANCE : VERTICAL AT 3 M

NO.	FREQ. (MHz)	EMISSION LEVEL (dBuV/m)	LIMIT (dBuV/m)	MARGIN (dB)	ANTENNA HEIGHT (m)	TABLE ANGLE (Degree)	RAW VALUE (dBuV)	CORRECTION FACTOR (dB/m)
1	*2480.00	99.80 PK			1.72 V	85	96.73	3.07
2	*2480.00	99.24 AV			1.72 V	85	96.17	3.07
3	2483.50	49.20 PK	74.00	-24.80	1.29 V	250	46.12	3.08
4	2483.50	38.00 AV	54.00	-16.00	1.29 V	250	34.92	3.08
5	4960.00	51.17 PK	74.00	-22.83	1.42 V	85	42.96	8.21
6	4960.00	39.27 AV	54.00	-14.73	1.42 V	85	31.06	8.21
7	7440.00	51.20 PK	74.00	-22.80	1.25 V	95	40.93	10.27
8	7440.00	40.20 AV	54.00	-13.80	1.25 V	95	29.93	10.27

REMARKS:

1. Emission level (dBuV/m) = Raw Value (dBuV) + Correction Factor (dB/m).
2. Correction Factor (dB/m) = Antenna Factor (dB/m) + Cable Factor (dB).
3. The emission levels of other frequencies were greater than 20dB margin.
4. Margin value = Emission level – Limit value.
5. " * " : Fundamental frequency.



ABOVE 1GHz WORST-CASE DATA: (CH 0)

“BM82A” and “BM65T” Simultaneous Transmitting

CHANNEL	TX Channel 0	DETECTOR FUNCTION	Peak (PK)
FREQUENCY RANGE	1GHz ~ 25GHz		Average (AV)

ANTENNA POLARITY & TEST DISTANCE: HORIZONTAL AT 3 M								
NO.	FREQ. (MHz)	EMISSION LEVEL (dBuV/m)	LIMIT (dBuV/m)	MARGIN (dB)	ANTENNA HEIGHT (m)	TABLE ANGLE (Degree)	RAW VALUE (dBuV)	CORRECTION FACTOR (dB/m)
1	2390.00	50.20 PK	74.00	-23.80	1.00 H	125	48.64	1.56
2	2390.00	39.35 AV	54.00	-14.65	1.00 H	125	37.79	1.56
3	*2402.00	107.25 PK			1.57 H	335	105.27	1.98
4	*2402.00	105.25 AV			1.57 H	335	103.27	1.98
5	4804.00	50.20 PK	74.00	-23.80	1.00 H	127	42.96	7.24
6	4804.00	37.36 AV	54.00	-16.64	1.00 H	127	30.12	7.24
7	#7206.00	52.41 PK	74.00	-21.59	1.00 H	156	40.96	11.45
8	#7206.00	40.75 AV	54.00	-13.25	1.00 H	156	29.30	11.45

ANTENNA POLARITY & TEST DISTANCE: VERTICAL AT 3 M								
NO.	FREQ. (MHz)	EMISSION LEVEL (dBuV/m)	LIMIT (dBuV/m)	MARGIN (dB)	ANTENNA HEIGHT (m)	TABLE ANGLE (Degree)	RAW VALUE (dBuV)	CORRECTION FACTOR (dB/m)
1	2390.00	48.52 PK	74.00	-25.48	1.06 V	96	46.96	1.56
2	2390.00	39.63 AV	54.00	-14.37	1.06 V	96	38.07	1.56
3	*2402.00	103.21 PK			1.64 V	289	101.23	1.98
4	*2402.00	101.23 AV			1.64 V	289	99.25	1.98
5	4804.00	49.36 PK	74.00	-24.64	1.00 V	128	42.12	7.24
6	4804.00	36.74 AV	54.00	-17.26	1.00 V	128	29.50	7.24
7	#7206.00	52.35 PK	74.00	-21.65	1.04 V	157	40.90	11.45
8	#7206.00	39.51 AV	54.00	-14.49	1.04 V	157	28.06	11.45

REMARKS:

1. Emission level (dBuV/m) = Raw Value (dBuV) + Correction Factor (dB/m).
2. Correction Factor (dB/m) = Antenna Factor (dB/m) + Cable Factor (dB).
3. The emission levels of other frequencies were greater than 20dB margin.
4. Margin value = Emission level – Limit value.
5. " * ": Fundamental frequency.
6. " # ": The radiated frequency is out of the restricted band.



4.3 6dB BANDWIDTH MEASUREMENT

4.3.1 LIMITS OF 6dB BANDWIDTH MEASUREMENT

The minimum of 6dB Bandwidth Measurement is 0.5 MHz.

4.3.2 TEST INSTRUMENTS

Equipment	Manufacturer	Model No.	Serial No.	Next Cal.
Power Sensor	Keysight	U2021XA	MY57320002	Jan. 11, 24
Power Sensor	Keysight	U2021XA	MY55060018	May 09, 23
Digital Multimeter	FLUKE	15B	A1220010DG	N/A
Humid & Temp Programmable Tester	Haida	HD-225T	110807201	Nov. 03, 23
Oscilloscope	Agilent	DSO9254A	MY51260160	Aug. 11, 23
Signal and Spectrum Analyzer	Rohde&Schwarz	FSV40	101094	Jan. 16, 24
Signal Generator	Agilent	N5183A	MY50140980	Sep. 18, 23
MXG-B RF Vector Signal Generator	Keysight	N5182B	MY56200288	Sep. 14, 23
BLUETOOTH TESTER	Rohde&Schwarz	CBT32	100811	N/A
Attenuator	MINI	BW-S10W2+	S130129FGE2	N/A
DC Source	Keysight	E3642A	MY56146098	N/A
Test software	ADT	ADT_RF Test Software V6.6.5.3	N/A	N/A

NOTES:

1. The test was performed in RF Oven room.
2. The calibration interval of the above test instruments is 12 months and the calibrations are traceable to CEPREI/CHINA, GRGT/CHINA and NIM/CHINA.



**BUREAU
VERITAS**

Test Report No.: RF2212WDG0106-4

4.3.3 TEST PROCEDURE

1. Set RBW = 100 kHz.
2. Set the video bandwidth (VBW) ≥ 3 RBW.
3. Detector = Peak.
4. Trace mode = max hold.
5. Sweep = auto couple.
6. Allow the trace to stabilize.
7. Measure the maximum width of the emission that is constrained by the frequencies associated with the two outermost amplitude points (upper and lower frequencies) that are attenuated by 6 dB relative to the maximum level measured in the fundamental emission.

4.3.4 DEVIATION FROM TEST STANDARD

No deviation.



4.3.5 TEST SETUP

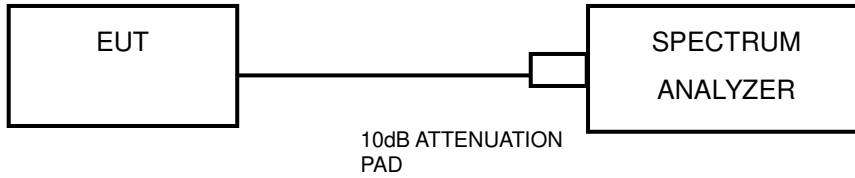

4.3.6 EUT OPERATING CONDITIONS

The software provided by client to enable the EUT under transmission condition continuously at lowest, middle and highest channel frequencies individually.



BUREAU VERITAS

Test Report No.: RF2212WDG0106-4

4.3.7 TEST RESULTS

BT-LE GFSK

CHANNEL	CHANNEL FREQUENCY (MHz)	6dB BANDWIDTH (MHz)	MINIMUM LIMIT (MHz)	PASS / FAIL
0	2402	0.72	0.5	PASS
19	2440	0.73	0.5	PASS
39	2480	0.73	0.5	PASS

CHO

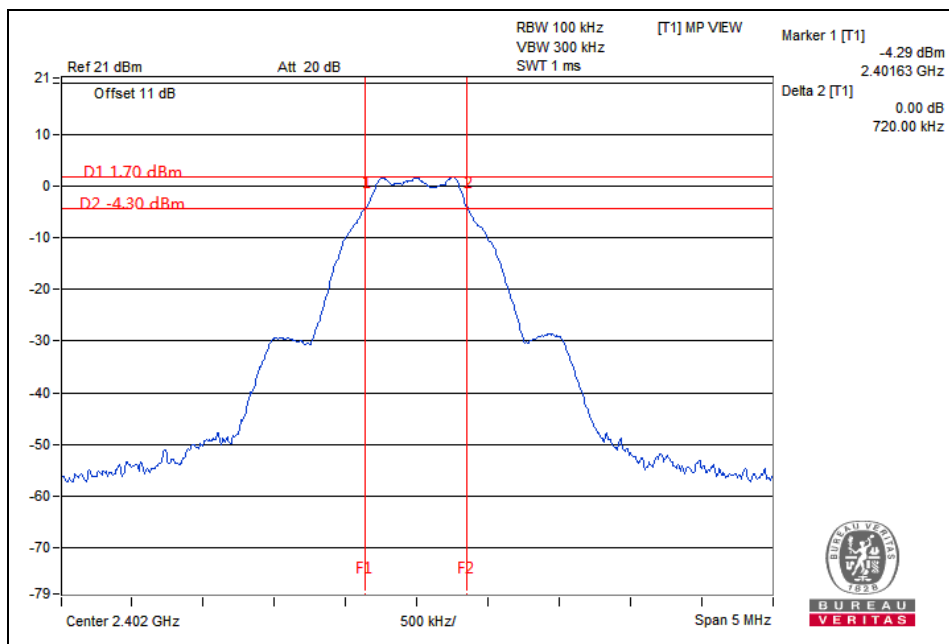



BUREAU VERITAS

Test Report No.: RF2212WDG0106-4

CH19

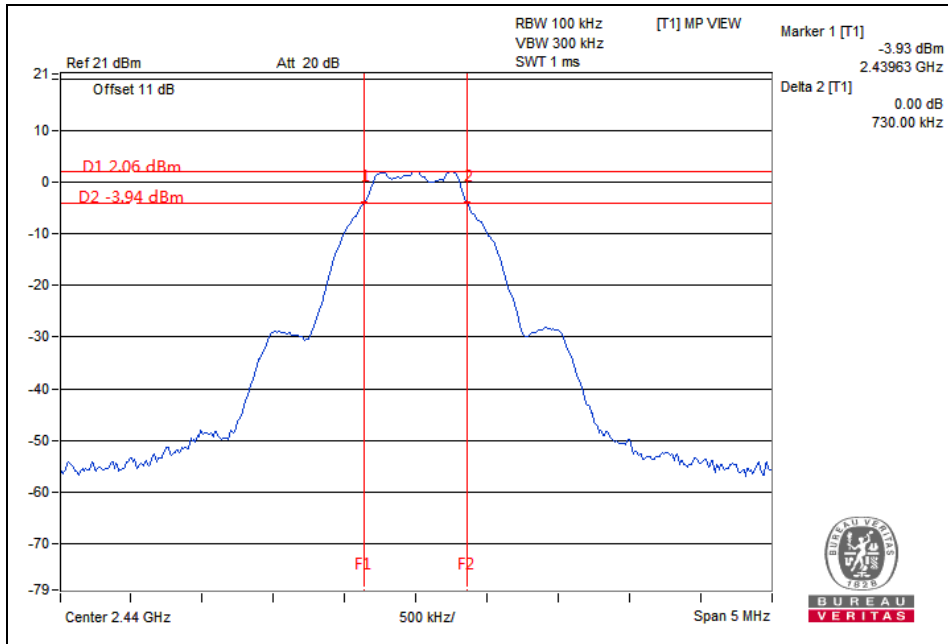

CH39

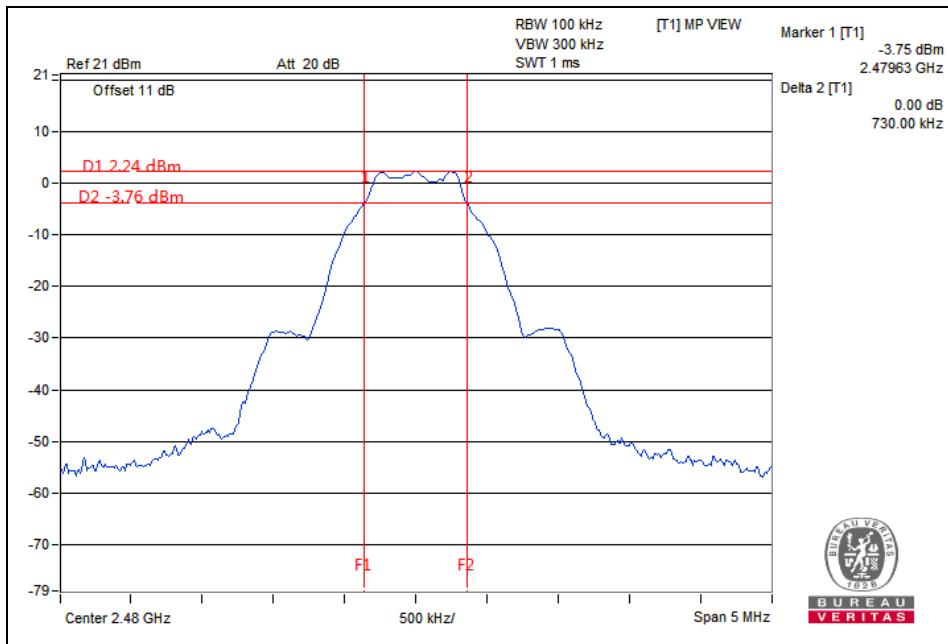

Bureau Veritas Shenzhen Co., Ltd.
Dongguan Branch

No. 96, Guantai Road (Houjie Section), Houjie
Town, Dongguan City, Guangdong Province.
523942. People's Republic of China.

Tel: +86 769 8998 2098
Fax: +86 769 8593 1080
Email: customerservice.dg@bureauveritas.com



4.4 CONDUCTED OUTPUT POWER

4.4.1 LIMITS OF CONDUCTED OUTPUT POWER MEASUREMENT

For systems using digital modulation in the 2400–2483.5 MHz band: 1 Watt (30dBm)

4.4.2 TEST SETUP

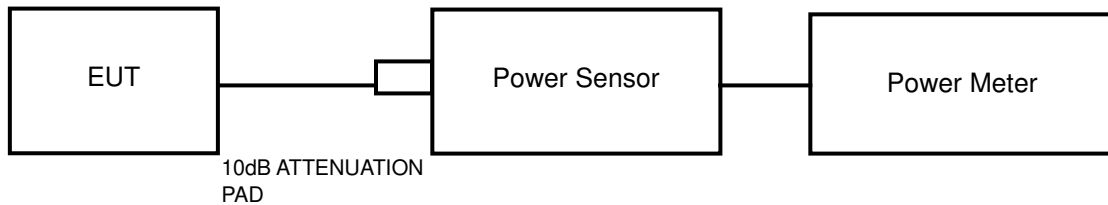

4.4.3 TEST INSTRUMENTS

Refer to section 4.3.2 to get information of above instrument.

4.4.4 TEST PROCEDURES

A peak power sensor was used on the output port of the EUT. A power meter was used to read the response of the peak power sensor and set the detector to PEAK. Record the power level.

An average power sensor was used on the output port of the EUT. A power meter was used to read the response of the average power sensor and set the detector to AVERAGE. Record the power level.

4.4.5 DEVIATION FROM TEST STANDARD

No deviation.

4.4.6 EUT OPERATING CONDITIONS

The software provided by client to enable the EUT under transmission condition continuously at lowest, middle and highest channel frequencies individually.



4.4.7 TEST RESULTS

4.4.7.1 MAXIMUM PEAK OUTPUT POWER

BT-LE GFSK

CHANNEL	CHANNEL FREQUENCY (MHz)	PEAK POWER (dBm)	PEAK POWER (mW)	PEAK POWER LIMIT (W)	PASS/FAIL
0	2402	4.23	2.649	1	PASS
19	2440	4.61	2.891	1	PASS
39	2480	4.72	2.965	1	PASS

4.4.7.2 AVERAGE OUTPUT POWER (FOR REFERENCE)

The average power sensor was used on the output port of the EUT. A power meter was used to read the response of the power sensor. Record the power level.

BT-LE GFSK

CHANNEL	CHANNEL FREQUENCY (MHz)	AVERAGE POWER (dBm)
0	2402	2.57
19	2440	2.98
39	2480	3.08



4.5 POWER SPECTRAL DENSITY MEASUREMENT

4.5.1 LIMITS OF POWER SPECTRAL DENSITY MEASUREMENT

The Maximum of Power Spectral Density Measurement is 8dBm/3KHz.

4.5.2 TEST SETUP

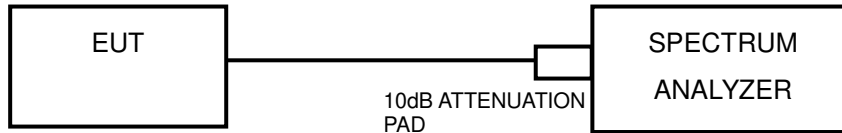

4.5.3 TEST INSTRUMENTS

Refer to section 4.3.2 to get information of above instrument.

4.5.4 TEST PROCEDURE

1. Set the span to 1.5 times the DTS bandwidth
2. Set the RBW = 3 kHz, VBW $\geq 3 \times$ RBW, Detector = peak.
3. Sweep time = auto couple, Trace mode = max hold, allow trace to fully stabilize.
4. Use the peak marker function to determine the maximum amplitude level.

4.5.5 DEVIATION FROM TEST STANDARD

No deviation.

4.5.6 EUT OPERATING CONDITION

The software provided by client to enable the EUT under transmission condition continuously at lowest, middle and highest channel frequencies individually.



BUREAU
VERITAS

Test Report No.: RF2212WDG0106-4

4.5.7 TEST RESULTS

BT-LE GFSK

Channel	FREQ. (MHz)	PSD (dBm/3kHz)	Limit (dBm/3kHz)	PASS /FAIL
0	2402	-12.86	8	PASS
19	2440	-12.46	8	PASS
39	2480	-12.33	8	PASS

CH0

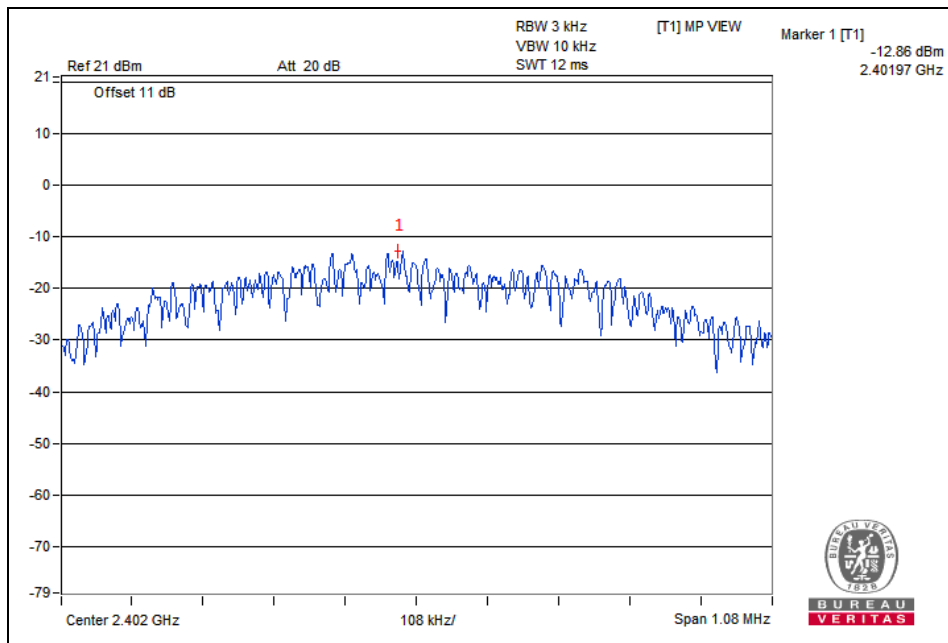



BUREAU VERITAS

Test Report No.: RF2212WDG0106-4

CH19

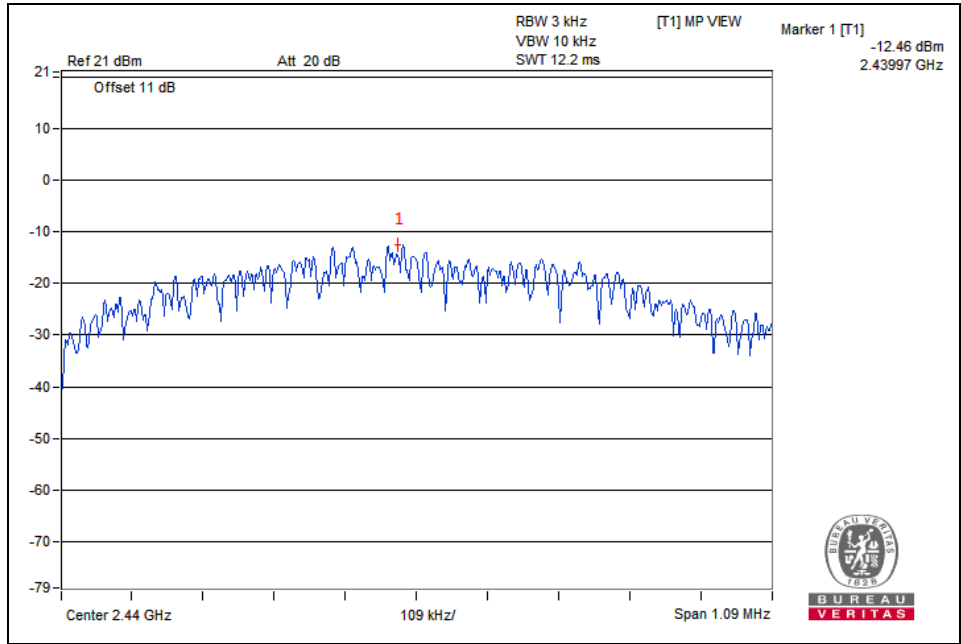

CH39

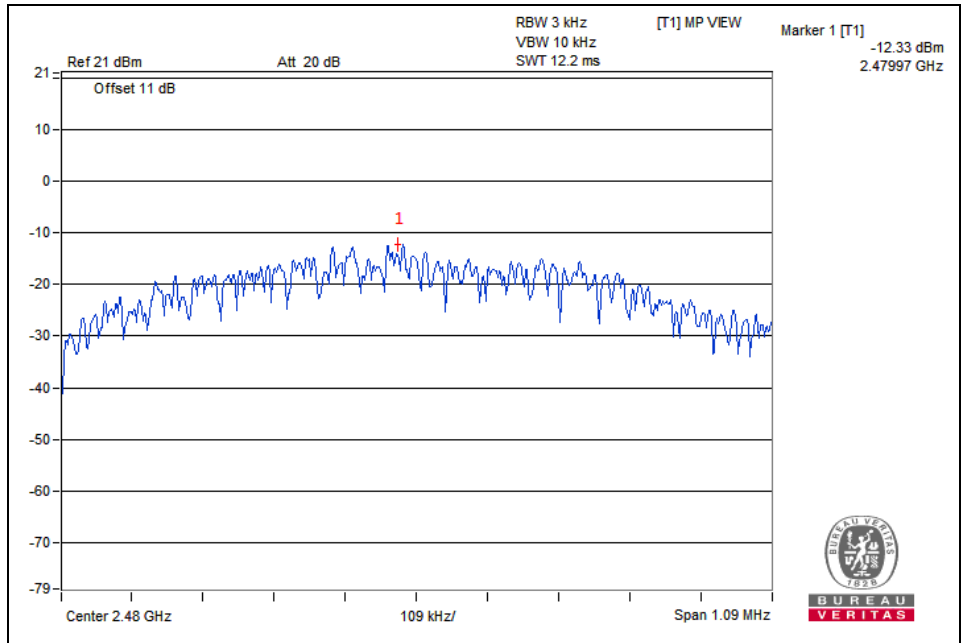

Bureau Veritas Shenzhen Co., Ltd.
Dongguan Branch

No. 96, Guantai Road (Houjie Section), Houjie
Town, Dongguan City, Guangdong Province.
523942. People's Republic of China.

Tel: +86 769 8998 2098
Fax: +86 769 8593 1080
Email: customerservice.dg@bureauveritas.com



4.6 OUT OF BAND EMISSION MEASUREMENT

4.6.1 LIMITS OF OUT OF BAND EMISSION MEASUREMENT

Below -20dB of the highest emission level of operating band (in 100kHz Resolution Bandwidth).

4.6.2 TEST SETUP

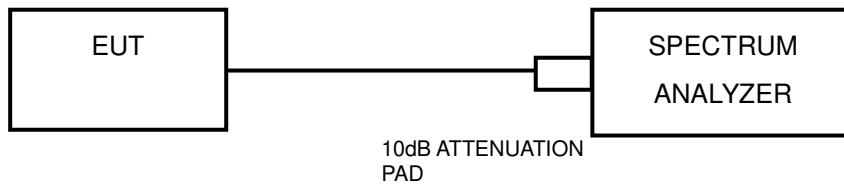

4.6.3 TEST INSTRUMENTS

Refer to section 4.3.2 to get information of above instrument.

4.6.4 TEST PROCEDURE

MEASUREMENT PROCEDURE REF

1. Set the RBW = 100 kHz.
2. Set the VBW \geq 300 kHz.
3. Detector = peak.
4. Sweep time = auto couple.
5. Trace mode = max hold.
6. Allow trace to fully stabilize.
7. Use the peak marker function to determine the maximum power level in any 100 kHz band segment within the fundamental EBW.



**BUREAU
VERITAS**

Test Report No.: RF2212WDG0106-4

MEASUREMENT PROCEDURE OOBE

1. Set RBW = 100 kHz.
2. Set VBW \geq 300 kHz.
3. Set span to encompass the spectrum to be examined
4. Detector = peak.
5. Trace Mode = max hold.
6. Sweep = auto couple.

4.6.5 DEVIATION FROM TEST STANDARD

No deviation.

4.6.6 EUT OPERATING CONDITION

The software provided by client to enable the EUT under transmission condition continuously at lowest, middle and highest channel frequencies individually.



BUREAU VERITAS

Test Report No.: RF2212WDG0106-4

4.6.7 TEST RESULTS

BT-LE GFSK

CH 0

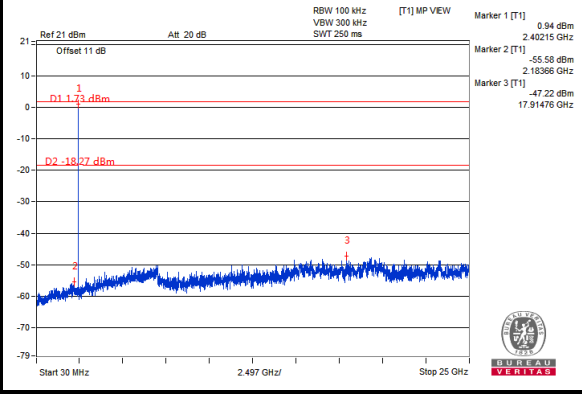
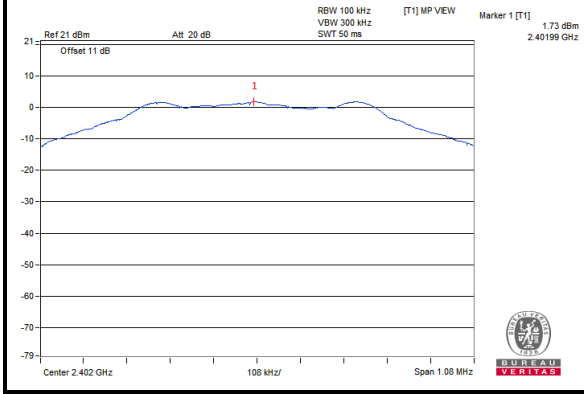

CH 19

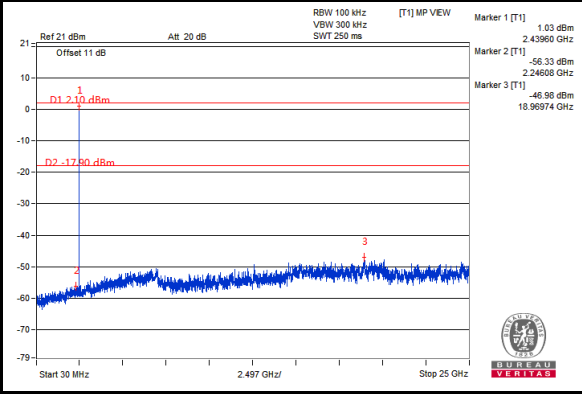
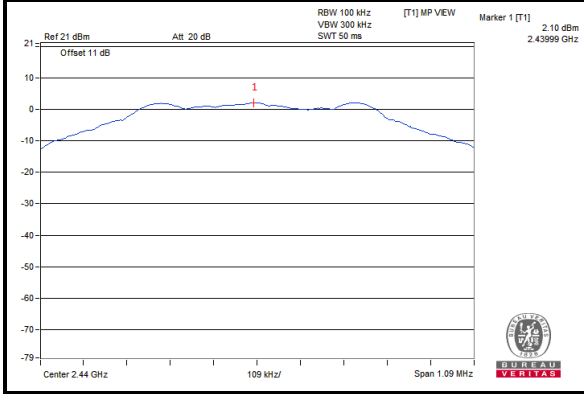

CH 39

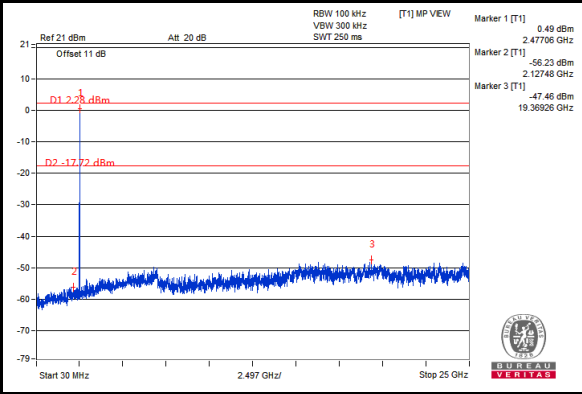
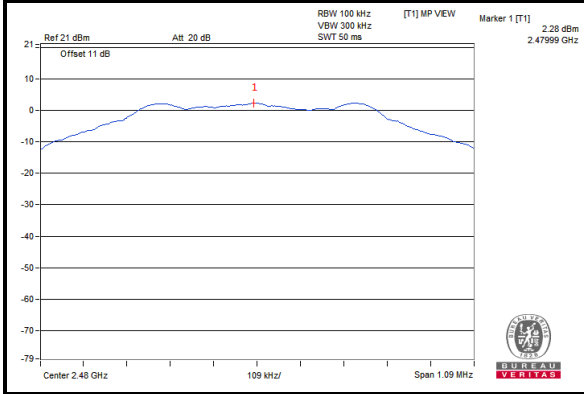

Bureau Veritas Shenzhen Co., Ltd.
Dongguan Branch

No. 96, Guantai Road (Houjie Section), Houjie
Town, Dongguan City, Guangdong Province.
523942, People's Republic of China.

Tel: +86 769 8998 2098
Fax: +86 769 8593 1080
Email: customerservice.dg@bureauveritas.com



BUREAU VERITAS

Test Report No.: RF2212WDG0106-4

BT-LE GFSK Band Edge:

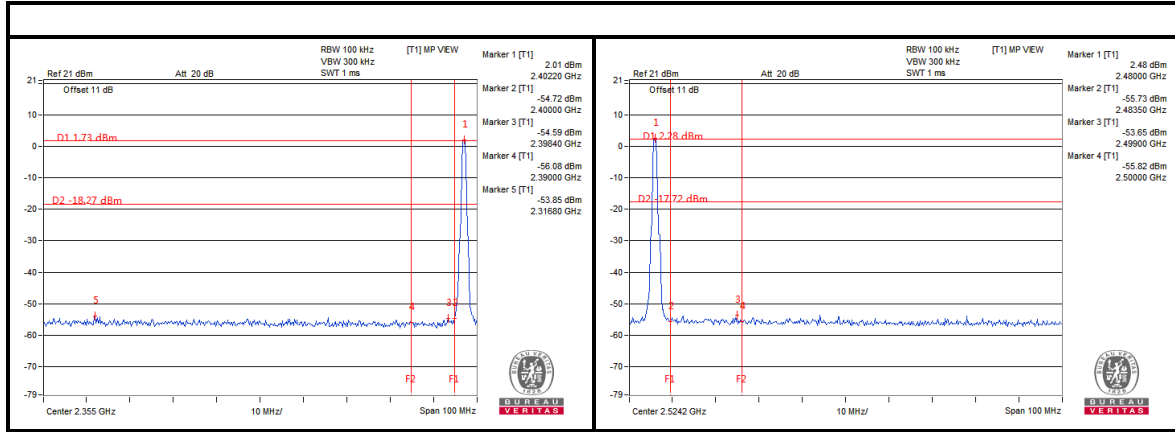

Bureau Veritas Shenzhen Co., Ltd.
Dongguan Branch

No. 96, Guantai Road (Houjie Section), Houjie
Town, Dongguan City, Guangdong Province.
523942. People's Republic of China.

Tel: +86 769 8998 2098
Fax: +86 769 8593 1080
Email: customerservice.dg@bureauveritas.com



**BUREAU
VERITAS**

Test Report No.: RF2212WDG0106-4

5 PHOTOGRAPHS OF THE TEST CONFIGURATION

Please refer to the attached file (Test Setup Photo).



**BUREAU
VERITAS**

Test Report No.: RF2212WDG0106-4

6 APPENDIX A - MODIFICATIONS RECORDERS FOR ENGINEERING CHANGES TO THE EUT BY THE LAB

No any modifications are made to the EUT by the lab during the test.

---END---