



Test Report No.: RF2212WDG0106-3



# TEST REPORT



Applicant	Tonly Technology Co., Ltd.
Address	Section 37, Zhongkai High-tech Development Zone, Huizhou City, Guangdong Province, P.R. China

Manufacturer or Supplier	Sony Corporation
Address	1-7-1 Konan Minato-ku Tokyo, 108-0075 Japan
Product	ACTIVE FRONT SPEAKER
Brand Name	SONY
Model	YY2078C1
Additional Models & Model Difference	N/A
Date of tests	Jan. 05, 2023 ~ Feb. 01, 2023

The tests have been carried out according to the requirements of the following standards:

**FCC Part 15, Subpart C, Section 15.247**

**CONCLUSION: The submitted sample was found to COMPLY with the test requirement**

Tested by Lucas Chen Project Engineer / EMC Department	Approved by Glyn He Assistant Manager / EMC Department
	 Date: Mar. 03, 2023

This report is governed by, and incorporates by reference, the Conditions of Testing as posted at the date of issuance of this report at <http://www.bureauveritas.com/home/about-us/our-business/cps/about-us/terms-conditions/> and is intended for your exclusive use. Any copying or replication of this report to or for any other person or entity, or use of our name or trademark, is permitted only with our prior written permission. This report sets forth our findings solely with respect to the test samples identified herein. The results set forth in this report are not indicative or representative of the quality or characteristics of the lot from which a test sample was taken or any similar or identical product unless specifically and expressly noted. Our report includes all of the tests requested by you and the results thereof based upon the information that you provided to us. Measurement uncertainty is only provided upon request for accredited tests. Statements of conformity are based on simple acceptance criteria without taking measurement uncertainty into account, unless otherwise requested in writing. You have 60 days from date of issuance of this report to notify us of any material error or omission caused by our negligence or if you require measurement uncertainty; provided, however, that such notice shall be in writing and shall specifically address the issue you wish to raise. A failure to raise such issue within the prescribed time shall constitute your unqualified acceptance of the completeness of this report, the tests conducted and the correctness of the report contents.

Bureau Veritas Shenzhen Co., Ltd.  
Dongguan Branch

No. 96, Guantai Road (Houjie Section), Houjie  
Town, Dongguan City, Guangdong Province.  
523942. People's Republic of China.

Tel: +86 769 8998 2098  
Fax: +86 769 8593 1080  
Email: [customerservice\\_dg@bureauveritas.com](mailto:customerservice_dg@bureauveritas.com)



## TABLE OF CONTENTS

<b>RELEASE CONTROL RECORD</b> .....	<b>5</b>
<b>1 SUMMARY OF TEST RESULTS</b> .....	<b>6</b>
<b>2 MEASUREMENT UNCERTAINTY</b> .....	<b>6</b>
<b>3 GENERAL INFORMATION</b> .....	<b>7</b>
3.1 GENERAL DESCRIPTION OF EUT.....	7
3.2 DESCRIPTION OF TEST MODES.....	8
3.2.1 CONFIGURATION OF SYSTEM UNDER TEST .....	9
3.2.2 TEST MODE APPLICABILITY AND TESTED CHANNEL DETAIL.....	9
3.3 GENERAL DESCRIPTION OF APPLIED STANDARDS.....	11
3.4 DESCRIPTION OF SUPPORT UNITS.....	11
3.5 CONFIGURATION OF SYSTEM UNDER TEST .....	12
<b>4 TEST TYPES AND RESULTS</b> .....	<b>13</b>
4.1 CONDUCTED EMISSION MEASUREMENT .....	13
4.1.1 LIMITS OF CONDUCTED EMISSION MEASUREMENT .....	13
4.1.2 TEST INSTRUMENTS.....	13
4.1.3 TEST PROCEDURES .....	14
4.1.4 DEVIATION FROM TEST STANDARD .....	14
4.1.5 TEST SETUP.....	15
4.1.6 EUT OPERATING CONDITIONS .....	15
4.1.7 TEST RESULTS.....	16
4.2 RADIATED EMISSION AND BANDEDGE MEASUREMENT .....	18
4.2.1 LIMITS OF RADIATED EMISSION AND BANDEDGE MEASUREMENT .....	18
4.2.2 TEST INSTRUMENTS.....	19
4.2.3 TEST PROCEDURES .....	20
4.2.4 DEVIATION FROM TEST STANDARD .....	21
4.2.5 TEST SETUP.....	21
4.2.6 EUT OPERATING CONDITIONS .....	22
4.2.7 TEST RESULTS.....	23
4.3 NUMBER OF HOPPING FREQUENCY USED.....	32
4.3.1 LIMIT OF HOPPING FREQUENCY USED .....	32
4.3.2 TEST SETUP.....	32
4.3.3 TEST INSTRUMENTS.....	32
4.3.4 TEST PROCEDURES .....	33
4.3.5 DEVIATION FROM TEST STANDARD .....	33



4.3.6	TEST RESULTS.....	33
4.4	DWELL TIME ON EACH CHANNEL.....	36
4.4.1	LIMIT OF DWELL TIME USED.....	36
4.4.2	TEST SETUP.....	36
4.4.3	TEST INSTRUMENTS.....	36
4.4.4	TEST PROCEDURES.....	36
4.4.5	DEVIATION FROM TEST STANDARD.....	37
4.4.6	TEST RESULTS.....	37
4.5	CHANNEL BANDWIDTH.....	40
4.5.1	LIMITS OF CHANNEL BANDWIDTH.....	40
4.5.2	TEST SETUP.....	40
4.5.3	TEST INSTRUMENTS.....	40
4.5.4	TEST PROCEDURE.....	40
4.5.5	DEVIATION FROM TEST STANDARD.....	40
4.5.6	EUT OPERATING CONDITION.....	40
4.5.7	TEST RESULTS.....	41
4.6	HOPPING CHANNEL SEPARATION.....	45
4.6.1	LIMIT OF HOPPING CHANNEL SEPARATION.....	45
4.6.2	TEST SETUP.....	45
4.6.3	TEST INSTRUMENTS.....	45
4.6.4	TEST PROCEDURES.....	45
4.6.5	DEVIATION FROM TEST STANDARD.....	45
4.6.6	TEST RESULTS.....	46
4.7	CONDUCTED OUTPUT POWER.....	50
4.7.1	LIMITS OF CONDUCTED OUTPUT POWER MEASUREMENT.....	50
4.7.2	TEST SETUP.....	50
4.7.3	TEST INSTRUMENTS.....	50
4.7.4	TEST PROCEDURES.....	50
4.7.5	DEVIATION FROM TEST STANDARD.....	50
4.7.6	EUT OPERATING CONDITION.....	51
4.7.7	TEST RESULTS.....	51
4.8	OUT OF BAND EMISSION MEASUREMENT.....	53
4.8.1	LIMITS OF OUT OF BAND EMISSION MEASUREMENT.....	53
4.8.2	TEST INSTRUMENTS.....	53
4.8.3	TEST PROCEDURE.....	53
4.8.4	DEVIATION FROM TEST STANDARD.....	53
4.8.5	EUT OPERATING CONDITION.....	53



**BUREAU  
VERITAS**

**Test Report No.: RF2212WDG0106-3**

4.8.6	TEST RESULTS.....	53
<b>5</b>	<b>PHOTOGRAPHS OF THE TEST CONFIGURATION .....</b>	<b>58</b>
<b>6</b>	<b>APPENDIX A - MODIFICATIONS RECORDERS FOR ENGINEERING CHANGES TO THE EUT BY THE LAB .....</b>	<b>59</b>



Test Report No.: RF2212WDG0106-3

## RELEASE CONTROL RECORD

ISSUE NO.	REASON FOR CHANGE	DATE ISSUED
RF2212WDG0106-3	Original release	Mar. 03, 2023



# 1 SUMMARY OF TEST RESULTS

The EUT has been tested according to the following specifications:

APPLIED STANDARD: FCC Part 15, Subpart C			
STANDARD SECTION	TEST TYPE AND LIMIT	RESULT	REMARK
15.207	AC Power Conducted Emission	PASS	Meet the requirement of limit.
15.247(a)(1)(iii)	Number of Hopping Frequency Used	PASS	Meet the requirement of limit.
15.247(a)(1)(iii)	Dwell Time on Each Channel	PASS	Meet the requirement of limit.
15.247(a)(1)	1. Hopping Channel Separation 2. Spectrum Bandwidth of a Frequency Hopping Sequence Spread Spectrum System	PASS	Meet the requirement of limit.
15.247(b)	Conducted Output Power	PASS	Meet the requirement of limit.
15.247(d)& 15.209	Transmitter Radiated Emission	PASS	Meet the requirement of limit.
15.247(d)	Out of band Emission Measurement	PASS	Meet the requirement of limit.
15.203	Antenna Requirement	PASS	No antenna connector is used.

# 2 MEASUREMENT UNCERTAINTY

Where relevant, the following measurement uncertainty levels have been estimated for tests performed on the EUT as specified in CISPR 16-4-2:

MEASUREMENT	FREQUENCY	UNCERTAINTY
Conducted emissions	9kHz~30MHz	2.68dB
Radiated emissions	9KHz ~ 30MHz	2.80dB
	30MHz ~ 1GMHz	4.62dB
	1GHz ~ 18GHz	4.96dB
	18GHz ~ 40GHz	4.50dB

This uncertainty represents an expanded uncertainty expressed at approximately the 95% confidence level using a coverage factor of k=2.



### 3 GENERAL INFORMATION

#### 3.1 GENERAL DESCRIPTION OF EUT

<b>PRODUCT</b>	ACTIVE FRONT SPEAKER
<b>MODEL NO.</b>	YY2078C1
<b>ADDITIONAL MODELS</b>	N/A
<b>FCC ID</b>	ZVAYY2078C1
<b>POWER SUPPLY</b>	DC 5/9/12/15V from USB Host Unit or DC 7.2V from Li-ion Battery
<b>MODULATION TECHNOLOGY</b>	FHSS
<b>MODULATION TYPE</b>	GFSK, $\pi/4$ DQPSK, 8DPSK
<b>OPERATING FREQUENCY</b>	2402MHz~2480MHz
<b>NUMBER OF CHANNEL</b>	79
<b>PEAK OUTPUT POWER</b>	2.692mW (Max. Measured)
<b>ANTENNA TYPE</b>	PCB Antenna, 3.4dBi Gain
<b>I/O PORTS</b>	Refer to user's manual
<b>CABLE SUPPLIED</b>	N/A

**NOTES:**

1. For a more detailed features description, please refer to the manufacturer's specifications or the user's manual.
2. For the test results, the EUT had been tested with all conditions. But only the worst case was shown in test report.
3. Please refer to the EUT photo document (Reference No.: 2212WDG0106-3) for detailed product photo.
4. The EUT has two modules, the "BM82A" and the "BM65T", they can transmit simultaneously, as for radiated emission (above 1GHz), the simultaneous transmission of two modules was also tested, but the report only shows the worst channel.
5. The EUT was powered by the following adapter:

<b>ADAPTER</b>	
BRAND:	SONY
MODEL:	AC-045AX7T
INPUT:	AC 100-240V, 50/60Hz 1.4A
OUTPUT:	DC 5/9/12/15V 3A or DC 20V 2.25A
TYPE-C CABLE:	Shielded, detachable, 150cm



### 3.2 DESCRIPTION OF TEST MODES

79 channels are provided to this EUT:

CHANNEL	FREQ. (MHz)	CHANNEL	FREQ. (MHz)	CHANNEL	FREQ. (MHz)	CHANNEL	FREQ. (MHz)
0	2402	20	2422	40	2442	60	2462
1	2403	21	2423	41	2443	61	2463
2	2404	22	2424	42	2444	62	2464
3	2405	23	2425	43	2445	63	2465
4	2406	24	2426	44	2446	64	2466
5	2407	25	2427	45	2447	65	2467
6	2408	26	2428	46	2448	66	2468
7	2409	27	2429	47	2449	67	2469
8	2410	28	2430	48	2450	68	2470
9	2411	29	2431	49	2451	69	2471
10	2412	30	2432	50	2452	70	2472
11	2413	31	2433	51	2453	71	2473
12	2414	32	2434	52	2454	72	2474
13	2415	33	2435	53	2455	73	2475
14	2416	34	2436	54	2456	74	2476
15	2417	35	2437	55	2457	75	2477
16	2418	36	2438	56	2458	76	2478
17	2419	37	2439	57	2459	77	2479
18	2420	38	2440	58	2460	78	2480
19	2421	39	2441	59	2461		



### 3.2.1 CONFIGURATION OF SYSTEM UNDER TEST

Please see section 5 photograph of the test configuration for reference.

### 3.2.2 TEST MODE APPLICABILITY AND TESTED CHANNEL DETAIL

Pre-Scan has been conducted to determine the worst-case mode from all possible combinations between available modulations, data rates, power supply voltage range and antenna ports.

Following channel(s) was (were) selected for the final test as listed below:

EUT CONFIGURE MODE	APPLICABLE TO				DESCRIPTION
	RE<1G	RE≥1G	PLC	APCM	
A	√	√	√	√	Powered By Adapter Input AC 120V/60Hz with BT link

Where **RE<1G**: Radiated Emission below 1GHz  
**PLC**: Power Line Conducted Emission

**RE≥1G**: Radiated Emission above 1GHz  
**APCM**: Antenna Port Conducted Measurement

#### **RADIATED EMISSION TEST (BELOW 1 GHz):**

- Pre-Scan has been conducted to determine the worst-case mode from all possible combinations between available modulations, X axis, antenna ports (if EUT with antenna diversity architecture) and packet type.
- Following channel(s) was (were) selected for the final test as listed below.

EUT CONFIGURE MODE	AVAILABLE CHANNEL	TESTED CHANNEL	MODULATION TECHNOLOGY	MODULATION TYPE	PACKET TYPE
A	0 to 78	39	FHSS	GFSK	DH5

For the test results, only the worst case was shown in test report.

#### **RADIATED EMISSION TEST (ABOVE 1 GHz):**

- Pre-Scan has been conducted to determine the worst-case mode from all possible combinations between available modulations, X axis, antenna ports (if EUT with antenna diversity architecture) and packet type.
- Following channel(s) was (were) selected for the final test as listed below.

EUT CONFIGURE MODE	AVAILABLE CHANNEL	TESTED CHANNEL	MODULATION TECHNOLOGY	MODULATION TYPE	PACKET TYPE
A	0 to 78	0, 39, 78	FHSS	GFSK	DH5
	0 to 78	0, 39, 78	FHSS	8DPSK	3DH5



**POWER LINE CONDUCTED EMISSION TEST:**

- Pre-Scan has been conducted to determine the worst-case mode from all possible combinations between available modulations, antenna ports (if EUT with antenna diversity architecture), and packet types.
- Following channel(s) was (were) selected for the final test as listed below.

EUT CONFIGURE MODE	TESTED CONDITION
A	BT Link

**ANTENNA PORT CONDUCTED MEASUREMENT:**

- This item includes all test value of each mode, but only includes spectrum plot of worst value of each mode.
- Pre-Scan has been conducted to determine the worst-case mode from all possible combinations between available modulations, antenna ports (if EUT with antenna diversity architecture), and packet types.
- Following channel(s) was (were) selected for the final test as listed below.

EUT CONFIGURE MODE	AVAILABLE CHANNEL	TESTED CHANNEL	MODULATION TECHNOLOGY	MODULATION TYPE	PACKET TYPE
A	0 to 78	0, 39, 78	FHSS	GFSK	DH5
	0 to 78	0, 39, 78	FHSS	8DPSK	3DH5

**TEST CONDITION:**

APPLICABLE TO	ENVIRONMENTAL CONDITIONS	TEST VOLTAGE	TESTED BY
RE<1G	25deg. C, 55%RH	Powered By Adapter Input AC 120V/60Hz	Jelly
RE≥1G	25deg. C, 55%RH	Powered By Adapter Input AC 120V/60Hz	Jelly
PLC	25deg. C, 58%RH	Powered By Adapter Input AC 120V/60Hz	Summer
APCM	25deg. C, 60%RH	Powered By Adapter Input AC 120V/60Hz	Vincent



### 3.3 GENERAL DESCRIPTION OF APPLIED STANDARDS

The EUT is a RF Product. According to the specifications of the manufacturer, it must comply with the requirements of the following standards:

- FCC Part 15, Subpart C. Section 15.247**
- KDB 558074 D01 15.247 Meas Guidance v05r02**
- ANSI C63.10-2013**

All test items have been performed and recorded as per the above standards.

### 3.4 DESCRIPTION OF SUPPORT UNITS

The EUT has been tested as an independent unit together with other necessary accessories or support units. The following support units or accessories were used to form a representative test configuration during the tests.

NO.	PRODUCT	BRAND	MODEL NO.	SERIAL NO.	FCC ID
1	iPhone 6 Plus	Apple	A1522/A1524	N/A	BCG-E2817A
2	ACTIVE REAR SPEAKER	SONY	YY2078C2/YY2078C3	N/A	N/A

NO.	SIGNAL CABLE DESCRIPTION OF THE ABOVE SUPPORT UNITS
1	N/A
2	N/A

### 3.5 CONFIGURATION OF SYSTEM UNDER TEST

#### For Conducted Emission Test

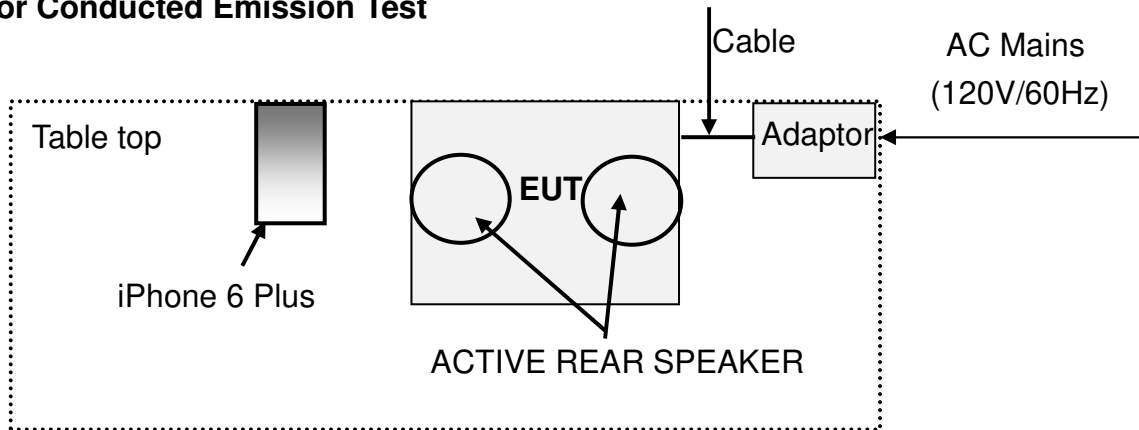

**Note:** For the actual test configuration, please refer to the attached file (Test Setup Photo).

#### For Radiated Emission Test

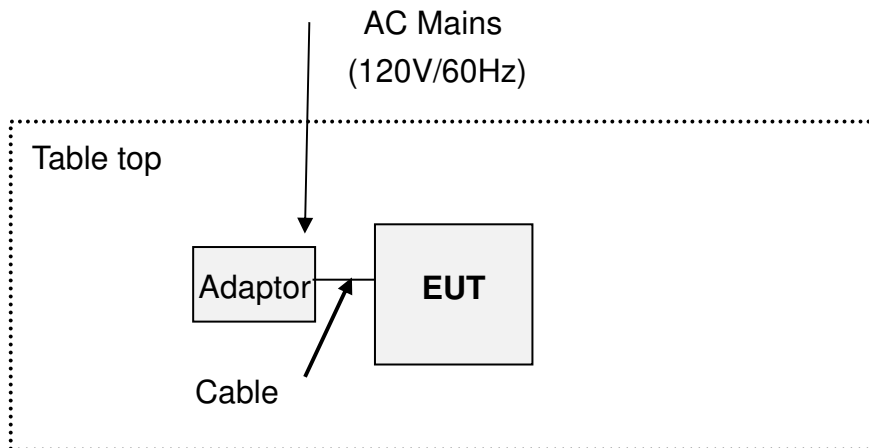

**Note:** For the actual test configuration, please refer to the attached file (Test Setup Photo).



## 4 TEST TYPES AND RESULTS

### 4.1. CONDUCTED EMISSION MEASUREMENT

#### 4.1.1 LIMITS OF CONDUCTED EMISSION MEASUREMENT

FREQUENCY OF EMISSION (MHz)	CONDUCTED LIMIT (dBµV)	
	Quasi-peak	Average
0.15 ~ 0.5	66 to 56	56 to 46
0.5 ~ 5	56	46
5 ~ 30	60	50

- NOTES:**
1. The lower limit shall apply at the transition frequencies.
  2. The limit decreases in line with the logarithm of the frequency in the range of 0.15 to 0.50MHz.
  3. All emanations from a class A/B digital device or system, including any network of conductors and apparatus connected thereto, shall not exceed the level of field strengths specified above.

#### 4.1.2 TEST INSTRUMENTS

Equipment	Manufacturer	Model No.	Serial No.	Next Cal.
EMI Test Receiver	Rohde&Schwarz	ESR7	101494	Jan. 18, 24
Artificial Mains Network	Rohde&Schwarz	ENV216	101173	Jan. 23, 24
Artificial Mains Network	Rohde&Schwarz	ESH3-Z5	100317	Jan. 18, 24
Voltage probe	SCHWARZBECK	TK 9421	TK 9421-176	Jul. 27, 23
Coaxial RF Cable	/	CE CABLE	C2310066DG	Jul. 24, 23
Test software	ADT	ADT_Cond_V7.3.7	N/A	N/A
Shielded Room 553	CHANGMAO	5m*5m*3m	E1-010034	Jan. 27,24

- NOTES:**
1. The test was performed at Shielded Room 553.
  2. The calibration interval of the above test equipment (except shielded room and chamber) is 12 months. And the calibrations are traceable to CEPREI/CHINA, GRGT/CHINA and NIM/CHINA.

#### 4.1.3 TEST PROCEDURES

- a. The EUT was placed 0.4 meters from the conducting wall of the shielded room with EUT being connected to the power mains through a line impedance stabilization network (LISN). Other support units were connected to the power mains through another LISN. The two LISNs provide 50 ohm/ 50uH of coupling impedance for the measuring instrument.
- b. Both lines of the power mains connected to the EUT were checked for maximum conducted interference.
- c. The frequency range from 150kHz to 30MHz was searched. Emission levels under (Limit - 20dB) was not recorded.

**NOTE:** All modes of operation were investigated and the worst-case emissions are reported.

#### 4.1.4 DEVIATION FROM TEST STANDARD

No deviation.

#### 4.1.5 TEST SETUP

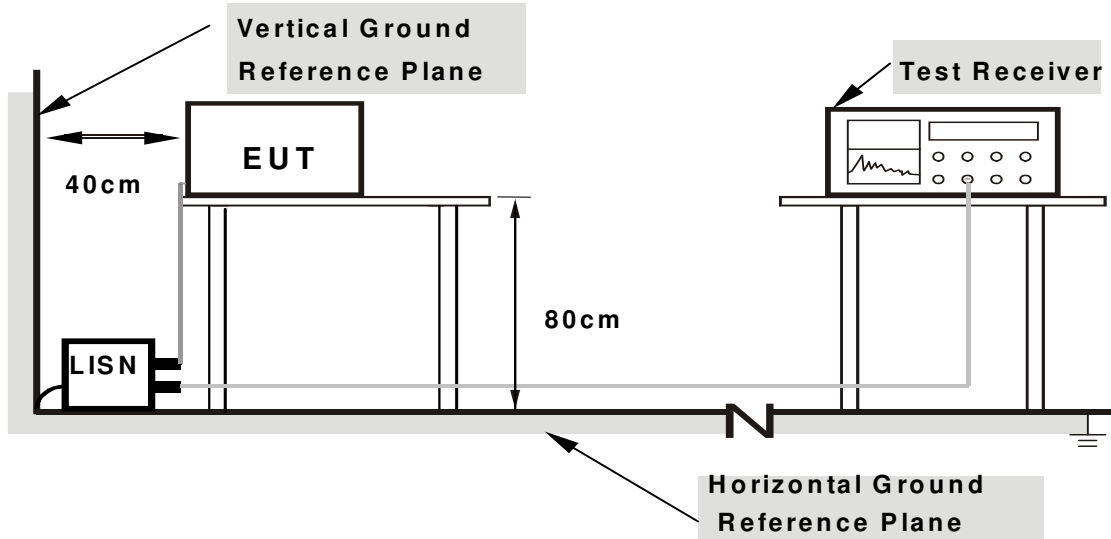

**Note: 1.Support units were connected to second LISN.**

**2.Both of LISNs (AMN) are 80 cm from EUT and at least 80 from other units and other metal planes**

For the actual test configuration, please refer to the attached file (Test Setup Photo).

#### 4.1.6 EUT OPERATING CONDITIONS

- a. Turned on the power and connected of all equipment.
- b. EUT was operated according to the type used was description in manufacturer's specifications or the User's Manual.



### 4.1.7 TEST RESULTS

**CONDUCTED WORST-CASE DATA: BT Link**

PHASE	Line	6dB BANDWIDTH	9kHz
-------	------	---------------	------

No	Freq. [MHz]	Corr. Factor (dB)	Reading Value [dB (uV)]		Emission Level [dB (uV)]		Limit [dB (uV)]		Margin (dB)	
			Q.P.	AV.	Q.P.	AV.	Q.P.	AV.	Q.P.	AV.
1	0.15000	9.95	31.22	8.25	41.17	18.20	66.00	56.00	-24.83	-37.80
2	0.17374	9.98	29.70	14.43	39.68	24.41	64.78	54.78	-25.10	-30.37
3	0.45185	10.14	28.68	26.20	38.82	36.34	56.84	46.84	-18.02	-10.50
4	0.48750	10.16	26.59	23.68	36.75	33.84	56.21	46.21	-19.46	-12.37
5	11.88600	10.74	23.69	16.23	34.43	26.97	60.00	50.00	-25.57	-23.03
6	18.81375	11.09	24.03	13.46	35.12	24.55	60.00	50.00	-24.88	-25.45

- REMARKS:**
1. Q.P. and AV. are abbreviations of quasi-peak and average individually.
  2. "-": The Quasi-peak reading value also meets average limit and measurement with the average detector is unnecessary.
  3. The emission levels of other frequencies were very low against the limit.
  4. Margin value = Emission level - Limit value
  5. Correction factor = Insertion loss + Cable loss
  6. Emission Level = Correction Factor + Reading Value.

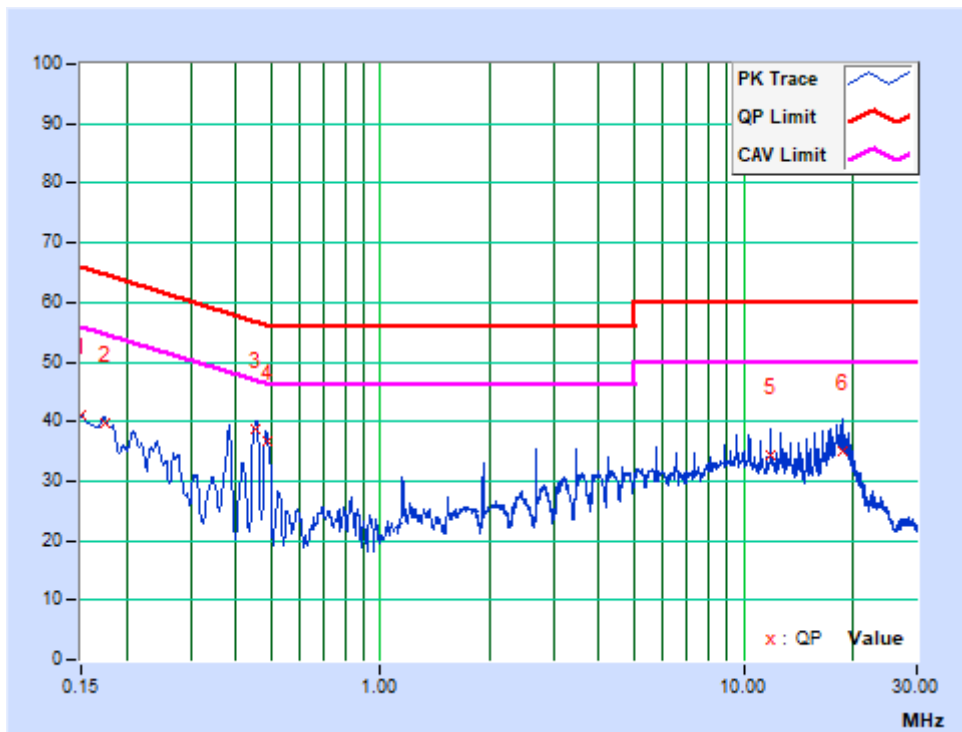



<b>PHASE</b>	Neutral	<b>6dB BANDWIDTH</b>	9kHz
--------------	---------	----------------------	------

No	Freq. [MHz]	Corr. Factor (dB)	Reading Value [dB (uV)]		Emission Level [dB (uV)]		Limit [dB (uV)]		Margin (dB)	
			Q.P.	AV.	Q.P.	AV.	Q.P.	AV.	Q.P.	AV.
1	0.15000	9.87	31.47	13.04	41.34	22.91	66.00	56.00	-24.66	-33.09
2	0.24231	9.96	25.01	19.62	34.97	29.58	62.02	52.02	-27.05	-22.44
<b>3</b>	<b>0.45600</b>	<b>10.01</b>	<b>32.99</b>	<b>30.70</b>	<b>43.00</b>	<b>40.71</b>	<b>56.77</b>	<b>46.77</b>	<b>-13.76</b>	<b>-6.05</b>
4	0.56703	10.03	24.37	13.94	34.40	23.97	56.00	46.00	-21.60	-22.03
5	11.92650	10.83	23.73	16.66	34.56	27.49	60.00	50.00	-25.44	-22.51
6	17.26800	11.02	22.77	16.01	33.79	27.03	60.00	50.00	-26.21	-22.97

- REMARKS:**
1. Q.P. and AV. are abbreviations of quasi-peak and average individually.
  2. "-": The Quasi-peak reading value also meets average limit and measurement with the average detector is unnecessary.
  3. The emission levels of other frequencies were very low against the limit.
  4. Margin value = Emission level - Limit value
  5. Correction factor = Insertion loss + Cable loss
  6. Emission Level = Correction Factor + Reading Value.

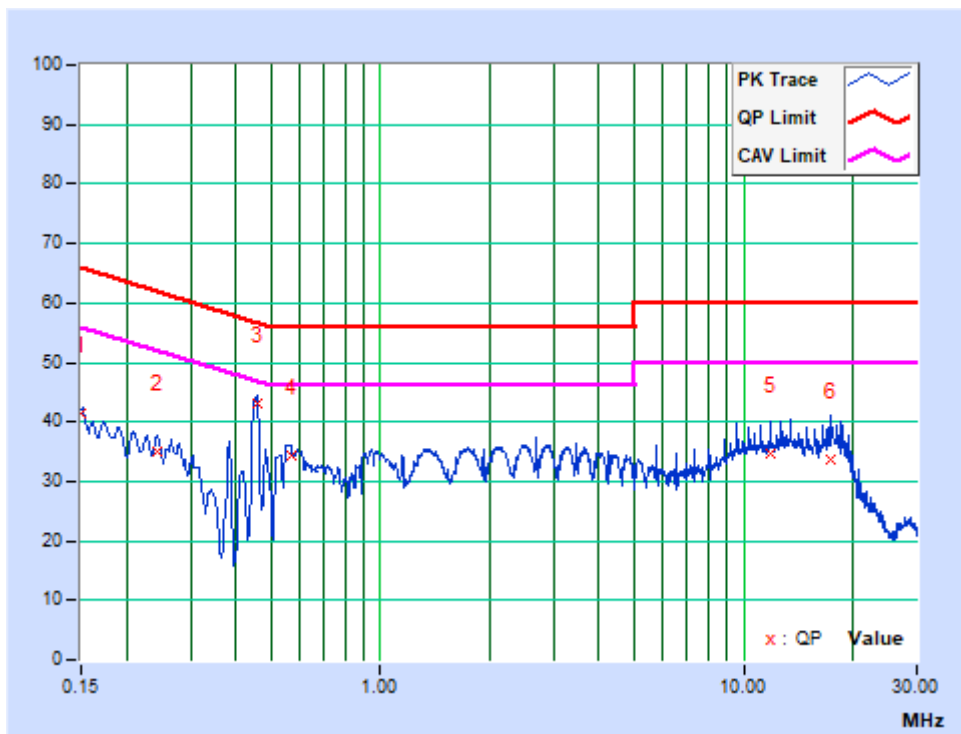

## 4.2. RADIATED EMISSION AND BANDEDGE MEASUREMENT

### 4.2.1 LIMITS OF RADIATED EMISSION AND BANDEDGE MEASUREMENT

Radiated emissions which fall in the restricted bands, as defined in Section 15.205(a), must also comply with the radiated emission limits specified in Section 15.209(a). Other emissions shall be at least 20dB below the highest level of the desired power.

FREQUENCIES (MHz)	FIELD STRENGTH (microvolts/meter)	MEASUREMENT DISTANCE (meters)
0.009 ~ 0.490	2400/F(kHz)	300
0.490 ~ 1.705	24000/F(kHz)	30
1.705 ~ 30.0	30	30
30 ~ 88	100	3
88 ~ 216	150	3
216 ~ 960	200	3
Above 960	500	3

#### NOTES:

1. The lower limit shall apply at the transition frequencies.
2. Emission level (dBuV/m) = 20 log Emission level (uV/m).
3. As shown in 15.35(b), for frequencies above 1000MHz, the field strength limits are based on average detector, however, the peak field strength of any emission shall not exceed the maximum permitted average limits, specified above by more than 20dB under any condition of modulation.



### 4.2.2 TEST INSTRUMENTS

<b>Equipment</b>	<b>Manufacturer</b>	<b>Model No.</b>	<b>Serial No.</b>	<b>Next Cal.</b>
EMI Test Receiver	Rohde&Schwarz	ESU40	100449	Feb. 22, 23
Signal and Spectrum Analyzer	Rohde&Schwarz	FSV7	102331	May 09, 23
Active Loop Antenna (9KHz -30MHz)	SCHWARZBECK	FMZB 1519B	1519B-045	May 20, 23
Amplifier (9KHz -1GHz)	Burgeon	BPA-530	100210	Mar. 08, 23
Trilog-Broadband Antenna(20M-2G)	SCHWARZBECK	VULB 9168	01263	Sep. 30, 23
Horn Antenna (1GHz -18GHz)	ETS -Lindgren	3117	00062558	May 21, 23
Horn Antenna (18GHz -40GHz)	SCHWARZBECK	BBHA 9170	BBHA9170147	May 14, 23
3m Semi-anechoic Chamber	ETS-LINDGREN	9m*6m*6m	NSEMC003	May 22, 23
Test Software	ADT	ADT_Radiated_V7.6.15.9.2	N/A	N/A
Broadband Preamplifier (1GHz~18GHz)	SCHWARZBECK	BBV9718	305	May 12, 23
Pre-Amplifier (18GHz-40GHz)	EMCI	EMC 184045	980102	Jan. 10, 24
Test Software	ADT	ADT_Radiated_V7.6.15.9.2	N/A	N/A
BLUETOOTH TESTER	Rohde&Schwarz	CBT32	100811	N/A

**NOTES:**

1. The test was performed in 966 Chamber .
2. The calibration interval of the above test instruments is 12 months and the calibrations are traceable to CEPREI/CHINA, GRGT/CHINA and NIM/CHINA.
3. The horn antenna is used only for the measurement of emission frequency above1GHz if tested.
4. The FCC Site Registration No. is 749762.



### 4.2.3 TEST PROCEDURES

- a. The EUT was placed on the top of a rotating table 1.5 meters(above 1GHz) and 0.8 meters(below 1GHz) above the ground at a 3 meters semi-anechoic chamber. The table was rotated 360 degrees to determine the position of the highest radiation.
- b. The EUT was set 3 meters away from the interference-receiving antenna, which was mounted on the top of a variable-height antenna tower.
- c. For below 1GHz was used bilog antenna, and above 1GHz was used horn antenna, and its height is varied from one meter to four meters above the ground to determine the maximum value of the field strength. Both horizontal and vertical polarizations of the antenna are set to make the measurement.
- d. For each suspected emission, the EUT was arranged to its worst case and then the antenna was tuned to heights from 1 meter to 4 meters and the rotatable table was turned from 0 degrees to 360 degrees to find the maximum reading.
- e. The test-receiver system was set to Peak Detect Function and Specified Bandwidth with Maximum Hold Mode.
- f. For below 30MHz, a loop antenna with its vertical plane is place 3m from the EUT and rotated about its vertical axis for maximum response at each azimuth about the EUT. And the centre of the loop shall be 1.3m above the ground.
- g. During the test, each emission was maximized by: having the EUT continuously working, investigated all operating modes, rotated about all 3 axis (X, Y & Z) and considered typical configuration to obtain worst position, manipulating interconnecting cables, For battery operated equipment, the equipment tests shall be perform using fresh batteries. The turntable was rotated to maximize the emission level.

#### **NOTES:**

1. The resolution bandwidth and video bandwidth of test receiver/spectrum analyzer is 120kHz for Quasi-peak detection at frequency below 1GHz.
2. The resolution bandwidth of test receiver/spectrum analyzer is 1 MHz and video bandwidth is 3MHz for Peak detection at frequency above 1GHz.
3. The resolution bandwidth of test receiver/spectrum analyzer is 1MHz and the video bandwidth is  $\geq 1/T$  (Duty cycle < 98%) or 10Hz(Duty cycle > 98%) for Average detection (AV) at frequency above 1GHz.
4. All modes of operation were investigated and the worst-case emissions are reported.
5. The testing of the EUT was performed on all 3 orthogonal axes; the worst-case test configuration was reported on the file test setup photo.



#### 4.2.4 DEVIATION FROM TEST STANDARD

No deviation.

#### 4.2.5 TEST SETUP

##### Below 30MHz test setup

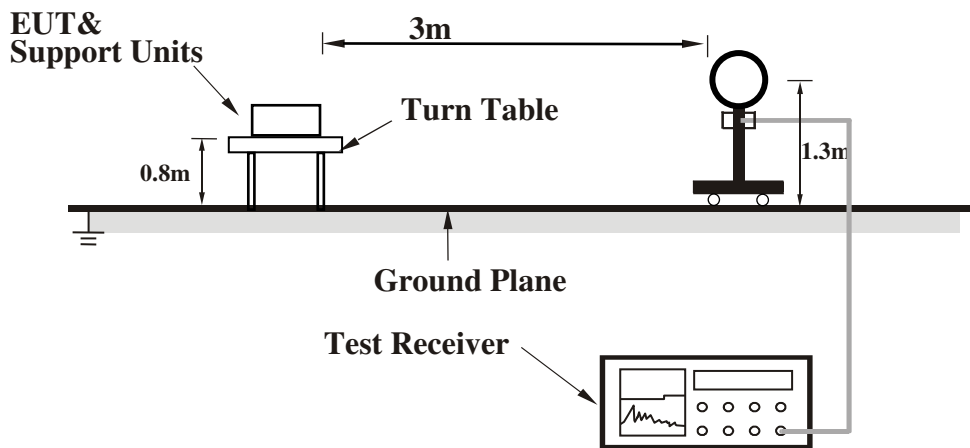

##### Below 1GHz test setup

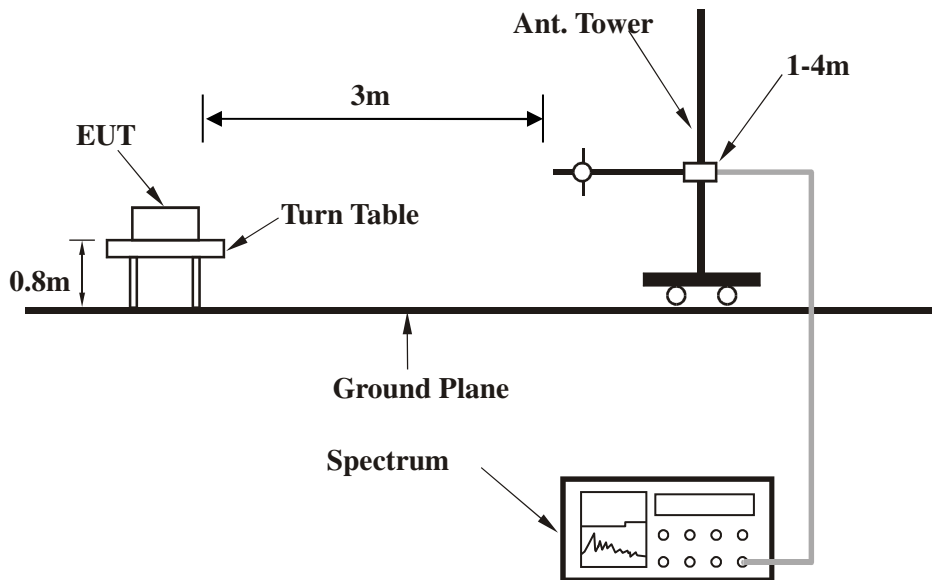

**Note:** For the actual test configuration, please refer to the attached file (Test Setup Photo).

## Above 1GHz test setup

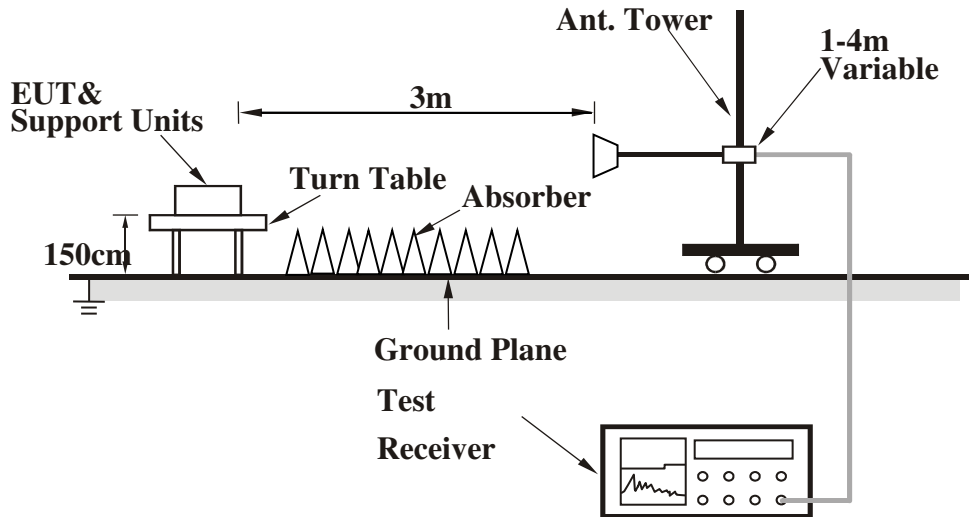

**Note:** For the actual test configuration, please refer to the attached file (Test Setup Photo).

### 4.2.6 EUT OPERATING CONDITIONS

- Set the EUT under full load condition and placed them on a testing table.
- Set the transmitter part of EUT under transmission condition continuously at specific channel frequency.
- The necessary accessories enable the EUT in full functions.



### 4.2.7 TEST RESULTS

#### BELOW 1GHz WORST-CASE DATA:

#### GFSK DH5

<b>CHANNEL</b>	Channel 39	<b>DETECTOR FUNCTION</b>	Quasi-Peak (QP)
<b>FREQUENCY RANGE</b>	9KHz ~ 1GHz		

ANTENNA POLARITY & TEST DISTANCE: HORIZONTAL AT 3 M								
NO.	FREQ. (MHz)	EMISSION LEVEL (dBuV/m)	LIMIT (dBuV/m)	MARGIN (dB)	ANTENNA HEIGHT (m)	TABLE ANGLE (Degree)	RAW VALUE (dBuV)	CORRECTION FACTOR (dB/m)
1	59.54	29.44 QP	40.00	-10.56	1.00 H	232	46.17	-16.73
2	126.38	29.59 QP	43.50	-13.91	1.00 H	265	47.35	-17.76
3	191.67	29.91 QP	43.50	-13.59	1.00 H	157	48.10	-18.19
4	291.15	24.91 QP	46.00	-21.09	1.00 H	276	39.65	-14.74
5	530.54	24.99 QP	46.00	-21.01	1.00 H	287	33.68	-8.69
6	620.71	26.66 QP	46.00	-19.34	1.00 H	261	33.13	-6.47

#### REMARKS:

1. Emission level (dBuV/m) = Raw Value (dBuV) + Correction Factor (dB/m).
2. Correction Factor (dB/m) = Antenna Factor (dB/m) + Cable Factor (dB).
3. The emission levels of other frequencies were greater than 20dB margin.
4. 9KHz~30MHz have been test and test data more than 20dB margin.
5. Margin value = Emission level – Limit value

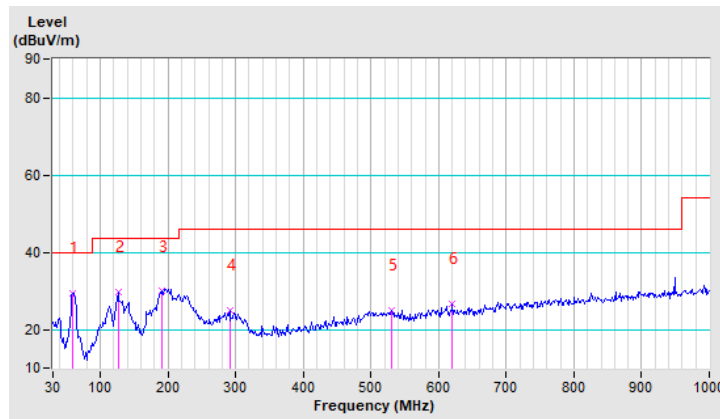



**BUREAU  
VERITAS**

**Test Report No.: RF2212WDG0106-3**

<b>CHANNEL</b>	Channel 39	<b>DETECTOR FUNCTION</b>	Quasi-Peak (QP)
<b>FREQUENCY RANGE</b>	9KHz ~ 1GHz		

<b>ANTENNA POLARITY &amp; TEST DISTANCE: VERTICAL AT 3 M</b>								
<b>NO.</b>	<b>FREQ. (MHz)</b>	<b>EMISSION LEVEL (dBuV/m)</b>	<b>LIMIT (dBuV/m)</b>	<b>MARGIN (dB)</b>	<b>ANTENNA HEIGHT (m)</b>	<b>TABLE ANGLE (Degree)</b>	<b>RAW VALUE (dBuV)</b>	<b>CORRECTIO N FACTOR (dB/m)</b>
1	59.54	31.65 QP	40.00	-8.35	1.00 V	227	48.38	-16.73
2	140.37	24.01 QP	43.50	-19.49	1.00 V	133	40.19	-16.18
3	194.78	29.74 QP	43.50	-13.76	1.00 V	178	48.01	-18.27
4	227.42	26.20 QP	46.00	-19.80	1.00 V	85	43.41	-17.21
5	306.70	28.46 QP	46.00	-17.54	1.00 V	160	42.72	-14.26
6	592.72	25.90 QP	46.00	-20.10	1.00 V	109	32.83	-6.93

**REMARKS:**

1. Emission level (dBuV/m) = Raw Value (dBuV) + Correction Factor (dB/m).
2. Correction Factor (dB/m) = Antenna Factor (dB/m) + Cable Factor (dB).
3. The emission levels of other frequencies were greater than 20dB margin.
4. 9KHz~30MHz have been test and test data more than 20dB margin.
5. Margin value = Emission level – Limit value

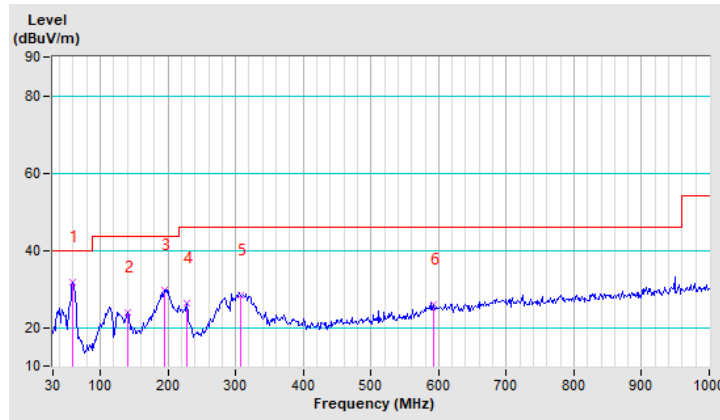

**Bureau Veritas Shenzhen Co., Ltd.  
Dongguan Branch**

No. 96, Guantai Road (Houjie Section), Houjie  
Town, Dongguan City, Guangdong Province.  
523942. People's Republic of China.

Tel: +86 769 8998 2098  
Fax: +86 769 8593 1080  
Email: [customerservice.dg@bureauveritas.com](mailto:customerservice.dg@bureauveritas.com)





ABOVE 1GHZ DATA

BT\_GFSK

CHANNEL	TX Channel 0	DETECTOR FUNCTION	Peak (PK)
FREQUENCY RANGE	1GHz ~ 25GHz		Average (AV)

ANTENNA POLARITY & TEST DISTANCE : HORIZONTAL AT 3 M								
NO.	FREQ. (MHz)	EMISSION LEVEL (dBuV/m)	LIMIT (dBuV/m)	MARGIN (dB)	ANTENNA HEIGHT (m)	TABLE ANGLE (Degree)	RAW VALUE (dBuV)	CORRECTION FACTOR (dB/m)
1	2390.00	43.20 PK	74.00	-30.80	1.90 H	335	40.40	2.80
2	2390.00	34.50 AV	54.00	-19.50	1.90 H	335	31.70	2.80
3	*2402.00	104.49 PK			1.90 H	335	101.65	2.84
4	*2402.00	103.59 AV			1.90 H	335	100.75	2.84
5	4804.00	47.40 PK	74.00	-26.60	2.24 H	241	40.34	7.06
6	4804.00	38.00 AV	54.00	-16.00	2.24 H	241	30.94	7.06
7	#7206.00	50.32 PK	74.00	-23.68	2.41 H	297	40.37	9.95
8	#7206.00	40.40 AV	54.00	-13.60	2.41 H	297	30.45	9.95

ANTENNA POLARITY & TEST DISTANCE : VERTICAL AT 3 M								
NO.	FREQ. (MHz)	EMISSION LEVEL (dBuV/m)	LIMIT (dBuV/m)	MARGIN (dB)	ANTENNA HEIGHT (m)	TABLE ANGLE (Degree)	RAW VALUE (dBuV)	CORRECTION FACTOR (dB/m)
1	2390.00	42.24 PK	74.00	-31.76	1.46 V	46	39.44	2.80
2	2390.00	32.44 AV	54.00	-21.56	1.46 V	46	29.64	2.80
3	*2402.00	101.03 PK			1.46 V	46	98.19	2.84
4	*2402.00	99.55 AV			1.46 V	46	96.71	2.84
5	4804.00	46.92 PK	74.00	-27.08	1.14 V	24	39.86	7.06
6	4804.00	37.00 AV	54.00	-17.00	1.14 V	24	29.94	7.06
7	#7206.00	50.10 PK	74.00	-23.90	1.41 V	214	40.15	9.95
8	#7206.00	42.70 AV	54.00	-11.30	1.41 V	214	32.75	9.95

REMARKS:

1. Emission level (dBuV/m) = Raw Value (dBuV) + Correction Factor (dB/m).
2. Correction Factor (dB/m) = Antenna Factor (dB/m) + Cable Factor (dB).
3. The emission levels of other frequencies were greater than 20dB margin.
4. Margin value = Emission level – Limit value.
5. " \* ": Fundamental frequency.
6. " # ": The radiated frequency is out of the restricted band.



CHANNEL	TX Channel 39	DETECTOR FUNCTION	Peak (PK)
FREQUENCY RANGE	1GHz ~ 25GHz		Average (AV)

ANTENNA POLARITY & TEST DISTANCE : HORIZONTAL AT 3 M								
NO.	FREQ. (MHz)	EMISSION LEVEL (dBuV/m)	LIMIT (dBuV/m)	MARGIN (dB)	ANTENNA HEIGHT (m)	TABLE ANGLE (Degree)	RAW VALUE (dBuV)	CORRECTION FACTOR (dB/m)
1	*2441.00	102.54 PK			1.00 H	310	99.58	2.96
2	*2441.00	102.00 AV			1.00 H	310	99.04	2.96
3	4882.00	49.50 PK	74.00	-24.50	2.01 H	214	41.87	7.63
4	4882.00	40.27 AV	54.00	-13.73	2.01 H	214	32.64	7.63
5	7323.00	51.00 PK	74.00	-23.00	1.24 H	87	40.89	10.11
6	7323.00	41.80 AV	54.00	-12.20	1.24 H	87	31.69	10.11
ANTENNA POLARITY & TEST DISTANCE : VERTICAL AT 3 M								
NO.	FREQ. (MHz)	EMISSION LEVEL (dBuV/m)	LIMIT (dBuV/m)	MARGIN (dB)	ANTENNA HEIGHT (m)	TABLE ANGLE (Degree)	RAW VALUE (dBuV)	CORRECTION FACTOR (dB/m)
1	*2441.00	98.96 PK			1.00 V	141	96.00	2.96
2	*2441.00	98.56 AV			1.00 V	141	95.60	2.96
3	4882.00	50.20 PK	74.00	-23.80	1.04 V	213	42.57	7.63
4	4882.00	40.50 AV	54.00	-13.50	1.04 V	213	32.87	7.63
5	7323.00	51.20 PK	74.00	-22.80	1.24 V	120	41.09	10.11
6	7323.00	39.00 AV	54.00	-15.00	1.24 V	120	28.89	10.11

REMARKS:

1. Emission level (dBuV/m) = Raw Value (dBuV) + Correction Factor (dB/m).
2. Correction Factor (dB/m) = Antenna Factor (dB/m) + Cable Factor (dB).
3. The emission levels of other frequencies were greater than 20dB margin.
4. Margin value = Emission level – Limit value.
5. " \* ": Fundamental frequency.



<b>CHANNEL</b>	TX Channel 78	<b>DETECTOR FUNCTION</b>	Peak (PK)
<b>FREQUENCY RANGE</b>	1GHz ~ 25GHz		Average (AV)

ANTENNA POLARITY & TEST DISTANCE : HORIZONTAL AT 3 M								
NO.	FREQ. (MHz)	EMISSION LEVEL (dBuV/m)	LIMIT (dBuV/m)	MARGIN (dB)	ANTENNA HEIGHT (m)	TABLE ANGLE (Degree)	RAW VALUE (dBuV)	CORRECTION FACTOR (dB/m)
1	*2480.00	102.78 PK			1.83 H	314	99.71	3.07
2	*2480.00	101.36 AV			1.83 H	314	98.29	3.07
3	2483.50	47.58 PK	74.00	-26.42	1.83 H	314	44.50	3.08
4	2483.50	35.40 AV	54.00	-18.60	1.83 H	314	32.32	3.08
5	4960.00	51.80 PK	74.00	-22.20	2.14 H	149	43.59	8.21
6	4960.00	40.57 AV	54.00	-13.43	2.14 H	149	32.36	8.21
7	7440.00	50.54 PK	74.00	-23.46	1.24 H	300	40.27	10.27
8	7440.00	42.00 AV	54.00	-12.00	1.24 H	300	31.73	10.27
ANTENNA POLARITY & TEST DISTANCE : VERTICAL AT 3 M								
NO.	FREQ. (MHz)	EMISSION LEVEL (dBuV/m)	LIMIT (dBuV/m)	MARGIN (dB)	ANTENNA HEIGHT (m)	TABLE ANGLE (Degree)	RAW VALUE (dBuV)	CORRECTION FACTOR (dB/m)
1	*2480.00	100.06 PK			1.01 V	14	96.99	3.07
2	*2480.00	99.21 AV			1.01 V	14	96.14	3.07
3	2483.50	46.00 PK	74.00	-28.00	1.01 V	14	42.92	3.08
4	2483.50	37.50 AV	54.00	-16.50	1.01 V	14	34.42	3.08
5	4960.00	50.42 PK	74.00	-23.58	1.24 V	74	42.21	8.21
6	4960.00	40.90 AV	54.00	-13.10	1.24 V	74	32.69	8.21
7	7440.00	49.39 PK	74.00	-24.61	1.00 V	330	39.12	10.27
8	7440.00	40.70 AV	54.00	-13.30	1.00 V	330	30.43	10.27

REMARKS:

1. Emission level (dBuV/m) = Raw Value (dBuV) + Correction Factor (dB/m).
2. Correction Factor (dB/m) = Antenna Factor (dB/m) + Cable Factor (dB).
3. The emission levels of other frequencies were greater than 20dB margin.
4. Margin value = Emission level – Limit value.
5. " \* ": Fundamental frequency.



BT\_8DPSK

<b>CHANNEL</b>	TX Channel 0	<b>DETECTOR FUNCTION</b>	Peak (PK)
<b>FREQUENCY RANGE</b>	1GHz ~ 25GHz		Average (AV)

ANTENNA POLARITY & TEST DISTANCE : HORIZONTAL AT 3 M								
NO.	FREQ. (MHz)	EMISSION LEVEL (dBuV/m)	LIMIT (dBuV/m)	MARGIN (dB)	ANTENNA HEIGHT (m)	TABLE ANGLE (Degree)	RAW VALUE (dBuV)	CORRECTION FACTOR (dB/m)
1	2390.00	44.20 PK	74.00	-29.80	1.09 H	90	41.40	2.80
2	2390.00	35.60 AV	54.00	-18.40	1.09 H	90	32.80	2.80
3	*2402.00	105.36 PK			1.09 H	90	102.52	2.84
4	*2402.00	104.21 AV			1.09 H	90	101.37	2.84
5	4804.00	47.62 PK	74.00	-26.38	1.03 H	312	40.56	7.06
6	4804.00	39.20 AV	54.00	-14.80	1.03 H	312	32.14	7.06
7	#7206.00	51.02 PK	74.00	-22.98	1.00 H	18	41.07	9.95
8	#7206.00	41.03 AV	54.00	-12.97	1.00 H	18	31.08	9.95

ANTENNA POLARITY & TEST DISTANCE : VERTICAL AT 3 M								
NO.	FREQ. (MHz)	EMISSION LEVEL (dBuV/m)	LIMIT (dBuV/m)	MARGIN (dB)	ANTENNA HEIGHT (m)	TABLE ANGLE (Degree)	RAW VALUE (dBuV)	CORRECTION FACTOR (dB/m)
1	2390.00	41.03 PK	74.00	-32.97	1.00 V	105	38.23	2.80
2	2390.00	31.58 AV	54.00	-22.42	1.00 V	105	28.78	2.80
3	*2402.00	102.10 PK			1.00 V	105	99.26	2.84
4	*2402.00	101.23 AV			1.00 V	105	98.39	2.84
5	4804.00	48.36 PK	74.00	-25.64	1.00 V	106	41.30	7.06
6	4804.00	38.25 AV	54.00	-15.75	1.00 V	106	31.19	7.06
7	#7206.00	51.03 PK	74.00	-22.97	1.06 V	67	41.08	9.95
8	#7206.00	43.26 AV	54.00	-10.74	1.06 V	67	33.31	9.95

REMARKS:

1. Emission level (dBuV/m) = Raw Value (dBuV) + Correction Factor (dB/m).
2. Correction Factor (dB/m) = Antenna Factor (dB/m) + Cable Factor (dB).
3. The emission levels of other frequencies were greater than 20dB margin.
4. Margin value = Emission level – Limit value.
5. " \* ": Fundamental frequency.
6. " # ": The radiated frequency is out of the restricted band.



CHANNEL	TX Channel 39	DETECTOR FUNCTION	Peak (PK)
FREQUENCY RANGE	1GHz ~ 25GHz		Average (AV)

ANTENNA POLARITY & TEST DISTANCE : HORIZONTAL AT 3 M								
NO.	FREQ. (MHz)	EMISSION LEVEL (dBuV/m)	LIMIT (dBuV/m)	MARGIN (dB)	ANTENNA HEIGHT (m)	TABLE ANGLE (Degree)	RAW VALUE (dBuV)	CORRECTION FACTOR (dB/m)
1	*2441.00	103.20 PK			1.00 H	129	100.24	2.96
2	*2441.00	102.47 AV			1.00 H	129	99.51	2.96
3	4882.00	50.26 PK	74.00	-23.74	1.00 H	48	42.63	7.63
4	4882.00	41.02 AV	54.00	-12.98	1.00 H	48	33.39	7.63
5	7323.00	52.10 PK	74.00	-21.90	1.00 H	69	41.99	10.11
6	7323.00	42.32 AV	54.00	-11.68	1.00 H	69	32.21	10.11
ANTENNA POLARITY & TEST DISTANCE : VERTICAL AT 3 M								
NO.	FREQ. (MHz)	EMISSION LEVEL (dBuV/m)	LIMIT (dBuV/m)	MARGIN (dB)	ANTENNA HEIGHT (m)	TABLE ANGLE (Degree)	RAW VALUE (dBuV)	CORRECTION FACTOR (dB/m)
1	*2441.00	99.20 PK			1.05 V	56	96.24	2.96
2	*2441.00	98.36 AV			1.05 V	56	95.40	2.96
3	4882.00	51.03 PK	74.00	-22.97	1.05 V	57	43.40	7.63
4	4882.00	40.85 AV	54.00	-13.15	1.05 V	57	33.22	7.63
5	7323.00	52.03 PK	74.00	-21.97	1.00 V	41	41.92	10.11
6	7323.00	43.20 AV	54.00	-10.80	1.00 V	41	33.09	10.11

REMARKS:

1. Emission level (dBuV/m) = Raw Value (dBuV) + Correction Factor (dB/m).
2. Correction Factor (dB/m) = Antenna Factor (dB/m) + Cable Factor (dB).
3. The emission levels of other frequencies were greater than 20dB margin.
4. Margin value = Emission level – Limit value.
5. " \* ": Fundamental frequency.



<b>CHANNEL</b>	TX Channel 78	<b>DETECTOR FUNCTION</b>	Peak (PK)
<b>FREQUENCY RANGE</b>	1GHz ~ 25GHz		Average (AV)

**ANTENNA POLARITY & TEST DISTANCE : HORIZONTAL AT 3 M**

NO.	FREQ. (MHz)	EMISSION LEVEL (dBuV/m)	LIMIT (dBuV/m)	MARGIN (dB)	ANTENNA HEIGHT (m)	TABLE ANGLE (Degree)	RAW VALUE (dBuV)	CORRECTION FACTOR (dB/m)
1	*2480.00	102.85 PK			1.00 H	123	99.78	3.07
2	*2480.00	101.52 AV			1.00 H	123	98.45	3.07
3	2483.50	48.32 PK	74.00	-25.68	1.00 H	123	45.24	3.08
4	2483.50	36.69 AV	54.00	-17.31	1.00 H	123	33.61	3.08
5	4960.00	51.36 PK	74.00	-22.64	1.06 H	69	43.15	8.21
6	4960.00	40.57 AV	54.00	-13.43	1.06 H	69	32.36	8.21
7	7440.00	52.03 PK	74.00	-21.97	1.05 H	57	41.76	10.27
8	7440.00	41.69 AV	54.00	-12.31	1.05 H	57	31.42	10.27

**ANTENNA POLARITY & TEST DISTANCE : VERTICAL AT 3 M**

NO.	FREQ. (MHz)	EMISSION LEVEL (dBuV/m)	LIMIT (dBuV/m)	MARGIN (dB)	ANTENNA HEIGHT (m)	TABLE ANGLE (Degree)	RAW VALUE (dBuV)	CORRECTION FACTOR (dB/m)
1	*2480.00	100.85 PK			1.02 V	120	97.78	3.07
2	*2480.00	100.12 AV			1.02 V	120	97.05	3.07
3	2483.50	47.37 PK	74.00	-26.63	1.02 V	120	44.29	3.08
4	2483.50	38.10 AV	54.00	-15.90	1.02 V	120	35.02	3.08
5	4960.00	51.03 PK	74.00	-22.97	1.00 V	185	42.82	8.21
6	4960.00	40.85 AV	54.00	-13.15	1.00 V	185	32.64	8.21
7	7440.00	49.36 PK	74.00	-24.64	1.50 V	18	39.09	10.27
8	7440.00	40.25 AV	54.00	-13.75	1.50 V	18	29.98	10.27

**REMARKS:**

1. Emission level (dBuV/m) = Raw Value (dBuV) + Correction Factor (dB/m).
2. Correction Factor (dB/m) = Antenna Factor (dB/m) + Cable Factor (dB).
3. The emission levels of other frequencies were greater than 20dB margin.
4. Margin value = Emission level – Limit value.
5. " \* " : Fundamental frequency.



ABOVE 1GHz WORST-CASE DATA: (CH 0)

“BM82A” and “BM65T” Simultaneous Transmitting

CHANNEL	TX Channel 0	DETECTOR FUNCTION	Peak (PK)
FREQUENCY RANGE	1GHz ~ 25GHz		Average (AV)

ANTENNA POLARITY & TEST DISTANCE: HORIZONTAL AT 3 M								
NO.	FREQ. (MHz)	EMISSION LEVEL (dBuV/m)	LIMIT (dBuV/m)	MARGIN (dB)	ANTENNA HEIGHT (m)	TABLE ANGLE (Degree)	RAW VALUE (dBuV)	CORRECTION FACTOR (dB/m)
1	2390.00	51.85 PK	74.00	-22.15	1.00 H	106	50.29	1.56
2	2390.00	40.85 AV	54.00	-13.15	1.00 H	106	39.29	1.56
3	*2402.00	111.10 PK			1.57 H	335	109.12	1.98
4	*2402.00	110.76 AV			1.57 H	335	108.78	1.98
5	4804.00	51.74 PK	74.00	-22.26	1.07 H	74	44.50	7.24
6	4804.00	38.52 AV	54.00	-15.48	1.07 H	74	31.28	7.24
7	#7206.00	54.10 PK	74.00	-19.90	1.00 H	52	42.65	11.45
8	#7206.00	42.36 AV	54.00	-11.64	1.00 H	52	30.91	11.45

ANTENNA POLARITY & TEST DISTANCE: VERTICAL AT 3 M								
NO.	FREQ. (MHz)	EMISSION LEVEL (dBuV/m)	LIMIT (dBuV/m)	MARGIN (dB)	ANTENNA HEIGHT (m)	TABLE ANGLE (Degree)	RAW VALUE (dBuV)	CORRECTION FACTOR (dB/m)
1	2390.00	49.37 PK	74.00	-24.63	1.05 V	20	47.81	1.56
2	2390.00	40.28 AV	54.00	-13.72	1.05 V	20	38.72	1.56
3	*2402.00	104.21 PK			1.64 V	289	102.23	1.98
4	*2402.00	103.23 AV			1.64 V	289	101.25	1.98
5	4804.00	50.41 PK	74.00	-23.59	1.00 V	54	43.17	7.24
6	4804.00	37.26 AV	54.00	-16.74	1.00 V	54	30.02	7.24
7	#7206.00	53.27 PK	74.00	-20.73	1.05 V	128	41.82	11.45
8	#7206.00	40.29 AV	54.00	-13.71	1.05 V	128	28.84	11.45

REMARKS:

1. Emission level (dBuV/m) = Raw Value (dBuV) + Correction Factor (dB/m).
2. Correction Factor (dB/m) = Antenna Factor (dB/m) + Cable Factor (dB).
3. The emission levels of other frequencies were greater than 20dB margin.
4. Margin value = Emission level – Limit value.
5. " \* ": Fundamental frequency.
6. " # ": The radiated frequency is out of the restricted band.



### 4.3 NUMBER OF HOPPING FREQUENCY USED

#### 4.3.1 LIMIT OF HOPPING FREQUENCY USED

At least 15 channels frequencies, and should be equally spaced.

#### 4.3.2 TEST SETUP

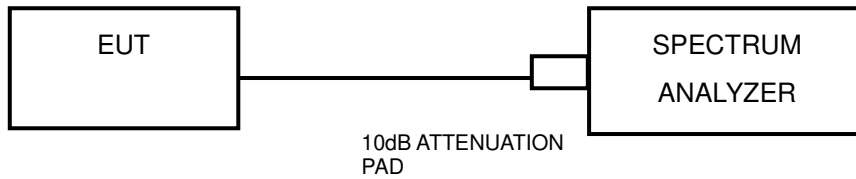

#### 4.3.3 TEST INSTRUMENTS

Equipment	Manufacturer	Model No.	Serial No.	Next Cal.
Power Sensor	Keysight	U2021XA	MY57320002	Feb. 23, 23
Power Sensor	Keysight	U2021XA	MY55060018	May 09, 23
Digital Multimeter	FLUKE	15B	A1220010DG	N/A
Humid & Temp Programmable Tester	Haida	HD-225T	110807201	Nov. 03, 23
Oscilloscope	Agilent	DSO9254A	MY51260160	Aug. 11, 23
Signal and Spectrum Analyzer	Rohde&Schwarz	FSV40	101094	Jan. 16, 24
Signal Generator	Agilent	N5183A	MY50140980	Sep. 18, 23
MXG-B RF Vector Signal Generator	Keysight	N5182B	MY56200288	Sep. 14, 23
BLUETOOTH TESTER	Rohde&Schwarz	CBT32	100811	N/A
Attenuator	MINI	BW-S10W2+	S130129FGE2	N/A
DC Source	Keysight	E3642A	MY56146098	N/A
Test software	ADT	ADT_RF Test Software V6.6.5.3	N/A	N/A

- NOTE:**
1. The test was performed in RF Test Shielded Room.
  2. The calibration interval of the above test instruments is 12 months and the calibrations are traceable to CEPREI/CHINA, GRGT/CHINA and NIM/CHINA.



#### 4.3.4 TEST PROCEDURES

- a. Check the calibration of the measuring instrument (SA) using either an internal calibrator or a known signal from an external generator.
- b. Turn on the EUT and connect its antenna terminal to measurement via a low loss cable. Then set it to any one measured frequency within its operating range and make sure the instrument is operated in its linear range.
- c. Set the SA on MaxHold Mode, and then keep the EUT in hopping mode. Record all the signals from each channel until each one has been recorded.
- d. Set the SA on View mode and then plot the result on SA screen.
- e. Repeat above procedures until all frequencies measured were completed.

#### 4.3.5 DEVIATION FROM TEST STANDARD

No deviation.

#### 4.3.6 TEST RESULTS

There are 79 hopping frequencies in the hopping mode. Please refer to next two pages for the test result. On the plots, it shows that the hopping frequencies are equally spaced.

GFSK

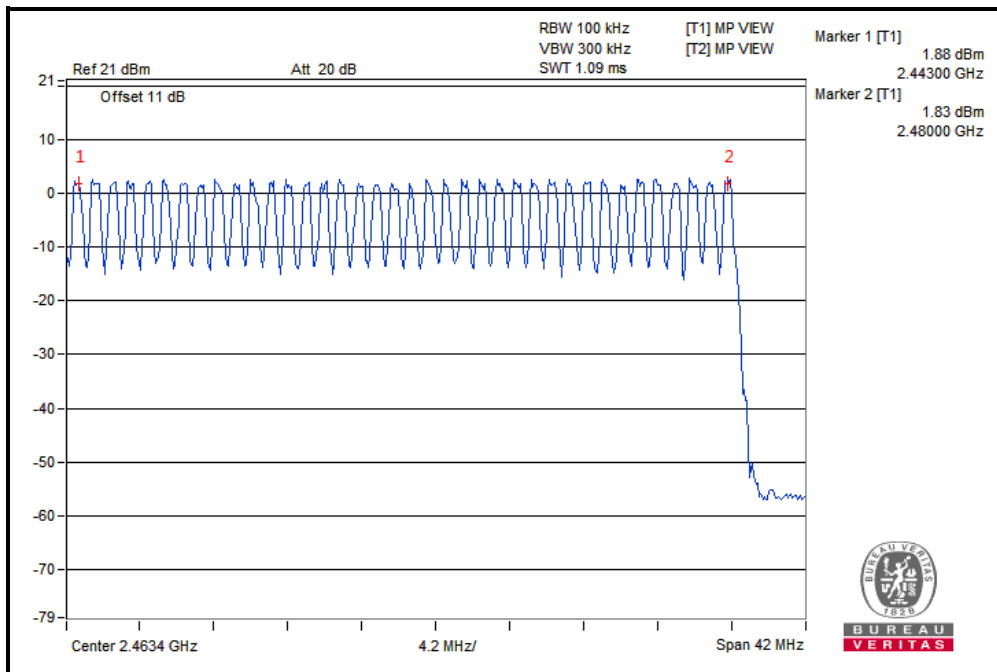
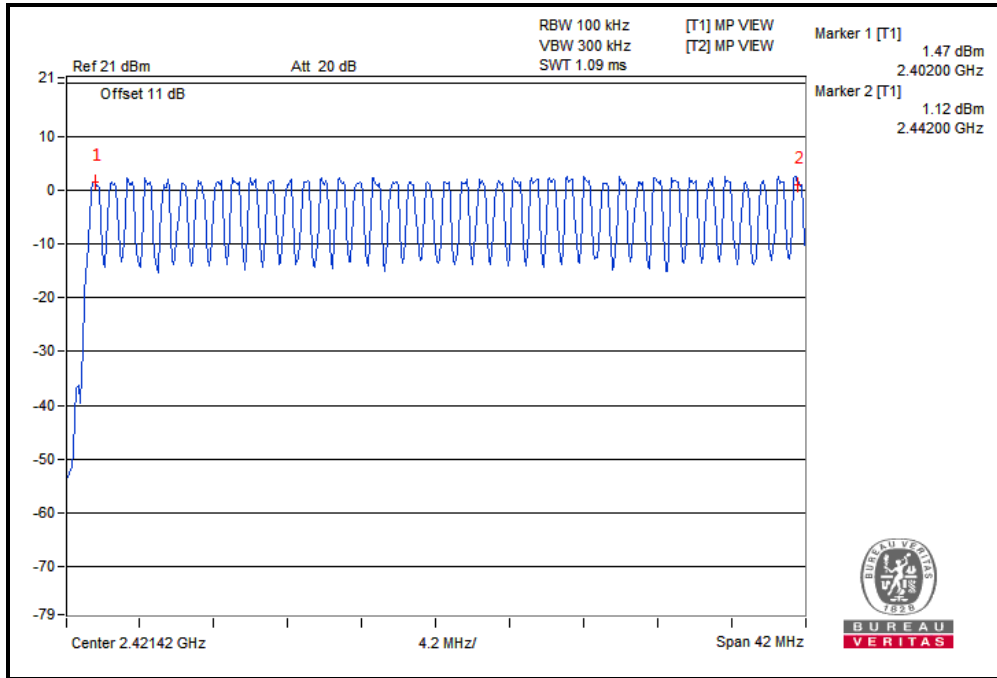

8DPSK

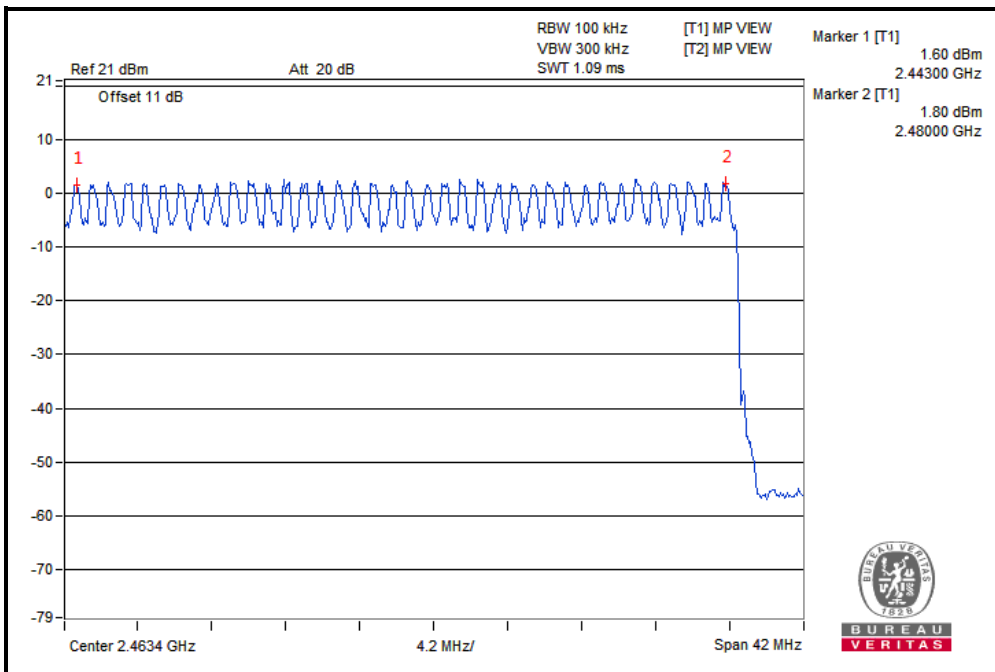
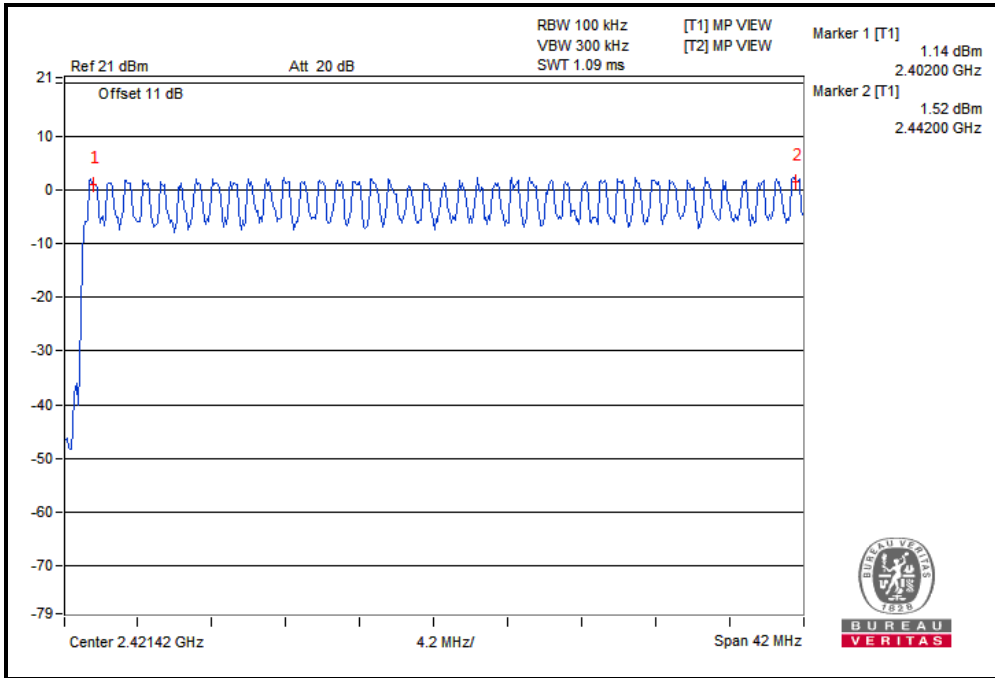

## 4.4 DWELL TIME ON EACH CHANNEL

### 4.4.1 LIMIT OF DWELL TIME USED

The average time of occupancy on any channel shall not be greater than 0.4 seconds within a period of 0.4 seconds multiplied by the number of hopping channels employed.

### 4.4.2 TEST SETUP

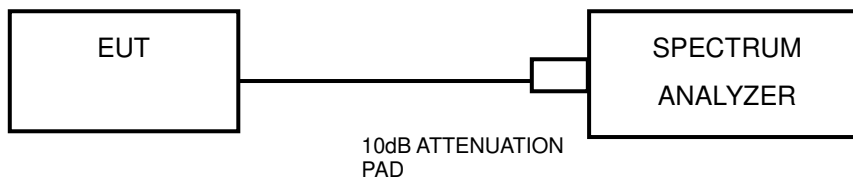

### 4.4.3 TEST INSTRUMENTS

Refer to section 4.3.3 to get information of above instrument.

### 4.4.4 TEST PROCEDURES

- a. Check the calibration of the measuring instrument (SA) using either an internal calibrator or a known signal from an external generator.
- b. Turn on the EUT and connect its antenna terminal to measurement via a low loss cable. Then set it to any one measured frequency within its operating range and make sure the instrument is operated in its linear range.
- c. Adjust the center frequency of SA on any frequency be measured and set SA to zero span mode. And then, set RBW and VBW of spectrum analyzer to proper value.
- d. Measure the time duration of one transmission on the measured frequency. And then plot the result with time difference of this time duration.
- e. Repeat above procedures until all different time-slot modes have been completed.



#### 4.4.5 DEVIATION FROM TEST STANDARD

No deviation.

#### 4.4.6 TEST RESULTS

##### GFSK

Mode	Number of Hopping Channel	Number of transmission in a period(channel number*0.4 sec)				Length of transmission time (msec)	Result (msec)	Limit (msec)	PASS / FAIL
		period (sec)	sweep time (sec)	times in a sweep	times in a period				
DH1	79	31.6	5	51	322.32	0.420	135.37	400	PASS
DH3	79	31.6	5	25	158.00	1.690	267.02	400	PASS
DH5	79	31.6	5	17	107.44	2.976	319.74	400	PASS

##### 8DPSK

Mode	Number of Hopping Channel	Number of transmission in a period(channel number*0.4 sec)				Length of transmission time (msec)	Result (msec)	Limit (msec)	PASS / FAIL
		period (sec)	sweep time (sec)	times in a sweep	times in a period				
3DH1	79	31.6	5	51	322.32	0.408	131.51	400	PASS
3DH3	79	31.6	5	25	158.00	1.720	271.76	400	PASS
3DH5	79	31.6	5	17	107.44	3.056	328.34	400	PASS

**NOTE:** Test plots of the transmitting time slot are shown on next page.



BUREAU VERITAS

Test Report No.: RF2212WDG0106-3

### GFSK



Bureau Veritas Shenzhen Co., Ltd.  
Dongguan Branch

No. 96, Guantai Road (Houjie Section), Houjie  
Town, Dongguan City, Guangdong Province.  
523942. People's Republic of China.

Tel: +86 769 8998 2098  
Fax: +86 769 8593 1080  
Email: [customerservice.dg@bureauveritas.com](mailto:customerservice.dg@bureauveritas.com)



BUREAU VERITAS

Test Report No.: RF2212WDG0106-3

### 8DPSK

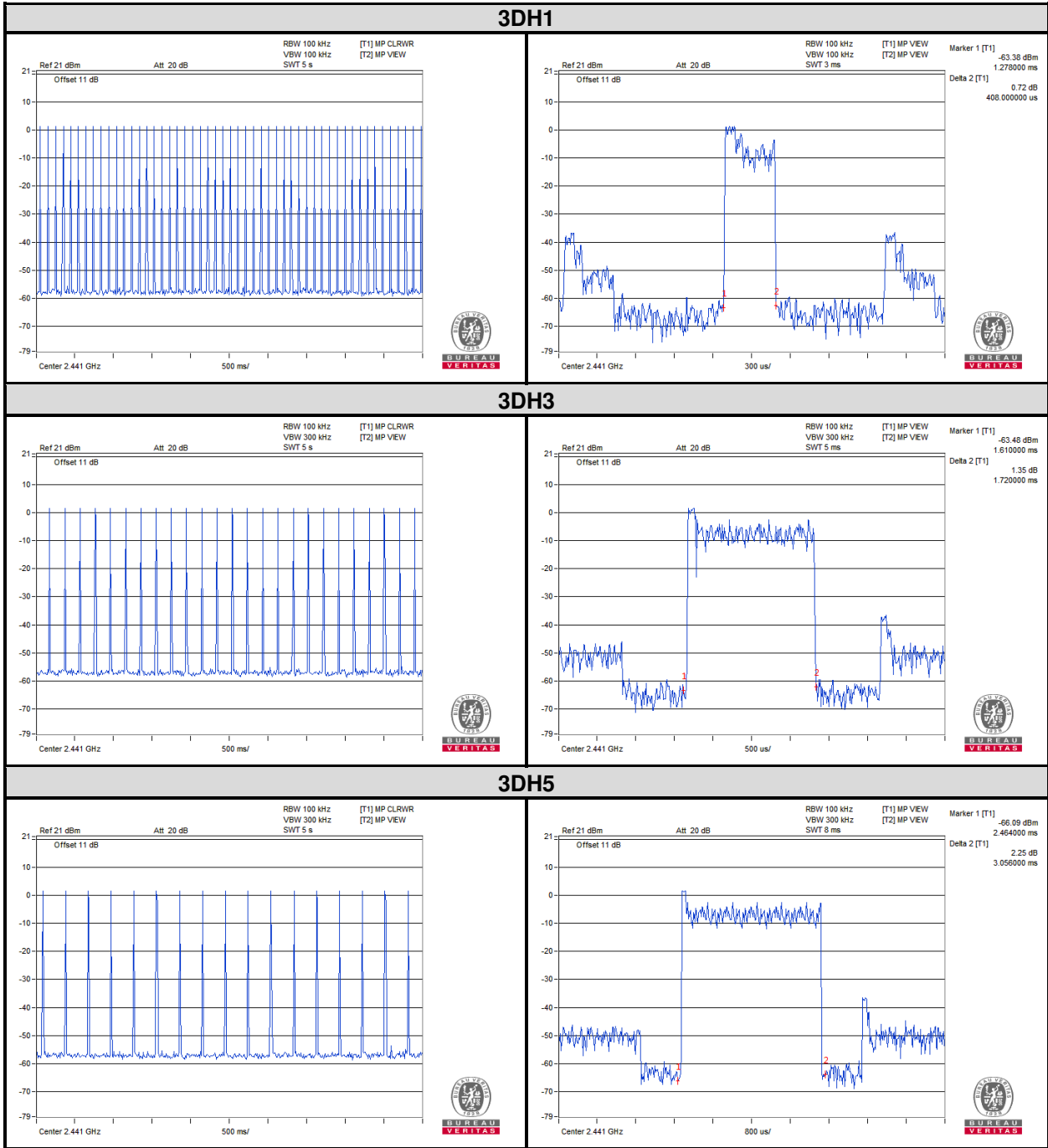

Bureau Veritas Shenzhen Co., Ltd.  
Dongguan Branch

No. 96, Guantai Road (Houjie Section), Houjie  
Town, Dongguan City, Guangdong Province.  
523942. People's Republic of China.

Tel: +86 769 8998 2098  
Fax: +86 769 8593 1080  
Email: [customerservice\\_dg@bureauveritas.com](mailto:customerservice_dg@bureauveritas.com)



## 4.5 CHANNEL BANDWIDTH

### 4.5.1 LIMITS OF CHANNEL BANDWIDTH

For frequency hopping system operating in the 2400-2483.5MHz, If the 20dB bandwidth of hopping channel is greater than 25kHz, two-thirds 20dB bandwidth of hopping channel shall be a minimum limit for the hopping channel separation.

### 4.5.2 TEST SETUP

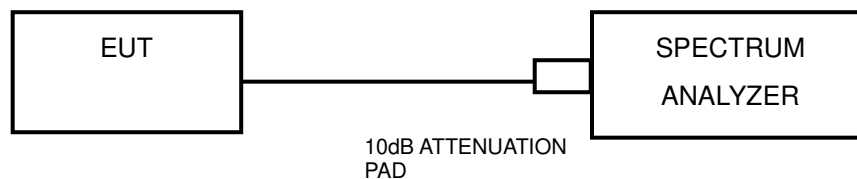

### 4.5.3 TEST INSTRUMENTS

Refer to section 4.3.3 to get information of above instrument.

### 4.5.4 TEST PROCEDURE

- a. Check the calibration of the measuring instrument using either an internal calibrator or a known signal from an external generator.
- b. Turn on the EUT and connect it to measurement instrument. Then set it to any one convenient frequency within its operating range. Set a reference level on the measuring instrument equal to the highest peak value.
- c. Measure the frequency difference of two frequencies that were attenuated 20dB from the reference level. Record the frequency difference as the emission bandwidth.
- d. Repeat above procedures until all frequencies measured were complete.

### 4.5.5 DEVIATION FROM TEST STANDARD

No deviation.

### 4.5.6 EUT OPERATING CONDITION

The software provided by client to enable the EUT under transmission condition continuously at lowest, middle and highest channel frequencies individually.





BUREAU VERITAS

Test Report No.: RF2212WDG0106-3

### 4.5.7 TEST RESULTS

#### GFSK

CHANNEL	CHANNEL FREQUENCY (MHz)	20dB BANDWIDTH (MHz)
0	2402	0.96
39	2441	0.97
78	2480	0.97

#### CH 0

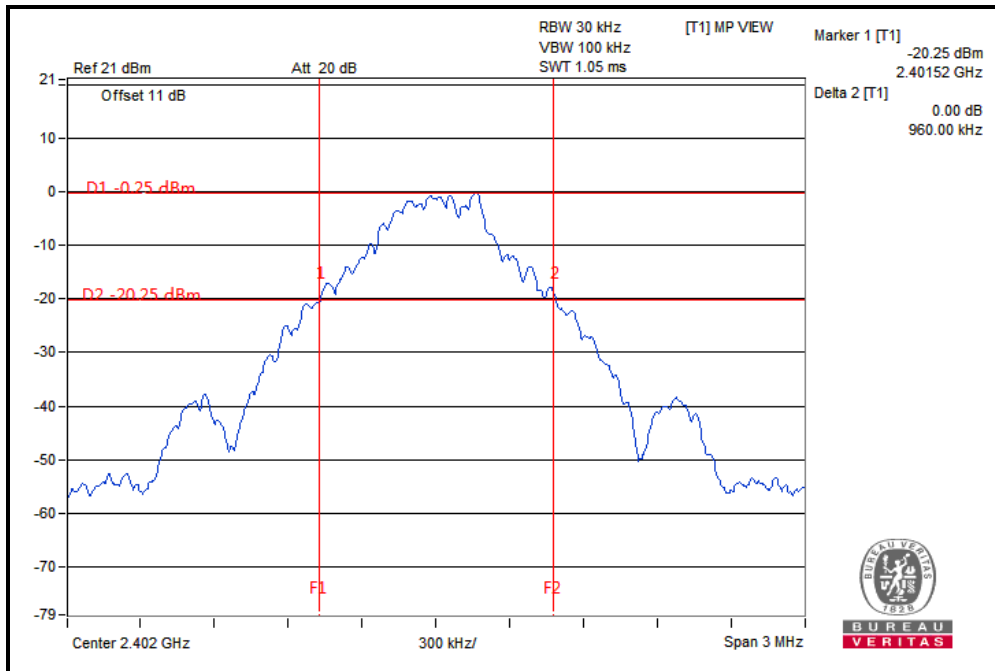

CH 39

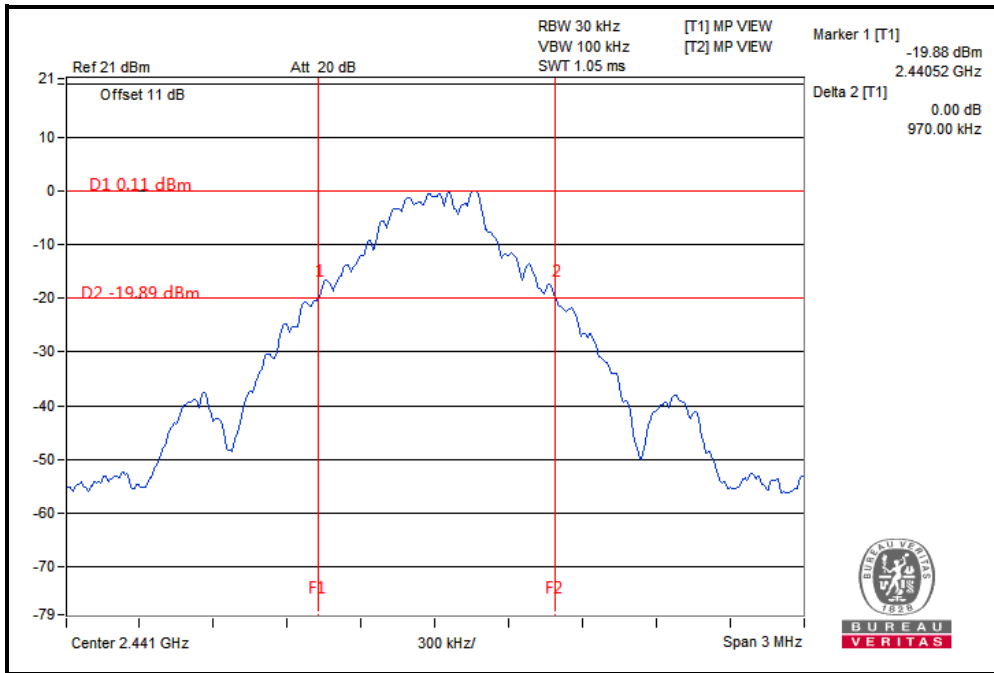

CH 78

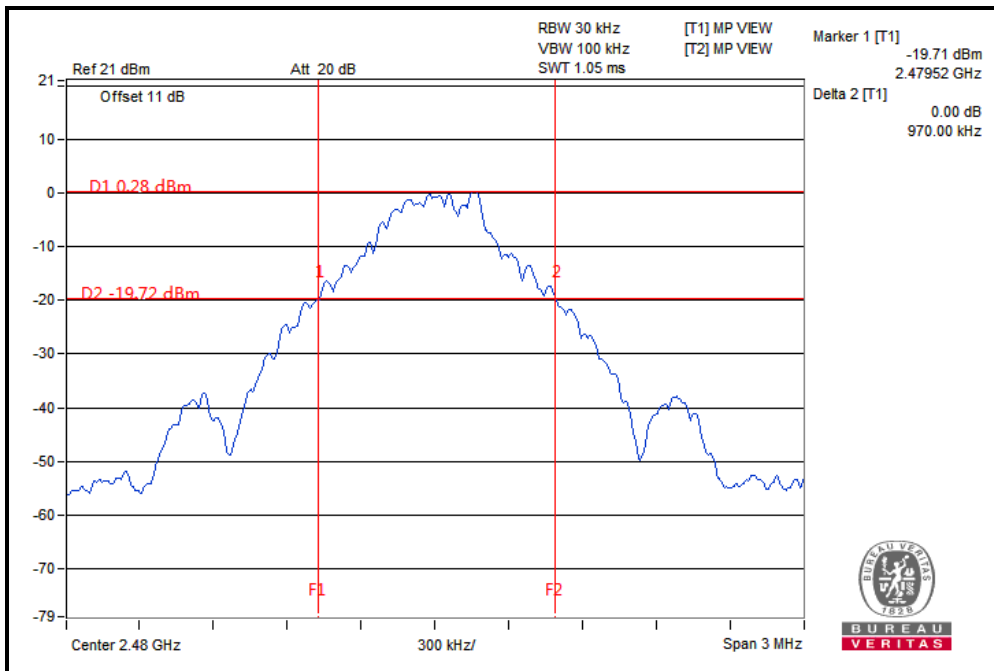

**8DPSK**

CHANNEL	CHANNEL FREQUENCY (MHz)	20dB BANDWIDTH (MHz)
0	2402	1.27
39	2441	1.28
78	2480	1.28

**CH 0**

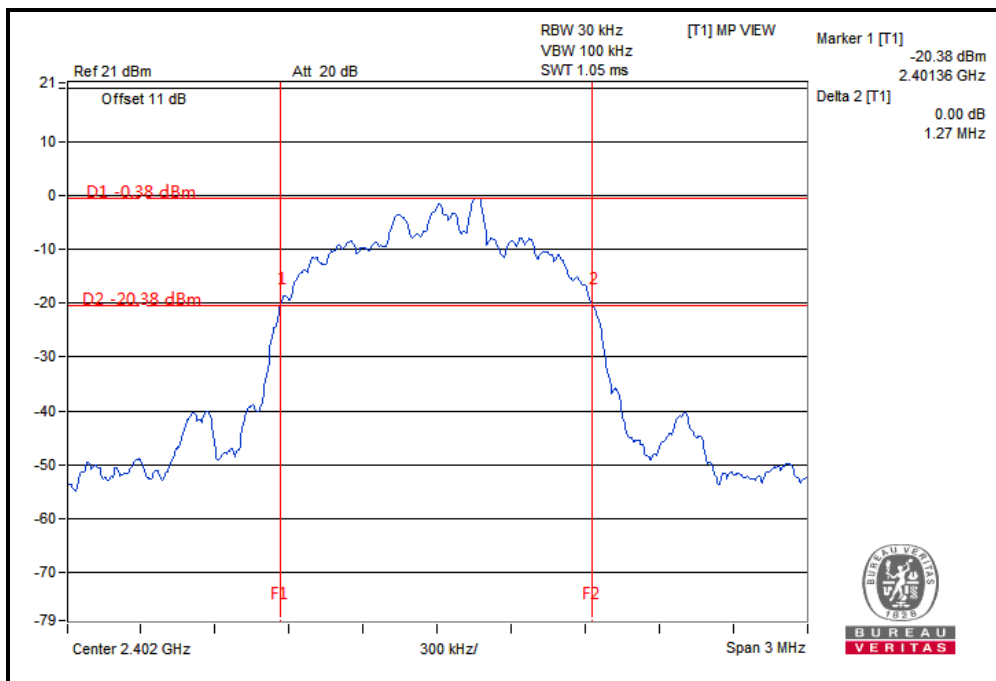



Test Report No.: RF2212WDG0106-3

CH 39

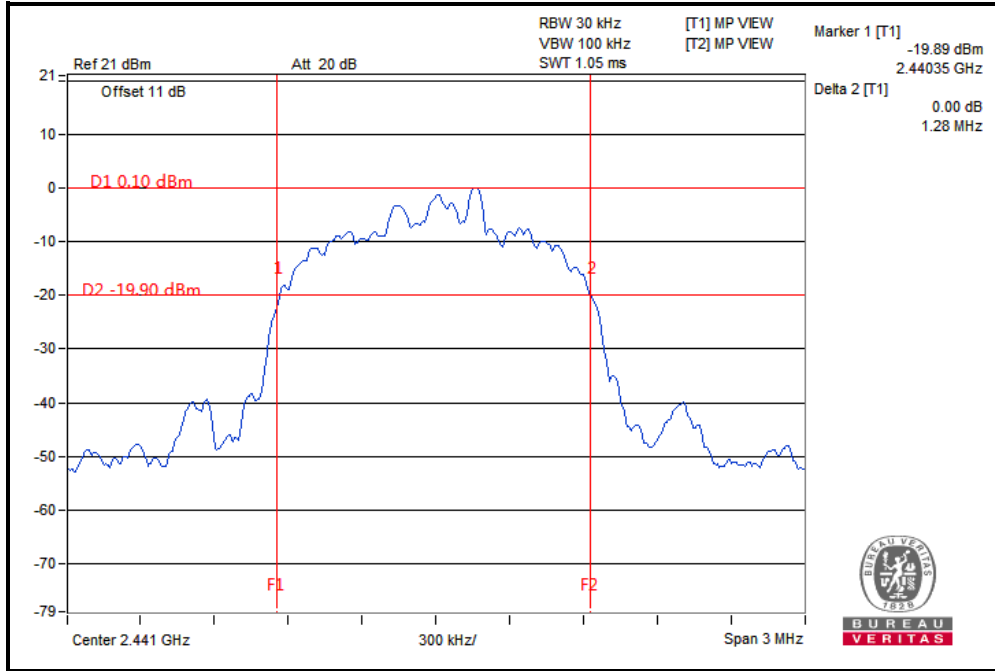

CH 78

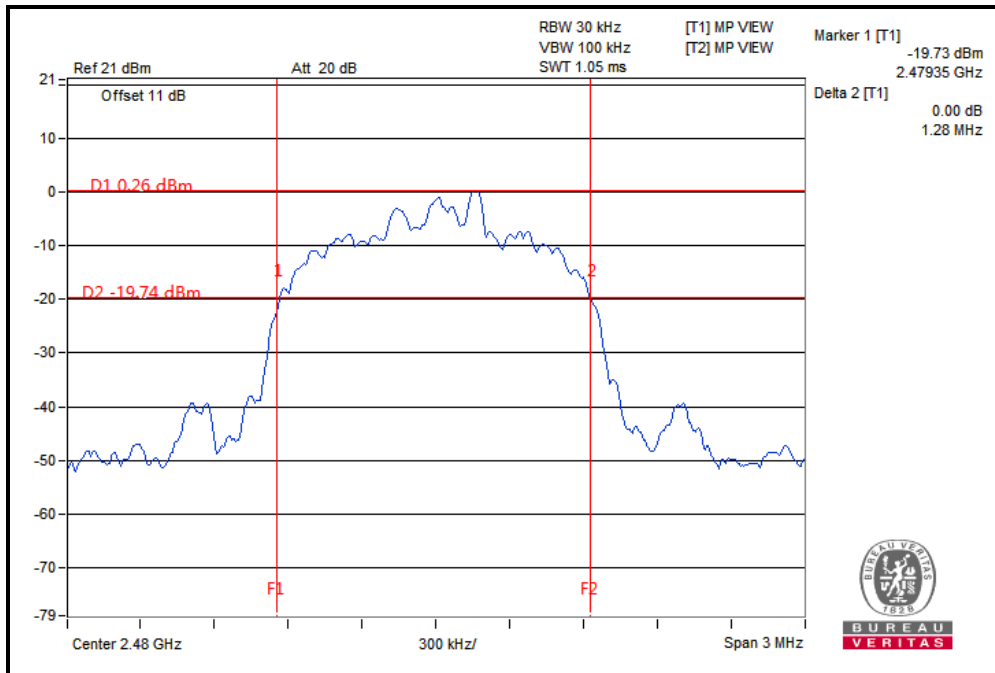

Bureau Veritas Shenzhen Co., Ltd.  
Dongguan Branch

No. 96, Guantai Road (Houjie Section), Houjie  
Town, Dongguan City, Guangdong Province.  
523942. People's Republic of China.

Tel: +86 769 8998 2098  
Fax: +86 769 8593 1080  
Email: [customerservice.dg@bureauveritas.com](mailto:customerservice.dg@bureauveritas.com)

## 4.6 HOPPING CHANNEL SEPARATION

### 4.6.1 LIMIT OF HOPPING CHANNEL SEPARATION

At least 25kHz or two-third of 20dB hopping channel bandwidth (whichever is greater).

### 4.6.2 TEST SETUP

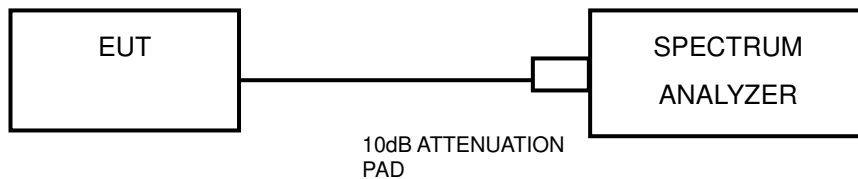

### 4.6.3 TEST INSTRUMENTS

Refer to section 4.3.3 to get information of above instrument.

### 4.6.4 TEST PROCEDURES

1. Check the calibration of the measuring instrument using either an internal calibrator or a known signal from an external generator.
2. Turn on the EUT and connect it to measurement instrument. Then set it to any one convenient frequency within its operating range.
3. By using the MaxHold function record the separation of two adjacent channels.
4. Measure the frequency difference of these two adjacent channels by SA MARK function. And then plot the result on SA screen.
5. Repeat above procedures until all frequencies measured were complete.

### 4.6.5 DEVIATION FROM TEST STANDARD

No deviation.

#### 4.6.6 TEST RESULTS

##### GFSK

CHANNEL	FREQUENCY (MHz)	ADJACENT CHANNEL SEPARATION (MHz)	20dB BANDWIDTH (MHz)	MINIMUM LIMIT (MHz)	PASS / FAIL
0	2402	1.00	0.96	0.64	PASS
39	2441	1.00	0.97	0.65	PASS
78	2480	1.00	0.97	0.65	PASS

**NOTE:** The minimum limit is two-third 20dB bandwidth.

##### CH 0

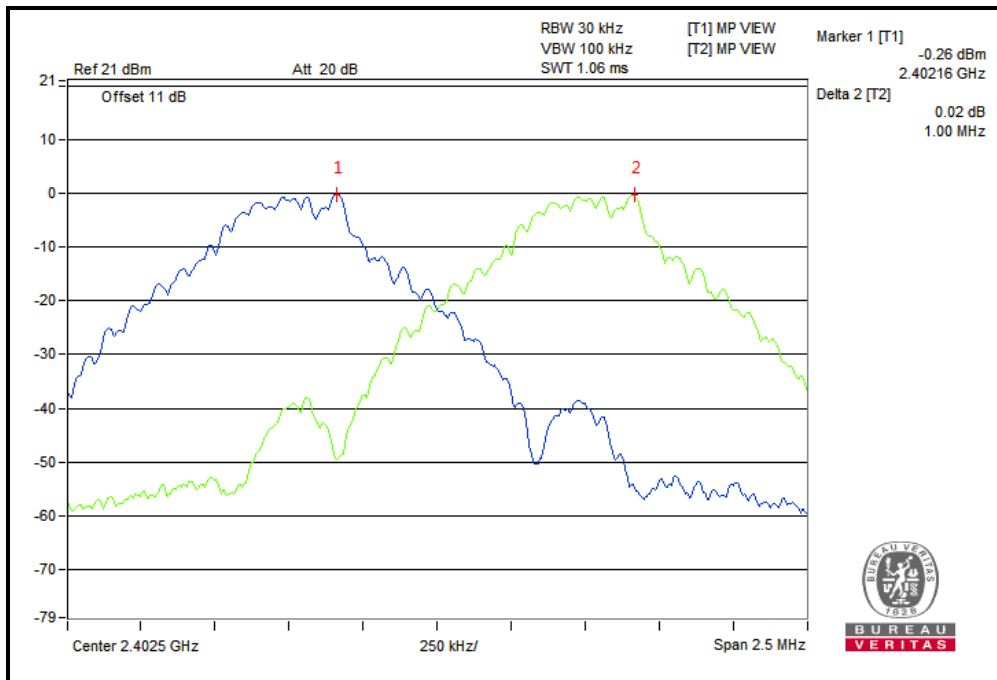

CH 39

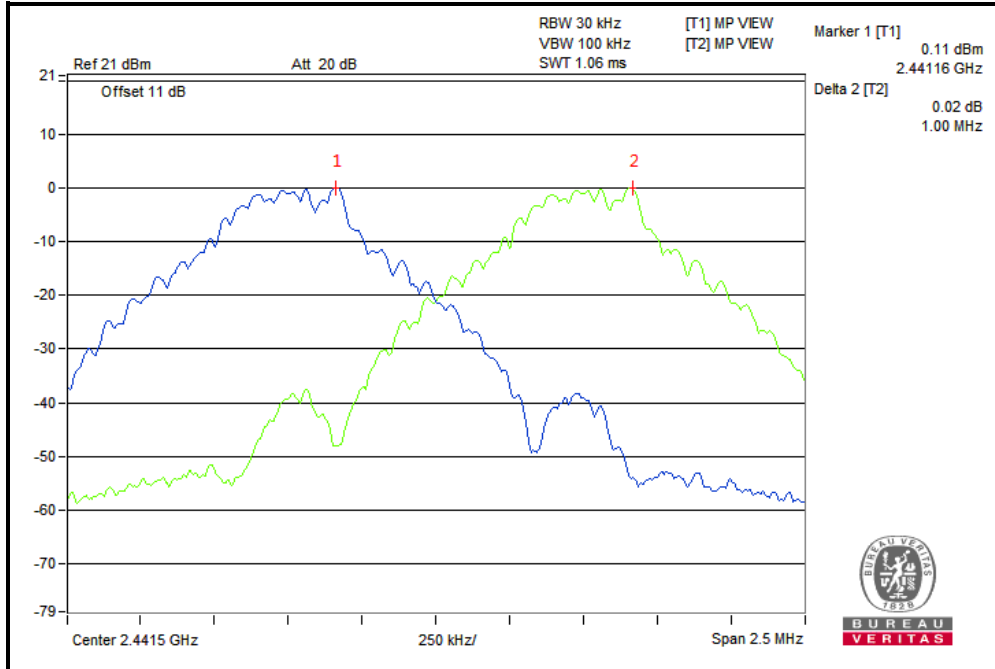

CH 78

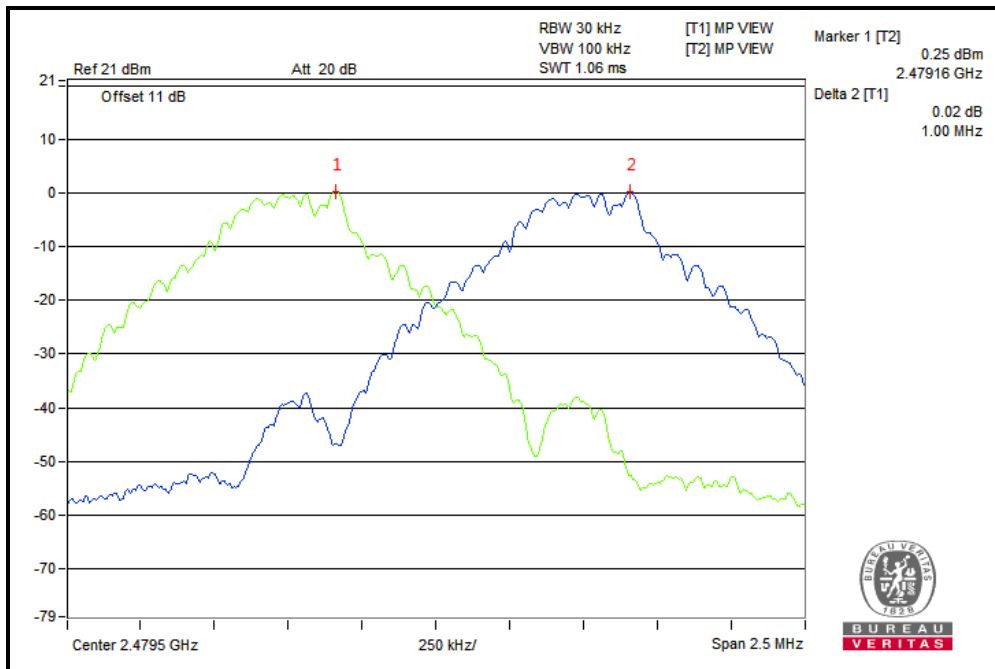



BUREAU VERITAS

Test Report No.: RF2212WDG0106-3

8DPSK

CHANNEL	FREQUENCY (MHz)	ADJACENT CHANNEL SEPARATION (MHz)	20dB BANDWIDTH (MHz)	MINIMUM LIMIT (MHz)	PASS / FAIL
0	2402	1.00	1.27	0.85	PASS
39	2441	1.00	1.28	0.85	PASS
78	2480	1.00	1.28	0.85	PASS

NOTE: The minimum limit is two-third 20dB bandwidth.

CH 0

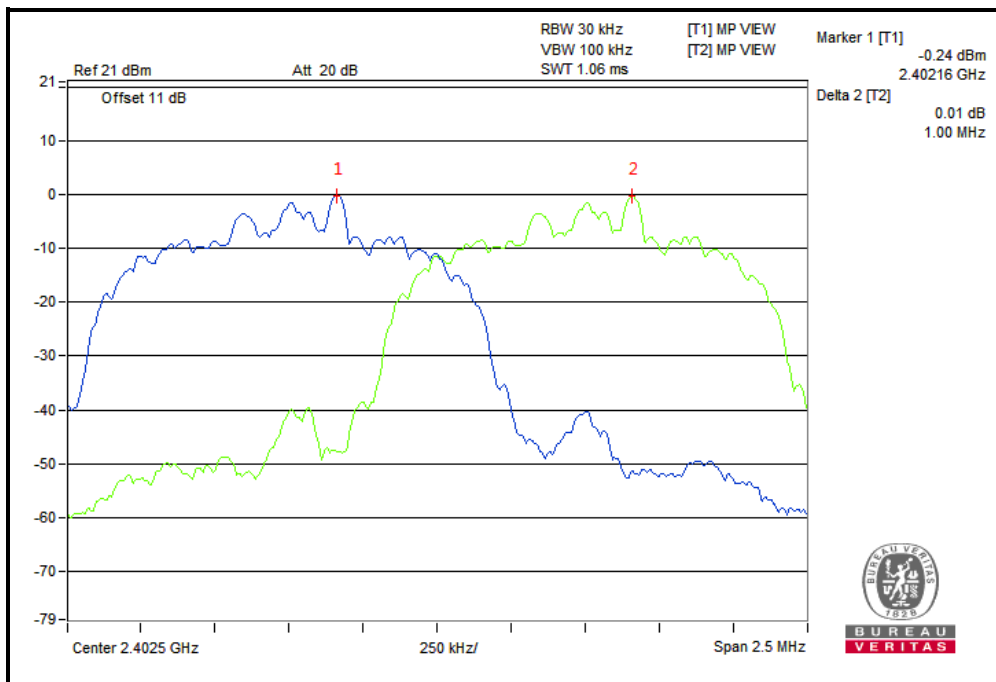



CH 39

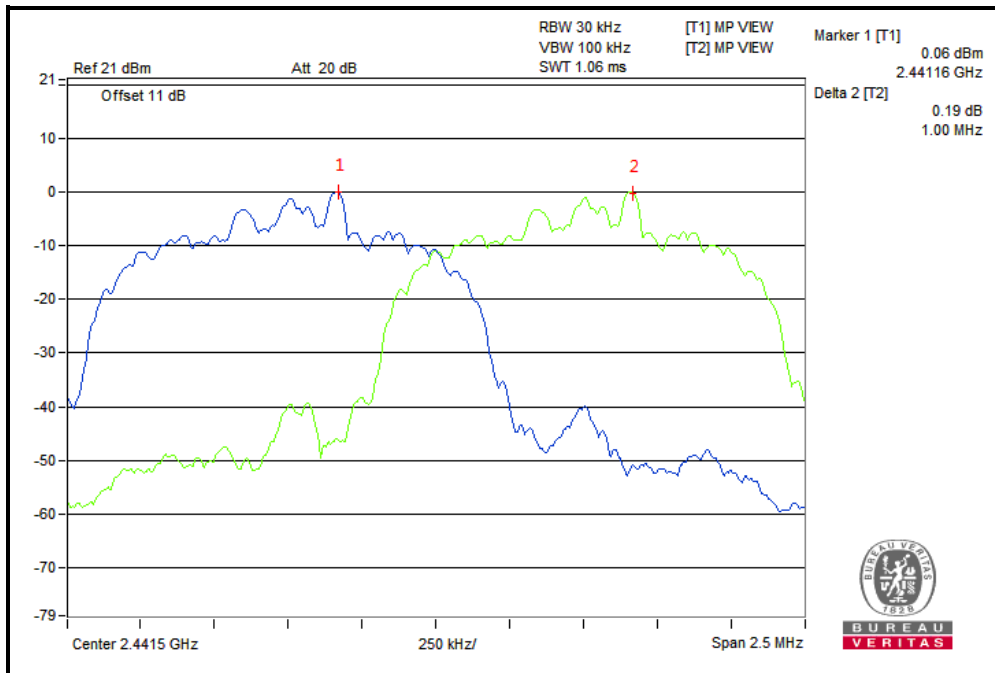

CH 78

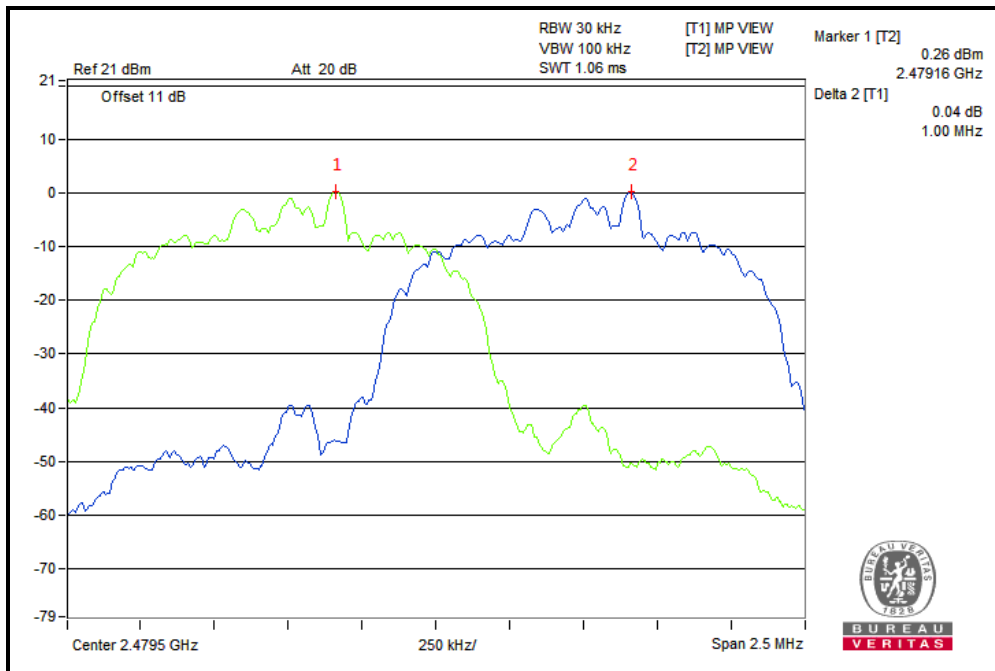



## 4.7 CONDUCTED OUTPUT POWER

### 4.7.1 LIMITS OF CONDUCTED OUTPUT POWER MEASUREMENT

The Maximum Output Power Measurement is 125mW.

### 4.7.2 TEST SETUP

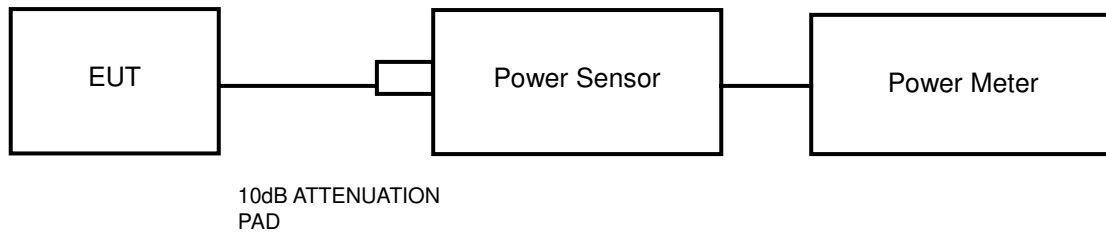

### 4.7.3 TEST INSTRUMENTS

Refer to section 4.3.3 to get information of above instrument.

### 4.7.4 TEST PROCEDURES

A peak power sensor was used on the output port of the EUT. A power meter was used to read the response of the peak power sensor and set the detector to PEAK. Record the power level.

An average power sensor was used on the output port of the EUT. A power meter was used to read the response of the average power sensor and set the detector to AVERAGE. Record the power level.

### 4.7.5 DEVIATION FROM TEST STANDARD

No deviation.

#### 4.7.6 EUT OPERATING CONDITION

The software provided by client to enable the EUT under transmission condition continuously at lowest, middle and highest channel frequencies individually.

#### 4.7.7 TEST RESULTS

##### MAXIMUM PEAK OUTPUT POWER

###### GFSK

CHANNEL	CHANNEL FREQUENCY (MHz)	PEAK POWER (dBm)	PEAK POWER (mW)	PEAK POWER LIMIT (mW)	PASS/FAIL
0	2402	3.64	2.312	125	PASS
39	2441	4.05	2.541	125	PASS
78	2480	4.14	2.594	125	PASS

###### 8DPSK

CHANNEL	CHANNEL FREQUENCY (MHz)	PEAK POWER (dBm)	PEAK POWER (mW)	PEAK POWER LIMIT (mW)	PASS/FAIL
0	2402	3.79	2.393	125	PASS
39	2441	4.20	2.63	125	PASS
78	2480	<b>4.30</b>	<b>2.692</b>	125	PASS



### AVERAGE OUTPUT POWER(FOR REFERENCE)

#### GFSK

CHANNEL	CHANNEL FREQUENCY (MHz)	AVERAGE POWER (dBm)	AVERAGE POWER (mW)
0	2402	2.60	1.820
39	2441	3.01	2.00
78	2480	3.09	2.037

#### 8DPSK

CHANNEL	CHANNEL FREQUENCY (MHz)	AVERAGE POWER (dBm)	AVERAGE POWER (mW)
0	2402	1.91	1.552
39	2441	2.37	1.726
78	2480	2.43	1.750

## 4.8 OUT OF BAND EMISSION MEASUREMENT

### 4.8.1 LIMITS OF OUT OF BAND EMISSION MEASUREMENT

Below  $-20\text{dB}$  of the highest emission level of operating band (in 100KHz RBW).

### 4.8.2 TEST INSTRUMENTS

Refer to section 4.3.3 to get information of above instrument.

### 4.8.3 TEST PROCEDURE

The transmitter output was connected to the spectrum analyzer via a low loss cable. of Spectrum Analyzer was set RBW to 100 kHz and VBW to 300 kHz with suitable frequency span including 100 MHz bandwidth from band edge. Detector = PEAK and Trace mode = Max Hold. The band edges was measured and recorded.

### 4.8.4 DEVIATION FROM TEST STANDARD

No deviation.

### 4.8.5 EUT OPERATING CONDITION

The software provided by client to enable the EUT under transmission condition continuously at lowest, middle and highest channel frequencies individually.

### 4.8.6 TEST RESULTS

The spectrum plots are attached on the following images. D1 line indicates the highest level. D2 line indicates the 20dB offset below D1. It shows compliance to the requirement.



BUREAU VERITAS

Test Report No.: RF2212WDG0106-3

GFSK

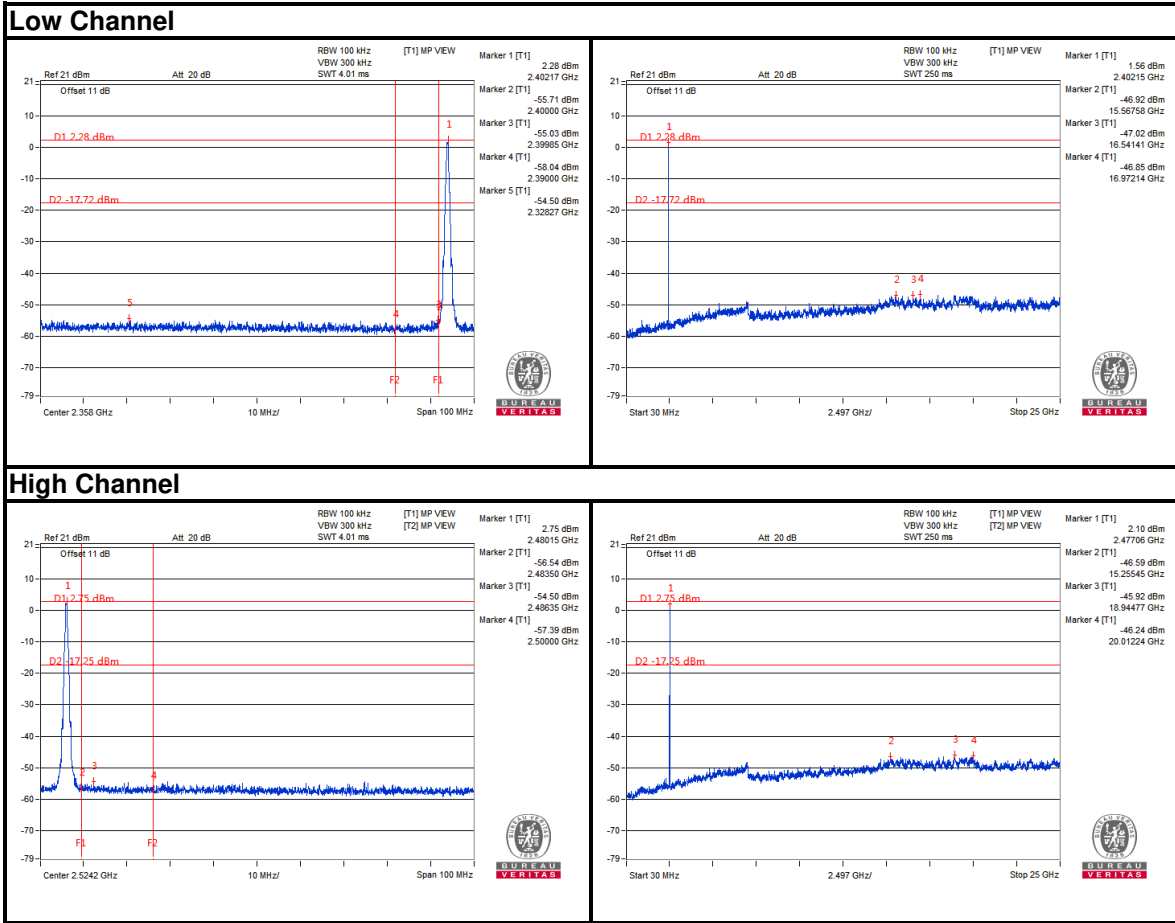

Bureau Veritas Shenzhen Co., Ltd.  
Dongguan Branch

No. 96, Guantai Road (Houjie Section), Houjie Town, Dongguan City, Guangdong Province. 523942. People's Republic of China.

Tel: +86 769 8998 2098  
Fax: +86 769 8593 1080  
Email: [customerservice\\_dg@bureauveritas.com](mailto:customerservice_dg@bureauveritas.com)



BUREAU VERITAS

Test Report No.: RF2212WDG0106-3

8DPSK

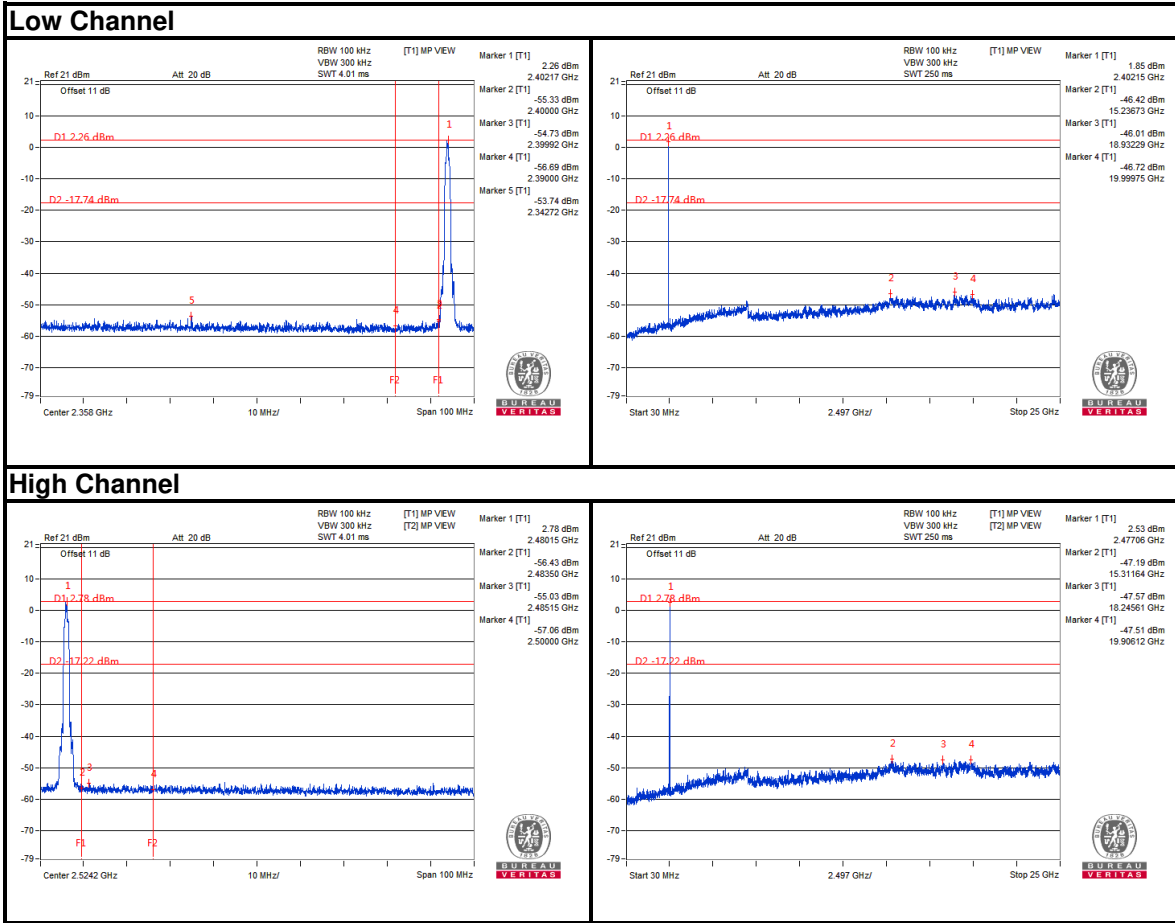

Bureau Veritas Shenzhen Co., Ltd.  
Dongguan Branch

No. 96, Guantai Road (Houjie Section), Houjie  
Town, Dongguan City, Guangdong Province.  
523942. People's Republic of China.

Tel: +86 769 8998 2098  
Fax: +86 769 8593 1080  
Email: [customerservice\\_dg@bureauveritas.com](mailto:customerservice_dg@bureauveritas.com)

GFSK

Hopping on Low Channel

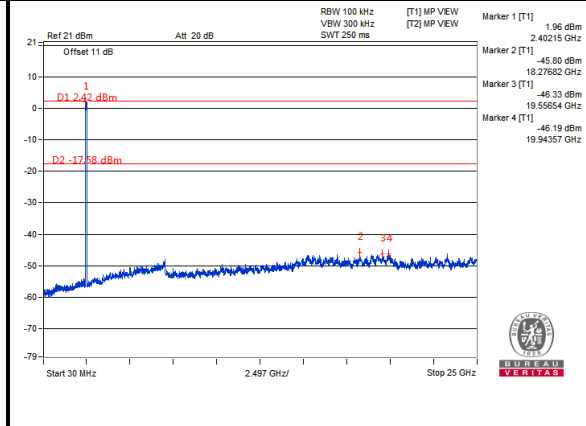
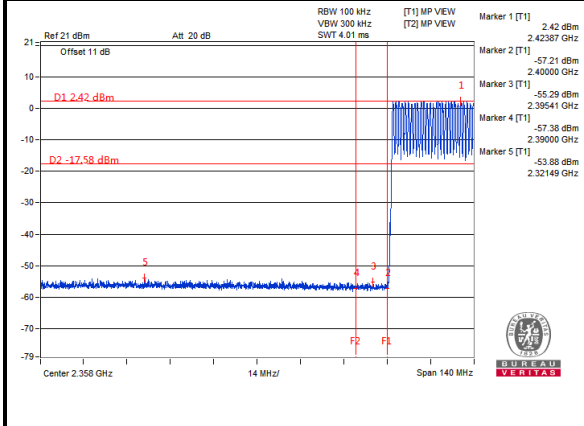

Hopping on High Channel

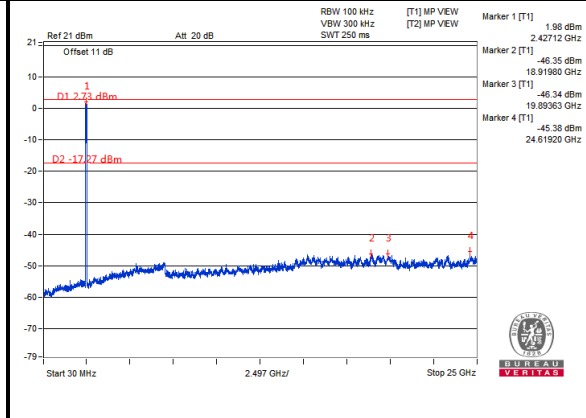
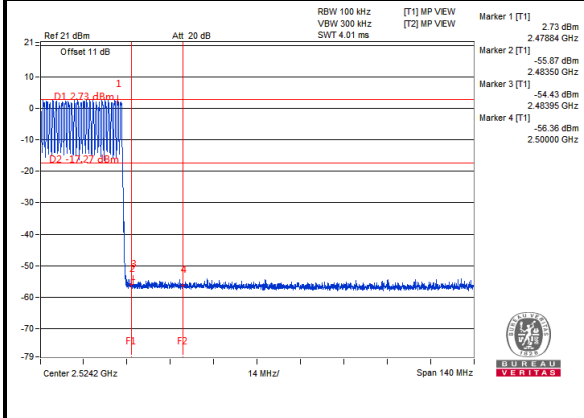





BUREAU VERITAS

Test Report No.: RF2212WDG0106-3

### 8DPSK

#### Hopping on Low Channel

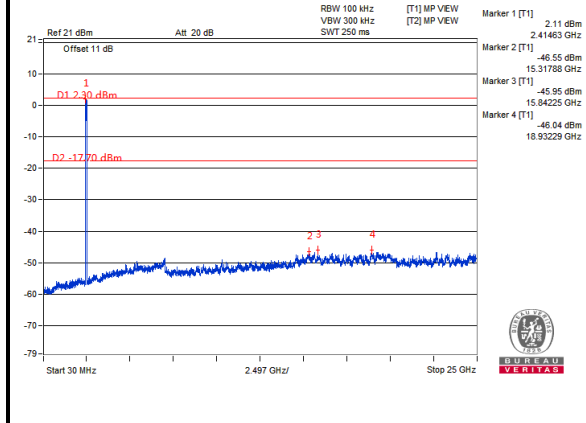
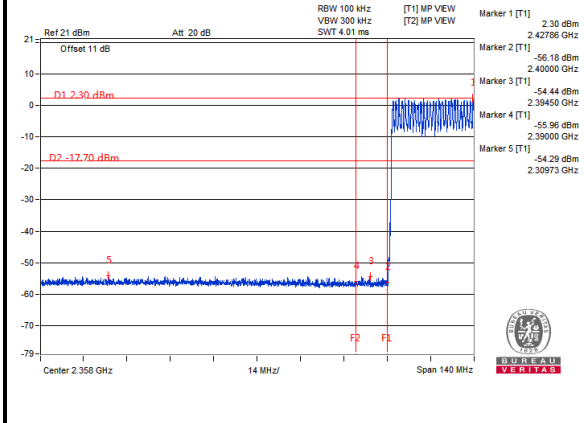

#### Hopping on High Channel

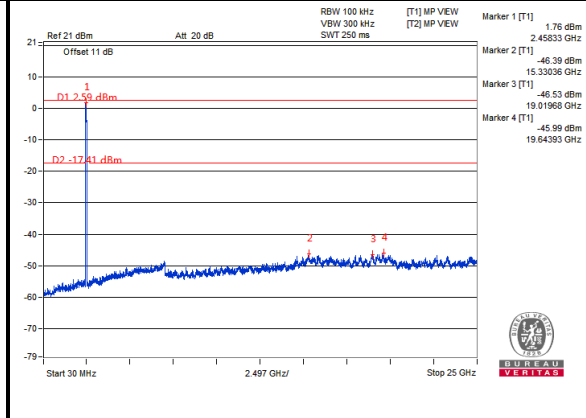
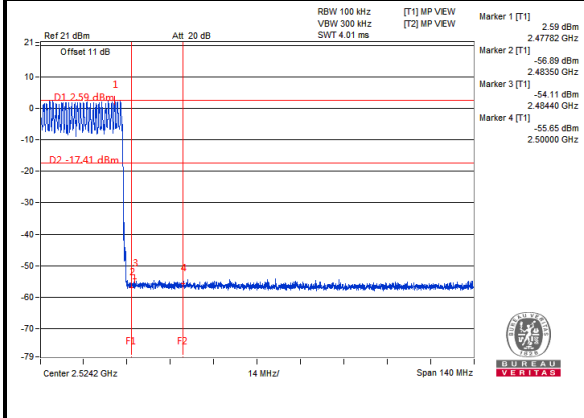

Bureau Veritas Shenzhen Co., Ltd.  
Dongguan Branch

No. 96, Guantai Road (Houjie Section), Houjie  
Town, Dongguan City, Guangdong Province.  
523942. People's Republic of China.

Tel: +86 769 8998 2098  
Fax: +86 769 8593 1080  
Email: [customerservice\\_dg@bureauveritas.com](mailto:customerservice_dg@bureauveritas.com)



**BUREAU  
VERITAS**

**Test Report No.: RF2212WDG0106-3**

## **5 PHOTOGRAPHS OF THE TEST CONFIGURATION**

Please refer to the attached file (Test Setup Photo).



**BUREAU  
VERITAS**

Test Report No.: RF2212WDG0106-3

## **6 APPENDIX A - MODIFICATIONS RECORDERS FOR ENGINEERING CHANGES TO THE EUT BY THE LAB**

No any modifications are made to the EUT by the lab during the test.

**---END---**